



**User Manual**

## **AIMB-203**

**Intel® Core™ i7/i5/i3/Pentium/  
Celeron LGA1150 Mini-ITX with  
CRT/LVDS/DP++/DVI-D, 9 COM,  
8 USB, Dual LAN, PCIe x16**

**ADVANTECH**

*Enabling an Intelligent Planet*

---

## Copyright

The documentation and the software included with this product are copyrighted 2016 by Advantech Co., Ltd. All rights are reserved. Advantech Co., Ltd. reserves the right to make improvements in the products described in this manual at any time without notice.

No part of this manual may be reproduced, copied, translated or transmitted in any form or by any means without the prior written permission of Advantech Co., Ltd. Information provided in this manual is intended to be accurate and reliable. However, Advantech Co., Ltd. assumes no responsibility for its use, nor for any infringements of the rights of third parties, which may result from its use.

## Acknowledgements

AMI is a trademark of Phoenix Technologies Ltd.

IBM and PC are trademarks of International Business Machines Corporation.

Intel® Core™ i7/i5/i3, Pentium, Celeron® is trademark of Intel Corporation

All other product names or trademarks are properties of their respective owners.

# A Message to the Customer

## Advantech Customer Services

Each and every Advantech product is built to the most exacting specifications to ensure reliable performance in the harsh and demanding conditions typical of industrial environments. Whether your new Advantech equipment is destined for the laboratory or the factory floor, you can be assured that your product will provide the reliability and ease of operation for which the name Advantech has come to be known.

Your satisfaction is our primary concern. Here is a guide to Advantech's customer services. To ensure you get the full benefit of our services, please follow the instructions below carefully.

## Technical Support

We want you to get the maximum performance from your products. So if you run into technical difficulties, we are here to help. For the most frequently asked questions, you can easily find answers in your product documentation. These answers are normally a lot more detailed than the ones we can give over the phone.

So please consult this manual first. If you still cannot find the answer, gather all the information or questions that apply to your problem, and with the product close at hand, call your dealer. Our dealers are well trained and ready to give you the support you need to get the most from your Advantech products. In fact, most problems reported are minor and are able to be easily solved over the phone.

In addition, free technical support is available from Advantech engineers every business day. We are always ready to give advice on application requirements or specific information on the installation and operation of any of our products.

# Declaration of Conformity

## FCC Class B

This device complies with the requirements in part 15 of the FCC rules:

Operation is subject to the following two conditions:

- This device may not cause harmful interference
- This device must accept any interference received, including interference that may cause undesired operation.

This equipment has been tested and found to comply with the limits for a Class B digital device, pursuant to Part 15 of the FCC Rules. These limits are designed to provide reasonable protection against harmful interference when the equipment is operated in a commercial environment. This equipment generates, uses, and can radiate radio frequency energy and, if not installed and used in accordance with the instruction manual, may cause harmful interference to radio communications. Operation of this device in a residential area is likely to cause harmful interference in which case the user will be required to correct the interference at his/her own expense. The user is advised that any equipment changes or modifications not expressly approved by the party responsible for compliance would void the compliance to FCC regulations and therefore, the user's authority to operate the equipment.

**Caution!** *There is a danger of a new battery exploding if it is incorrectly installed. Do not attempt to recharge, force open, or heat the battery. Replace the battery only with the same or equivalent type recommended by the manufacturer. Discard used batteries according to the manufacturer's instructions.*



## CPU Compatibility

CPU Family	Speed	TDP	L3 cache
Intel® Haswell I7-4770 3.4GHz		84W	8MB
Intel® Haswell I7-4770K 3.5GHz		84W	8MB
Intel® Haswell I7-4770S 3.1GHz		65W	8MB
Intel® Haswell I5-4670K 3.4GHz		84W	6MB
Intel® Haswell I5-4570 3.2GHz		84W	6MB
Intel® Haswell I5-4570S 2.9GHz		65W	6MB
Intel® Haswell I5-4570TE 2.7GHz		35W	4MB
Intel® Haswell I3-4330 3.5GHz		65W	4MB
Intel® Haswell Pentium G3420 3.2GHz		54W	3MB
Intel® Xeon® Processor E3-1268L(V3) 2.3GHz		45W	8MB
Intel® Haswell Celeron G1820 2.7GHz		53W	2MB
Intel® Haswell Celeron G1820TE 2.2GHz		35W	2MB

## Memory Compatibility

Brand	Size	Speed	Type	ECC	Vendor PN	Memory	Result
Transcend	1GB	DDR3 1066	SODIMM DDR3	N	TS128MSK64 V1U	SEC K4B1G0846G- BCH9	PASS
Transcend	2GB	DDR3 1066	SODIMM DDR3	N	TS128MSK64 V1U	SEC HCH9 K4B1G0846D (128x8)	PASS
Transcend	4GB	DDR3 1066	SODIMM DDR3	N	TS7KSN28420 -1Y	HYNIX H5TQ2G83BF R (256x8)	PASS
Apacer	4GB	DDR3 1066	SODIMM DDR3	N	78.B2GC8.AF1	HYNIX H5TQ2G83BF R (256x8)	PASS
Transcend	1GB	DDR3 1333	SODIMM DDR3	N	TS128MSK64 V3U	ELPIDA J1108BFBG- DJ-F	PASS
Transcend	2GB	DDR3 1333	SODIMM DDR3	N	TS256MSK64 V3N	HYNIX H5TQ2G83CF R	PASS
Transcend	2GB	DDR3 1333	SODIMM DDR3	N	TS256MSK64 W3N	SEC 234 HYK0 K4B2G0846D	PASS
Transcend	4GB	DDR3 1333	SODIMM DDR3	N	TS512MSK64 V3N	HYNIX H5TQ2G83BF R (256x8)	PASS
Transcend	4GB	DDR3 1333	SODIMM DDR3	N	TS512MSK64 V3N	HYNIX H5TQ2G83CF R H9C 144AK 256x8	PASS
Transcend	8GB	DDR3 1333	SODIMM DDR3	N	TS1GSK64V3 H	MICRON IZD27 D9PBC 79T5 512x8	PASS
Apacer	1GB	DDR3 1333	SODIMM DDR3	N	78.02GC6.AF0	HYNIX H5TQ1G83DF R-H9C	PASS
	1GB	DDR3 1333	SODIMM DDR3	N		HYNIX H5TQ1G83TF R-H9C	PASS
Apacer	2GB	DDR3 1333	SODIMM DDR3	N	78.A2GC9.420 0C	ELPIDA J2108BCSE- DJ-F	PASS
Apacer	4GB	DDR3 1333	SODIMM DDR3	N	78.B2GC9.AF1	HYNIX H5TQ2G83BF R (256x8)	PASS
Apacer	4GB	DDR3 1333	SODIMM DDR3	N	78.B2GC9.421 0C	ELPIDA J2108BCSE- DJ-F	PASS
Apacer	4GB	DDR3 1333	SODIMM DDR3	N	78.B2GC9.421 0C	ELPIDA J2108ECSE- DJ-F 256x8	PASS
Apacer	8GB	DDR3 1333	SODIMM DDR3	N	78.C2GCM.42 30C	ELPIDA J4208BASE- DJ-F 512x8	PASS

DSL	4GB	DDR3 1333	SODIMM DDR3	N	D3SH56082XH 15AA	HYNIX H5TQ2G83BF R (256x8)	PASS
DSL	2GB	DDR3 1600	SODIMM DDR3	N	D3SS56081XH 12AA	SEC 113 HCK0 K4B2G0846C (256x8)	PASS
DSL	4GB	DDR3 1600	SODIMM DDR3	N	D3SS56082XH 12AA	SEC 113 HCK0 K4B2G0846C (256x8)	PASS
DSL	8GB	DDR3 1333	SODIMM DDR3	N	D3SE1208XL1 5AB	ELPIDA J4208EBBG- GN-F	PASS
DSL	8GB	DDR3 1600	SODIMM DDR3	N	D3SE1208XL1 2AA	ELPIDA J4208EBBG- GN-F	PASS
Apacer	2GB	DDR3 1600	SODIMM DDR3	N	78.A2GCJ.AF0 0C	HYNIX H5TQ2G83CF R (256x8)	PASS
Apacer	2GB	DDR3 1600	SODIMM DDR3	N	78.A2GCR.AT 00C	MICRON IYM22 D9PFJ (256x8)	PASS
Apacer	4GB	DDR3 1600	SODIMM DDR3	N	78.B2GCJ.AF1 0C	HYNIX H5TQ2G83CF R (256x8)	PASS
Apacer	4GB	DDR3 1600	SODIMM DDR3	N	78.B2GCR.AF 10C	HYNIX H5TC2G83EF R	PASS
Apacer	4GB	DDR3 1600	SODIMM DDR3	N	78.B2GCZ.AT0 0C	MICRON 2QE22 D9QBJ	PASS
Apacer	8GB	DDR3 1600	SODIMM DDR3	N	78.C2GCZ.AT3 0C	MICRON 2REI7 D9QBJ	PASS
Transcend	2GB	DDR3 1600	SODIMM DDR3	N	TS256MSK64 V6N	MICRON IVM77 D9PFJ	PASS
Transcend	4GB	DDR3 1600	SODIMM DDR3	N	TS512MSK64 V6N	MICRON 2DM77 D9PFJ 256x8	PASS
Transcend	4GB	DDR3 1600	SODIMM DDR3	N	TS512MSK64 W6H	SEC 231 HYK0 K4B4G0846B	PASS
Transcend	4GB	DDR3 1600	SODIMM DDR3	N	TS512MSK64 N6N	MICRON IRM72 D9PFJ	PASS
Transcend	8GB	DDR3 1600	SODIMM DDR3	N	TS1GSK64V6 H	MICRON IZD27 D9PBC 79T5 512x8	PASS
Transcend	8GB	DDR3 1600	SODIMM DDR3	N	TS1GSK64W6 H	SEC 231 HYK0 K4B4G0846B	PASS
ATP	8GB	DDR3 1600	SODIMM DDR3	N	AW24M64F8B LK0S	SEC 140 HYK0 K4B4G0846B 512x8	PASS

## Ordering Information

P/N	Chipset	DP++	CRT	DVI-D	LVDS	GbE LAN	COM	SATA III / II	USB3 .0/2.0	MiniPCIe	LPT	TPM	AMP	PClex16
AIMB-203G2-00A1E	H81	1	1	1	1	2	9	2/1	2/6	2 (1 x F/S; 1 x H/S)	1	(1)	2 x 6W	1
AIMB-203L-00A1E	H81	0	1	1	0	1	9	2/1	2/6	1 (F/S)	0	0	2 x 6W	1

\* ( ) is not populated when MP

## Product Warranty (2 years)

Advantech warrants to you, the original purchaser, that each of its products will be free from defects in materials and workmanship for two years from the date of purchase.

This warranty does not apply to any products which have been repaired or altered by persons other than repair personnel authorized by Advantech, or which have been subject to misuse, abuse, accident or improper installation. Advantech assumes no liability under the terms of this warranty as a consequence of such events.

Because of Advantech's high quality-control standards and rigorous testing, most of our customers never need to use our repair service. If an Advantech product is defective, it will be repaired or replaced at no charge during the warranty period. For out-of-warranty repairs, you will be billed according to the cost of replacement materials, service time and freight. Please consult your dealer for more details.

If you think you have a defective product, follow these steps:

1. Collect all the information about the problem encountered. (For example, CPU speed, Advantech products used, other hardware and software used, etc.) Note anything abnormal and list any onscreen messages you get when the problem occurs.
2. Call your dealer and describe the problem. Please have your manual, product, and any helpful information readily available.
3. If your product is diagnosed as defective, obtain an RMA (return merchandise authorization) number from your dealer. This allows us to process your return more quickly.
4. Carefully pack the defective product, a fully-completed Repair and Replacement Order Card and a photocopy proof of purchase date (such as your sales receipt) in a shippable container. A product returned without proof of the purchase date is not eligible for warranty service.
5. Write the RMA number visibly on the outside of the package and ship it prepaid to your dealer.

---

## Initial Inspection

Before you begin installing your motherboard, please make sure that the following materials have been shipped:

- 1 x AIMB-203 Intel Core™ i7/i5/i3 LGA1150 Mini-ITX motherboard
- 2 x SATA HDD cable
- 2 x Serial port cable
- 1 x I/O port bracket
- 1 x Startup manual
- 1 x Driver CD
- 1 x Warranty card

If any of these items are missing or damaged, contact your distributor or sales representative immediately. We have carefully inspected the AIMB-203 mechanically and electrically before shipment. It should be free of marks and scratches and in perfect working order upon receipt. As you unpack the AIMB-203, check it for signs of shipping damage. (For example, damaged box, scratches, dents, etc.) If it is damaged or it fails to meet the specifications, notify our service department or your local sales representative immediately. Also notify the carrier. Retain the shipping carton and packing material for inspection by the carrier. After inspection, we will make arrangements to repair or replace the unit.



# Contents

## Chapter 1 General Information .....1

1.1	Introduction .....	2
1.2	Features .....	2
1.3	Specifications .....	2
1.3.1	System .....	2
1.3.2	Memory .....	2
1.3.3	Input/Output .....	2
1.3.4	Graphics.....	3
1.3.5	Ethernet LAN .....	3
1.3.6	Industrial features .....	3
1.3.7	Mechanical and environmental specifications.....	3
1.4	Jumpers and Connectors .....	4
	Table 1.1: Connector and Header List.....	4
	Table 1.2: Jumper List.....	5
1.5	Board layout: Jumper and Connector Locations .....	6
	Figure 1.1 Jumper and Connector Location .....	6
1.6	AIMB-203 Board Diagram .....	7
	Figure 1.2 AIMB-203 Board Diagram .....	7
1.7	Safety Precautions .....	7
1.8	Jumper Settings .....	8
1.8.1	How to Set Jumpers.....	8
1.8.2	CMOS Clear (JCMOS1).....	8
	Table 1.3: CMOS1 .....	8
1.8.3	Case open selection pin header (JCASEOP_SW1) .....	8
	Table 1.4: Case open selection pin header (JCASEOP_SW1) ...	8
1.8.4	COM1_RI# Pin RI#/5V/12V selection (JSETCOM1_V1) .....	9
	Table 1.5: COM1_RI# Pin RI#/5V/12V selection (JSETCOM1_V1).....	9
1.8.5	COM2_RI# Pin RI#/5V/12V selection (JSETCOM2_V1) .....	9
	Table 1.6: COM2_RI# Pin RI#/5V/12V selection (JSETCOM2_V1).....	9
1.8.6	COM5 RS232,RS422,RS485 selection pin header (JSETCOM5)..	10
	Table 1.7: COM5 RS232,RS422,RS485 selection pin header (JSETCOM5).....	10
1.8.7	ATX/AT Mode Selection (PSON1) .....	11
	Table 1.8: ATX/AT Mode Selection (PSON1).....	11
1.8.8	LVDS Panel Voltage Selection (JLVDS1) .....	11
	Table 1.9: LVDS Panel Voltage Selection (JLVDS1) .....	11
1.8.9	Watchdog timer output and OBS beep (JWDT1+JOBS1) .....	11
	Table 1.10: Watchdog timer output and OBS beep (JWDT1+JOBS1).....	11
1.8.10	Power switch/HDD LED/SMBus/Speaker pin header (JFP1) ....	12
	Table 1.11: Power switch/HDD LED/SMBus/Speaker pin header (JFP1).....	12
1.9	System Memory .....	12
1.10	Memory Installation Procedures.....	12
1.11	Cache Memory.....	13
1.12	Processor Installation.....	13

## Chapter 2 Connecting Peripherals .....15

2.1	Introduction .....	16
2.2	USB Ports (LAN1_USB12/LAN2_USB34/USB56/USB78) .....	16

	Table 2.1: LAN LED Indicator.....	16
2.3	DVI-D(Up) and VGA(Down) connector (VGA1+DVI1) .....	17
2.4	Serial Ports (COM1~COM9) .....	18
2.5	PS/2 Keyboard and Mouse Connector (KBMS1).....	19
2.6	CPU Fan Connector (CPU_FAN1) .....	19
2.7	System FAN Connector (SYSFAN1/2) .....	20
2.8	Power Switch/HDD LED/SMBUS/Speaker Pin Header (JFP1) & Power LED and Keyboard Lock Pin Header (JFP2) .....	21
2.8.1	ATX soft power switch (JFP1/PWR_SW) .....	21
2.8.2	Reset (JFP1/RESET).....	21
2.8.3	HDD LED (JFP1/HDDLED) .....	21
2.8.4	External speaker (JFP1/SPEAKER).....	21
2.8.5	Power LED and keyboard lock connector (JFP2/PWR_LED & KEY LOCK).....	22
	Table 2.2: ATX power supply LED status (No support for AT power) .....	22
2.9	Display Port (DP1) .....	22
2.10	Print port interface box header (LPT1).....	23
2.11	SATA Signal Connector (SATA1 ~ SATA3).....	23
2.12	HD Analog Audio Interface (AUDIO1, FPAUD1) .....	24
2.13	PCI-E x16 Slot (PCIEX16_1) .....	25
2.14	LVDS Panel Connector (LVDS1).....	25
2.15	LVDS Backlight Inverter Power Connector (INV1).....	26
2.16	MINIPCIE and mSATA Connector (MINIPCIE1).....	27
2.17	MINIPCIE Connector (MINIPCIE2) & SIM Card Socket (SIM1).....	27
2.18	HD audio interface pin header (SPDIF1) .....	28
2.19	Audio Amplifier Output Connector (JAMP1) .....	29
2.20	General Purpose I/O Pin Header (GPIO1).....	29
2.21	SPI BIOS Flash Socket (SPI1).....	29
2.22	Low Pin Count Header (LPC1) .....	30
2.23	Case-Open Detect Connector (JCASE1).....	31
2.24	ATX 12V Power Supply Connector (ATX12V1) & ATX Power Supply Connector (ATXPWR1).....	31
2.25	CMOS battery Wafer Box (BAT1) .....	32
2.26	LGA 1150 CPU socket (CPU1).....	32
2.27	DDR3 SO-DIMM Socket (DIMMA1, DIMMB1).....	33

## **Chapter 3 BIOS Operation ..... 35**

3.1	Introduction .....	36
3.2	BIOS Setup .....	36
3.2.1	Main Menu .....	37
3.2.2	Advanced BIOS Features .....	38
3.2.3	Chipset.....	58
3.2.4	Boot .....	68
3.2.5	Security.....	69
3.2.6	Save & Exit .....	70

## **Chapter 4 Software Introduction & Service ..... 71**

4.1	Introduction .....	72
4.2	Value-Added Software Services .....	72
4.2.1	Software API.....	72

## **Chapter 5 Chipset Software Installation Utility 75**

5.1	Before You Begin.....	76
5.2	Introduction .....	76

5.3	Windows 7/8 Driver Setup.....	77
-----	-------------------------------	----

## **Chapter 6**    **VGA Setup.....79**

6.1	Introduction .....	80
6.2	Windows 7/8.....	80

## **Chapter 7**    **LAN Configuration.....81**

7.1	Introduction .....	82
7.2	Features .....	82
7.3	Installation .....	82
7.4	Windows® 7/8 Driver Setup (Realtek 8111E) .....	83

## **Appendix A**    **I/O Pin Assignments.....85**

A.1	PS/2 Keyboard and PS/2 Mouse Connector (KBMS1) .....	86
A.2	DVI-D(Up) and VGA(Down) Connector (VGA1+DVI1).....	86
A.3	DisplayPort connector (DP1).....	87
A.4	COM1 Connector (COM1) .....	88
A.5	RJ45+USB3.0 Stack Connector (LAN1_USB12).....	88
A.6	RJ45+USB2.0 Stack Connector (LAN2_USB34).....	89
A.7	HD Analog Audio Interface (AUDIO1).....	89
A.8	Case Open Selection Pin Header (JCASEOP_SW1) .....	90
A.9	Case Open Pin Header (JCASE1) .....	90
A.10	COM1 RI# Selection Pin Header (JSETCOM1_V1) .....	90
A.11	Front Panel Audio Pin Header (FPAUD1).....	91
A.12	HD Audio Interface Pin Header (SPDIF1).....	91
A.13	Print Port Interface Box Header (LPT1) .....	92
A.14	LVDS VESA, JEIDA Format Selection Pin Header (JLVDS_VCON1)....	92
A.15	Audio Amplifier Output Pin Header (JAMP1) .....	93
A.16	COM2 RI# Selection Pin Header (JSETCOM2_V1) .....	93
A.17	LVDS Backlight Inverter Power Connector (INV1).....	94
A.18	LVDS Panel Voltage Selection (JLVDS1) .....	94
A.19	LVDS Panel Connector (LVDS1) .....	95
A.20	ATX 12V Power Supply Connector (ATX12V1) .....	96
A.21	Low Pin Count Interface Header (LPC1).....	96
A.22	8-bit General Purpose I/O Pin Header (GPIO1).....	97
A.23	COM2 ~ COM5 Box Header (COM2345).....	97
A.24	COM5 RS232,RS422,RS485 Selection Pin Header (JSETCOM5) .....	98
A.25	MINIPCI, mSATA Connector (MINIPCI1).....	98
A.26	MINIPCI Connector (MINIPCI2) .....	100
A.27	Serial ATA Interface Connector (SATA1~SATA3) .....	101
A.28	PCI-Express x16 Slot (PCIEX16_1).....	101
A.29	SPI BIOS Flash Socket (SPI1).....	103
A.30	COM6 ~ COM9 Box Header (COM6789).....	104
A.31	LGA 1150 CPU Socket (CPU1) .....	104
A.32	Dual Port USB2.0 Pin Header (USB78) .....	105
A.33	Dual Port USB2.0 Pin Header (USB56) .....	105
A.34	Watchdog Timer Output and OBS Beep (JWDT1+JOBS1) .....	105
A.35	AT/ATX Mode Selection (PSON1) .....	106
A.36	ATX Power Supply Connector (ATXPWR1).....	106
A.37	CMOS Battery Wafer Box (BAT1).....	107
A.38	CMOS Mode Selection (JCMOS1).....	107
A.39	Power LED and Keyboard Lock Pin Header (JFP2) .....	107
A.40	Power Switch/HDD LED/SMBus/Speaker Pin Header (JFP1).....	108
A.41	CPU FAN Connector (CPUFAN1).....	108
A.42	System Fan1 Connector (SYSFAN1).....	108

---

A.43	System Fan2 Connector (SYSFAN2) .....	109
A.44	SIM Card Holder (SIM2) .....	109

# Chapter 1

General Information

## 1.1 Introduction

AIMB-203 is designed with the Intel® H81 for industrial applications that require both performance computing and enhanced power management capabilities. The motherboard supports Intel desktop Core i7-4770S 3.1GHz / Core i7-4770TE 2.3GHz / i5-4570S 2.9GHz / i5-4570TE 2.7GHz / i3-4330 3.5GHz / i3-4330TE 2.4GHz / Pentium G3420 3.2GHz / Pentium G3320TE 2.3GHz / Celeron G1820 2.7GHz / Celeron G1820TE 2.2GHz processor up to 8 MB L3 cache and DDR3 SO-DIMM 1333/1600 up to 16GB. A rich I/O connectivity of 9 serial ports, 8 USB, dual GbE LAN and 3 SATA ports.

## 1.2 Features

- **Rich I/O connectivity:** 9 x serial ports, 2 x USB 3.0, 6 x USB 2.0, 2 x SATA 3.0, 1 x SATA 2.0, Dual GbE LAN
- **Standard Mini-ITX form factor with industrial feature:** The AIMB-203 is a full-featured Mini-ITX motherboard with balanced expandability and performance
- **Wide selection of storage devices:** SATA HDD, mSATA, customers benefit from the flexibility of using the most suitable storage device for larger capacity.
- **Optimized integrated graphic solution:** With Intel® Graphics Flexible, supports versatile display options and 32-bit 3D graphics engine

## 1.3 Specifications

### 1.3.1 System

- **CPU:** LGA1150 Intel desktop Core i7-4770S 3.1GHz / Core i7-4770TE 2.3GHz / i5-4570S 2.9GHz / i5-4570TE 2.7GHz / i3-4330 3.5GHz / i3-4330TE 2.4GHz / Pentium G3420 3.2GHz / Pentium G3320TE 2.3GHz / Celeron G1820 2.7GHz / Celeron G1820TE 2.2GHz
- **BIOS:** AMI EFI 64 Mbit SPI BIOS
- **System chipset:** Intel® H81
- **SATA hard disk drive interface:**
  - Two on-board SATA connectors with data transmission rate up to 600 MB
  - One on-board SATA connector with data transmission rate up to 300 MB

### 1.3.2 Memory

- **RAM:** Up to 16 GB in 2 slots 204-pin SODIMM sockets. Supports dual channel DDR3 1333/1600 MHz SDRAM

### 1.3.3 Input/Output

- **PCI bus:** 1 PCIe x16 slot
- **Serial ports:** Nine serial ports, 8 x RS-232 & 1 x RS-232/422/485
- **Keyboard and PS/2 mouse connector:** Supports one standard PS/2 keyboard, one standard PS/2 mouse
- **USB port:** Supports up to eight USB ports with transmission rates up to 625 MB, 4 on board pin headers with USB 2.0, 2 external ports with USB 2.0, and 2 external ports with USB 3.0
- **GPIO connector:** 8-bit general purpose Input/Output

### 1.3.4 Graphics

- **Controller:** Intel® Gfx Gen 7.5, HD graphics
- **Display memory:** 1 GB maximum shared memory with 2GB and above system memory installed
- **VGA:** Supports VGA up to resolution 1920 x 1200 @ 60 Hz refresh rate
- **LVDS:** Supports LVDS up to resolution 1920 x 1200
- **Displayport1.2:** Supports Display port up to resolution 3840 x 2160 @ 60Hz
- **DVI-D:** Supports DVI-D up to resolution 1920 x 1200

### 1.3.5 Ethernet LAN

- Supports dual 10/100/1000 Mbps Ethernet port (s) via PCI Express x1 bus which provides 500 MB/s data transmission rate
- **Controller:** LAN1: Realtek 8111E; LAN2: Realtek 8111E

### 1.3.6 Industrial features

- **Watchdog timer:** Can generate a system reset. The watchdog timer is programmable, with each unit equal to one second or one minute (255 levels)

### 1.3.7 Mechanical and environmental specifications

- **Operating temperature:** 0 ~ 60° C (32 ~ 140° F, Depending on CPU)
- **Storage temperature:** -40 ~ 85° C (-40 ~ 185° F)
- **Humidity:** 5 ~ 95% non-condensing
- **Power supply voltage:** +3.3 V, +5 V, +12 V, -12 V, 5 Vsb
- **Power consumption:**  
Intel Core i7-4770S 3.1GHz, 2pcs 8GB DDR3 1600MHz SDRAM, +5V @ 2.21A, +3.3V @ 1.03A, +12V @ 5.1A, 5VSB @ 0.4A  
Measure the maximum current value which system under maximum load (CPU: Top speed, RAM & Graphic: Full loading)
- **Board size:** 170 mm x 170 mm (6.69" x 6.69")
- **Board weight:** 0.365 kg

## 1.4 Jumpers and Connectors

Connectors on the AIMB-203 motherboard link it to devices such as hard disk drives and a keyboard. In addition, the board has a number of jumpers used to configure your system for your application.

The tables below list the function of each of the board jumpers and connectors. Later sections in this chapter give instructions on setting jumpers. Chapter 2 gives instructions for connecting external devices to your motherboard.

**Table 1.1: Connector and Header List**

	<b>Description</b>	<b>Part Reference</b>
1	PS/2 keyboard and PS/2 mouse connector	KBMS1
2	DVI-D (Up) and VGA (Down) connector	VGA1+DVI1
3	DisplayPort connector	DP1
4	COM1 connector	COM1
5	RJ45+USB3.0 stack connector	LAN1_USB12
6	RJ45+USB3.0 stack connector	LAN2_USB34
7	HD Analog Audio Interface	AUDIO1
8	Case open selection pin header	JCASEOP_SW1
9	Case open pin header	JCASE1
10	COM1 RI# selection pin header	JSETCOM1_V1
11	Front panel audio pin header	FPAUD1
12	HD audio interface pin header	SPDIF1
13	Print port interface box header	LPT1
14	LVDS VESA, JEIDA format selection pin header	JLVDS_VCON1
15	Audio amplifier output pin header	JAMP1
16	COM2 RI# selection pin header	JSETCOM2_V1
17	LVDS Backlight inverter power connector	INV1
18	LVDS panel voltage selection	JLVDS1
19	LVDS panel connector	LVDS1
20	ATX 12V power supply connector	ATX12V1
21	Low pin count interface header	LPC1
22	8-bits General Purpose I/O pin header	GPIO1
23	COM2 ~ COM5 box header	COM2345
24	COM5 RS232,RS422,RS485 selection pin header	JSETCOM5
25	MINIPCIE, mSATA connector	MINIPCIE1
26	MINIPCIE connector	MINIPCIE2
27	Serial ATA interface connector	SATA1 ~ SATA3
28	PCI-Express x16 slot	PCIEX16_1
29	SPI BIOS flash socket	SPI1
30	COM6 ~ COM9 box header	COM6789
31	LGA 1150 CPU socket	CPU1
32	Dual port USB2.0 pin header	USB78
33	Dual port USB2.0 pin header	USB56
34	Watchdog timer output and OBS beep	JWDT1+JOBS1
35	AT/ATX Mode selection	PSON1
36	ATX Power supply connector	ATXPWR1
37	CMOS battery wafer box	BAT1



38	CMOS Mode selection	JCMOS1
39	Power LED and keyboard lock pin header	JFP2
40	Power switch/HDD LED/SMBus/Speaker pin header	JFP1
41	CPU FAN connector	CPUFAN1
42	DDR3 SO-DIMM socket	DIMMA1
43	DDR3 SO-DIMM socket	DIMMB1
44	System fan1 connector	SYSFAN1
45	System fan2 connector	SYSFAN2
46	SIM Card holder	SIM2

**Table 1.2: Jumper List**

Label	Function
JCASEOP_SW1	Case open selection pin header
JSETCOM1_V1	COM1_RI# Pin RI#/5V/12V selection
JSETCOM2_V1	COM2_RI# Pin RI#/5V/12V selection
JSETCOM5	COM5 RS232,RS422,RS485 selection pin header
JCMOS1	CMOS Mode selection
JWDT1+JOBS1	Watchdog timer output and OBS beep
JFP1	Power switch/HDD LED/SMBus/Speaker pin header
PERSON1	AT/ATX Mode selection
JLVDS1	LVDS panel voltage selection

## 1.5 Board layout: Jumper and Connector Locations

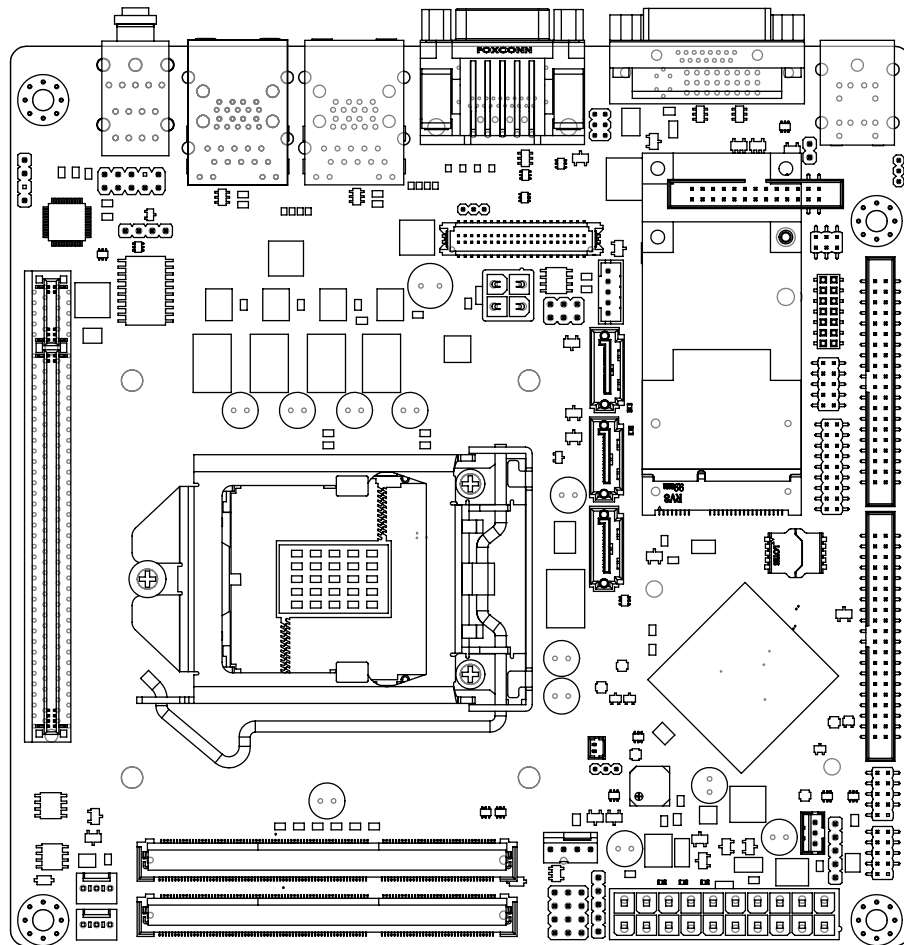

Figure 1.1 Jumper and Connector Location

## 1.6 AIMB-203 Board Diagram

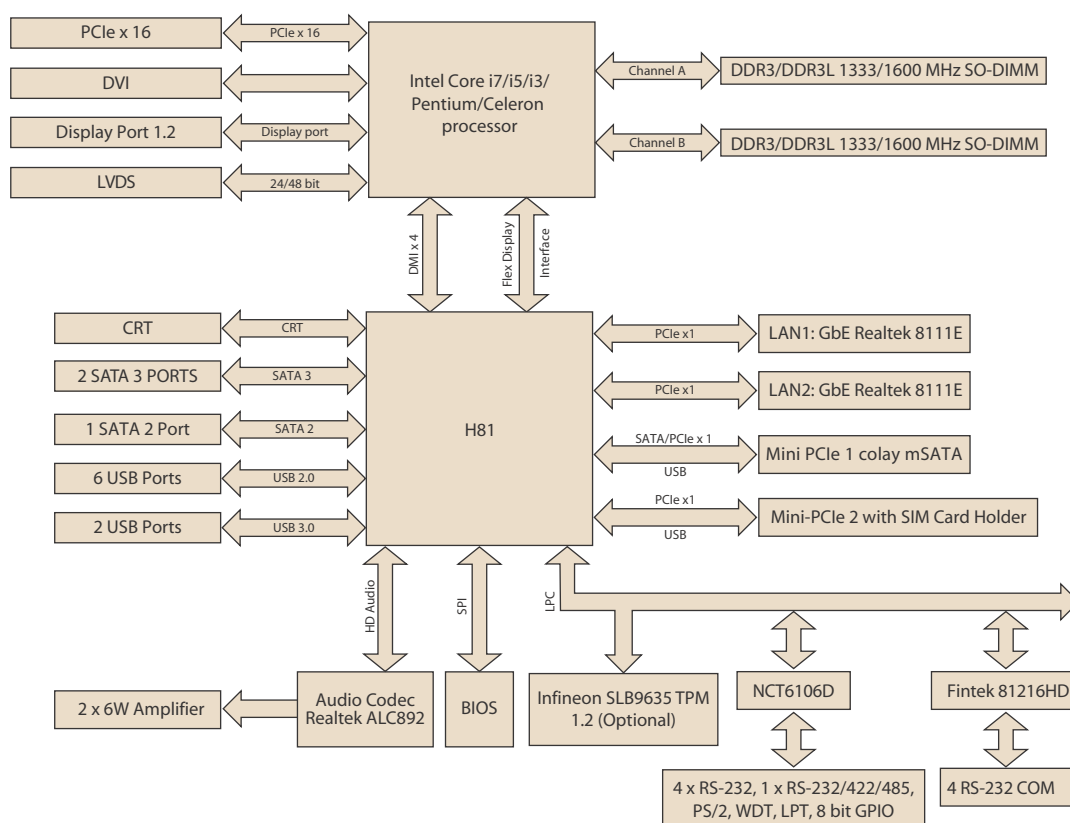

Figure 1.2 AIMB-203 Board Diagram

## 1.7 Safety Precautions

**Warning!** Always completely disconnect the power cord from chassis whenever you work with the hardware. Do not make connections while the power is on. Sensitive electronic components can be damaged by sudden power surges. Only experienced electronics personnel should open the PC chassis.



**Caution!** Always ground yourself to remove any static charge before touching the motherboard. Modern electronic devices are very sensitive to electrostatic discharges. As a safety precaution, use a grounding wrist strap at all times. Place all electronic components on a static-dissipative surface or in a static-shielded bag when they are not in the chassis.



**Caution!** The computer is provided with a battery-powered real-time clock circuit. There is a danger of explosion if battery is incorrectly replaced. Replace only with same or equivalent type recommended by the manufacturer. Discard used batteries according to manufacturer's instructions.



**Caution!** There is a danger of a new battery exploding if it is incorrectly installed. Do not attempt to recharge, force open, or heat the battery. Replace the battery only with the same or equivalent type recommended by the manufacturer. Discard used batteries according to the manufacturer's instructions.



## 1.8 Jumper Settings

This section provides instructions on how to configure your motherboard by setting the jumpers. It also includes the motherboards's default settings and your options for each jumper.

### 1.8.1 How to Set Jumpers

You can configure your motherboard to match the needs of your application by setting the jumpers. A jumper is a metal bridge that closes an electrical circuit. It consists of two metal pins and a small metal clip (often protected by a plastic cover) that slides over the pins to connect them. To “close” (or turn ON) a jumper, you connect the pins with the clip. To “open” (or turn OFF) a jumper, you remove the clip. Sometimes a jumper consists of a set of three pins, labeled 1, 2, and 3. In this case you connect either pins 1 and 2, or 2 and 3. A pair of needle-nose pliers may be useful when setting jumpers.

### 1.8.2 CMOS Clear (JCMOS1)

The AIMB-203 motherboard contains a jumper that can erase CMOS data and reset the system BIOS information. Normally this jumper should be set with pins 1-2 closed. If you want to reset the CMOS data, set CMOS1 to 2-3 closed for just a few seconds, and then move the jumper back to 1-2 closed. This procedure will reset the CMOS to its default setting.

**Table 1.3: CMOS1**

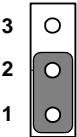
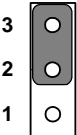
Function	Setting
Normal (Default)	
Clear CMOS	

### 1.8.3 Case open selection pin header (JCASEOP\_SW1)

**Table 1.4: Case open selection pin header (JCASEOP\_SW1)**

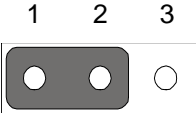
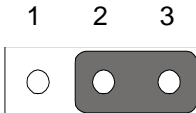
Function	Setting
Normal Close (Default)	
Normal Open	

### 1.8.4 COM1\_RI# Pin RI#/5V/12V selection (JSETCOM1\_V1)

**Table 1.5: COM1\_RI# Pin RI#/5V/12V selection (JSETCOM1\_V1)**

Function	Setting
Set COM1_RI# as RI# (Default)	
Set COM1_RI# as 5V	
Set COM1_RI# as 12V	

### 1.8.5 COM2\_RI# Pin RI#/5V/12V selection (JSETCOM2\_V1)

**Table 1.6: COM2\_RI# Pin RI#/5V/12V selection (JSETCOM2\_V1)**

Function	Setting
Set COM2_RI# as RI# (Default)	
Set COM2_RI# as 5V	
Set COM2_RI# as 12V	

## 1.8.6 COM5 RS232,RS422,RS485 selection pin header (JSETCOM5)

**Table 1.7: COM5 RS232,RS422,RS485 selection pin header (JSETCOM5)**

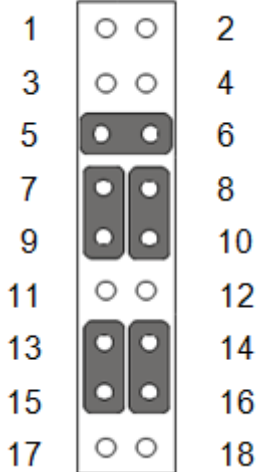
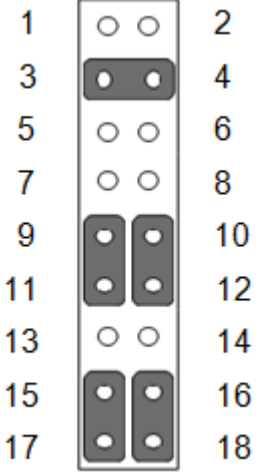
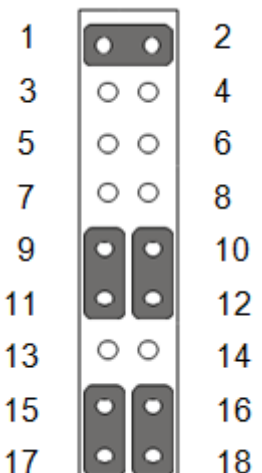
Function	Setting		
Set COM5 as RS-232 (Default)			
	Set COM5 as RS-422		
		Set COM5 as RS-485	

## 1.8.7 ATX/AT Mode Selection (PSON1)

**Table 1.8: ATX/AT Mode Selection (PSON1)**

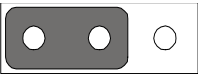
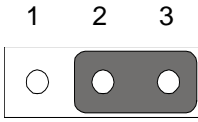
Function	Jumper Setting
AT Mode	 1 2 3 1-2 closed
ATX Mode (Default)	 1 2 3 2-3 closed

## 1.8.8 LVDS Panel Voltage Selection (JLVDS1)

**Table 1.9: LVDS Panel Voltage Selection (JLVDS1)**

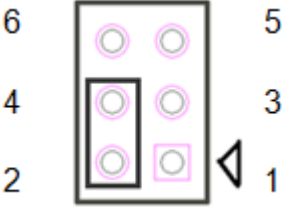
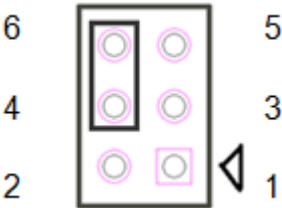
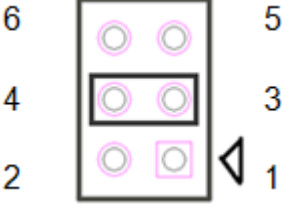
Function	Jumper Setting
Set LVDS Panel as +5V	 6 5 4 3 2 1
Set LVDS Panel as +3.3V (Default)	 6 5 4 3 2 1
Set LVDS Panel as +12V	 6 5 4 3 2 1

## 1.8.9 Watchdog timer output and OBS beep (JWDT1+JOBS1)

**Table 1.10: Watchdog timer output and OBS beep (JWDT1+JOBS1)**

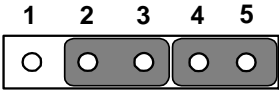
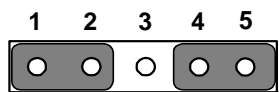
Function	Setting
Watchdog Timer Output(2-3) (Default) OBS BEEP(4-5) (Default)	 1 2 3 4 5
Watchdog Timer Disable(1-2) OBS BEEP(4-5) (Default)	 1 2 3 4 5

## 1.8.10 Power switch/HDD LED/SMBus/Speaker pin header (JFP1)

**Table 1.11: Power switch/HDD LED/SMBus/Speaker pin header (JFP1)**

**Function**

**Setting**

JFP1(7-10) (Default)

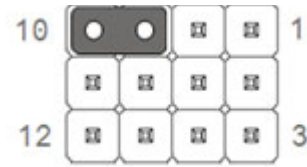

Pin	Signal	Pin	Signal
1	+5V	2	HDD LED+
3	Power Button+	4	NC
5	HDD LED-	6	Power Button-
7	SPK_P3	8	SMB_DATA
9	System Reset+	10	SPK_P4
11	SMB_CLK	12	System Reset-

## 1.9 System Memory

AIMB-203 has two sockets for a 204-pin DDR3 SODIMM. This socket uses a 1.5 V unbuffered double data rate synchronous DRAM (DDR SDRAM). DRAM is available in capacities of 1 GB, 2 GB, 4 GB and 8 GB. The sockets can be filled in any combination with SODIMMs of any size, giving a total memory size between 1 GB, 2 GB, 4 GB, 8 GB and 16 GB. AIMB-203 does NOT support ECC (error checking and correction).

## 1.10 Memory Installation Procedures

To install SODIMMs, slowly slide the SODIMM module along the plastic guides on both ends of the socket. Then firmly but gently (avoid pushing down too hard) press the SODIMM module well down into the socket, until you hear a click when the two handles have automatically locked the memory module into the correct position of the SODIMM socket. To remove the memory module, just push both handles outward, and the memory module will be ejected by the mechanism.



## 1.11 Cache Memory

The AIMB-203 supports a CPU with one of the following built-in full speed Last Level Cache:

8MB for Intel Core i7-4770S

8MB for Intel Core i7-4770TE

6MB for Intel Core i5-4570S

4MB for Intel Core i5-4570TE

3MB for Intel Core i3-4330

3MB for Intel Core i3-4330TE

3MB for Intel Pentium G3420

3MB for Intel Pentium G3320TE

2MB for Intel Celeron G1820

2MB for Intel Celeron G1820TE

The built-in second-level cache in the processor yields much higher performance than conventional external cache memories.

## 1.12 Processor Installation

The AIMB-203 is designed for LGA1150, Core i7/Core i5/Core i3, Pentium, Celeron processor.



# Chapter 2

Connecting  
Peripherals

## 2.1 Introduction

You can access most of the connectors from the top of the board as it is being installed in the chassis. If you have a number of cards installed or have a packed chassis, you may need to partially remove the card to make all the connections.

## 2.2 USB Ports (LAN1\_USB12/LAN2\_USB34/USB56/USB78)

AIMB-203 provides up to eight USB ports. Two USB3.0 and two USB2.0 on the rear side and four pin header on the board. The USB interface complies with USB Specification Rev. 2.0 and Rev. 3.0 supporting transmission rates up to 625 Mbps and is fuse protected. The USB interface can be disabled in the system BIOS setup.

The AIMB-203 is equipped with two high-performance 1000 Mbps Ethernet LAN adapter, which are supported by all major network operating systems. The RJ-45 jacks on the rear panel provides for convenient LAN connection.

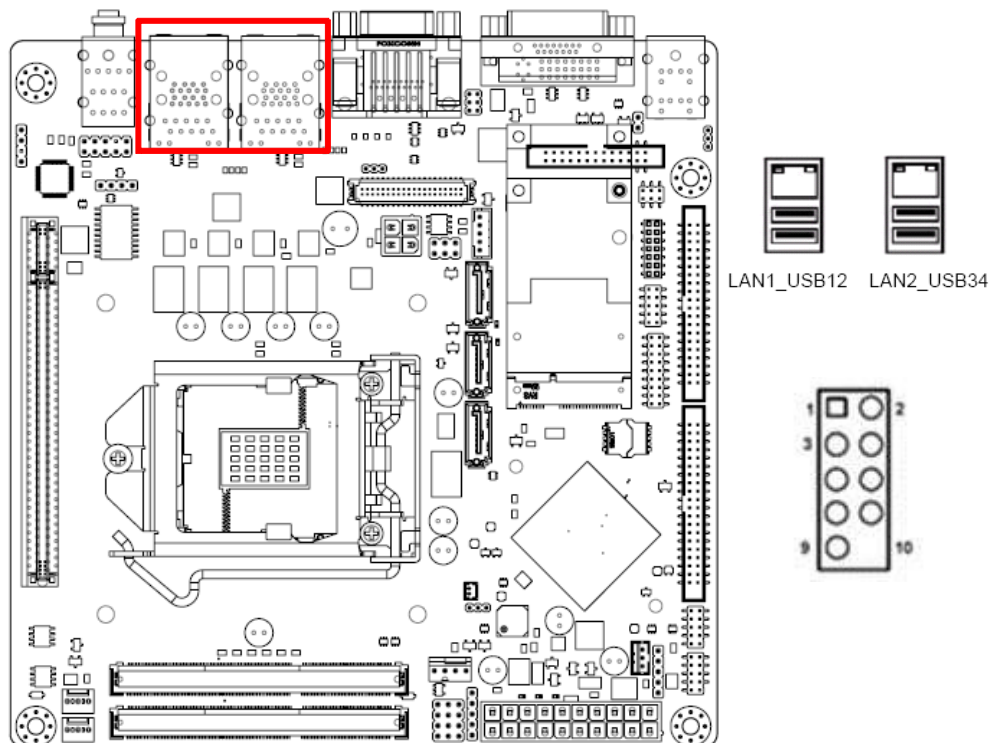

**Table 2.1: LAN LED Indicator**

LAN Mode	LAN Indicator	
LAN1 indicator	LED1 (Right)	off for mal-link; Link (On) / Active (Flash)
	LED2 (Left)	100 Mbps (On) / 10 Mbps (Off)
	LED2 (Left)	1000 Mbps (On)
LAN2 indicator	LED1 (Right)	off for mal-link; Link (On) / Active (Flash)
	LED2 (Left)	100 Mbps (On) / 10 Mbps (Off)
	LED2 (Left)	1000 Mbps (On)

## 2.3 DVI-D(Up) and VGA(Down) connector (VGA1+DVI1)

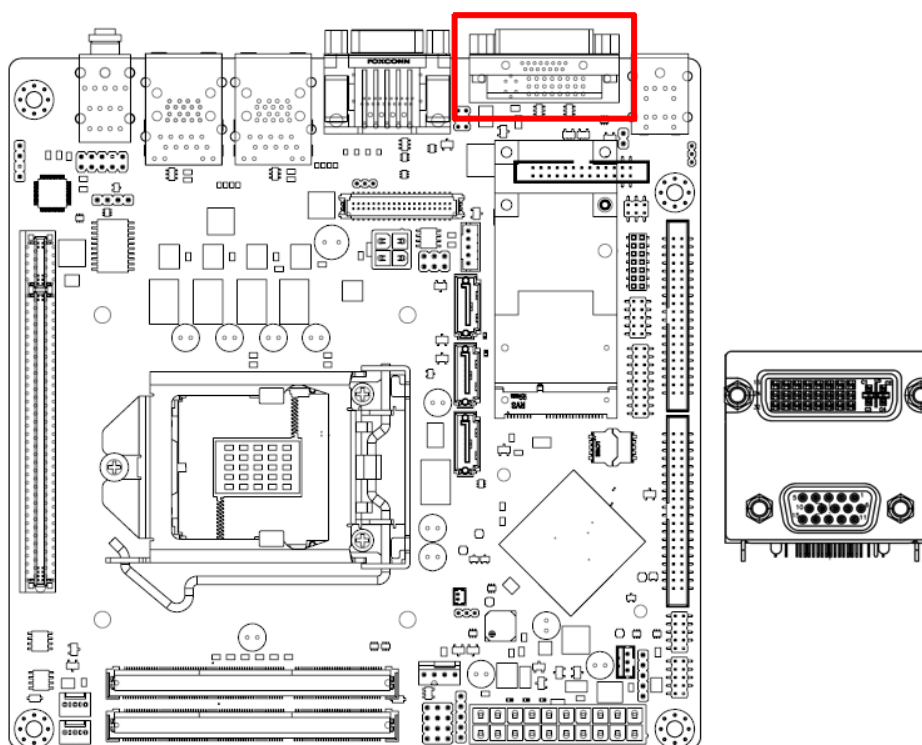

AIMB-203 includes VGA and DVI-D interfaces that can drive conventional VGA and DVI-D displays. VGA is a standard 15-pin D-SUB connector commonly used for VGA. Pin assignments for VGA and DVI-D connectors are detailed in Appendix A.

## 2.4 Serial Ports (COM1~COM9)

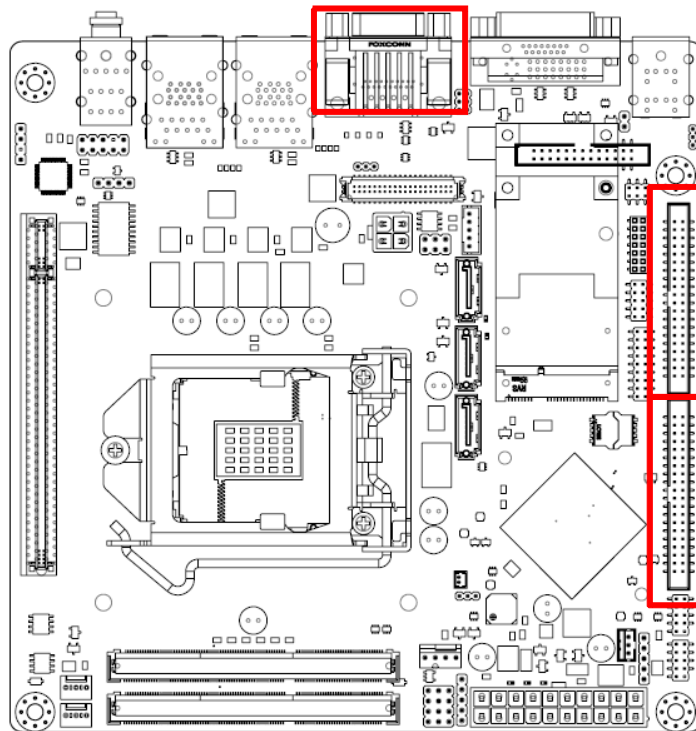

COM1

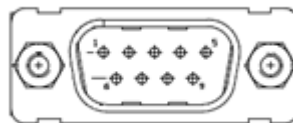

COM2 ~ COM5 box header (COM2345)

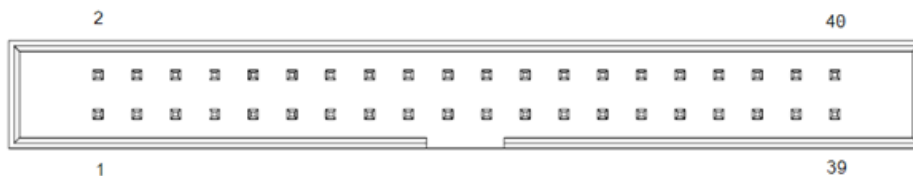

COM6 ~ COM9 box header (COM6789)

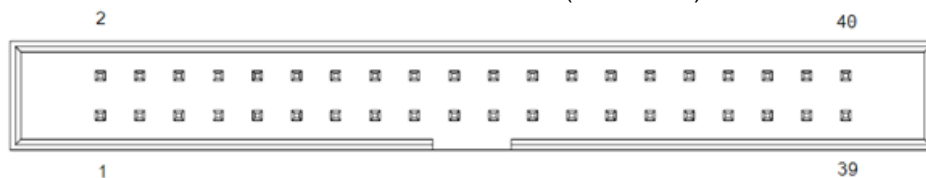

AIMB-203 supports nine serial ports. COM1~4 and COM6~9 supports RS-232 function, COM5 supports RS-232/422/485 function by BIOS selection. COM1 and COM2 supports 5V/12V by jumper selection.

These ports can connect to serial devices, such as a mouse or a printer, or to a communications network.

The IRQ and address ranges for both ports are fixed. However, if you want to disable the port or change these parameters later, you can do this in the system BIOS setup.

Different devices implement the RS-232 standards in different ways. If you have problems with a serial device, be sure to check the pin assignments for the connector.

## 2.5 PS/2 Keyboard and Mouse Connector (KBMS1)

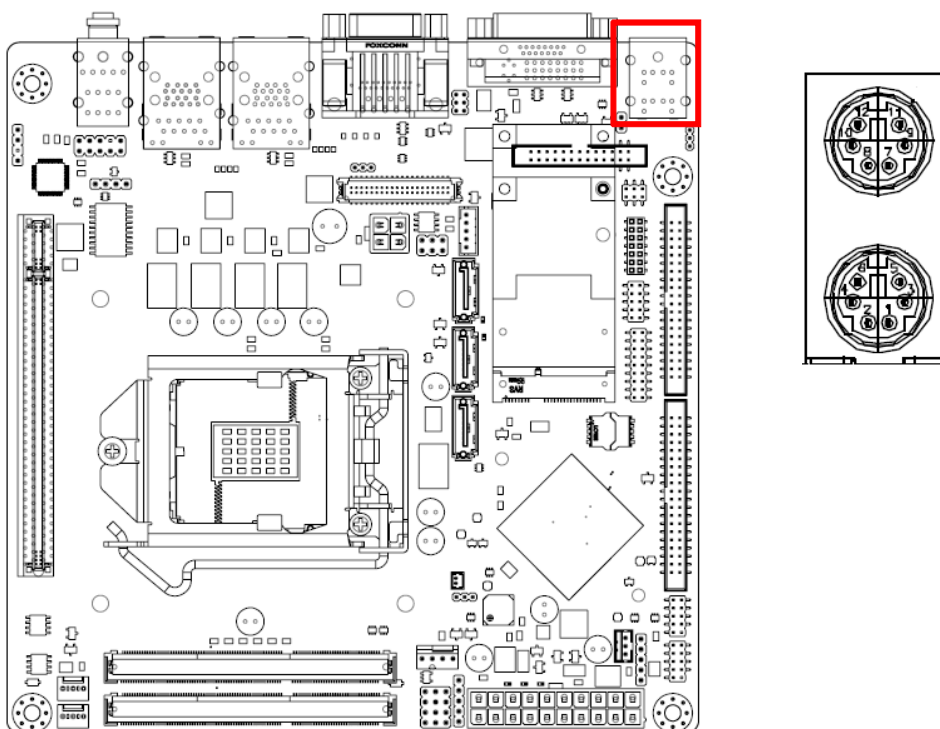

Two 6-pin mini-DIN connectors (KBMS1) on the motherboard provide connection to a PS/2 keyboard and a PS/2 mouse, respectively.

## 2.6 CPU Fan Connector (CPU\_FAN1)

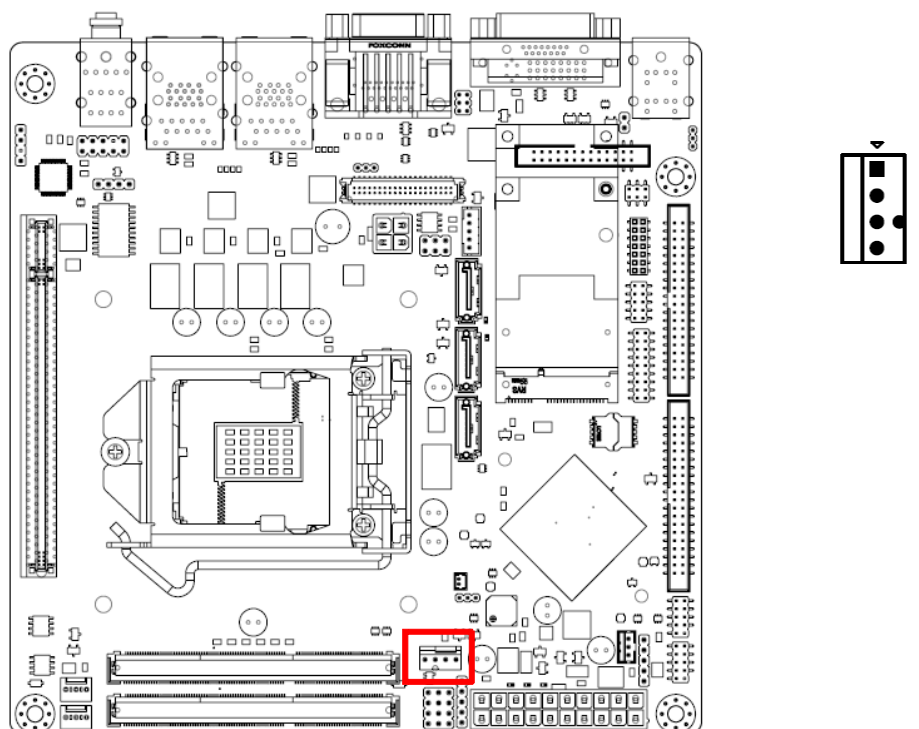

If a fan is used, this connector supports cooling fans of 500 mA (6 W) or less.

## 2.7 System FAN Connector (SYSFAN1/2)

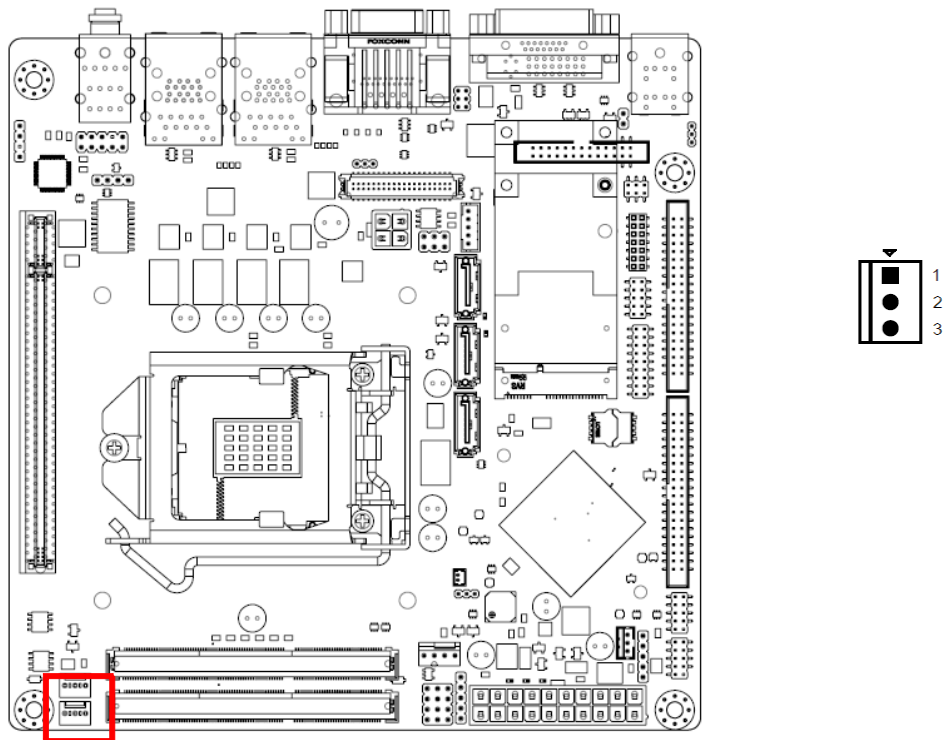

If a fan is used, this connector supports cooling fans of 500 mA (6 W) or less.



## 2.8 Power Switch/HDD LED/SMBUS/Speaker Pin Header (JFP1) & Power LED and Keyboard Lock Pin Header (JFP2)

There are several headers for monitoring and controlling the AIMB-203.

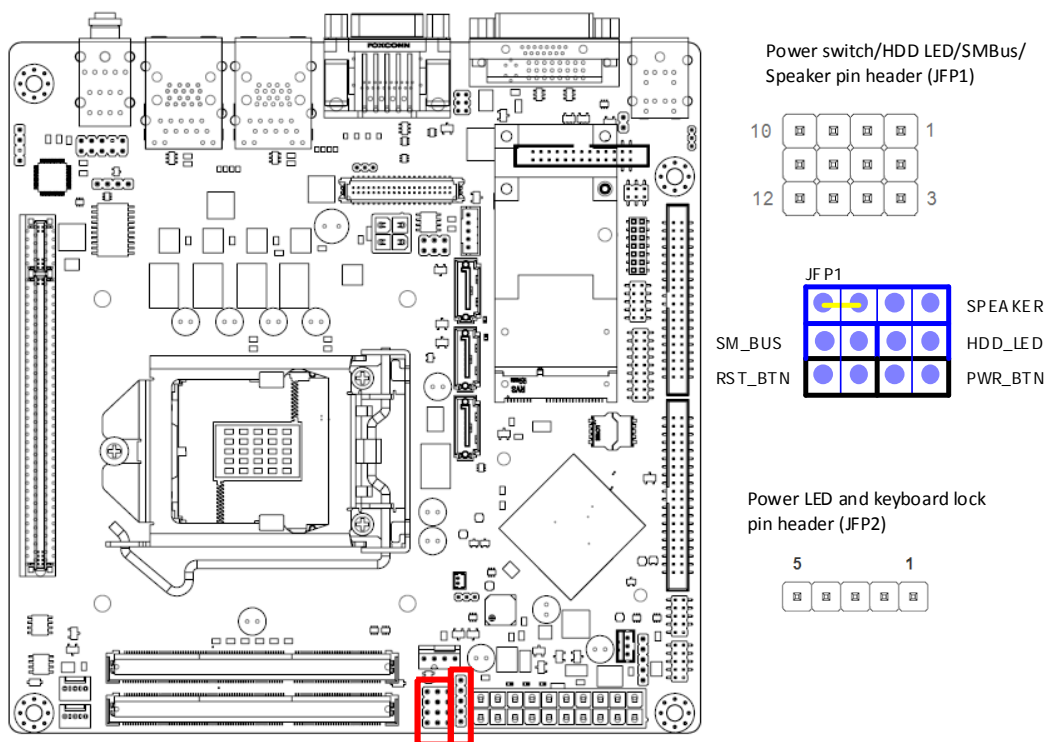

### 2.8.1 ATX soft power switch (JFP1/PWR\_SW)

If your computer case is equipped with an ATX power supply, you should connect the power on/off button on your computer case to (JFP1/ PWR\_SW), for convenient power on and off.

### 2.8.2 Reset (JFP1/RESET)

Many computer cases offer the convenience of a reset button. Connect the wire for the reset button.

### 2.8.3 HDD LED (JFP1/HDDLED)

You can connect an LED to connector (JFP1/HDDLED) to indicate when the HDD is active.

### 2.8.4 External speaker (JFP1/SPEAKER)

JFP1/SPEAKER is a 4-pin connector for an external speaker. If there is no external speaker, the AIMB-203 provides an onboard buzzer as an alternative. To enable the buzzer, set pins 7 & 10 as closed.

## 2.8.5 Power LED and keyboard lock connector (JFP2/PWR\_LED & KEY LOCK)

(JFP2/PWR\_LED & KEY LOCK) is a 5-pin connector for the power on LED and Key Lock function. Refer to Appendix B for detailed information on the pin assignments. The Power LED cable should be connected to pin 1-3. The key lock button cable should be connected to pin 4-5. There are 3 modes for the power supply connection. The first is “ATX power mode”; the system turns on/off by a momentary power button. The second is “AT Power Mode”; the system turns on/off via the power supply switch. The third is another “AT Power Mode” which makes use of the front panel power switch. The power LED status is indicated in the following table:

**Table 2.2: ATX power supply LED status (No support for AT power)**

Power mode	LED (ATX Power Mode) (On/off by momentary button)	LED (AT power Mode) (On/off by switching power supply)	LED (AT power Mode) (On/off by front panel switch)
PSON1 (on back plane) jumper setting	pins 2-3 closed	pins 1-2 closed	Connect pins 1 & 2 to panel switch via cable
System On	On	On	On
System Suspend	Fast flashes	Fast flashes	Fast flashes
System Off	Slow flashes	Off	Off

## 2.9 Display Port (DP1)

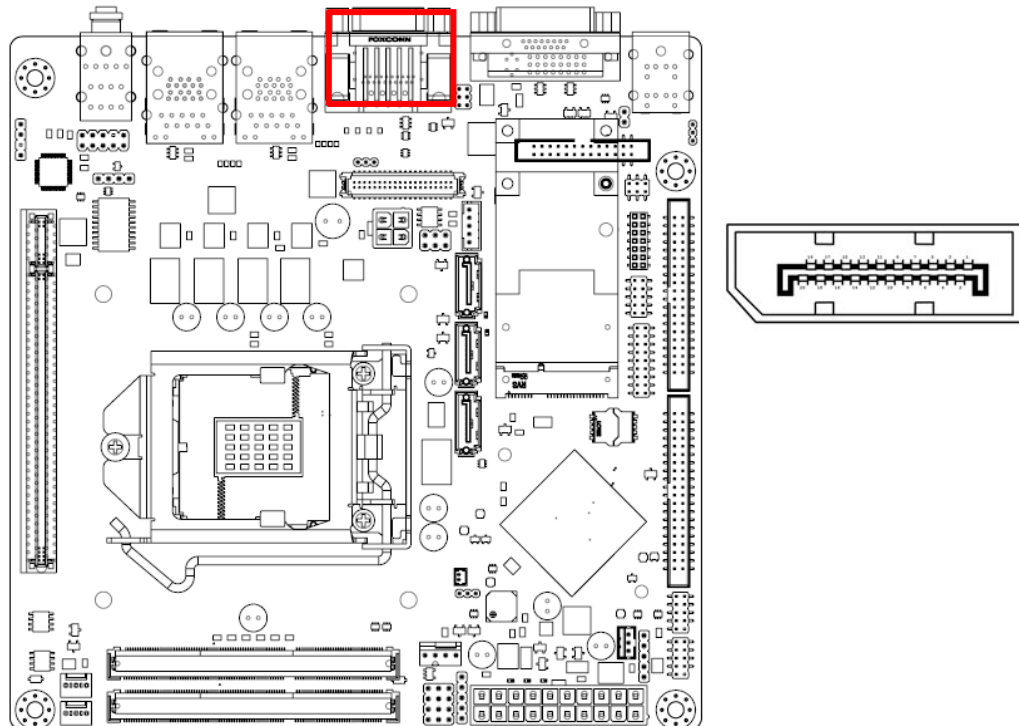

## 2.10 Print port interface box header (LPT1)

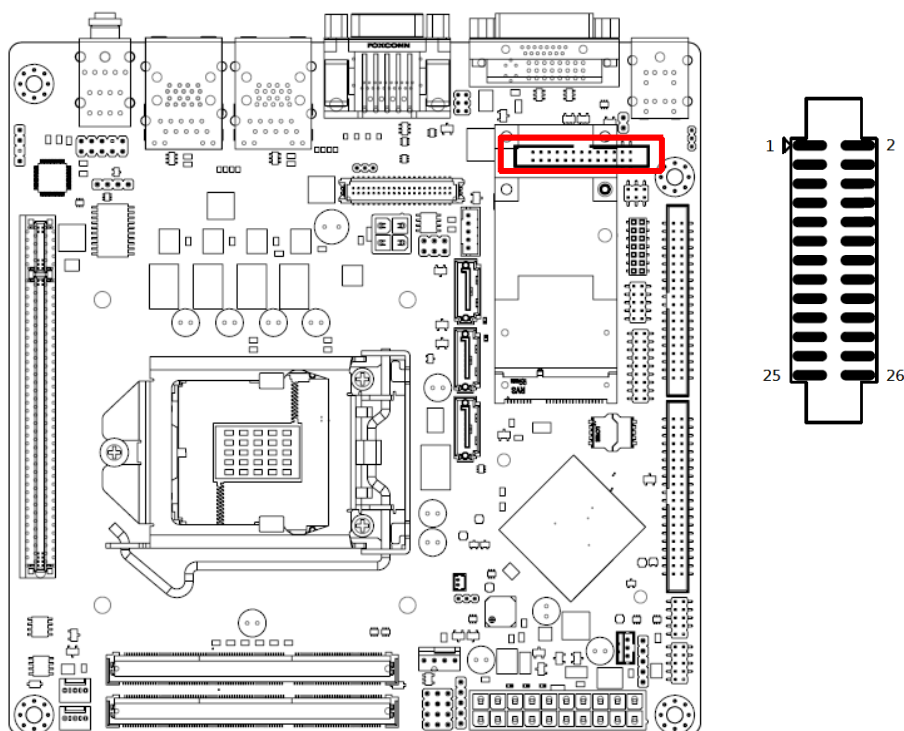

## 2.11 SATA Signal Connector (SATA1 ~ SATA3)

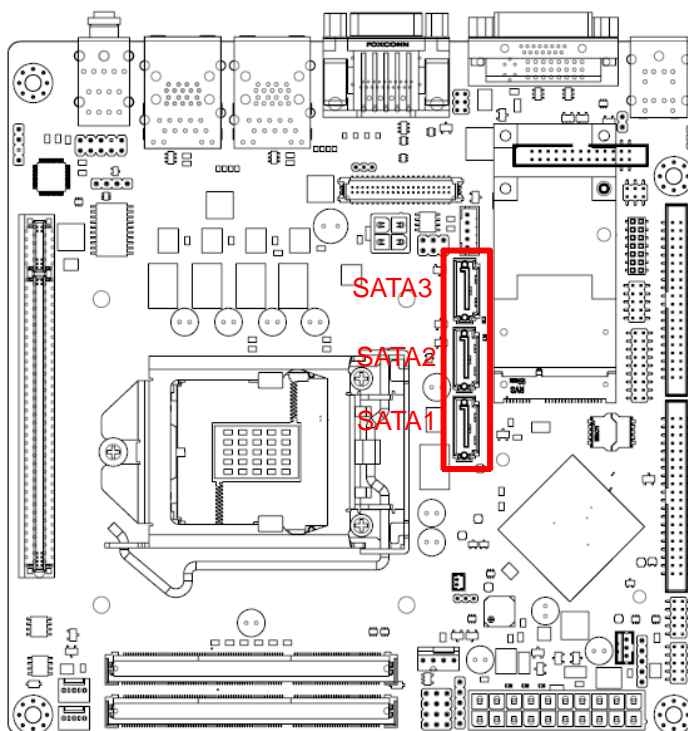

AIMB-203 features a high performance Serial ATA III & II interface (up to 600 MB/s & 300 MB/s) which eases hard drive cabling with thin, space-saving cables.

## 2.12 HD Analog Audio Interface (AUDIO1, FPAUD1)

Front headphone connector (FPAUD1) is for a chassis-mounted front panel audio I/O module that supports HD Audio. Connect this connector with the front panel audio I/O module cable.

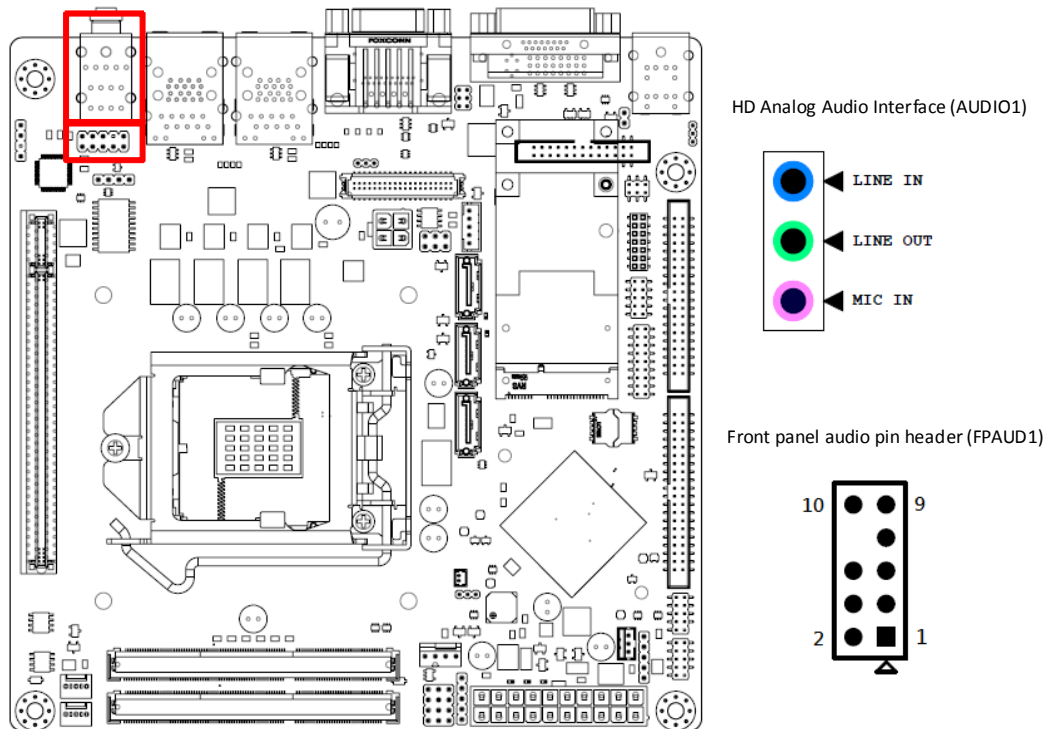

**Note!** For motherboards with the optional HD Audio feature, we recommend that you connect a high-definition front panel audio module to this connector to take advantage of the motherboard's high definition audio capability.



## 2.13 PCI-E x16 Slot (PCIEX16\_1)

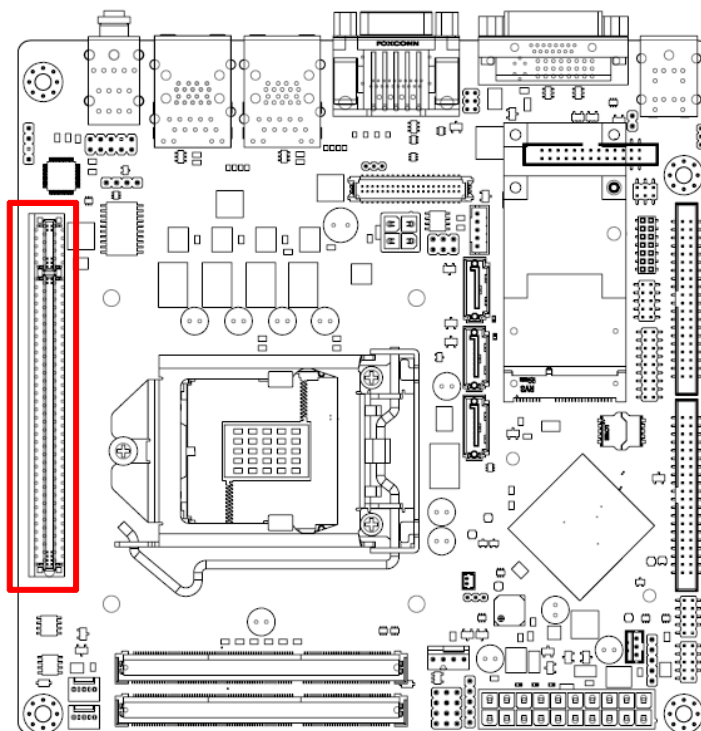

AIMB-203 provides 1 x PCI express x16 slot.

## 2.14 LVDS Panel Connector (LVDS1)

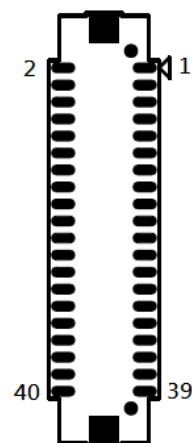
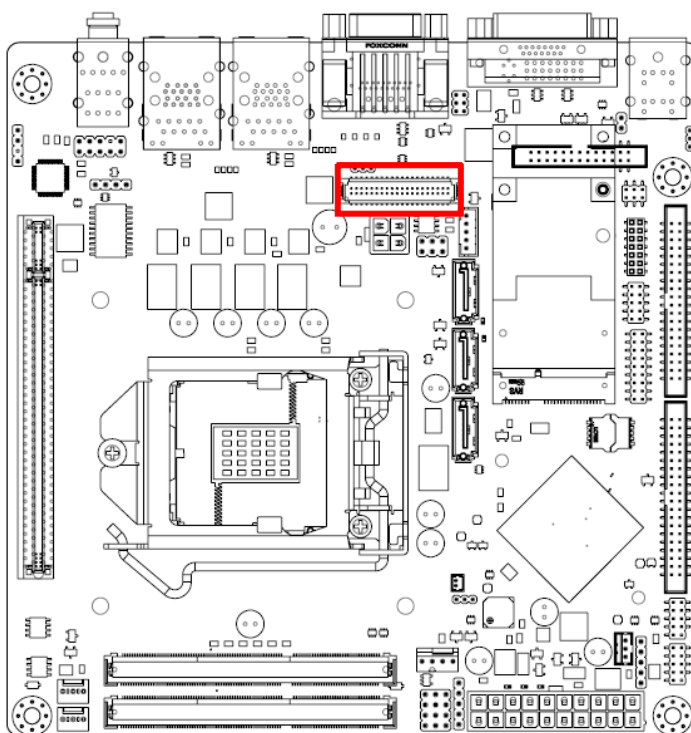

## 2.15 LVDS Backlight Inverter Power Connector (INV1)

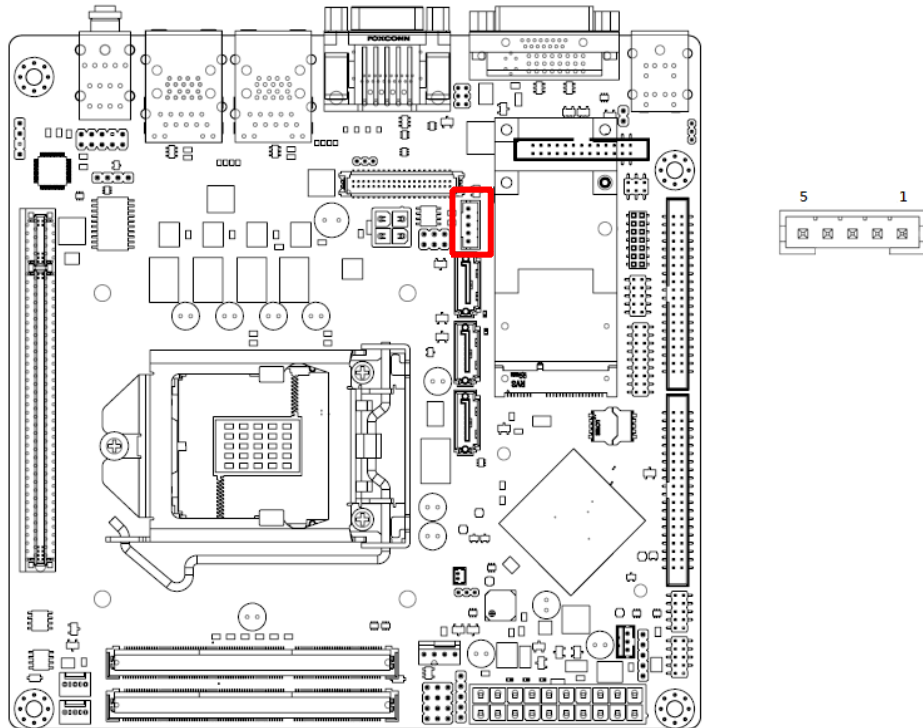

**Note!**



■ **Signal Description**

**Signal**

VR

ENBKL

**Signal Description**

Vadj=0.75 V

(Recommended: 4.7 K $\Omega$ , >1/16 W)

LCD backlight ON/OFF control signal

## 2.16 MINIPCIIE and mSATA Connector (MINIPCIIE1)

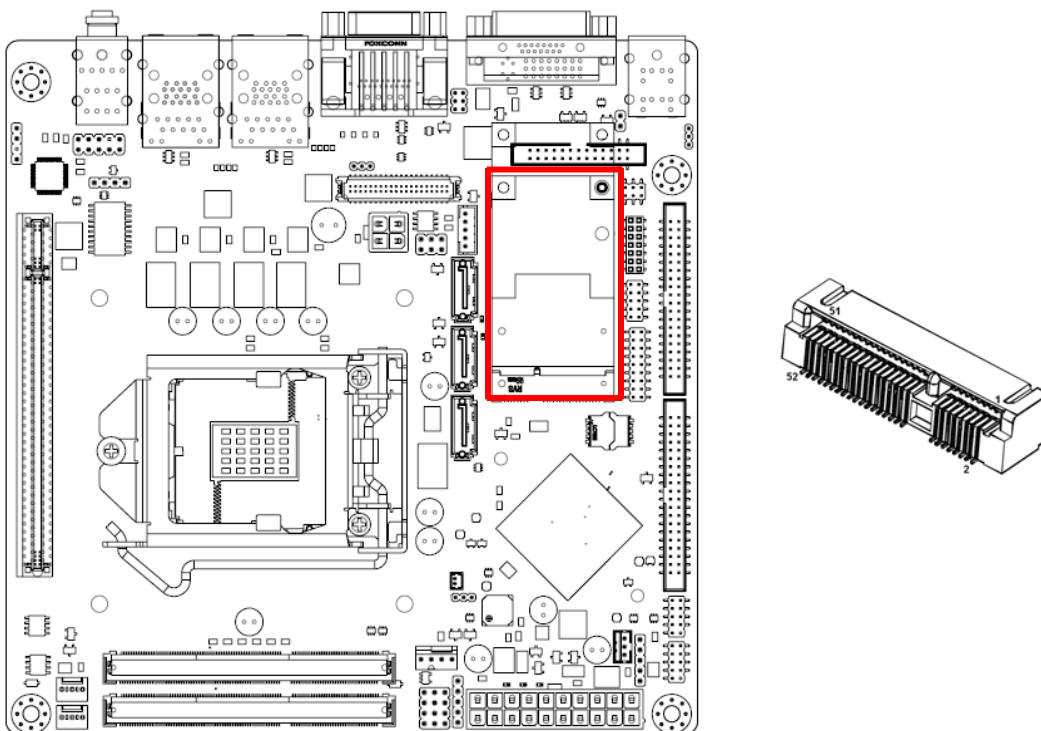

## 2.17 MINIPCIIE Connector (MINIPCIIE2) & SIM Card Socket (SIM1)

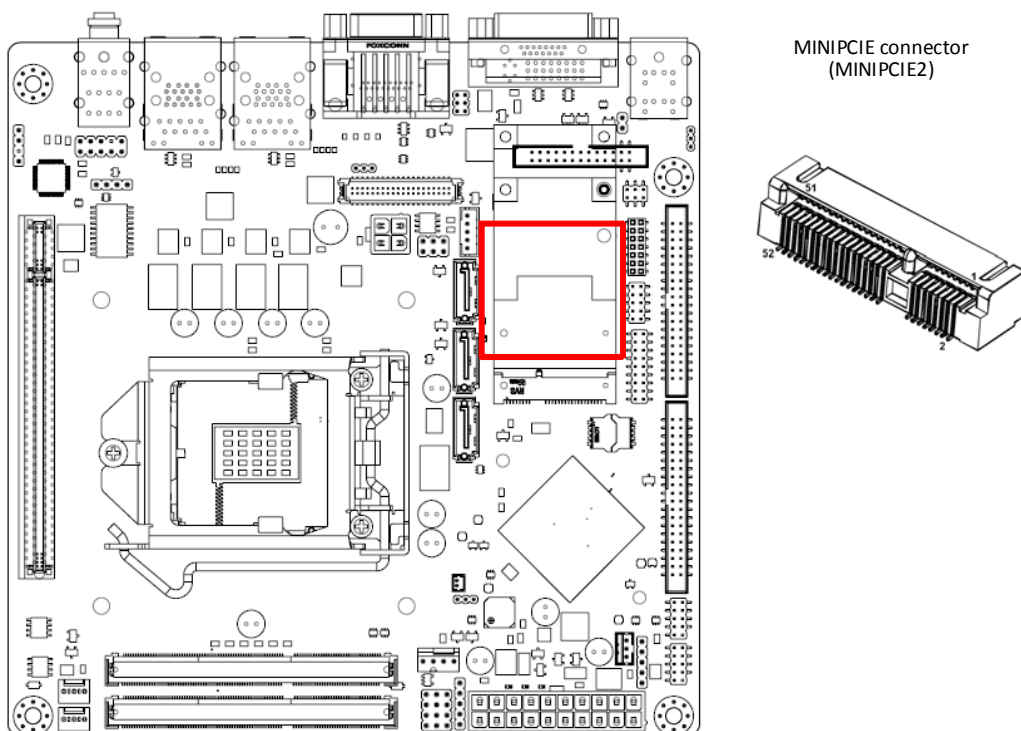

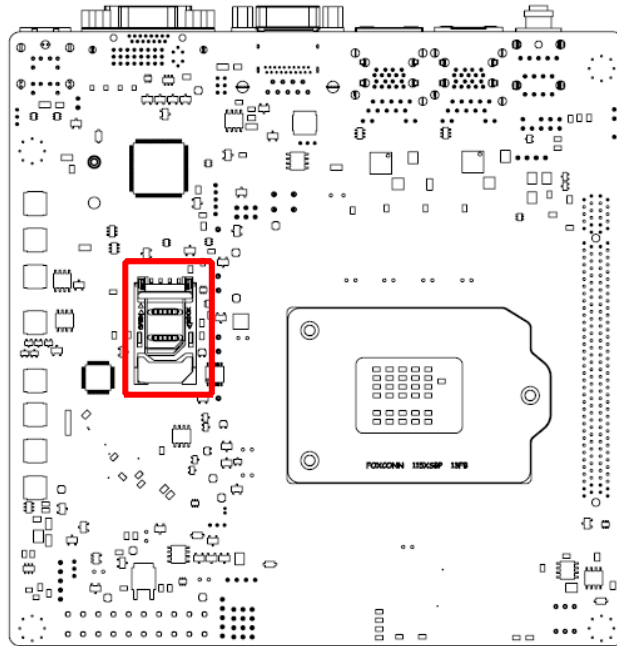

SIM Card holder (SIM2)



## 2.18 HD audio interface pin header (SPDIF1)

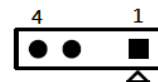
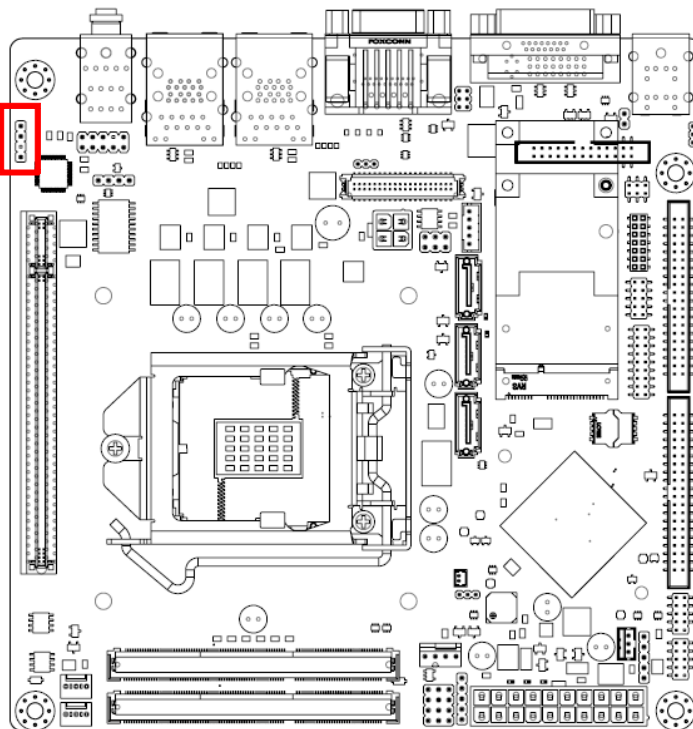



## 2.19 Audio Amplifier Output Connector (JAMP1)

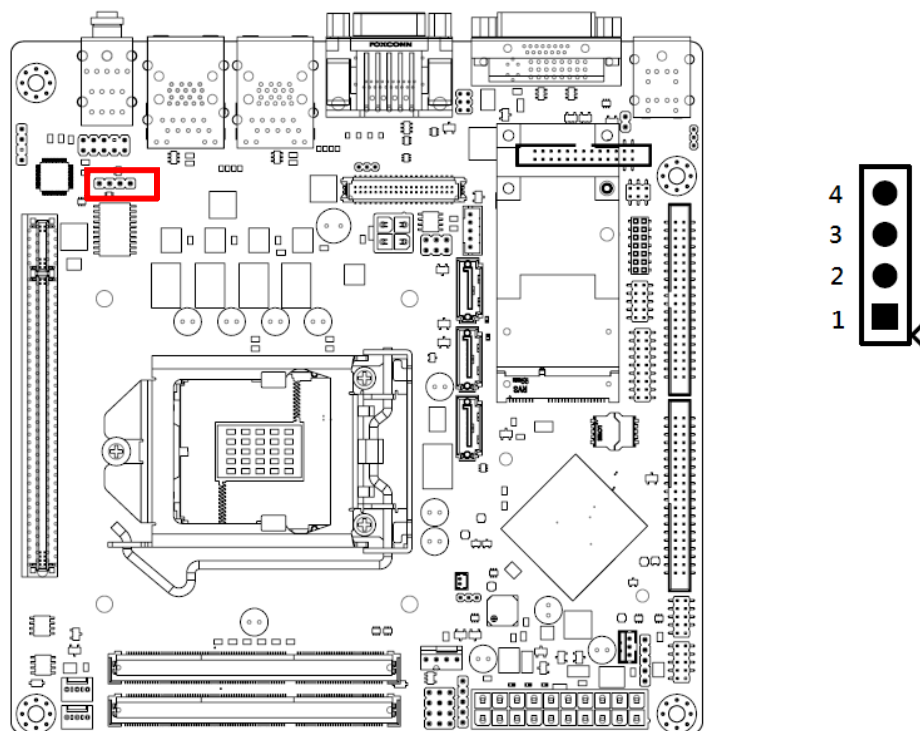

## 2.20 General Purpose I/O Pin Header (GPIO1)

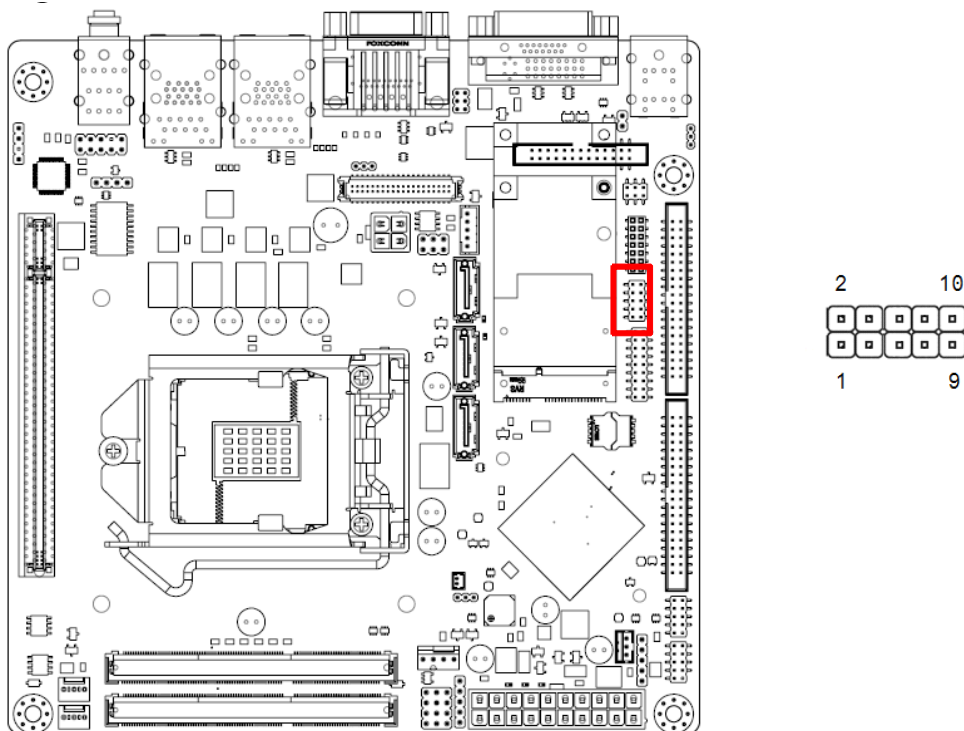

## 2.21 SPI BIOS Flash Socket (SPI1)

The SPI flash card pin header may be used to flash BIOS if the AIMB-203 cannot power on.

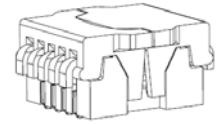
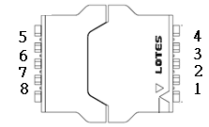
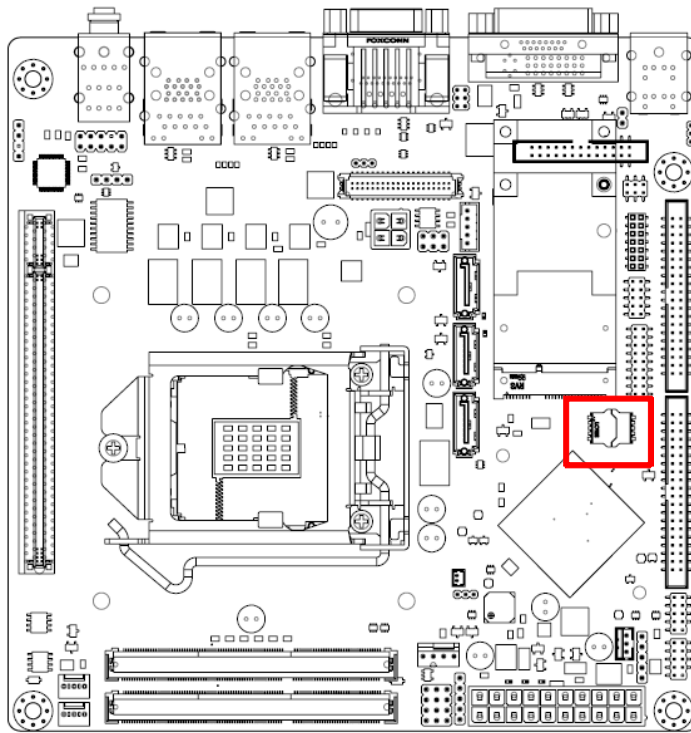

## 2.22 Low Pin Count Header (LPC1)

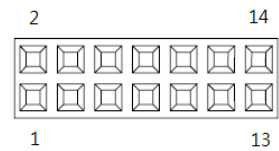
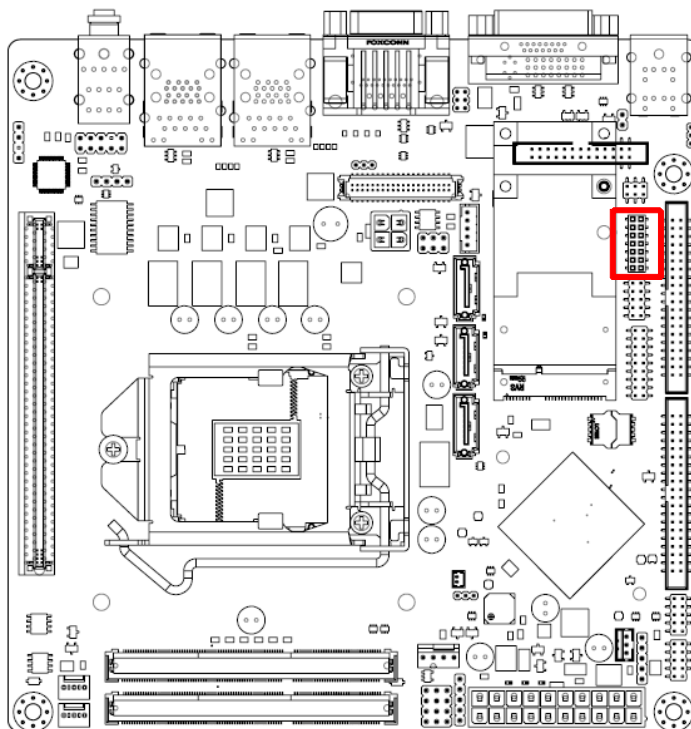

## 2.23 Case-Open Detect Connector (JCASE1)

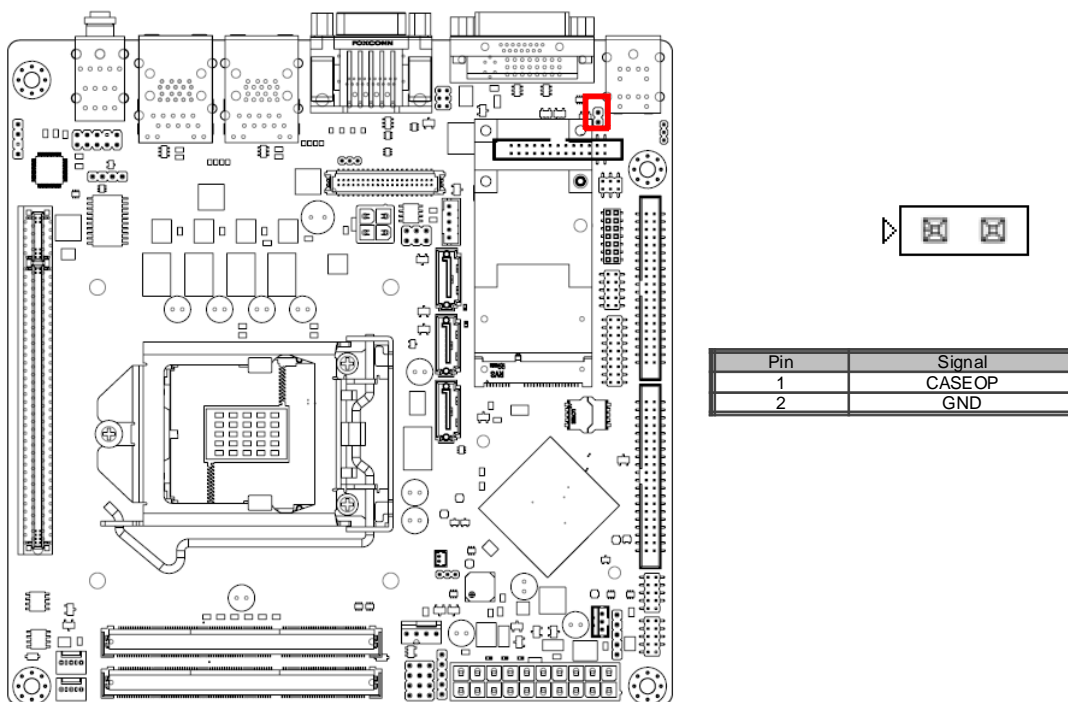

## 2.24 ATX 12V Power Supply Connector (ATX12V1) & ATX Power Supply Connector (ATXPWR1)

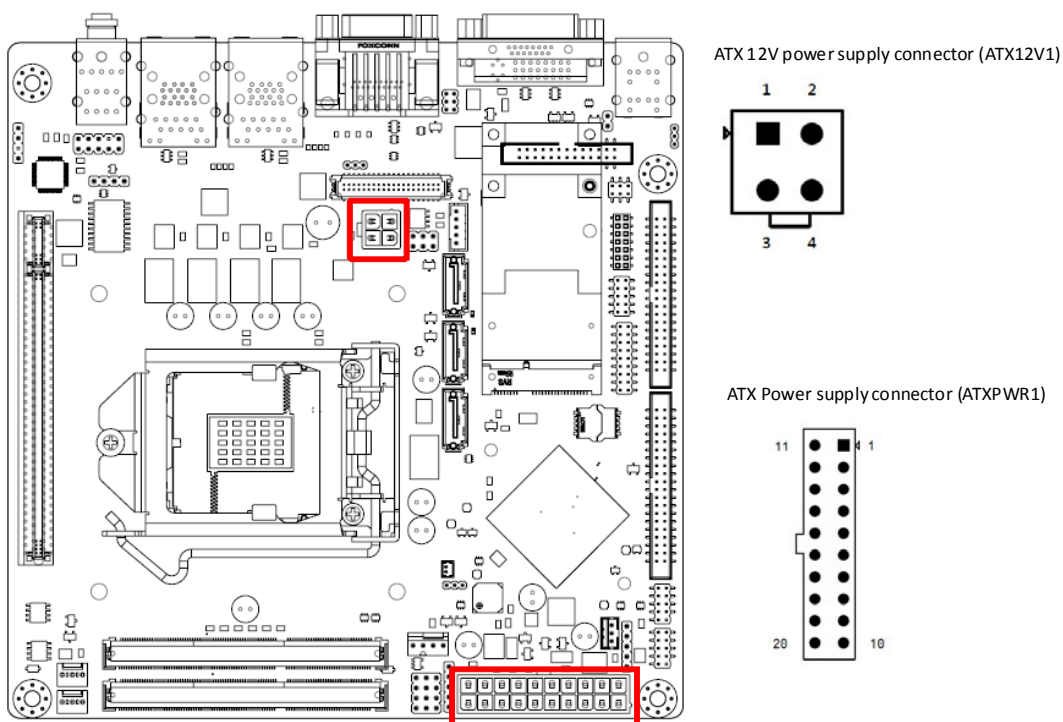

## 2.25 CMOS battery Wafer Box (BAT1)

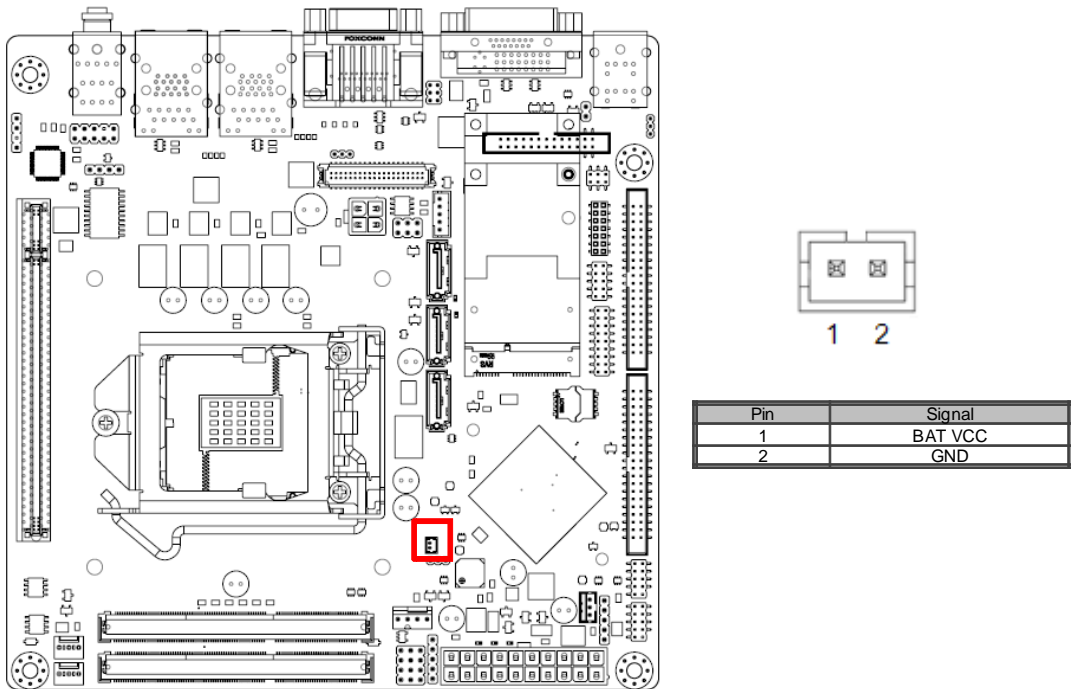

## 2.26 LGA 1150 CPU socket (CPU1)

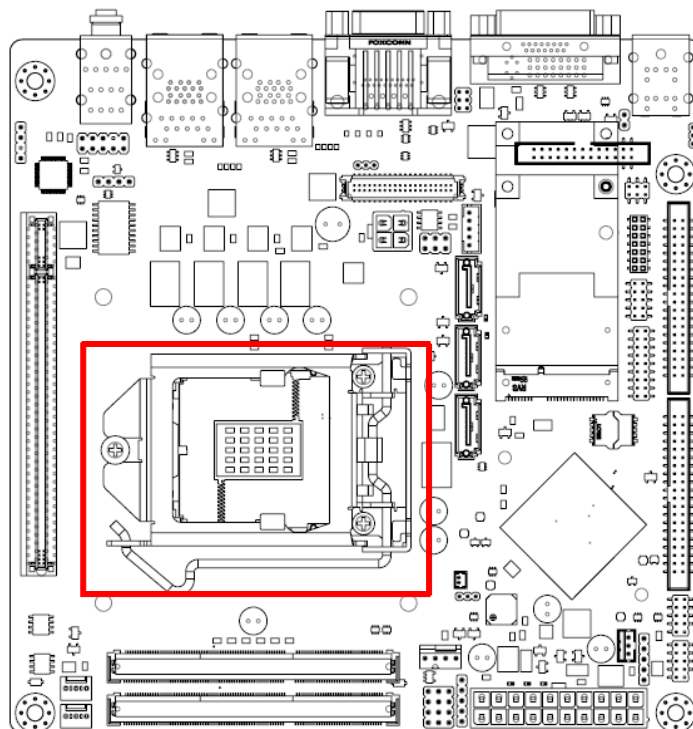

## 2.27 DDR3 SO-DIMM Socket (DIMMA1, DIMMB1)

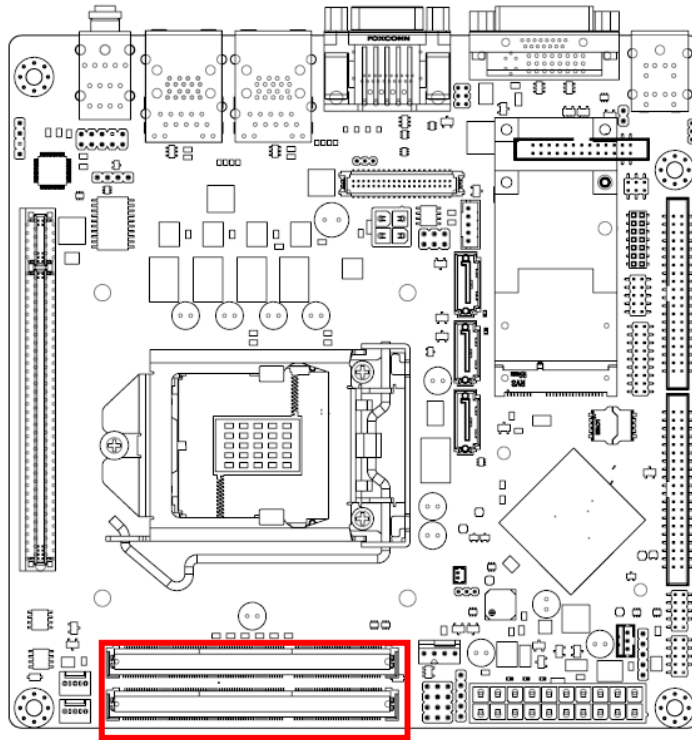



# Chapter 3

BIOS Operation

## 3.1 Introduction

With the AMI BIOS Setup program, you can modify BIOS settings and control the special features of your computer. The Setup program uses a number of menus for making changes and turning special features on or off. This chapter describes the basic navigation of the AIMB-203 setup screens.

## 3.2 BIOS Setup

The AIMB-203 Series system has AMI BIOS built in, with a CMOS SETUP utility that allows users to configure required settings or to activate certain system features.

The CMOS SETUP saves the configuration in the CMOS RAM of the motherboard. When the power is turned off, the battery on the board supplies the necessary power to preserve the CMOS RAM.

When the power is turned on, press the <Del> button during the BIOS POST (Power-On Self Test) to access the CMOS SETUP screen.

---

### Control Keys

---

< ↑ >> ↓ >> ← >> → >	Move to select item
----------------------	---------------------

<Enter>	Select Item
---------	-------------

<Esc>	Main Menu - Quit and not save changes into CMOS Sub Menu - Exit current page and return to Main Menu
-------	---

<Page Up/+>	Increase the numeric value or make changes
-------------	--

<Page Down/->	Decrease the numeric value or make changes
---------------	--

<F1>	General help, for Setup Sub Menu
------	----------------------------------

<F2>	Item Help
------	-----------

<F5>	Load Previous Values
------	----------------------

<F7>	Load Setup Defaults
------	---------------------

<F10>	Save all CMOS changes
-------	-----------------------

---



### 3.2.1 Main Menu

Press <Del> to enter AMI BIOS CMOS Setup Utility, the Main Menu will appear on the screen. Use arrow keys to select among the items and press <Enter> to accept or enter the sub-menu.



The Main BIOS setup screen has two main frames. The left frame displays all the options that can be configured. Grayed-out options cannot be configured; options in blue can. The right frame displays the key legend.

Above the key legend is an area reserved for a text message. When an option is selected in the left frame, it is highlighted in white. Often a text message will accompany it.

#### 3.2.1.1 System time / System date

Use this option to change the system time and date. Highlight System Time or System Date using the <Arrow> keys. Enter new values through the keyboard. Press the <Tab> key or the <Arrow> keys to move between fields. The date must be entered in MM/DD/YY format. The time must be entered in HH:MM:SS format.

### 3.2.2 Advanced BIOS Features

Select the Advanced tab from the AIMB-203 setup screen to enter the Advanced BIOS Setup screen. You can select any of the items in the left frame of the screen, such as CPU Configuration, to go to the sub menu for that item. You can display an Advanced BIOS Setup option by highlighting it using the <Arrow> keys. All Advanced BIOS Setup options are described in this section. The Advanced BIOS Setup screen is shown below. The sub menus are described on the following pages.

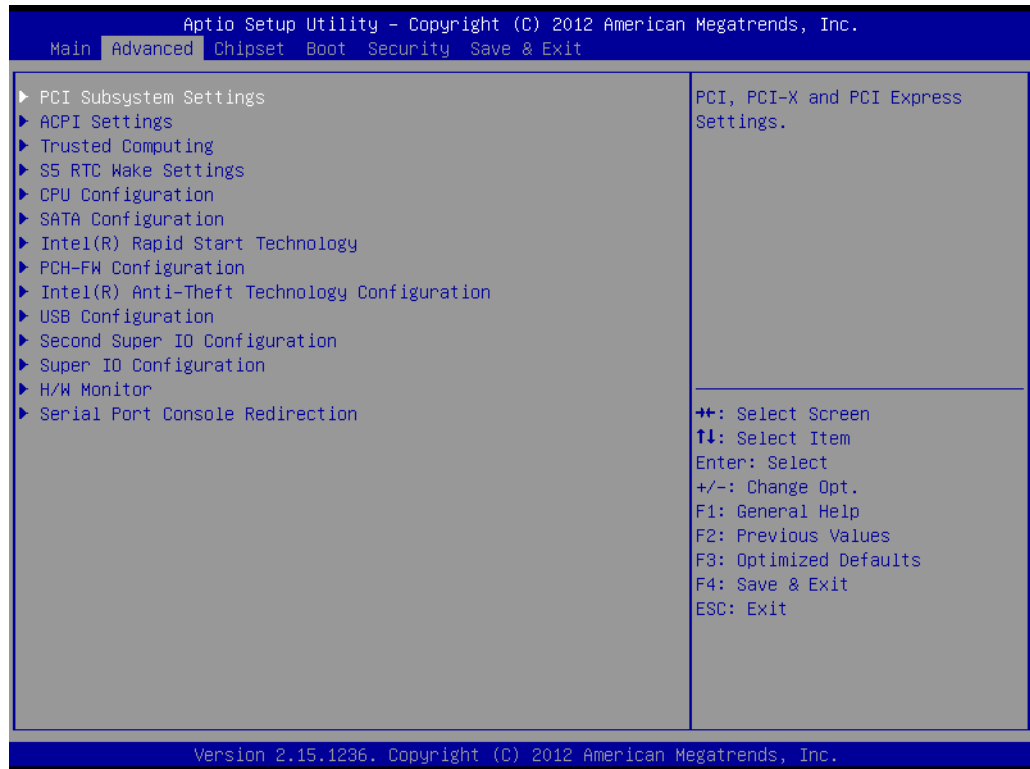

### 3.2.2.1 PCI Subsystem Settings

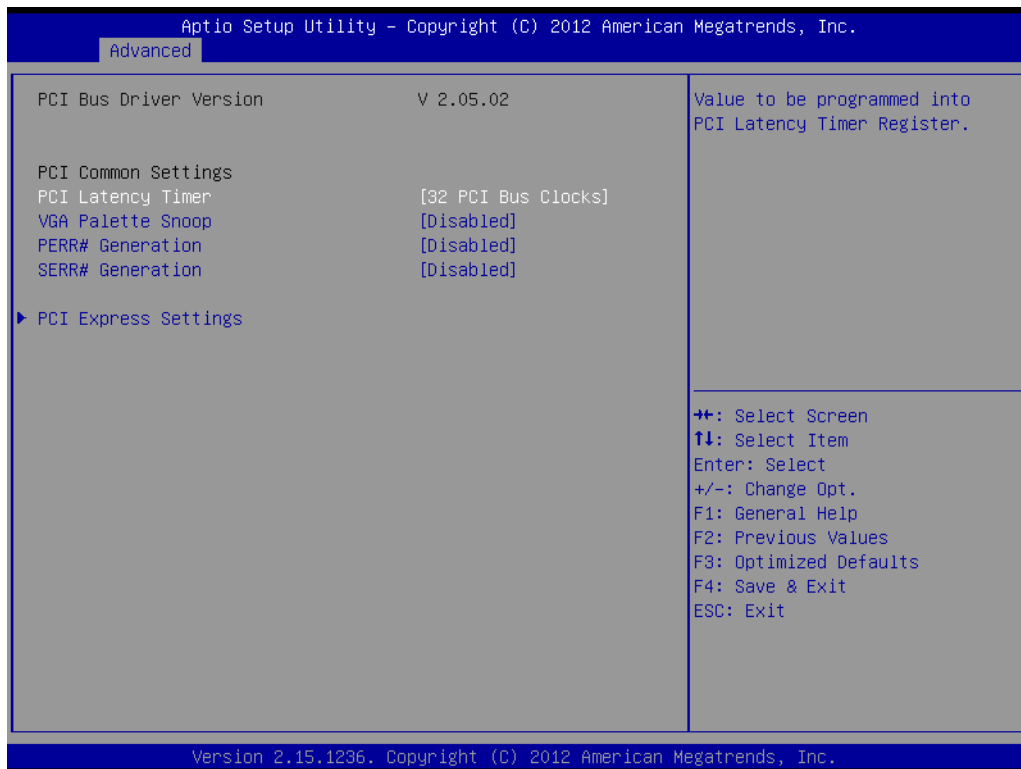

#### PCI Common Settings

- **PCI Latency Timer**  
Value to be programmed into PCI Latency Timer Register.
- **VGA Palette Snoop**  
Enable or Disable VGA palette registers snooping.
- **PERR# Generation**  
Enable or Disable PERR# Generation.
- **SERR#Generation**  
Enable or Disable SERR# Generation.

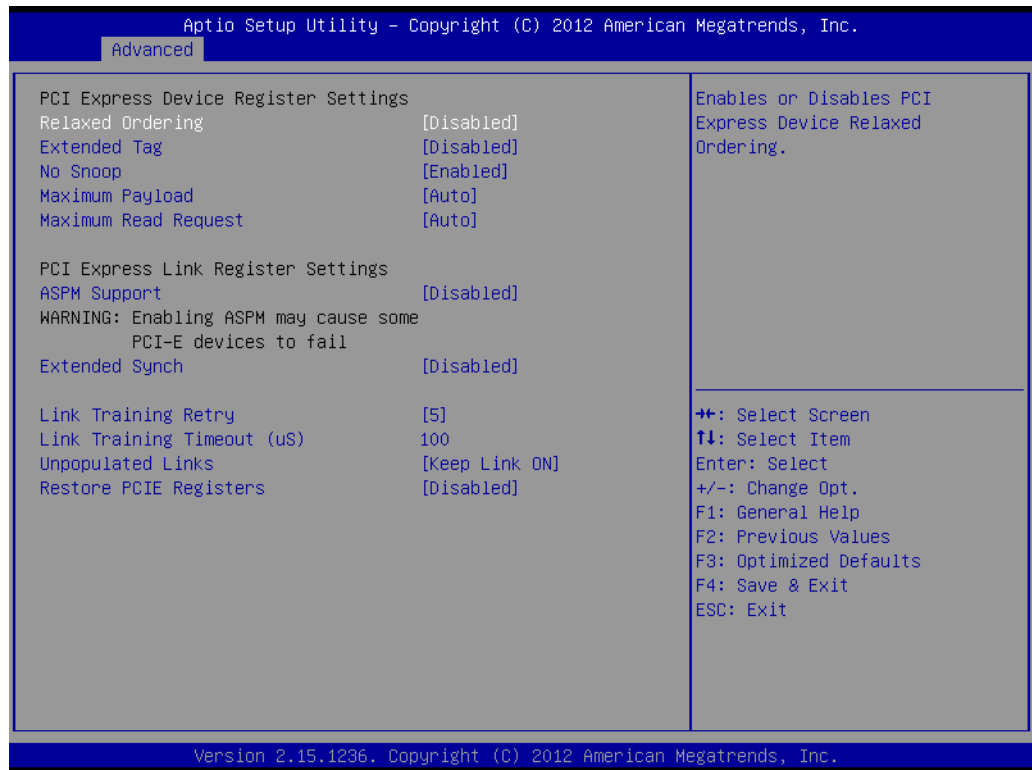

### PCI Express Device Register Settings

- **Relaxed Ordering**  
Enable or disable Relaxed Ordering.
- **Extended Tag**  
Enable or disable Extended Tag.
- **No Snoop**  
Enable or disable No Snoop.
- **Maximum Payload**  
Set Maximum Payload of PCI Express Device or allow System BIOS to select the value.
- **Maximum Read Request**  
Set Maximum Read Request Size of PCI Express Device or allow System BIOS to select the value.

### PCI Express Link Register Settings

- **ASPM Support**  
Enable or disable ASPM Support
- **Extended Synch**  
Enable or disable Extended Synch
- **Link Training Retry**  
Defines number of retry attempts software will take to retrain the link if previous training attempt was unsuccessful.
- **Link Training Timeout**  
Defines number of micro-seconds software that will wait before polling "Link Training" bit in link status register. Values range from 10 to 1000 uS.
- **Unpopulated Links**  
In order to save power, software will disable unpopulated PCI Express links, if this option set to 'Disable Link'.

- Restore PCIE Registers**  
 On non-PCI Express aware OS's (Pre Windows Vista) some devices may not be correctly re initialized after S3. Enabling this register PCI Express device configurations on S3 resume. Warning: Enabling this may cause issues with other hardware after S3 resume.

### 3.2.2.2 ACPI Settings

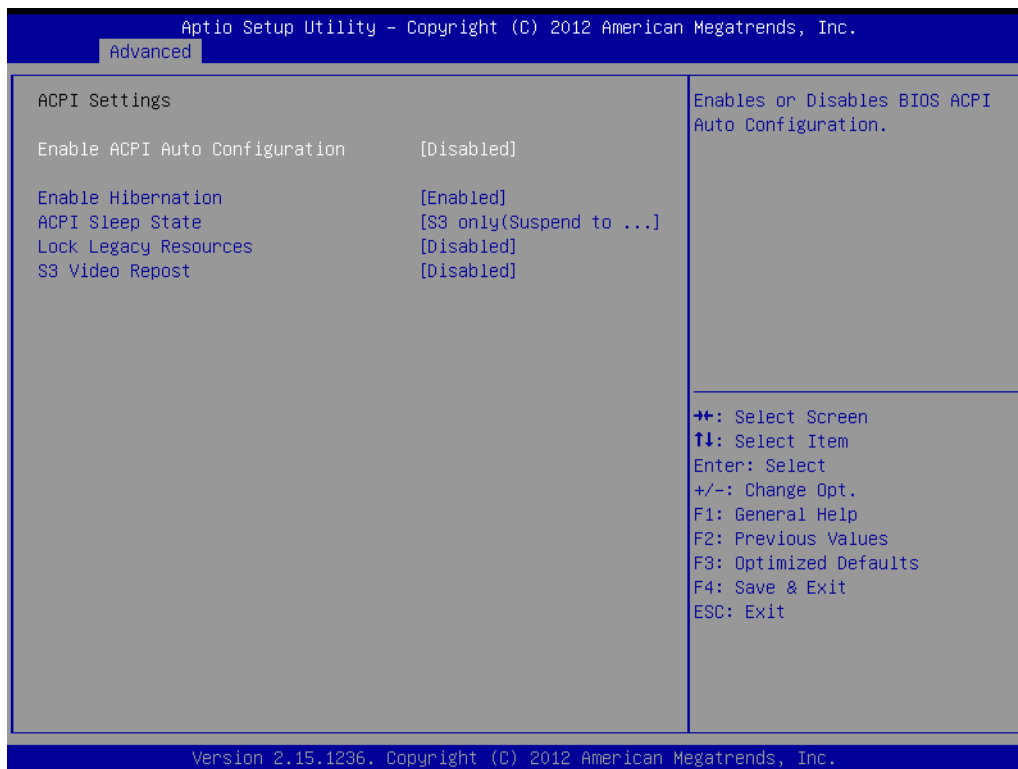

- Enable ACPI Auto Configuration**  
 Enable or disable BIOS ACPI Auto Configuration
- Enable Hibernation**  
 This item allows users to enable or disable hibernation
- ACPI Sleep state**  
 This item allows users to set the ACPI sleep state
- Lock Legacy Resources**  
 This item allows users to lock legacy devices' resources.
- S3 Video Repost**  
 Enable or disable video repost

### 3.2.2.3 Trusted Computing

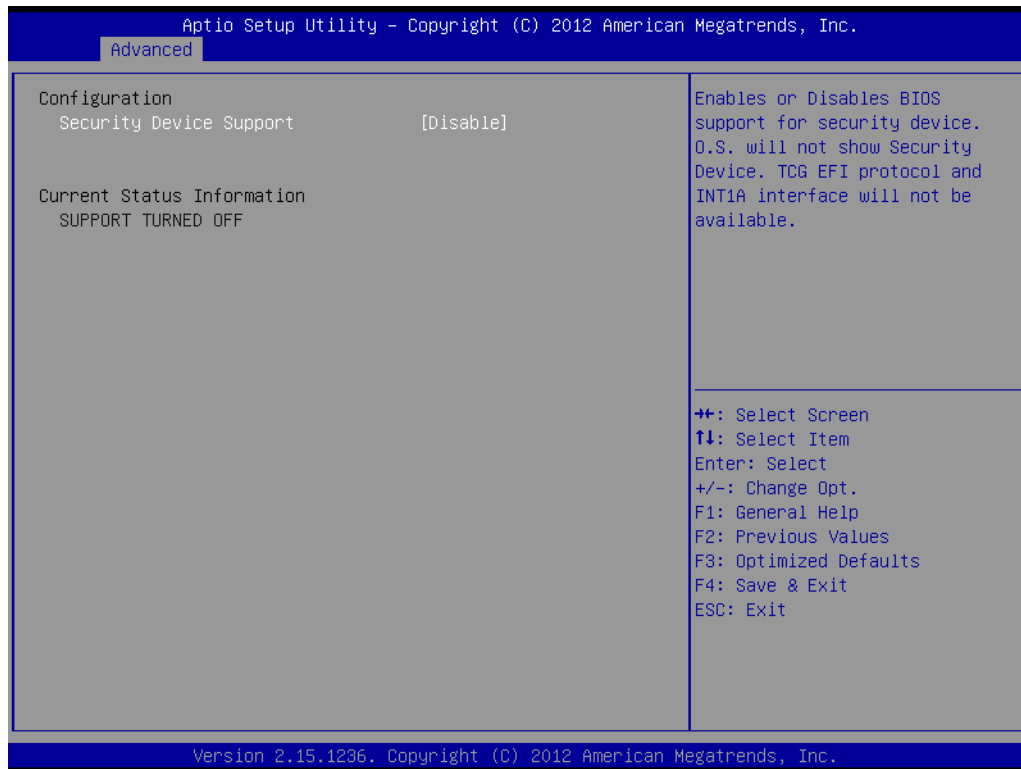

- **Security Device Support**  
Enable or disable BIOS support for security device.

### 3.2.2.4 S5 RTC wake Settings



- **Wake system with fixed time**  
Enable or disable system wake on alarm event

### 3.2.2.5 CPU Configuration

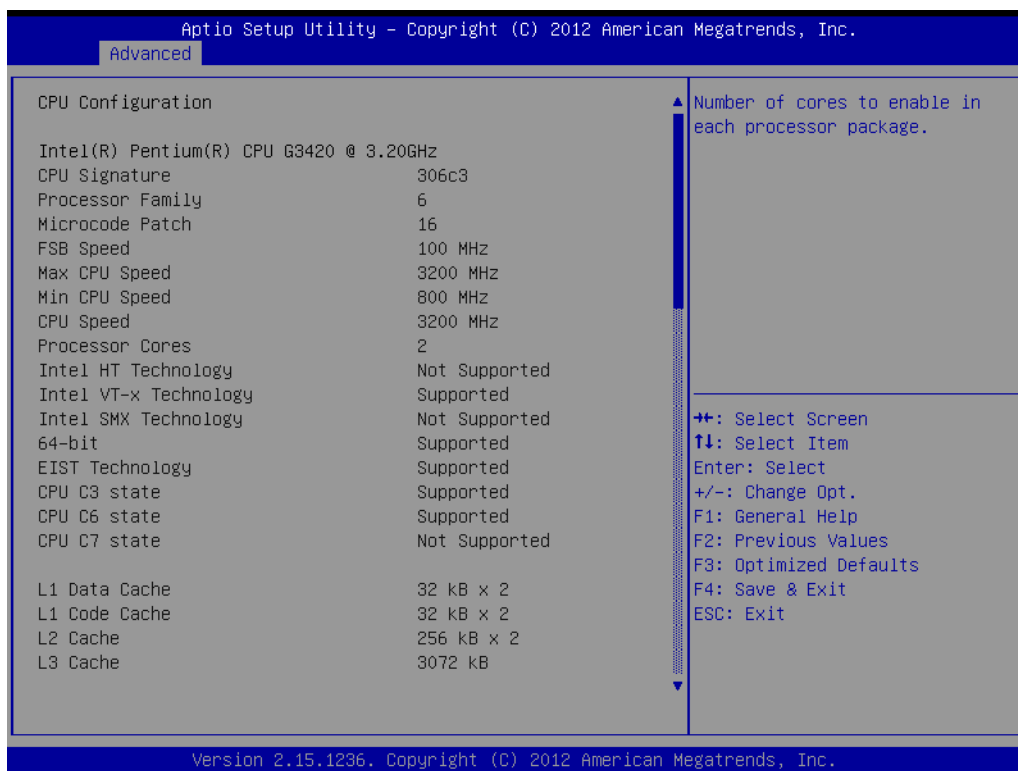

### 3.2.2.6 SATA Configuration

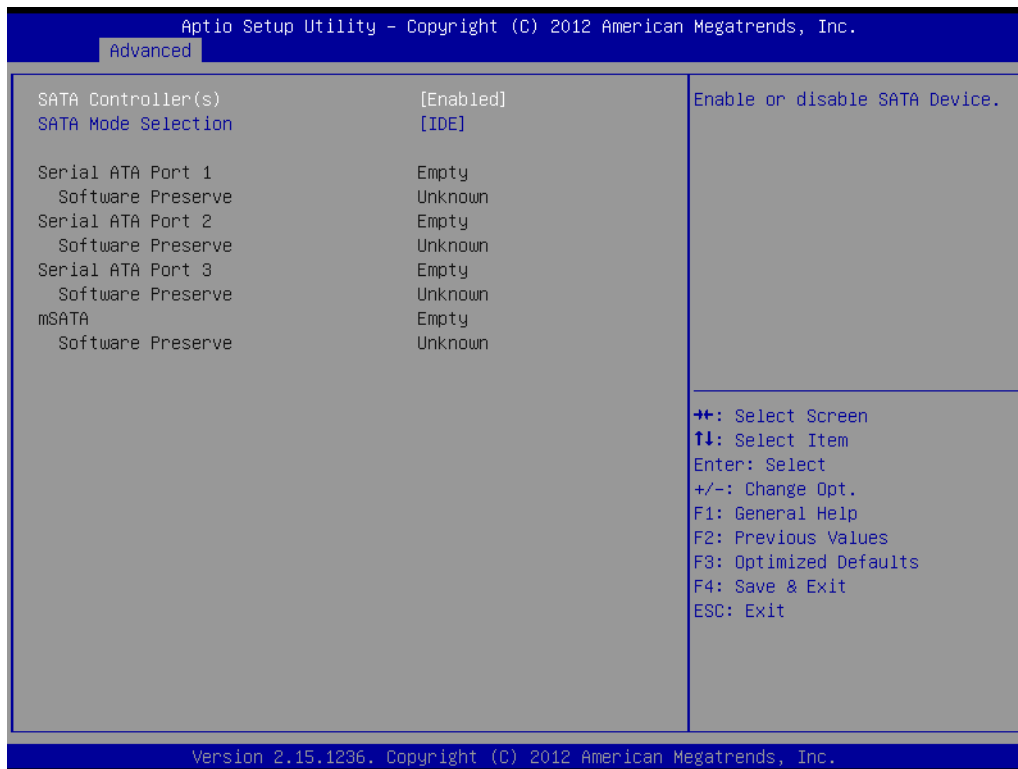

#### SATA Controller(s)

This item allows users to enable or disable the SATA device.

## SATA Mode Selection

This item allows users to select mode of SATA controller(s).

### 3.2.2.7 INTEL Rapid Start Technology

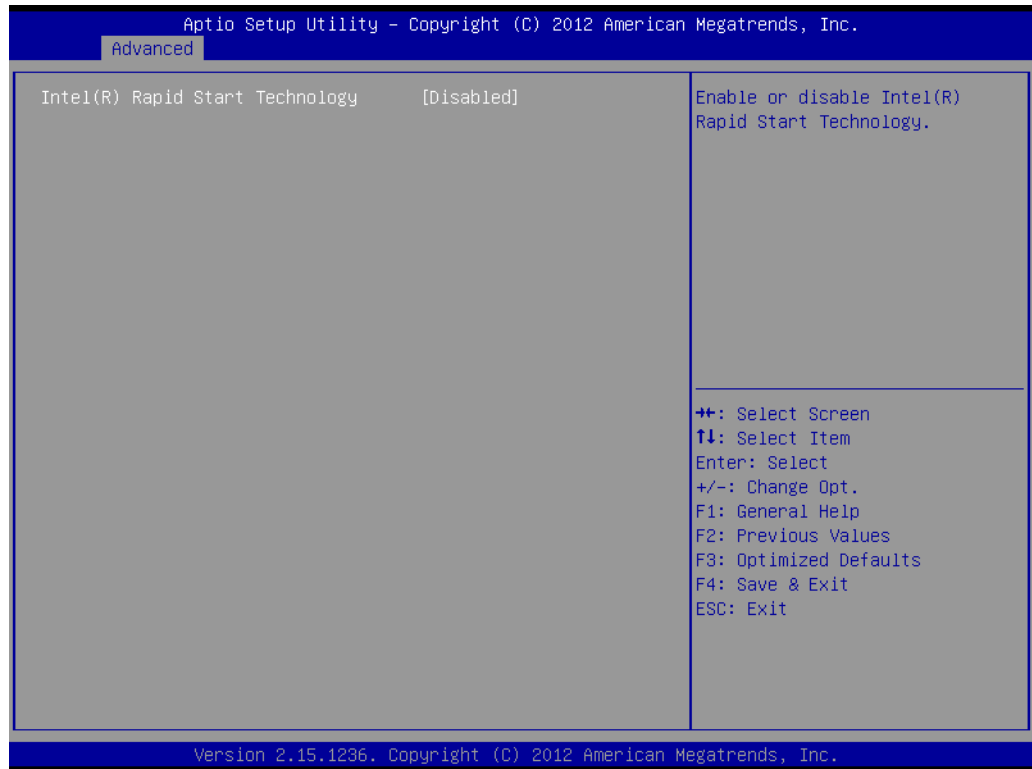

### Intel® Rapid start technology

This item allows users to enable or disable Intel rapid start technology.



### 3.2.2.8 PCH(FW) Configuration

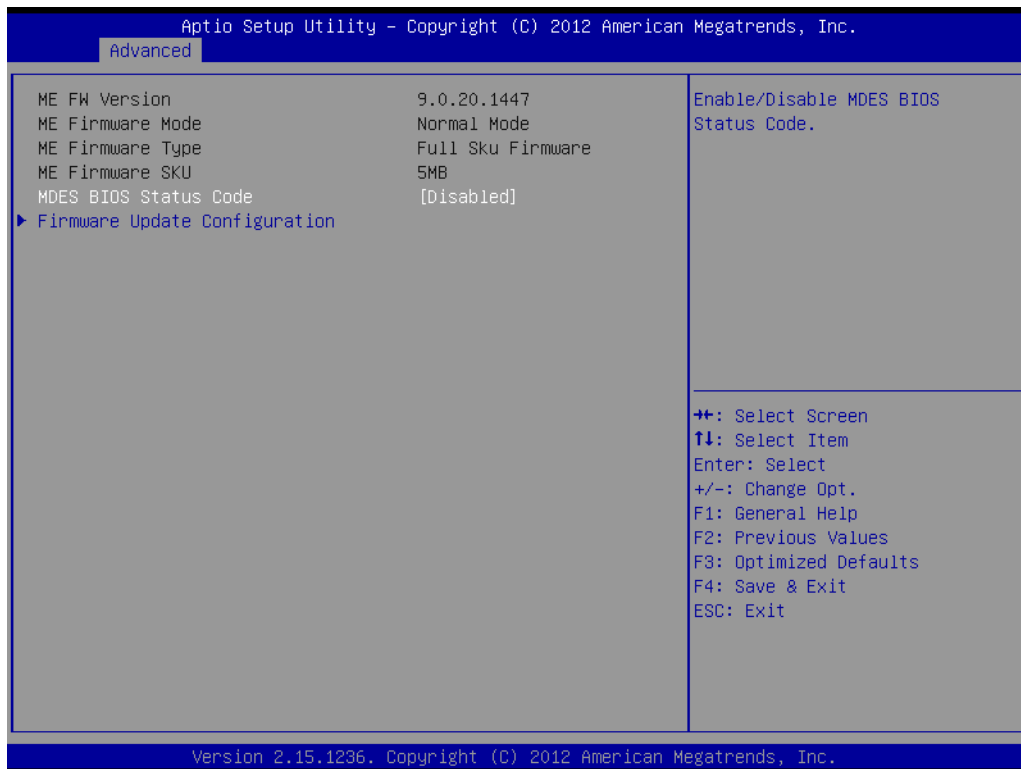

#### PCH-FW Version

PCH-FW page shows Intel ME FW information.

- **MDES BIOS Status Code**  
 Enable or disable MDES BIOS Status Code.

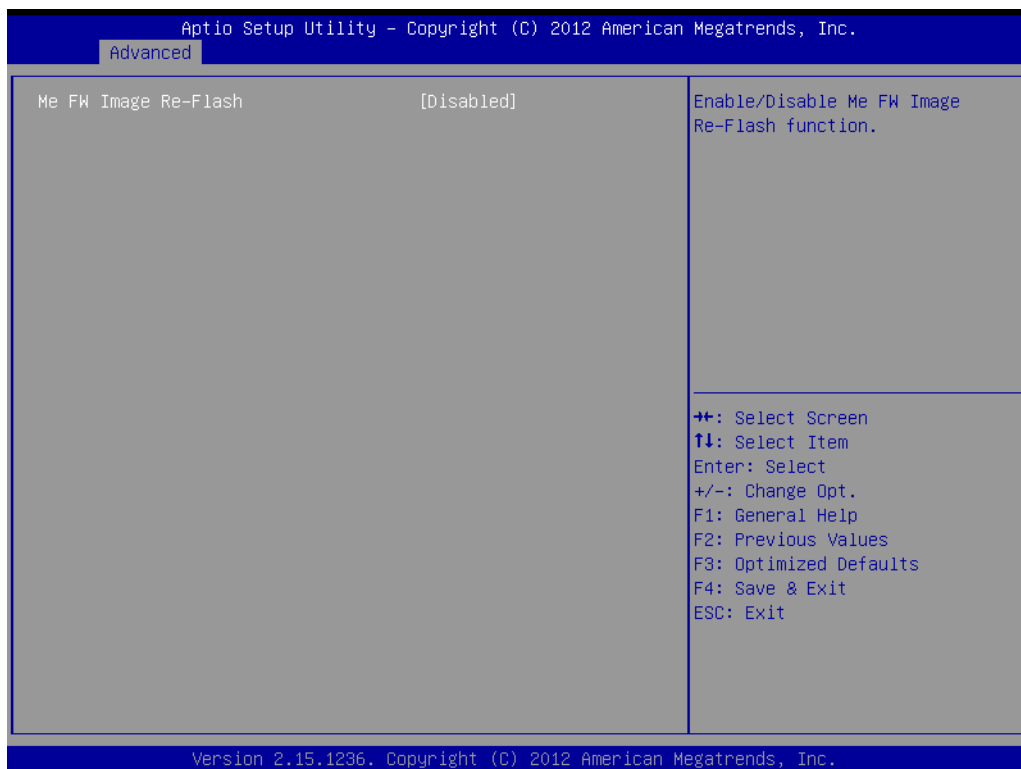

- **Me FW Image Re-Flash**  
 This item allows users to enable or disable Me FW image re-flash function.

### 3.2.2.9 Intel® Anti-Theft Technology Configuration

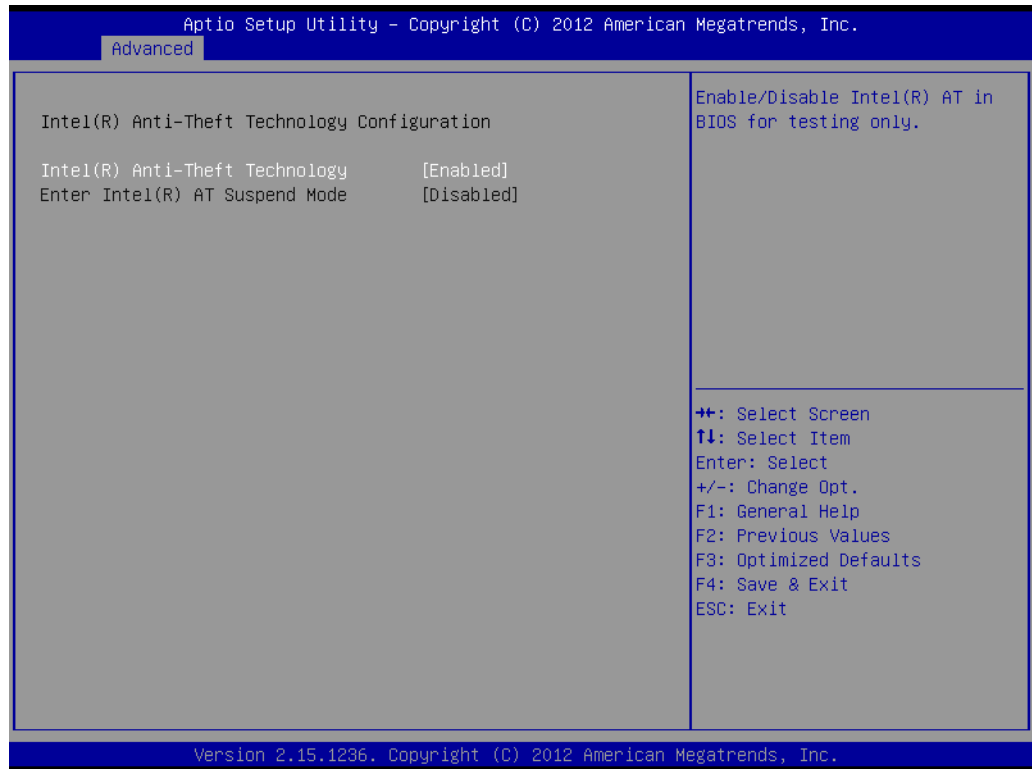

- **Intel® Anti-theft Technology**  
This item allows users to enable or disable Intel AT in BIOS for testing only.
- **Enter Intel® AT Suspend Mode**  
This item allows users to enable or disable enter Intel AT suspend mode function.

### 3.2.2.10 USB configuration

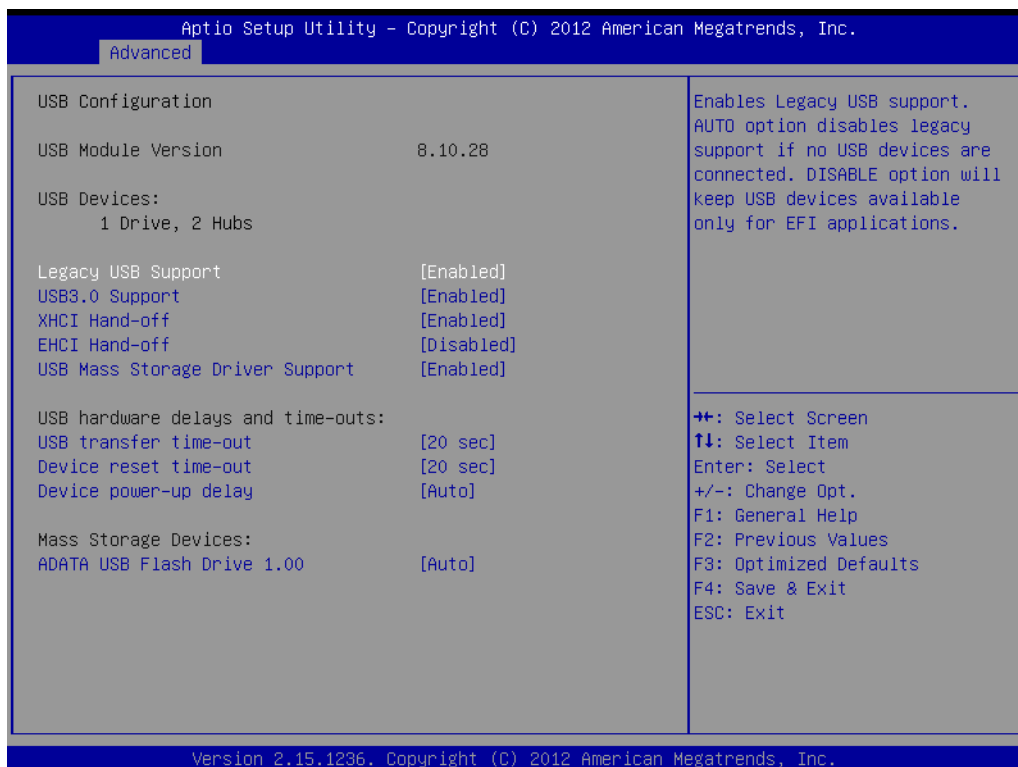

- **Legacy USB support**  
Enables support for legacy USB. Auto option disables legacy support if no USB devices are connected.
- **USB3.0 support**  
This item allows users to enable or disable USB3.0 function.
- **XHCI Hand-off**  
This is a workaround for OS without XHCI hand-off support. The XHCI ownership change should claim by XHCI driver.
- **EHCI Hand-off**  
This is a workaround for OS without EHCI hand-off support. The EHCI ownership change should claim by EHCI driver.
- **USB Mass Storage Driver Support**  
This item allows users to enable or disable USB Mass Storage Driver.
- **USB transfer time-out**  
Time-out value for control, bulk, and interrupt transfers.
- **Device reset time-out**  
USB mass storage device starts unit command time-out.
- **Device power-up delay**  
Maximum time the device will take before it properly reports itself to the host controller.
- **Mass storage device**  
Mass storage device emulation type. 'AUTO' enumerates devices according to their media format. Optical drives are emulated as 'CDROM'.

### 3.2.2.11 Super IO Configuration

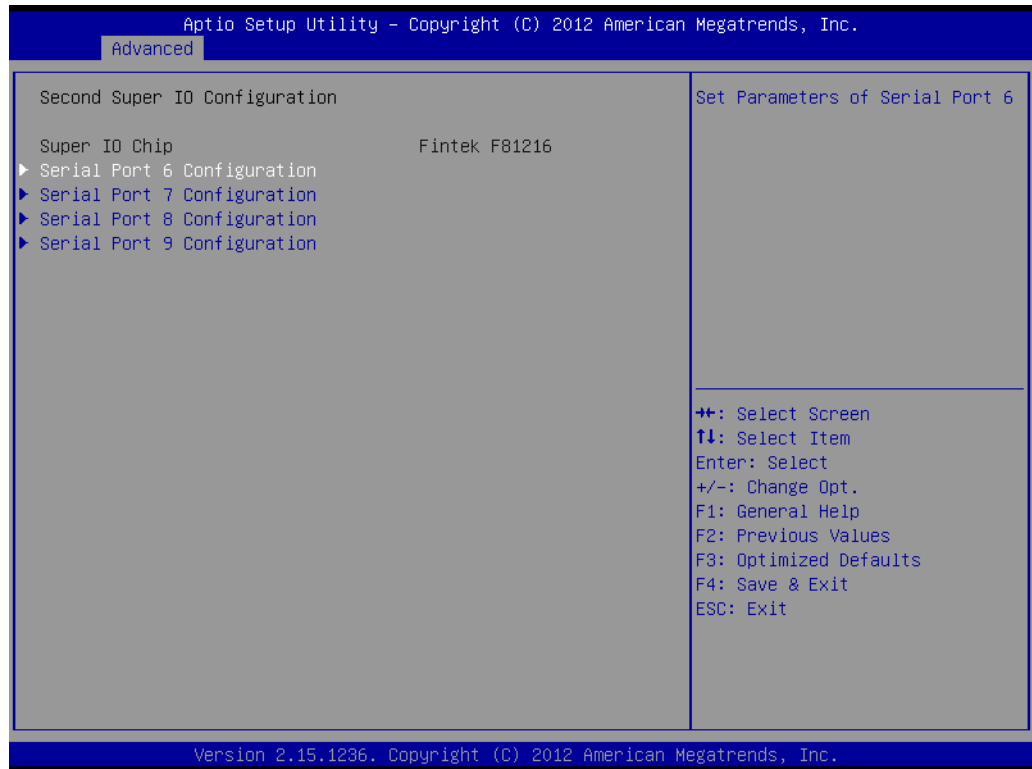

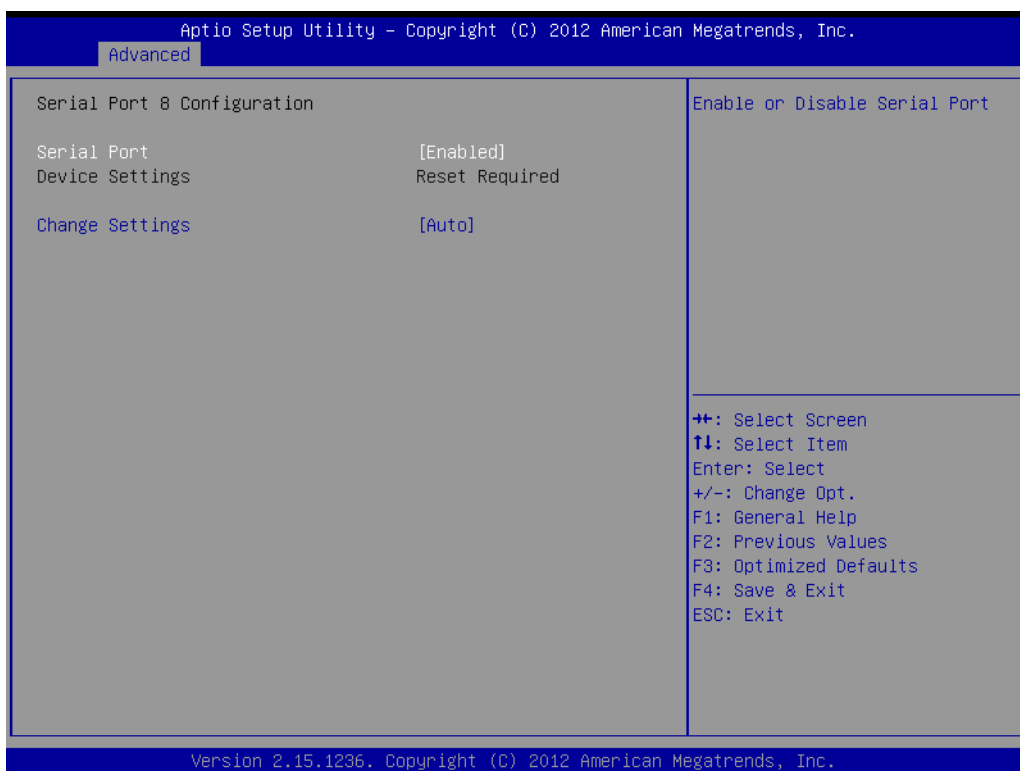
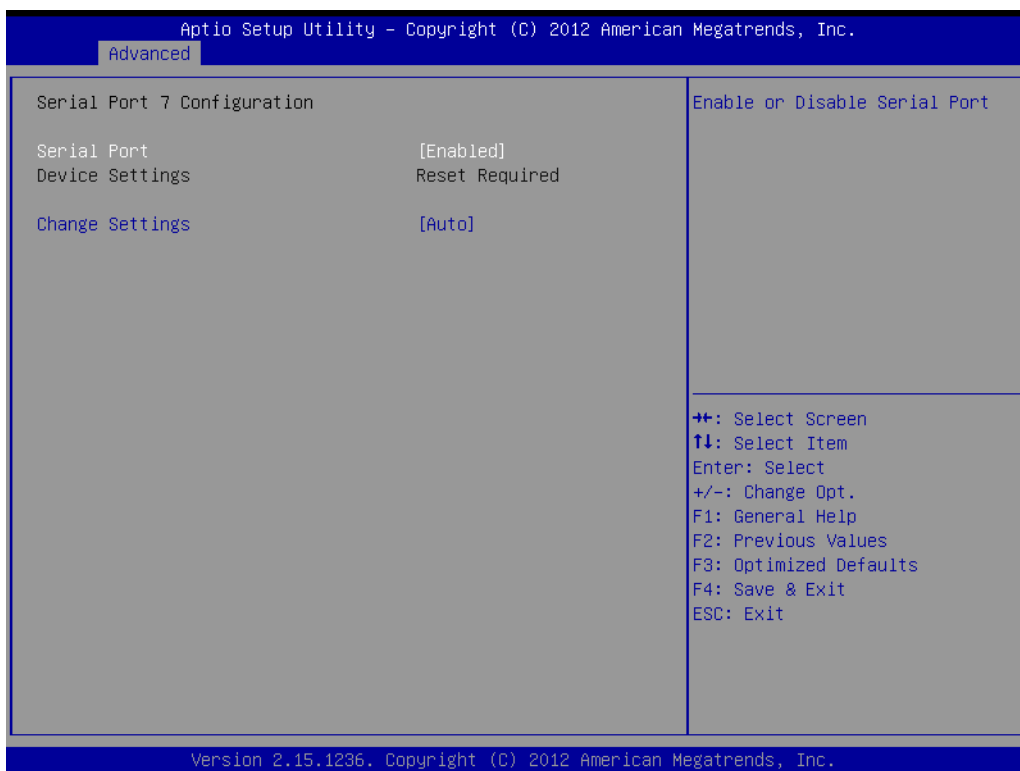

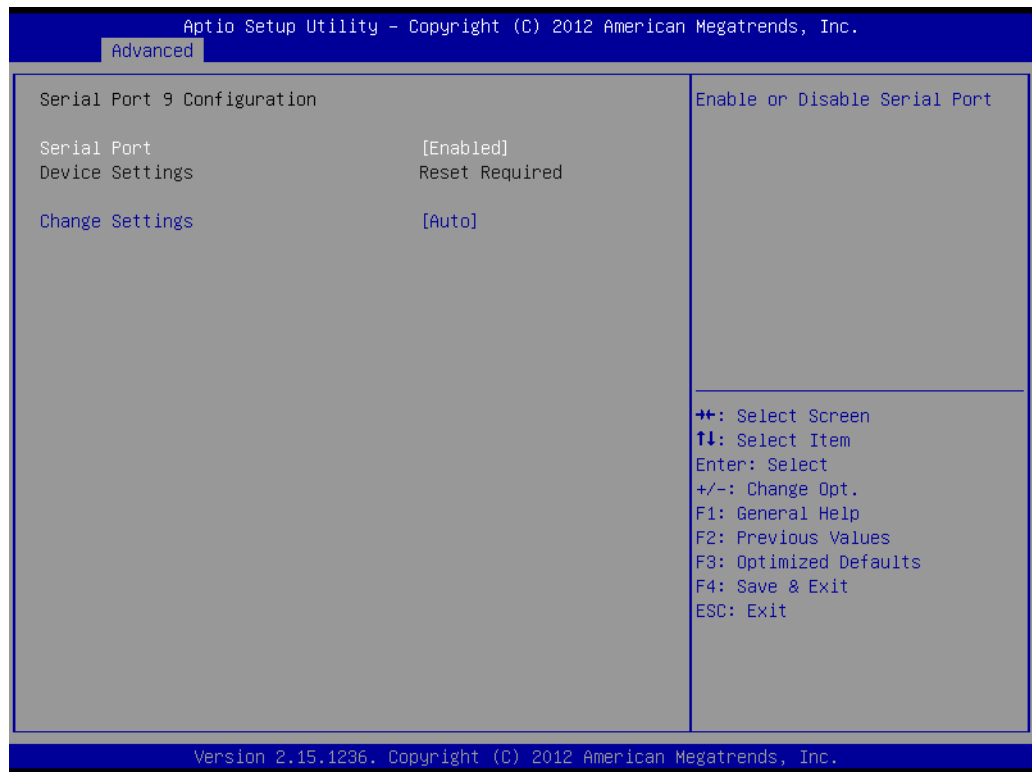
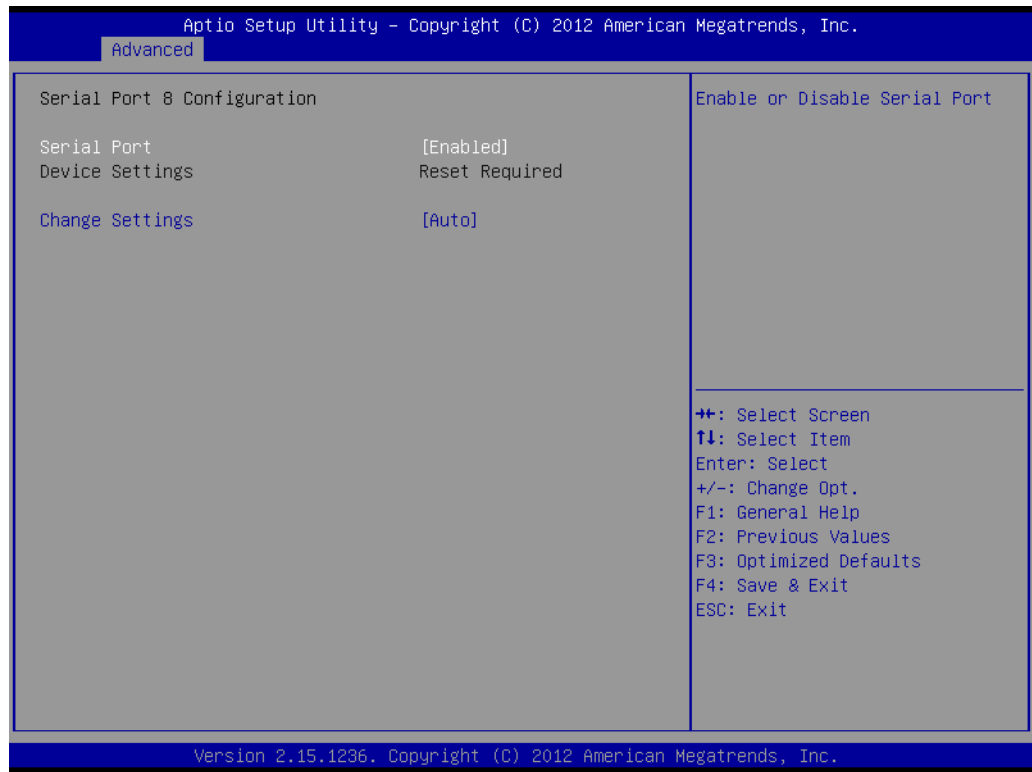

- **Serial Port 6/7/8/9**  
This item will allow users to enable or disable serial port 6/7/8/9.
- **Change Settings**  
This item allows users to change the serial port 6/7/8/9 setting.

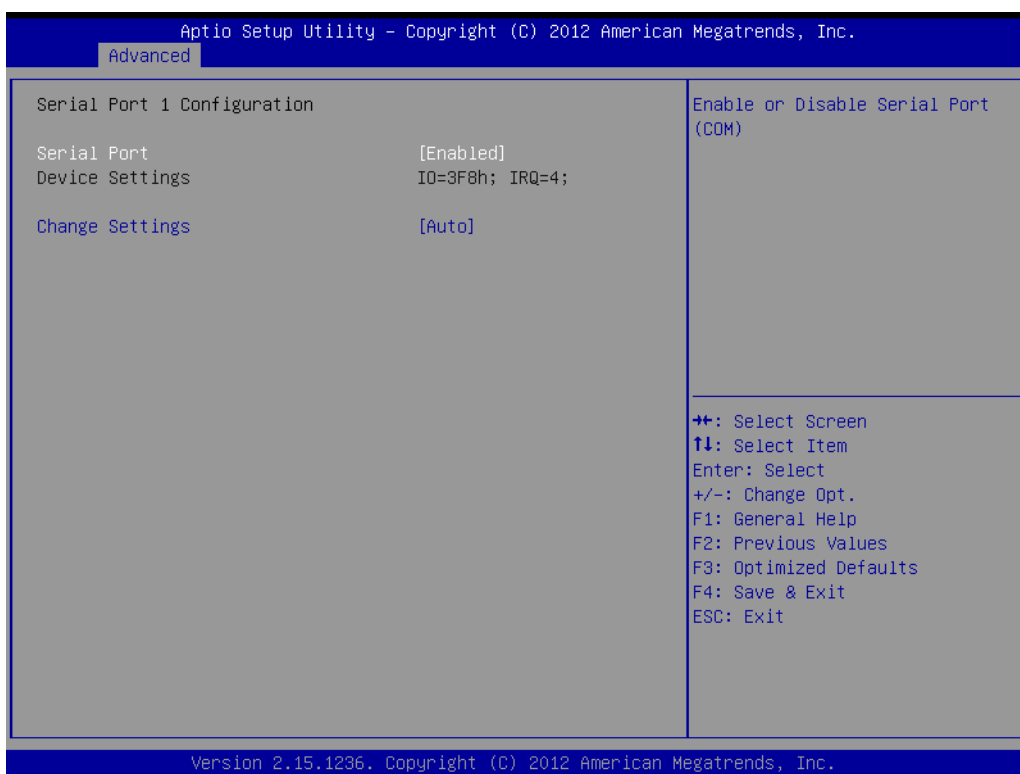
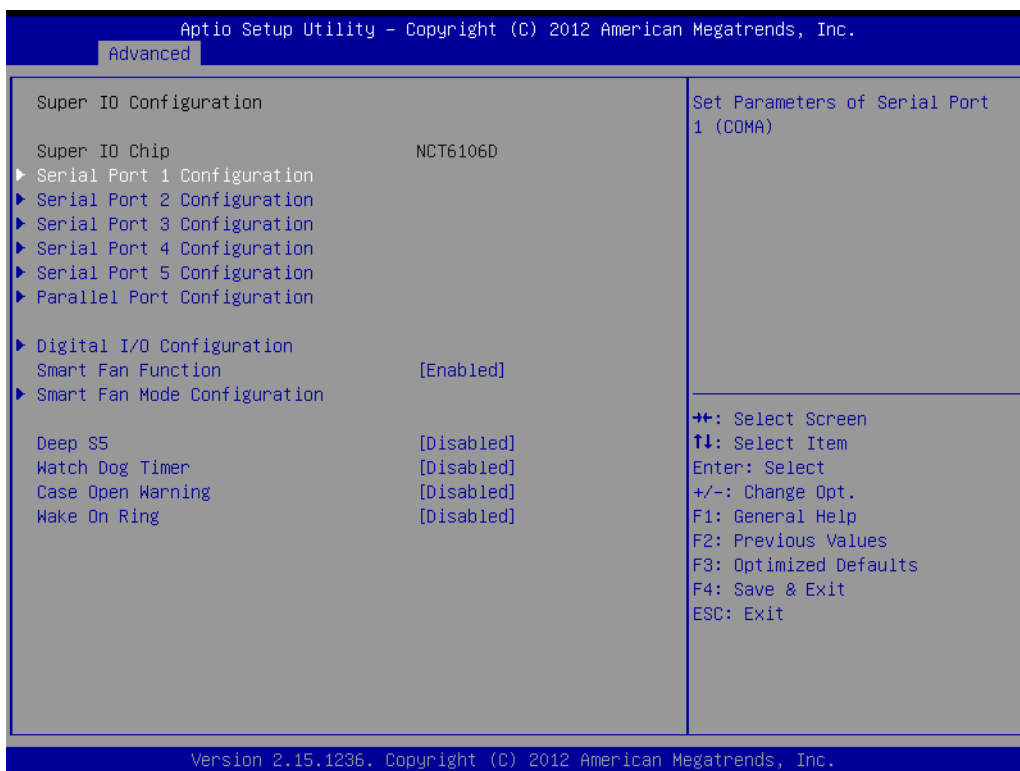

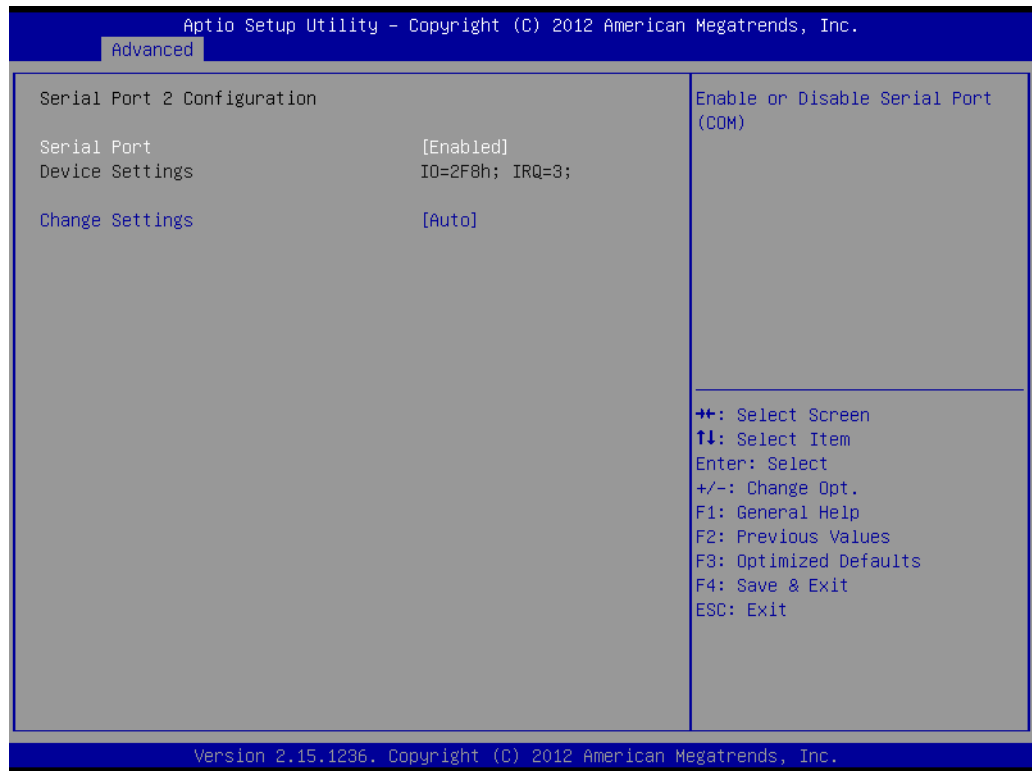



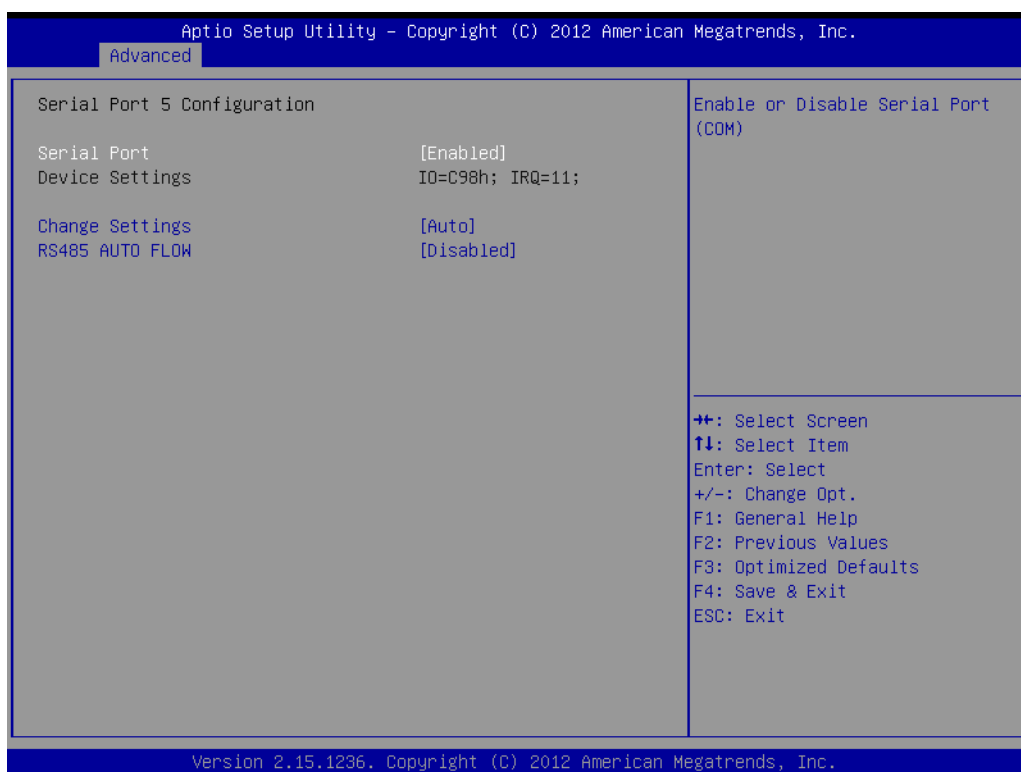
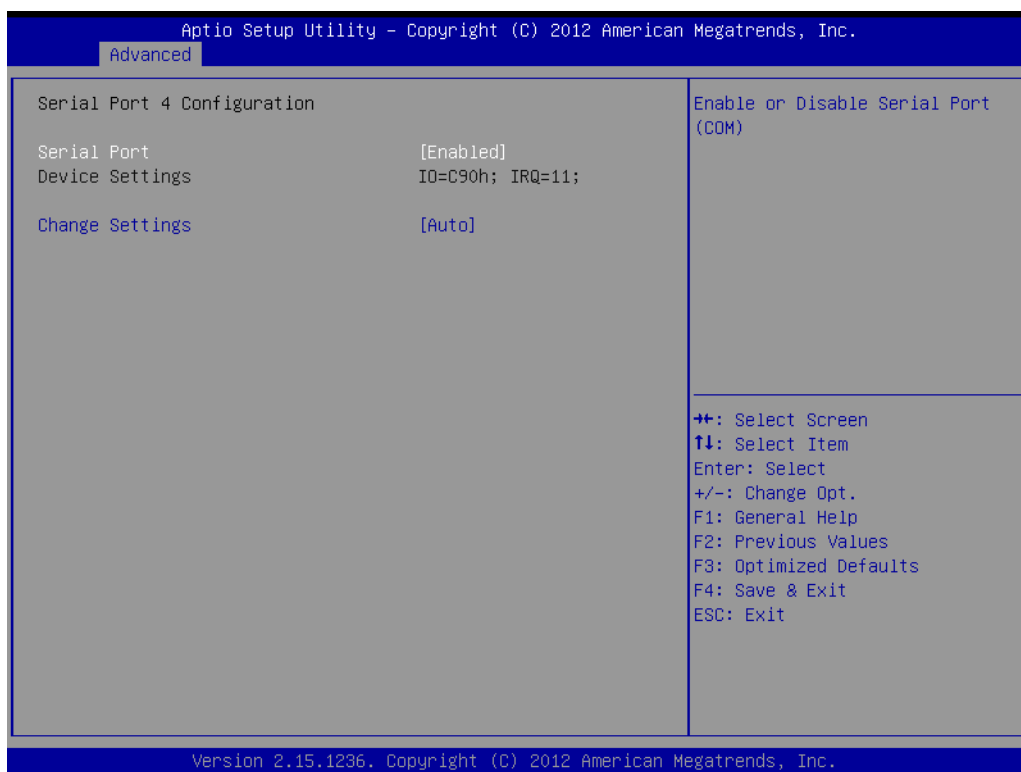

- **Serial Port 1/2/3/4/5**  
This item will allow users to enable or disable serial port 1/2/3/4/5.
- **Change Settings**  
This item allows users to change the serial port 1/2/3/4/5 setting.

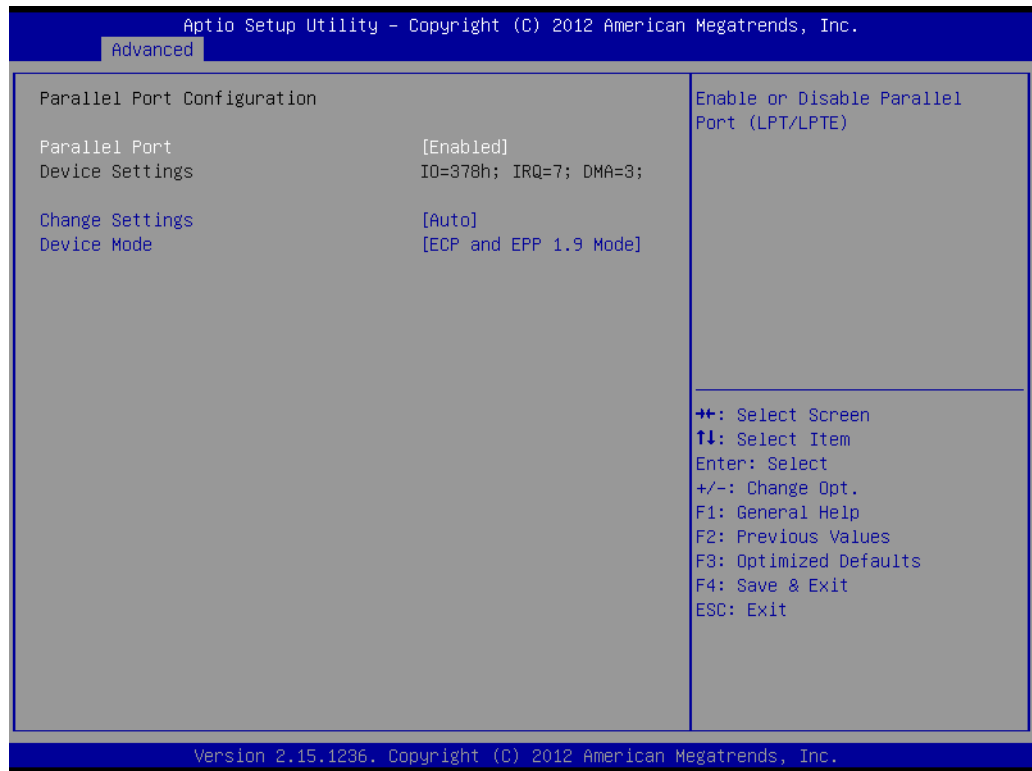

- **Parallel Port**  
This item will allow users to enable or disable parallel port.
- **Change Settings**  
This item allows users to change the parallel port setting.
- **Device Mode**  
This item allows users to change the device mode.

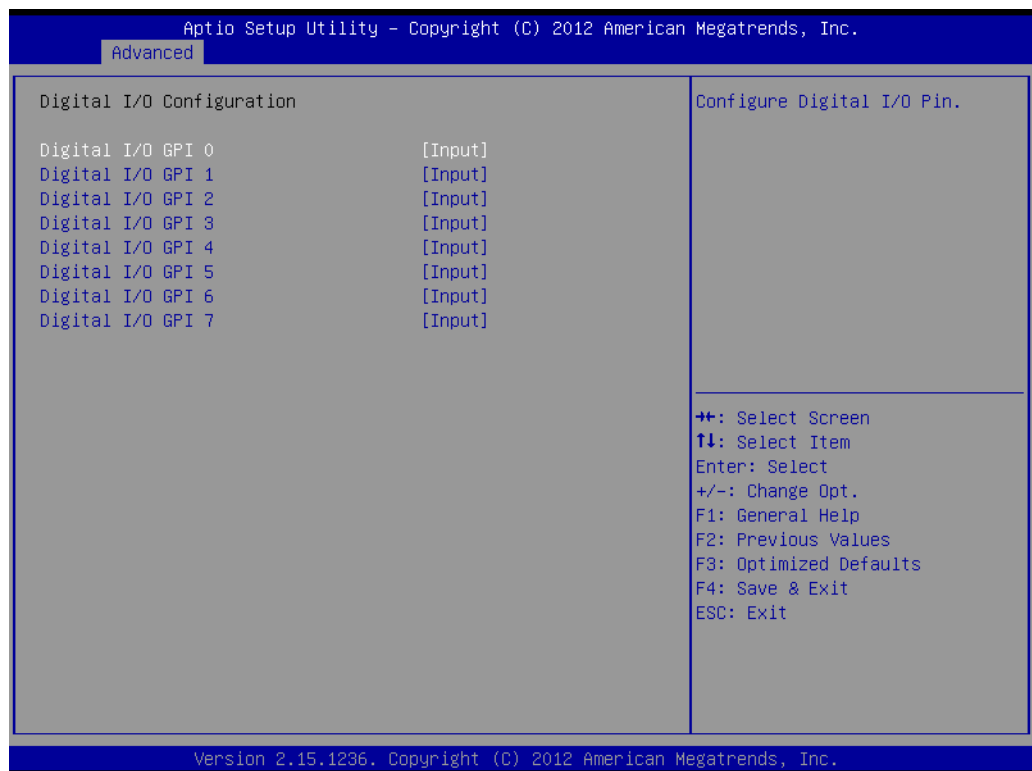

- **Digital I/O GPI 0/1/2/3/4/5/6/7**  
This item will allow users to set up Digital I/O 0~7 to "input" or "output".

### 3.2.2.12 Smart Fan Mode Configuration

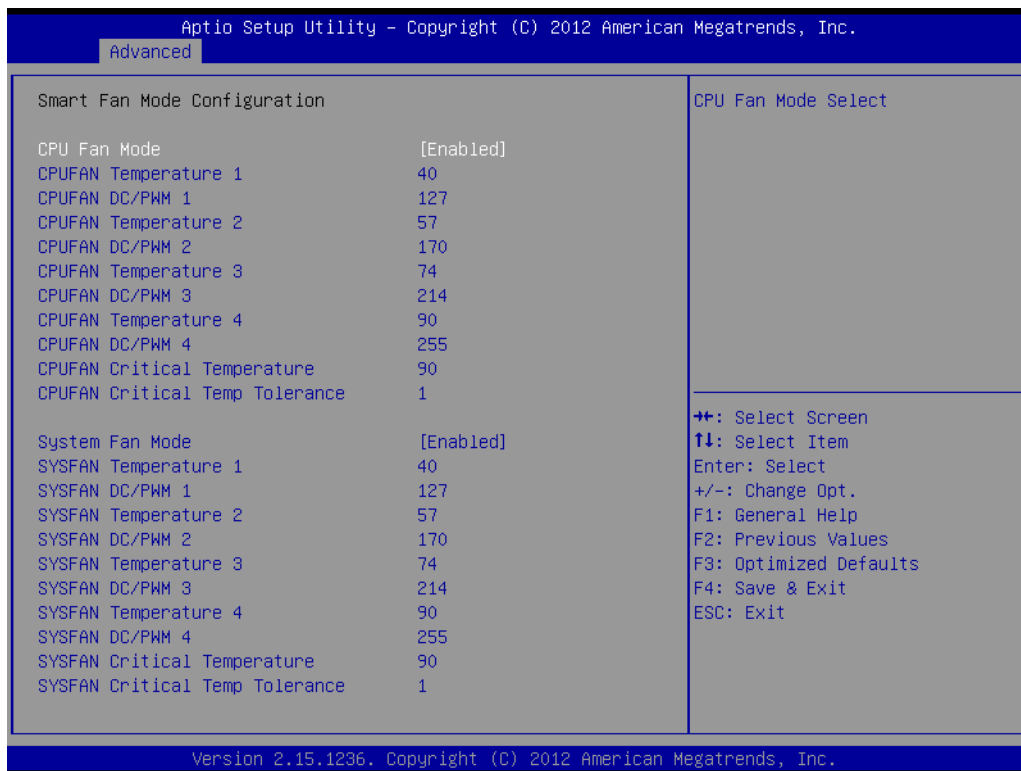

- **CPU Fan Mode**  
To enable or disable CPU smart fan.
- **System Fan Mode**  
To enable or disable System Smart Fan.

### 3.2.2.13 PC Health Status

This Page Shows AIMB-203 PC Health Status.

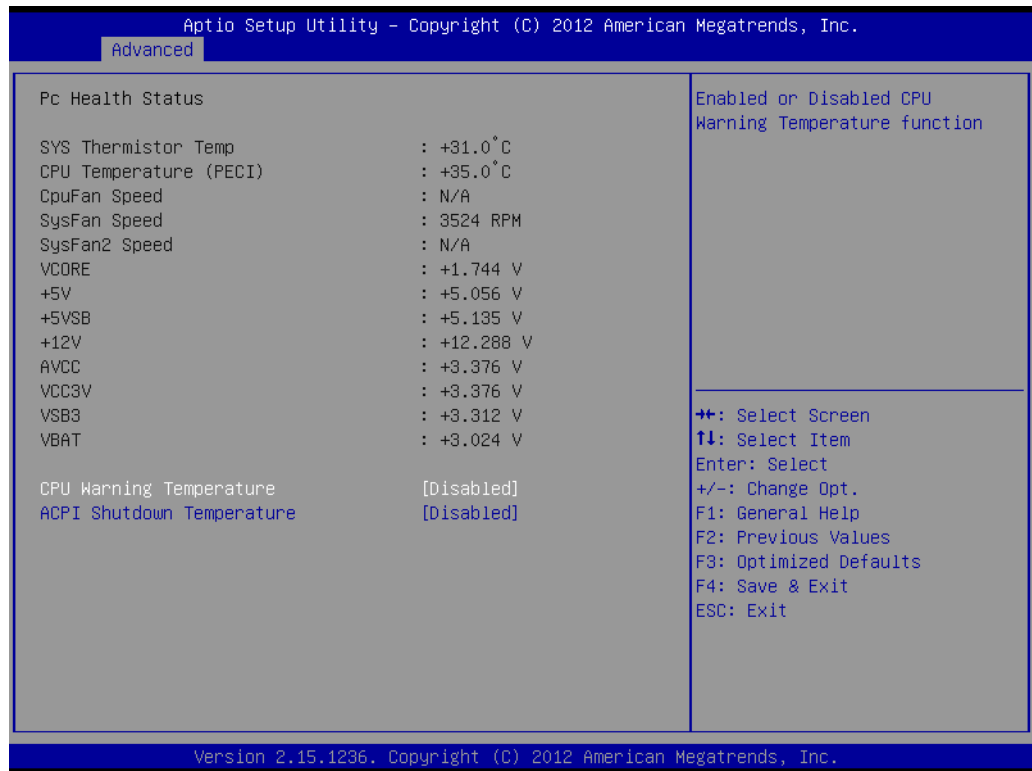

- **CPU Warning Temperature**  
Use this to set the CPU warning temperature threshold. When the system CPU reaches the warning temperature, the buzzer will beep.
- **ACPI Shutdown Temperature**  
This screen allows users to set the CPU temperature at which the system will automatically shut down to prevent the CPU from overheating damage.

### 3.2.2.14 Serial Port Console Redirection

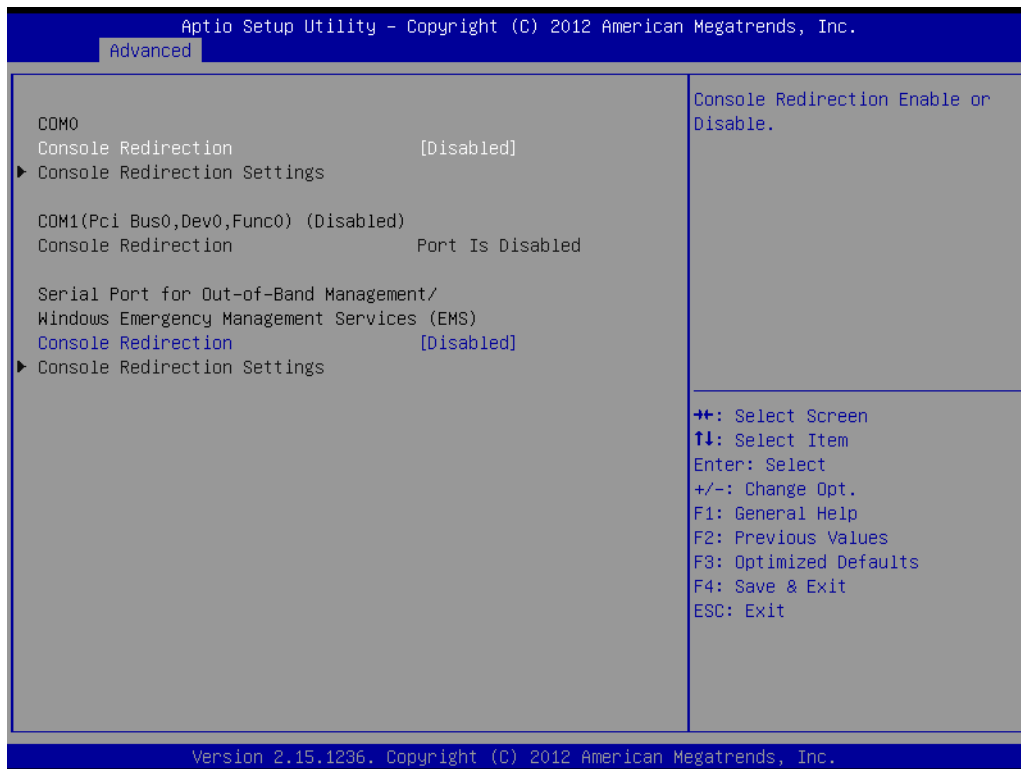

- **Console Redirection**

This item allows users to enable or disable console redirection.

### 3.2.3 Chipset

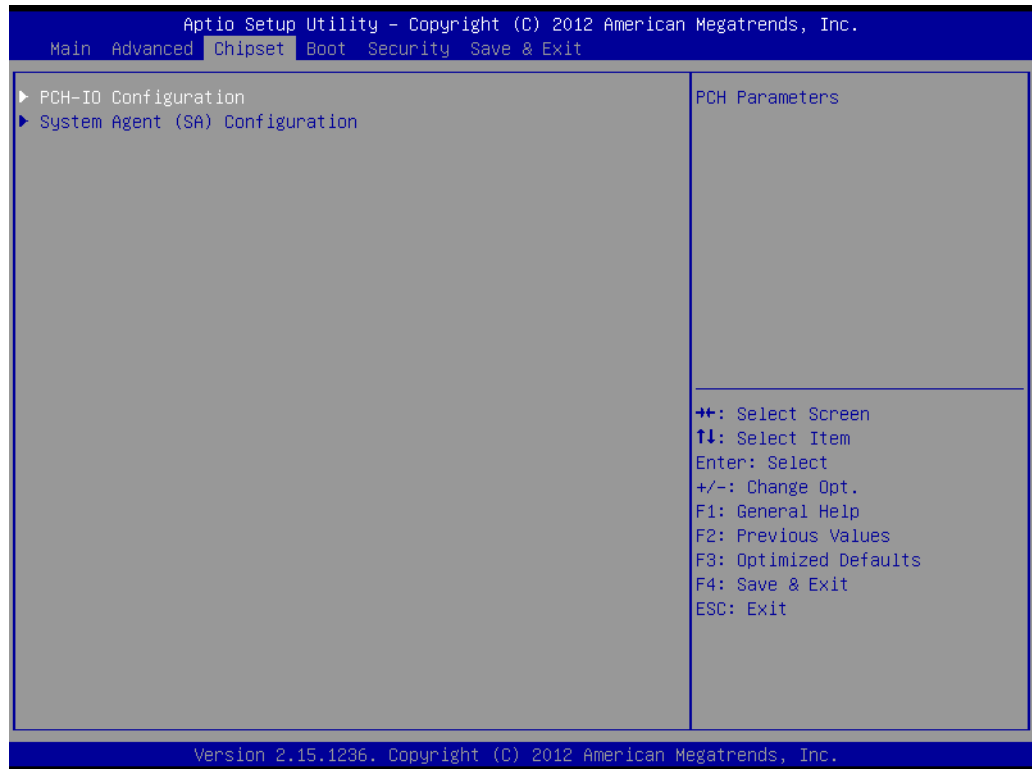

This page provides information of the chipset on AIMB-203.

#### PCH-IO Configuration

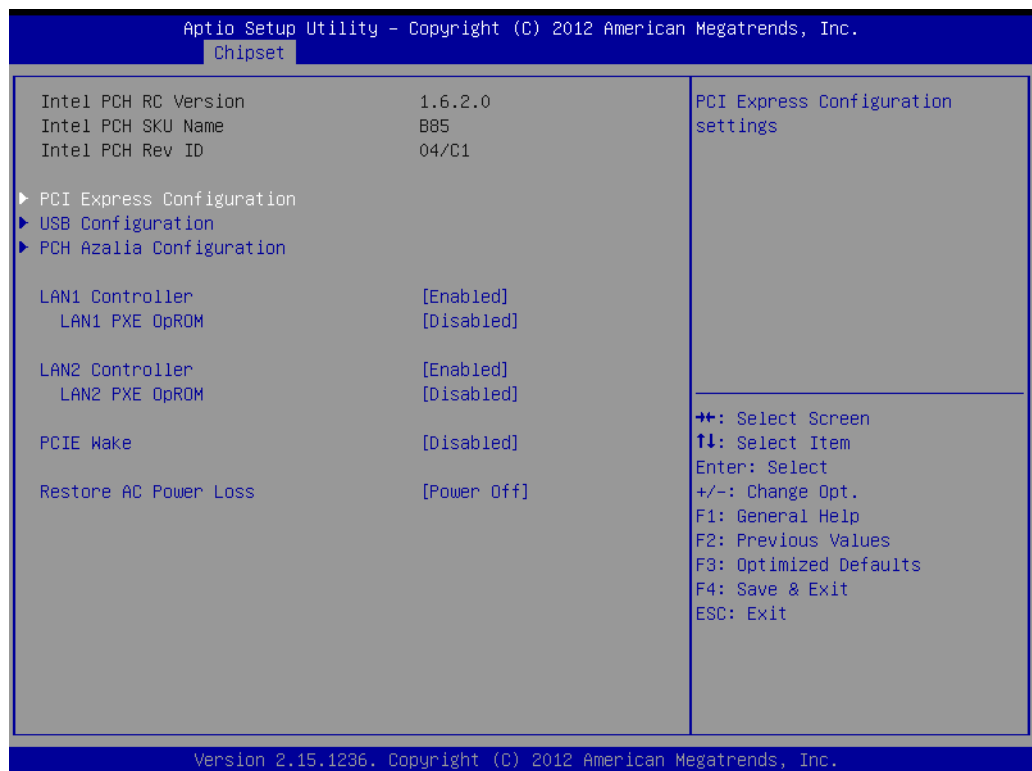

**PCI Express Configuration**  
Details of PCI Express items.

**USB Configuration**

Details of USB items.

**PCH Azalia Configuration**

Details of PCH azalia items.

**LAN 1 controller**

Enable or disable the LAN 1 controller.

- **LAN 1 PXE OpROM**

Enable or disable the LAN 1 option-ROM.

**LAN 2 controller**

Enable or disable the LAN 2 controller.

- **LAN 2 PXE OpROM**

Enable or disable the LAN 2 option-ROM.

**PCIe Wake**

Enable or disable PCIe to wake the system from S5.

**Restore AC Power Loss**

This item allows users to select off, on and last state.

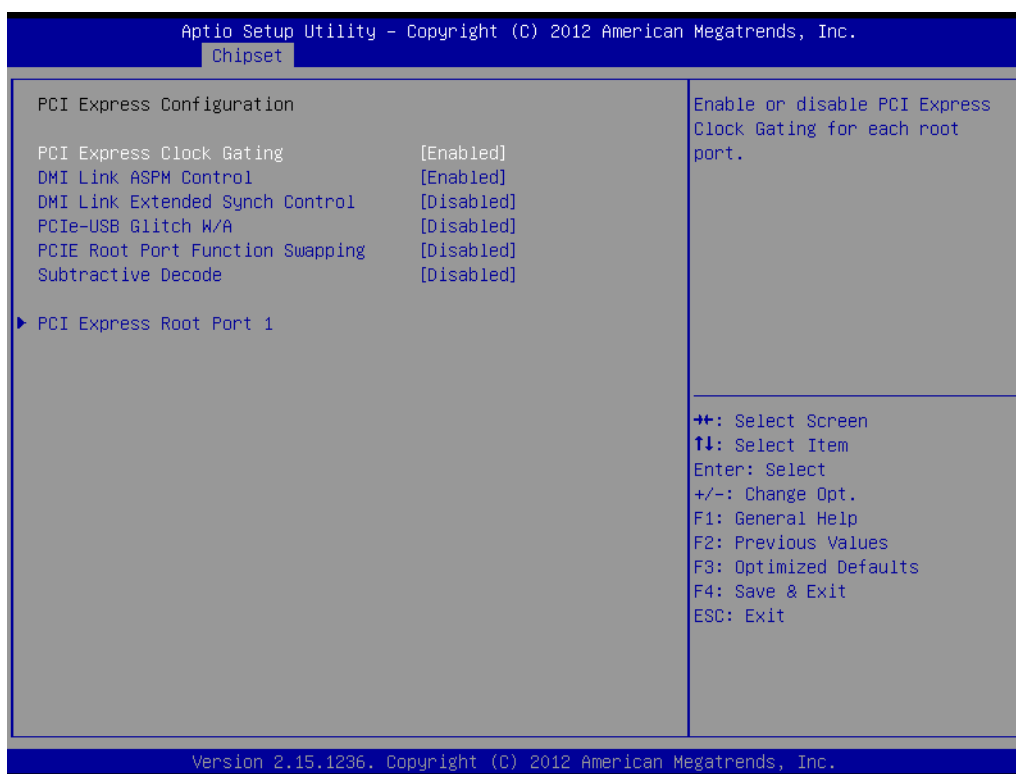
**3.2.3.1 PCI Express Configuration**

- **PCI Express Clock Gating**  
This item allows users to enable or disable the PCI Express Clock Gating.
- **DMI Link ASPM Support**  
This item allows users to enable or disable ASPM.
- **DMI Link Extended Synch Control**  
This item allows users to enable or disable DMI Link Extended Synch.
- **PCIe-USB Glitch W/A**  
This item allows users to enable or disable PCIe-USB Glitch W/A.

- **PCI Express Root Port Function Swapping**  
This item allows users to enable or disable PCI Express Root Port Function Swapping.
- **Subtractive Decode**  
This item allows users to enable or disable Subtractive Decode.

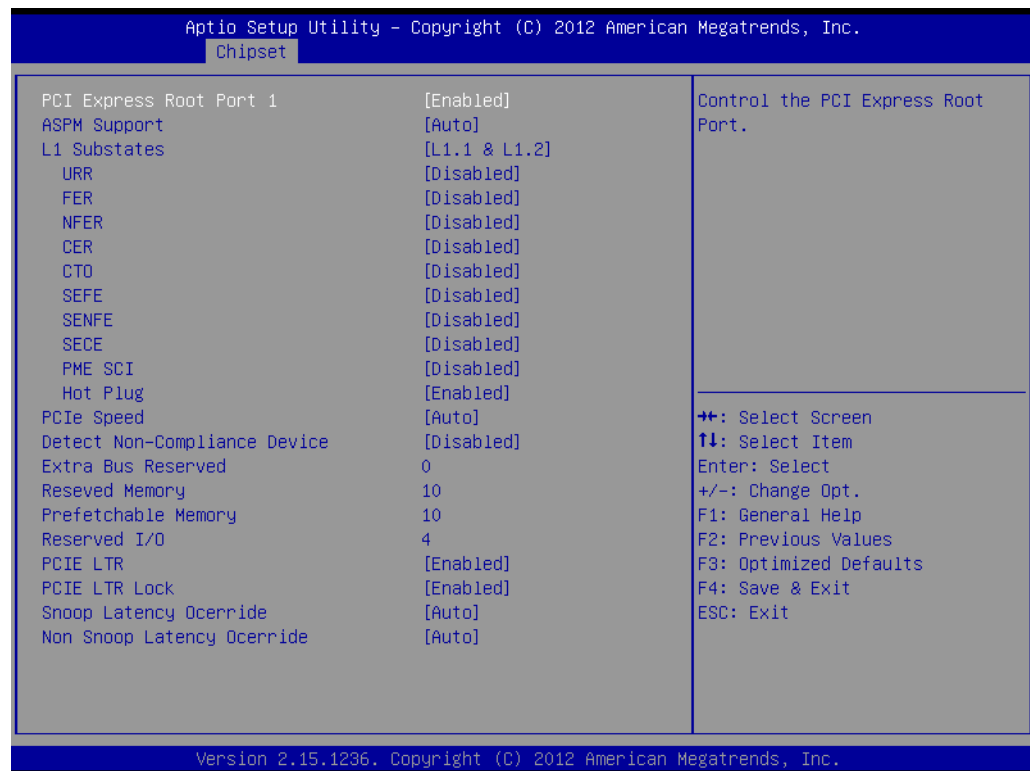

- **PCI Express Root Port 1 & 3**  
Control the PCI Express Root Port
- **ASPM Support**  
This item allows users to enable or disable PEG ASPM.
- **L1 Substates**  
This item allows users to select L1.1 or L1.2.
- **URR**  
This item allows users to enable or disable the URR function.
- **FER**  
This item allows users to enable or disable the FER function.
- **NFER**  
This item allows users to enable or disable the NFER function.
- **CER**  
This item allows users to enable or disable the CER function.
- **CTO**  
This item allows users to enable or disable the CTO function.
- **SEFE**  
This item allows users to enable or disable the SEFE function.
- **SENF**  
This item allows users to enable or disable the SENFE function.
- **SECE**  
This item allows users to enable or disable the SECE function.
- **PME SCI**  
This item allows users to enable or disable the PME SCI function.



- **Hot Plug**  
This item allows users to enable or disable the PCI Express hot plug function.
- **PCIe Speed**  
Select PCI Express port speed [Auto, Gen1, Gen2].
- **Detect Non-Compliance Device**  
Detect Non-Compliance PCI Express Device. If enable, it will take more time at POST time.
- **PCIE LTR**  
This item allows users to enable or disable PCIE Latency Reporting
- **PCIE LTR Lock**  
This item allows users to enable or disable PCIE LTR Lock.
- **Snoop Latency Ocerride**  
Snoop Latency Ocerride for PCH PCIE.
- **Non Snoop Latency Ocerride**  
Non Snoop Latency Ocerride for PCH PCIE.

### 3.2.3.2 USB Configuration

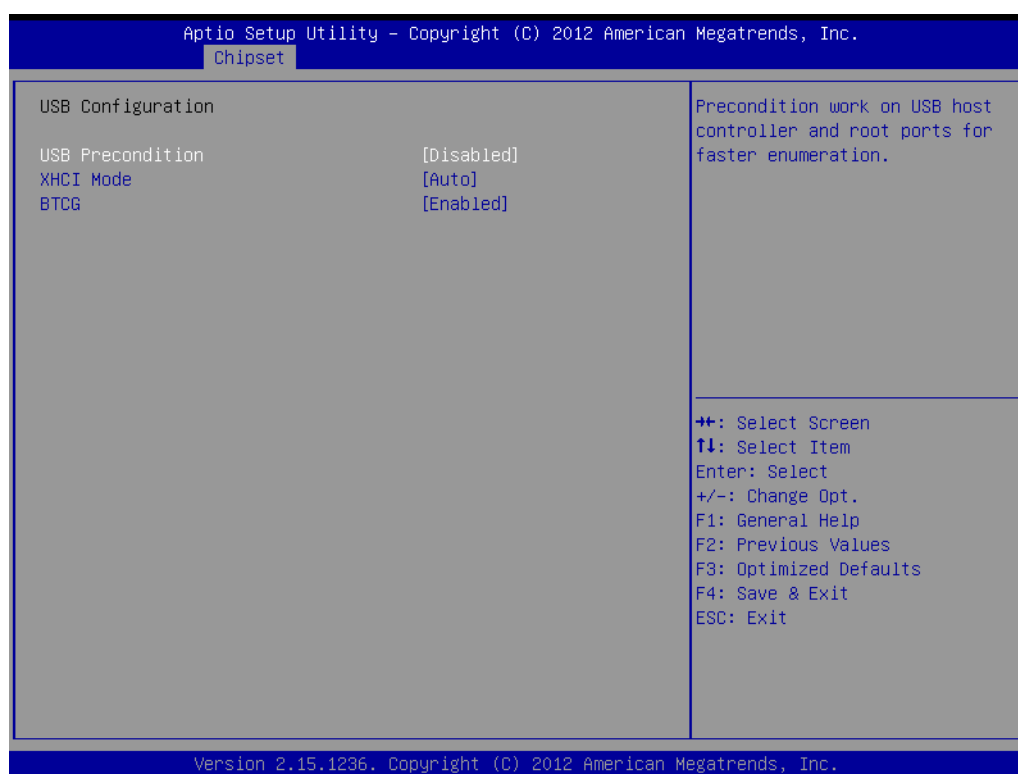

- **USB Precondition**  
This item allows user to enable or disable USB Precondition.
- **XHCI Mode**  
Select Smart auto, Auto, Enabled and Disable Mode of operation of XHCI controller.

**Note!** *Smart auto setting remembers the last setting, but auto mode does not.*



*Using smart auto setting, USB devices may not be recognized when system rebooting with more than one USB device connected.*

- **BTCG**  
Enables or disables the BTCG function.

### 3.2.3.3 PCH Azalia Configuration



- **Azalia**  
Control detection of the Azalia device.  
Disable = Azalia will be unconditionally disabled  
Enable=Azalia will be unconditionally enabled  
Auto=Azalia will be enabled if present, disabled otherwise

### 3.2.3.4 System Agent (SA) Configuration

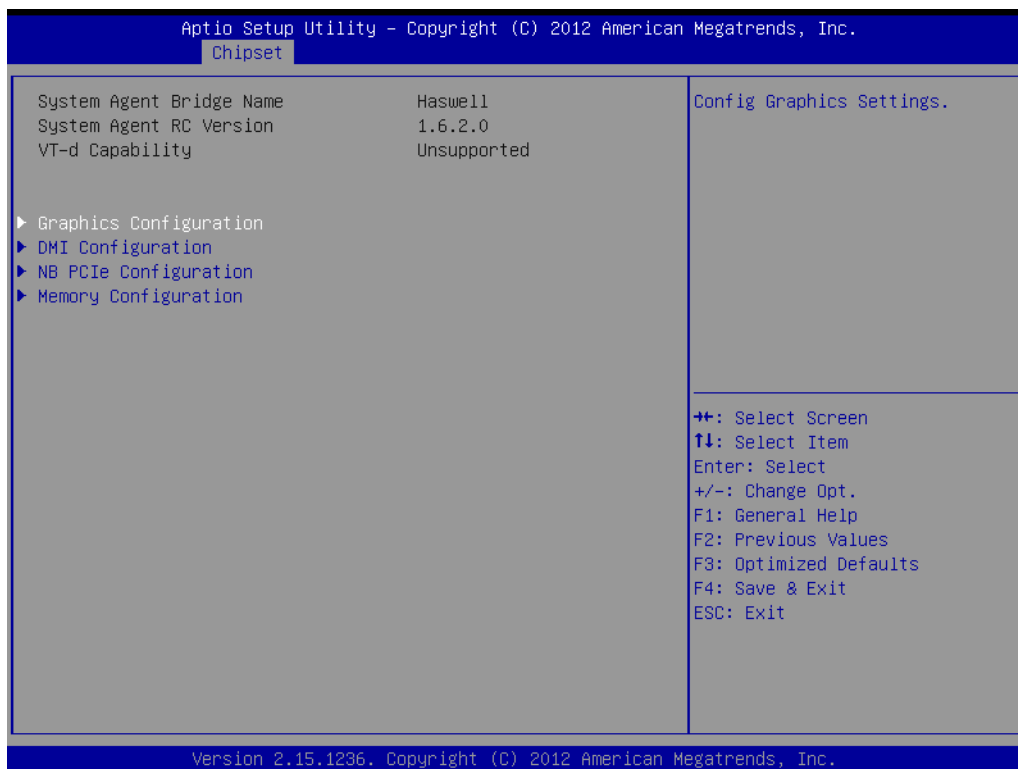

### Graphic Configuration

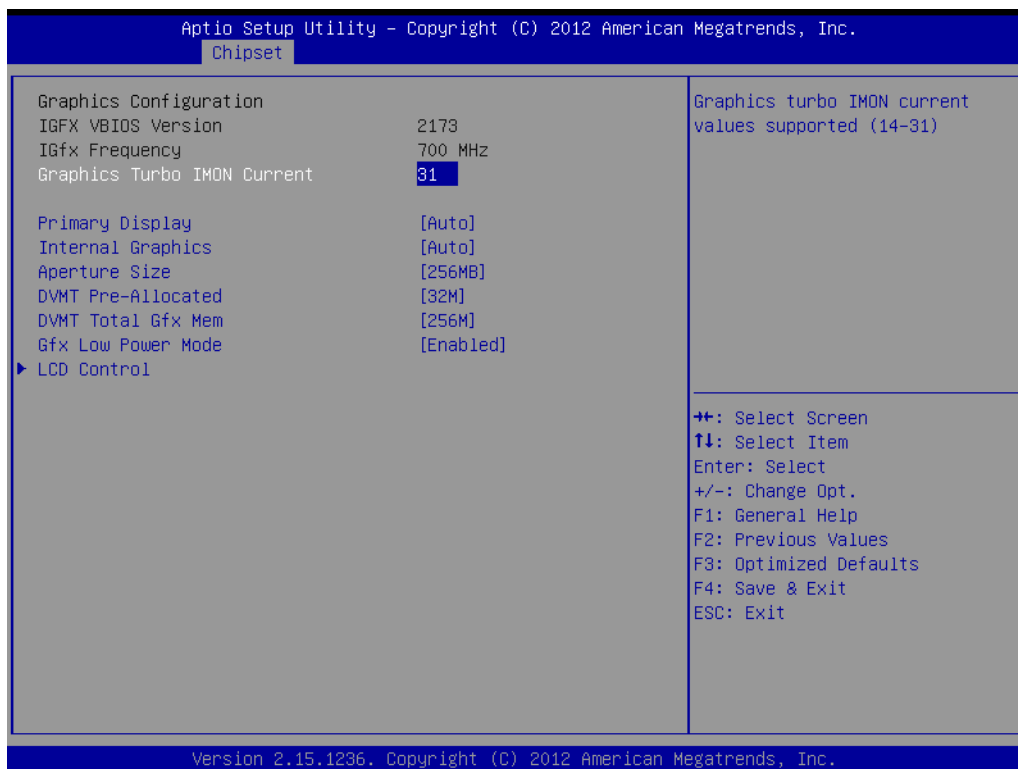

- **Graphics Turbo IMON Current**  
Graphics turbo IMON current values supported (14-31).
- **Primary Display**  
"Auto or IGFX or PEG" optimal to Primary Display.

- **Internal Graphics**  
"Auto or Disable or Enable" Internal Graphics.
- **Aperture Size**  
Aperture size optimal between 128MB, 256MB, or 512MB.
- **DVMT Pre-Allocated**  
DVMT pre-allocated (fixed) Graphics memory size optimal from 32M to 1024M.
- **DVMT Total Gfx Mem**  
DVMT Total Gfx Mem optimal Between 128M, 256M or MAX.
- **Gfx Low Power Mode**  
This item allows users to enable or disable IGD low power mode.

## LCD Control

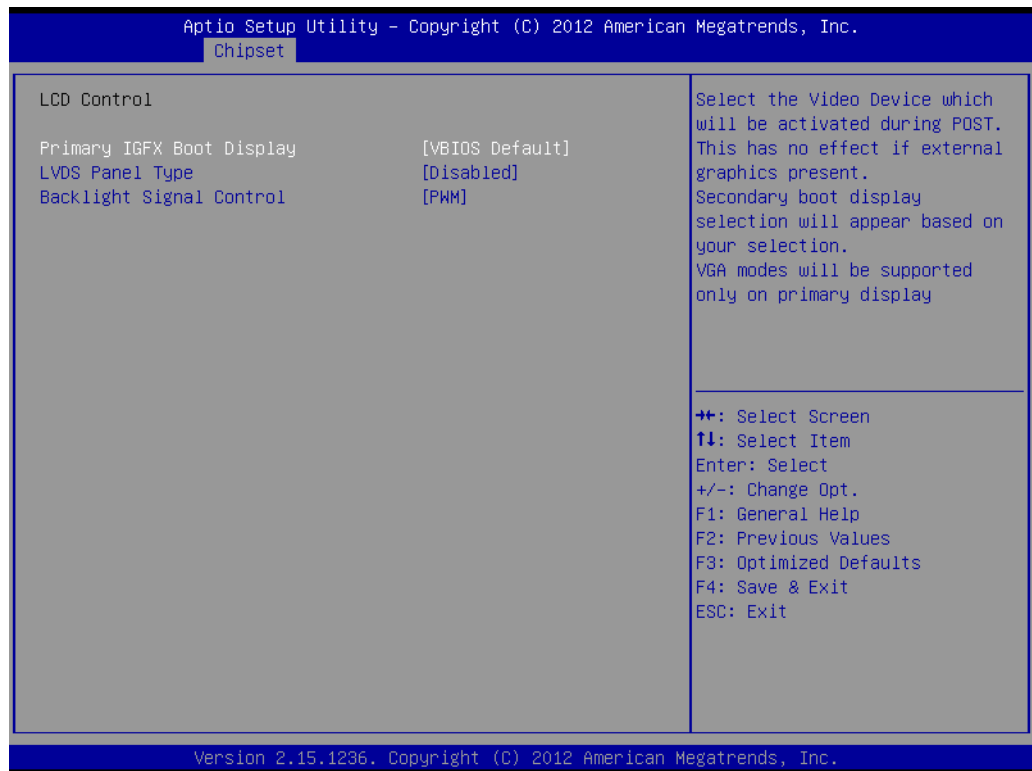

- **Primary IGFX Boot Display [VBIOS Default]**  
Select the video device which will be activated during POST. Secondary boot display selection will appear based on customer's selection.
- **LVDS Panel Type**  
LVDS Panel Type selection.
- **Backlight Signal Control**  
Switch Backlight Signal Control for PWM or LINEAR.

Here is 2 displays combination table and all of these combinations are verified and tested properly already.

Single Display		BIOS SETUP MENU	DOS	Win7
CRT		PASS	PASS	PASS
DVI		PASS	PASS	PASS
DP		PASS	PASS	PASS
LVDS		PASS	PASS	PASS
Dual Display		BIOS SETUP MENU	DOS	Win7 (Extended mode & Clone mode)
CRT	DP	PASS	Only Primary	PASS
CRT	DVI	PASS	Only Primary	PASS
CRT	LVDS	PASS	Only Primary	PASS
DVI	LVDS	PASS	Only Primary	PASS
DVI	DP	PASS	Only Primary	PASS
DP	LVDS	PASS	Only Primary	PASS

### 3.2.3.5 DMI Configuration

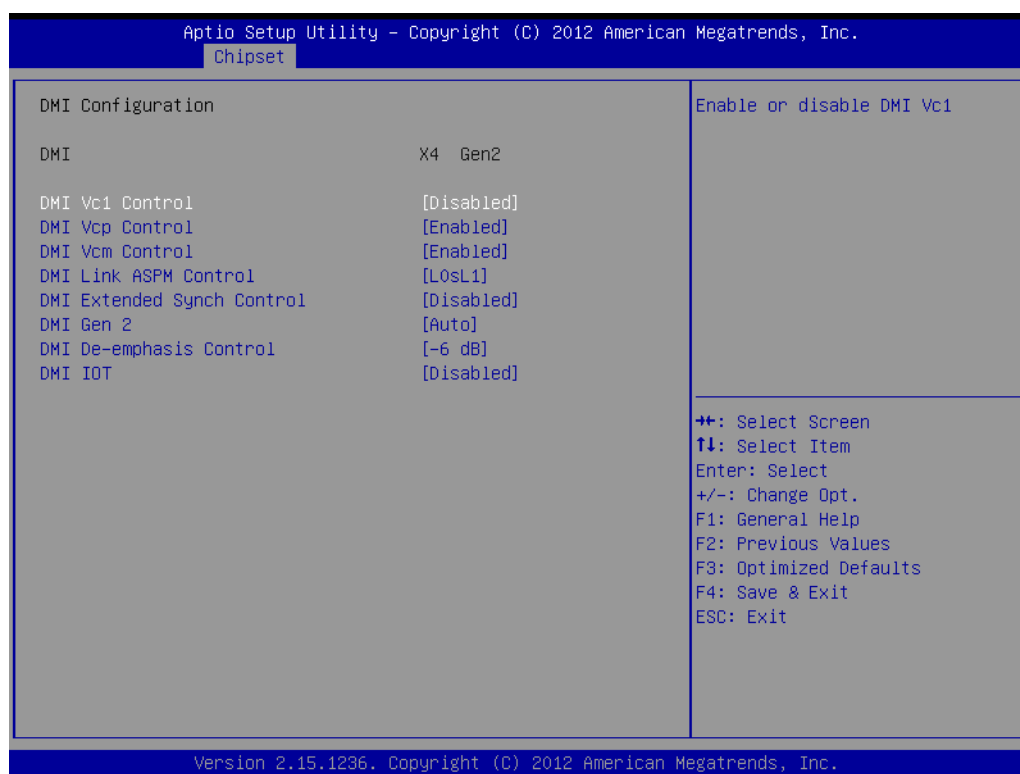

- **DMI Vc1 Control**  
This item allows users to enable or disable DMI Vc1.
- **DMI Vcp Control**  
This item allows users to enable or disable DMI Vcp.
- **DMI Vcm Control**  
This item allows users to enable or disable DMI Vcm.
- **DMI Link ASPM Control**  
This item allows users to select power management control.

- **DMI Extended Synch Control**  
This item allows users to enable or disable DMI Extended Synch.
- **DMI Gen 2**  
This item allows users to select DMI speed.
- **DMI De-emphasis Control**  
Configure the De-emphasis control on DMI.
- **DMI IOT**  
This item allows users to enable or disable DMI IOT.

### 3.2.3.6 NB PCIe Configuration

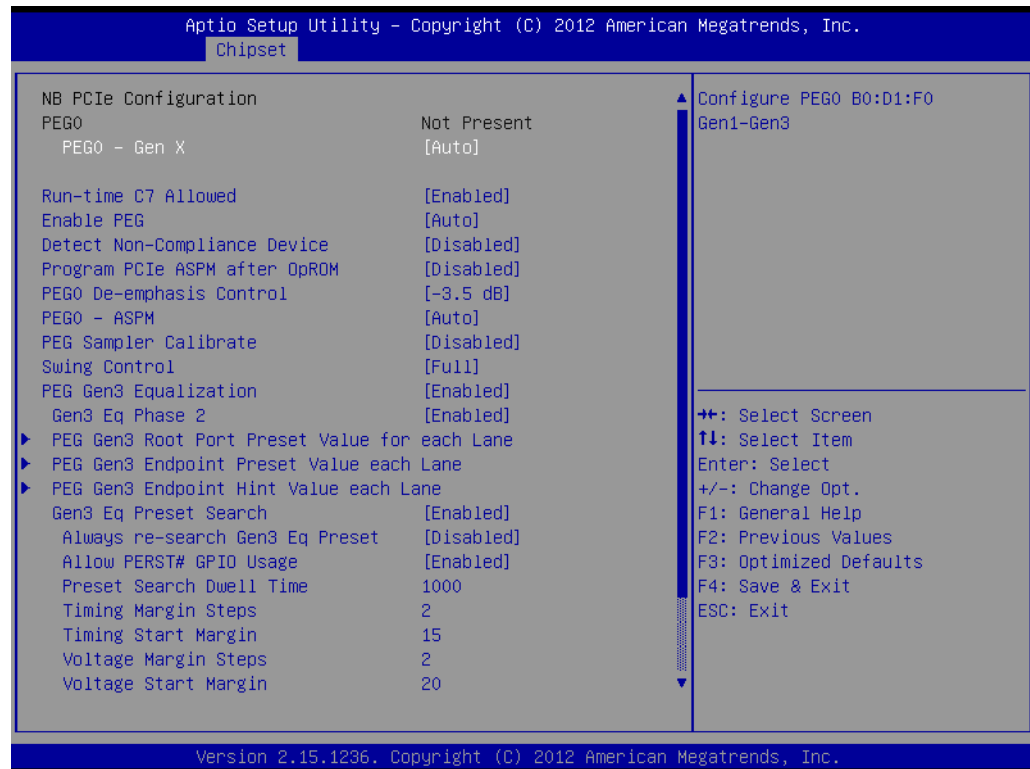

- **PEG0 - Gen x**  
"Auto, Enable or Disable" PEG0 - Gen x
- **Run-time C7 Allowed**  
Enable or Disable the entry to C7 state. Don't enable this feature until you have all the appropriate Save/Restore Controller/Endpoint states.
- **Enable PEG**  
"Auto, Enable or Disable" Enable PEG.
- **Detect Non-Compliance Device**  
Detect Non-Compliance PCI Express Device in PEG.
- **Program PCIe ASPM after OpROM**  
Enabled: PCIe ASPM will be programmed after OpROM  
Disabled: PCIe ASPM will be programmed before OpROM
- **PEG0 De-emphasis Control**  
Configure the De-emphasis control on PEG0.
- **PEG0 ASPM**  
Control ASPM support for the PEG Device. This has no effect if PEG is not the currently active device.

- **PEG Sampler Calibrate**  
This item allows users to enable or disable PEG sampler calibrate function
- **Swing Control**  
Perform PEG Swing Control, on IVB C0 and Later.
- **PEG Gen3 Equalization**  
This item allows users to enable or disable PEG Gen3 Equalization function.
- **Gen3 Eq Phase 2**  
This item allows users to enable or disable Gen3 Eq Phase 2 function.
- **Gen3 Eq Preset search**  
This item allows users to enable or disable Gen3 Eq Preset search function.
- **Always research Gen3 Eq Preset**  
This item allows users to enable or disable research Gen3 Eq Preset function.
- **Allow PERST# GPIO Usage**  
This item allows users to enable or disable Allow PERST# GPIO function.

### 3.2.3.7 Memory Information

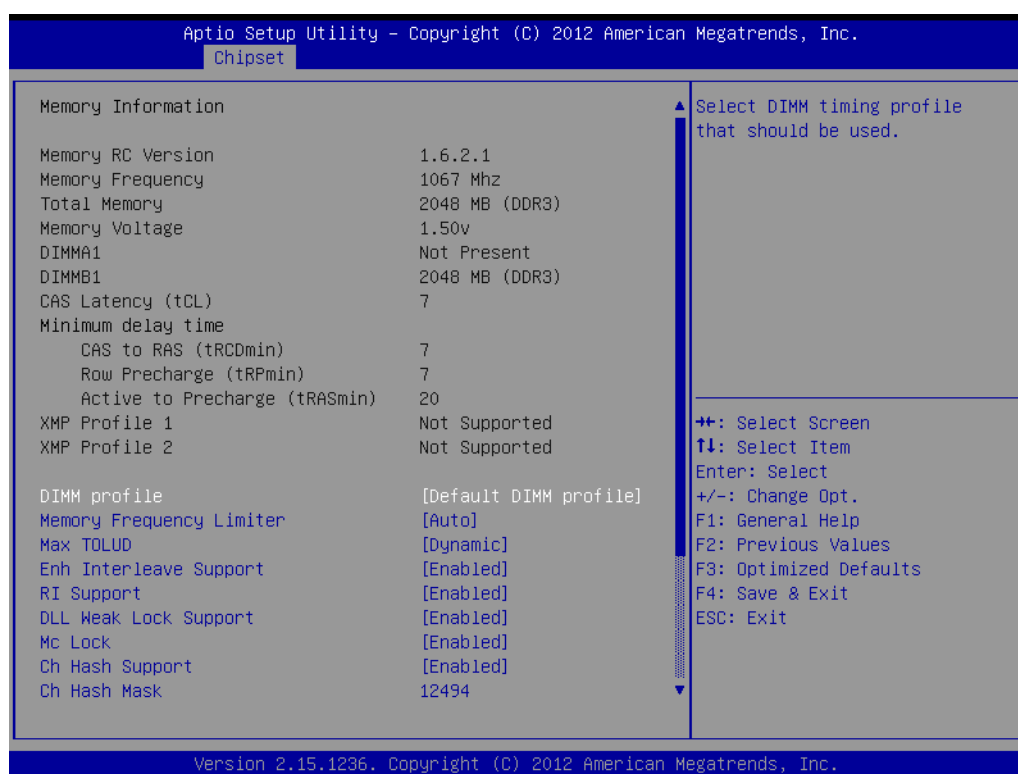

- **DIMM profile**  
Select DIMM timing profile that should be used.
- **Memory Frequency Limiter**  
Maximum Memory Frequency selection in MHz.
- **Max TOLUD**  
This item allows users to select the maximum TOLUD.
- **Enh Interleave Support**  
This item allows users to enable or disable EnH Interleave function.
- **RI Support**  
This item allows users to enable or disable RI support function.

- **DLL Weak Lock Support**  
This item allows users to enable or disable DLL Weak Lock Support function.
- **Mc Lock**  
This item allows users to enable or disable Mc Lock function.
- **Ch Hash Support**  
This item allows users to enable or disable Ch Hash function.
- **Ch Hash Mask**  
Set the BIT(s) to be included in the XOR function. NOTE: BIT mask corresponds to BITS[19:6]

### 3.2.4 Boot

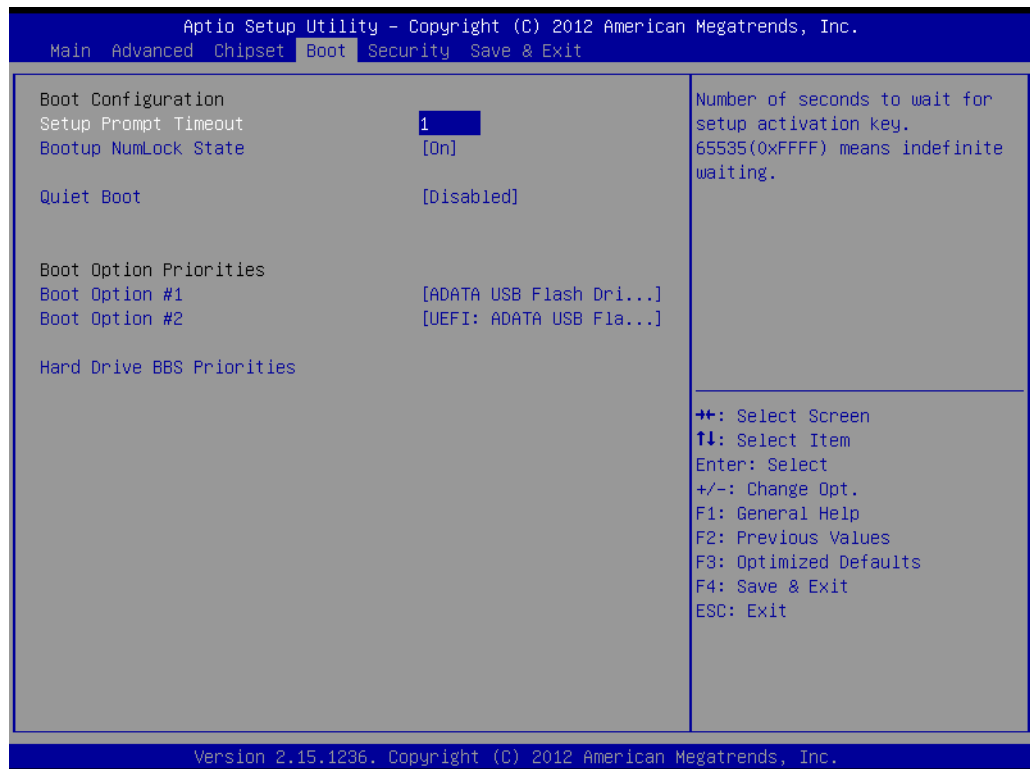

- **Setup Prompt Timeout**  
This item allows you to change number of seconds to wait for setup activation key.
- **Bootup NumLock State**  
Select the Power-on state for Numlock.
- **Quiet Boot**  
If this option is set to Disabled, the BIOS display normal POST messages. If Enabled, an OEM Logo is shown instead of POST messages.
- **Boot Option Priorities**  
Set the system boot order.



### 3.2.5 Security

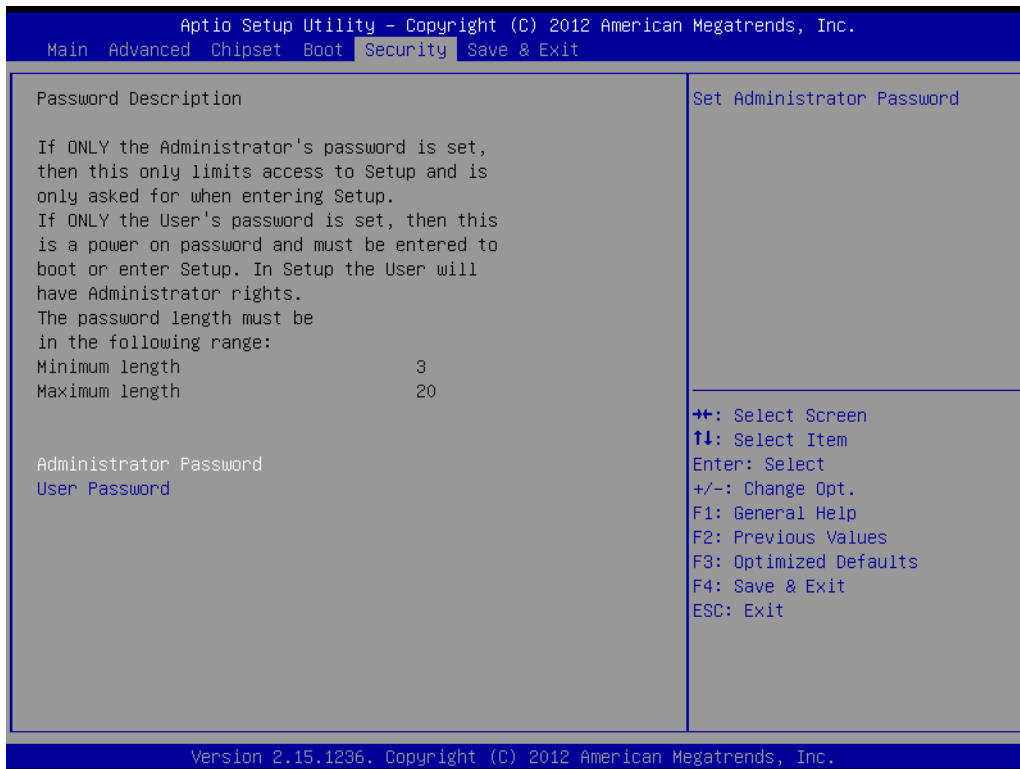

Select Security Setup from the AIMB-203 Setup main BIOS setup menu. All Security Setup options, such as password protection and virus protection are described in this section. To access the sub menu for the following items, select the item and press<Enter>: Change Administrator / User Password.

## 3.2.6 Save & Exit

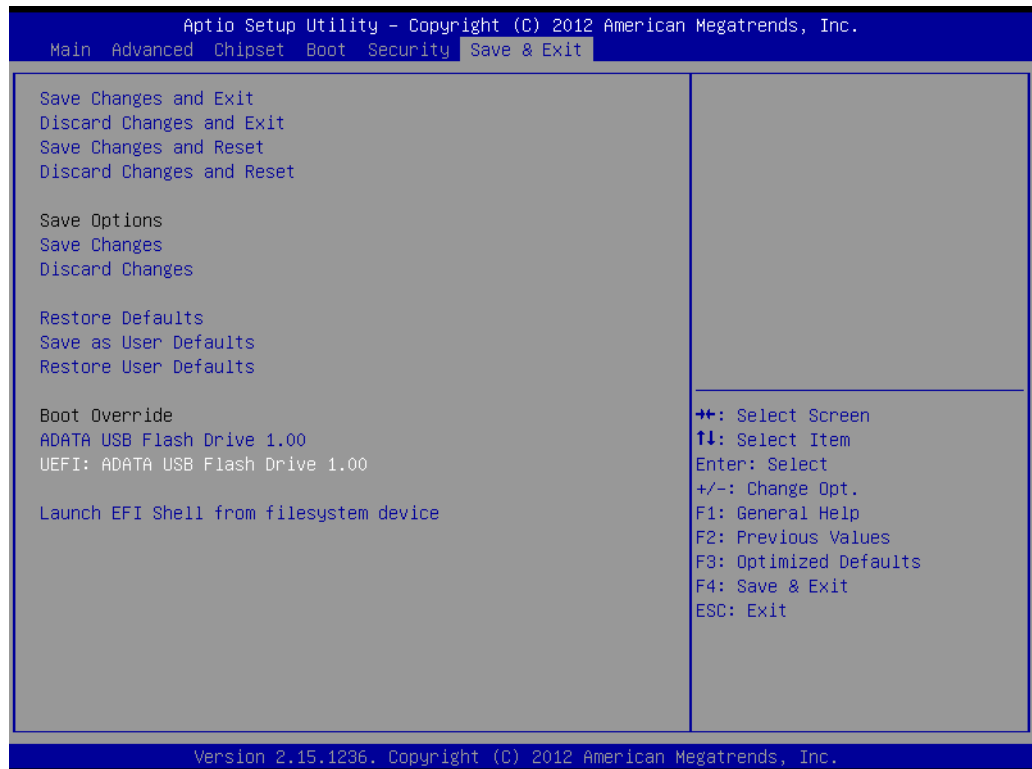

- **Save Changes and Exit**  
This item allows you to exit system setup after saving changes.
- **Discard Changes and Exit**  
This item allows you to exit system setup without saving any changes.
- **Save Changes and Reset**  
This item allows you to reset the system after saving the changes.
- **Discard Changes and Reset**  
This item allows you to reset system setup without saving any changes.
- **Save Changes**  
This item allows you to save changes done so far to any of the options.
- **Discard Changes**  
This item allows you to discard changes done so far to any of the options.
- **Restore Defaults**  
This item allows you to restore/load default values for all the options.
- **Save as User Defaults**  
This item allows you to save the changes done so far as user defaults.
- **Restore User Defaults**  
This item allows you to restore the user defaults to all the options.
- **Boot Override**  
Boot device selection can override your boot priority.
- **Launch EFI Shell from filesystem device**  
Attempts to Launch EFI Shell application (Shellx64.efi) from one of the available filesystem devices.

# Chapter 4

Software Introduction  
& Service

## 4.1 Introduction

The mission of Advantech Embedded Software Services is to "Enhance quality of life with Advantech platforms and Microsoft® Windows® embedded technology." We enable Windows® Embedded software products on Advantech platforms to more effectively support the embedded computing community. Customers are freed from the hassle of dealing with multiple vendors (hardware suppliers, system integrators, embedded OS distributors) for projects. Our goal is to make Windows® Embedded Software solutions easily and widely available to the embedded computing community.

## 4.2 Value-Added Software Services

Software API: An interface that defines the ways by which an application program may request services from libraries and/or operating systems. Provides not only the underlying drivers required but also a rich set of user-friendly, intelligent and integrated interfaces, which speeds development, enhances security and offers add-on value for Advantech platforms. It plays the role of catalyst between developer and solution, and makes Advantech embedded platforms easier and simpler to adopt and operate with customer applications.

### 4.2.1 Software API

#### 4.2.1.1 Control

##### GPIO



General Purpose Input/Output is a flexible parallel interface that allows a variety of custom connections. It allows users to monitor the level of signal input or set the output status to switch on/off the device. Our API also provide Programmable GPIO, which allows developers to dynamically set the GPIO input or output status.

#### 4.2.1.2 Display

##### Brightness Control



The Brightness Control API allows a developer to access embedded devices and easily control brightness.

##### Backlight



The Backlight API allows a developer to control the backlight (screen) on/off in embedded devices.

### 4.2.1.3 Monitor

#### Watchdog



A watchdog timer (WDT) is a device that performs a specific operation after a certain period of time if something goes wrong and the system does not recover on its own. A watchdog timer can be programmed to perform a warm boot (restarting the system) after a certain number of seconds.

#### Hardware Monitor



The Hardware Monitor (HWM) API is a system health supervision API that inspects certain condition indexes, such as fan speed, temperature and voltage.

### 4.2.1.4 Power Saving

#### CPU Speed



Makes use of Intel SpeedStep technology to save power consumption. The system will automatically adjust the CPU speed depending on the system loading.

#### System Throttling



Refers to a series of methods for reducing power consumption in computers by lowering the clock frequency. This API allows the user to adjust the clock from 87.5% to 12.5%.



# Chapter 5

Chipset Software  
Installation Utility

## 5.1 Before You Begin

To facilitate the installation of the enhanced display drivers and utility software, read the instructions in this chapter carefully. The drivers for the AIMB-203 are located on the software installation CD. The driver in the folder of the driver CD will guide and link you to the utilities and drivers under a Windows system. Updates are provided via Service Packs from Microsoft\*.

**Note!** *The files on the software installation CD are compressed. Do not attempt to install the drivers by copying the files manually. You must use the supplied SETUP program to install the drivers.*



Before you begin, it is important to note that most display drivers need to have the relevant software application already installed in the system prior to installing the enhanced display drivers. In addition, many of the installation procedures assume that you are familiar with both the relevant software applications and operating system commands. Review the relevant operating system commands and the pertinent sections of your application software's user manual before performing the installation.

## 5.2 Introduction

The Intel® Chipset Software Installation (CSI) utility installs the Windows INF files that outline to the operating system how the chipset components will be configured. This is needed for the proper functioning of the following features:

- Core PCI PnP services
- IDE Ultra ATA 100/66/33 and Serial ATA interface support
- USB support
- Identification of Intel® chipset components in the Device Manager

**Note!** *This utility is used for the following versions of Windows, and it has to be installed **before** installing all the other drivers:*



- Windows 7 (32-bit)
- Windows 7 (64-bit)
- Windows 8 (32-bit)
- Windows 8 (64-bit)



## 5.3 Windows 7/8 Driver Setup

1. Insert the driver CD into your system's CD-ROM drive. You can see the driver folder items. Navigate to the "Intel Chip" folder and click "infinst\_autol.exe" to complete the installation of the driver.

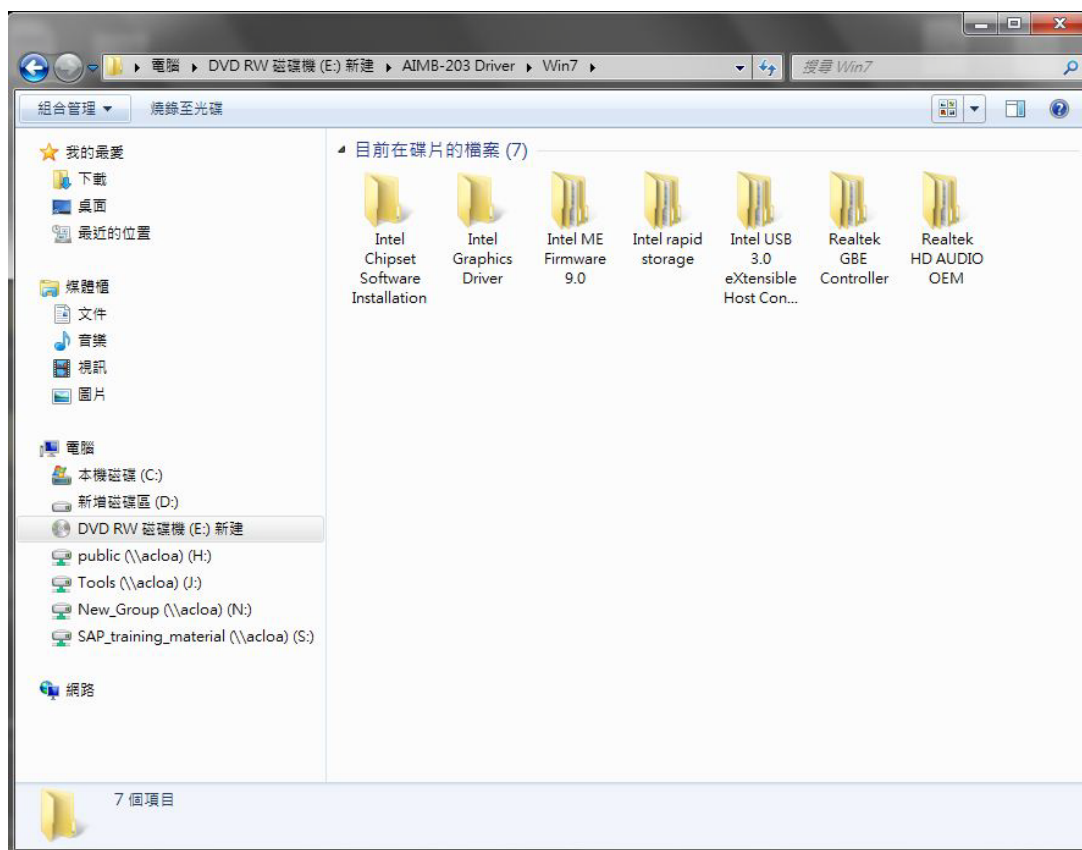



# Chapter 6

## VGA Setup

## 6.1 Introduction

4th Gen Intel Core i processors are embedded with an integrated graphics controller. You need to install the VGA driver to enable the function.

Optimized integrated graphic solution: With Intel Graphics Flexible, it supports versatile display options and 32-bit 3D graphics engine. Dual independent display, enhanced display modes for widescreen flat panels for extend, twin, and clone dual display mode, and optimized 3D support deliver an intensive and realistic visual experience.

## 6.2 Windows 7/8

**Note!** Before installing this driver, make sure the CSI utility has been installed in your system. See Chapter 5 for information on installing the CSI utility.



Insert the driver CD into your system's CD-ROM drive. You can see the driver folders items. Navigate to the "Intel Graphics" folder and click "setup.exe" to complete the installation of the drivers for Windows 7 and Windows 8.

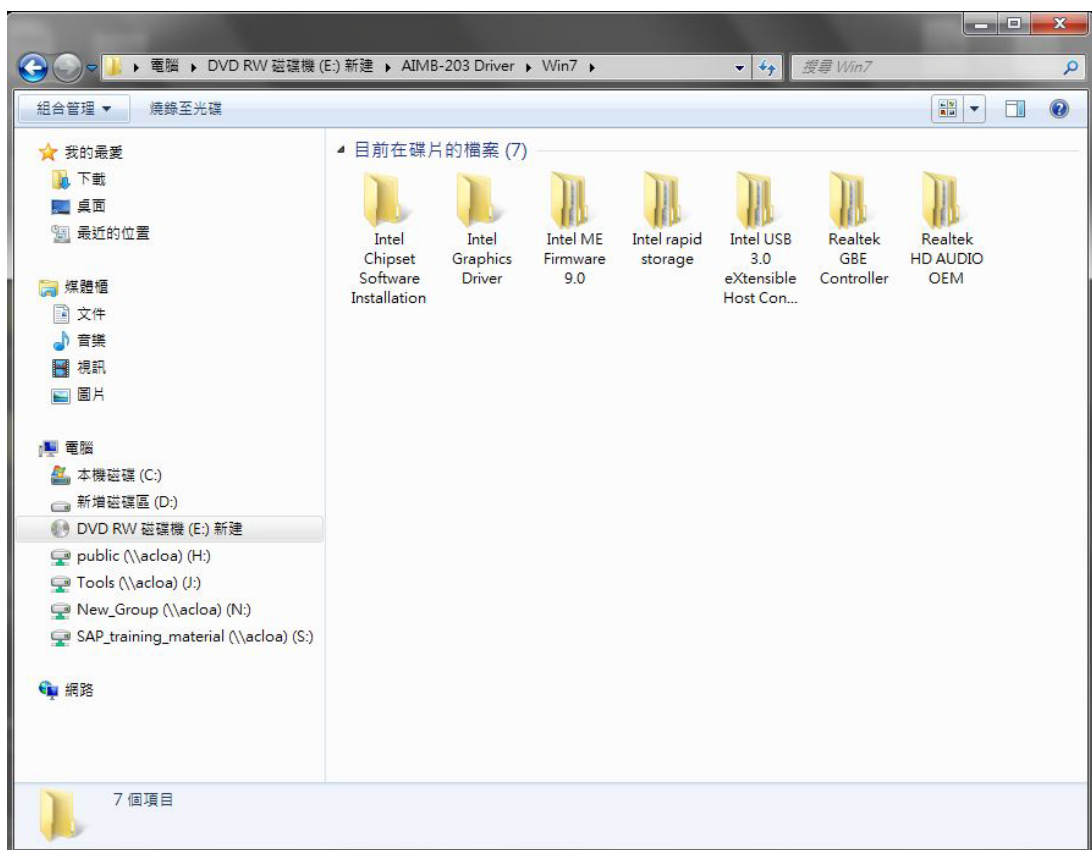

# Chapter 7

## LAN Configuration

---

## 7.1 Introduction

The AIMB-203 has dual Gigabit Ethernet LANs via dedicated PCI Express x1 lanes (Realtek 8111E (LAN1) and Realtek 8111E(LAN2)) that offer bandwidth of up to 500 MB/sec, eliminating the bottleneck of network data flow and incorporating Gigabit Ethernet at 1000 Mbps.

## 7.2 Features

- Integrated 10/100/1000 Mbps transceiver
- 10/100/1000 Mbps triple-speed MAC
- High-speed RISC core with 24-KB cache
- On-chip voltage regulation
- Wake-on-LAN (WOL) support
- PCI Express X1 host interface

## 7.3 Installation

**Note!** *Before installing the LAN drivers, make sure the CSI utility has been installed on your system. See Chapter 5 for information on installing the CSI utility.*



The AIMB-203's Realtek 8111E (LAN1) and Realtek 8111E (LAN2) Gigabit integrated controllers support all major network operating systems. However, the installation procedure varies from system to system. Please find and use the section that provides the driver setup procedure for the operating system you are using.

## 7.4 Windows® 7/8 Driver Setup (Realtek 8111E)

Insert the driver CD into your system's CD-ROM drive. Select the "Realtek GBE Controller" folder then navigate to the directory for your OS.

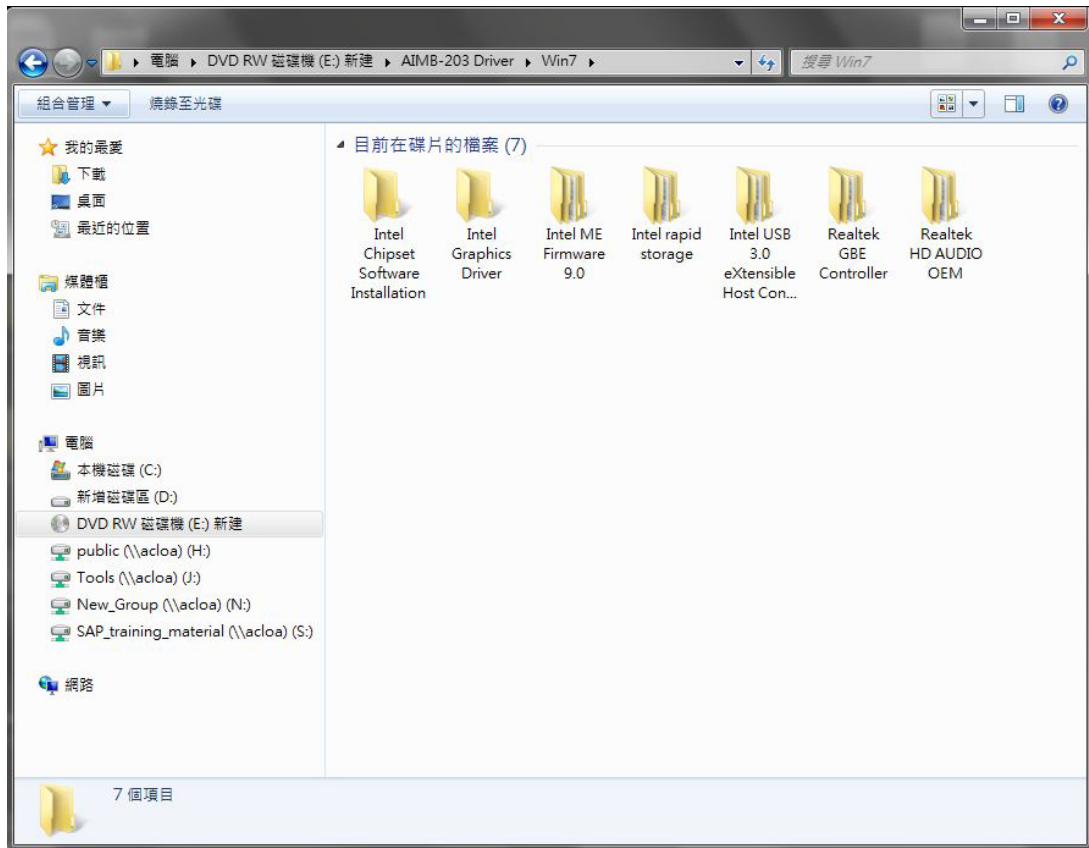





# Appendix **A**

I/O Pin Assignments

## A.1 PS/2 Keyboard and PS/2 Mouse Connector (KBMS1)

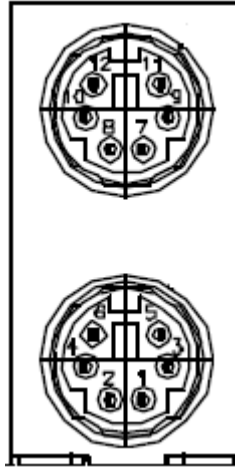

Pin	Signal
1	Keyboard DATA
2	NC
3	GND
4	+5V
5	Keyboard CLK
6	NC
7	Mouse DATA
8	NC
9	GND
10	+5V
11	Mouse CLK
12	NC

## A.2 DVI-D(Up) and VGA(Down) Connector (VGA1+DVI1)

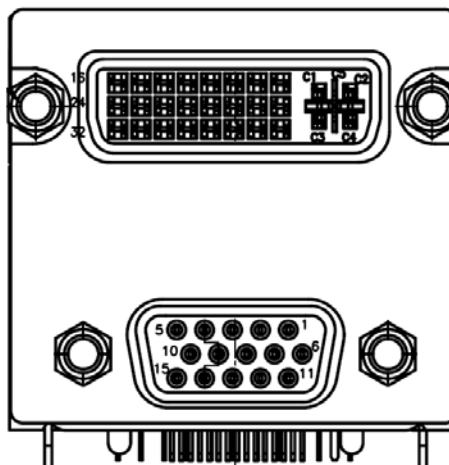

Pin	Signal	Pin	Signal
1	RED	2	GREEN
3	BLUE	4	ID2
5	GND	6	RED GND
7	GREEN GND	8	BLUE GND
9	KEY	10	SGND
11	ID0	12	SDA
13	HSYNC	14	VSYNC
15	SCL	16	TMDS DATA2-
17	TMDS DATA2+	18	TMDS DATA 2/4 Shield
19	GND	20	GND
21	DDC clock	22	DDC data
23	GND	24	TMDS DATA1-
25	TMDS DATA1+	26	TMDS DATA 1/3 Shield
27	GND	28	GND
29	+5V	30	GND
31	Hot Plug Detect	32	TMDS DATA0-
33	TMDS DATA0+	34	GND
35	GND	36	GND
C1	GND	C2	GND
C3	GND	C4	GND
C5	GND		

### A.3 DisplayPort connector (DP1)

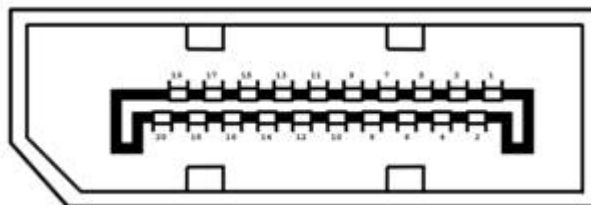

Pin	Signal	Pin	Signal
1	ML_LANE0+	2	GND
3	ML_LANE0-	4	ML_LANE1+
5	GND	6	ML_LANE1-
7	ML_LANE2+	8	GND
9	ML_LANE2-	10	ML_LANE3+
11	GND	12	ML_LANE3-
13	Config 1	14	GND
15	AUX_CH+	16	GND
17	AUX_CH-	18	Hot Plug Detect
19	GND	20	+3.3V

## A.4 COM1 Connector (COM1)

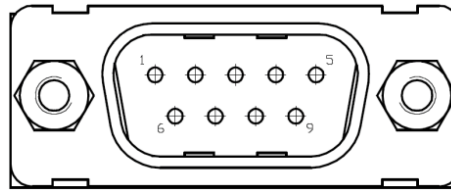

Pin	Signal	Pin	Signal
1	DCD#	6	DSR#
2	RXD	7	RST#
3	TXD	8	CTS#
4	DTR#	9	RI
5	GND		

## A.5 RJ45+USB3.0 Stack Connector (LAN1\_USB12)

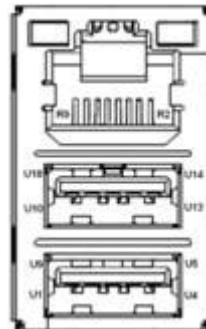

Pin	Signal	Pin	Signal
R2	MDI_0+	R3	MDI_0-
R4	MDI_1+	R5	MDI_1-
R6	MDI_2+	R7	MDI_2-
R8	MDI_3+	R9	MDI_3-
U1	+5V	U2	D0-
U3	D0+	U4	GND
U5	RX0-	U6	RX0+
U7	GND	U8	TX0-
U9	TX0+	U10	+5V
U11	D1-	U12	D1+
U13	GND	U14	RX1-
U15	RX1+	U16	GND
U17	TX1-	U18	TX1+

## A.6 RJ45+USB2.0 Stack Connector (LAN2\_USB34)

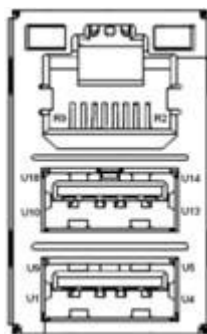

Pin	Signal	Pin	Signal
R2	MDI_0+	R3	MDI_0-
R4	MDI_1+	R5	MDI_1-
R6	MDI_2+	R7	MDI_2-
R8	MDI_3+	R9	MDI_3-
U1	+5V	U2	D0-
U3	D0+	U4	GND
U5	RX0-	U6	RX0+
U7	GND	U8	TX0-
U9	TX0+	U10	+5V
U11	D1-	U12	D1+
U13	GND	U14	RX1-
U15	RX1+	U16	GND
U17	TX1-	U18	TX1+

## A.7 HD Analog Audio Interface (AUDIO1)

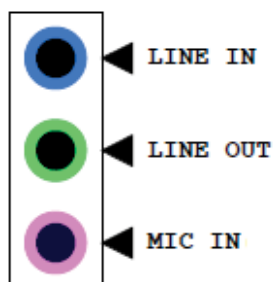

Pin	Signal
1	MIC IN
2	LINE OUT
3	LINE IN

## A.8 Case Open Selection Pin Header (JCASEOP\_SW1)



Pin	Signal
1	CASEOP#
2	HWM_CASEOP#
3	CASEOP

Note: Setting Case Open w/ Normal Close or Open Switch. (2-3) is default.

## A.9 Case Open Pin Header (JCASE1)

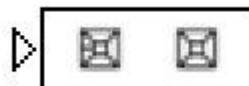

Pin	Signal
1	CASEOP
2	GND

## A.10 COM1 RI# Selection Pin Header (JSETCOM1\_V1)

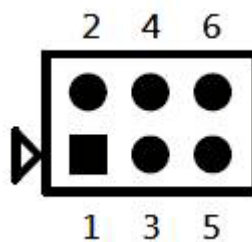

Pin	Signal
1	RI#
2	RI#_VCON
3	RI#_VCON
4	+5V
5	+12V
6	RI#_VCON

## A.11 Front Panel Audio Pin Header (FPAUD1)

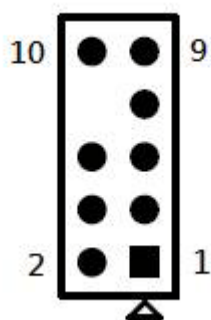

Pin	Signal
1	MIC IN-L
2	GND
3	MIC IN-R
4	FPAUD_DETECT#
5	LINE OUT-R
6	SENSE R1
7	SENSE
8	KEY
9	LINE OUT-L
10	SENSE R2

## A.12 HD Audio Interface Pin Header (SPDIF1)

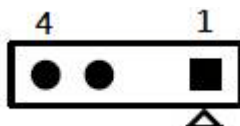

Pin	Signal
1	+5V
2	KEY
3	SPDIF OUT
4	GND

## A.13 Print Port Interface Box Header (LPT1)

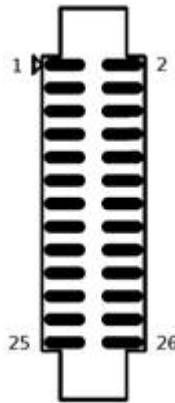

Pin	Signal	Pin	Signal
1	STB#	2	AFD#
3	PD0	4	ERR#
5	PD1	6	INIT#
7	PD2	8	SLIN#
9	PD3	10	GND
11	PD4	12	GND
13	PD5	14	GND
15	PD6	16	GND
17	PD7	18	GND
19	ACK#	20	GND
21	BUSY	22	GND
23	PE	24	GND
25	SLCT	26	NC

## A.14 LVDS VESA, JEIDA Format Selection Pin Header (JLVDS\_VCON1)

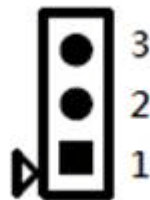

Pin	Signal
1	+3.3V
2	OPTION
3	GND



## A.15 Audio Amplifier Output Pin Header (JAMP1)

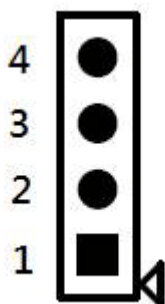

Pin	Signal
1	GND
2	AMP_OUT-L
3	GND
4	AMP_OUT-R

## A.16 COM2 RI# Selection Pin Header (JSETCOM2\_V1)



Pin	Signal
1	RI#
2	RI#_VCON
3	RI#_VCON
4	+5V
5	+12V
6	RI#_VCON

## A.17 LVDS Backlight Inverter Power Connector (INV1)

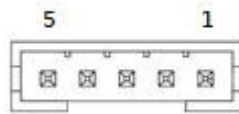

Pin	Signal
1	+12V
2	GND
3	BKL_EN
4	BKL_CTRL
5	+5V

## A.18 LVDS Panel Voltage Selection (JLVDS1)

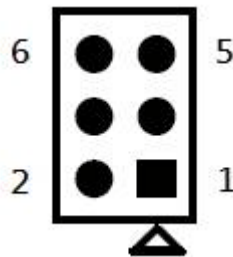

Pin	Signal
1	NC
2	+5V
3	+12V
4	LVDS_VDD
5	NC
6	+3.3V

## A.19 LVDS Panel Connector (LVDS1)

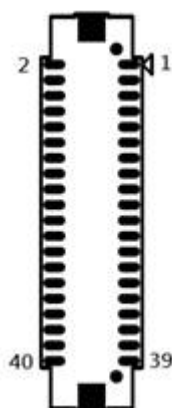

Pin	Signal	Pin	Signal
1	VDD	2	VDD
3	LVDS DETECT#	4	GND
5	VDD	6	VDD
7	OD0-	8	ED0-
9	OD0+	10	ED0+
11	GND	12	GND
13	OD1-	14	ED1-
15	OD1+	16	ED1+
17	GND	18	GND
19	OD2-	20	ED2-
21	OD2+	22	ED2+
23	GND	24	GND
25	OCK-	26	ECK-
27	OCK+	28	ECK+
29	GND	30	GND
31	DDC CLK	32	DDC DAT
33	GND	34	GND
35	OD3-	36	ED3-
37	OD3+	38	ED3+
39	LVDS ENBKL	40	LVDS VCON

## A.20 ATX 12V Power Supply Connector (ATX12V1)

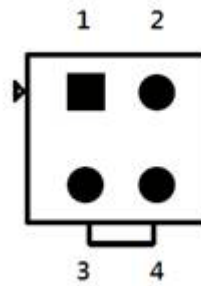

Pin	Signal
1	GND
2	GND
3	+12V
4	+12V

## A.21 Low Pin Count Interface Header (LPC1)

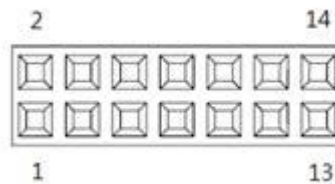

Pin	Signal	Pin	Signal
1	LPC CLK (33MHz)	2	AD1
3	RESET#	4	AD0
5	FRAME#	6	+3.3V
7	AD3	8	GND
9	AD2	10	SMBus CLK
11	SERIRQ	12	SMBus DAT
13	+5VSB	14	+5V

## A.22 8-bit General Purpose I/O Pin Header (GPIO1)

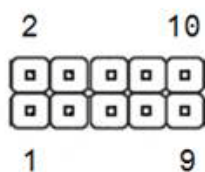

Pin	Signal	Pin	Signal
1	GPIO0	2	GPIO4
3	GPIO1	4	GPIO5
5	GPIO2	6	GPIO6
7	GPIO3	8	GPIO7
9	+5V	10	GND

## A.23 COM2 ~ COM5 Box Header (COM2345)

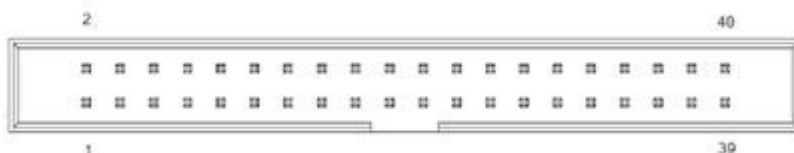

Pin	Signal	Pin	Signal
1	DCD# [2]	2	DSR# [2]
3	RXD [2]	4	RST# [2]
5	TXD [2]	6	CTS# [2]
7	DTR# [2]	8	RI [2]
9	GND	10	GND
11	DCD# [3]	12	DSR# [3]
13	RXD [3]	14	RST# [3]
15	TXD [3]	16	CTS# [3]
17	DTR# [3]	18	RI [3]
19	GND	20	GND
21	DCD# [4]	22	DSR# [4]
23	RXD [4]	24	RST# [4]
25	TXD [4]	26	CTS# [4]
27	DTR# [4]	28	RI [4]
29	GND	30	GND
31	DCD# [5]	32	DSR# [5]
33	RXD [5]	34	RST# [5]
35	TXD [5]	36	CTS# [5]
37	DTR# [5]	38	RI [5]
39	GND	40	GND

## A.24 COM5 RS232,RS422,RS485 Selection Pin Header (JSETCOM5)

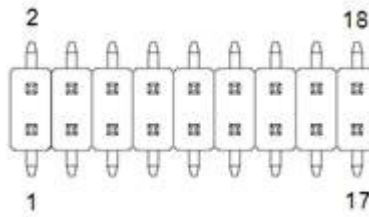

Pin	Signal	Pin	Signal
1	RX	2	RX_485
3	RX	4	RX_422
5	RX	6	RX_232
7	DCD [5]	8	SOUT [5]
9	DCD# [5]	10	COM_SOUT [5]
11	TX_485-	12	RX_485+
13	SIN [5]	14	DTR [5]
15	COM_SIN [5]	16	DTR# [5]
17	TX_485+	18	RX_485-

## A.25 MINIPCIE, mSATA Connector (MINIPCIE1)

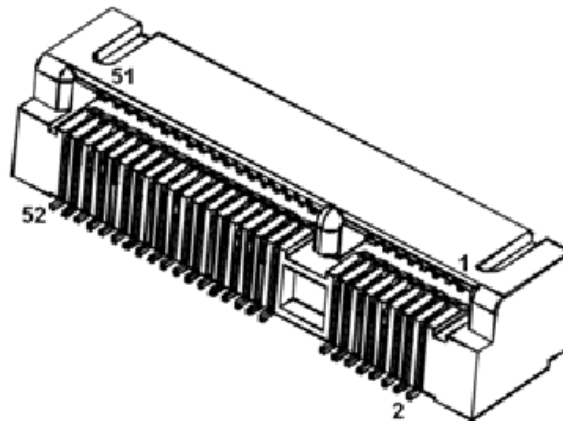

MINIPCIE:

Pin	Signal	Pin	Signal
1	WAKE#	2	+3.3Vaux
3	Reserved	4	GND
5	Reserved	6	+1.5V
7	CLKREQ#	8	Reserved
9	GND	10	Reserved
11	REFCLK-	12	Reserved
13	REFCLK+	14	Reserved

15	GND	16	Reserved
17	Reserved	18	GND
19	Reserved	20	DISABLE#
21	DETECT#	22	RESET#
23	PCIE_RX+	24	+3.3Vaux
25	PCIE_RX-	26	GND
27	GND	28	+1.5V
29	GND	30	SMB_CLK
31	PCIE_TX-	32	SMB_DATA
33	PCIE_TX+	34	GND
35	GND	36	USB_D-
37	GND	38	USB_D+
39	+3.3Vaux	40	GND
41	+3.3Vaux	42	Reserved
43	V1.2_DETECT#	44	LED_WLAN#
45	Reserved	46	Reserved
47	Reserved	48	+1.5V
49	Reserved	50	GND
51	MSATA_DETECT#	52	+3.3Vaux

## mSATA:

Pin	Signal	Pin	Signal
1	Reserved	2	+3.3V
3	Reserved	4	GND
5	Reserved	6	+1.5V
7	Reserved	8	Reserved
9	GND	10	Reserved
11	Reserved	12	Reserved
13	Reserved	14	Reserved
15	GND	16	Reserved
17	Reserved	18	GND
19	Reserved	20	Reserved
21	DETECT#	22	Reserved
23	RX+	24	+3.3V
25	RX-	26	GND
27	GND	28	+1.5V
29	GND	30	SMB_CLK
31	TX-	32	SMB_DATA

33	TX+	34	GND
35	GND	36	Reserved
37	GND	38	Reserved
39	+3.3V	40	GND
41	+3.3V	42	Reserved
43	Reserved	44	Reserved
45	Reserved	46	Reserved
47	Reserved	48	+1.5V
49	Reserved	50	GND
51	MSATA_DETECT#	52	+3.3V

## A.26 MINIPCI Connector (MINIPCI2)

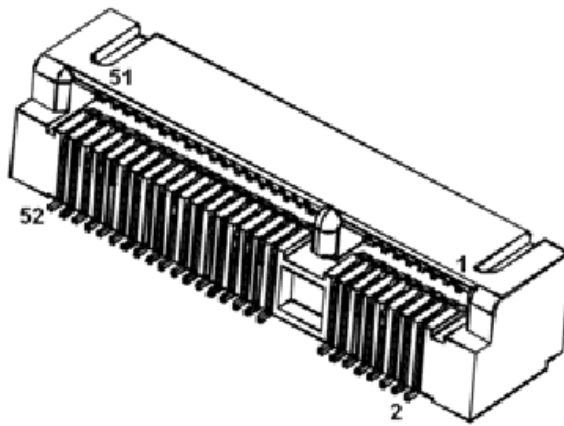

Pin	Signal	Pin	Signal
1	WAKE#	2	+3.3Vaux
3	Reserved	4	GND
5	Reserved	6	+1.5V
7	CLKREQ#	8	UIM_PWR
9	GND	10	UIM_DATA
11	REFCLK-	12	UIM_CLK
13	REFCLK+	14	UIM_RESET
15	GND	16	UIM_VPP
17	Reserved	18	GND
19	Reserved	20	Reserved
21	DETECT#	22	PERST#
23	PCIE_RX-	24	+3.3Vaux
25	PCIE_RX+	26	GND
27	GND	28	+1.5V



29	GND	30	SMB_CLK
31	PCIE_TX-	32	SMB_DATA
33	PCIE_TX+	34	GND
35	GND	36	USB_D-
37	GND	38	USB_D+
39	+3.3Vaux	40	GND
41	+3.3Vaux	42	Reserved
43	V1.2_DETECT#	44	LED_WLAN#
45	Reserved	46	Reserved
47	Reserved	48	+1.5V
49	Reserved	50	GND
51	Reserved	52	+3.3Vaux

## A.27 Serial ATA Interface Connector (SATA1~SATA3)

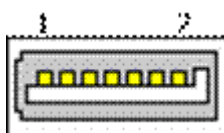

Pin	Signal
1	GND
2	TX+
3	TX-
4	GND
5	RX-
6	RX+
7	GND

## A.28 PCI-Express x16 Slot (PCIEX16\_1)

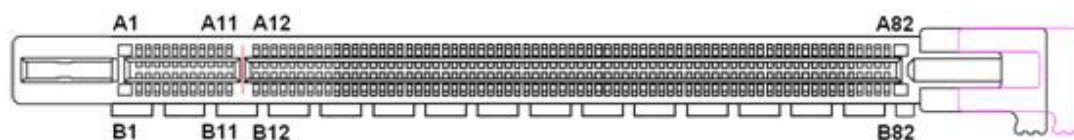

Pin	Signal	Pin	Signal
B1	+12V	A1	PRSNT1#
B2	+12V	A2	+12V
B3	+12V	A3	+12V
B4	GND	A4	GND
B5	SMB_CLK	A5	Reserved
B6	SMB_DATA	A6	Reserved

B7	GND	A7	Reserved
B8	+3.3V	A8	Reserved
B9	Reserved	A9	+3.3V
B10	+3.3VAUX	A10	+3.3V
B11	WAKE#	A11	PWRGD
B12	Reserved	A12	GND
B13	GND	A13	REFCLK+
B14	TX0+	A14	REFCLK-
B15	TX0-	A15	GND
B16	GND	A16	RX0+
B17	Reserved	A17	RX0-
B18	DETECT#	A18	GND
B19	TX1+	A19	CONFIG1
B20	TX1-	A20	GND
B21	GND	A21	RX1+
B22	GND	A22	RX1-
B23	TX2+	A23	GND
B24	TX2-	A24	GND
B25	GND	A25	RX2+
B26	GND	A26	RX2-
B27	TX3+	A27	GND
B28	TX3-	A28	GND
B29	GND	A29	RX3+
B30	Reserved	A30	RX3-
B31	Reserved	A31	GND
B32	GND	A32	CONFIG2
B33	TX4+	A33	Reserved
B34	TX4-	A34	GND
B35	GND	A35	RX4+
B36	GND	A36	RX4-
B37	TX5+	A37	GND
B38	TX5-	A38	GND
B39	GND	A39	RX5+
B40	GND	A40	RX5-
B41	TX6+	A41	GND
B42	TX6-	A42	GND
B43	GND	A43	RX6+
B44	GND	A44	RX6-
B45	TX7+	A45	GND
B46	TX7-	A46	GND
B47	GND	A47	RX7+
B48	Reserved	A48	RX7-
B49	GND	A49	GND
B50	TX8+	A50	Reserved
B51	TX8-	A51	GND
B52	GND	A52	RX8+
B53	GND	A53	RX8-
B54	TX9+	A54	GND

B55	TX9-	A55	GND
B56	GND	A56	RX9+
B57	GND	A57	RX9-
B58	TX10+	A58	GND
B59	TX10-	A59	GND
B60	GND	A60	RX10+
B61	GND	A61	RX10-
B62	TX11+	A62	GND
B63	TX11-	A63	GND
B64	GND	A64	RX11+
B65	GND	A65	RX11-
B66	TX12+	A66	GND
B67	TX12-	A67	GND
B68	GND	A68	RX12+
B69	GND	A69	RX12-
B70	TX13+	A70	GND
B71	TX13-	A71	GND
B72	GND	A72	RX13+
B73	GND	A73	RX13-
B74	TX14+	A74	GND
B75	TX14-	A75	GND
B76	GND	A76	RX14+
B77	GND	A77	RX14-
B78	TX15+	A78	GND
B79	TX15-	A79	GND
B80	GND	A80	RX15+
B81	Reserved	A81	RX15-
B82	Reserved	A82	GND

## A.29 SPI BIOS Flash Socket (SPI1)

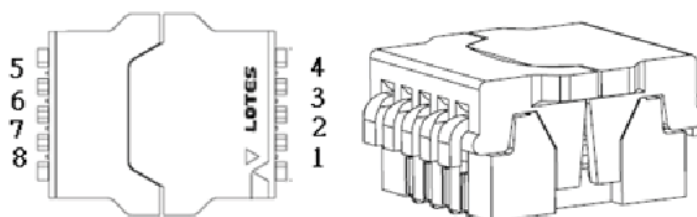

Pin	Signal	Pin	Signal
1	CS#	5	MOSI
2	MISO	6	SCK
3	WP# / IO2	7	HOLD# / IO3
4	GND	8	+3.3V

## A.30 COM6 ~ COM9 Box Header (COM6789)

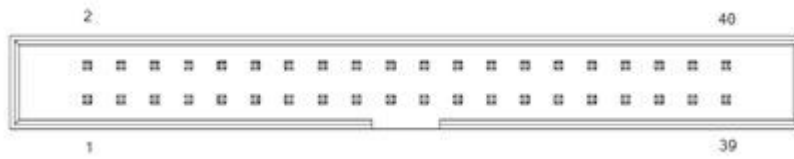

Pin	Signal	Pin	Signal
1	DCD# [6]	2	DSR# [6]
3	RXD [6]	4	RST# [6]
5	TXD [6]	6	CTS# [6]
7	DTR# [6]	8	RI [6]
9	GND	10	GND
11	DCD# [7]	12	DSR# [7]
13	RXD [7]	14	RST# [7]
15	TXD [7]	16	CTS# [7]
17	DTR# [7]	18	RI [7]
19	GND	20	GND
21	DCD# [8]	22	DSR# [8]
23	RXD [8]	24	RST# [8]
25	TXD [8]	26	CTS# [8]
27	DTR# [8]	28	RI [8]
29	GND	30	GND
31	DCD# [9]	32	DSR# [9]
33	RXD [9]	34	RST# [9]
35	TXD [9]	36	CTS# [9]
37	DTR# [9]	38	RI [9]
39	GND	40	GND

## A.31 LGA 1150 CPU Socket (CPU1)

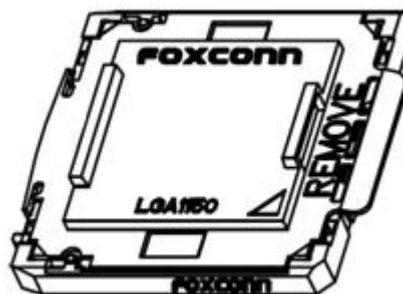

### A.32 Dual Port USB2.0 Pin Header (USB78)

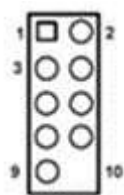

Pin	Signal	Pin	Signal
1	+5V	2	+5V
3	D0-	4	D1-
5	D0+	6	D1+
7	GND	8	GND
9	NC	10	X

### A.33 Dual Port USB2.0 Pin Header (USB56)

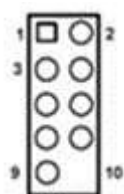

Pin	Signal	Pin	Signal
1	+5V	2	+5V
3	D0-	4	D1-
5	D0+	6	D1+
7	GND	8	GND
9	NC	10	X

### A.34 Watchdog Timer Output and OBS Beep (JWDT1+JOBS1)



Pin	Signal
1	NC
2	WDT
3	RESET#
4	SIO BEEP
5	FRP BEEP

## A.35 AT/ATX Mode Selection (PSON1)

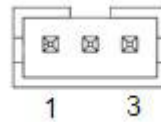

Pin	Signal
1	VCCAT
2	+3.3V
3	VCCATX

## A.36 ATX Power Supply Connector (ATXPWR1)

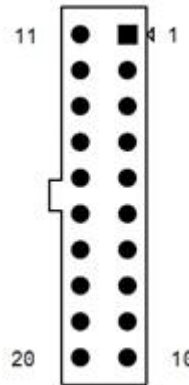

Pin	Signal	Pin	Signal
1	+3.3V	11	+3.3V
2	+3.3V	12	-12V
3	GND	13	GND
4	+5V	14	PSON#
5	GND	15	GND
6	+5V	16	GND
7	GND	17	GND
8	POWER_OK	18	-5V
9	+5VSB	19	+5V
10	+12V	20	+5V

### A.37 CMOS Battery Wafer Box (BAT1)

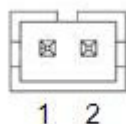

Pin	Signal
1	BAT VCC
2	GND

### A.38 CMOS Mode Selection (JCMOS1)

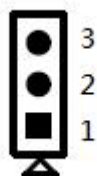

Pin	Signal
1	NC
2	RTC RESET#
2	GND

### A.39 Power LED and Keyboard Lock Pin Header (JFP2)



Pin	Signal
1	LED Power
2	NC
3	GND
4	Keyboard LOCK#
5	GND

## A.40 Power Switch/HDD LED/SMBus/Speaker Pin Header (JFP1)



Pin	Signal	Pin	Signal
1	+5V	2	HDD LED+
3	Power Button+	4	NC
5	HDD LED-	6	Power Button-
7	SPK_P3	8	SMB_DATA
9	System Reset+	10	SPK_P4
11	SMB_CLK	12	System Reset-

## A.41 CPU FAN Connector (CPUFAN1)



Pin	Signal
1	GND
2	+12V
3	DETECT
4	PWM IN

## A.42 System Fan1 Connector (SYSFAN1)

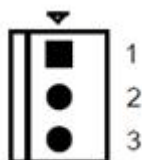

Pin	Signal
1	GND
2	FAN POWER
3	DETECT



## A.43 System Fan2 Connector (SYSFAN2)

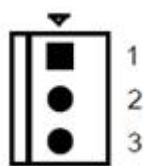

Pin	Signal
1	GND
2	FAN POWER
3	DETECT

## A.44 SIM Card Holder (SIM2)



Pin	Signal
1	UIM_PWR
2	UIM_RESET
3	UIM_CLK
4	Reserved
5	GND
6	UIM_VPP
7	UIM_DATA
8	Reserved

**ADVANTECH**

*Enabling an Intelligent Planet*

**[www.advantech.com](http://www.advantech.com)**

Please verify specifications before quoting. This guide is intended for reference purposes only.

All product specifications are subject to change without notice.

No part of this publication may be reproduced in any form or by any means, electronic, photocopying, recording or otherwise, without prior written permission of the publisher.

All brand and product names are trademarks or registered trademarks of their respective companies.

© Advantech Co., Ltd. 2016