



User Manual

AIMB-230

Intel® Core™ Celeron 2980U / i3-4010U / i5-4300U / i7-4650U Mini-ITX with eDP/DP/DP++, 2 COM, and Dual LAN

ADVANTECH

Enabling an Intelligent Planet

Copyright

The documentation and the software included with this product are copyrighted 2015 by Advantech Co., Ltd. All rights are reserved. Advantech Co., Ltd. reserves the right to make improvements in the products described in this manual at any time without notice.

No part of this manual may be reproduced, copied, translated or transmitted in any form or by any means without the prior written permission of Advantech Co., Ltd. Information provided in this manual is intended to be accurate and reliable. However, Advantech Co., Ltd. assumes no responsibility for its use, nor for any infringements of the rights of third parties, which may result from its use.

Acknowledgements

AMI is a trademark of Phoenix Technologies Ltd.

IBM and PC are trademarks of International Business Machines Corporation.

Intel® Core™ i7/i5/i3 Celeron® is trademark of Intel Corporation

WinBond is a trademark of Winbond Corporation.

All other product names or trademarks are properties of their respective owners.

A Message to the Customer

Advantech Customer Services

Each and every Advantech product is built to the most exacting specifications to ensure reliable performance in the harsh and demanding conditions typical of industrial environments. Whether your new Advantech equipment is destined for the laboratory or the factory floor, you can be assured that your product will provide the reliability and ease of operation for which the name Advantech has come to be known.

Your satisfaction is our primary concern. Here is a guide to Advantech's customer services. To ensure you get the full benefit of our services, please follow the instructions below carefully.

Technical Support

We want you to get the maximum performance from your products. So if you run into technical difficulties, we are here to help. For the most frequently asked questions, you can easily find answers in your product documentation. These answers are normally a lot more detailed than the ones we can give over the phone.

So please consult this manual first. If you still cannot find the answer, gather all the information or questions that apply to your problem, and with the product close at hand, call your dealer. Our dealers are well trained and ready to give you the support you need to get the most from your Advantech products. In fact, most problems reported are minor and are able to be easily solved over the phone.

In addition, free technical support is available from Advantech engineers every business day. We are always ready to give advice on application requirements or specific information on the installation and operation of any of our products.

Declaration of Conformity

FCC Class B

This device complies with the requirements in part 15 of the FCC rules:

Operation is subject to the following two conditions:

- This device may not cause harmful interference
- This device must accept any interference received, including interference that may cause undesired operation.

This equipment has been tested and found to comply with the limits for a Class B digital device, pursuant to Part 15 of the FCC Rules. These limits are designed to provide reasonable protection against harmful interference when the equipment is operated in a commercial environment. This equipment generates, uses, and can radiate radio frequency energy and, if not installed and used in accordance with the instruction manual, may cause harmful interference to radio communications. Operation of this device in a residential area is likely to cause harmful interference in which case the user will be required to correct the interference at his/her own expense. The user is advised that any equipment changes or modifications not expressly approved by the party responsible for compliance would void the compliance to FCC regulations and therefore, the user's authority to operate the equipment.

Caution! *There is a danger of a new battery exploding if it is incorrectly installed. Do not attempt to recharge, force open, or heat the battery. Replace the battery only with the same or equivalent type recommended by the manufacturer. Discard used batteries according to the manufacturer's instructions.*



Memory Compatibility

Test Item	Description						Result	Remark
Brand	Size	Speed	Type	ECC	Vendor PN	Memory		
DSL	2GB	DDR3 1600	SODIMM DDR3	N	D3SS5608 1XH12AA	SEC 113 HCK0 K4B2G0846C (256x8)	PASS	
DSL	4GB	DDR3 1600	SODIMM DDR3	N	D3SS5608 2XH12AA	SEC 113 HCK0 K4B2G0846C (256x8)	PASS	
Transcend	2GB	DDR3 1600	SODIMM DDR3	N	TS256MS K64V6N	MICRON IVM77 D9PFJ	PASS	
Transcend	4GB	DDR3 1600	SODIMM DDR3	N	TS512MS K64N6N	MICRON IRM72 D9PFJ	PASS	

Ordering Information

Order Number	CPU	Display	GbE	TPM	Storage	USB	PCIe/PCI
AIMB-230G2-U5A1E	i5-4300U						
AIMB-230G2-U0A1E	Celeron 2980U	DP/HDMI, DP++/DVI/ HDMI, LVDS/eDP (optional)	2	Yes (optional)	3 x SATA III 1 x mSATA	4 x USB3.0 2 x USB2.0	1 x Full-size Mini-PCIe
AIMB-230G2-U3A1E	i3-4010U						
AIMB-230G2-U7A1E	i7-4650U						

Order Number	CPU	Display	GbE	COM	USB	Audio	Remark
AIMB-B12305-00Y1E	i5-4300U						
AIMB-B12300-00Y1E	Celeron 2980U	DP/HDMI, DP++/DVI/ HDMI	2	2	4 x USB3.0 2 x USB2.0	Line Out Mic-In	Barebone, with thermal module
AIMB-B12303-00Y1E	i3-4010U						
AIMB-B12307-00Y1E	i7-4650U						

Product Warranty (2 years)

Advantech warrants to you, the original purchaser, that each of its products will be free from defects in materials and workmanship for two years from the date of purchase.

This warranty does not apply to any products which have been repaired or altered by persons other than repair personnel authorized by Advantech, or which have been subject to misuse, abuse, accident or improper installation. Advantech assumes no liability under the terms of this warranty as a consequence of such events.

Because of Advantech's high quality-control standards and rigorous testing, most of our customers never need to use our repair service. If an Advantech product is defective, it will be repaired or replaced at no charge during the warranty period. For out-of-warranty repairs, you will be billed according to the cost of replacement materials, service time and freight. Please consult your dealer for more details.

If you think you have a defective product, follow these steps:

1. Collect all the information about the problem encountered. (For example, CPU speed, Advantech products used, other hardware and software used, etc.) Note anything abnormal and list any onscreen messages you get when the problem occurs.
2. Call your dealer and describe the problem. Please have your manual, product, and any helpful information readily available.
3. If your product is diagnosed as defective, obtain an RMA (return merchandise authorization) number from your dealer. This allows us to process your return more quickly.
4. Carefully pack the defective product, a fully-completed Repair and Replacement Order Card and a photocopy proof of purchase date (such as your sales receipt) in a shippable container. A product returned without proof of the purchase date is not eligible for warranty service.
5. Write the RMA number visibly on the outside of the package and ship it prepaid to your dealer.

Initial Inspection

Before you begin installing your motherboard, please make sure that the following materials have been shipped:

- 1 x AIMB-230 mini-ITX Motherboard
- 2 x SATA HDD cable
- 2 x SATA Power cable
- 1 x CPU Fanless Heat Sink
- 1 x Startup manual
- 1 x Driver CD
- 1 x Warranty card

If any of these items are missing or damaged, contact your distributor or sales representative immediately. We have carefully inspected the AIMB-230 mechanically and electrically before shipment. It should be free of marks and scratches and in perfect working order upon receipt. As you unpack the AIMB-230, check it for signs of shipping damage. (For example, damaged box, scratches, dents, etc.) If it is damaged or it fails to meet the specifications, notify our service department or your local sales representative immediately. Also notify the carrier. Retain the shipping carton and packing material for inspection by the carrier. After inspection, we will make arrangements to repair or replace the unit.

Contents

Chapter 1 General Information1

1.1	Introduction	2
1.2	Features	2
1.3	Specifications	2
1.3.1	System	2
1.3.2	Memory	2
1.3.3	Input/Output	2
1.3.4	Graphics.....	3
1.3.5	Ethernet LAN	3
1.3.6	Industrial features	3
1.3.7	Mechanical and environmental specifications.....	3
1.4	Jumpers and Connectors	4
	Table 1.1: Jumpers.....	4
	Table 1.2: Connectors	4
1.5	Board layout: Jumper and Connector Locations	6
	Figure 1.1 Jumper and Connector Location	6
1.6	AIMB-230 Board Diagram	7
	Figure 1.2 AIMB-230 Board Diagram	7
1.7	Safety Precautions	8
1.8	Jumper Settings	8
1.8.1	How to Set Jumpers.....	8
1.8.2	CMOS Clear (CMOS1)	9
	Table 1.3: CMOS1	9
1.8.3	JLVDS1 / JLVDS2: LCD Power 3.3 V/5 V/ 12 V Selector.....	9
	Table 1.4: JLVDS1/JLVDS2: LCD Power 3.3 V/5 V/ 12 V Selector	9
1.8.4	JVBR1: Backlight control selector for LVDS1	10
	Table 1.5: JVBR1: Backlight Control Selector for LVDS1	10
1.8.5	PSON1: ATX, AT Mode Selector	10
	Table 1.6: PSON1: ATX, AT Mode Selector.....	10
1.8.6	JWDT1+JOBS1: Watchdog Timer Output and OBS Alarm Option.	10
	Table 1.7: JWDT1+JOBS1: Watchdog Timer Output and OBS	10
	Alarm Option.....	10
1.9	System Memory	11
1.10	Memory Installation Procedures.....	11
1.11	Cache Memory.....	11

Chapter 2 Connecting Peripherals13

2.1	Introduction	14
2.2	LAN Ports and USB Ports (LAN1, LAN2, USB12, USB34, USB56)	14
	Table 2.1: LAN LED Indicator.....	14
2.3	DP/HDMI and DP++ Connector (DP-HDMI1/DP1).....	15
2.4	Serial Ports (COM1~COM2)	16
2.5	PS/2 Keyboard and Mouse Connector (KBMS1)	17
2.6	CPU Fan Connector (CPU_FAN1).....	17
2.7	System FAN Connector (SYSFAN1).....	18
2.8	Front Panel Connectors (JFP1/JFP2)	19
2.8.1	ATX soft power switch ((JFP1/PWR_BTN)).....	19
2.8.2	Reset (JFP1/RST_BTN)	19
2.8.3	HDD LED (JFP2/HDD_LED).....	19
2.8.4	External speaker (JFP2/SPEAKER)	19
2.8.5	Power LED and keyboard lock connector (JFP3/PWR_LED & KEY	19

	LOCK).....	20
	Table 2.2: ATX power supply LED status (No support for AT power)	20
2.9	Line Out, Mic In Connector (AUDIO1/AUDIO2).....	20
2.10	Digital Audio Connector (SPDIF_O1).....	21
2.11	Serial ATA Interface (SATA1 ~ SATA3/SATA_PWR1 ~ SATA_PWR3).....	21
2.12	SATA power connector(SATA_PWR1~3).....	22
2.13	Full / Half Size Mini PCI Express Slot.....	22
2.14	Front Headphone Connector (FP_AUDIO1).....	23
2.15	ATX 12V/DCIN 12V/5V SB Input Power Connector (ATX12V1/DCIN1).....	24
2.16	SPI Flash Connector(SPI_CN1).....	25
2.17	LCD Inverter Connector (INV1).....	26
2.18	LVDS Connector (LVDS1).....	27
2.19	General Purpose I/O Connector (GPIO1).....	27
Chapter 3	BIOS Operation	29
3.1	Introduction	30
3.2	BIOS Setup.....	30
3.2.1	Main Menu.....	31
3.2.2	Advanced BIOS Features.....	32
3.2.3	Chipset.....	45
3.2.4	Boot.....	52
3.2.5	Security.....	53
3.2.6	Save & Exit.....	54
Chapter 4	Software Introduction & Service	55
4.1	Introduction	56
4.2	Value-Added Software Services	56
4.2.1	Software API.....	56
4.2.2	Software Utility.....	58
Chapter 5	Chipset Software Installation Utility	59
5.1	Before You Begin.....	60
5.2	Introduction	60
5.3	Windows 7 Driver Setup	61
Chapter 6	VGA Setup	63
6.1	Introduction	64
6.2	Windows 7	64
Chapter 7	LAN Configuration	67
7.1	Introduction	68
7.2	Features.....	68
7.3	Installation.....	68
7.4	Windows® 7 Driver Setup (Realtek RTL8111E).....	69
Appendix A	I/O Pin Assignments	71
A.1	USB Header (USB56).....	72
	Table A.1: USB Header (USB56)	72

A.2	DP/HDMI Connector (DP-HDMI1).....	72
	Table A.2: DP/HDMI Connector (DP-HDMI1).....	72
A.3	DP Connector.....	73
	Table A.3: DP Connector.....	73
A.4	SPI_CN1: SPI Fresh Card Pin Connector.....	73
	Table A.4: SPI_CN1:SPI Fresh Card Pin Connector.....	73
A.5	PS/2 Keyboard and Mouse Connector (KBMS1).....	74
	Table A.5: PS/2 Keyboard and Mouse Connector (KBMS1).....	74
A.6	CPU Fan Power Connector (CPUFAN1/CPUFAN1_1).....	74
	Table A.6: CPU Fan Power Connector (CPUFAN1/CPUFAN1_1).....	74
A.7	CPU Fan Speed Control (JCPUFAN1).....	74
	Table A.7: CPU Fan Speed Control (JCPUFAN1).....	74
A.8	System Fan Power Connector (SYS_FAN1).....	75
	Table A.8: System Fan Power Connector (SYSFAN1).....	75
A.9	System Fan Speed Control (JSYSFAN1).....	75
	Table A.9: CPU Fan Speed Control (JCPUFAN1).....	75
A.10	Power LED & Keyboard Lock Connector (JFP3).....	75
	Table A.10:Power LED & Keyboard Lock Connector (JFP2).....	75
A.11	Power Switch/Reset Switch/HDD LED/SMBus/Speaker (JFP1/JFP2) ...	76
	Table A.11:Power Switch/Reset Switch/HDD LED/SMBus/Speak- er (JFP1/JFP2).....	76
A.12	USB/LAN Ports (LAN1/LAN2/USB12/USB34).....	76
	Table A.12:USB Port.....	76
	Table A.13:Ethernet 10/100/1000 Mbps RJ-45 Port.....	76
A.13	Line Out, Mic In Connector (AUDIO1/AUDIO2).....	77
A.14	Serial ATA (SATA1 ~ 3).....	77
	Table A.14:Serial ATA 0/1 (SATA1/SATA2).....	77
A.15	AT/ATX Mode (PSON1).....	77
	Table A.15:AT/ATX Mode (PSON1).....	77
A.16	HD Audio Interface (FP_AUDIO1).....	77
	Table A.16:AC-97 Audio Interface (FPAUD1).....	77
A.17	GPIO Pin Header (GPIO1).....	78
	Table A.17:GPIO Pin Header (GPIO1).....	78
A.18	LVDS Connector: LVDS1.....	78
	Table A.18:LVDS Connector: LVDS1.....	78
A.19	LVDS Power Jumper (JLVDS1/JLVDS2).....	79
A.20	LVDS Inverter (INV1).....	79
	Table A.19:LVDS Power Jumper.....	79
A.21	LVDS Backlight control (JVBR1).....	80
	Table A.20:LVDS Backlight control(JVBR1).....	80
A.22	ATX12V/12V DC IN (ATX12V1/DCIN1).....	80
	Table A.21:ATX 12 V connector (ATX12V1).....	80
A.23	HD Digital Audio Interface (SPDIF_O1).....	80
	Table A.22:HD Digital Audio Interface (SPDIF_OUT1).....	80
A.24	Amplifier Audio Output (AMPJ1).....	81
	Table A.23:Amplifier Audio Output (AMPJ1).....	81
A.25	COM1 Protocols Selection (JSETCOM1).....	81
	Table A.24:COM1 Protocol Selection (JSETCOM1).....	81
A.26	COM1/COM2 Box Header (COM1/COM2).....	82
	Table A.25:COM1/COM2 Box Header (COM1/COM2).....	82
A.27	COM1 RS422/485 Master or Slave Selection (COM1_S1~S4).....	82
	Table A.26:COM1 RS422/485 Master or Slave Selection (COM1_S1~S4).....	82
A.28	Watch dog and Open chassis alarm (JWDT1+JOBS1).....	83
	Table A.27:Watchdog and Open Chassis Alarm (JWDT1+JOBS1) 83	
A.29	Low Pin Count Bus (LPC1).....	83
	Table A.28:Low Pin Count Bus (LPC1).....	83

Chapter 1

General Information

1.1 Introduction

AIMB-230 is designed with the Intel® HASWELL ULT Dual Core for industrial applications that require both performance computing and enhanced power management capabilities. The motherboard supports Intel HASWELL ULT Dual Core i5 1.9 GHz / Celeron 1.6GHz processor up to 3 MB L3 cache and DDR3L SO-DIMM 1600 up to 16GB. A rich I/O connectivity of 2 serial ports, 4 USB 3.0, 2 USB 2.0, dual GbE LAN and 3 SATA III ports.

1.2 Features

- **Rich I/O connectivity:** 2 serial ports, 4 USB 3.0, 2 USB 2.0, 3 SATA 3.0, 1 mSATA, Dual GbE LAN
- **Standard Mini-ITX form factor with industrial feature:** The AIMB-230 is a full-featured Mini-ITX motherboard with balanced expandability and performance
- **Wide selection of storage devices:** SATA HDD, customers benefit from the flexibility of using the most suitable storage device for larger capacity
- **Optimized integrated graphic solution:** With Intel® Graphics Flexible, it supports versatile display options and 32-bit 3D graphics engine

1.3 Specifications

1.3.1 System

- **CPU:** BGA 1168 (MCP) 22nm Processor / Intel HASWELL ULT Dual Core i5 / Celeron processor
- **BIOS:** AMI EFI 16 Mbit SPI BIOS
- **System chipset:** Intel® Lynx Point-LP
- **SATA hard disk drive interface:**
 - Three on-board SATA connectors with data transmission rate up to 600 MB
- **mSATA Interface:** Supports mSATA slot

1.3.2 Memory

- **RAM:** Up to 16 GB in 2 slots 204-pin SODIMM sockets. Supports dual channel DDR3L 1600 MHz SDRAM

1.3.3 Input/Output

- **Serial ports:** Two serial ports, COM 1 support RS-232/422/485 +5 V, +12 V (without H/W auto flow control)
- **Keyboard and PS/2 mouse connector:** Supports PS/2 K/S,M/S with 5-pin wafer
- **USB port:** Supports up to six USB ports with transmission rate up to 625 MB, 2 on board pin header with USB 2.0 and 4 external ports with USB 3.0
- **GPIO connector:** 8-bit general purpose Input/Output

1.3.4 Graphics

- **Controller:** Intel® HD Graphics 5000 Support DirectX 11.1, OpenGL 4.0, OpenCL 1.3, Full AVC, VC1, MPEG2 H/W encoder
- **LVDS:** Through Chrontel CH7511 to support LVDS Support single channel 24-bit/ dual channel 48-bit LVDS, Max 1920 x 1200 @ 60 Hz
- **HDMI:** Supports HDMI 1.4 for HD Video playback Max resolution up to 4096 x 2304 at 24 Hz on HDMI
- **Display port:** Supports Display port up to resolution 3200 x 2000

:

Note! *Triple independent display need to use DP+LVDS+HDMI, HDMI + HDMI + DP, DP + DP + eDP, HDMI + DP + eDP*



1.3.5 Ethernet LAN

- Supports dual 10/100/1000 Mbps Ethernet port (s) via PCI Express x1 bus which provides 500 MB/s data transmission rate
- **Controller:** LAN1: Realtek RTL8111E; LAN2: Realtek RTL8111E

1.3.6 Industrial features

- **Watchdog timer:** Can generate a system reset. The watchdog timer is programmable, with each unit equal to one second or one minute (255 levels)

1.3.7 Mechanical and environmental specifications

- **Operating temperature:** 0 ~ 60° C (32 ~ 140° F, Depending on CPU speed and cooler solution)
- **Storage temperature:** -40 ~ 85° C (-40 ~ 185° F)
- **Humidity:** 5 ~ 95% non-condensing
- **Power supply voltage:** +12 V
- **Power consumption:** TBD
Measure the maximum current value which system under maximum load (CPU: Top speed, RAM & Graphic: Full loading)
- **Board size:** 170 mm x 170 mm (6.69" x 6.69")
- **Board weight:** 0.365 kg

1.4 Jumpers and Connectors

Connectors on the AIMB-230 motherboard link it to devices such as hard disk drives and a keyboard. In addition, the board has a number of jumpers used to configure your system for your application.

The tables below list the function of each of the board jumpers and connectors. Later sections in this chapter give instructions on setting jumpers. Chapter 2 gives instructions for connecting external devices to your motherboard.

Table 1.1: Jumpers

Label	Function
JFP1	Power switch/Reset switch
JFP2	HDD LED/SMBus/Speaker
JFP3	Power LED / Keyboard lock
CMOS1	CMOS clear (Default 1-2)
PSON1	AT(1-2) / ATX(2-3) (Default 2-3)
JWDT1+JOBS1	Watchdog Reset and OBS Alarm
JLVDS1	Voltage 0V/12V selector for LVDS1 connector (Default none, 0V)
JLVDS2	Voltage 3.3V/5V selector for LVDS2 connector (Default 1-2,3.3V)
VCON1	Panel selection (Default 1, 3.3V)
JVBR1	Brightness control selector for Analog or Digital (Default 1-2, Linear)
JCOM1	COM1 5V/12V selector (Default 1-2, RI)
JSETCOM1	RS232/RS485/RS422 selector (Default 5-6,7-9,8-10,13-15,14-16)
COM1_S1~S4	RS422/485 master or slave selection (Default 1-2 Slave)
JCPUFAN1,JSYSFAN1	FAN control by DC or PWM mode selection (Default 2-3)

Note! *JLVDS1 and JLVDS2 can't be used at the same time, or else M/B would be damaged.*



Table 1.2: Connectors

Label	Function
LVDS1	LVDS1 connector
INV1	LVDS1 inverter connector
USB12	USB port 1, 2 connector
USB34	USB port 3, 4 connector
USB56	USB port 5, 6 (on board)
DP-HDMI1	DP / HDMI connector
DP1	DP++ connector
EDP1	eDP connector (Optional)
COM1, 2	Serial port connector (RS232); COM1: RS232/RS485/RS422 supports +5,+12V,COM2: RS232
KBMS1	PS/2 Keyboard and Mouse connector
CPUFAN1	CPU FAN 2.54mm connector (4-pin)
CPUFAN1_1	CPU FAN1 2.00mm connector (4-pin)
SYSFAN1	System FAN1 2.54mm connector (4-pin)

Table 1.2: Connectors	
LAN1, LAN2	LAN1 / LAN2
USB12, USB34	USB 3.0 1, 2 / USB 3.0 3, 4
AUDIO1, 2	Audio connector
SPDIF_O1	SPDIF Audio out pin header
FP_AUDIO1	HD Audio Front Panel Pin Header
ATX_5V1	ATX power supply shutdown and wake up
SATA1	Serial ATA data connector 1
SATA2	Serial ATA data connector 2
SATA3	Serial ATA data connector 3
SATA_PWR1	Serial ATA power connector 1
SATA_PWR2	Serial ATA power connector 2
SATA_PWR3	Serial ATA power connector 3
DIMMA1	Memory connector channel
DIMMB1	Memory connector channel
LPC1	Low Pin Count Header
GPIO1	GPIO header
BAT1	Battery connector
ATX12V1, ATX12V2	ATX 12V Main power connector
DCIN1	DC jack 12V Main power connector
COM1, 2	COM port
LANLED1	LAN1 status connector
AMPJ1	Amplifier connector
EDP1	eDP connector
DP-HDMI1	Display port and HDMI connector
DP1	Display Port connector
MINI_PCIE1	Full-sized Mini PCI Express x 1 slot / mSATA X 1 Slot
MINI_PCIE2	Half-sized Mini PCI Express x 1

1.5 Board layout: Jumper and Connector Locations

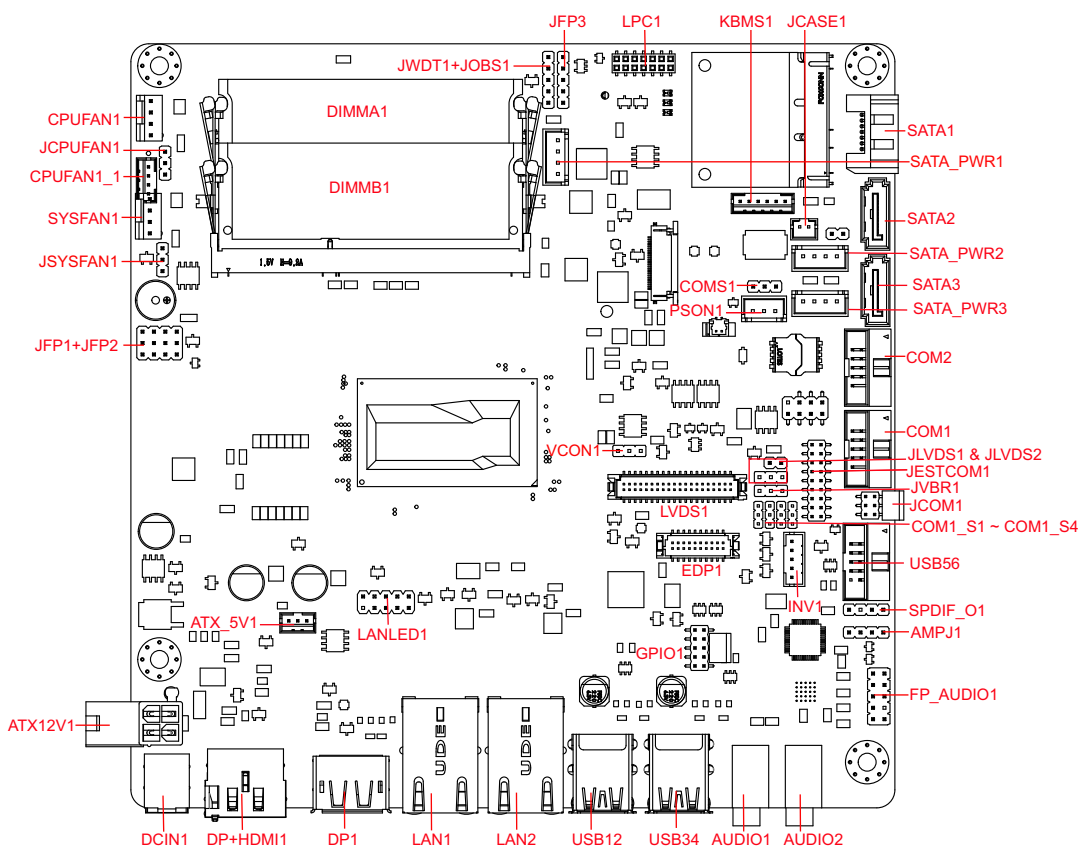

Figure 1.1 Jumper and Connector Location

1.6 AIMB-230 Board Diagram

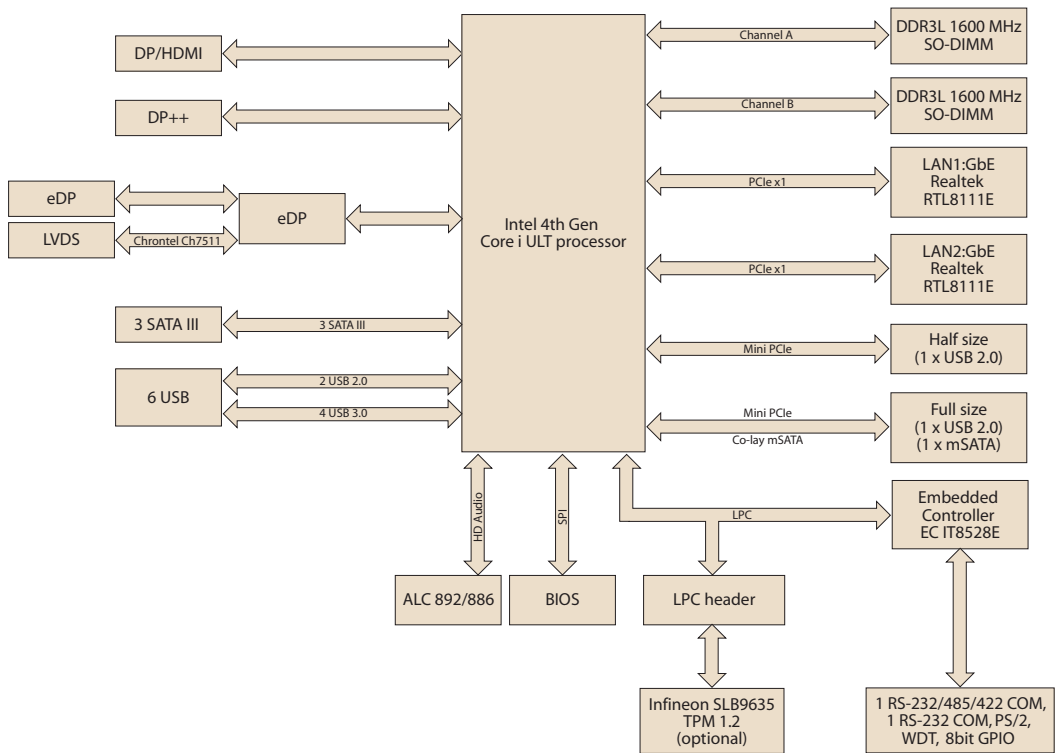

Figure 1.2 AIMB-230 Board Diagram

1.7 Safety Precautions

Warning! *Always completely disconnect the power cord from chassis whenever you work with the hardware. Do not make connections while the power is on. Sensitive electronic components can be damaged by sudden power surges. Only experienced electronics personnel should open the PC chassis.*



Caution! *Always ground yourself to remove any static charge before touching the motherboard. Modern electronic devices are very sensitive to electrostatic discharges. As a safety precaution, use a grounding wrist strap at all times. Place all electronic components on a static-dissipative surface or in a static-shielded bag when they are not in the chassis.*



Caution! *The computer is provided with a battery-powered real-time clock circuit. There is a danger of explosion if battery is incorrectly replaced. Replace only with same or equivalent type recommended by the manufacturer. Discard used batteries according to manufacturer's instructions.*



Caution! *There is a danger of a new battery exploding if it is incorrectly installed. Do not attempt to recharge, force open, or heat the battery. Replace the battery only with the same or equivalent type recommended by the manufacturer. Discard used batteries according to the manufacturer's instructions.*



1.8 Jumper Settings

This section provides instructions on how to configure your motherboard by setting the jumpers. It also includes the motherboards's default settings and your options for each jumper.

1.8.1 How to Set Jumpers

You can configure your motherboard to match the needs of your application by setting the jumpers. A jumper is a metal bridge that closes an electrical circuit. It consists of two metal pins and a small metal clip (often protected by a plastic cover) that slides over the pins to connect them. To “close” (or turn ON) a jumper, you connect the pins with the clip. To “open” (or turn OFF) a jumper, you remove the clip. Sometimes a jumper consists of a set of three pins, labeled 1, 2, and 3. In this case you connect either pins 1 and 2, or 2 and 3. A pair of needle-nose pliers may be useful when setting jumpers.

1.8.2 CMOS Clear (CMOS1)

The AIMB-230 motherboard contains a jumper that can erase CMOS data and reset the system BIOS information. Normally this jumper should be set with pins 1-2 closed. If you want to reset the CMOS data, set CMOS1 to 2-3 closed for just a few seconds, and then move the jumper back to 1-2 closed. This procedure will reset the CMOS to its default setting.

Table 1.3: CMOS1

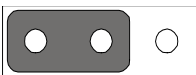
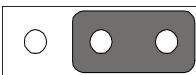
Function	Jumper Setting
*Keep CMOS data	 1-2 closed
Clear CMOS data	 2-3 closed

* Default

1.8.3 JLVDS1 / JLVDS2: LCD Power 3.3 V/5 V/ 12 V Selector

Table 1.4: JLVDS1/JLVDS2: LCD Power 3.3 V/5 V/ 12 V Selector

Closed Pins	Result
JLVDS1	
1-2	Jumper for 12 V LVDS panel
JLVDS2	
1-2	Jumper for 3.3 V LVDS panel*
2-3	Jumper for 5 V LVDS panel

*Default

Note! *JLVDS1 and JLVDS2 can't be used at the same time, or else M/B would be damaged.*

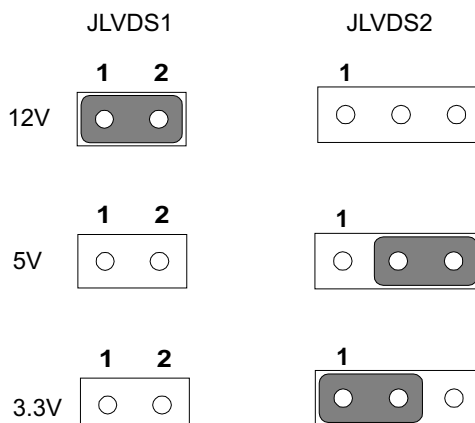

1.8.4 JVBR1: Backlight control selector for LVDS1

Table 1.5: JVBR1: Backlight Control Selector for LVDS1

Closed Pins	Result
1-2*	Linear brightness control
2-3	PWM brightness control

*Default

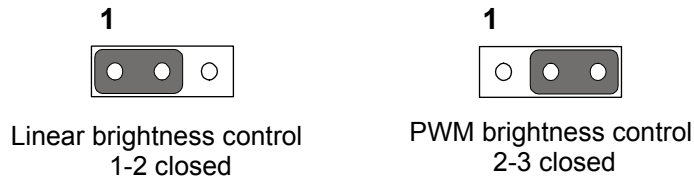

1.8.5 PS0N1: ATX, AT Mode Selector

Table 1.6: PS0N1: ATX, AT Mode Selector

Closed Pins	Result
1-2	AT Mode
2-3*	ATX Mode

*Default



1.8.6 JWDT1+JOBS1: Watchdog Timer Output and OBS Alarm Option

Table 1.7: JWDT1+JOBS1: Watchdog Timer Output and OBS Alarm Option

Closed Pins	Result
1-2	NC
2-3*	Watchdog Timer Output OBS_Beep
4-5*	Error Beep*

*Default

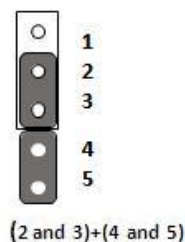

1.9 System Memory

The AIMB-230 has two sockets for a 204-pin DDR3L SODIMM. This socket uses a 3 V unbuffered double data rate synchronous DRAM (DDR SDRAM). DRAM is available in capacities of 1 GB, 2 GB, 4 GB and 8 GB. The sockets can be filled in any combination with SODIMMs of any size, giving a total memory size between 1 GB, 2 GB, 4 GB and 8 GB. AIMB-230 does NOT support ECC (error checking and correction).

1.10 Memory Installation Procedures

To install SODIMMs, first make sure the two handles of the SODIMM socket are in the “open” position, i.e., the handles lean outward. Slowly slide the SODIMM module along the plastic guides on both ends of the socket. Then firmly but gently (avoid pushing down too hard) press the SODIMM module well down into the socket, until you hear a click when the two handles have automatically locked the memory module into the correct position of the SODIMM socket. To remove the memory module, just push both handles outward, and the memory module will be ejected by the mechanism.

1.11 Cache Memory

The AIMB-230 supports a CPU with one of the following built-in full speed L3 caches:

3 MB for Intel Core i5-4300

2 MB for Intel Celeron

The built-in third-level cache in the processor yields much higher performance than conventional external cache memories.

Chapter 2

Connecting
Peripherals

2.1 Introduction

You can access most of the connectors from the top of the board as it is being installed in the chassis. If you have a number of cards installed or have a packed chassis, you may need to partially remove the card to make all the connections.

2.2 LAN Ports and USB Ports (LAN1, LAN2, USB12, USB34, USB56)

The AIMB-230 provides up to six USB ports. Four USB3.0 on the rear side and two-pin header on the board. The USB interface complies with USB Specification Rev. 2.0 and Rev. 3.0 supporting transmission rate up to 625 Mbps and is fuse protected. The USB interface can be disabled in the system BIOS setup.

The AIMB-230 is equipped with two high-performance 1000 Mbps Ethernet LAN adapter, both of which are supported by all major network operating systems. The RJ-45 jacks on the rear panel provide for convenient LAN connection.

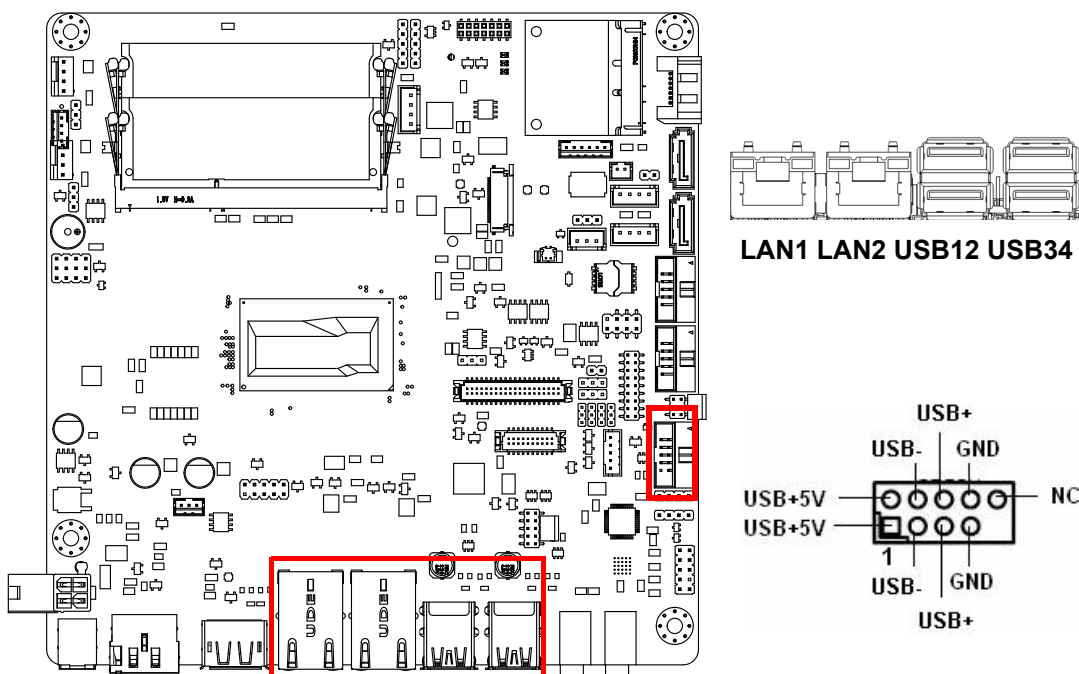

Table 2.1: LAN LED Indicator

LAN Mode	LAN Indicator	
LAN1 indicator	LED1 (Right)	off for mal-link; Link (On) / Active (Flash)
	LED2 (Left)	100 Mbps (On) / 10 Mbps (Off)
	LED2 (Left)	1000 Mbps (On)
LAN2 indicator	LED1 (Right)	off for mal-link; Link (On) / Active (Flash)
	LED2 (Left)	100 Mbps (On) / 10 Mbps (Off)
	LED2 (Left)	1000 Mbps (On)

Front Panel LAN LED(LANLED1)

		LANLED1	
LAN1 ACTLED- R	1	2	LAN2 ACTLED- R
+3.3V A LAN1	3	4	+3.3V A LAN2
LAN1 LED1000- R	5	6	LAN2 LED1000- R
LAN1 LED100-	7	8	LAN2 LED100-
+3.3V A LAN1	9		

2.3 DP/HDMI and DP++ Connector (DP-HDMI1/DP1)

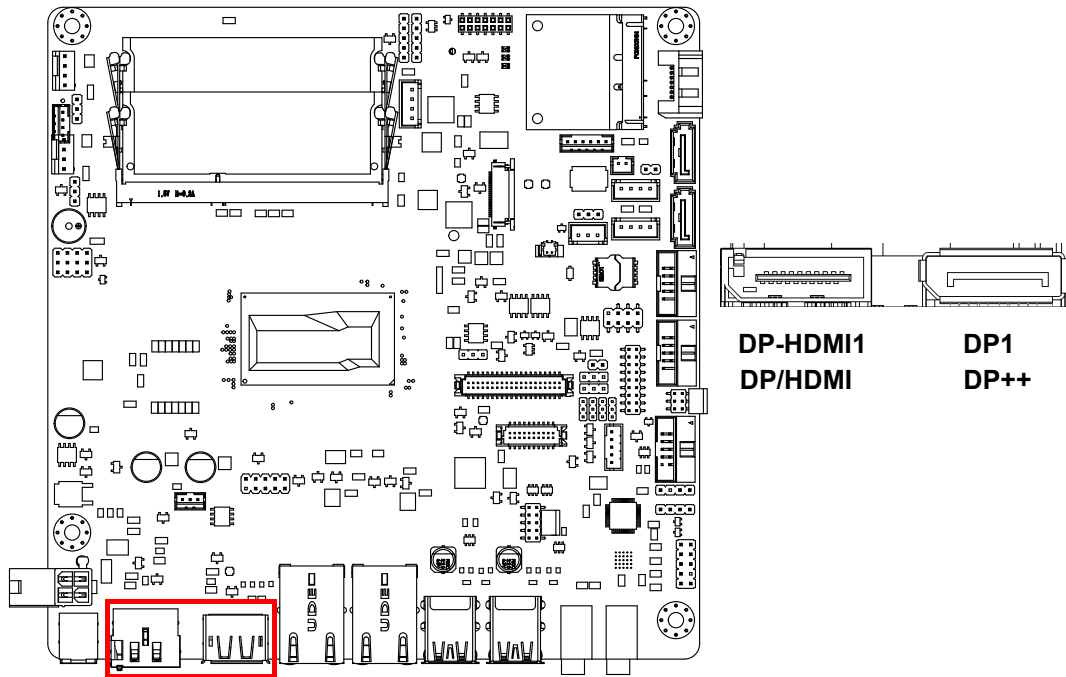

The AIMB-230 includes DP/HDMI and DP++ interface that can drive conventional DP/HDMI and DP++ displays. DP-HDMI1 is include DP and HDMI connector.

2.4 Serial Ports (COM1~COM2)

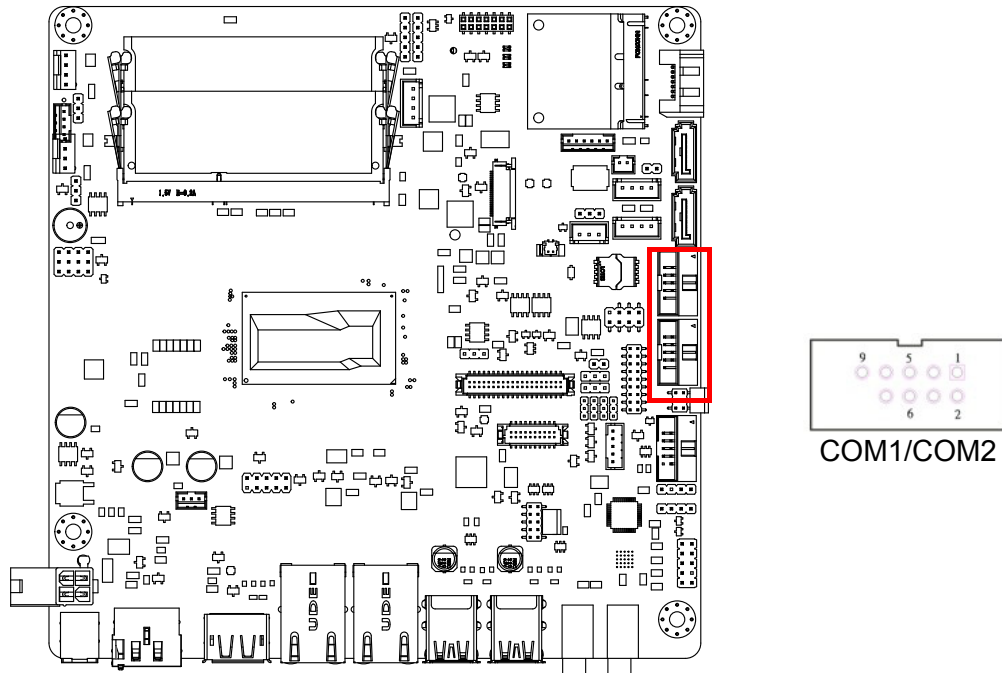

AIMB-230 supports two serial ports, and COM1 supports RS232/485/422 with 5V/12V selected via jumper. RS-485 has no H/W auto flow control function.

These ports can connect to serial devices, such as a mouse or a printer, or to a communications network.

The IRQ and address ranges for both ports are fixed. However, if you want to disable the port or change these parameters later, you can do this in the system BIOS setup.

Different devices implement the RS-232 standards in different ways. If you have problems with a serial device, be sure to check the pin assignments for the connector.

Serial Ports Voltage Select

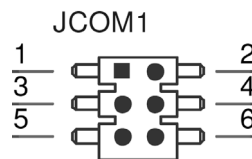

JCOM1: 1-2	5V
3-4*	0V
5-6	12V

2.5 PS/2 Keyboard and Mouse Connector (KBMS1)

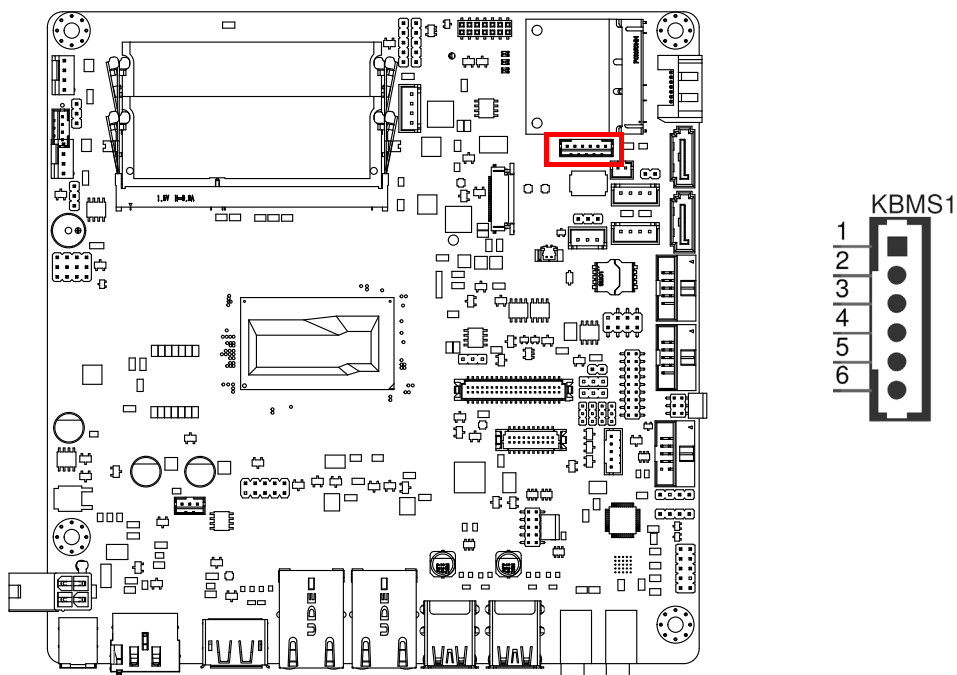

6-pin wafer box connectors (KBMS1) on the motherboard provide connection to a PS/2 keyboard and a PS/2 mouse, respectively.

2.6 CPU Fan Connector (CPU_FAN1)

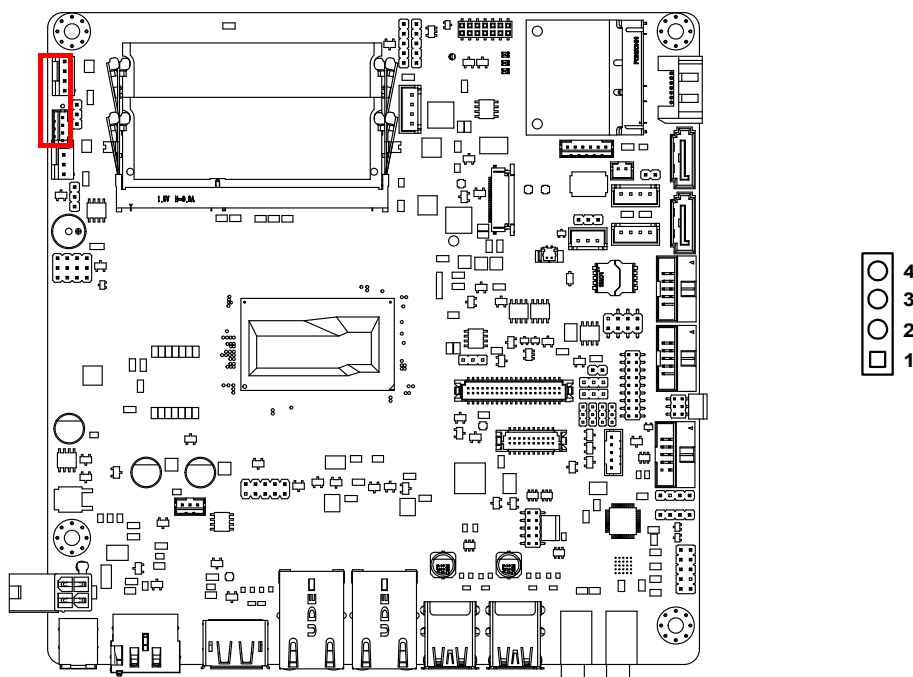

If a fan is used, this connector supports cooling fans of 500 mA (6 W) or less.

2.7 System FAN Connector (SYSFAN1)

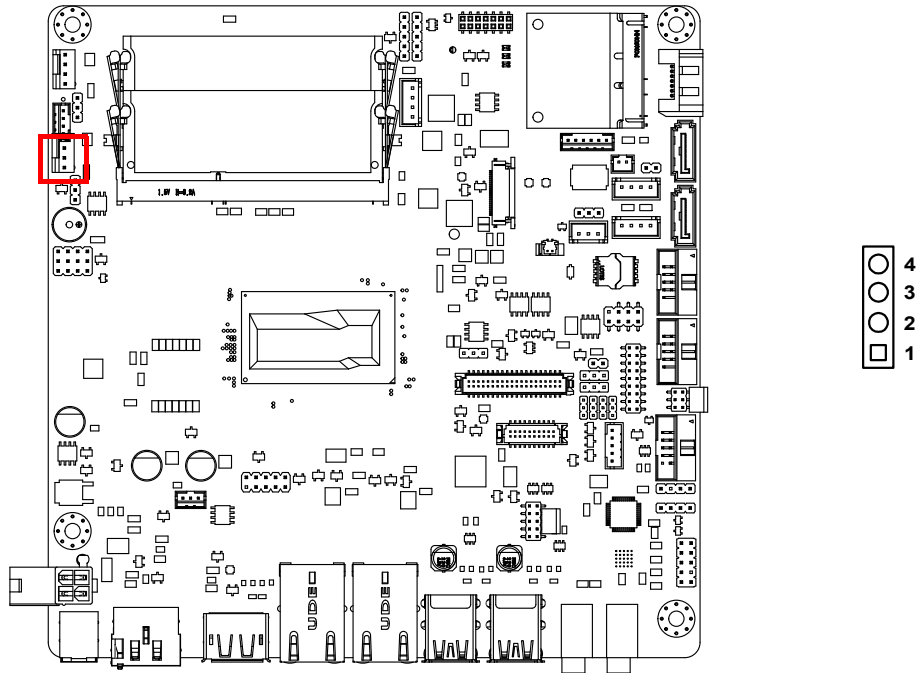

If a fan is used, this connector supports cooling fans of 500 mA (6 W) or less.

2.8 Front Panel Connectors (JFP1/JFP2)

There are several headers for monitoring and controlling the AIMB-230.

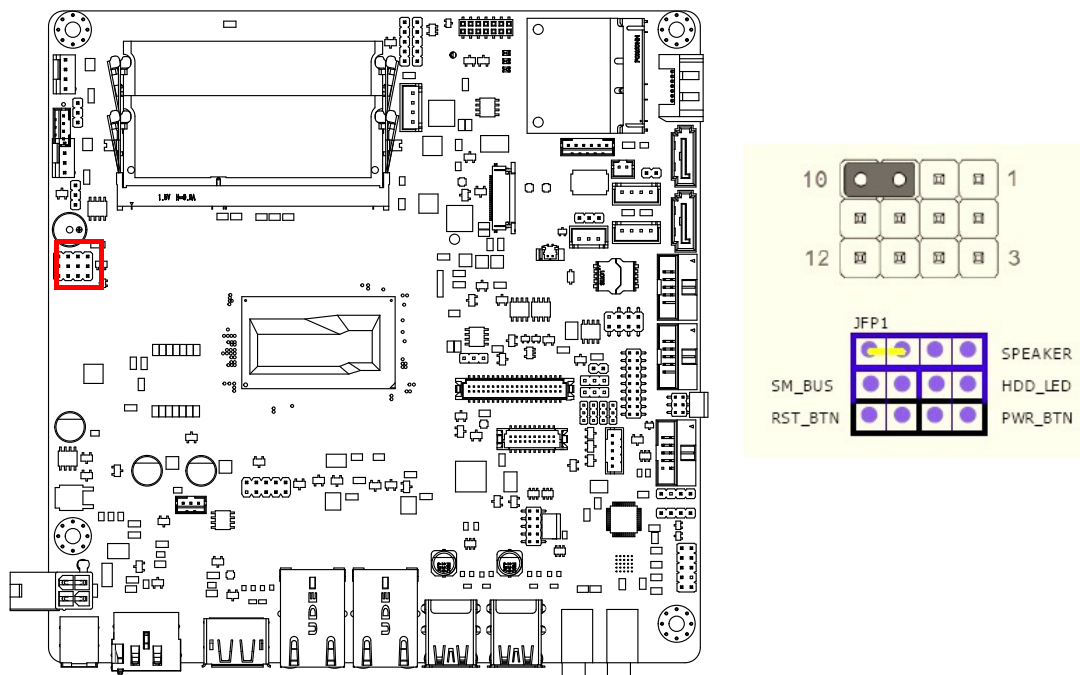

2.8.1 ATX soft power switch ((JFP1/PWR_BTN))

If your computer case is equipped with an ATX power supply, you should connect the power on/off button on your computer case to ((JFP1/ PWR_BTN)), for convenient power on and off.

2.8.2 Reset (JFP1/RST_BTN)

Many computer cases offer the convenience of a reset button. Connect the wire for the reset button.

2.8.3 HDD LED (JFP2/HDD_LED)

You can connect an LED to connector (JFP2/HDDLED) to indicate when the HDD is active.

2.8.4 External speaker (JFP2/SPEAKER)

JFP2/SPEAKER is a 4-pin connector for an external speaker. If there is no external speaker, the AIMB-230 provides an onboard buzzer as an alternative. To enable the buzzer, set pins 7 & 10 as closed.

2.8.5 Power LED and keyboard lock connector (JFP3/PWR_LED & KEY LOCK)

(JFP3/PWR_LED & KEY LOCK) is a 5-pin connector for the power on LED and Key Lock function. Refer to Appendix B for detailed information on the pin assignments. The Power LED cable should be connected to pin 1-3. The key lock button cable should be connected to pin 4-5. There are 3 modes for the power supply connection. The first is “ATX power mode”; the system turns on/off by a momentary power button. The second is “AT Power Mode”; the system turns on/off via the power supply switch. The third is another “AT Power Mode” which makes use of the front panel power switch. The power LED status is indicated in the following table:

Table 2.2: ATX power supply LED status (No support for AT power)

Power mode	LED (ATX Power Mode) (On/off by momentary button)	LED (AT power Mode) (On/off by switching power supply)	LED (AT power Mode) (On/off by front panel switch)
PSO1 (on back plane) jumper setting	pins 2-3 closed	pins 1-2 closed	Connect pins 1 & 2 to panel switch via cable
System On	On	On	On
System Off	Off	Off	Off
S3	Fast flashes	N/A	N/A
S4	Slow flashes	N/A	N/A

2.9 Line Out, Mic In Connector (AUDIO1/AUDIO2)

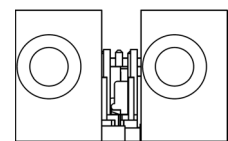
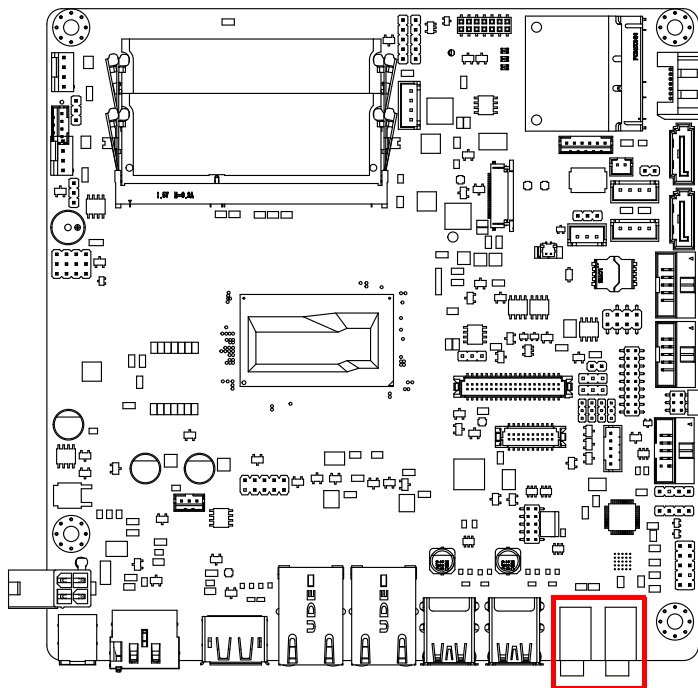

Line Out Mic In

2.10 Digital Audio Connector (SPDIF_O1)

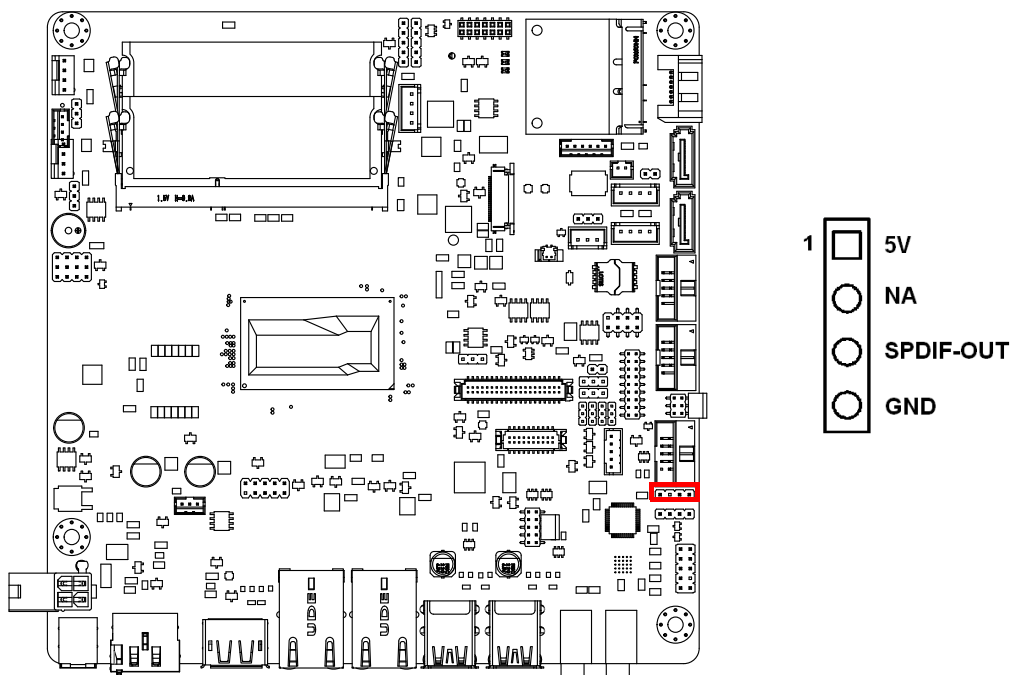

2.11 Serial ATA Interface (SATA1 ~ SATA3/ SATA_PWR1 ~ SATA_PWR3)

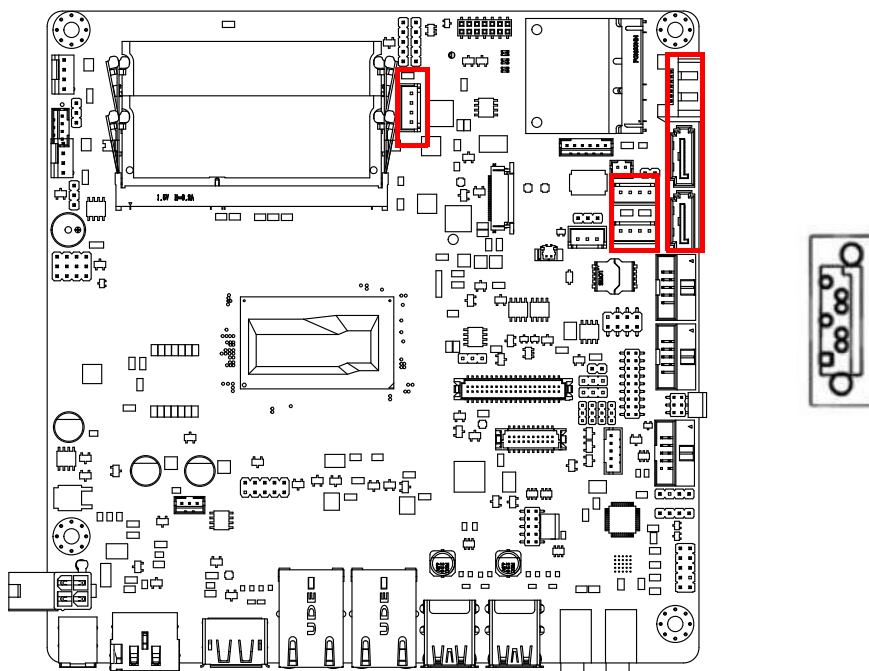

AIMB-230 features a high performance Serial ATA interface (up to 300 MB/s) and Serial ATA III interface (up to 600 MB/s) which eases hard drive cabling with thin, space-saving cables.

2.12 SATA power connector(SATA_PWR1~3)

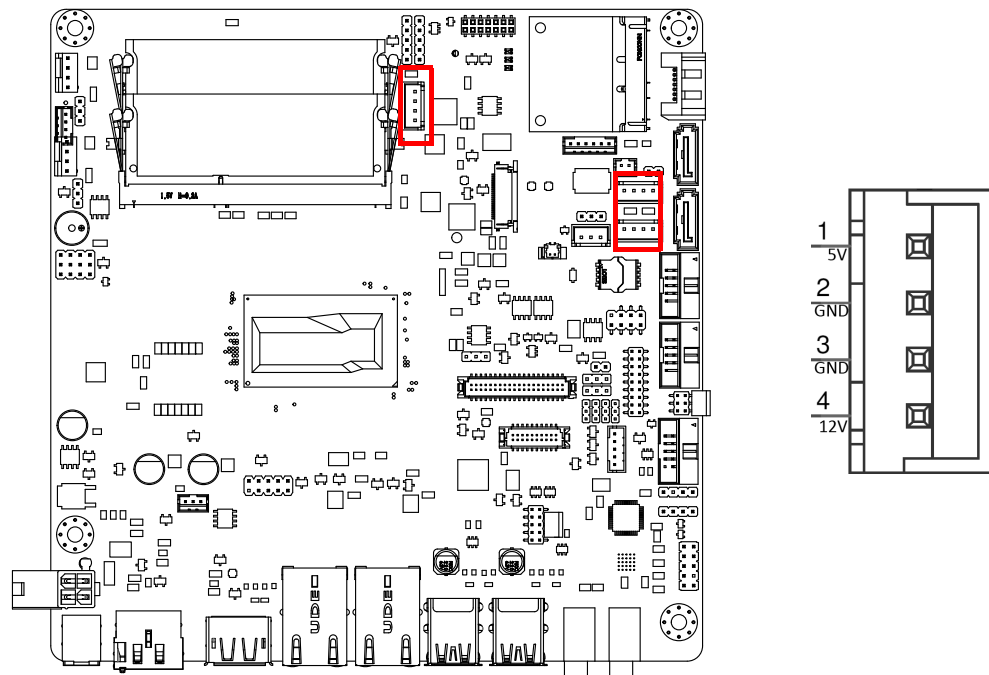

2.13 Full / Half Size Mini PCI Express Slot

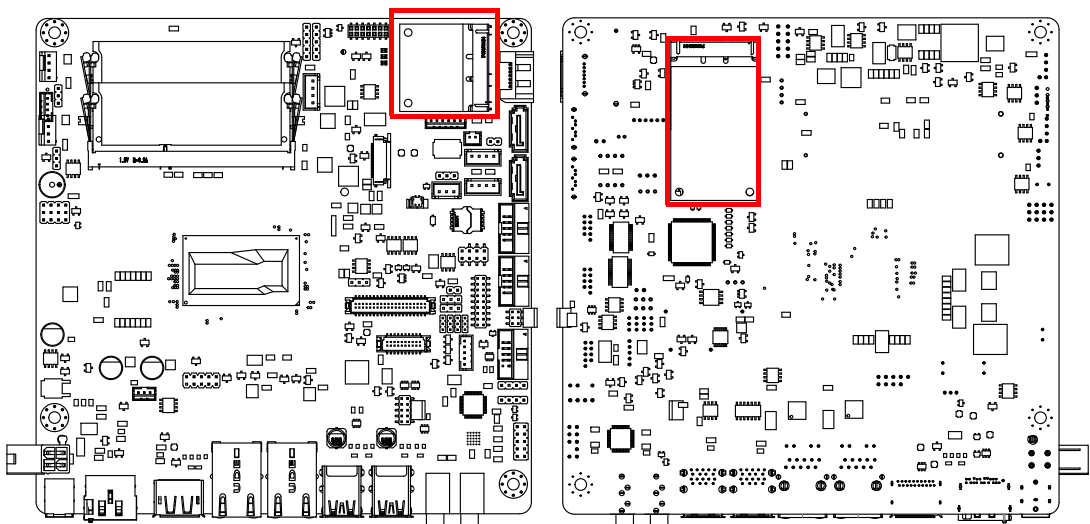

The AIMB-230 provides 1 Full size Mini PCI express slot (Co-lay mSATA) and 1 Half size Mini PCI express slot.

2.14 Front Headphone Connector (FP_AUDIO1)

This connector is for a chassis-mounted front panel audio I/O module that supports either HD Audio or legacy AC'97 (optional) audio standard. Connect this connector with the front panel audio I/O module cable.

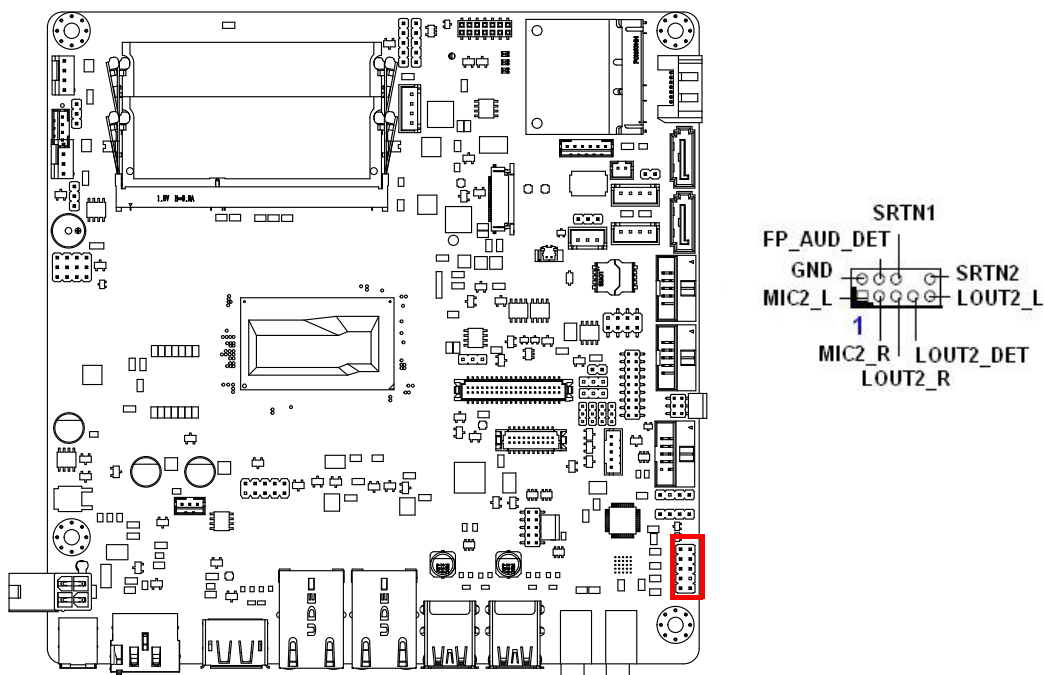

Note!  For motherboards with the optional HD Audio feature, we recommend that you connect a high-definition front panel audio module to this connector to take advantage of the motherboard's high definition audio capability.

2.15 ATX 12V/DCIN 12V/5V SB Input Power Connector (ATX12V1/DCIN1)

This connector is for an ATX 12 V power supply. The plugs from the power supply are designed to fit these connectors in only one direction. Determine the proper orientation and push down firmly until the connectors mate completely.

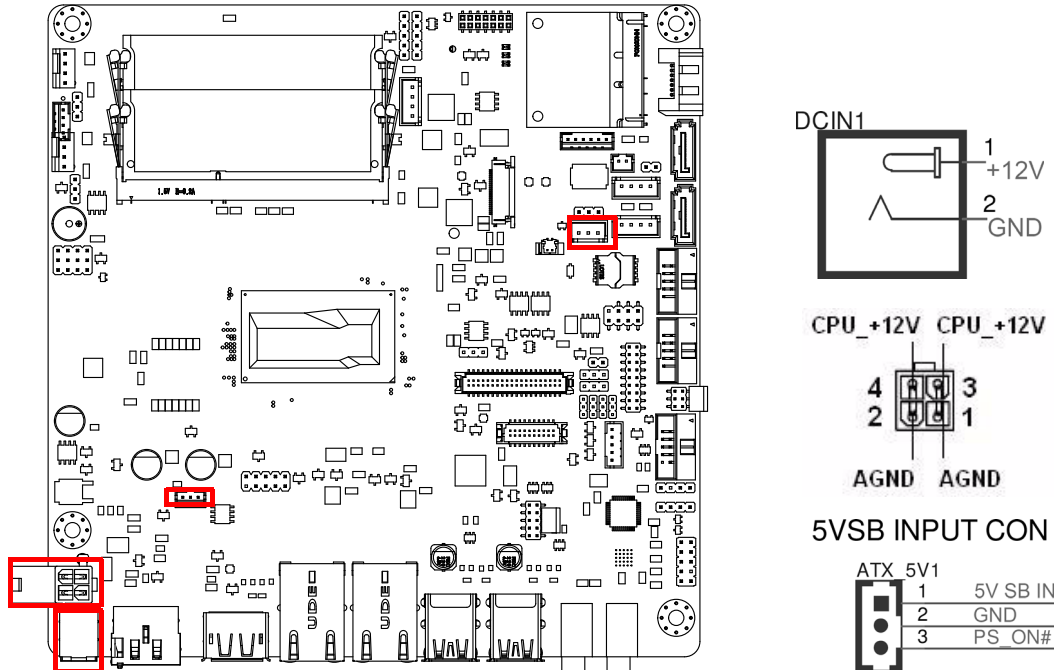

- Note!**
1. Connect the ATX12V1 connector with the PSU ATX 12V 4-pin connector.
 2. For a fully configured system, we recommend that you use a power supply unit (PSU) that complies with ATX 12 V Specification 2.0 (or later version) and provides a minimum power of 180 W.
 3. ATX_5V1 is for operation system shutdown command, if you use ATX12V1 input, you can power shutdown the system.

PSON1 is for AT/ATX mode selection(PSON1)

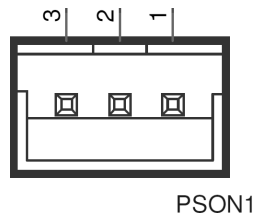

PSON1:1-2 AT*
 2-3 ATX

2.16 SPI Flash Connector(SPI_CN1)

The SPI flash card pin header may be used to flash BIOS if the AIMB-230 cannot power on.

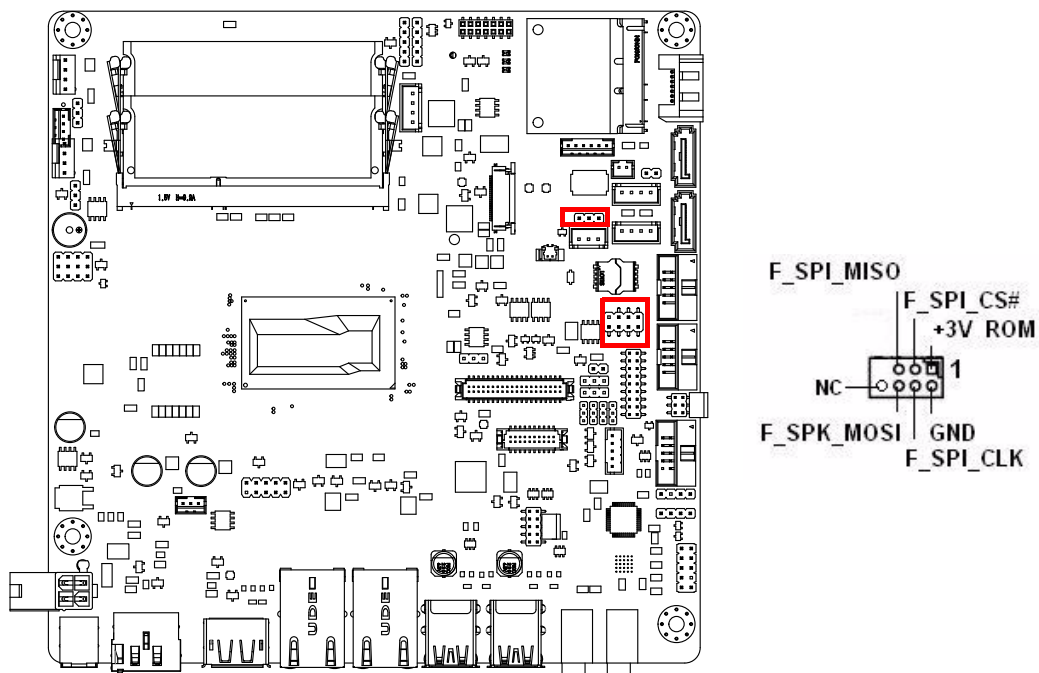

Clean CMOS(CMOS1)

Clean CMOS and reset RTC

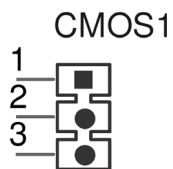

CMOS1: 1-2 Keep CMOS data*

3-4 Clean CMOS

2.17 LCD Inverter Connector (INV1)

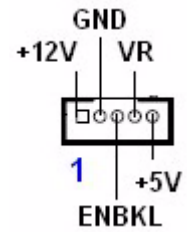
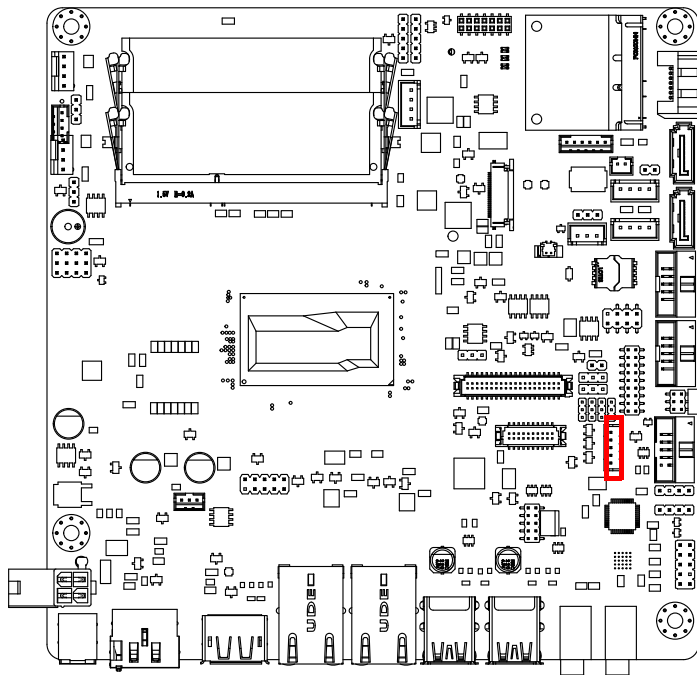

Note! ■ **Signal Description**



Signal

VR

ENBKl

Signal Description

$V_{adj}=0.75\text{ V}$

(Recommended: $4.7\text{ K}\Omega$, $>1/16\text{ W}$)

LCD backlight ON/OFF control signal

2.18 LVDS Connector (LVDS1)

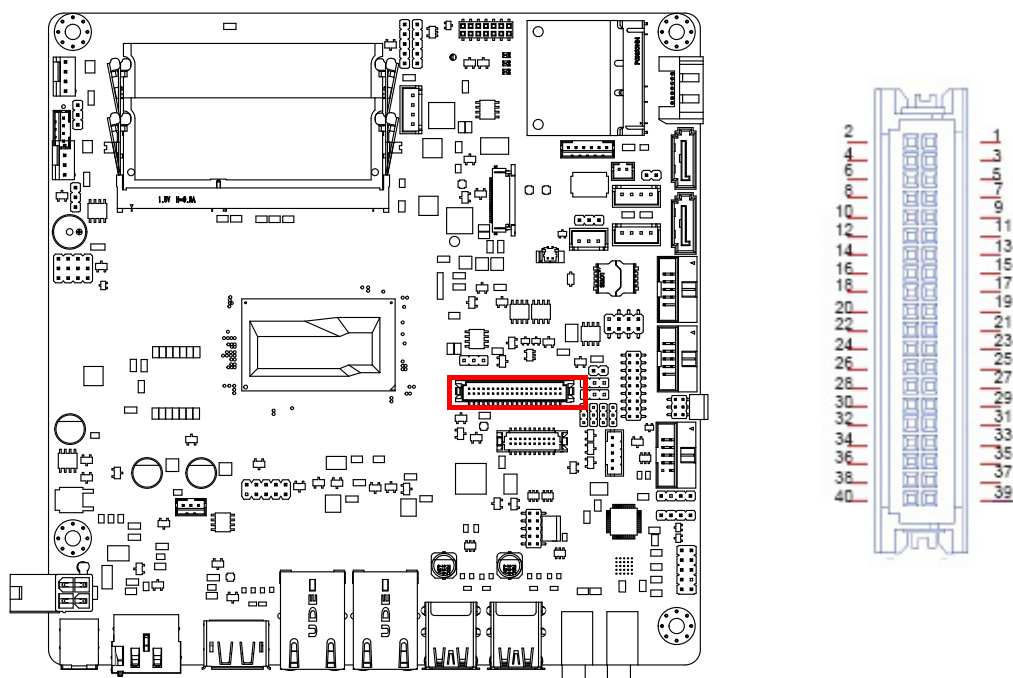

2.19 General Purpose I/O Connector (GPIO1)

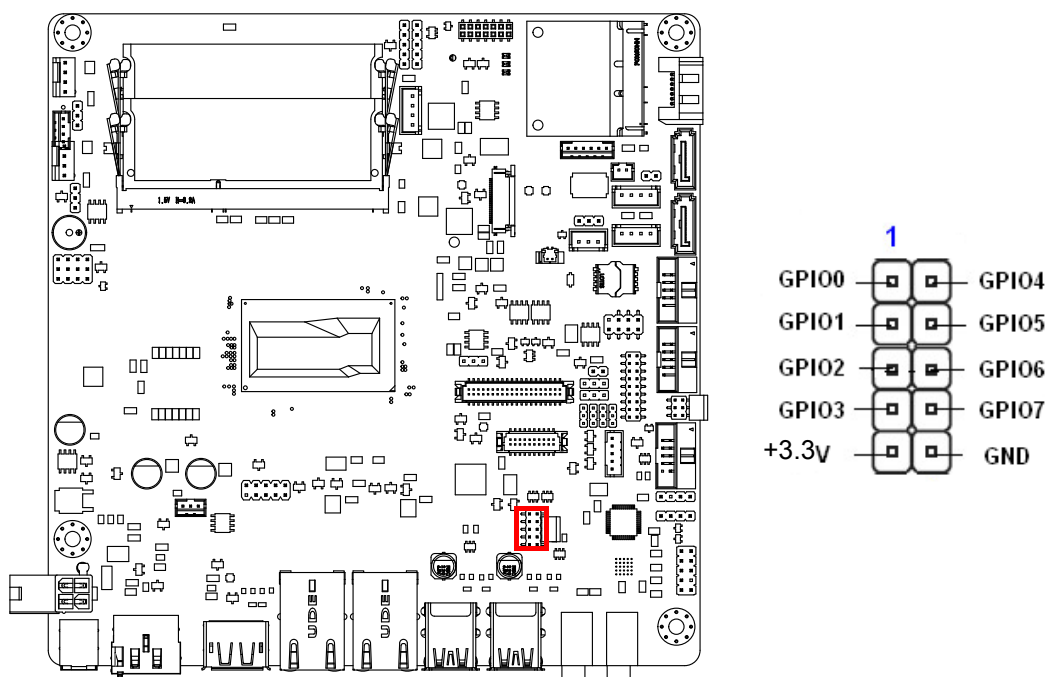

Chapter 3

BIOS Operation

3.1 Introduction

With the AMI BIOS Setup program, you can modify the BIOS settings and control the special features of your computer. The Setup program uses a number of menus for making changes and turning special features on or off. This chapter describes the basic navigation of the AIMB-230 setup screens.

3.2 BIOS Setup

The AIMB-230 Series system has AMI BIOS built in, with a CMOS SETUP utility that allows users to configure required settings or to activate certain system features.

The CMOS SETUP saves the configuration in the CMOS RAM of the motherboard. When the power is turned off, the battery on the board supplies the necessary power to preserve the CMOS RAM.

When the power is turned on, press the button during the BIOS POST (Power-On Self Test) to access the CMOS SETUP screen.

Control Keys

< ↑ >< ↓ >< ← >< → >	Move to select item
----------------------	---------------------

<Enter>	Select Item
---------	-------------

<Esc>	Main Menu - Quit and not save changes into CMOS Sub Menu - Exit current page and return to Main Menu
-------	---

<Page Up/+>	Increase the numeric value or make changes
-------------	--

<Page Down/->	Decrease the numeric value or make changes
---------------	--

<F1>	General help, for Setup Sub Menu
------	----------------------------------

<F2>	Item Help
------	-----------

<F5>	Load Previous Values
------	----------------------

<F7>	Load Setup Defaults
------	---------------------

<F10>	Save all CMOS changes
-------	-----------------------

3.2.1 Main Menu

Press to enter AMI BIOS CMOS Setup Utility, the Main Menu will appear on the screen. Use arrow keys to select among the items and press <Enter> to accept or enter the sub-menu.



The Main BIOS setup screen has two main frames. The left frame displays all the options that can be configured. Grayed-out options cannot be configured; options in blue can. The right frame displays the key legend.

Above the key legend is an area reserved for a text message. When an option is selected in the left frame, it is highlighted in white. Often a text message will accompany it.

3.2.1.1 System time / System date

Use this option to change the system time and date. Highlight System Time or System Date using the <Arrow> keys. Enter new values through the keyboard. Press the <Tab> key or the <Arrow> keys to move between fields. The date must be entered in MM/DD/YY format. The time must be entered in HH:MM:SS format.

3.2.2 Advanced BIOS Features

Select the Advanced tab from the AIMB-230 setup screen to enter the Advanced BIOS Setup screen. You can select any of the items in the left frame of the screen, such as CPU Configuration, to go to the sub menu for that item. You can display an Advanced BIOS Setup option by highlighting it using the <Arrow> keys. All Advanced BIOS Setup options are described in this section. The Advanced BIOS Setup screen is shown below. The sub menus are described on the following pages.

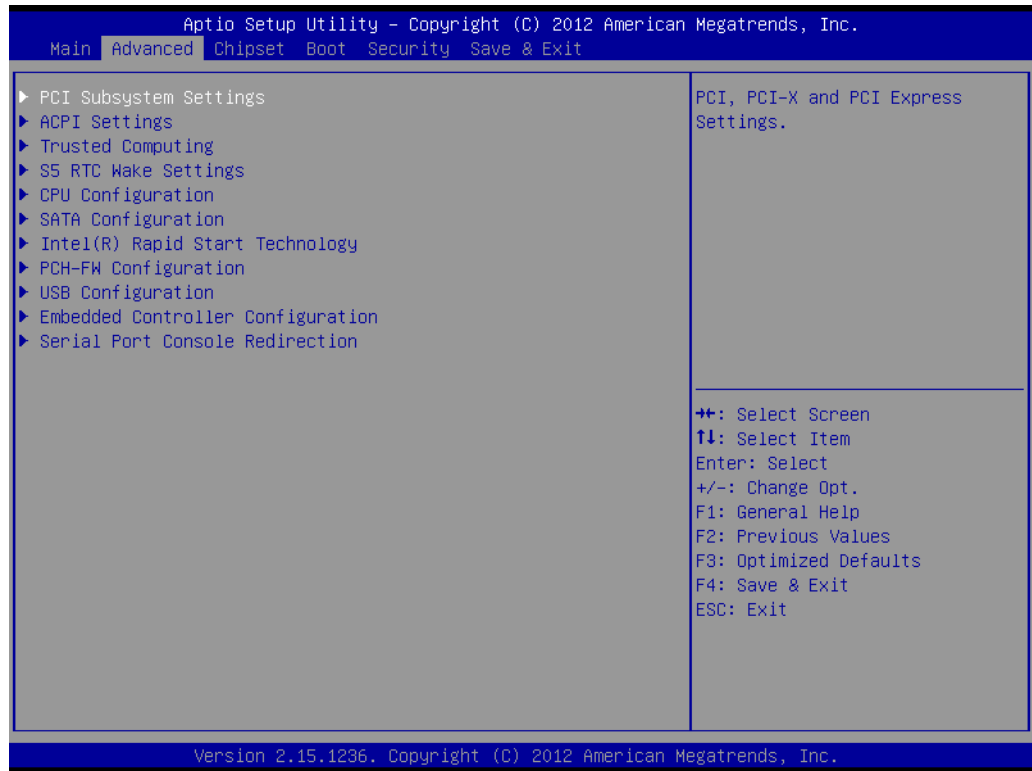

3.2.2.1 PCI Subsystem Settings

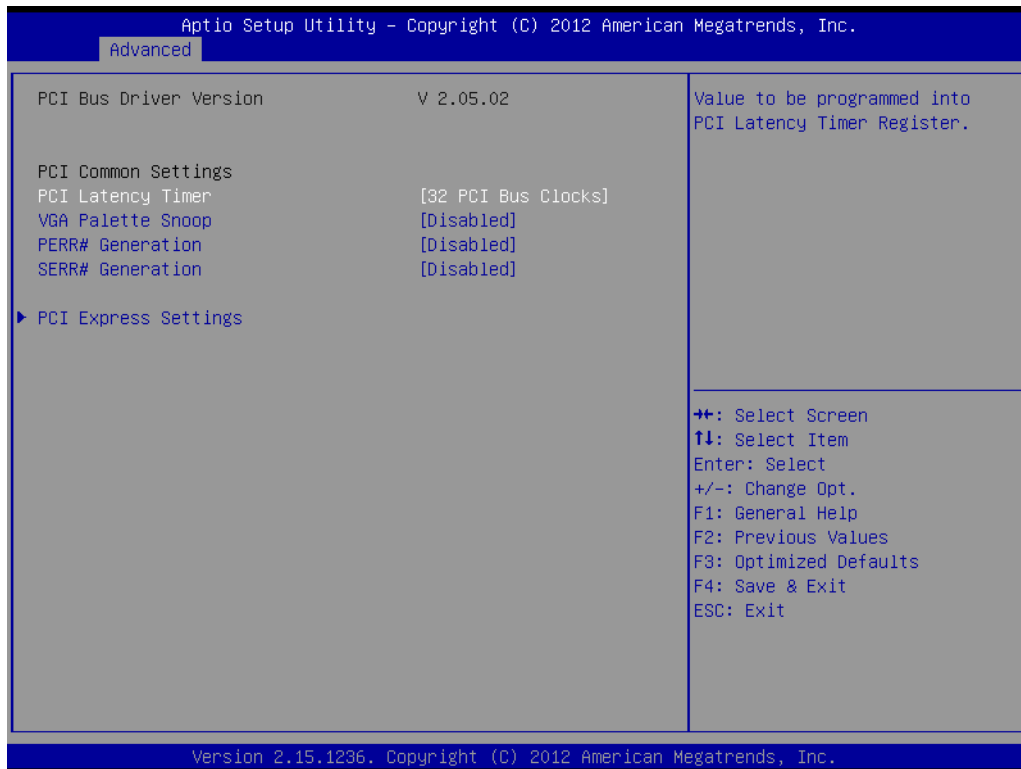

- **PCI Latency Timer**
This item allows users to programmed PCI Latency timer.
- **VGA Palette Snoop**
This item allows users to enable or disable VGA Palette Snoop.
- **PERR## Generation**
This item allows users to enable or disable PERR## Generation.
- **SERR## Generation**
This item allows users to enable or disable SERR## Generation.

3.2.2.2 PCI Express Device Register Settings



- **Relaxed Ordering**
Enable or disable Relaxed Ordering
- **Extended Tag**
Enable or disable Extended Tag
- **No Snoop**
Enable or disable No Snoop
- **Maximum Payload**
This item allows users to set the Maximum Payload
- **Maximum Read Request**
This item allows users to set the Maximum Read Request
- **ASPM Support**
Enable or disable ASPM Support
- **Extended Synch**
Enable or disable Extended Synch
- **Link Training Retry**
This item allows users to set the Link Training Retry
- **Link Training Timeout (uS)**
This item allows users to set the Link Training Timeout (uS)
- **Unpopulated Links**
This item allows users to set the Unpopulated Links
- **Restore PCIE Registers**
Enable or disable Restore PCIE Registers

3.2.2.3 ACPI settings

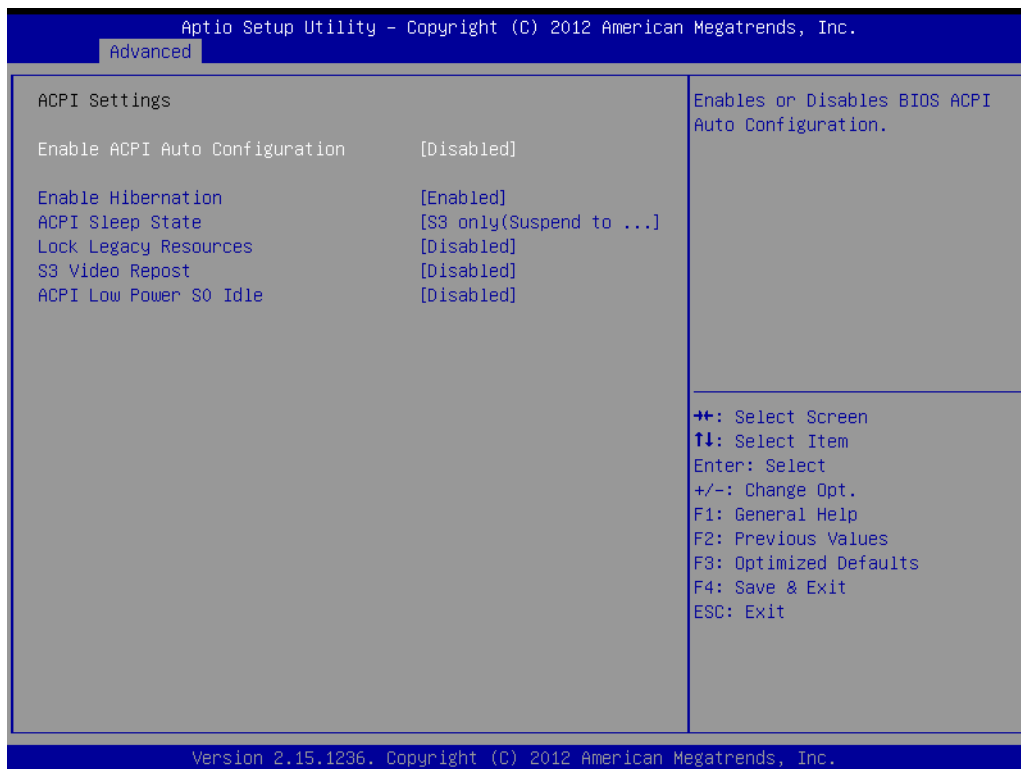

- **Enable ACPI Auto Configuration**
Enable or disable BIOS ACPI Auto Configuration
- **Enable Hibernation**
This item allows users to enable or disable hibernation
- **ACPI Sleep state**
This item allows users to set the ACPI sleep state
- **Lock Legacy Resources**
This item allows users to lock legacy devices' resources.
- **S3 Video Repost**
Enable or disable video repost
- **Power on by Modem**
Disable/Enable power on modem function

3.2.2.4 Trusted Computing



- **Security Device Support**
Enable or disable BIOS support for security device.

3.2.2.5 S5 RTC Wake Settings



- **Wake system with fixed time**
Enable or disable system wake on alarm event

3.2.2.6 CPU Configuration

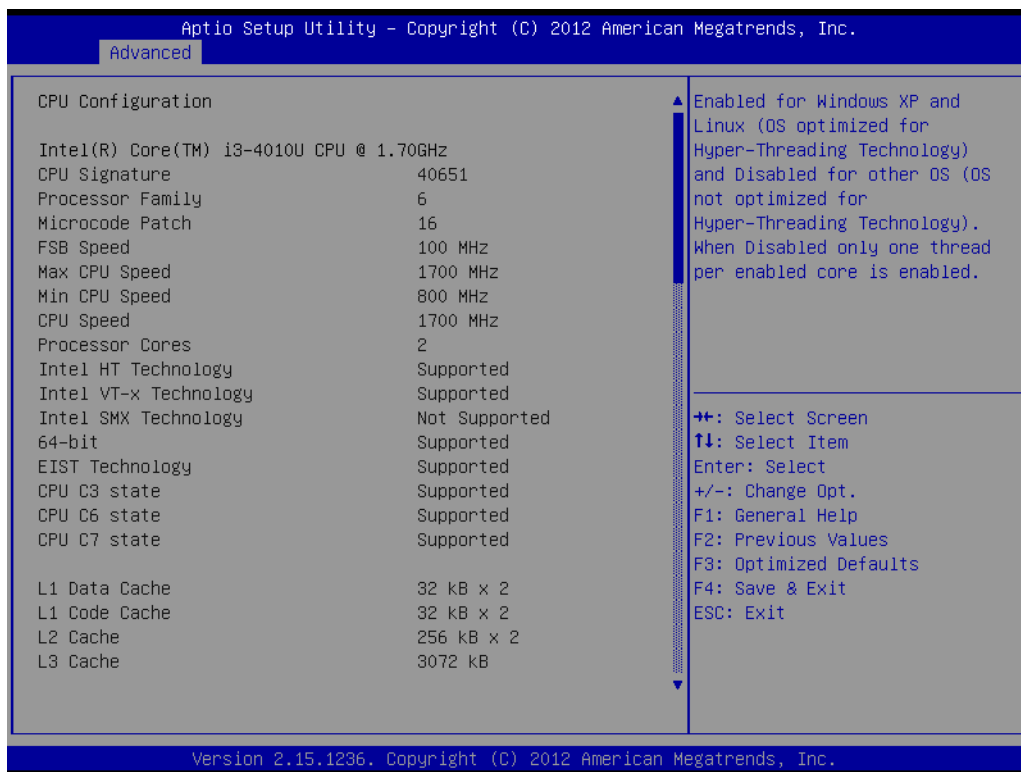

3.2.2.7 SATA configuration

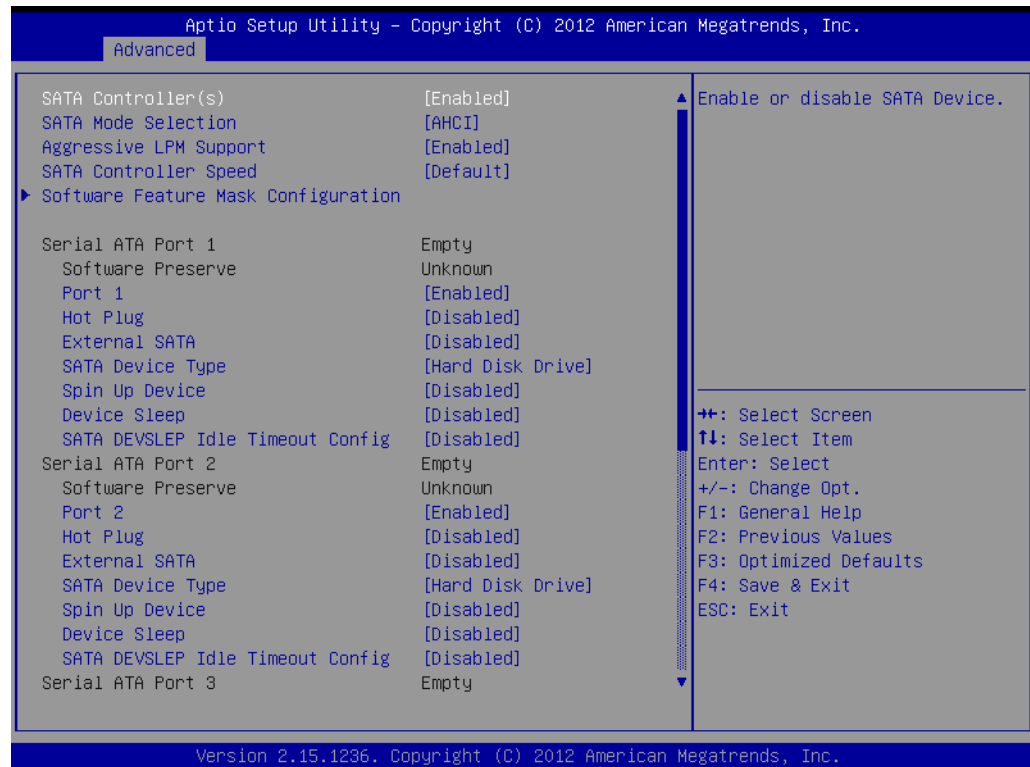

- **SATA Controller(s)**
This item allows users to enable or disable the SATA controller(s).
- **SATA Mode Selection**
This item allows users to select mode of SATA controller(s).
- **Aggressive LPM Support**
This item allows users to enable or disable the Aggressive LPM Support.
- **SATA Controller Speed**
This item allows users to select the mode for SATA Controller Speed.
- **Serial ATA Port 1/2/3**
This item allows users to enable or disable the SATA Port.
- **Hot Plug**
This item allows users to enable or disable the Hot Plug.
- **External SATA**
This item allows users to enable or disable the External SATA.
- **SATA Device type**
This item allows users to select mode of SATA Device type.
- **Spin up Device**
This item allows users to enable or disable the Spin up Device.
- **Device Sleep**
This item allows users to enable or disable the Device Sleep.
- **SATA DEVSLEP idle Timeout Config**
This item allows users to enable or disable the SATA DEVSLEP idle Timeout Config.

3.2.2.8 INTEL Rapid Star Technology

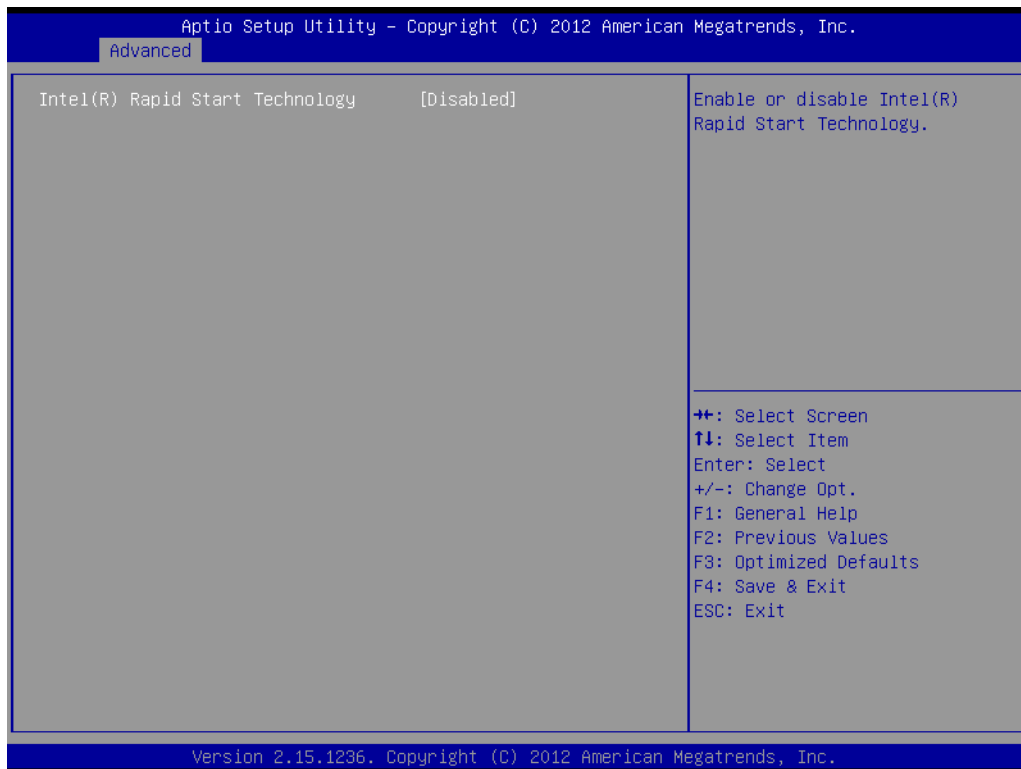

- **Intel® Rapid start technology**
This item allows users to enable or disable Intel rapid start technology.

3.2.2.9 PCH (FW) Configuration

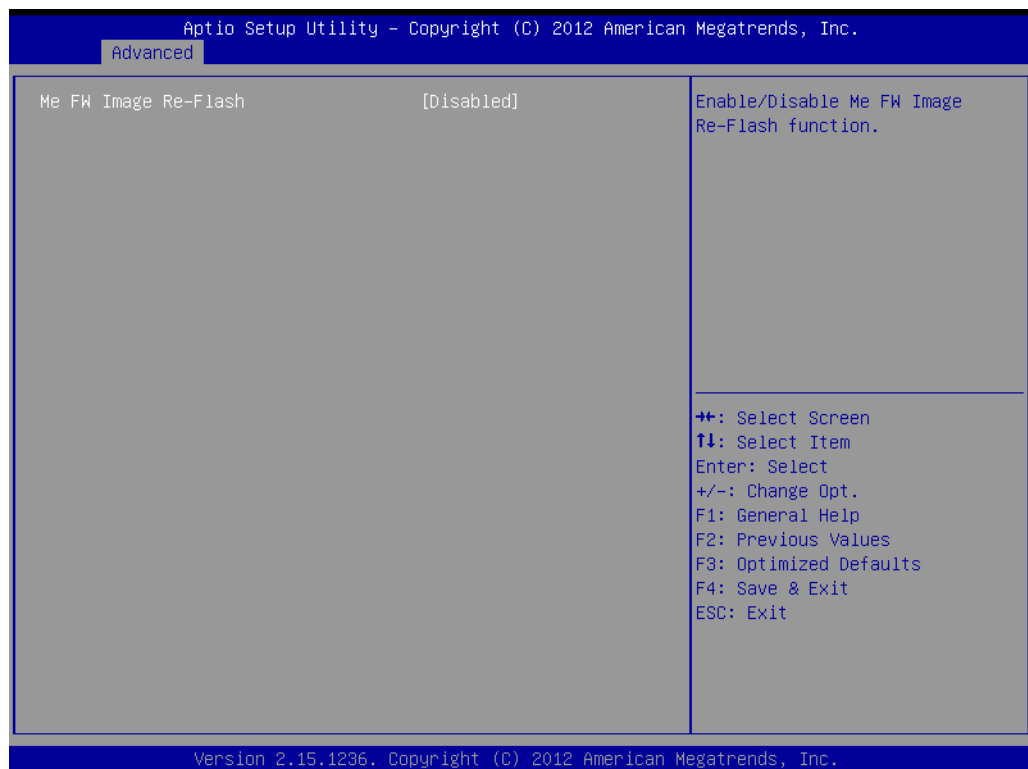
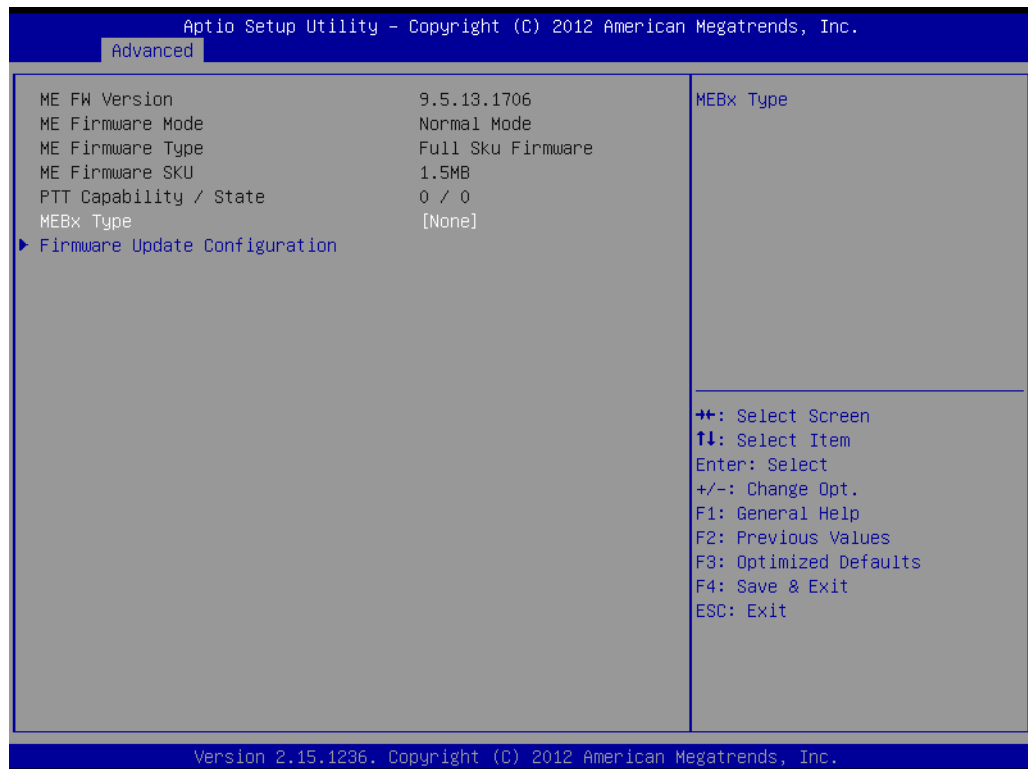

- **Me FW Image Re-Flash**
This item allows users to enable or disable Me FW image re-flash function.

3.2.2.10 USB Configuration

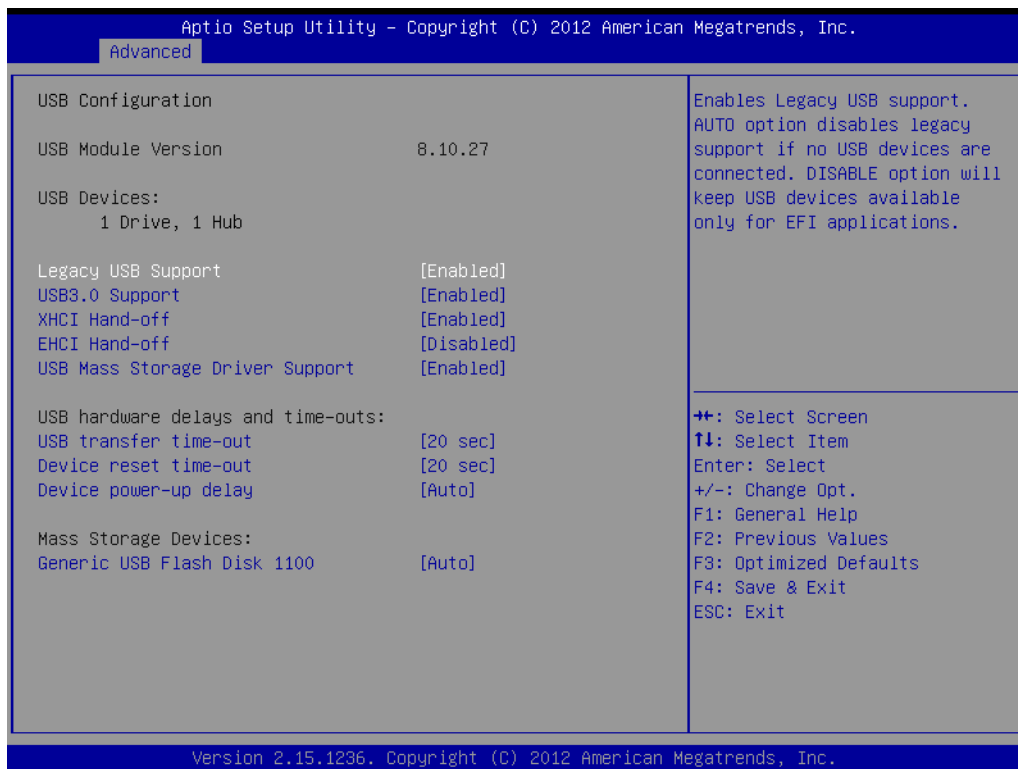

- **Legacy USB support**
Enables support for legacy USB. Auto option disables legacy support if no USB devices are connected.
- **USB3.0 support**
This item allows users to enable or disable USB3.0 function.
- **XHCI Hand-off**
This is a workaround for OS without XHCI hand-off support. The XHCI ownership change should claim by XHCI driver.
- **EHCI Hand-off**
This is a workaround for OS without EHCI hand-off support. The EHCI ownership change should claim by EHCI driver.
- **USB transfer time-out**
This item allows users to set the USB transfer time-out
- **Device reset time-out**
This item allows users to set the Device reset time-out
- **Device power-up delay**
This item allows users to set the Device power-up delay
- **Generic USB Flash Disk 1100**
This item allows users to set the Generic USB Flash Disk 1100

3.2.2.11 Embedded Controller configuration

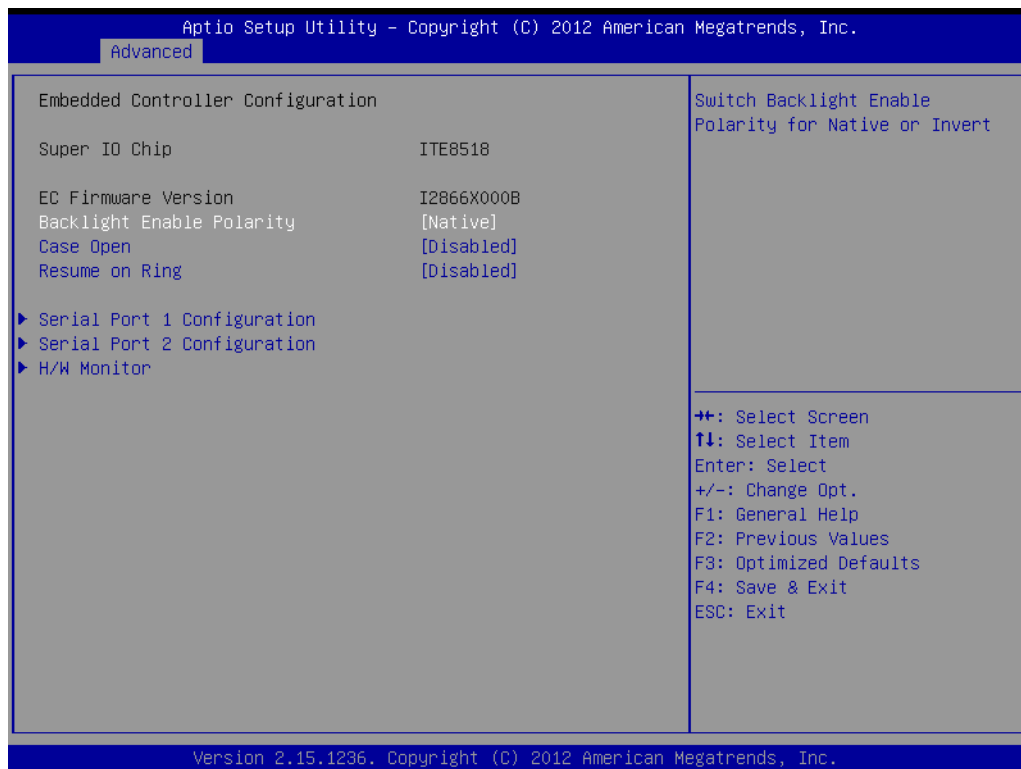

- **Backlight Enable Polarity**
This item allows users to set backlight enable polarity.
- **Case Open**
This item allows users to set Case open enable polarity.
- **Resume on Ring**
This item allows users to set Resume on Ring enable polarity.

3.2.2.12 Serial port 1/2 Configuration

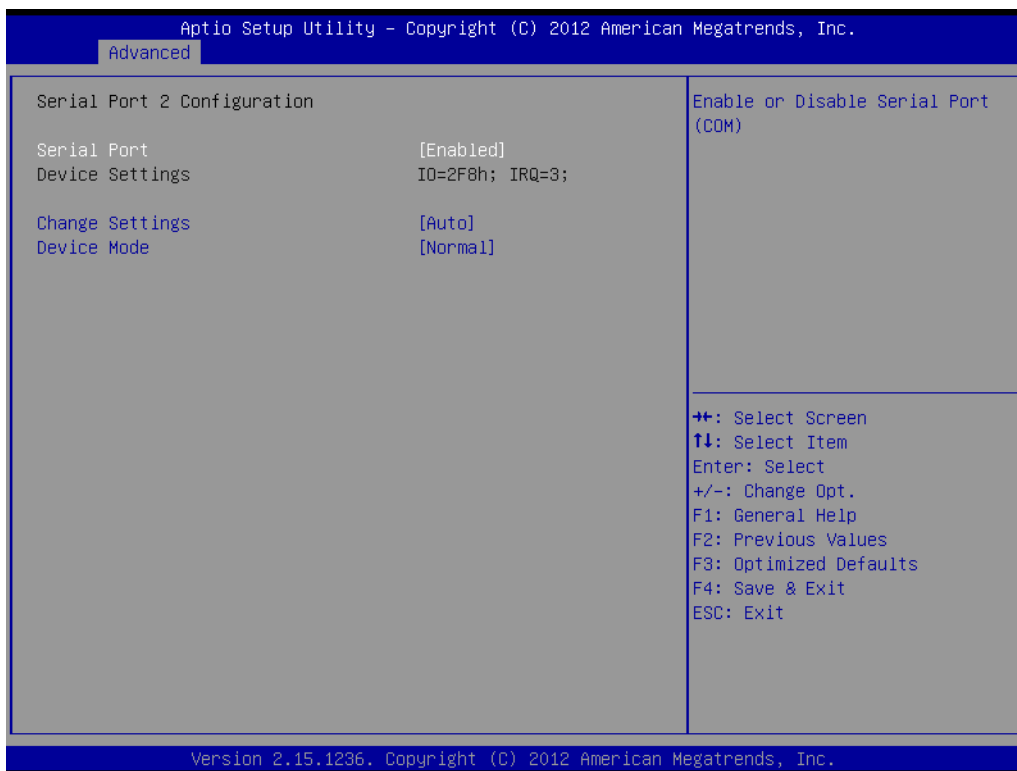
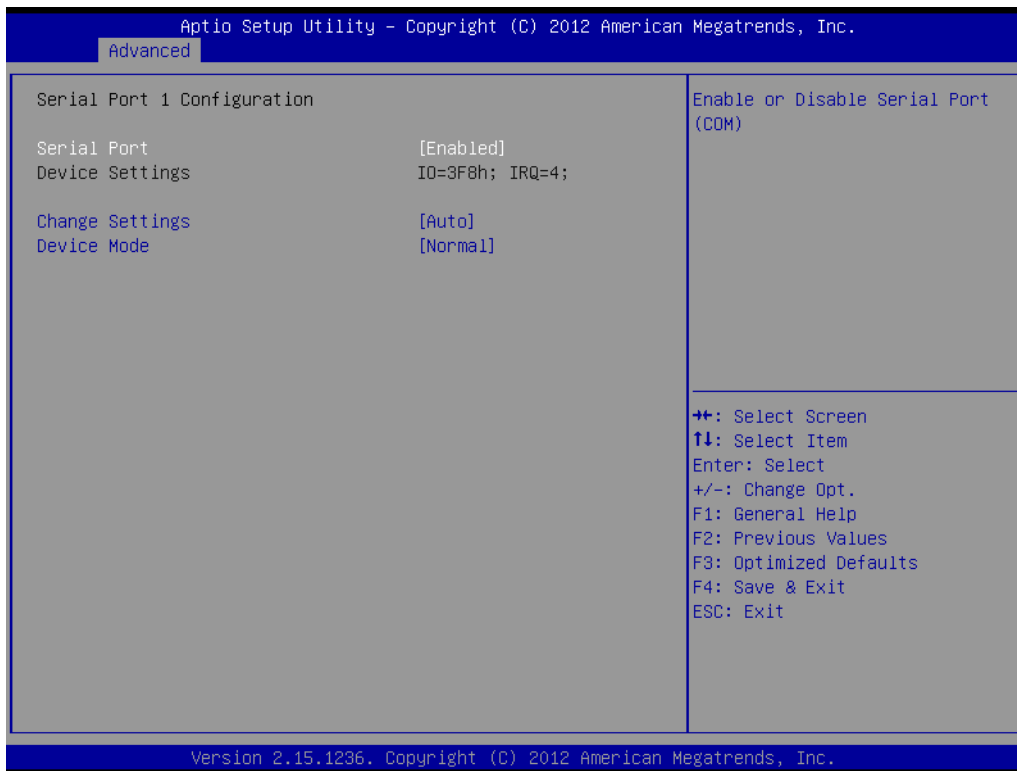

- **Serial Port**
This item will allow users to enable or disable serial port.
- **Change Settings**
This item allows users to change the serial port setting.
- **Device Mode**
This item allows users to change the device mode.

3.2.2.13 PC Health Status

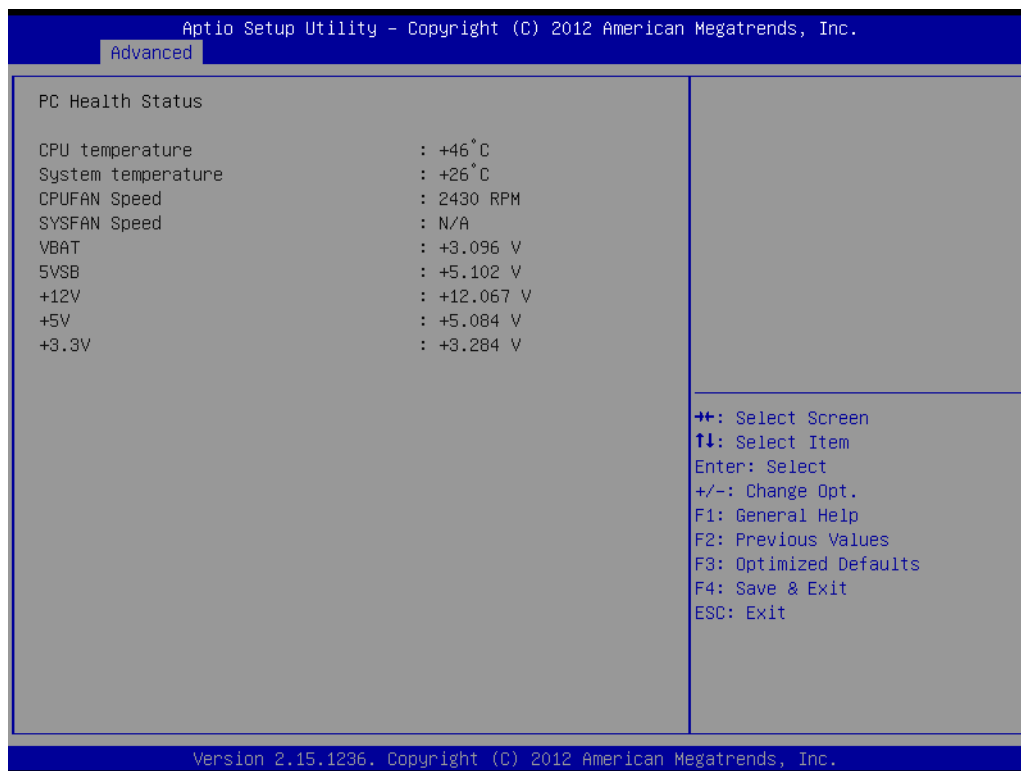

3.2.2.14 Serial Port Console Redirection



■ **Console Redirection**

This item allows users to enable or disable console redirection for Microsoft Windows Emergency Management Services (EMS).

3.2.3 Chipset

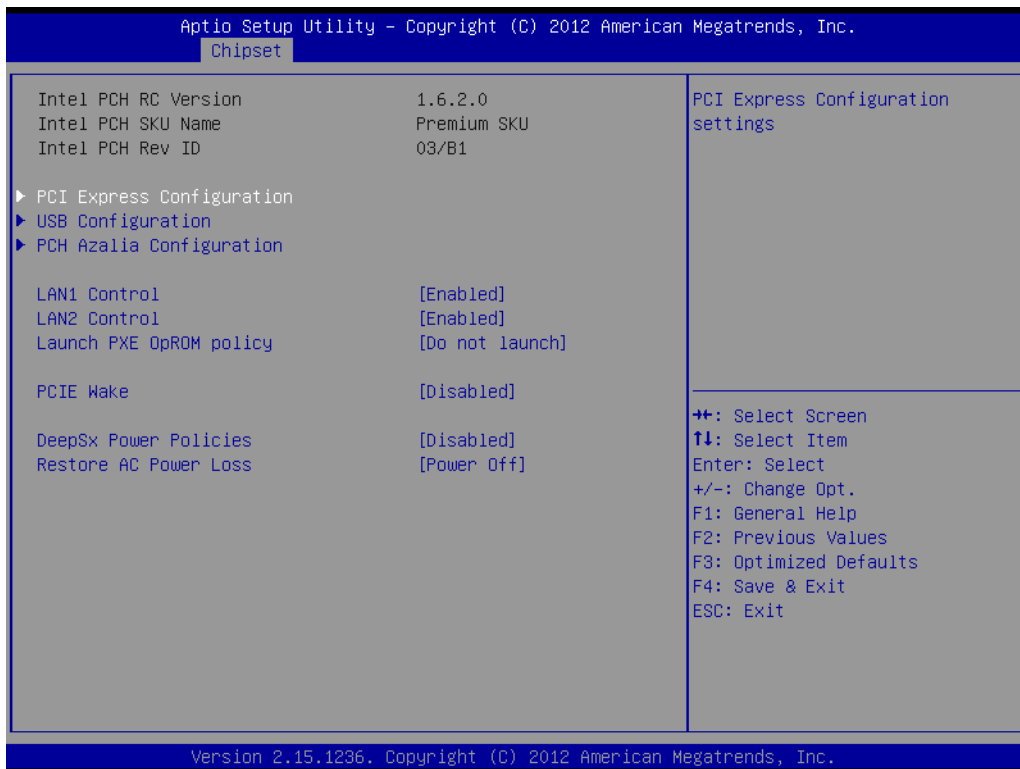

- **PCI Express Configuration**
Details of PCI Express items.
- **USB Configuration**
Details of USB items.
- **PCH Azalia Configuration**
Details of PCH azalia items.
- **LAN controller**
Enables or disables the LAN1/2 controller.
- **Launch PXE OpROM Policy**
Enables or disables the LAN1/2 option-ROM.
- **PCIE Wake**
Enables or disables LAN1/2 wake up from sleep state.
- **DeeSx Power Policies**
Enables or disables the DeeSx Power Policies.
- **Restore AC Power Loss**
This item allows users to select off, on and last state.

3.2.3.1 PCI Express Configuration

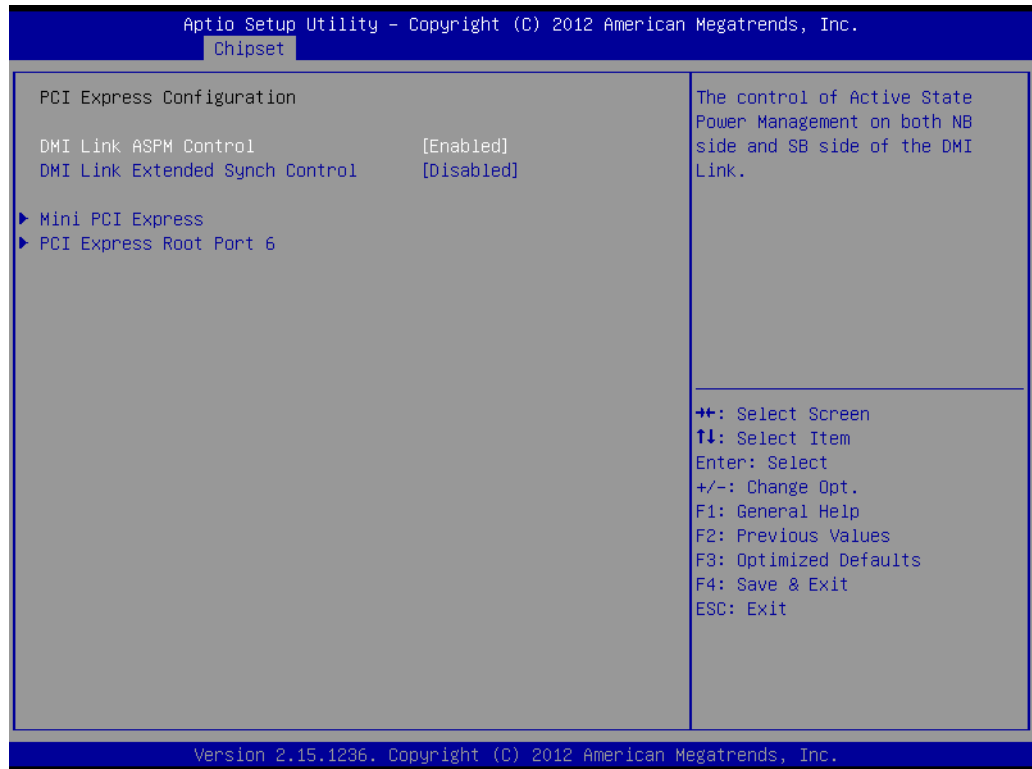

- **DMI Link ASPM Control**
This item allows users to enable or disable the DMI Link ASPM Control.
- **DMI Link Extended Synch Control**
This item allows users to configure Mini PCI Express setting.
- **Mini PCI Express**
This item allows users to enable or disable the PME SCI function.
- **PCI Express Root Port**
This item allows users to configure PCI Express Root port setting.

3.2.3.2 USB Configuration

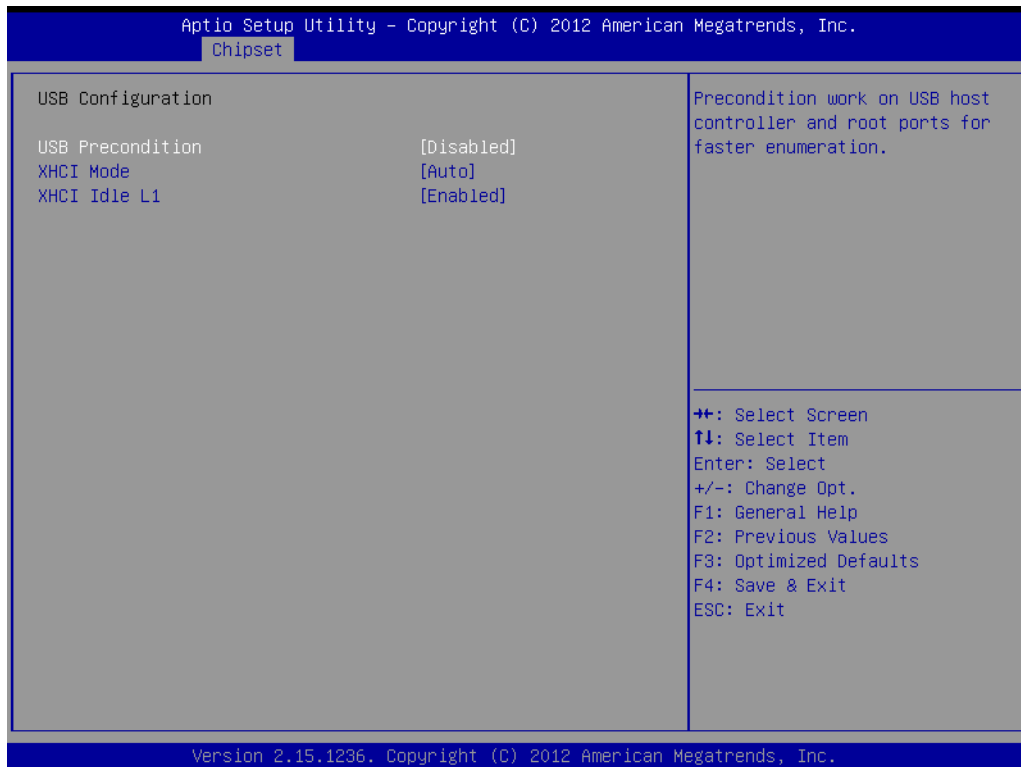

- **USB Precondition**
This item allows user to enable or disable USB Precondition.
- **XHCI Mode**
This item allows user to enable or disable XHCI Mode.
- **XHCI Idle L1**
Enables or disables the XHCI Idle L1.

3.2.3.3 PCH Azalia Configuration

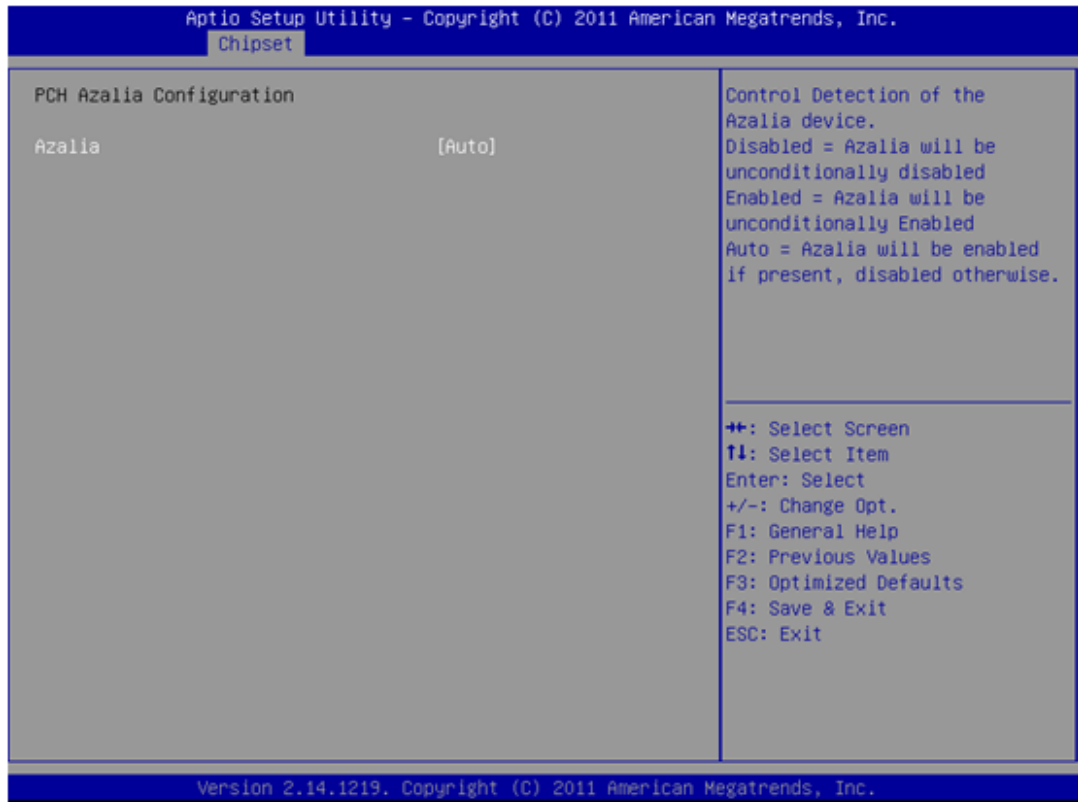

- **Azalia**
This item allows user to enable or disable azalea device.

3.2.3.4 System Agent (SA) Configuration

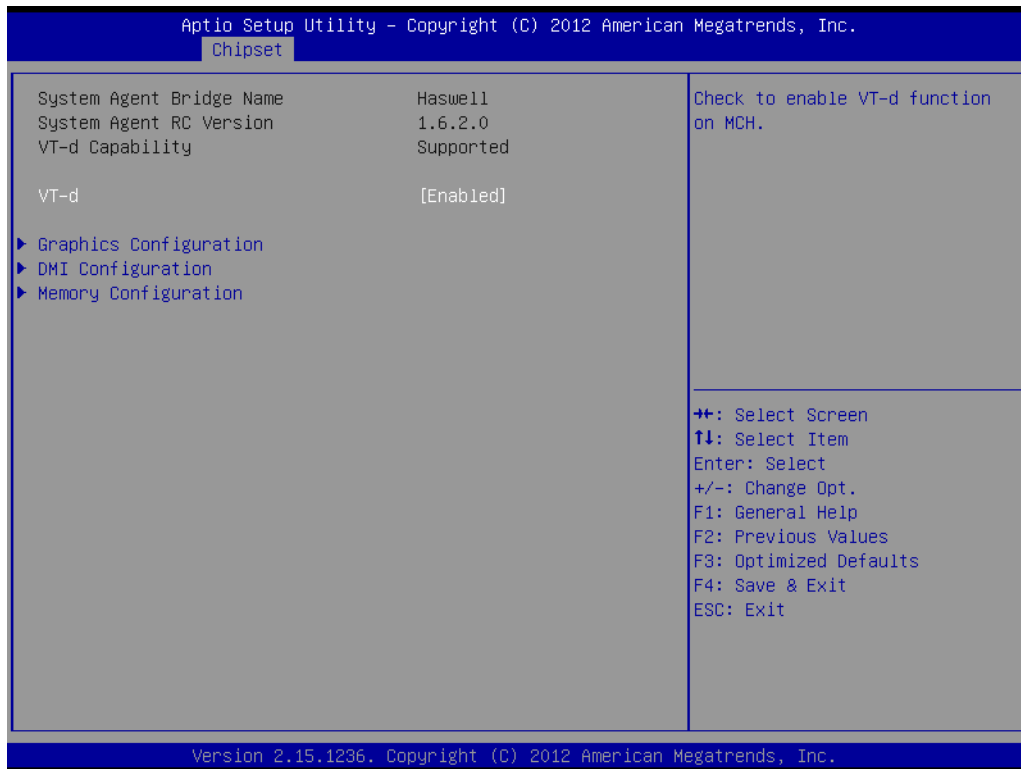

- **VT-d**
This item allows users to enable or disable VT-d.

3.2.3.5 Graphic Configuration

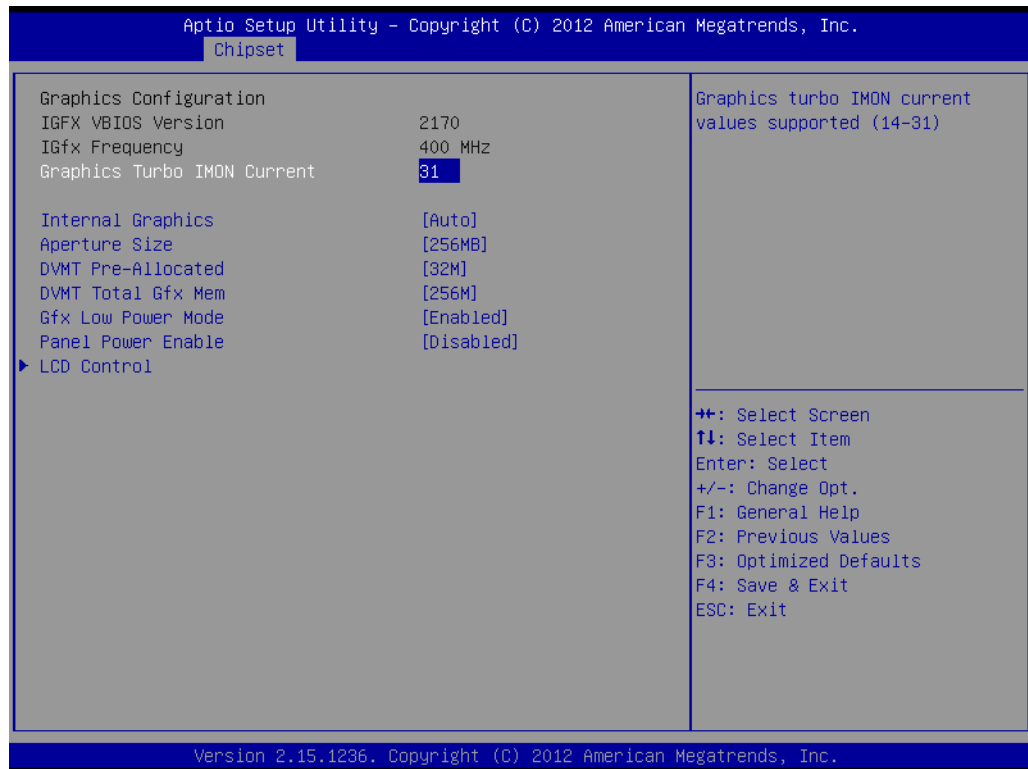

- **Graphics Turbo IMON Current**
This item allows users to select which Graphics Turbo IMON Current.
- **Internal Graphics**
This item allows users to enable or disable IGD.
- **Aperture Size**
This item allows users to select aperture size.
- **DVMT Pre-Allocated**
This item allows users to select DVMT pre-allocated memory size.
- **DVMT Total Gfx Mem**
This item allows users to select DVMT total memory size.
- **Gfx Low Power Mode**
This item allows users to enable or disable IGD low power mode.
- **Panel Power Enable**
This item allows users to enable or disable Panel Power.

3.2.3.6 LCD Control

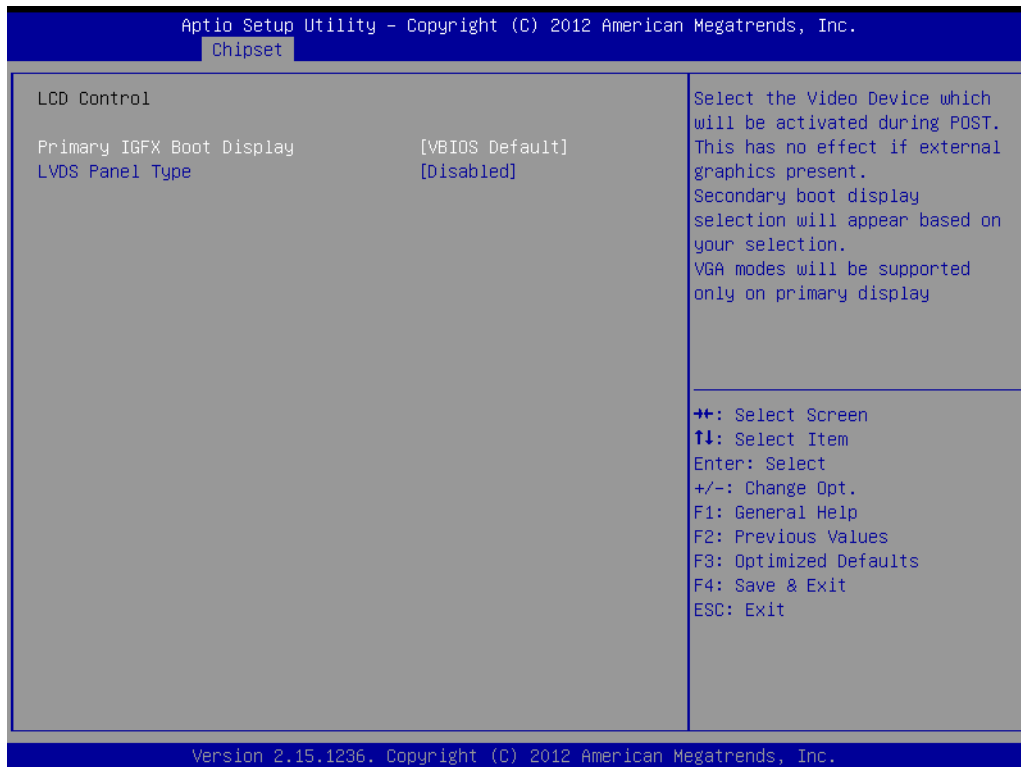

- **Primary IGFX Boot Display**
Select Primary IGFX Boot Display.
- **LVDS Panel Type**
Select LVDS Panel type.

3.2.4 Boot

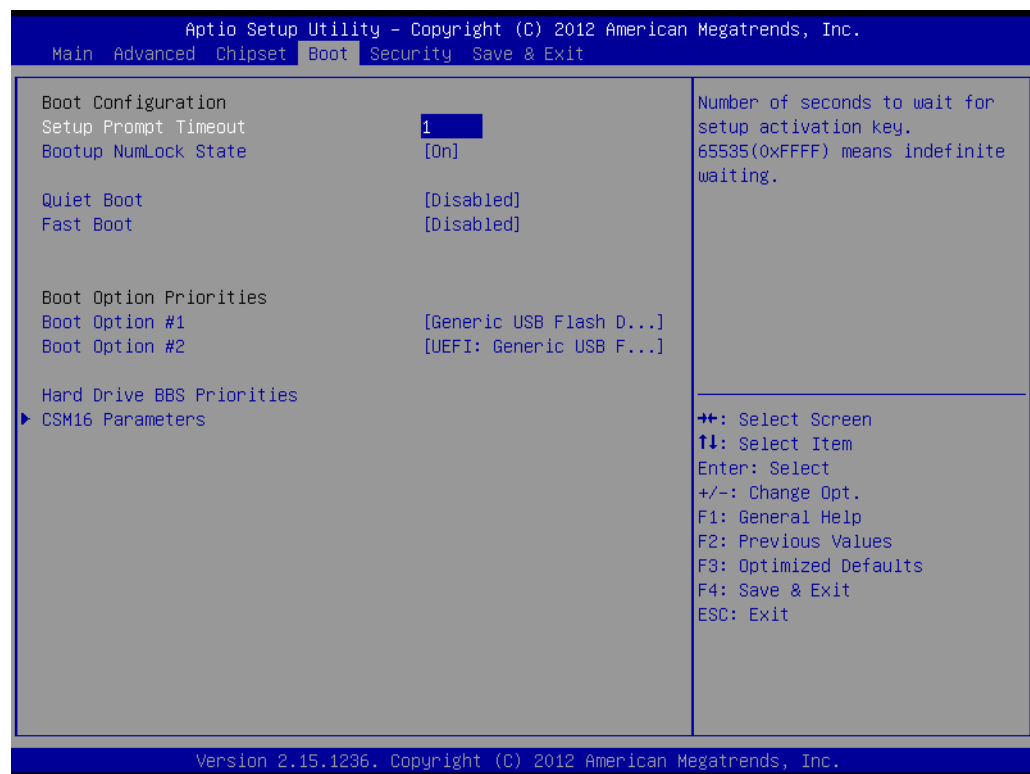

- **Setup Prompt Timeout**
This item allows you to change number of seconds to wait for setup activation key.
- **Bootup NumLock State**
Select the Power-on state for Numlock.
- **Quiet Boot**
If this option is set to Disabled, the BIOS display normal POST messages. If Enabled, an OEM Logo is shown instead of POST messages.
- **FAST Boot**
This item allows users to enable or disable Fast Boot.
- **Boot Option Priorities**
Set the system boot order.
- **GateA20 Active**
This item allows you to select upon request or Always.
- **Option ROM Messages**
Sets display mode for option ROM.
- **INT19 Trap Response**
This item allows option ROMs to trap interrupt 19.

3.2.5 Security



Select Security Setup from the AIMB-230 Setup main BIOS setup menu. All Security Setup options, such as password protection and virus protection are described in this section. To access the sub menu for the following items, select the item and press<Enter>: Change Administrator / User Password.

3.2.6 Save & Exit

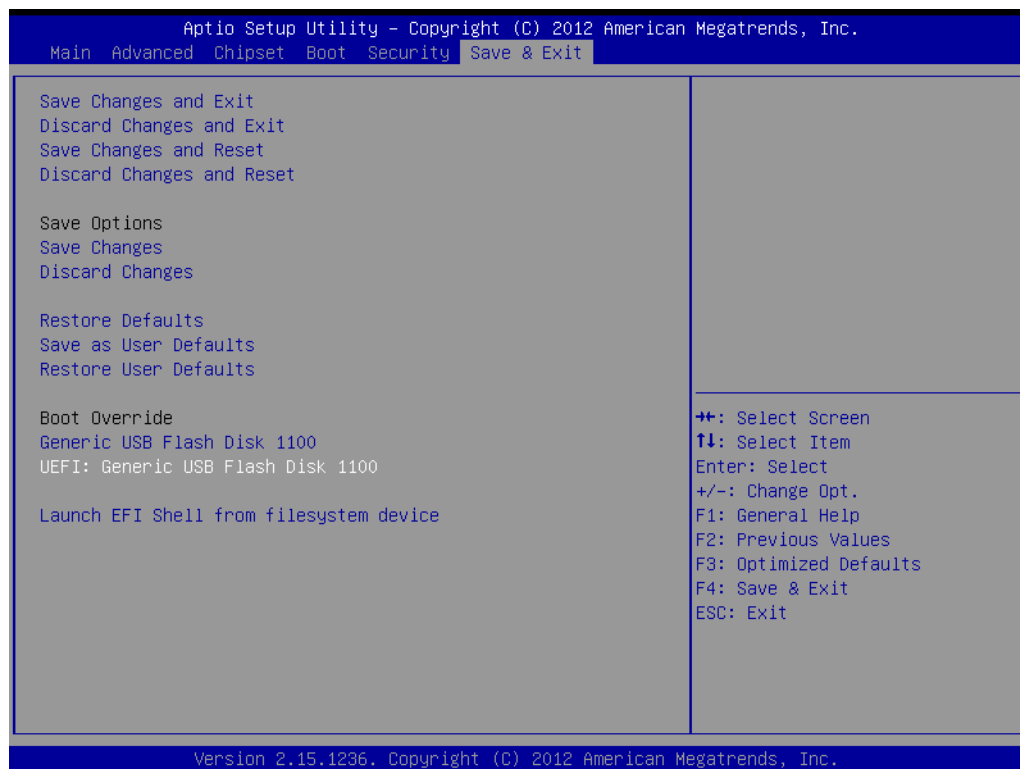

- **Save Changes and Exit**
This item allows you to exit system setup after saving changes.
- **Discard Changes and Exit**
This item allows you to exit system setup without saving any changes.
- **Save Changes and Reset**
This item allows you to reset the system after saving the changes.
- **Discard Changes and Reset**
This item allows you to rest system setup without saving any changes.
- **Save Changes**
This item allows you to save changes done so far to any of the options.
- **Discard Changes**
This item allows you to discard changes done so far to any of the options.
- **Restore Defaults**
This item allows you to restore/load default values for all the options.
- **Save as User Defaults**
This item allows you to save the changes done so far as user defaults.
- **Restore User Defaults**
This item allows you to restore the user defaults to all the options.
- **Boot Override**
Boot device selection can override your boot priority.

Chapter 4

Software Introduction
& Service

4.1 Introduction

We enable Windows® Embedded software products on Advantech platforms to more effectively support the embedded computing community. Customers are freed from the hassle of dealing with multiple vendors (hardware suppliers, system integrators, embedded OS distributors) for projects. Our goal is to make Windows® Embedded software solutions easily and widely available to the embedded computing community.

4.2 Value-Added Software Services

Software API: An interface that defines the ways by which an application program may request services from libraries and/or operating systems. Provides not only the underlying drivers required but also a rich set of user-friendly, intelligent and integrated interfaces, which speeds development, enhances security and offers add-on value for Advantech platforms. It plays the role of catalyst between developer and solution, and makes Advantech embedded platforms easier and simpler to adopt and operate with customer applications.

4.2.1 Software API

4.2.1.1 Control

GPIO



General Purpose Input/Output is a flexible parallel interface that allows a variety of custom connections. It allows users to monitor the level of signal input or set the output status to switch on/off the device. Our API also provide Programmable GPIO, which allows developers to dynamically set the GPIO input or output status.

SMBus



SMBus is the System Management Bus defined by Intel Corporation in 1995. It is used in personal computers and servers for low-speed system management communications. The SMBus API allows a developer to interface a embedded system environment and transfer serial messages using the SMBus protocols, allowing multiple simultaneous device control.

4.2.1.2 Display

Brightness Control



The Brightness Control API allows a developer to access embedded devices and easily control brightness.

Backlight

The Backlight API allows a developer to control the backlight (screen) on/off in embedded devices.

4.2.1.3 Monitor**Watchdog**

A watchdog timer (WDT) is a device that performs a specific operation after a certain period of time if something goes wrong and the system does not recover on its own. A watchdog timer can be programmed to perform a warm boot (restarting the system) after a certain number of seconds.

Hardware Monitor

The Hardware Monitor (HWM) API is a system health supervision API that inspects certain condition indexes, such as fan speed, temperature and voltage.

4.2.1.4 Power Saving**CPU Speed**

Makes use of Intel SpeedStep technology to save power consumption. The system will automatically adjust the CPU speed depending on the system loading.

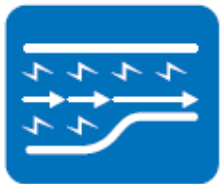
System Throttling

Refers to a series of methods for reducing power consumption in computers by lowering the clock frequency. This API allows the user to adjust the clock from 87.5% to 12.5%.

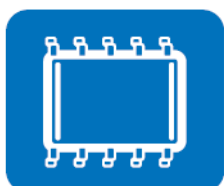
4.2.2 Software Utility**BIOS Flash**

The BIOS Flash utility allows customers to update the flash ROM BIOS version, or use it to back up current BIOS by copying it from the flash chip to a file on customers' disk. The BIOS Flash utility also provides a command line version and an API for fast implementation into customized applications.

Embedded Security ID



The embedded application is the most important property of a system integrator. It contains valuable intellectual property, design knowledge and innovation; but it's also easy to copy. Embedded Security ID utility provides reliable security functions for customers to secure their application data within the embedded BIOS.

Monitoring



The Monitoring is a utility for customer to monitor the system health, like voltage, CPU and system temperature and fan speed. These items are important to a device, if the critical errors occur and are not solved immediately, permanent damage may be caused.

eSOS



The eSOS is a small OS stored in BIOS ROM. It will boot up in case of a main OS crash. It will diagnose the hardware status, and then send an e-mail to the designated administrator. The eSOS also provide for remote connection via Telnet server and FTP server so the administrator can attempt to rescue the system. Note: This function requires BIOS customization.

Chapter 5

Chipset Software
Installation Utility

5.1 Before You Begin

To facilitate the installation of the enhanced display drivers and utility software, read the instructions in this chapter carefully. The drivers for the AIMB-230 are located on the software installation CD. The driver in the folder of the driver CD will guide and link you to the utilities and drivers under a Windows system. Updates are provided via Service Packs from Microsoft*.

Note! *The files on the software installation CD are compressed. Do not attempt to install the drivers by copying the files manually. You must use the supplied SETUP program to install the drivers.*



Before you begin, it is important to note that most display drivers need to have the relevant software application already installed in the system prior to installing the enhanced display drivers. In addition, many of the installation procedures assume that you are familiar with both the relevant software applications and operating system commands. Review the relevant operating system commands and the pertinent sections of your application software's user manual before performing the installation.

5.2 Introduction

The Intel® Chipset Software Installation (CSI) utility installs the Windows INF files that outline to the operating system how the chipset components will be configured. This is needed for the proper functioning of the following features:

- Core PCI PnP services
- Serial ATA interface support
- USB 2.0/3.0 support
- Identification of Intel® chipset components in the Device Manager

Note! *This utility is used for the following versions of Windows, and it has to be installed **before** installing all the other drivers:*



- Windows 7 (32-bit)
- Windows 7 (64-bit)

5.3 Windows 7 Driver Setup

1. Insert the driver CD into your system's CD-ROM drive. You can see the driver folder items. Navigate to the "Chipset" folder and click "infnst_autol.exe" to complete the installation of the driver.

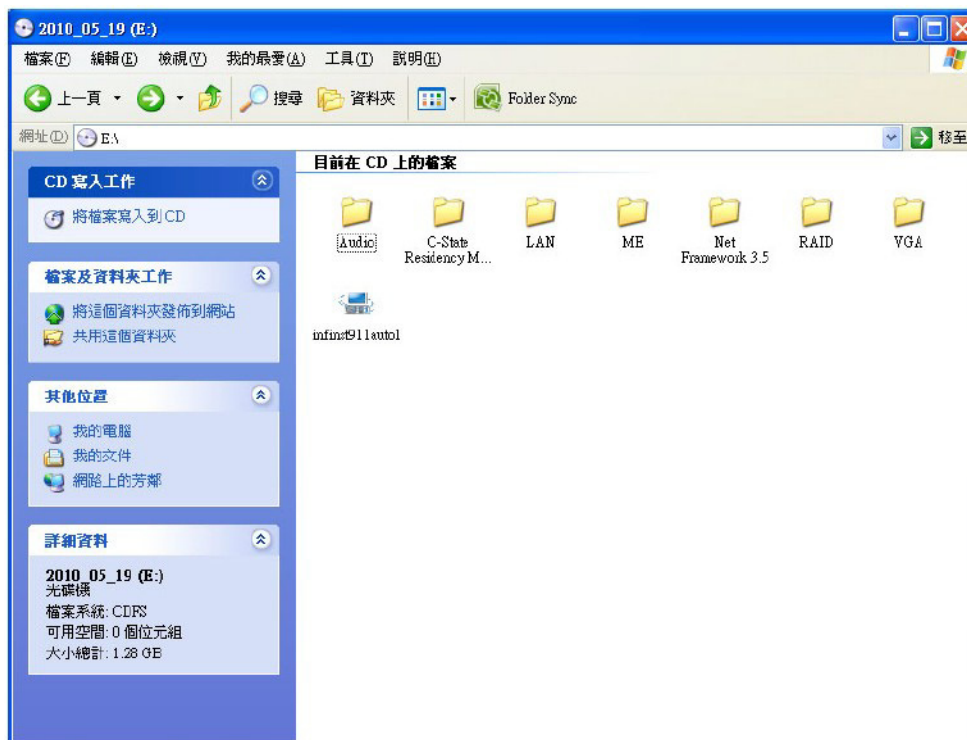

Chapter 6

VGA Setup

6.1 Introduction

The Intel mobile Core i7, Core i5, Core i3, Celeron CPUs with dual core are embedded with an integrated graphics controller. You need to install the VGA driver to enable the function.

Optimized integrated graphic solution: With Intel Graphics Flexible, it supports versatile display options and 32-bit 3D graphics engine. Dual independent display, enhanced display modes for widescreen flat panels for extend, twin, and clone dual display mode, and optimized 3D support deliver an intensive and realistic visual experience.

6.2 Windows 7

Note! Before installing this driver, make sure the CSI utility has been installed in your system. See Chapter 5 for information on installing the CSI utility.



Insert the driver CD into your system's CD-ROM drive. You can see the driver folders items. Navigate to the "VGA" folder and click "setup.exe" to complete the installation of the drivers for Windows 7 and Windows XP.

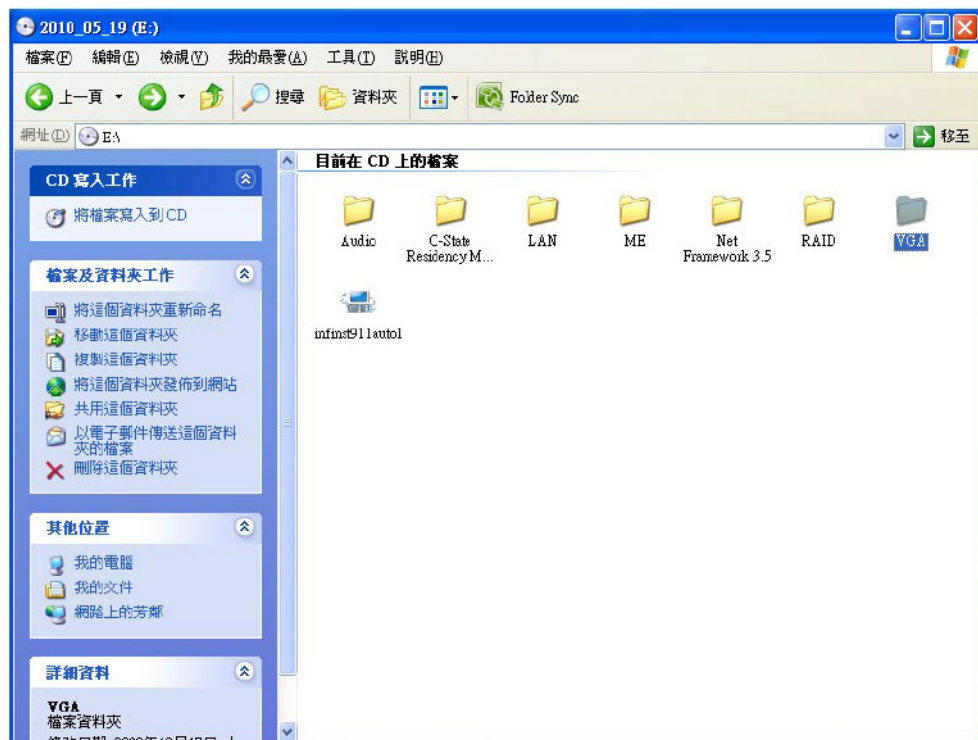

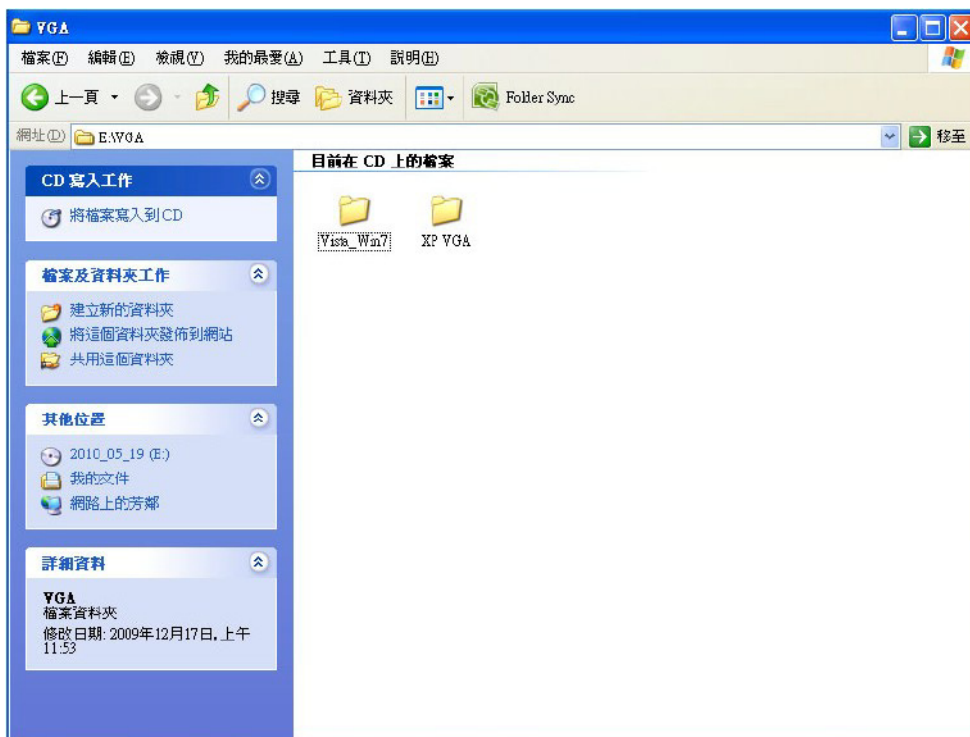

Chapter 7

LAN Configuration

7.1 Introduction

The AIMB-230 has dual Gigabit Ethernet LANs via dedicated PCI Express x1 lanes (Realtek RTL8111E(LAN1) and RTL8111E (LAN2)) that offer bandwidth of up to 500 MB/sec, eliminating the bottleneck of network data flow and incorporating Gigabit Ethernet at 1000 Mbps.

7.2 Features

- Integrated 10/100/1000 Mbps transceiver
- 10/100/1000 Mbps triple-speed MAC
- High-speed RISC core with 24-KB cache
- On-chip voltage regulation
- Wake-on-LAN (WOL) support
- PCI Express X1 host interface

7.3 Installation

Note! *Before installing the LAN drivers, make sure the CSI utility has been installed on your system. See Chapter 5 for information on installing the CSI utility.*



The AIMB-230's Realtek RTL8111E (LAN1) and RTL8111E (LAN2) Gigabit integrated controllers support all major network operating systems. However, the installation procedure varies from system to system. Please find and use the section that provides the driver setup procedure for the operating system you are using.

7.4 Windows® 7 Driver Setup (Realtek RTL8111E)

Insert the driver CD into your system's CD-ROM drive. Select the LAN folder then navigate to the directory for your OS.

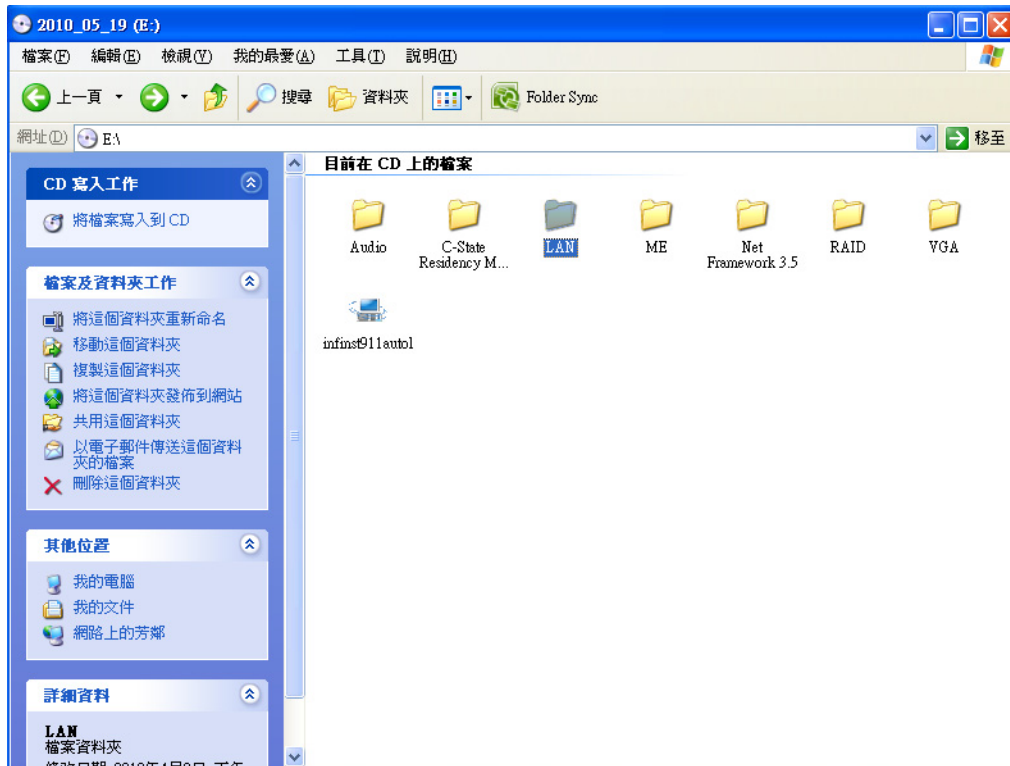

Appendix **A**

I/O Pin Assignments

A.1 USB Header (USB56)

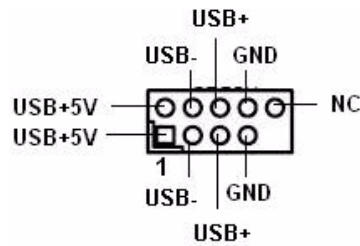

Table A.1: USB Header (USB56)

Pin	Signal	Pin	Signal
1	USB0_VCC5	2	USB1_VCC5
3	USB0_D-	4	USB1_D-
5	USB0_D+	6	USB1_D+
7	GND	8	GND
9	Key	10	N/C

A.2 DP/HDMI Connector (DP-HDMI1)

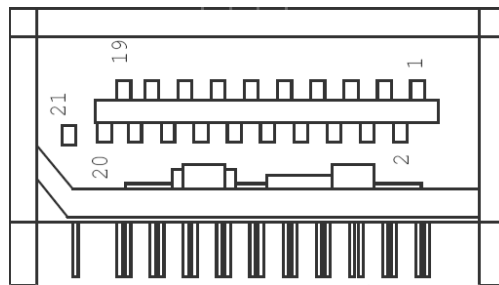

Table A.2: DP/HDMI Connector (DP-HDMI1)

Pin	Signal	Pin	Signal
1	DP_0+	12	DP_3-
2	GND	13	NC
3	DP_0-	14	NC
4	DP_1+	15	DP-HDMI_CLK_AUX+
5	GND	16	DP-HDMI_DATA
6	DP_1-	17	DP-HDMI_AUX
7	DP_2+	18	DP-HPD
8	GND	19	HDMI_HPD
9	DP_2-	20	+V3.3
10	DP_3+	21	DP/HDMI_DET
11	GND		

A.3 DP Connector

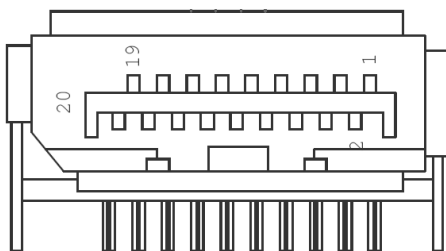

Table A.3: DP Connector

Pin	Signal	Pin	Signal
1	DP2_0+	11	GND
2	GND	12	DP2_3-
3	DP2_0-	13	DP2_AUX_EN
4	DP2_1+	14	GND
5	GND	15	DP2_AUX+
6	DP2_1-	16	GND
7	DP2_2+	17	DP2_AUX-
8	GND	18	DP2_HPD
9	DP2_2-	19	GND
10	DP2_3+	20	+V3.3

A.4 SPI_CN1: SPI Fresh Card Pin Connector

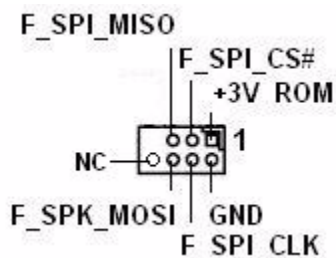

Table A.4: SPI_CN1:SPI Fresh Card Pin Connector

Pin	Signal	Pin	Signal
1	+F1_3V	2	GND
3	F1_SPI_CS#_Q	4	F1_SPI_CLK_Q
5	F1_SPI_MISO_Q	6	F1_SPI_MOSI_Q
7	KEY	8	NC

A.5 PS/2 Keyboard and Mouse Connector (KBMS1)

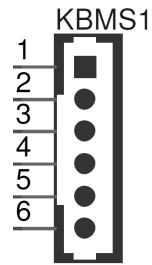

Table A.5: PS/2 Keyboard and Mouse Connector (KBMS1)

Pin	Signal	Pin	Signal
1	KB_CLK	4	GND
2	KB_DAT	5	VCC_KBMS
3	MS_DAT	6	MS_CLK

A.6 CPU Fan Power Connector (CPUFAN1/ CPUFAN1_1)

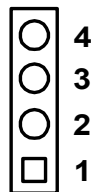

Table A.6: CPU Fan Power Connector (CPUFAN1/CPUFAN_1)

Pin	Signal
1	GND
2	CPU FAN VCC
3	DETECT
4	CPU PWM

A.7 CPU Fan Speed Control (JCPUFAN1)

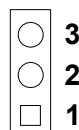

Table A.7: CPU Fan Speed Control (JCPUFAN1)

Pin	Signal
1-2	VCC Control
2-3*	PWM Control

A.8 System Fan Power Connector (SYS_FAN1)

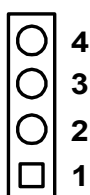

Table A.8: System Fan Power Connector (SYSFAN1)

Pin	Signal
1	GND
2	SYS FAN VCC
3	DETECT
4	SYS FAN PWM

A.9 System Fan Speed Control (JSYSFAN1)

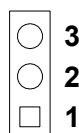

Table A.9: CPU Fan Speed Control (JCPUFAN1)

Pin	Signal
1-2	VCC Control
2-3*	PWM Control

A.10 Power LED & Keyboard Lock Connector (JFP3)

You can use an LED to indicate when the single board computer is on. Pin 1 of JFP3 supplies the LED's power, and Pin 3 is the ground.

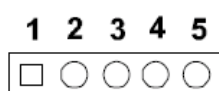

Table A.10: Power LED & Keyboard Lock Connector (JFP2)

Pin	Function
1	LED power
2	NC
3	GND
4	KEYLOCK#
5	GND

A.11 Power Switch/Reset Switch/HDD LED/SMBus/ Speaker (JFP1/JFP2)

The single board computer has its own buzzer. You can also connect it to the external speaker on your computer chassis.

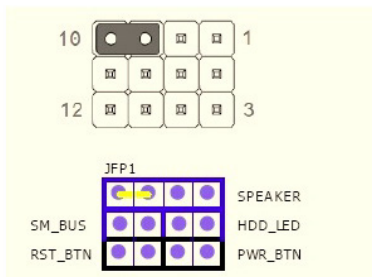

Table A.11: Power Switch/Reset Switch/HDD LED/SMBus/Speaker (JFP1/JFP2)

Pin	Signal	Pin	Signal
1	+5V	7	Speaker 3
2	+3.3V	8	SMB_DAT
3	Power Switch+	9	Reset Switch+
4	NC	10	Speaker 4
5	HDD LED	11	SMB_CLK
6	GND	12	GND

A.12 USB/LAN Ports (LAN1/LAN2/USB12/USB34)

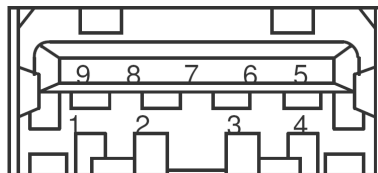

Table A.12: USB Port

Pin	Signal	Pin	Signal
1	VCC	6	USB3_RX+
2	USB2_D-	7	GND
3	USB2_D+	8	USB3_TX-
4	GND	9	USB3_TX+
5	USB3_RX-		

Table A.13: Ethernet 10/100/1000 Mbps RJ-45 Port

Pin	Signal	Pin	Signal
1	MDI0+	5	MDI2-
2	MDI0-	6	MDI1-
3	MDI1+	7	MDI3+
4	MDI2+	8	MDI3-

A.13 Line Out, Mic In Connector (AUDIO1/AUDIO2)

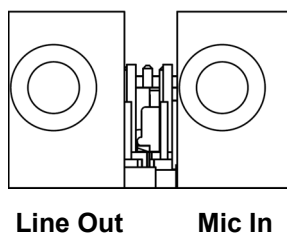

A.14 Serial ATA (SATA1 ~ 3)

Table A.14: Serial ATA 0/1 (SATA1/SATA2)

Pin	Signal	Pin	Signal
1	GND	2	SATA_0TX+
3	SATA_0TX-	4	GND
5	SATA_0RX-	6	SATA_0RX+
7	GND	8	

A.15 AT/ATX Mode (PSON1)

Table A.15: AT/ATX Mode (PSON1)

Pin	Signal	Pin	Signal
1	#PSON_SIO (to super IO)	2	#PSON (to power supply)
3	GND		

A.16 HD Audio Interface (FP_AUDIO1)

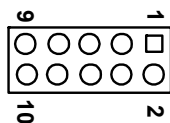

Table A.16: AC-97 Audio Interface (FPAUD1)

Pin	Signal	Pin	Signal
1	MIC2_L	2	GND
3	MIC2_R	4	FP_AUD_DET
5	LOUT2_R	6	SRTN1
7	LOUT2_DET	8	KEY
9	LOUT2_L	10	SRTN2

A.17 GPIO Pin Header (GPIO1)

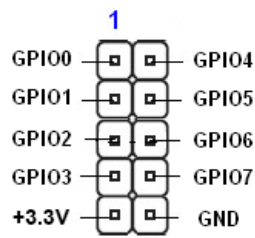

Table A.17: GPIO Pin Header (GPIO1)

Pin	Signal	Pin	Signal
1	GPIO0	2	GPIO4
3	GPIO1	4	GPIO5
5	GPIO2	6	GPIO6
7	GPIO3	8	GPIO7
9	+3.3V	10	GND

A.18 LVDS Connector: LVDS1

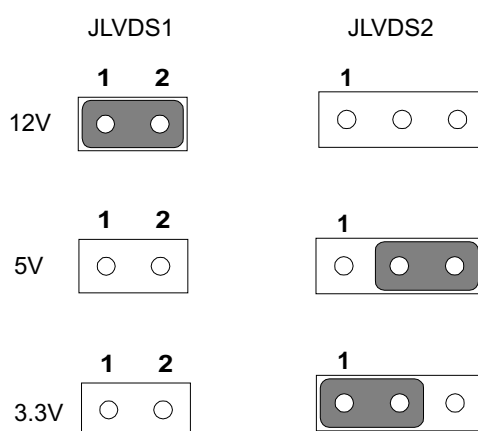

Table A.18: LVDS Connector: LVDS1

Pin	Signal	Pin	Signal
1	VDD_LVDS	2	VDD_LVDS
3	GND	4	GND
5	VDD_LVDS	6	VDD_LVDS
7	LVDS_L0_N	8	LVDS_U0_N
9	LVDS_L0_P	10	LVDS_U0_P
11	GND	12	GND
13	LVDS_L1_N	14	LVDS_U1_N
15	LVDS_L1_P	16	LVDS_U1_P
17	GND	18	GND
19	LVDS_L2_N	20	LVDS_U2_N
21	LVDS_L2_P	22	LVDS_U2_P

23	GND	24	GND
25	LVDS_CLKL_N	26	LVDS_CLKU_N
27	LVDS_CLKL_P	28	LVDS_CLKU_P
29	GND	30	GND
31	LVDS_CH7511_DDC_CLK	32	LVDS_CH7511_DDC_DATA
33	GND	34	GND
35	LVDS_L3_N	36	LVDS_U3_N
37	LVDS_L3_P	38	LVDS_U3_P
39	LVDS_BL_EN	40	VCON

A.19 LVDS Power Jumper (JLVDS1/JLVDS2)



Note! *JLVDS1 and JLVDS2 can't be used at the same time, or else M/B would be damaged.*



A.20 LVDS Inverter (INV1)

Table A.19: LVDS Power Jumper

Pin	Signal
1	+12V
2	GND
3	BL_EN
4	BL_CLT
5	+5V

A.21 LVDS Backlight control (JVBR1)

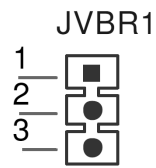

Table A.20: LVDS Backlight control(JVBR1)

Pin	Signal
1-2*	EC control
2-3	NC

A.22 ATX12V/12V DC IN (ATX12V1/DCIN1)

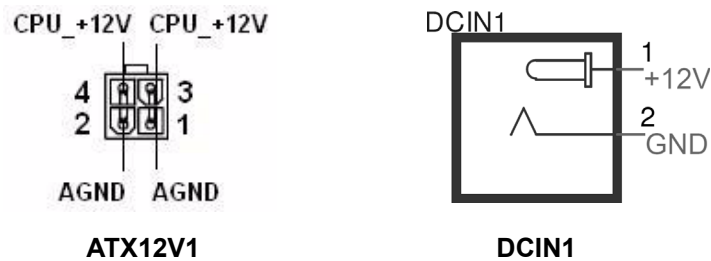

Table A.21: ATX 12 V connector (ATX12V1)

Pin	Signal	Pin	Signal
1	aGND	2	aGND
3	CPU_+12V	4	CPU_+12V

A.23 HD Digital Audio Interface (SPDIF_O1)

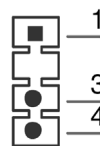

Table A.22: HD Digital Audio Interface (SPDIF_OUT1)

Pin	Signal
1	+5V
3	SPDIF Out
4	GND

A.24 Amplifier Audio Output (AMPJ1)

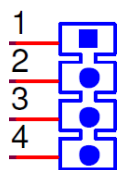

Table A.23: Amplifier Audio Output (AMPJ1)

Pin	Signal	Pin	Signal
1	AMP_L-	2	AMP_L+
3	AMP_R-	4	AMP_R+

A.25 COM1 Protocols Selection (JSETCOM1)

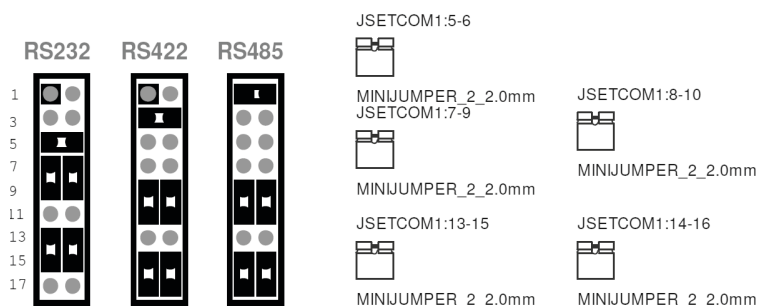

Table A.24: COM1 Protocol Selection (JSETCOM1)

RS-232*	5-6	7-9	8-10
	13-15	14-16	
RS-422	3-4	9-11	10-12
	15-17	16-18	
RS-485	1-2	9-11	10-12
	15-17	16-18	

Note! Without H/W auto flow control.



A.26 COM1/COM2 Box Header (COM1/COM2)

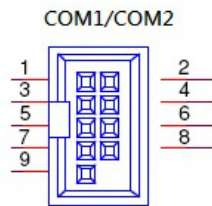

Table A.25: COM1/COM2 Box Header (COM1/COM2)

Pin	Signal	Pin	Signal
1	DCD#	2	DSR#
3	RXD	4	RTS#
5	TXD	6	CTS#
7	DTR#	8	RI#
9	GND		

A.27 COM1 RS422/485 Master or Slave Selection (COM1_S1~S4)

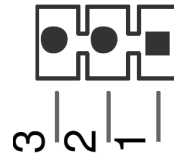

Table A.26: COM1 RS422/485 Master or Slave Selection (COM1_S1~S4)

COM1_S1	1-2*	slave
	2-3	master
COM1_S2	1-2*	slave
	2-3	master
COM1_S3	1-2*	slave
	2-3	master
COM1_S4	1-2*	slave
	2-3	master

A.28 Watch dog and Open chassis alarm (JWDT1+JOBS1)

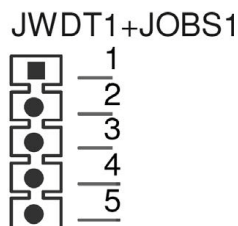

Table A.27: Watchdog and Open Chassis Alarm (JWDT1+JOBS1)

Pin	Signal	Pin	Signal
1	NC	4	EC_Beep
2	WG	5	Beep
3	Reset		

JWDT1+JOBS1: 2-3 WDT control by EC*; 4-5 Alarm by EC*

A.29 Low Pin Count Bus (LPC1)

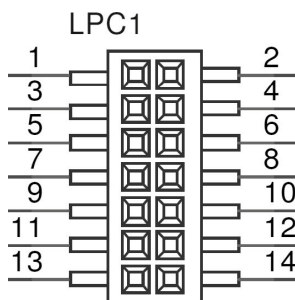

Table A.28: Low Pin Count Bus (LPC1)

Pin	Signal	Pin	Signal
1	CLK24M	8	GND
2	LPC_AD1	9	LPC_AD2
3	80PORT_RST	10	LPC1_SMB_CLK
4	LPC_AD0	11	SERIRQ
5	LPC_FRAME	12	LPC1_SMB_DAT
6	+3.3V	13	+5VSB
7	LPC_AD3	14	+5V

ADVANTECH

Enabling an Intelligent Planet

www.advantech.com

Please verify specifications before quoting. This guide is intended for reference purposes only.

All product specifications are subject to change without notice.

No part of this publication may be reproduced in any form or by any means, electronic, photocopying, recording or otherwise, without prior written permission of the publisher.

All brand and product names are trademarks or registered trademarks of their respective companies.

© Advantech Co., Ltd. 2015