

Advantech

AQD-D4U8GN24-SE

Datasheet

Rev. 1.0
2017-01-05

Description

DDR4 1.2V Unbuffered DIMM is high-speed, low power memory module that use 1Gx8bits DDR4 SDRAM in FBGA package and a 4096 bits serial EEPROM on a 288-pin printed circuit board. DDR4 1.2V Unbuffered DIMM is a Dual In-Line Memory Module and is intended for mounting into 288-pin edge connector sockets.

Synchronous design allows precise cycle control with the use of system clock. Data I/O transactions are possible on both edges of DQS. Range of operation frequencies, programmable latencies allow the same device to be useful for a variety of high bandwidth, high performance memory system applications.

Features

- RoHS compliant products
- JEDEC standard 1.2V (1.14V to 1.26V) Power supply
- VDDQ=1.2V (1.14V to 1.26V)
- Clock Freq: 1200MHZ for 2400Mb/s/Pin
- 16 Banks (4 Bank Groups)
- Programmable CAS Latency: 10, 11, 12, 13, 14,15,16, 17,18
- Programmable Additive Latency (Posted /CAS): 0,CL-2 or CL-1 clock
- Programmable /CAS Write Latency (CWL) = 12,16 (DDR4-2400)
- 8 bit pre-fetch
- Burst Length: 4, 8
- Bi-directional Differential Data-Strobe
- On Die Termination with ODT pin
- Serial presence detect with EEPROM
- Asynchronous reset
- PCB: 30μ gold finger

Pin Identification

| Symbol | Function |
|----------------------------|---|
| A0–A17 | Register address input |
| BA0, BA1 | Register bank select input |
| BG0, BG1 | Register bank group select input |
| RAS_n2 | Register row address strobe input |
| CAS_n3 | Register column address strobe input |
| WE_n4 | Register write enable input |
| CS0_n, CS1_n, CS2_n, CS3_n | DIMM Rank Select Lines input |
| CKE0, CKE1 | Register clock enable lines input |
| ODT0, ODT1 | Register on-die termination control lines input |
| ACT_n | Register input for activate input |
| DQ0–DQ63 | DIMM memory data bus |
| CB0–CB7 | DIMM ECC check bits |
| DQS0_t–DQS17_t | Data Buffer data strobes (positive line of differential pair) |
| DQS0_c–DQS17_c | Data Buffer data strobes (negative line of differential pair) |
| CK0_t, CK1_t | Register clock input (positive line of differential pair) |
| CK0_c, CK1_c | Register clocks input (negative line of differential pair) |
| SCL | I2C serial bus clock for SPD/TS and register |
| SDA | I2C serial bus data line for SPD/TS and register |
| SA0–SA2 | I2C slave address select for SPD/TS and register |

| | |
|---------|--|
| PAR | Register parity input |
| VDD | SDRAM core power supply |
| VPP | SDRAM activating power supply |
| VREFCA | SDRAM command/address reference supply |
| VSS | Power supply return (ground) |
| VDDSPD | Serial SPD/TS positive power supply |
| ALERT_n | Register ALERT_n output |
| RESET_n | Set Register and SDRAMs to a Known State |
| EVENT_n | SPD signals a thermal event has occurred |
| VTT | SDRAM I/O termination supply |
| RFU | Reserved for future use |
| NC | No Connection |

Dimensions (Unit: millimeter)

Unit: mm

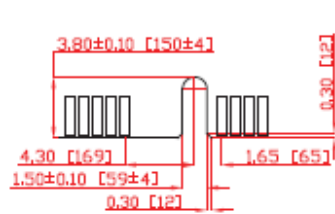
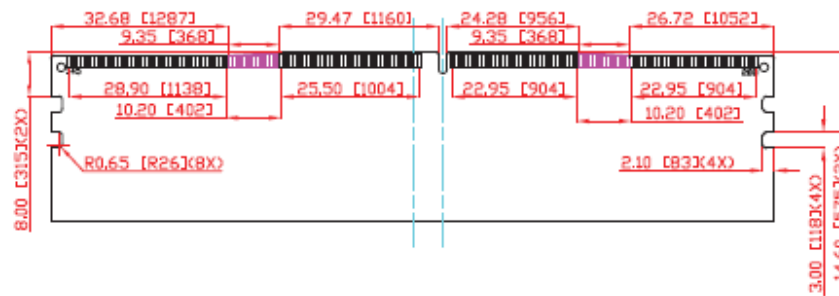
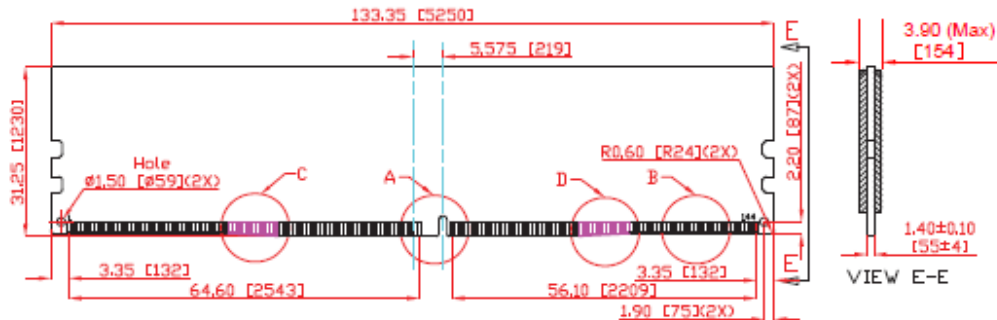

Detail A

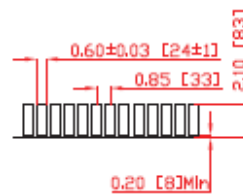

Detail B

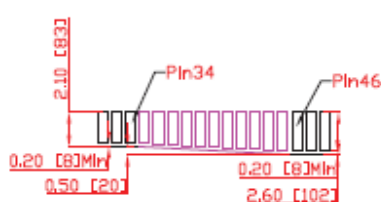

Detail C
30µ gold finger

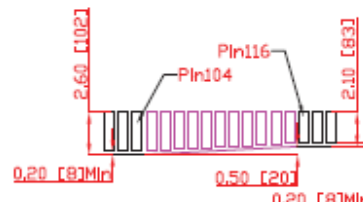

Detail D

(All dimensions are in millimeters with ±0.15mm tolerance unless specified otherwise.)



Enabling an Intelligent Planet

288 Pin DDR4 1.2V 2400 UDIMM
8GB Based on 1Gx8
AQD-D4U8GN24-SE

Pin Assignments

| Pin No. | Pin name | Pin No. | Pin name | Pin No. | Pin name | Pin No. | Pin name | Pin No. | Pin name | Pin No. | Pin name | Pin No. | Pin name | Pin No. | Pin name |
|---------|----------------------|---------|----------|---------|-------------------------|---------|----------|---------|-----------|---------|----------|---------|-------------------------|---------|----------|
| 1 | NC | 145 | NC | 39 | VSS | 183 | DQ25 | 77 | VTT | 221 | VTT | 114 | VSS | 258 | DQ47 |
| 2 | VSS | 146 | VREFCA | 40 | DM3_n, DBI3_n, NC | 184 | VSS | KEY | | | | 115 | DQ42 | 259 | VSS |
| 3 | DQ4 | 147 | VSS | 41 | NC | 185 | DQS3_c | 78 | EVENT_n | 222 | PARITY | 116 | VSS | 260 | DQ43 |
| 4 | VSS | 148 | DQ5 | 42 | VSS | 186 | DQS3_t | 79 | A0 | 223 | VDD | 117 | DQ52 | 261 | VSS |
| 5 | DQ0 | 149 | VSS | 43 | DQ30 | 187 | VSS | 80 | VDD | 224 | BA1 | 118 | VSS | 262 | DQ53 |
| 6 | VSS | 150 | DQ1 | 44 | VSS | 188 | DQ31 | 81 | BA0 | 225 | A10/AP | 119 | DQ48 | 263 | VSS |
| 7 | DM0_n,DBI0_n, NC | 151 | VSS | 45 | DQ26 | 189 | VSS | 82 | RAS_n/A16 | 226 | VDD | 120 | VSS | 264 | DQ49 |
| 8 | NC | 152 | DQS0_c | 46 | VSS | 190 | DQ27 | 83 | VDD | 227 | RFU | 121 | DM6_n, DBI6_n, NC | 265 | VSS |
| 9 | VSS | 153 | DQS0_t | 47 | CB4, NC | 191 | VSS | 84 | CS0_n | 228 | WE_n/A14 | 122 | NC | 266 | DQS6_c |
| 10 | DQ6 | 154 | VSS | 48 | VSS | 192 | CB5, NC | 85 | VDD | 229 | VDD | 123 | VSS | 267 | DQS6_t |
| 11 | VSS | 155 | DQ7 | 49 | CB0, NC | 193 | VSS | 86 | CAS_n/A15 | 230 | NC | 124 | DQ54 | 268 | VSS |
| 12 | DQ2 | 156 | VSS | 50 | VSS | 194 | CB1, NC | 87 | ODT0 | 231 | VDD | 125 | VSS | 269 | DQ55 |
| 13 | VSS | 157 | DQ3 | 51 | DM8_n, DBI8_n, NC | 195 | VSS | 88 | VDD | 232 | A13 | 126 | DQ50 | 270 | VSS |
| 14 | DQ12 | 158 | VSS | 52 | NC | 196 | DQS8_c | 89 | CS1_n | 233 | VDD | 127 | VSS | 271 | DQ51 |
| 15 | VSS | 159 | DQ13 | 53 | VSS | 197 | DQS8_t | 90 | VDD | 234 | NC | 128 | DQ60 | 272 | VSS |
| 16 | DQ8 | 160 | VSS | 54 | CB6, NC | 198 | VSS | 91 | ODT1 | 235 | NC | 129 | VSS | 273 | DQ61 |
| 17 | VSS | 161 | DQ9 | 55 | VSS | 199 | CB7, NC | 92 | VDD | 236 | VDD | 130 | DQ56 | 274 | VSS |
| 18 | DM1_n, DBI1_n, NC | 162 | VSS | 56 | CB2, NC | 200 | VSS | 93 | NC | 237 | NC | 131 | VSS | 275 | DQ57 |
| 19 | NC | 163 | DQS1_c | 57 | VSS | 201 | CB3, NC | 94 | VSS | 238 | SA2 | 132 | DM7_n, DBI7_n, NC | 276 | VSS |
| 20 | VSS | 164 | DQS1_t | 58 | RESET_n | 202 | VSS | 95 | DQ36 | 239 | VSS | 133 | NC | 277 | DQS7_c |
| 21 | DQ14 | 165 | VSS | 59 | VDD | 203 | CKE1 | 96 | VSS | 240 | DQ37 | 134 | VSS | 278 | DQS7_t |
| 22 | VSS | 166 | DQ15 | 60 | CKE0 | 204 | VDD | 97 | DQ32 | 241 | VSS | 135 | DQ62 | 279 | VSS |
| 23 | DQ10 | 167 | VSS | 61 | VDD | 205 | RFU | 98 | VSS | 242 | DQ33 | 136 | VSS | 280 | DQ63 |

| | | | | | | | | | | | | | | | |
|----|----------------------|-----|--------|----|----------|-----|---------|-----|-------------------------|-----|--------|-----|------|-----|--------|
| 24 | VSS | 168 | DQ11 | 62 | ACT_n | 206 | VDD | 99 | DM4_n, DBI4_n, NC | 243 | VSS | 137 | DQ58 | 281 | VSS |
| 25 | DQ20 | 169 | VSS | 63 | BG0 | 207 | BG1 | 100 | NC | 244 | DQS4_c | 138 | VSS | 282 | DQ59 |
| 26 | VSS | 170 | DQ21 | 64 | VDD | 208 | ALERT_n | 101 | VSS | 245 | DQS4_t | 139 | SA0 | 283 | VSS |
| 27 | DQ16 | 171 | VSS | 65 | A12/BC_n | 209 | VDD | 102 | DQ38 | 246 | VSS | 140 | SA1 | 284 | VDDSPD |
| 28 | VSS | 172 | DQ17 | 66 | A9 | 210 | A11 | 103 | VSS | 247 | DQ39 | 141 | SCL | 285 | SDA |
| 29 | DM2_n, DBI2_n, NC | 173 | VSS | 67 | VDD | 211 | A7 | 104 | DQ34 | 248 | VSS | 142 | VPP | 286 | VPP |
| 30 | NC | 174 | DQS2_c | 68 | A8 | 212 | VDD | 105 | VSS | 249 | DQ35 | 143 | VPP | 287 | VPP |
| 31 | VSS | 175 | DQS2_t | 69 | A6 | 213 | A5 | 106 | DQ44 | 250 | VSS | 144 | RFU | 288 | VPP |
| 32 | DQ22 | 176 | VSS | 70 | VDD | 214 | A4 | 107 | VSS | 251 | DQ45 | | | | |
| 33 | VSS | 177 | DQ23 | 71 | A3 | 215 | VDD | 108 | DQ40 | 252 | VSS | | | | |
| 34 | DQ18 | 178 | VSS | 72 | A1 | 216 | A2 | 109 | VSS | 253 | DQ41 | | | | |
| 35 | VSS | 179 | DQ19 | 73 | VDD | 217 | VDD | 110 | DM5_n, DBI5_n, NC | 254 | VSS | | | | |
| 36 | DQ28 | 180 | VSS | 74 | CK0_t | 218 | CK1_t | 111 | NC | 255 | DQS5_c | | | | |
| 37 | VSS | 181 | DQ29 | 75 | CK0_c | 219 | CK1_c | 112 | VSS | 256 | DQS5_t | | | | |
| 38 | DQ24 | 182 | VSS | 76 | VDD | 220 | VDD | 113 | DQ46 | 257 | VSS | | | | |

NOTE :

1. Address A17 is only valid for 16 Gb x4 based SDRAMs.
2. RAS_n is a multiplexed function with A16.
3. CAS_n is a multiplexed function with A15.
4. WE_n is a multiplexed function with A14.

Block Diagram 8GB, 1Gx64 Module(1 Rank x8)

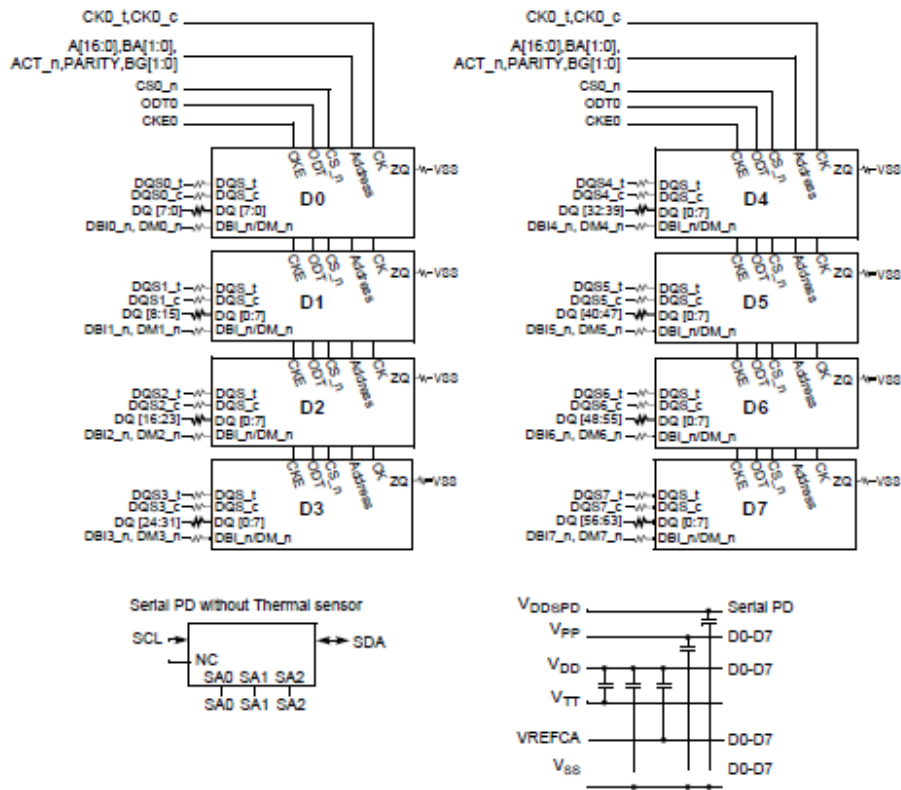

- Note 1: CK1_t, CK1_c terminated with 75 Ω ± 5% resistor.
- Note 2: Unless otherwise noted resistors are 15 Ω ± 5%.
- Note 3: ZQ resistors are 240 Ω ± 1%. For all other resistor values refer to the appropriate wiring diagram.
- Note 4: Event_n isn't used for SPD without TS. Option Resistor for it should be unplaced.

This technical information is based on industry standard data and tests believed to be reliable. However, Advantech makes no warranties, either expressed or implied, as to its accuracy and assume no liability in connection with the use of this product. Advantech reserves the right to make changes in specifications at any time without prior notice.

Operating Temperature Condition

| Parameter | Symbol | Rating | Unit | Note |
|-----------------------|--------|---------|------|------|
| Operating Temperature | TOPER | 0 to 85 | °C | 1,2 |

Note: 1. Operating Temperature is the case surface temperature on the center/top side of the DRAM. For the measurement conditions, please refer to JESD51-2 standard.
 2. At 0 - 85C, operation temperature range are the temperature which all DRAM specification will be supported.

Absolute Maximum DC Ratings

| Parameter | Symbol | Value | Unit | Note |
|-------------------------------------|-----------|------------|------|------|
| Voltage on VDD relative to Vss | VDD | -0.3 ~ 1.5 | V | 1,3 |
| Voltage on VDDQ pin relative to Vss | VDDQ | -0.3 ~ 1.5 | V | 1,3 |
| Voltage on VPP pin relative to Vss | VPP | -0.3 ~ 3.0 | V | 4 |
| Voltage on any pin relative to Vss | VIN, VOUT | -0.3 ~ 1.5 | V | 1,3 |
| Storage temperature | TSTG | -55~+100 | °C | 1,2 |

Note: 1. Stresses greater than those listed under “Absolute Maximum Ratings” may cause permanent damage to the device. This is a stress rating only and functional operation of the device at these or any other conditions above those indicated in the operational sections of this specification is not implied. Exposure to absolute maximum rating conditions for extended periods may affect reliability
 2. Storage Temperature is the case surface temperature on the center/top side of the DRAM. For the measurement conditions, please refer to JESD51-2 standard.
 3. VDD and VDDQ must be within 300 mV of each other at all times and VREFCA must be not greater than 0.6 x VDDQ, When VDD and VDDQ are less than 500 mV; VREFCA may be equal to or less than 300 mV
 4. VPP must be equal or greater than VDD/VDDQ at all times.

AC & DC Operating Conditions

Recommended DC operating conditions

| Symbol | Parameter | Rating | | | Unit | NOTE |
|--------|---------------------------|--------|------|------|------|-------|
| | | Min. | Typ. | Max. | | |
| VDD | Supply Voltage | 1.14 | 1.2 | 1.26 | V | 1,2,3 |
| VDDQ | Supply Voltage for Output | 1.14 | 1.2 | 1.26 | V | 1,2,3 |
| VPP | Peak-to-Peak Voltage | 2.375 | 2.5 | 2.75 | V | 3 |

NOTE:

- Under all conditions VDDQ must be less than or equal to VDD.
- VDDQ tracks with VDD. AC parameters are measured with VDD and VDDQ tied together.
- DC bandwidth is limited to 20MHz.

AC & DC Logic Input Levels for Single-Ended Signals

| Symbol | Parameter | DDR4-1600/1866/2133/2400 | | Unit | NOTE |
|---------------|---------------------------------------|--------------------------|--------------|------|------|
| | | Min. | Max. | | |
| VIH.CA(DC75) | DC input logic high | VREFCA+ 0.075 | VDD | V | |
| VIL.CA(DC75) | DC input logic low | VSS | VREFCA-0.075 | V | |
| VIH.CA(AC100) | AC input logic high | VREF + 0.1 | Note 2 | V | 1 |
| VIL.CA(AC100) | AC input logic low | Note 2 | VREF - 0.1 | V | 1 |
| VREFCA(DC) | Reference Voltage for ADD, CMD inputs | 0.49*VDD | 0.51*VDD | V | 2,3 |

NOTE :

- See “Overshoot and Undershoot Specifications” on section.
- The AC peak noise on VREFCA may not allow VREFCA to deviate from VREFCA(DC) by more than ± 1% VDD (for reference : approx. ± 12mV)
- For reference : approx. VDD/2 ± 12mV

Timing Parameters & Specifications

| Speed | | DDR4 2400 | | Unit |
|---|----------|-------------------|--------|------------|
| Parameter | Symbol | Min | Max | |
| Average Clock Period | tCK | 0.833 | <0.938 | ns |
| CK high-level width | tCH | 0.48 | 0.52 | tCK |
| CK low-level width | tCL | 0.48 | 0.52 | tCK |
| DQS, /DQS to DQ skew, per group, per access | tDQSQ | - | 0.16 | tCK(avg)/2 |
| DQ output hold time from DQS, /DQS | tQH | 0.76 | - | tCK(avg)/2 |
| DQS_t and DQS_c low-impedance time (Referenced from RL-1) | tLZ(DQS) | -300 | 150 | ps |
| DQS_t and DQS_c high-impedance time (Referenced from RL+BL/2) | tHZ(DQS) | - | 150 | ps |
| DQS_t, DQS_c falling edge setup time to CK_t, CK_c rising edge | tDSS | 0.18 | - | tCK |
| DQS_t, DQS_c falling edge hold time from CK_t, CK_c rising edge | tDSH | 0.18 | - | tCK |
| DQS, /DQS Read preamble | tRPRE | 0.9 | - | tCK |
| | | 1.8 | - | tCK |
| DQS, /DQS differential Read postamble | tRPST | 0.33 | - | tCK |
| DQS, /DQS Write preamble | tWPRE | 0.9 | - | tCK |
| | | 1.8 | NA | tCK |
| DQS, /DQS Write postamble | tWPST | 0.33 | - | tCK |
| DQS, /DQS differential input low pulse width | tDQSL | 0.46 | 0.54 | tCK |
| DQS, /DQS differential input high pulse width | tDQSH | 0.46 | 0.54 | tCK |
| DQS, /DQS rising edge to CK, /CK rising edge | tDQSS | -0.27 | +0.27 | tCK |
| DQS, /DQS falling edge setup time to CK, /CK rising edge | tDSS | 0.18 | - | tCK |
| DQS, /DQS falling edge hold time to CK, /CK rising edge | tDSH | 0.18 | - | tCK |
| Delay from start of internal write transaction to internal read com-mand for different bank group | tWTR_S | max (2nCK, 2.5ns) | - | |
| Delay from start of internal write transaction to internal read com-mand for same bank group | tWTR_L | max (4nCK, 7.5ns) | | |
| Write recovery time | tWR | 15 | - | ns |
| Mode register set command cycle time | tMRD | 8 | - | nCK |
| CAS_n to CAS_n command delay for same bank group | tCCD_L | max(5 nCK, 5 ns) | - | nCK |

| CAS_n to CAS_n command delay for different bank group | tCCD_S | 4 | | nCK |
|---|--------------|---|-----|------|
| Auto precharge write recovery + precharge time | tDAL(min) | Programmed WR + roundup (tRP / tCK(avg)) | | nCK |
| ACTIVATE to ACTIVATE Command delay to different bank group for 2KB page size | tRRD_S(2K) | Max(4nCK,5 .3ns) | - | nCK |
| Parameter | Symbol | Min | Max | Unit |
| ACTIVATE to ACTIVATE Command delay to different bank group for 1KB page size | RRD_S(1K) | Max(4nCK,3 .3ns) | - | nCK |
| ACTIVATE to ACTIVATE Command delay to different bank group for 1/ 2KB page size | tRRD_S(1/2K) | Max(4nCK,3 .3ns) | | nCK |
| ACTIVATE to ACTIVATE Command delay to same bank group for 2KB page size | tRRD_L(2K) | Max(4nCK,6 .4ns) | | nCK |
| ACTIVATE to ACTIVATE Command delay to same bank group for 1KB page size | tRRD_L(1K) | Max(4nCK,4 .9ns) | | nCK |
| ACTIVATE to ACTIVATE Command delay to same bank group for 1/2KB page size | tRRD_L(1/2K) | Max(4nCK,4 .9ns) | | nCK |
| Four activate window for 2KB page size | tFAW_2K | Max(28nCK, 30ns) | - | ns |
| Four activate window for 1KB page size | tFAW_1K | Max(20nCK, 21ns) | | ns |
| Four activate window for 1/2KB page size | tFAW_1/2K | Max(16nCK, 13ns) | - | ns |
| Power-up and RESET calibration time | tZQinitl | 1024 | - | nCK |
| Normal operation Full calibration time | tZQoper | 512 | - | nCK |
| Normal operation short calibration time | tZQcs | 128 | - | nCK |
| Exit self refresh to commands not requiring a locked DLL | tXS | tRFC(min)+ 10ns | - | |
| Exit self refresh to commands requiring a locked DLL | tXSDLL | tDLLK(min) | - | |
| Internal read to precharge command delay | tRTP | max (4nCK,7.5ns) | - | |
| Minimum CKE low width for Self refresh entry to exit timing | tCKESR | tCKE(min)+ 1nCK | - | |
| Exit power down with DLL to any valid command: Exit Precharge Power Down with DLL | tXP | max (4nCK,6ns) | - | |
| CKE minimum pulse width (high and low pulse width) | tCKE | max (3nCK, 5ns) | | |
| Asynchronous RTT turn-on delay (Power-Down with DLL frozen) | tAONAS | 1.0 | 9.0 | ns |
| Asynchronous RTT turn-off delay (Power-Down with DLL frozen) | tAOFAS | 1.0 | 9.0 | ns |
| RTT dynamic change skew | tADC | 0.3 | 0.7 | ns |



Enabling an Intelligent Planet

288 Pin DDR4 1.2V 2400 UDIMM
8GB Based on 1Gx8
AQD-D4U8GN24-SE

SERIAL PRESENCE DETECT SPECIFICATION

8192MB(1024Mx64Bit) Serial Presence Detect for DDR4 DIMM (PC-19200) 2400 CL=17

| BYTE | FUNCTION DESCRIBED | FUNCTION SUPPORTED | HEX VALUE |
|------|--|--|-----------|
| 0 | Number of serial PD bytes written/SPD device size/CRC coverage | 512B Total, 384B Used | 23 |
| 1 | SPD revision | Revision 1.0 | 10 |
| 2 | Key byte/DRAM device type | DDR4 SDRAM | 0C |
| 3 | Key byte/module type | UDIMM | 02 |
| 4 | SDRAM density and banks | 8Gb, 4BG, 4Banks | 85 |
| 5 | SDRAM addressing | 16 rows, 10 columns | 21 |
| 6 | SDRAM package type | Monolithic DRAM Device | 00 |
| 7 | SDRAM optional features | Unlimited MAC | 08 |
| 8 | SDRAM thermal and refresh options | — | 00 |
| 9 | Other SDRAM optional feature | sPPR supported | 60 |
| 10 | Reserved | — | 00 |
| 11 | Module Nominal Voltage,VDD | 1.2V | 03 |
| 12 | Module organization | 1Ranks / x8 bits | 01 |
| 13 | Module memory bus width | 64 bits / non-ECC | 03 |
| 14 | Module thermal sensor | Thermal sensor incorporated not onto this assembly | 00 |
| 15 | Reserved | — | 00 |
| 16 | Reserved | — | 00 |
| 17 | Timebases | MTB 125ps, FTB 1ps | 00 |
| 18 | SDRAM minimum cycle time(tCKAVG min) | 0.833ns | 07 |
| 19 | SDRAM maximum cycle time(tCKAVG max) | 1.5ns | 0C |
| 20 | CAS latencies supported, first byte | CL=10,11,12,13,14,15,16,17,18 | F8 |
| 21 | CAS latencies supported, second byte | CL=10,11,12,13,14,15,16,17,18 | 0F |
| 22 | CAS latencies supported, third byte | CL=10,11,12,13,14,15,16,17,18 | 00 |
| 23 | CAS latencies supported, fourth byte | CL=10,11,12,13,14,15,16,17,18 | 00 |
| 24 | Minimum CAS latency time(tAA min) | 13.75ns | 6E |
| 25 | Minimum RAS to CAS delay time(tRCD min) | 13.75ns | 6E |
| 26 | Minimum Row precharge delay time(tRP min) | 13.75ns | 6E |

| | | | |
|-------|--|----------------------------|----|
| 27 | Upper nibbles for tRAS min and tRC min | tRAS = 32ns, tRC = 45.75ns | 11 |
| 28 | Minimum active to precharge delay time(tRAS min), least significant byte | 32ns | 00 |
| 29 | Minimum active to active/refresh delay time(tRC min), least significant byte | 45.75ns | 6E |
| 30 | Minimum refresh recovery delay time(tRFC1 min), LSB | 350ns | F0 |
| 31 | Minimum refresh recovery delay time(tRFC1 min), MSB | 350ns | 0A |
| 32 | Minimum refresh recovery delay time(tRFC2 min), LSB | 260ns | 20 |
| 33 | Minimum refresh recovery delay time(tRFC2 min), MSB | 260ns | 08 |
| 34 | Minimum refresh recovery delay time(tRFC3 min), LSB | 160ns | 00 |
| 35 | Minimum refresh recovery delay time(tRFC3 min), MSB | 160ns | 05 |
| 36 | Minimum four activate window time(tFAW min), most significant nibble | 21ns | 00 |
| 37 | Minimum four activate window time(tFAW min), least significant byte | 21ns | A8 |
| 38 | Minimum activate to activate delay time(tRRD_S min), different bank group | 3.3ns | 1B |
| 39 | Minimum activate to activate delay time(tRRD_L min), same bank group | 4.9ns | 28 |
| 40 | Minimum CAS to CAS delay time(tCCD_L min), same bank group | 5ns | 28 |
| 41 | Upper Nibble for tWR min | 15ns | 00 |
| 42 | Minimum Write Recovery Time (tWR min) | 15ns | 78 |
| 43 | Upper Nibbles for tWTR min | 2.5ns | 00 |
| 44 | Minimum Write to Read Time (tWTR_S min), different bank group | 2.5ns | 14 |
| 45 | Minimum Write to Read Time (tWTR_L min), same bank group | 7.5ns | 3C |
| 46-59 | Reserved | — | 00 |
| 60 | Connector to SRAM bit mapping | DQ0 - 3 | 16 |
| 61 | Connector to SRAM bit mapping | DQ4 - 7 | 36 |
| 62 | Connector to SRAM bit mapping | DQ8 - 11 | 16 |
| 63 | Connector to SRAM bit mapping | DQ12 - 15 | 36 |
| 64 | Connector to SRAM bit mapping | DQ16 - 19 | 16 |
| 65 | Connector to SRAM bit mapping | DQ20 - 23 | 36 |
| 66 | Connector to SRAM bit mapping | DQ24 - 27 | 16 |
| 67 | Connector to SRAM bit mapping | DQ28 - 31 | 36 |
| 68 | Connector to SRAM bit mapping | CB0 - 3 | 00 |

| | | | |
|---------|--|---------------------|----|
| 69 | Connector to SRAM bit mapping | CB4 - 7 | 00 |
| 70 | Connector to SRAM bit mapping | DQ32 - 35 | 16 |
| 71 | Connector to SRAM bit mapping | DQ36 - 39 | 36 |
| 72 | Connector to SRAM bit mapping | DQ40 - 43 | 16 |
| 73 | Connector to SRAM bit mapping | DQ44 - 47 | 36 |
| 74 | Connector to SRAM bit mapping | DQ48 - 51 | 16 |
| 75 | Connector to SRAM bit mapping | DQ52 - 55 | 36 |
| 76 | Connector to SRAM bit mapping | DQ56 - 59 | 16 |
| 77 | Connector to SRAM bit mapping | DQ60 - 63 | 36 |
| 78-116 | Reserved | — | 00 |
| 117 | Fine offset for minimum CAS to CAS delay time (tCCD_L min), same bank group | 5ns | 00 |
| 118 | Fine offset for minimum activate to activate delay time (tRRD_L min), same bank group | 4.9ns | 9C |
| 119 | Fine offset for minimum activate to activate delay time (tRRD_S min), different e bank group | 3.3ns | B5 |
| 120 | Fine offset for minimum activate to activate/refresh delay time(tRC min) | 45.75ns | 00 |
| 121 | Fine offset for minimum ROW precharge delay time (tRP min) | 13.75ns | 00 |
| 122 | Fine offset for minimum RAS to CAS delay time(tRCD min) | 13.75ns | 00 |
| 123 | Fine offset for minimum CAS latency time (tAA min) | 13.75ns | 00 |
| 124 | Fine offset for SDRAM maximum cycle time(tCKAVG max) | 1.6ns | E7 |
| 125 | Fine offset for SDRAM minimum cycle time(tCKAVG min) | 0.833ns | D6 |
| 126 | CRC for base configuration section section, Least significant byte | EC | EC |
| 127 | CRC for base configuration section section, Most significant byte | 5A | 5A |
| 128 | Raw card extension, module nominal height | R/C A, 31.25mm | 11 |
| 129 | Module maximum thickenss | 1 < thickness ≤ 2mm | 11 |
| 130 | Reference raw card used | Row Card A | 00 |
| 131 | Address mapping from edge connector to DRAM | Standard = 0 | 00 |
| 132-253 | Reserved | — | 00 |
| 254 | CRC for base configuration section section, Least significant byte | B6 | B6 |
| 255 | CRC for base configuration section section, Most significant byte | 58 | 58 |
| 256-319 | Reserved | — | 00 |

| | | | |
|-----|---|--------|----|
| 320 | Module manufacturer's ID code, least significant byte | Apacer | 01 |
| 321 | Module manufacturer's ID code, least significant byte | Apacer | 7A |
| 322 | Module manufacturing location | | 00 |
| 323 | Module manufacturing date | | 00 |
| 324 | Module manufacturing date | | 00 |
| 325 | Module serial number | | 00 |
| 326 | Module serial number | | 00 |
| 327 | Module serial number | | 00 |
| 328 | Module serial number | | 00 |
| 329 | Module part number | A | 41 |
| 330 | Module part number | Q | 51 |
| 331 | Module part number | D | 44 |
| 332 | Module part number | - | 2D |
| 333 | Module part number | D | 44 |
| 334 | Module part number | 4 | 34 |
| 335 | Module part number | U | 55 |
| 336 | Module part number | 8 | 38 |
| 337 | Module part number | G | 47 |
| 338 | Module part number | N | 4E |
| 339 | Module part number | 2 | 32 |
| 340 | Module part number | 4 | 34 |
| 341 | Module part number | - | 2D |
| 342 | Module part number | S | 53 |
| 343 | Module part number | E | 45 |
| 344 | Module part number | | 20 |
| 345 | Module part number | | 20 |
| 346 | Module part number | | 20 |
| 347 | Module part number | | 20 |
| 348 | Module part number | | 20 |



Enabling an Intelligent Planet

**288 Pin DDR4 1.2V 2400 UDIMM
8GB Based on 1Gx8
AQD-D4U8GN24-SE**

| | | | |
|---------|---|--|----|
| 349 | Module revision code | | 00 |
| 350 | DRAM manufacturer's ID code, least significant byte | | 00 |
| 351 | DRAM manufacturer's ID code, least significant byte | | 00 |
| 352 | DRAM stepping | | 00 |
| 353-381 | Module manufacturer's specific data | | 00 |
| 382-383 | Reserved | | 00 |
| 384-511 | End user programmable | | 00 |