



**User Manual**

# **ARK-3531**

## **Fanless Embedded Box PC**

**ADVANTECH**

*Enabling an Intelligent Planet*

---

## **Attention!**

Please note:

This package contains a hard-copy user manual in Chinese for China CCC certification purposes. There is an English user manual included as a PDF file on the CD. Please disregard the Chinese hard copy user manual if the product is not to be sold and/or installed in China.

## Copyright

The documentation and the software included with this product are copyrighted 2020 by Advantech Co., Ltd. All rights are reserved. Advantech Co., Ltd. reserves the right to make improvements in the products described in this manual at any time without notice.

No part of this manual may be reproduced, copied, translated, or transmitted in any form or by any means without the prior written permission of Advantech Co., Ltd. Information provided in this manual is intended to be accurate and reliable. However, Advantech Co., Ltd. assumes no responsibility for its use, nor for any infringements of the rights of third parties, which may result from its use.

## Acknowledgments

Award is a trademark of Award Software International, Inc.

VIA is a trademark of VIA Technologies, Inc.

IBM, PC/AT, PS/2 and VGA are trademarks of International Business Machines Corporation.

Intel® and Pentium® are trademarks of Intel Corporation.

Microsoft Windows® is a registered trademark of Microsoft Corp.

RTL is a trademark of Realtek Semi-Conductor Co., Ltd.

ESS is a trademark of ESS Technology, Inc.

UMC is a trademark of United Microelectronics Corporation.

SMI is a trademark of Silicon Motion, Inc.

Creative is a trademark of Creative Technology LTD.

CHRONTEL is a trademark of Chrontel Inc.

All other product names or trademarks are properties of their respective owners.

For more information about this and other Advantech products, please visit our website at:

<http://www.advantech.com/>

<http://www.advantech.com/ePlatform/>

For technical support and service, please visit our support website at:

<http://support.advantech.com.tw/support/>

---

## Product Warranty (2 years)

Advantech warrants to you, the original purchaser, that each of its products will be free from defects in materials and workmanship for two years from the date of purchase.

This warranty does not apply to any products which have been repaired or altered by persons other than repair personnel authorized by Advantech, or which have been subject to misuse, abuse, accident, or improper installation. Advantech assumes no liability under the terms of this warranty as a consequence of such events.

Because of Advantech's high quality-control standards and rigorous testing, most of our customers never need to use our repair service. If an Advantech product is defective, it will be repaired or replaced at no charge during the warranty period. For out-of-warranty repairs, you will be billed according to the cost of replacement materials, service time and freight. Please consult your dealer for more details.

If you think you have a defective product, follow these steps:

1. Collect all the information about the problem encountered. (For example, CPU speed, Advantech products used, other hardware and software used, etc.) Note anything abnormal and list any onscreen messages you get when the problem occurs.
2. Call your dealer and describe the problem. Please have your manual, product, and any helpful information readily available.
3. If your product is diagnosed as defective, obtain an return merchandise authorization (RMA) number from your dealer. This allows us to process your return more quickly.
4. Carefully pack the defective product, a fully-completed Repair and Replacement Order Card and a photocopy proof of purchase date (such as your sales receipt) in a shippable container. A product returned without proof of the purchase date is not eligible for warranty service.
5. Write the RMA number visibly on the outside of the package and ship it prepaid to your dealer.

## Declaration of Conformity

### FCC Class B

Note: This equipment has been tested and found to comply with the limits for a Class B digital device, pursuant to part 15 of the FCC Rules. These limits are designed to provide reasonable protection against harmful interference in a residential installation.

This equipment generates, uses and can radiate radio frequency energy and, if not installed and used in accordance with the instructions, may cause harmful interference to radio communications. However, there is no guarantee that interference will not occur in a particular installation. If this equipment does cause harmful interference to radio or television reception, which can be determined by turning the equipment off and on, the user is encouraged to try to correct the interference by one or more of the following measures:

- Reorient or relocate the receiving antenna.
- Increase the separation between the equipment and receiver.
- Connect the equipment into an outlet on a circuit different from that to which the receiver is connected.
- Consult the dealer or an experienced radio/TV technician for help.

## Technical Support and Assistance

1. Visit the Advantech website at [www.advantech.com/support](http://www.advantech.com/support) where you can find the latest information about the product.
2. Contact your distributor, sales representative, or Advantech's customer service center for technical support if you need additional assistance. Please have the following information ready before you call:
  - Product name and serial number
  - Description of your peripheral attachments
  - Description of your software (operating system, version, application software, etc.)
  - A complete description of the problem
  - The exact wording of any error messages

## Warnings, Cautions, and Notes

**Warning!** *Warnings indicate conditions, which if not observed, can cause personal injury!*



**Caution!** *Cautions are included to help you avoid damaging hardware or losing data. e.g.*



*There is a danger of a new battery exploding if it is incorrectly installed. Do not attempt to recharge, force open, or heat the battery. Replace the battery only with the same or equivalent type recommended by the manufacturer. Discard used batteries according to the manufacturer's instructions.*

**Note!** *Notes provide optional additional information.*



## Packing List

Before installation, please ensure the following items have been shipped:

- 1 x ARK-3531 Unit
- 1 x Mounting Kit
- 1 x User Manual (Simplified Chinese)
- 1 x China RoHS

## Ordering Information

Part No.	CPU	DDR4	GbE	VGA	HDMI	RS-232/ 422/485	RS- 232	USB3.1	USB3.0	DIO	DC Input
ARK-3531- 00A1	LGA1151 Socket Type	Up to 64GB	2	1	1	4	4	2	6	16bit	9-36V

**Note!** CPU/Memory/Storage and operating system bundled by request.



## ARK-3531 Default SKU Option Items

### Optional Item for Default SKU

Part Number	Description
96PSA-A150W19P4-3	AC-to-DC Adapter, DC19V 150W, 0 ~ 40 °C (32 ~ 104 °F)
96PSA-A230W24P4-3	AC-to-DC Adapter, DC24V 230W, -20 ~ 60 °C (-4 ~ 140 °F)
1702002600	Power cable 3-pin 183 cm (64.1 in), USA type
1702002605	Power cable 3-pin 183 cm (64.1 in), EU type
1702031801	Power cable 3-pin 183 cm (64.1 in), UK type
1700000237	Power cable, 3-pin 183 cm (64.1 in), PSE type

# Safety Instructions

1. Read these safety instructions carefully.
2. Retain this user manual for future reference.
3. Disconnect the equipment from all AC outlets before cleaning. Use only a damp cloth for cleaning. Do not use liquid or sprayed detergent.
4. For pluggable equipment, the power outlet should be near the equipment and easily accessible.
5. Protect the equipment from humidity.
6. Place the equipment on a reliable surface during installation. Dropping or letting the equipment fall may cause damage.
7. The openings on the enclosure are for air convection and protect the equipment from overheating. Do not cover the openings.
8. The power outlet sockets should have grounded connections.
9. Position the power cord away from high-traffic areas. Do not place anything over the power cord.
10. All cautions and warnings on the equipment should be noted.
11. If the equipment is not used for a long time, disconnect the equipment from the power source to avoid damage from transient over-voltage.
12. Never pour liquid into an opening as this can cause fire or electrical shock.
13. Never open the equipment. For safety reasons, only qualified service personnel should open the equipment.
14. If one of the following occurs, have the equipment checked by service personnel:
  - The power cord or plug is damaged.
  - Liquid has penetrated into the equipment.
  - The equipment has been exposed to moisture.
  - The equipment is malfunctioning or does not operate according to the user manual.
  - The equipment has been dropped and damaged.
  - The equipment shows obvious signs of breakage.
15. Do not leave the equipment in an environment with a storage temperature of below  $-40\text{ }^{\circ}\text{C}$  ( $-40\text{ }^{\circ}\text{F}$ ) or above  $85\text{ }^{\circ}\text{C}$  ( $185\text{ }^{\circ}\text{F}$ ) as this may cause damage. The equipment should be stored in a controlled environment.
16. Any unverified component may cause unexpected damage. To ensure correct installation, always use the components (e.g., screws) provided in the accessory box.
17. **CAUTION:** The equipment is equipped with a battery-powered real-time clock circuit. There is a risk of explosion if a battery is incorrectly replaced. Replace only with same or equivalent type as recommended by the manufacturer. Discard all used batteries according to the manufacturer's instructions.
18. Always disconnect the power cord from the chassis before manually handling the hardware. Do not implement connections or configuration changes while the device is powered on. Sudden power surges may damage sensitive electronic components.
19. In accordance with IEC 704-1:1982 specifications, the sound pressure level at the operator's position should not exceed 70 dB (A).
20. The equipment should only be installed in a restricted access areas.
21. **DISCLAIMER:** These instructions are provided according to IEC 704-1 specifications.

Advantech disclaims all responsibility for the accuracy of any statements contained herein.

22. Use a power cord connected to a socket-outlet with a grounded connection.
23. This product is intended to be supplied by a UL Listed power supply suitable for use at minimum Tma 50 °C (122 °F) whose output meets PS2 (or LPS), ES1 (or SELV) and output is rated: 9-36Vdc, 16.65-4.16A. Please contact Advantech for further information.
24. Never open the equipment. For safety reasons, the equipment should be opened by qualified service personnel only).

## Consignes de Sécurité

1. Veuillez lire attentivement ces instructions de sécurité.
2. Veuillez conserver ce manuel de l'utilisateur pour référence ultérieure.
3. Veuillez débrancher cet équipement de la prise secteur avant le nettoyage. Utilisez un chiffon humide. Ne pas utiliser de détergent liquide ou pulvérisé pour le nettoyage. Utilisez une feuille ou un chiffon humide pour le nettoyage.
4. Pour les équipements enfichables, la prise de courant doit être à proximité de l'équipement et doit être facilement accessible.
5. S'il vous plaît garder cet équipement de l'humidité.
6. Posez cet équipement sur une surface fiable lors de l'installation. Une chute ou une chute pourrait causer des blessures.
7. Les ouvertures sur le boîtier sont destinées à la convection d'air, protégeant ainsi l'équipement de la surchauffe. **NE COUVREZ PAS LES OUVERTURES.**
8. La prise de courant doit avoir une connexion mise à la terre.
9. Placez le cordon d'alimentation de sorte que personne ne puisse marcher dessus.  
Ne placez rien sur le cordon d'alimentation.
10. Tous les avertissements et mises en garde sur l'équipement doivent être notés.
11. Si l'appareil n'est pas utilisé pendant une longue période, débranchez-le du secteur pour ne pas être endommagé par une surtension transitoire.
12. Ne jamais verser de liquide dans les ouvertures de ventilation; Cela pourrait provoquer un incendie ou un choc électrique.
13. N'ouvrez jamais l'équipement. Pour des raisons de sécurité, seul le personnel de maintenance qualifié doit ouvrir l'équipement.
14. Si l'une des situations suivantes se présente, faites vérifier le matériel par le personnel de service:
  - Le cordon d'alimentation ou la fiche est endommagé.
  - Un liquide a pénétré dans l'appareil.
  - L'équipement a été exposé à l'humidité.
  - L'équipement ne fonctionne pas bien ou vous ne pouvez pas le faire fonctionner conformément au manuel d'utilisation.
  - Equipment L'équipement est tombé et a été endommagé.
  - Equipment L'équipement présente des signes évidents de rupture.
15. Ne laissez pas cet équipement dans un environnement où la température de stockage peut être inférieure à -40 °C (-40 °F) ou supérieure à 85 °C (185 °F). Cela pourrait endommager l'équipement. L'équipement doit être dans un environnement contrôlé.
16. Tout composant non vérifié peut causer des dommages inattendus. Pour garantir une installation correcte, veuillez toujours utiliser les composants (ex. Vis) fournis avec la boîte d'accessoires.
17. **ATTENTION:** L'ordinateur est équipé d'un circuit d'horloge temps réel alimenté par batterie. Il y a un risque d'explosion si la batterie est remplacée de manière incorrecte. Remplacez uniquement avec le même type ou un type équivalent



recommandé par le fabricant. Jetez les piles usagées conformément aux instructions du fabricant.

18. Débranchez toujours complètement le cordon d'alimentation de votre châssis lorsque vous utilisez du matériel. Ne faites pas de connexion quand l'appareil est sous tension. Les composants électroniques sensibles peuvent être endommagés par des surtensions soudaines.
19. Niveau de pression acoustique au poste de l'opérateur selon la norme CEI 704-1: 1982 n'est pas supérieur à 70 dB (A).
20. L'équipement ne doit être installé que dans une zone d'accès restreint.
21. **AVERTISSEMENT:** Cet ensemble d'instructions est donné conformément à la norme CEI 704-1. Advantech décline toute responsabilité quant à l'exactitude des déclarations contenues dans ce.
22. Au moyen d'un cordon d'alimentation connecté à une prise de courant avec mise à la terre.
23. Ce produit est destiné à être alimenté par un bloc d'alimentation homologué UL adapté à une utilisation à T<sub>ma</sub> 50 degrés C min. dont la sortie est conforme à PS2 (ou LPS), ES1 (ou SELV) et dont la sortie est nominale: 9-36Vdc, 16.65-4.16A, si besoin d'aide supplémentaire, veuillez contacter Advantech pour plus d'informations.
24. N'ouvrez jamais l'équipement. Pour des raisons de sécurité, l'équipement ne doit être ouvert que par du personnel de service qualifié (Par personne qualifiée).



# Contents

<b>Chapter 1</b>	<b>General Introduction .....</b>	<b>1</b>
1.1	Introduction .....	2
1.2	Product Features.....	3
	1.2.1 General .....	3
	1.2.2 Display .....	3
	1.2.3 Ethernet .....	3
1.3	Chipset.....	4
	1.3.1 Functional specifications.....	4
	1.3.2 SUSI 4.0.....	5
1.4	Mechanical Specifications.....	5
	1.4.1 Dimensions .....	5
	Figure 1.1 ARK-3531 Mechanical Dimensions Diagram .....	5
	1.4.2 Weight.....	6
1.5	Power Requirements.....	6
	1.5.1 System power .....	6
1.6	Operating Environment Specifications .....	6
	1.6.1 Operating temperature.....	6
	1.6.2 Relative humidity.....	6
	1.6.3 Storage temperature .....	6
	1.6.4 Safety.....	6
	1.6.5 EMC .....	6
<b>Chapter 2</b>	<b>Hardware Configuration.....</b>	<b>7</b>
2.1	Introduction .....	8
2.2	Jumpers .....	8
	2.2.1 Jumper Description .....	8
	2.2.2 Jumper List .....	8
	Table 2.1: Jumper List.....	8
	2.2.3 Jumper Locations.....	9
	Figure 2.1 Jumper Layout.....	9
	2.2.4 Jumper Settings.....	10
2.3	Connectors.....	11
	2.3.1 ARK-3531 External I/O Locations .....	11
	Figure 2.2 ARK-3531 Front and Rear I/O Connector Diagram..	11
	Figure 2.3 COM Connector.....	12
	Table 2.2: COM Connector Pin Assignments .....	12
	Figure 2.4 Ethernet Connector .....	13
	Table 2.3: Ethernet Connector Pin Assignments.....	13
	Figure 2.5 Power ON/OFF Button .....	13
	Figure 2.6 Audio Connector.....	14
	Figure 2.7 LED Indicators .....	14
	Figure 2.8 HDMI Receptacle Connector.....	14
	Table 2.4: HDMI Connector Pin Assignments .....	14
	Figure 2.9 USB 3.0 Connector.....	15
	Table 2.5: USB 3.1 and USB 3.0 Connector Pin Assignments ..	15
	Figure 2.10VGA Connector .....	15
	Table 2.6: VGA Connector Pin Assignments.....	15
	Figure 2.11DIO Connector.....	16
	Table 2.7: DIO Connector Pin Assignment.....	16
2.4	Installation .....	17
	2.4.1 CPU/Memory Installation .....	17
	2.4.2 Remove Bottom Cover.....	18
	2.4.3 HDD/SSD Installation.....	18

2.4.4	miniPCIe/mSATA/m.2 Module Installation .....	19
2.4.5	Mounting Kit Installation.....	19
2.4.6	Wide Operating Temperature Support.....	19

## **Chapter 3 BIOS Settings ..... 21**

3.1	Introduction .....	22
3.2	Entering the Setup .....	23
3.2.1	Main Setup.....	23
3.2.2	Advanced BIOS Features Setup.....	24
3.2.3	Chipset Configuration .....	47
3.2.4	Security.....	61
3.2.5	Boot .....	62
3.2.6	Save & Exit .....	63

## **Appendix A Watchdog Timer Sample Code ..... 65**

A.1	EC Watchdog Timer Sample Code.....	66
-----	------------------------------------	----

## **Appendix B Fixing the LAN order ..... 67**

B.1	Problem Statement .....	68
B.2	Addressing the LAN Order.....	69

# Chapter 1

## General Introduction

This chapter details background information on the ARK-3531 series.

---

## 1.1 Introduction

Advantech's ARK-3531 is an intelligent, high-performance, fanless desktop system powered by 8th & 9th Gen. Intel® Core™ i3/i5/i7 LGA1151 processors. ARK-3531 supports a maximum 35W processor and broad temperature ranges (-20 ~ 60 °C / -4 ~ 140 °F). Additionally, it provides multiple I/O — 8x COM, 4x GbE, 2x USB 3.1, 6 x USB 3.0, 1x miniPCIe (share with mSATA), 1x M.2 (E key), and 2x 2.5" SATA III hard drive bays.

### **Rugged Multi-Functional Design**

ARK-3531 adopts an advanced thermal design for its desktop processor solution. All models are fanless, and feature various quality features. These include wide operating temperatures (-20 ~ 60 °C / -4 ~ 140 °F), diverse expandability options, and structural strengthening. It supports diverse I/O interfaces — including 4 x Intel® GbE, 2 x USB 3.1, 6 x USB 3.0, 2 x 2.5" HDD, 1 x miniPCIe, 1 x M.2 (E key) 4 x RS-232/422/485 and 4 x RS-232 COM ports.

### **Smart AI solution**

ARK-3531 is designed to support VEGA series AI solutions. High computing performance is paired with AI computing, yielding an intelligent AI system.

### **Built-in Intelligent Management Tools — Advantech SUSI API and WISE-DeviceOn**

Advantech SUSI API provides a valuable suite of programmable APIs such as multi-level watchdog, hardware monitoring, system restoration, and other user-friendly interfaces.

SUSI API is an intelligent self-management cross platform tool that monitors the system's status for problems and takes action in the event of abnormalities. SUSI API offers a boot up guarantee in critical, low-temperature environments so systems can automatically recover when voltages dip. SUSI API makes the entire system more reliable and intelligent. ARK-3531 also supports Advantech's own WISE-DeviceOn, which provides easy remote management so users can monitor, configure, and control a large number of terminals to make maintenance and system recovery simpler.

## 1.2 Product Features

### 1.2.1 General

- **CPU:** 8th & 9th Gen. Intel® Core™ i3/i5/i7 LGA1151 desktop processor (up to 35W)
- **System Chipset:** Intel® H370 (Q370 supports by TPN)
- **BIOS:** AMI EFI 128Mbit
- **System Memory:** DDR4 2666Mhz up to 64GB
- **Watchdog Timer:** Single chip Watchdog 255-level interval timer, setup by software
- **I/O Interface:** 4 x RS232/422/485, 4 x RS232
- **USB:** 2x USB 3.1, 6x USB 3.0 compliant ports
- **Audio:** High Definition Audio (HD), Line-out/Mic-in
- **Storage:** 2 x 2.5" HDD drive bays (9.5 mm/0.374 in height) and 1 x mSATA
- **Expansion Interface:**
  - 1 x Full size MiniPCIe (support mSATA and 1 with SIM)
  - 1 x M.2 (E key for Wi-Fi, suggested installation at Advantech manufacturing)
- **TPM:** TPM2.0

### 1.2.2 Display

- **Controller:** According to customer-specified CPU selection
- **Resolution:**
  - VGA: supports 2048x1280 @ 60 Hz
  - HDMI: supports HDMI 1.4, 3840 x 2160 @ 30 Hz
- **Dual Display:**
  - VGA+HDMI (Default)
  - HDMI+HDMI (Support by TPN)
  - DP+VGA (Support by TPN)
  - DP+HDMI (Support by TPN)

### 1.2.3 Ethernet

- **Chipset:**
  - LAN1 Intel® i219LM
  - LAN2/3/4 Intel® i210IT (LAN3/4 support by TPN)
- **Speed:** 10/100/1000 Mbps
- **Interface:** Up to 4 x RJ45

## 1.3 Chipset

### 1.3.1 Functional specifications

#### 1.3.1.1 Processor

<b>Processor</b>	Supports 8th/9th Gen. Intel® LGA1151 processor (up to 35W)
<b>Memory</b>	Supports DDR4 2666 MHz up to 64GB 2 x 260-pin SODIMM socket type

#### 1.3.1.2 Chipset

<b>Internal Graphics Features</b>	<ul style="list-style-type: none"><li>■ Direct x 12, OpenGL 4.4</li><li>■ VGA + HDMI</li><li>■ Intel® Display Power saving technology 6.0</li></ul>
<b>Video Accelerator</b>	<ul style="list-style-type: none"><li>■ HW accelerated Media Decode: H.265/HEVC, H.264/MPEG-4 AVC, MPEG-2, VC-1/WMV9, JPEG/MJPEG, VP8 and VP9</li><li>■ HW accelerated Media Encode: H.265/HEVC, H.264/MPEG-4 AVC, MPEG-2, JPEG/MJPEG and VP8</li></ul>
<b>SATA Interface</b>	<b>Intel® H370 (Q370 supports by TPN) chip supports:</b> <ul style="list-style-type: none"><li>■ Supports several optional selections of Serial ATA III</li><li>■ Supports SATA data transfer rates of up to 6 Gb/s</li><li>■ Integrated AHCI controller</li><li>■ Supports mSATA socket</li></ul>
<b>USB Interface</b>	<b>Intel® H370 (Q370 supports by TPN) chip supports:</b> <ul style="list-style-type: none"><li>■ 1 x EHCI Host Controller, supporting SuperSpeed USB 3.1/ 3.0 ports</li><li>■ 1 x XHCI Host Controllers, supporting HighSpeed USB 2.0 ports</li><li>■ Supports wake-up from sleep states S3</li><li>■ Maximum 500mA for each USB port</li></ul>
<b>Power Management</b>	<b>Intel® H370 (Q370 supports by TPN) chip supports:</b> <ul style="list-style-type: none"><li>■ Supports ACPI</li><li>■ ACPI-defined power states (processor driven C states)</li><li>■ ACPI Power Management Timer</li><li>■ SMI# generation</li></ul>
<b>BIOS</b>	<b>Intel® H370 (Q370 supports by TPN) chip supports:</b> <ul style="list-style-type: none"><li>■ AMI 128-Mbit EFI Flash BIOS via SPI</li></ul>

#### 1.3.1.3 Others

<b>Serial Ports</b>	<ul style="list-style-type: none"><li>■ 8x serial ports</li><li>■ Supports IRQ Sharing among serial ports under Microsoft Windows OS</li><li>■ COM1, COM2, COM5, COM6: RS-232/422/485</li><li>■ COM3, COM4, COM7, COM8: RS-232</li></ul>
<b>Ethernet</b>	<b>LAN1 Intel i219LM, LAN2/3/4 Intel i210IT (LAN3/4 support by TPN)</b> <ul style="list-style-type: none"><li>■ Supports 10/100/1000 Mbps</li><li>■ LAN Connectors: Phone Jack RJ45 8P 90D (F)</li></ul>
<b>Audio</b>	<b>Audio Codec: ALC888S-VD2-GR</b> <ul style="list-style-type: none"><li>■ Compliant with HD Audio specifications</li><li>■ Supports 16/20/24-bit DAC and 16/20/24-bit ADC resolution</li><li>■ Supports: Speak-out, Mic-in</li><li>■ Audio Connectors: Ear Phone Jack * 1</li></ul>
<b>Battery Backup</b>	BATTERY 3V/210 mAh with WIRE x 1
<b>TPM</b>	TPM 2.0



## 1.3.2 SUSI 4.0

<b>SUSI API</b>	
<b>Sequence Control</b>	Supported
<b>DIO</b>	16-bit programmable DIO
<b>Watchdog Timer</b>	Multi-level WDT (set by Advantech iManager) Programmable 1-255 sec / min
<b>Hardware Monitor</b>	CPU Temperature / input Current / input Voltage
<b>System Information</b>	Running HR / Boot record

## 1.4 Mechanical Specifications

### 1.4.1 Dimensions

200 x 75 x 215 mm / 7.87 x 2.95 x 8.46 in (W x H x D)

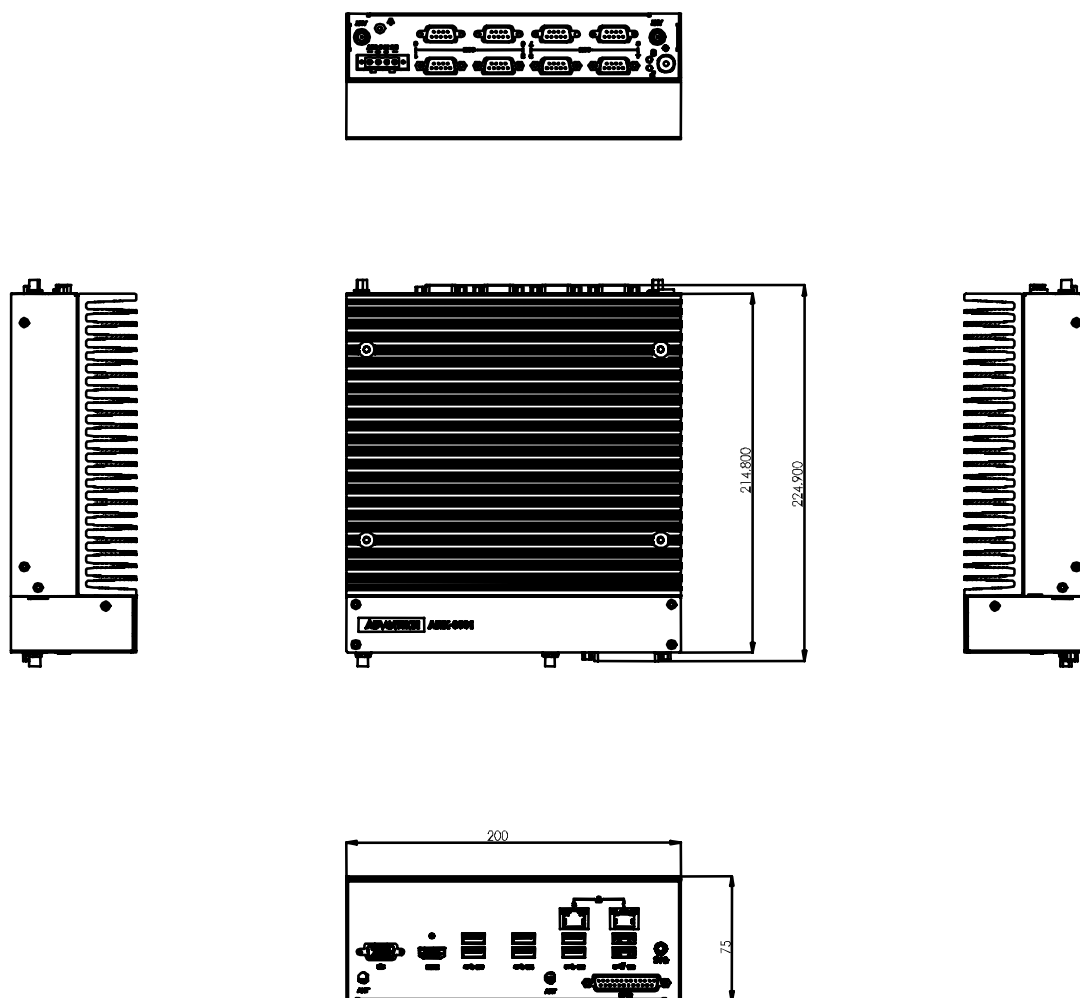

Figure 1.1 ARK-3531 Mechanical Dimensions Diagram

---

## 1.4.2 Weight

3.2 kg (7 lb)

## 1.5 Power Requirements

### 1.5.1 System power

- **Minimum Power Input:** 9 ~ 36VDC
- **Optional Adapter:**
  - 150W @ 19V/7.89A power adapter (optional)
  - 230W @ 24V/9.58A power adapter (optional)

## 1.6 Operating Environment Specifications

### 1.6.1 Operating temperature

- With extended peripherals: -20 ~ 60 °C (-4 ~ 140 °F) with 0.7m/s air flow

### 1.6.2 Relative humidity

- 95% @ 40 °C (104 °F) (non-condensing)

### 1.6.3 Storage temperature

- -40 ~ 85 °C (-40 ~ 185 °F)

### 1.6.4 Safety

- UL, CB, CCC, BSMI

### 1.6.5 EMC

- CE/FCC Class B, CCC, BSMI

# Chapter 2

Hardware  
Configuration

## 2.1 Introduction

The following sections show the internal jumper settings and the external connector pin assignments for different applications.

## 2.2 Jumpers

### 2.2.1 Jumper Description

You may configure ARK-3531 to match the needs of your application by setting jumpers. A jumper is a metal bridge used to close an electric circuit. It consists of two metal pins and a small metal clip (often protected by a plastic cover) that slides over the pins to connect them. To close a jumper, you connect the pins with the clip. To open a jumper, remove the clip. Sometimes a jumper will have three pins, labeled 1, 2 and 3. In this case you would connect either pins 1 and 2, or 2 and 3.

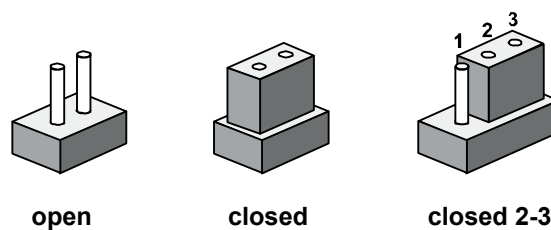

The jumper settings are schematically depicted in this manual as follows.

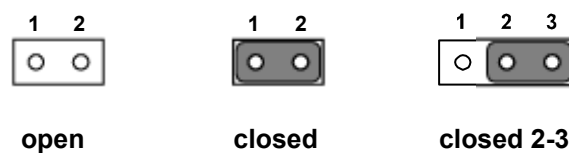

A pair of needle-nose pliers may be helpful when working with jumpers. If you have any doubts about the best hardware configuration for your application, contact your local distributor or sales representative before you make any changes. Generally, you simply need a standard cable to make most connections.

### 2.2.2 Jumper List

**Table 2.1: Jumper List**

J1	Auto Power On Setting
JCMOS1	Clear CMOS
JSETCOM1_V1	COM1 RI power setting

### 2.2.3 Jumper Locations

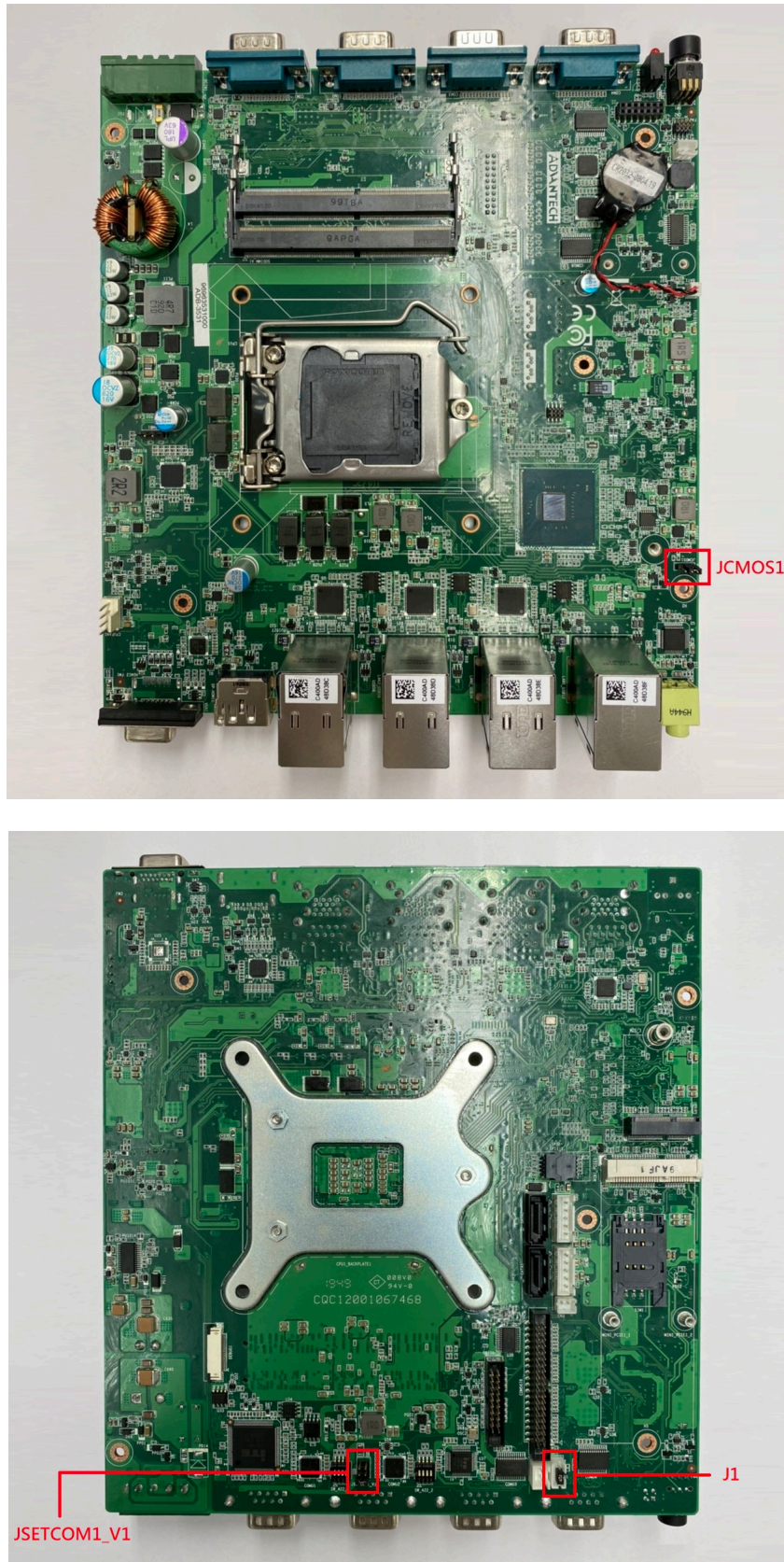

Figure 2.1 Jumper Layout

## 2.2.4 Jumper Settings

### 2.2.4.1 Auto Power On Setting for J1

#### J1 Auto Power On Setting

Part Number	1655303020
Footprint	WHL3V-2M
Description	WAFER BOX 3P 2.0mm 180D(M) DIP 2001-WS-3
Setting	Function
(1-2)	Auto Power On
(2-3)	Power Button for Power On (Default)

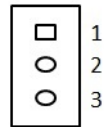

### 2.2.4.2 Clear CMOS Setting for JCMOS1

#### JCMOS1 Clear CMOS Setting

Part Number	1653003101
Footprint	HD_3x1P_79_D
Description	PIN HEADER 3x1P 2.0 mm 180D(M) DIP 2000-13 WS
Setting	Function
(1-2)	Normal Operation (Default)
(2-3)	Clear CMOS

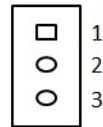

### 2.2.4.3 COM1 RI Power Setting (JSETCOM1\_V1) H3

#### JSETCOM1\_V1 COM1 RI power setting

Part Number	1653003201
Footprint	HD_3x2P_79_D
Description	PIN HEADER 3x2P 2.0mm 180D(M) DIP 21N22050
Setting	Function
(1-2)	Normal (default)
(3-4)	+5V
(5-6)	+12V

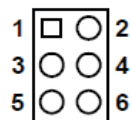

## 2.3 Connectors

### 2.3.1 ARK-3531 External I/O Locations

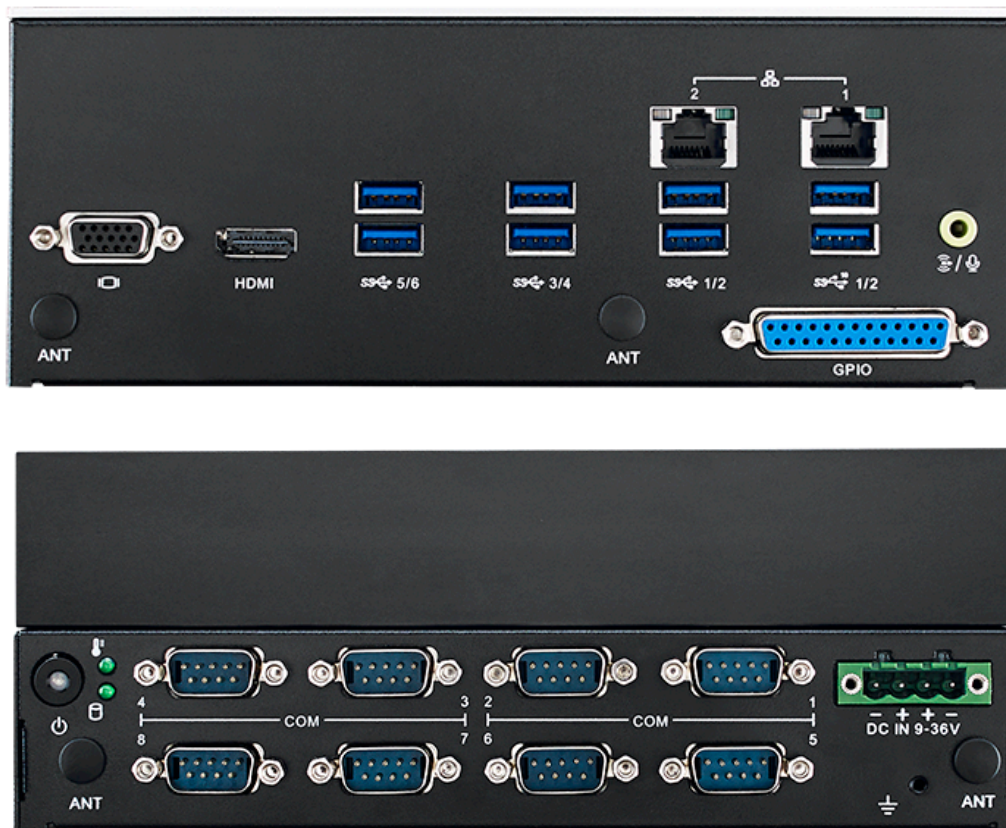

Figure 2.2 ARK-3531 Front and Rear I/O Connector Diagram

### 2.3.1.1 COM Connector

ARK-3531 provides up to eight D-sub 9-pin connectors, which offers RS-232/422/485 serial communication interface ports. The default setting is RS-232, the mode RS-422/485 of ARK-3531 COM1/2/5/6 can be supported via the BIOS settings. Optional COM3/4/7/8 supports RS-232.

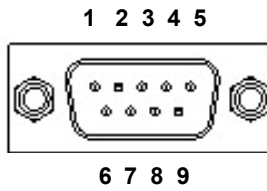

Figure 2.3 COM Connector

Table 2.2: COM Connector Pin Assignments

	RS-232	RS-422	RS-485
Pin	Signal Name	Signal Name	Signal Name
1	DCD	Tx-	DATA-
2	RxD	Tx+	DATA+
3	TxD	Rx+	NC
4	DTR	Rx-	NC
5	GND	GND	GND
6	DSR	NC	NC
7	RTS	NC	NC
8	CTS	NC	NC
9	RI	NC	NC

**Note!** NC represents “No Connection”.





### 2.3.1.2 Ethernet Connector (LAN)

ARK-3531 is equipped with up to 4x (LAN3/4 are optional by TPN support) Ethernet controllers that are fully compliant with IEEE 802.3u 10/100/1000 Mbps CSMA/CD standards. These Ethernet ports provides a standard RJ-45 jack connector with LED indicators on the front side to show its Active/Link status (Green LED) and Speed status (Yellow LED).

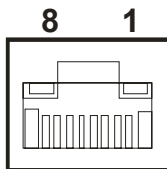

Figure 2.4 Ethernet Connector

Table 2.3: Ethernet Connector Pin Assignments

Pin	10/100/1000BaseT Signal Name
1	TX+
2	TX-
3	RX+
4	MDI2+
5	MDI2-
6	RX-
7	MDI3+
8	MDI3-

### 2.3.1.3 Power On/Off Button

ARK-3531 has a Power On/Off button with LED indicators on the front side that show “On” (Green LED) and “Off/Suspend” statuses (Orange LED). The Power button supports dual functions: Soft Power -On/Off (Instant off or Delay 4 Seconds then off), and Suspend.



Figure 2.5 Power ON/OFF Button

#### 2.3.1.4 Audio Connector

ARK-3531 features one phone jack connector that supports stereo Line Out or Mic In audio ports. The audio chip is controlled by ALC888 and compliant with the Azalea standards.

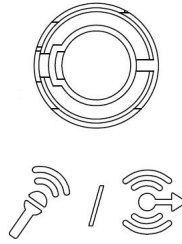

Figure 2.6 Audio Connector

#### 2.3.1.5 LED Indicators

There are four LEDs on the front panel that indicate the system's status: HDD LED is for HDD status.

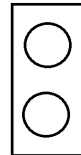

Figure 2.7 LED Indicators

#### 2.3.1.6 HDMI Connector

An integrated, 19-pin receptacle connector HDMI Type A Interface is provided. The HDMI link supports resolutions up to 3840 x 2160 @ 30 Hz.

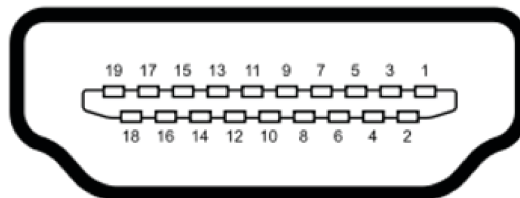

Figure 2.8 HDMI Receptacle Connector

Table 2.4: HDMI Connector Pin Assignments

Pin	Signal Name	Pin	Signal Name
1	TMDS Data 2+	2	TMDS Data 2 shield
3	TMDS Data 2-	4	TMDS Data 1+
5	TMDS Data 1 shield	6	TMDS Data 1-
7	TMDS Data 0+	8	TMDS Data 0 shield
9	TMDS Data 0-	10	TMDS clock+
11	TMDS clock shield	12	TMDS clock-
13	CEC	14	Reserved
15	SCL	16	SDA
17	DDC/CEC Ground	18	+5V
19	Hot Plug Detect		

### 2.3.1.7 USB 3.1 and USB 3.0 Connector

ARK-3531 supports 2x USB 3.1, and 6x USB 3.0 interfaces. The USB interfaces comply with USB UHCI, Rev. 3.0 standards. Please refer to Table 2.5 for its pin assignments. USB 3.0 connectors contain legacy pins to interface with USB 2.0 devices, and a new set of pins for USB 3.0 connectivity.

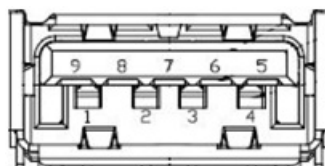

Figure 2.9 USB 3.0 Connector

Table 2.5: USB 3.1 and USB 3.0 Connector Pin Assignments

Pin	Signal Name	Pin	Signal Name
1	+5V	2	USB_data-
3	USB_data+	4	GND
5	SSRX-	6	SSRX+
7	GND	8	SSTX-
9	SSTX+		

### 2.3.1.8 VGA Connector

ARK-3531 provides an integrated 15-pin female VGA digital video interface, which supports up to 1920 x 1200 @ 60 Hz. Please refer to Table 2.6 for its pin assignments.

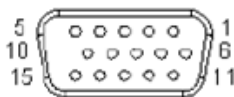

Figure 2.10 VGA Connector

Table 2.6: VGA Connector Pin Assignments

Pin	Signal Name	Pin	Signal Name
1	Red	2	Green
3	Blue	4	NC
5	GND	6	GND
7	GND	8	GND
9	NC	10	GND
11	NC	12	DDAT
13	H-SYNC	14	V-SYNC
15	DCLK		

### 2.3.1.9 DIO Connector

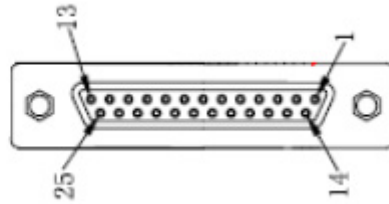

Figure 2.11 DIO Connector

Table 2.7: DIO Connector Pin Assignment

Pin	Signal Name	Pin	Signal Name
1	GND	14	GND
2	Port0 D0	15	Port1 D0
3	Port0 D1	16	Port1 D1
4	Port0 D2	17	Port1 D2
5	Port0 D3	18	Port1 D3
6	Port0 D4	19	Port1 D4
7	Port0 D5	20	Port1 D5
8	Port0 D6	21	Port1 D6
9	Port0 D7	22	Port1 D7
10	+5V	23	+5V
11	NC	24	NC
12	NC	25	NC
13	NC		

**Note!** NC represents “No Connection”.



## 2.4 Installation

### 2.4.1 CPU/Memory Installation

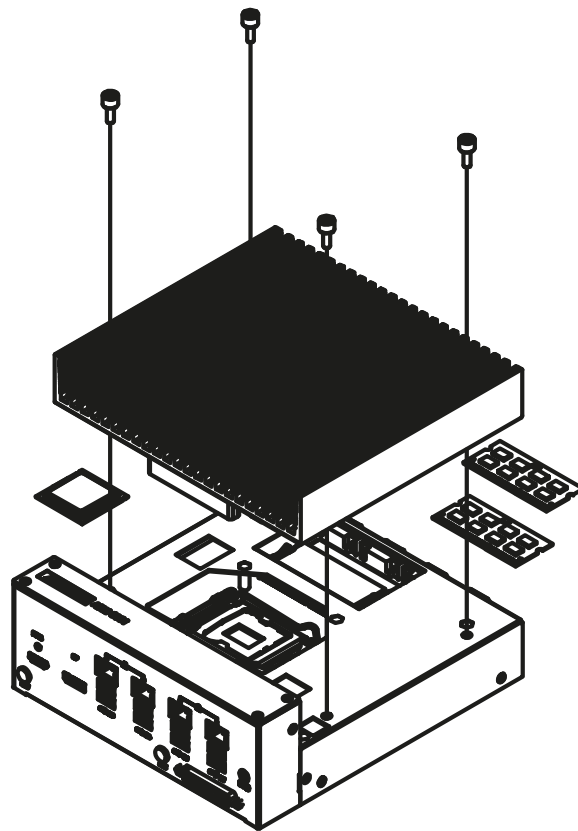

1. Unscrew the 4 screws on the top cover, and remove the top cover.
2. Install the CPU (LGA1151) and memory into the system.
3. Replace the top cover.

## 2.4.2 Remove Bottom Cover

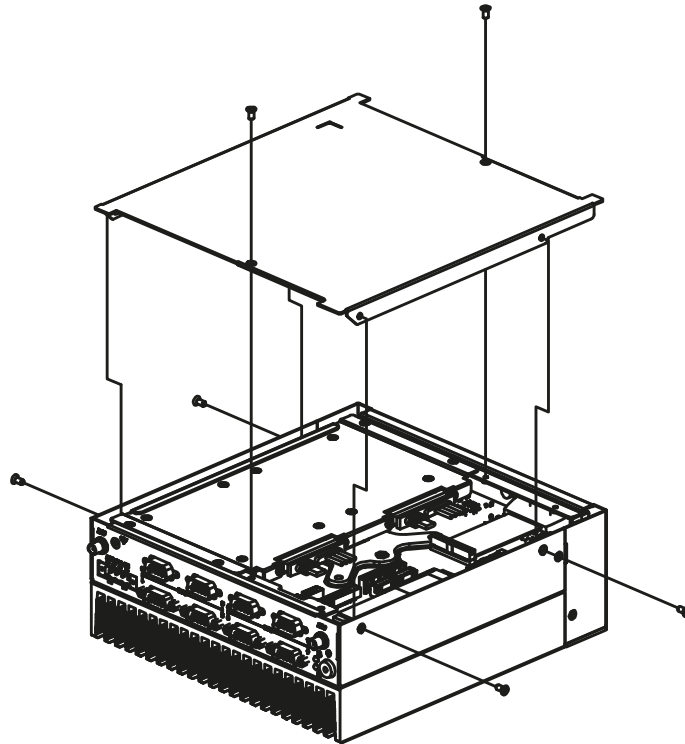

1. Unscrew 6 screws on the bottom cover.

## 2.4.3 HDD/SSD Installation

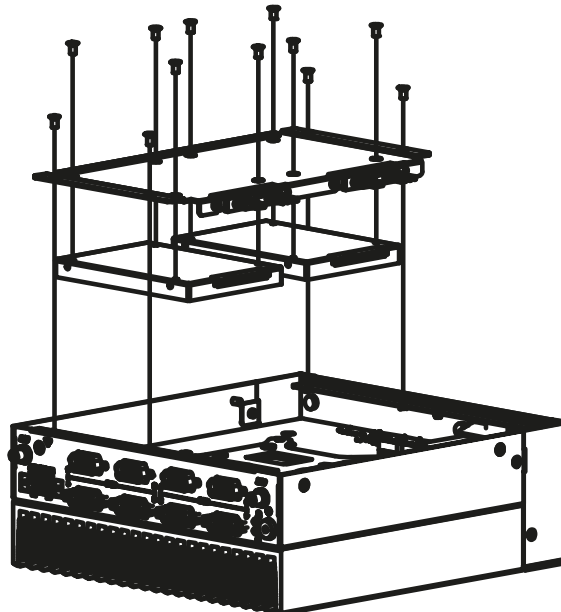

1. Remove bottom cover (2.4.2).
2. Remove 4 screws for HDD/SSD bracket.
3. Install HDD/SSD with each 4 screws on HDD/SSD.
4. Replace HDD/SSD bracket and secure in place with 4 screws.
5. Replace the bottom cover and secure in place with 6 screws.

## 2.4.4 miniPCIe/mSATA/m.2 Module Installation

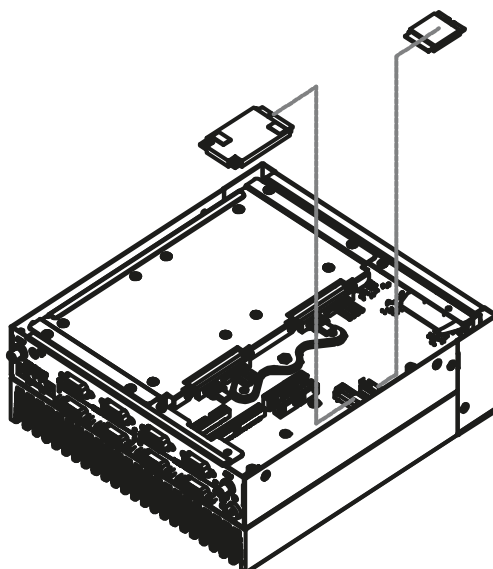

1. Remove bottom cover (2.4.2).
2. Install miniPCIe/mSATA module with 2 screws (MINI\_PCIE1 with SIM holder), M.2 module with 1 screw (M2E).
3. Replace the bottom cover and fix in place with 6 screws.

## 2.4.5 Mounting Kit Installation

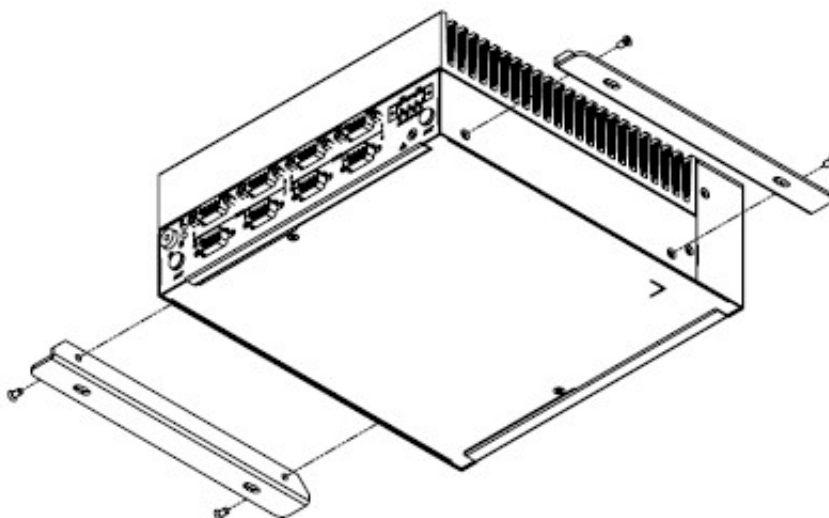

1. Take out mounting kit and 4 screws (M3x6L) from the accessory box.  
Retirez le kit de montage et les 4 vis (M3x6L) de la boîte d'accessoires.
2. Screw one of the 2 screws (M3x6L) on left and right side and fix the system horizontally.  
Vissez chaque 2 vis (M3x6L) sur les côtés gauche et droit et fixez le système horizontalement.

## 2.4.6 Wide Operating Temperature Support

To make sure the system works well under 0 °C (32 °F) or over 40° C (104 °F), please ensure your peripherals are i-grade. These support wide temperature operation.





# Chapter 3

BIOS Settings

## 3.1 Introduction

AMIBIOS has been integrated into motherboards for over two decades. With the AMIBIOS Setup program, users can modify BIOS settings and control various system features. This chapter describes the basic navigation of the ARK-3531 BIOS setup screens.



AMI's BIOS ROM has a built-in Setup program that allows users to modify the basic system configuration. This information is stored in flash ROM so it retains the Setup information when the power is turned off.

## 3.2 Entering the Setup

Turn on the computer and check for the patch code. If there is a number assigned to the patch code, it means that BIOS supports your CPU. If there is no number assigned to the patch code, please contact an Advantech application engineer to obtain an up-to-date patch code file. This will ensure that your CPU's system status is valid. After ensuring that you have a number assigned to the patch code, press <DEL> and you will immediately be allowed to enter Setup.

### 3.2.1 Main Setup

When users first enter the BIOS Setup Utility, they will enter the Main setup screen. Users can always return to the Main setup screen by selecting the Main tab. There are two Main Setup options. They are described in this section. The Main BIOS Setup screen is shown below.

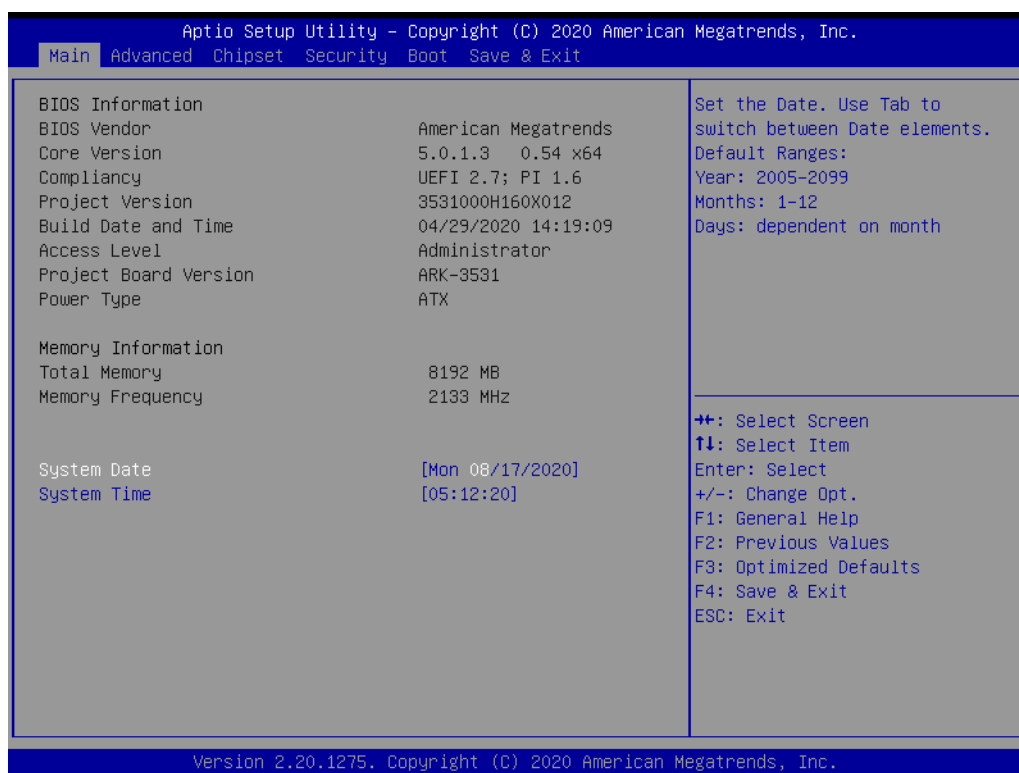

The Main BIOS setup screen has two main frames. The left frame displays all the options that can be configured. Grayed-out options cannot be configured; options in blue can. The right frame displays the key legend.

Above the key legend is an area reserved for a text message. When an option is selected in the left frame, it is highlighted in white. Often a text message will accompany it.

#### System time / System date

Use this option to change the system time and date. Highlight System Time or System Date using the <Arrow> keys. Enter new values through the keyboard. Press the <Tab> key or the <Arrow> keys to move between fields. The date must be entered in MM/DD/YY format. The time must be entered in HH:MM:SS format.

### 3.2.2 Advanced BIOS Features Setup

Select the Advanced tab from the ARK-3531 setup screen to enter the Advanced BIOS Setup screen. Users can select any item in the left frame of the screen, such as CPU Configuration, to go to the sub menu for that item. Users can display an Advanced BIOS Setup option by highlighting it using the <Arrow> keys. All Advanced BIOS Setup options are described in this section. The Advanced BIOS Setup screens are shown below. The sub menus are described on the following pages.

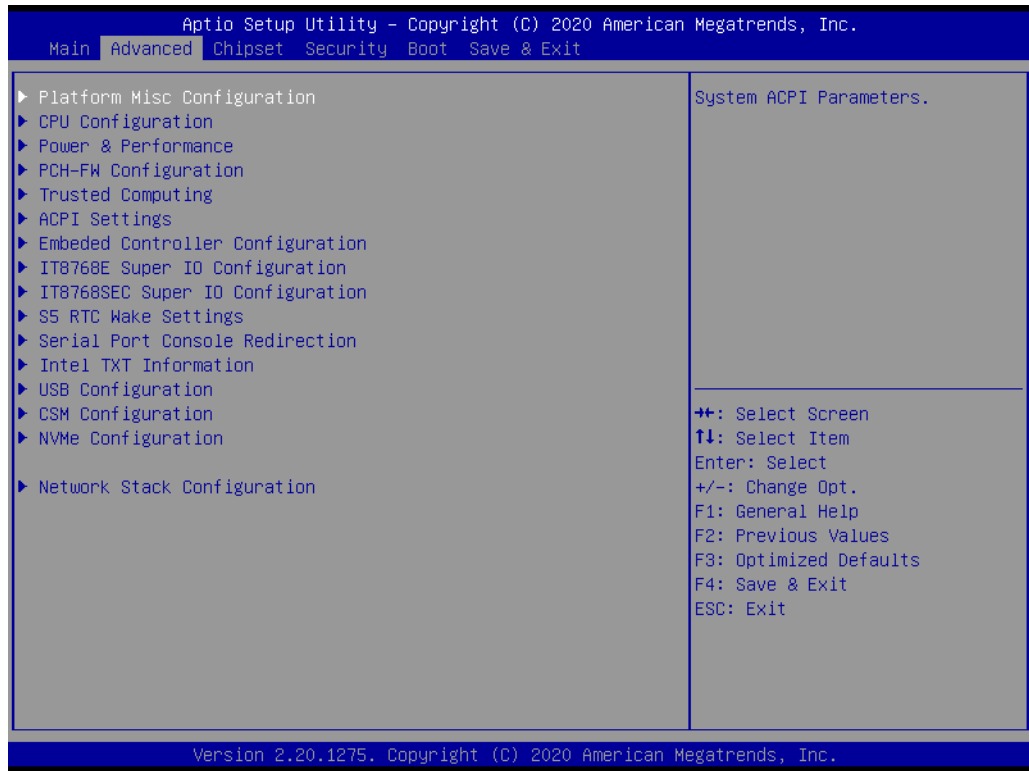

### 3.2.2.1 Platform Misc Configuration

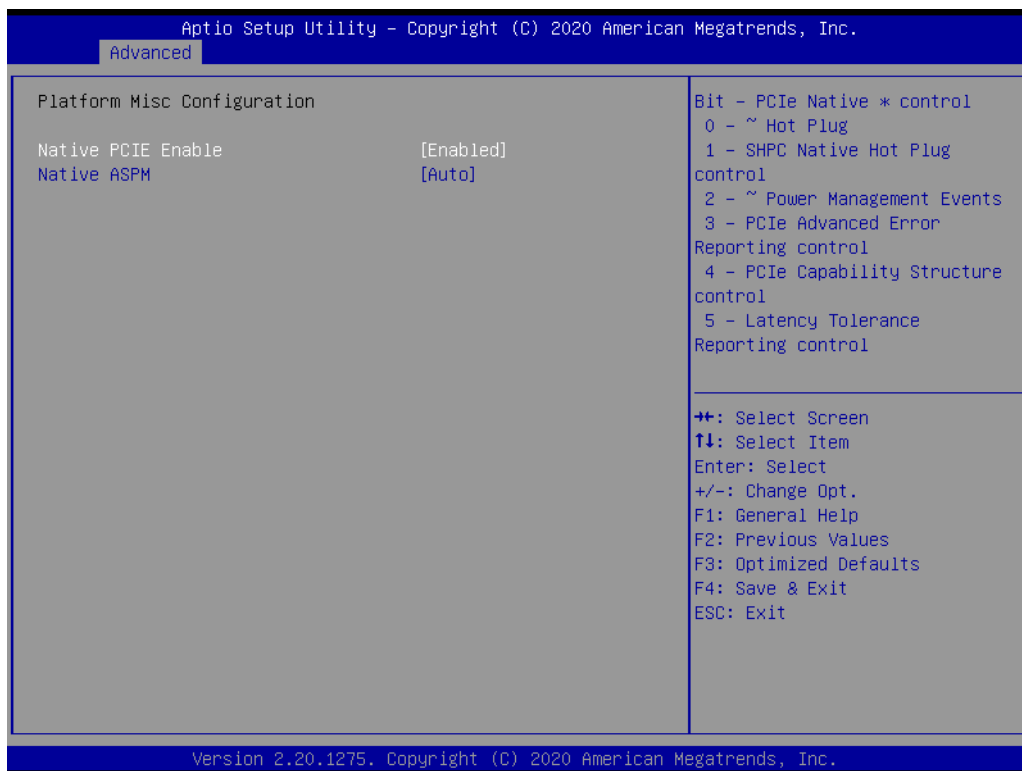

#### Native PCIE Enable

PCI Express Native Support Enable/Disable.

#### Native ASPM

When enabled, the OS will control the ASPM support for the device. If disabled, the BIOS will.

### 3.2.2.2 CPU Configuration

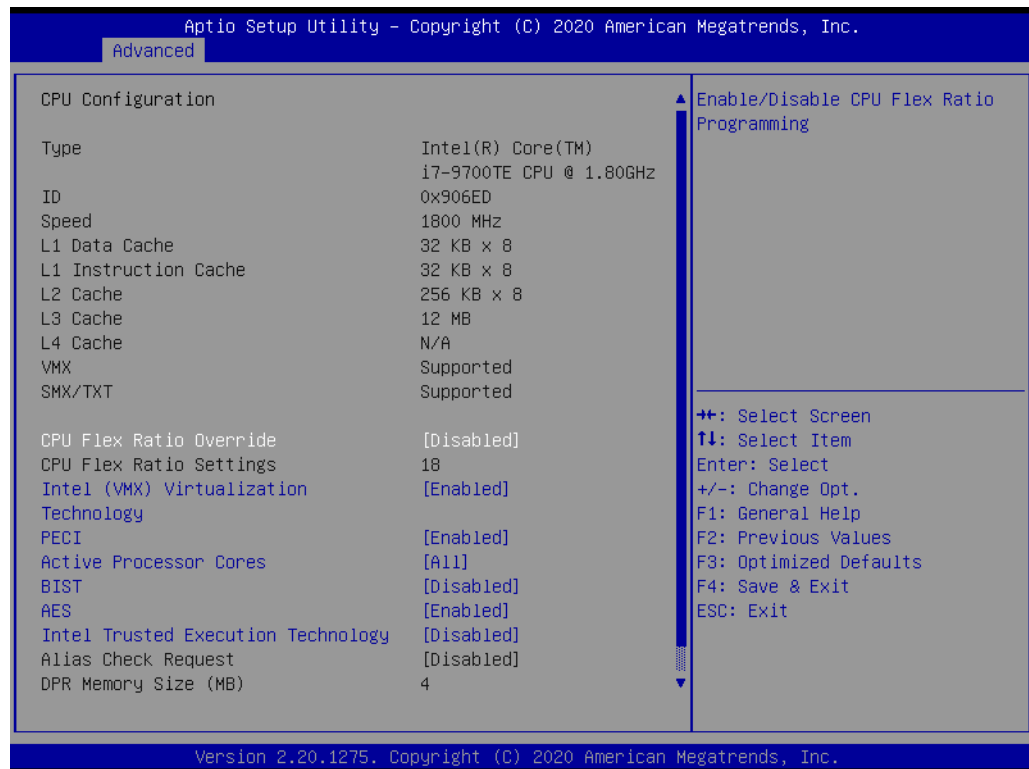

- **CPU Flex Ratio Override**  
This item allows users to enable or disable CPU Flex Ratio Override.
- **Intel® (VMX) Virtualization Technology**  
This feature is used to “Enable or Disable” the Intel® Virtualization Technology (IVT) extension. It allows multiple operating systems to run simultaneously on the same system by creating virtual machines, each running its own x86 operating system.
- **PECI**  
This item allows users to enable or disable Platform Environment Control Interface.
- **Active Processor Cores**  
This item allows users to set how many processor cores should be active.
- **BIST**  
This item allows users to enable or disable Built-In Self Test.
- **AES**  
“Enable or Disable” CPU advanced encryption standard instruction.
- **Intel® Trusted Execution Technology**  
“Enable or Disable” utilization of additional hardware capabilities provided by Intel® Trusted Execution Technology. Changes require a full power cycle to take effect.
- **Alias Check Request**  
This item allows users to enable or disable Alias Check Request.
- **Reset AUX Content**  
Reset TPM AUX content. TXT may not be functional after AUX content gets reset.

### 3.2.2.3 Power & Performance – CPU Power Management Control

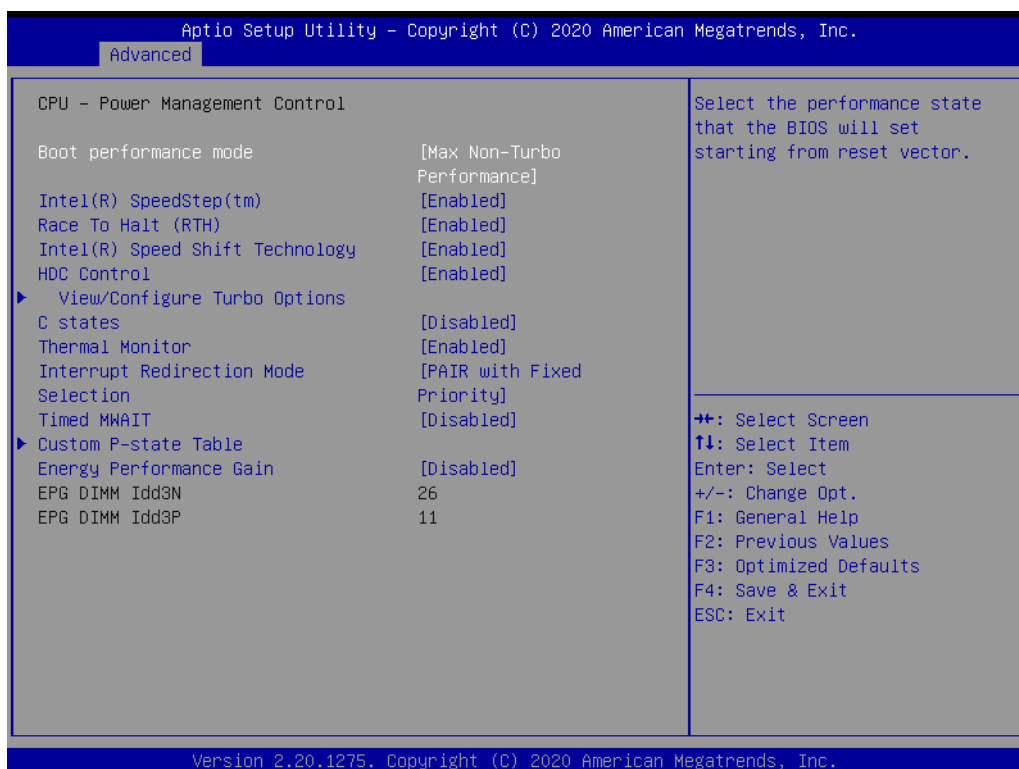
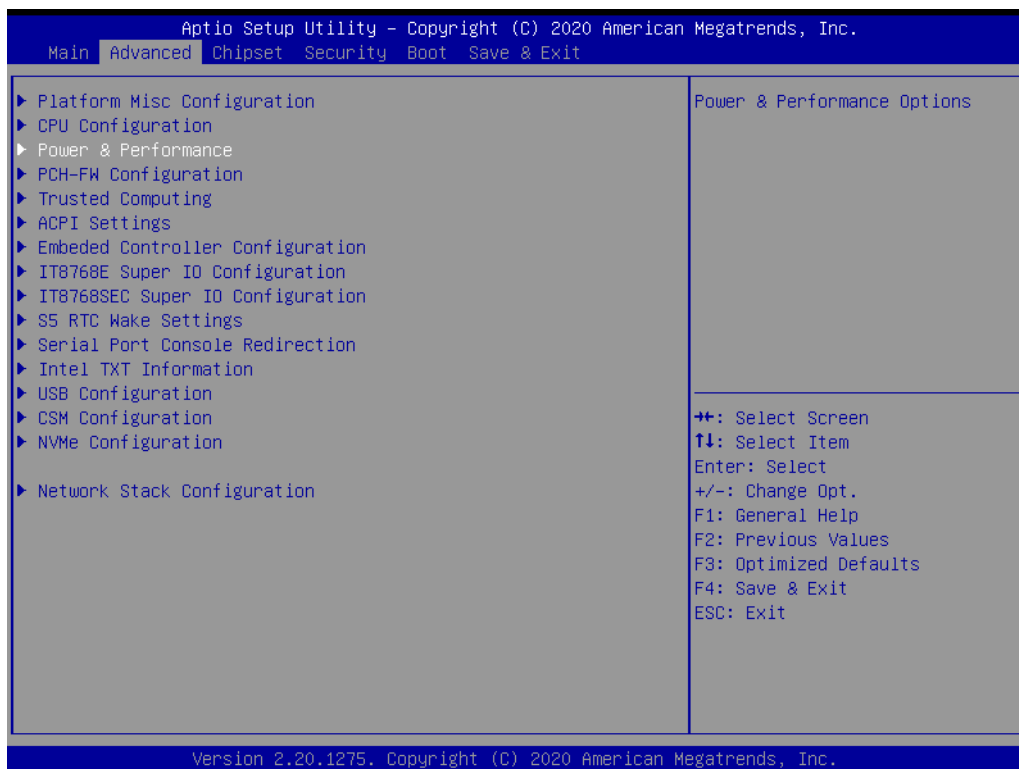

- **Boot Performance**  
Select the performance state that the BIOS will set before OS hand-off.
- **Intel® Speedstep™**  
Allows more than two frequency ranges to be supported.

- 
- **Race to Halt (RTH)**  
Enable/Disable Race to Halt feature. RTH will dynamically increase CPU frequency in order to enter pkg C-State faster to reduce overall power.
  - **Intel® Speed Shift Technology**  
Enable/Disable Intel (R) Speed Shift Technology support. Enabling will expose the CPPC v2 interface to allow for hardware controlled P-states.
  - **HDC Control**  
This option allows HDC configuration.  
Disabled: Disable HDC  
Enabled: Can be enabled by OS if OS native support is available.
  - **C states**  
Intel® C states setting for power saving.
  - **Thermal Monitor**  
Enable/Disable Thermal Monitor.
  - **Interrupt Redirection Mode Selection**  
Interrupt Redirection Mode Select for Logical Interrupts.
  - **Timed MWAIT**  
Enable/Disable Timed MWAIT Support.
  - **Energy Performance Gain**  
Enable/Disable Energy Performance Gain.



### 3.2.2.4 Power & Performance – GT Power Management Control

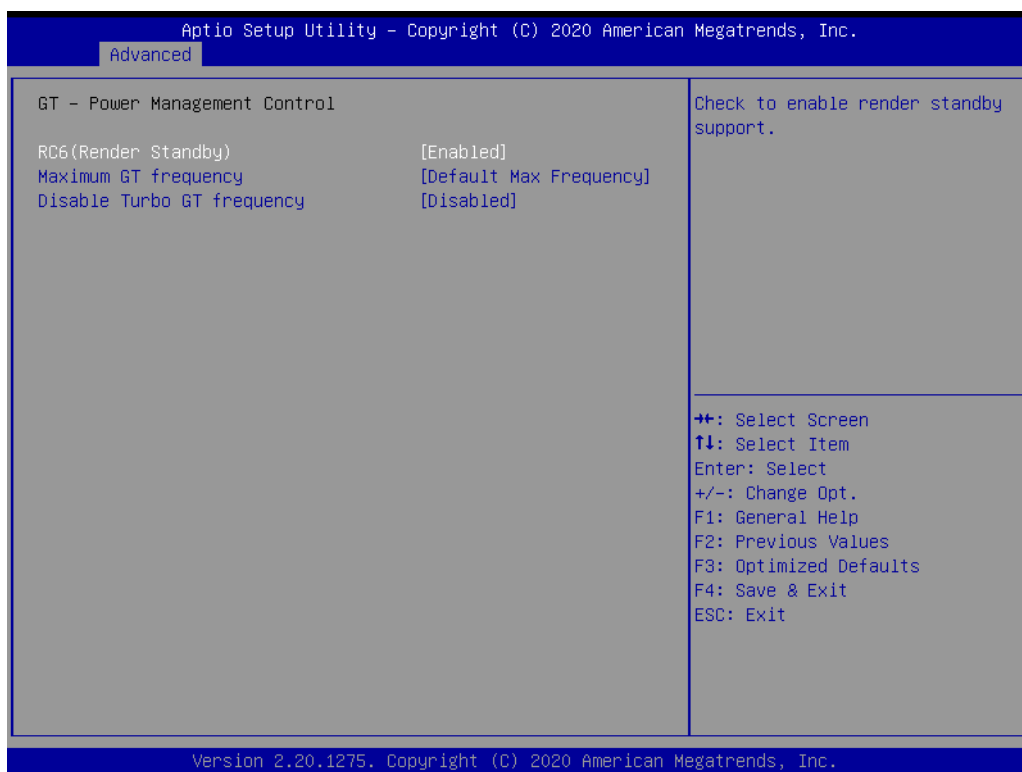
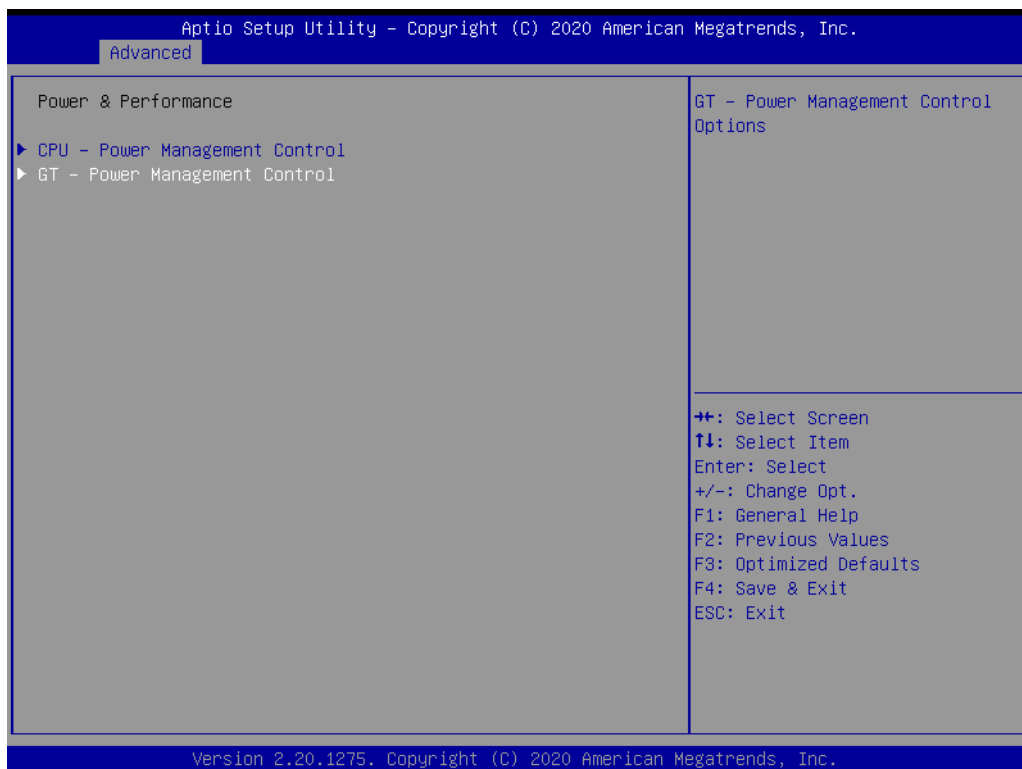

- **RC6 (Render Standby)**  
Check to enable render standby support.
- **Maximum GT frequency**  
Maximum GT frequency limited by the user.

- **Disable Turbo GT frequency**  
Enabled: Disables Turbo GT frequency. Disabled: GT frequency is not limited.

### 3.2.2.5 PCH-FW Configuration

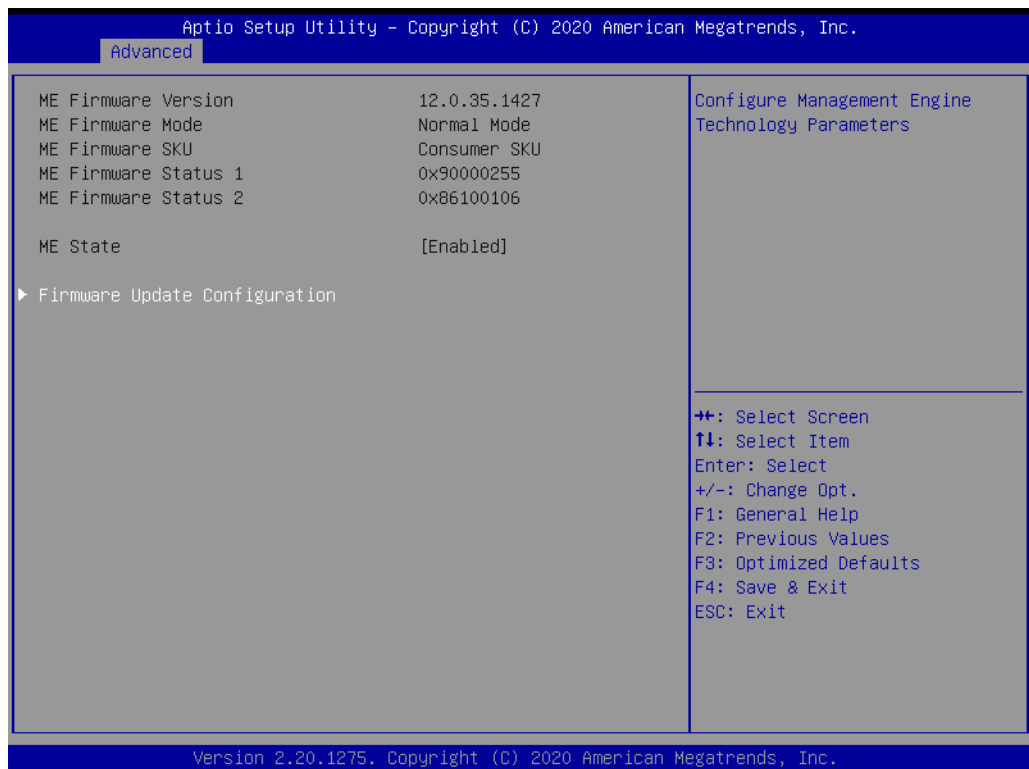
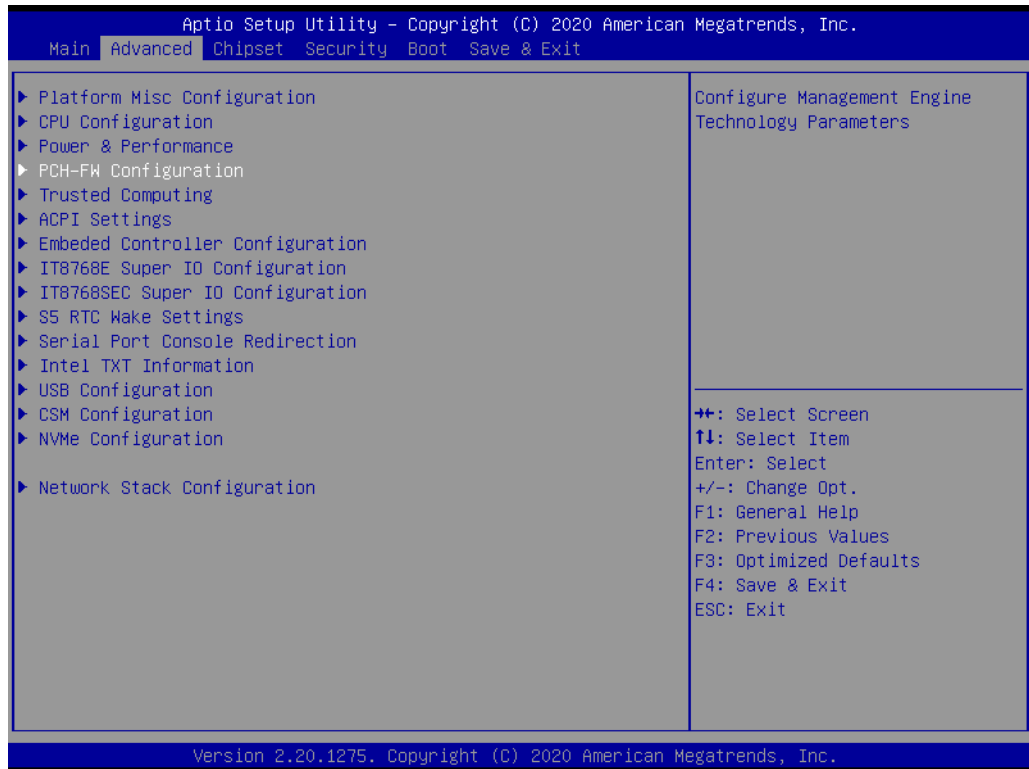

- **PCH-FW Version**  
PCH-FW page shows Intel® ME FW information.

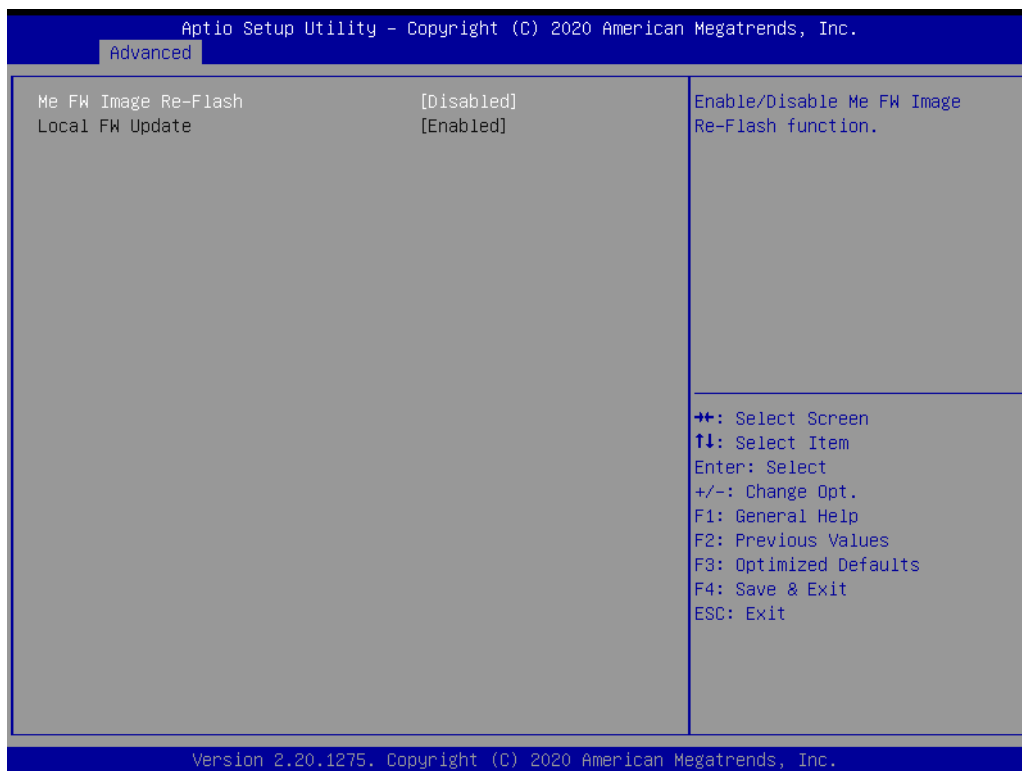

- **ME FW Image Re-flash**  
“Enable or Disable” ME firmware image re-flash function.

### 3.2.2.6 Trusted Computing

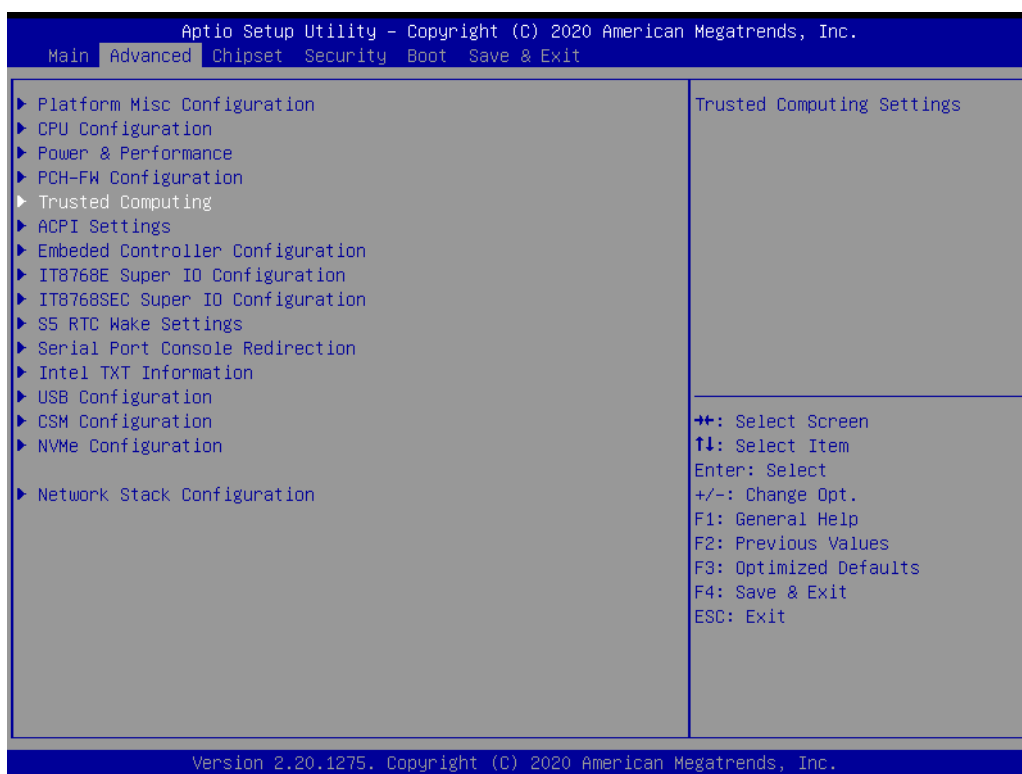

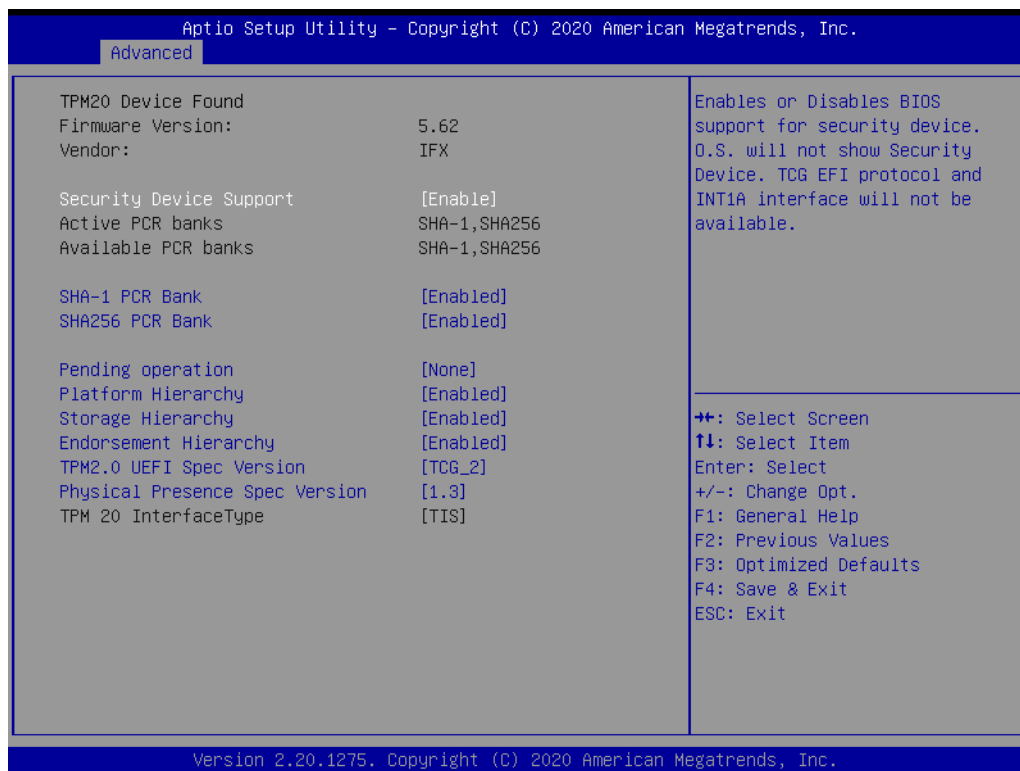

- **TPM Support**  
“Enable or Disable” TPM Support.
- **Security Device Support**  
Enables or Disables BIOS support for security device.
- **SHA-1 PCR Bank**  
Enable or Disable SHA-1 PCR Bank.
- **SHA256 PCR Bank**  
Enable or Disable SHA256 PCR Bank.
- **Pending Operation**  
Schedule an Operation for the Security Device. NOTE: Your Computer will reboot during restart in order to change State of Security Device.
- **Platform Hierarchy**  
Enable or Disable Platform Hierarchy.
- **Storage Hierarchy**  
Enable or Disable Storage Hierarchy.
- **Endorsement Hierarchy**  
Enable or Disable Endorsement Hierarchy.
- **TPM 2.0 UEFI Spec Version**  
Select the TCG2 Spec Version Support. TCG\_1\_2:the Compatible mode for Win8/Win10. TCG\_2:Support new TCG2 protocol and event format for Win10 or later.
- **Physical Presence Spec Version**  
Select to Tell O.S. to support PPI Spec Version 1.2 or 1.3. Note some HCK tests might not support 1.3.

### 3.2.2.7 ACPI Settings

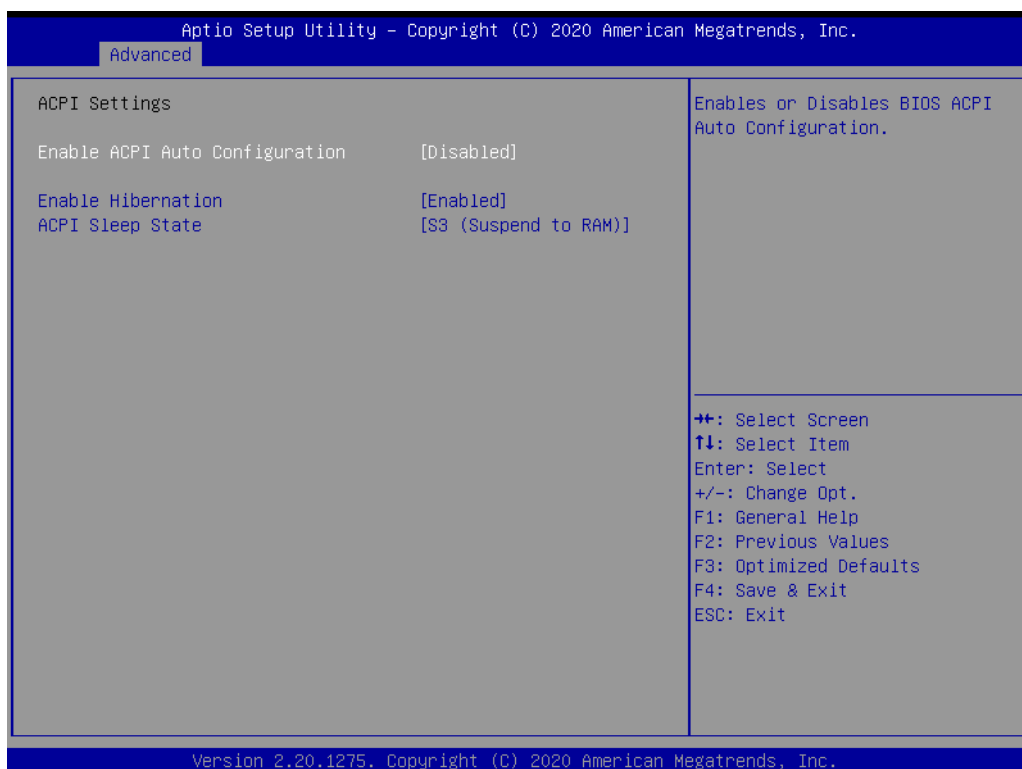
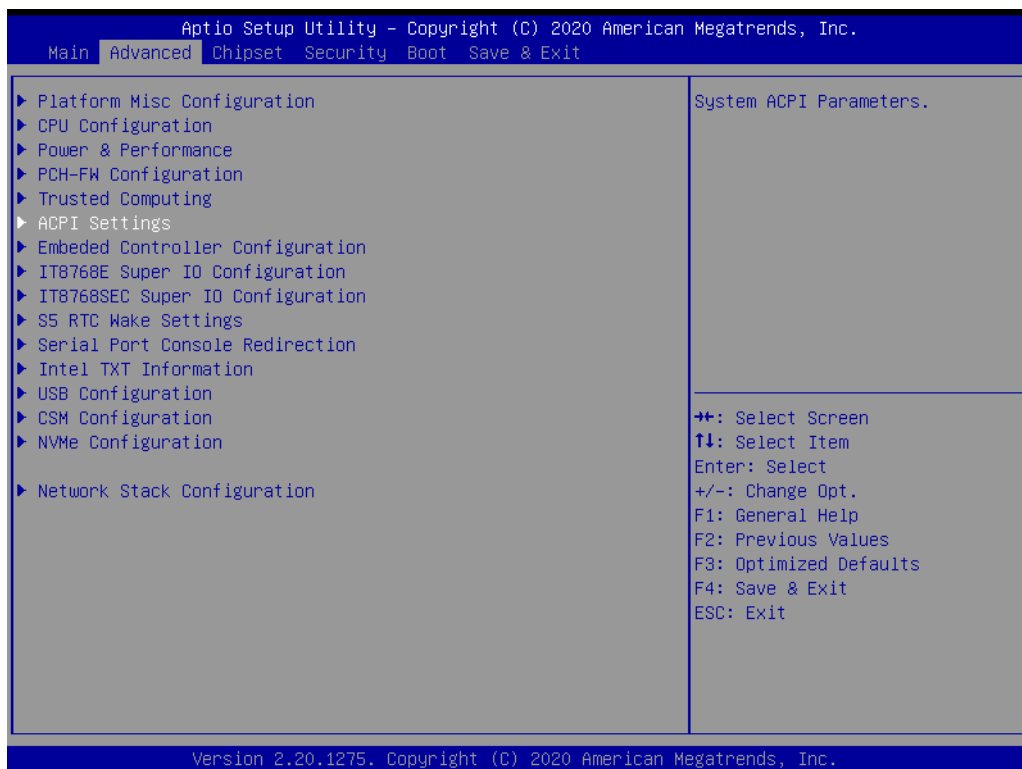

- **Enable ACPI Auto Configuration**  
Enables or Disables BIOS ACPI Auto Configuration.
- **Enable Hibernation**  
“Enable or Disable” Hibernation (OS/S4 Sleep State). This option may not be applied in some OS.

- **ACPI Sleep State**  
“Auto or S1 only or S3 only” ACPI Sleep State.

### 3.2.2.8 Embedded Controller Configuration

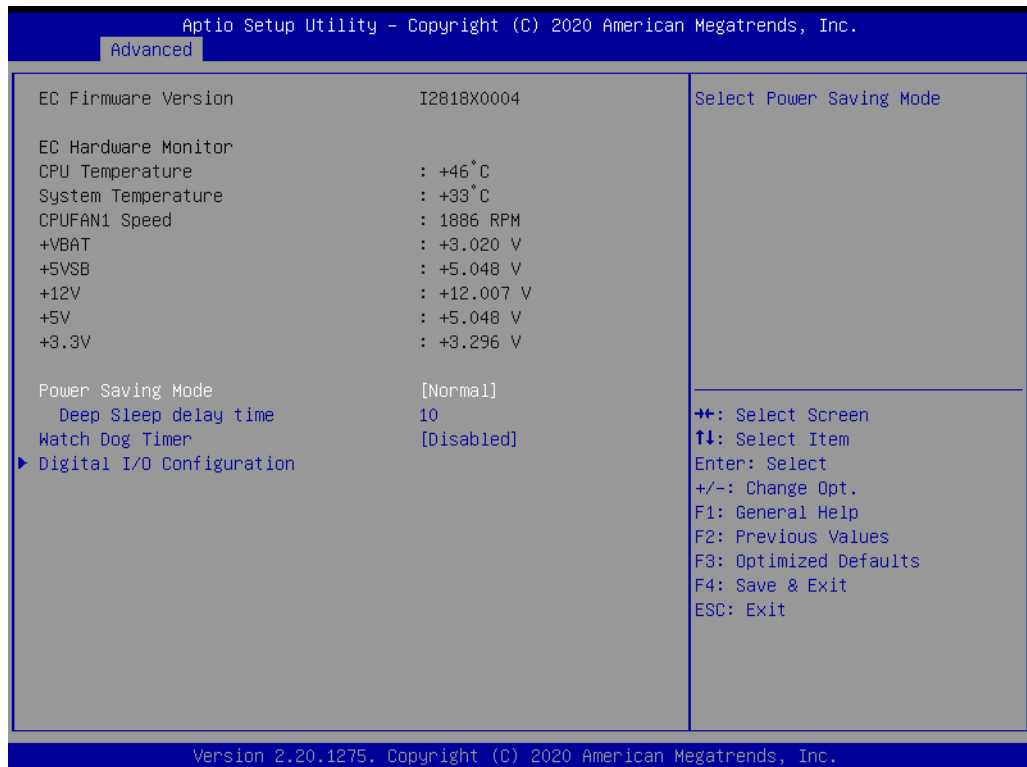
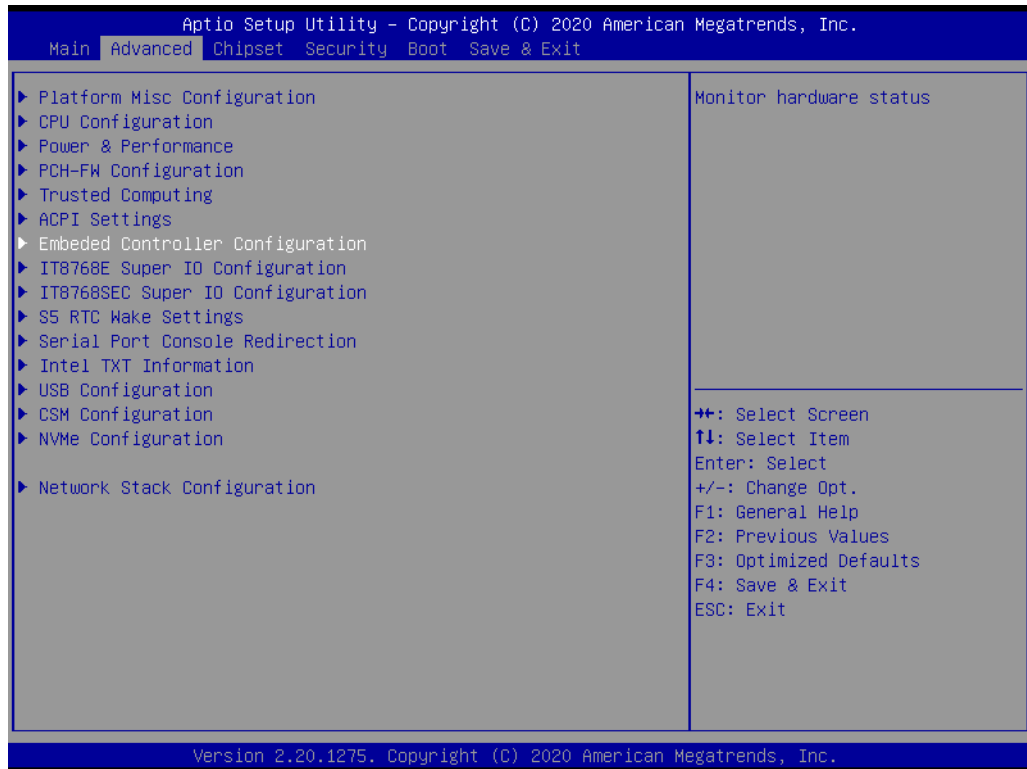

- **EC Hardware Monitor**  
This page displays all information about system Temperature/Voltage/Current.

- **Power Saving Mode**  
This item allows users to set the board's power saving mode when off.
- **Watch Dog Timer**  
Enable or Disable Watchdog Timer function (Starts before OS boots).

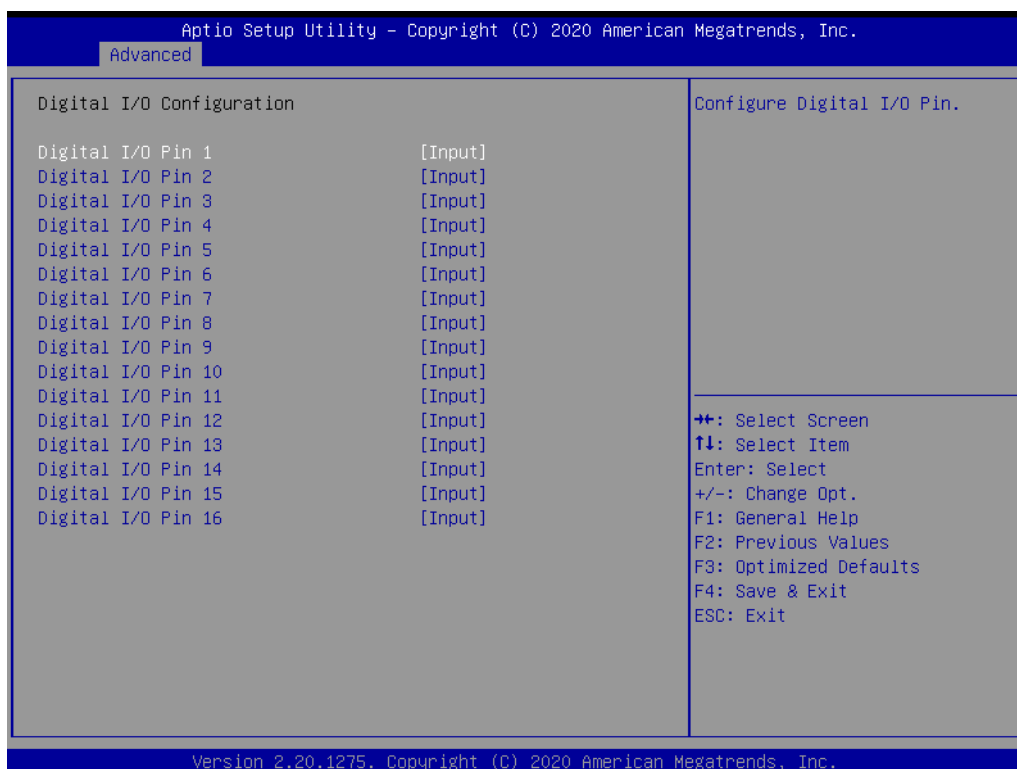
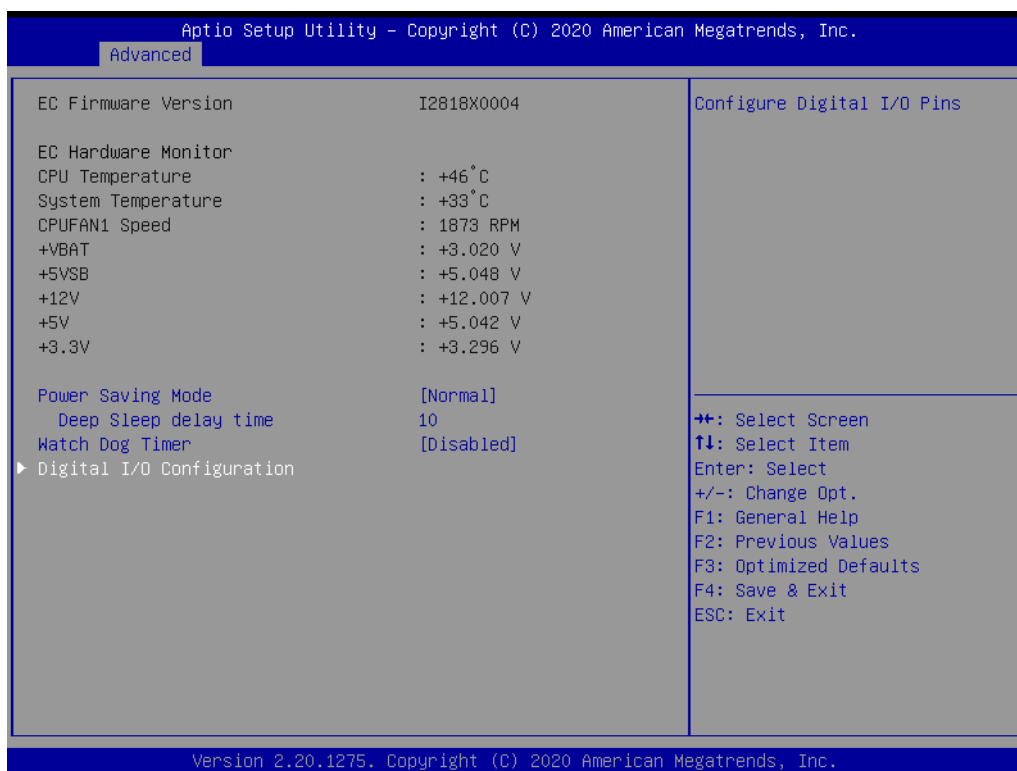

- **Digital I/O Configuration**  
This item allows users to set the Digital I/O to Input or Output.

### 3.2.2.9 Super I/O Configuration

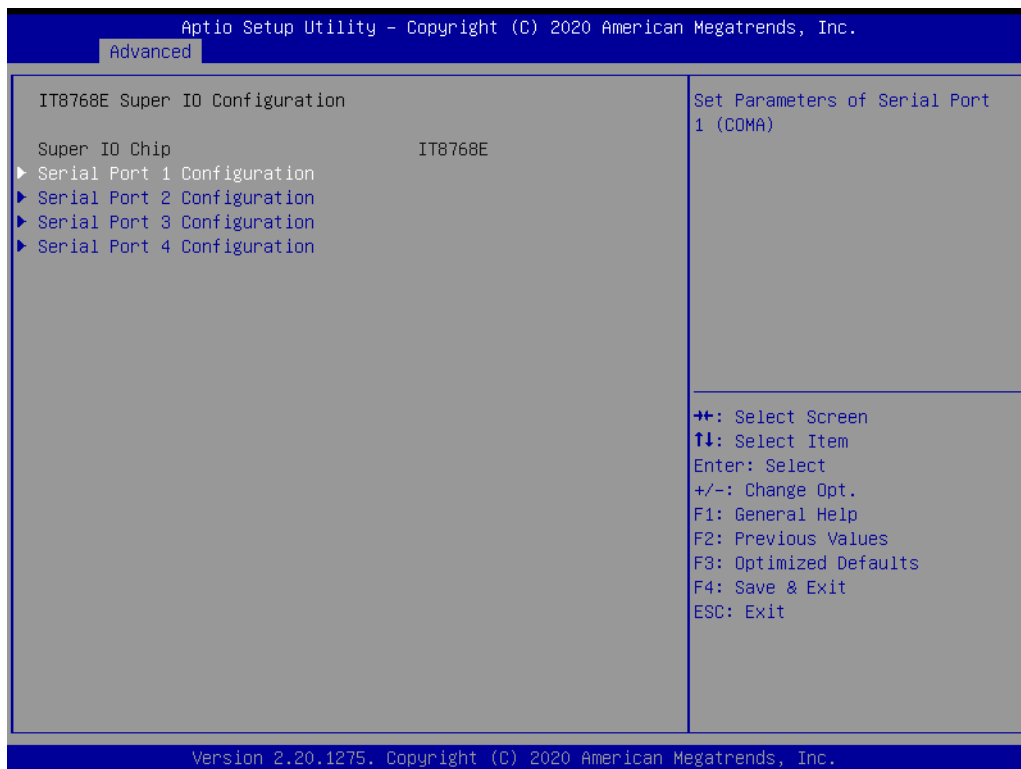
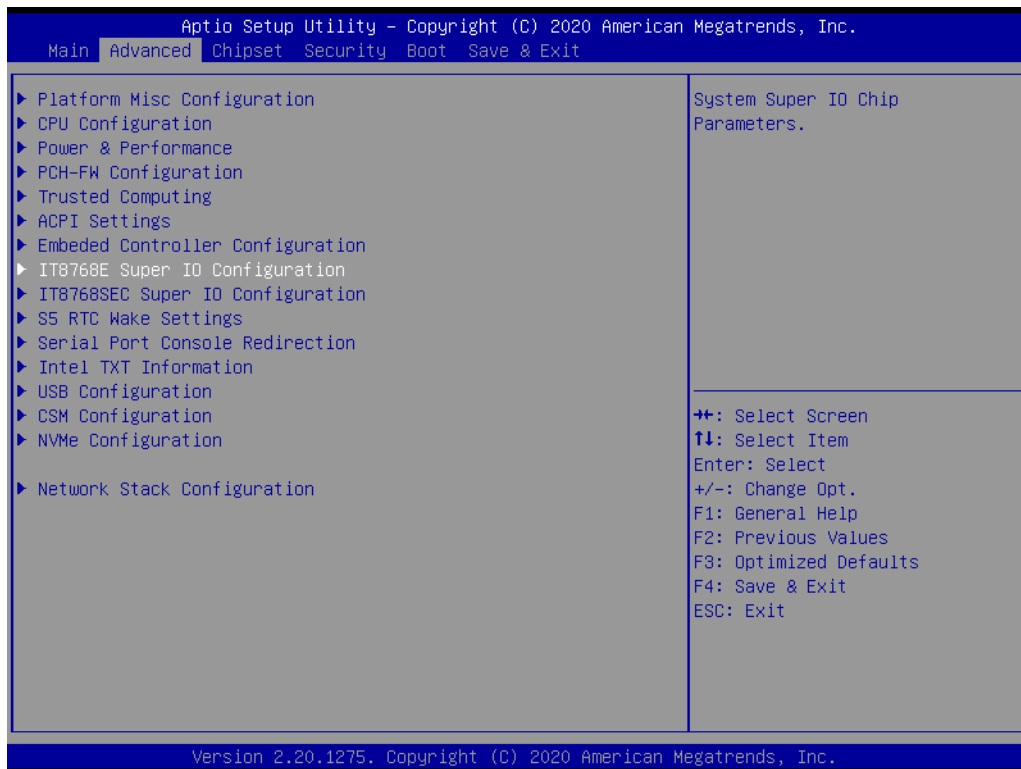



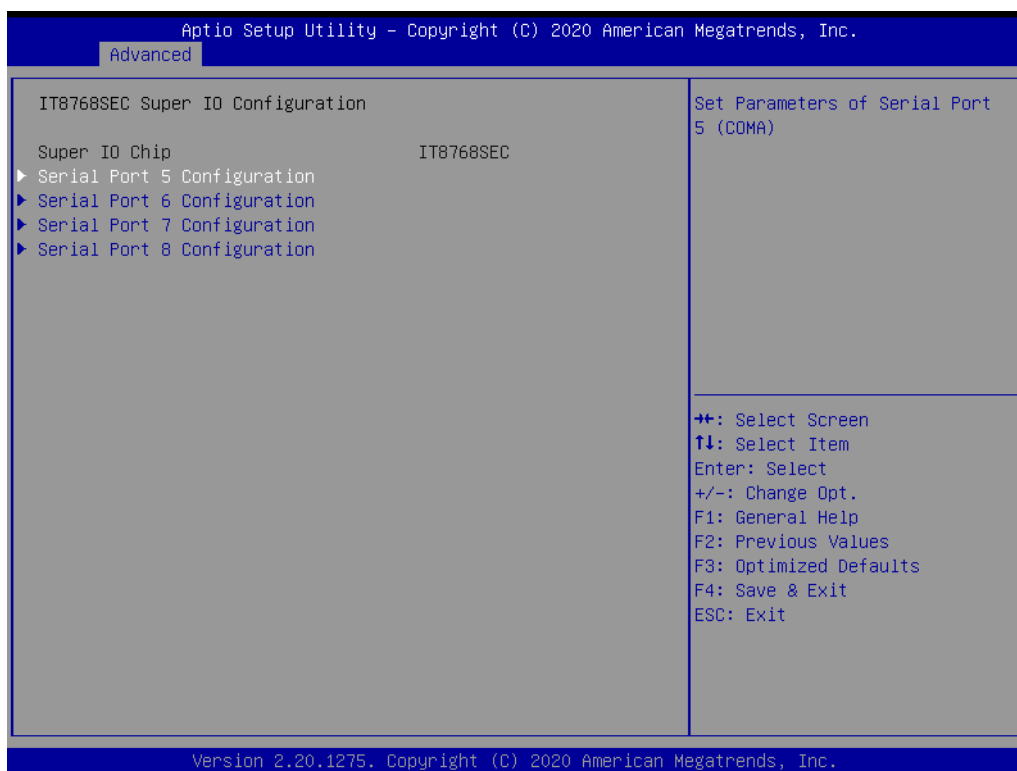
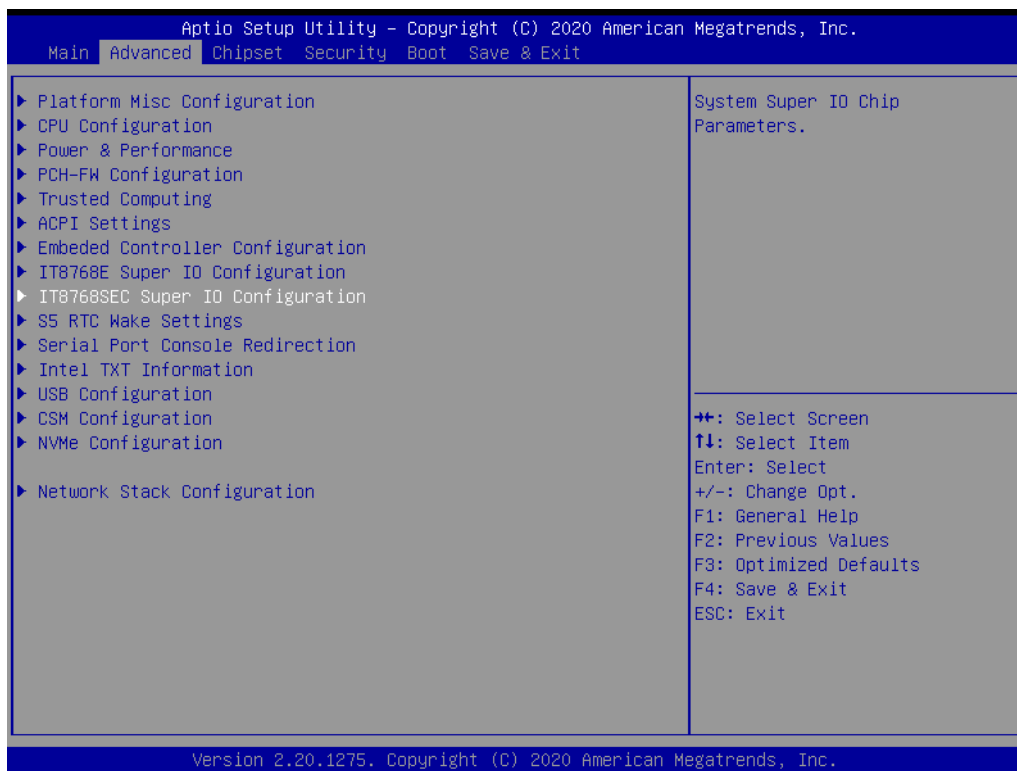

- **Serial Port 1 Configuration**  
Set Parameters of Serial Port 1.
- **Serial Port 2 Configuration**  
Set Parameters of Serial Port 2.
- **Serial Port 3 Configuration**  
Set Parameters of Serial Port 3.

- 
- **Serial Port 4 Configuration**  
Set Parameters of Serial Port 4.
  - **Serial Port 5 Configuration**  
Set Parameters of Serial Port 5.
  - **Serial Port 6 Configuration**  
Set Parameters of Serial Port 6.
  - **Serial Port 7 Configuration**  
Set Parameters of Serial Port 7.
  - **Serial Port 8 Configuration**  
Set Parameters of Serial Port 8.

### 3.2.2.10 S5 RTC Wake Settings

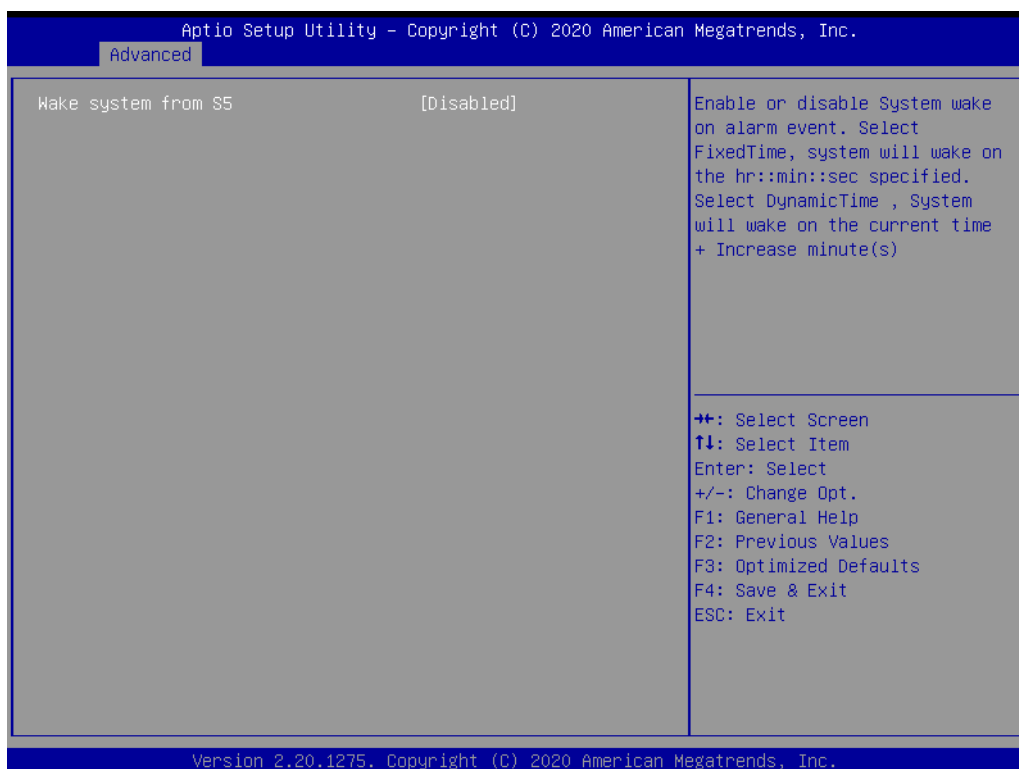
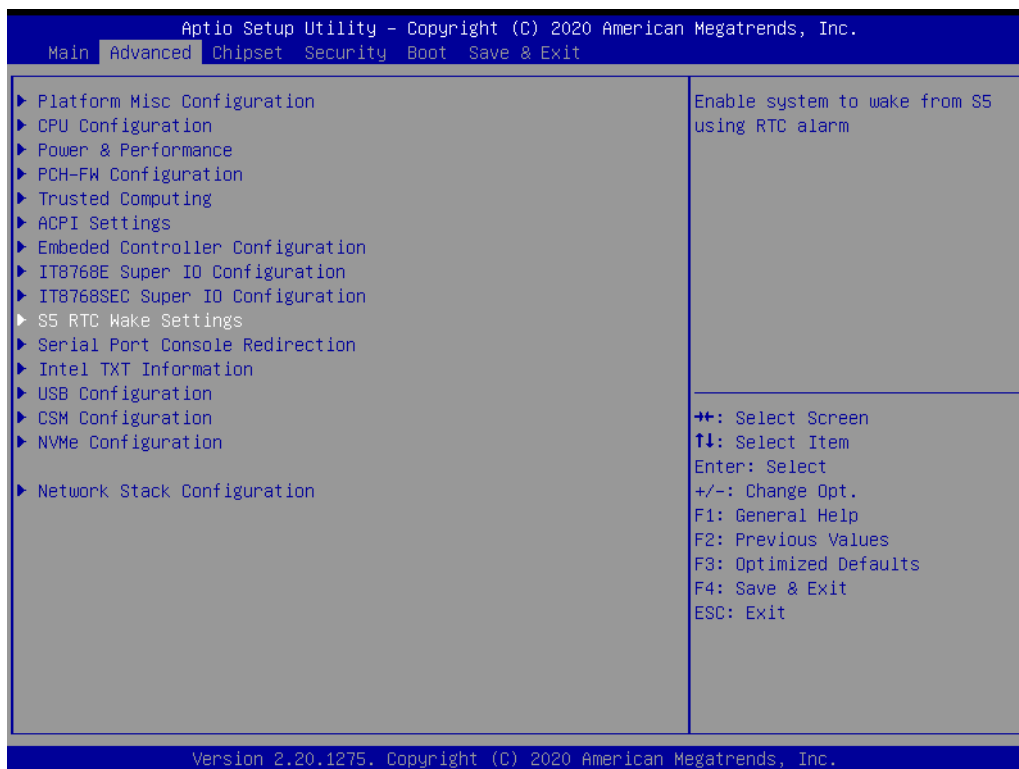

- **Wake System From S5**  
 Enable or disable System wake on alarm event. Select FixedTime, system will wake on the hr::min::sec specified.

### 3.2.2.11 Serial Port Console Redirection

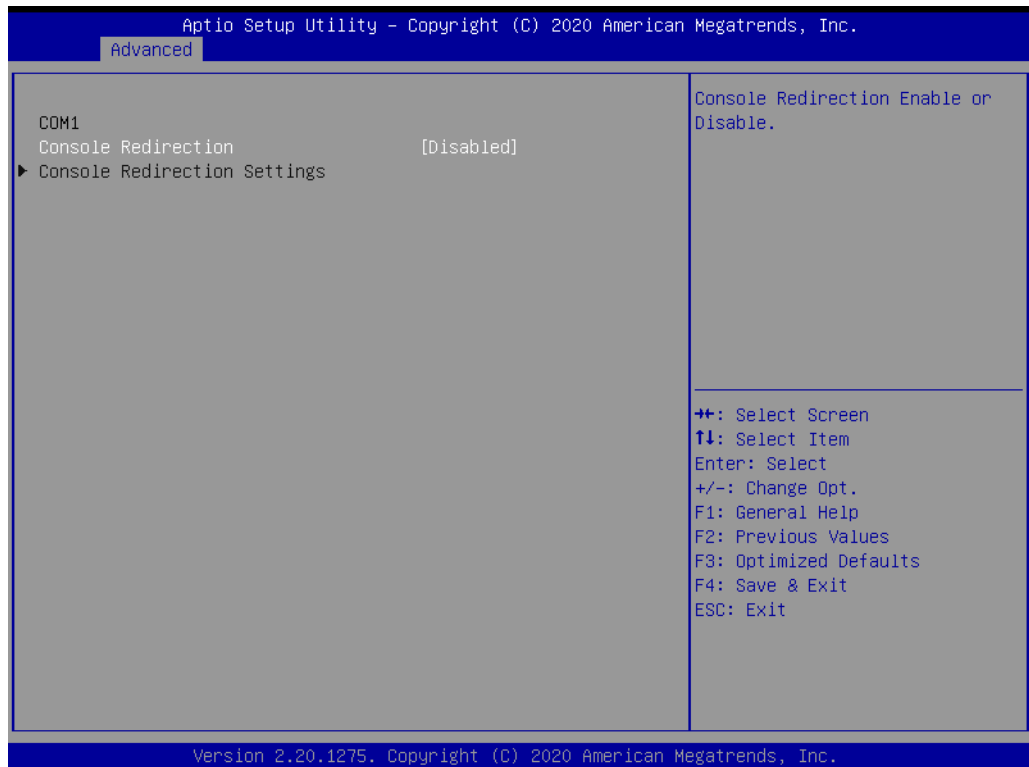
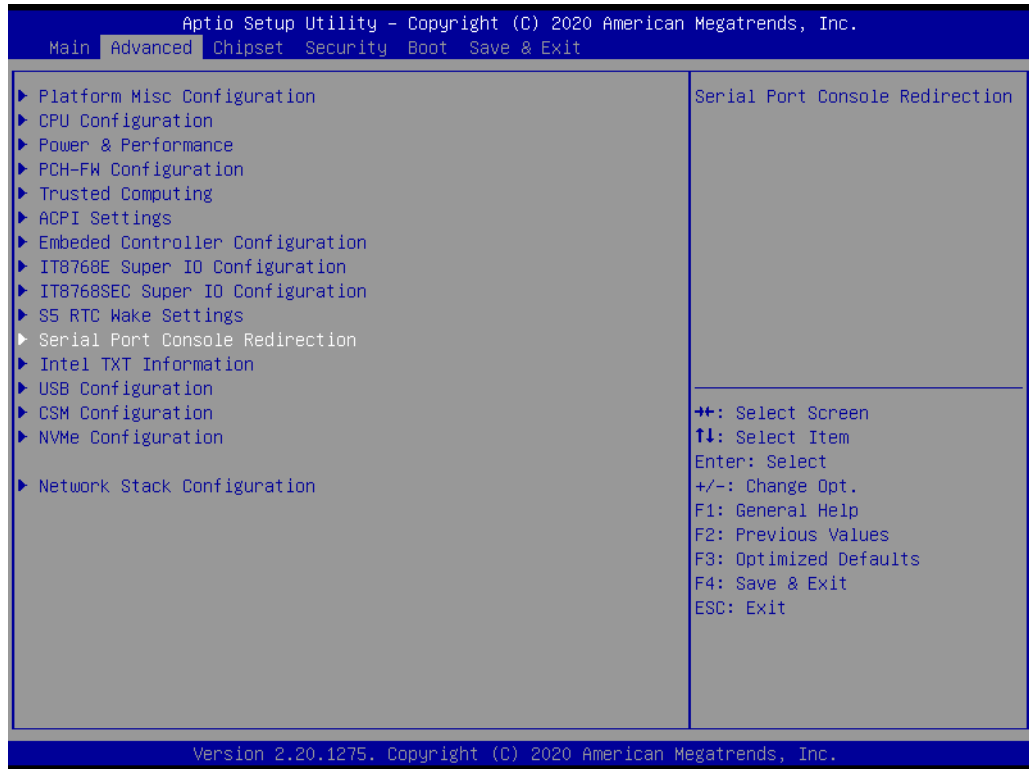

- **Console Redirection**  
This item allows users to enable or disable console redirection for Microsoft Windows Emergency Management Services (EMS).
- **Console Redirection Setting**  
This item allows users to configuration console redirection detail settings.

### 3.2.2.12 Intel TXT Information

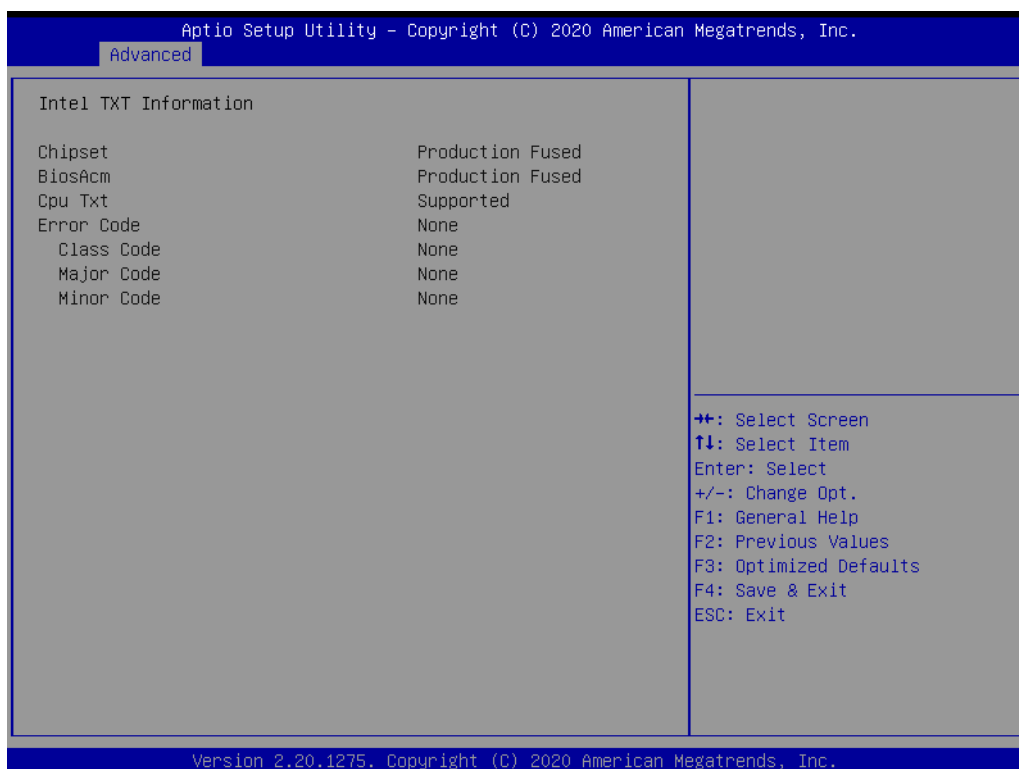
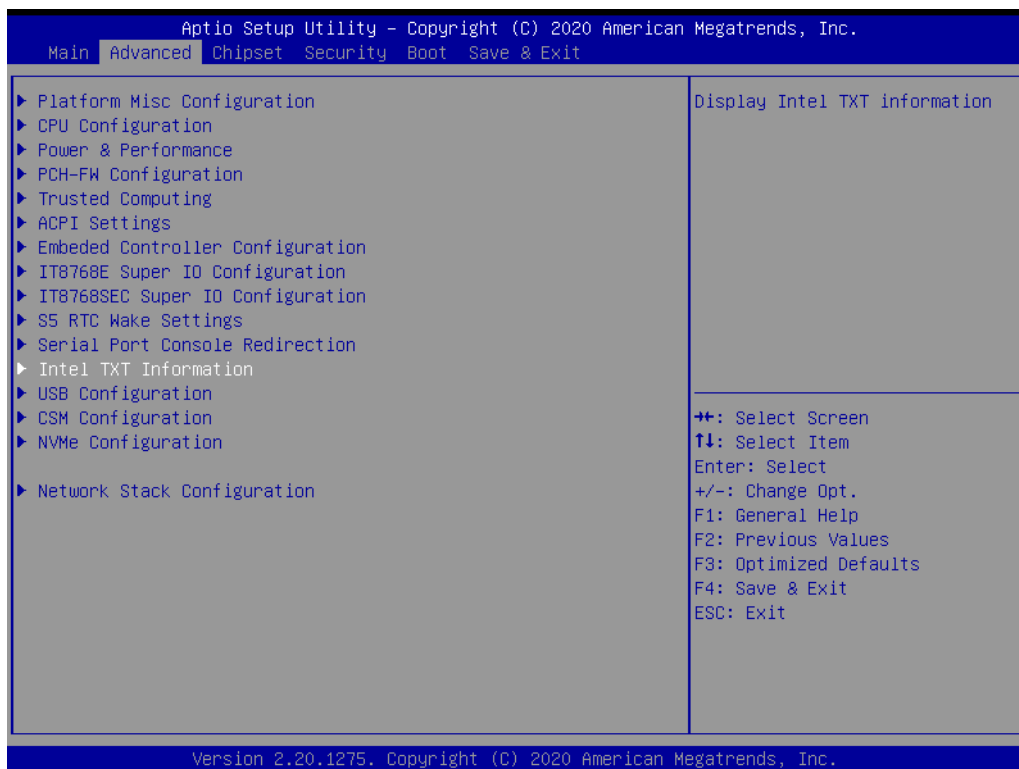

- **Intel TXT Information**  
 Display Intel TXT information.

### 3.2.2.13 USB Configuration

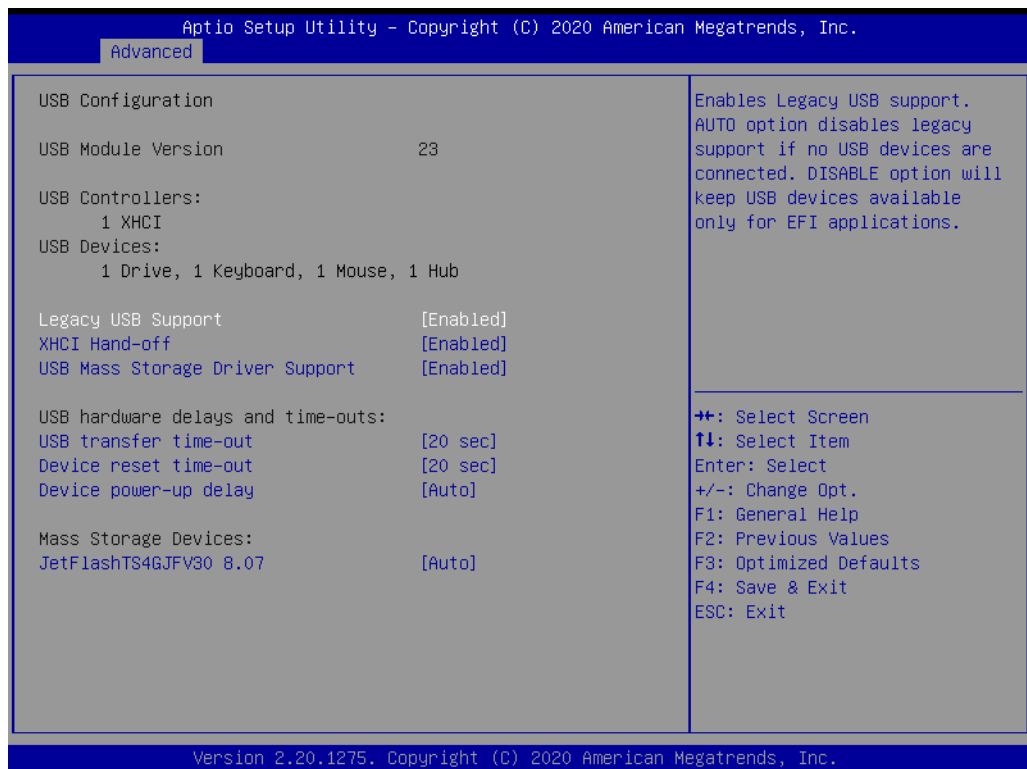
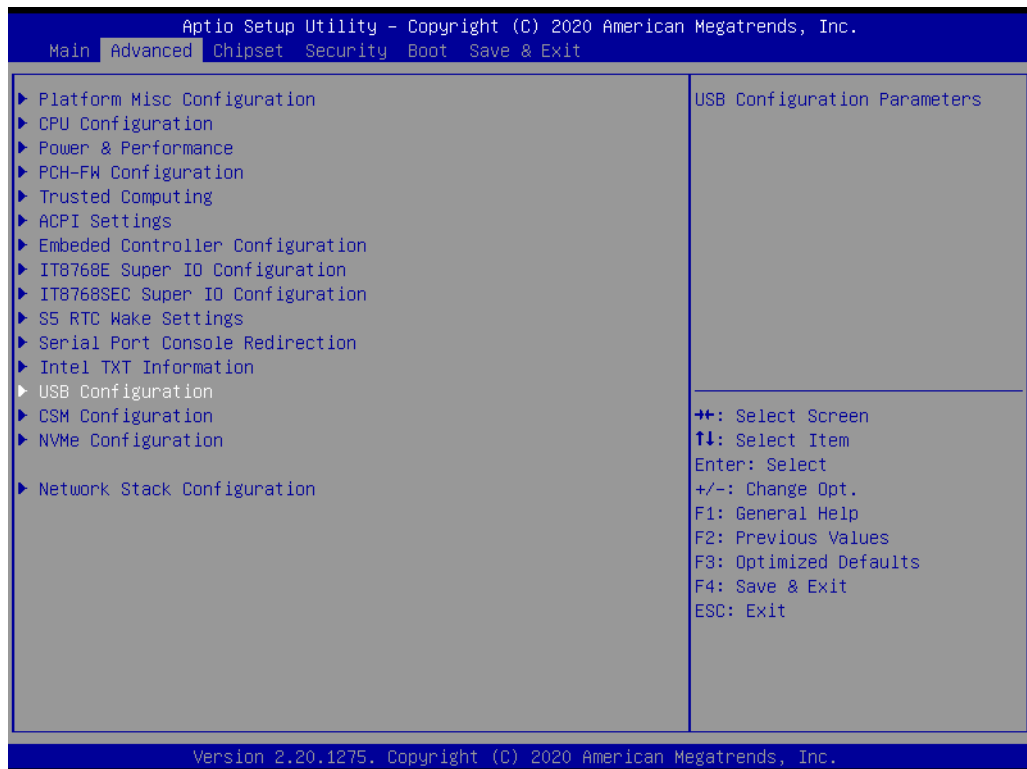

- **Legacy USB Support**

This supports USB devices with legacy OS such as DOS. When choosing “AUTO”, the system will automatically detect USB devices. It will enable USB legacy mode when a USB device is plugged in and disable USB legacy mode when no USB device is plugged in.

- **XHCI Hand-off**  
This is a workaround for OS without XHCI hand-off support. The XHCI ownership change should be claimed by XHCI driver.
- **USB Mass Storage Driver Support**  
“Enable or Disable” USB Mass Storage driver support.
- **USB Transfer Time-Out**  
Allows you to select the USB transfer time-out value. [1,5,10,20sec].
- **Device Reset Time-Out**  
Allows you to select the USB device reset time-out value. [10,20,30,40sec].
- **Device Power-Up Delay**  
Maximum time the device will take before it properly reports itself to the Host Controller. “Auto” uses default value: for a Root port it is 100 ms, for a Hub port the delay is take from Hub descriptor.
- **Mass Storage Devices**  
Mass storage device emulation type. “Auto” enumerates device according to their media format. Optical drives are emulated as “CD-ROM”, drives with no media will be emulated according to a drive type.

### 3.2.2.14 CSM Configuration

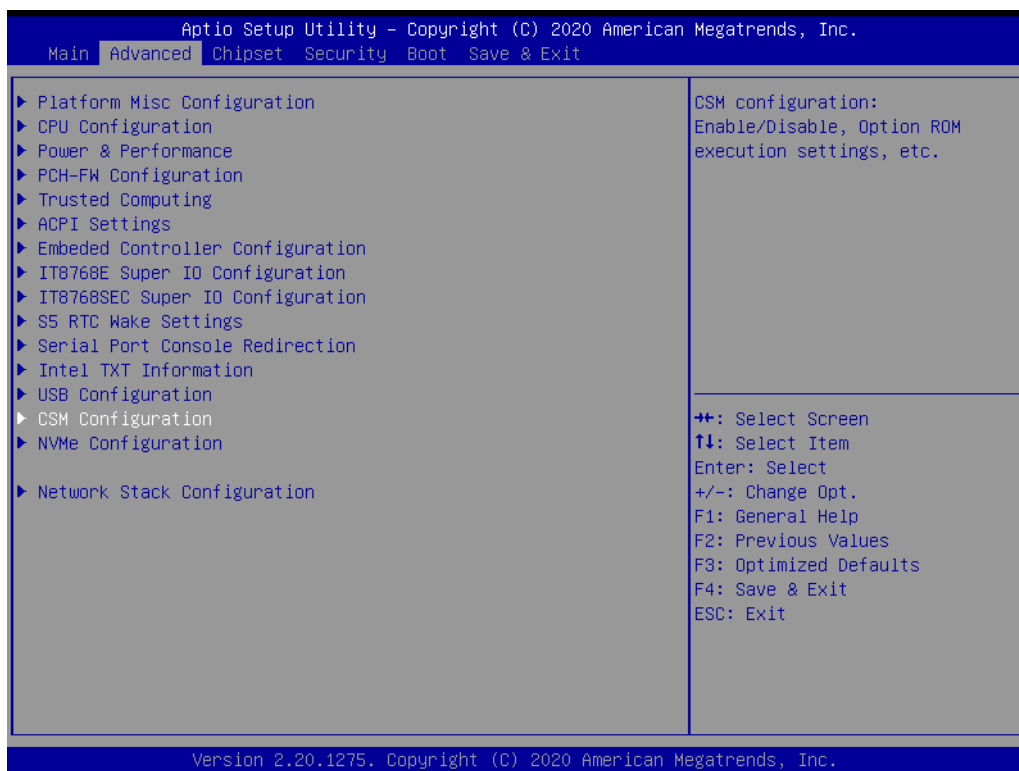

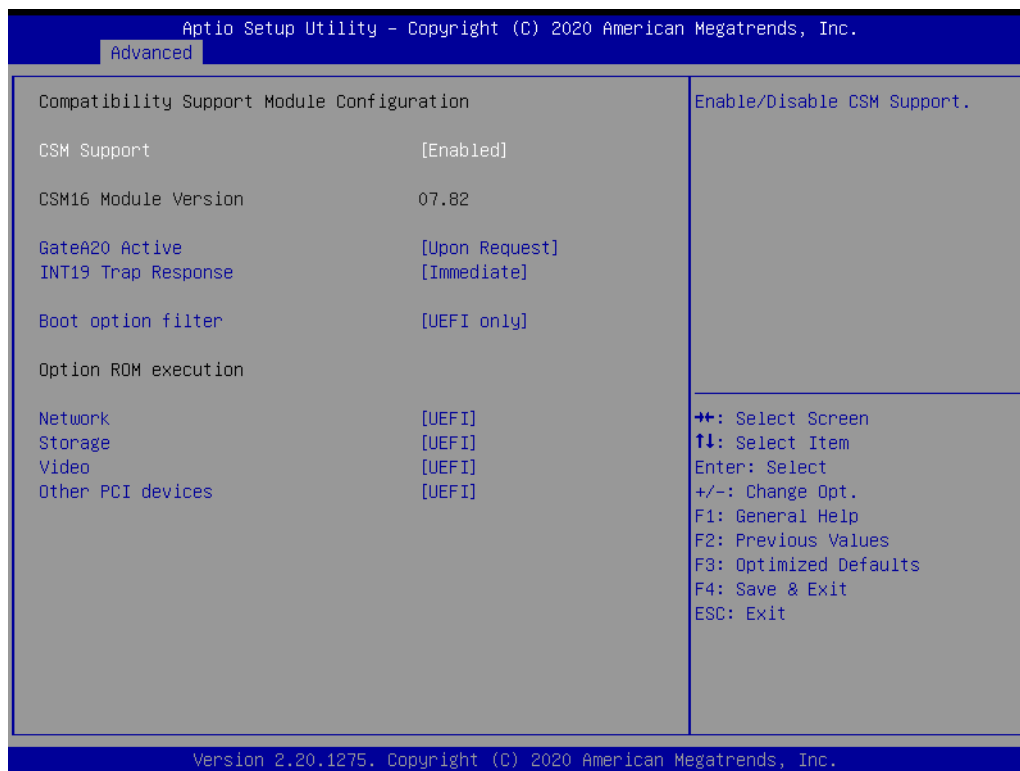

## Compatibility Support Module Configuration

- **CSM Support**  
Enable/Disable CSM Support.
- **GateA20 Active**  
UPON REQUEST - GA20 can be disabled using BIOS services. ALWAYS - do not allow disabling GA20; this option is useful when any RT code above 1MB is executed.
- **INT19 Trap Response**  
BIOS reaction on INT19 trapping by Option ROM: IMMEDIATE - execute the trap right away; POSTPONED - execute the trap during legacy boot.
- **Boot option filter**  
This option controls Legacy/UEFI ROMs priority.
- **Option ROM Message**  
BIOS Set display mode for Option ROM.
- **Network**  
Controls the execution of UEFI and Legacy PXE OpROM.
- **Storage**  
Controls the execution of UEFI and Legacy Storage OpROM.
- **Video**  
Controls the execution of UEFI and Legacy Video OpROM.
- **Other PCI devices**  
Determines OpROM execution policy for devices other than Network, Storage, or Video.



### 3.2.2.15 NVMe Configuration

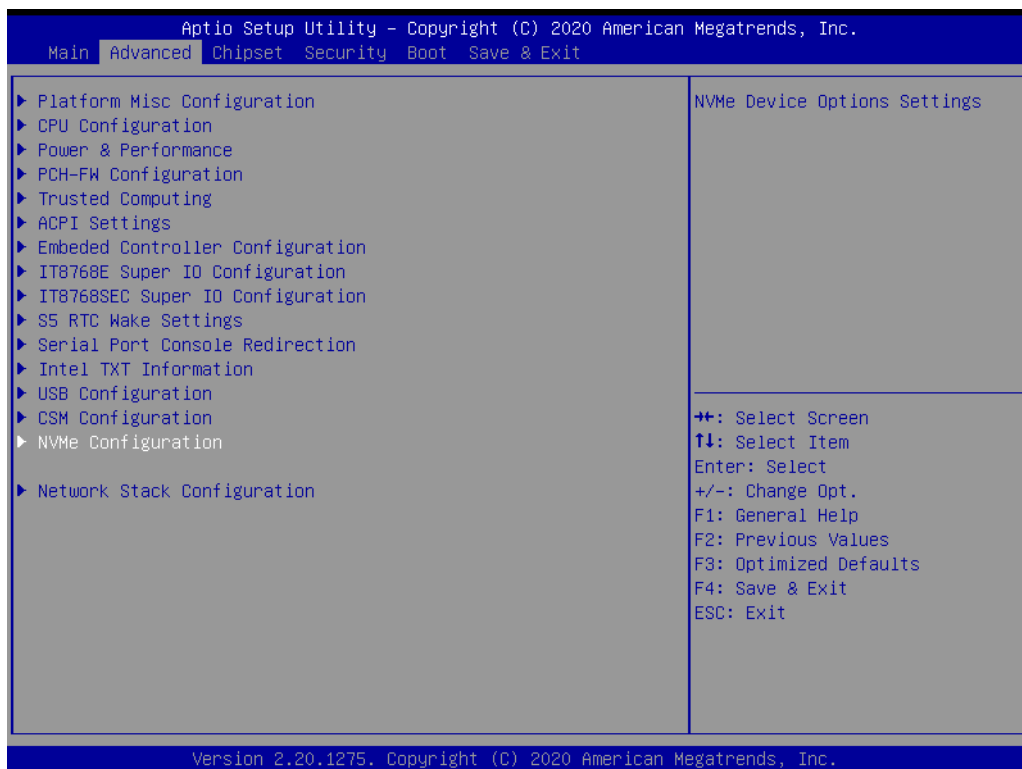

#### NVMe Device Options Settings

### 3.2.2.16 Network Stack Configuration

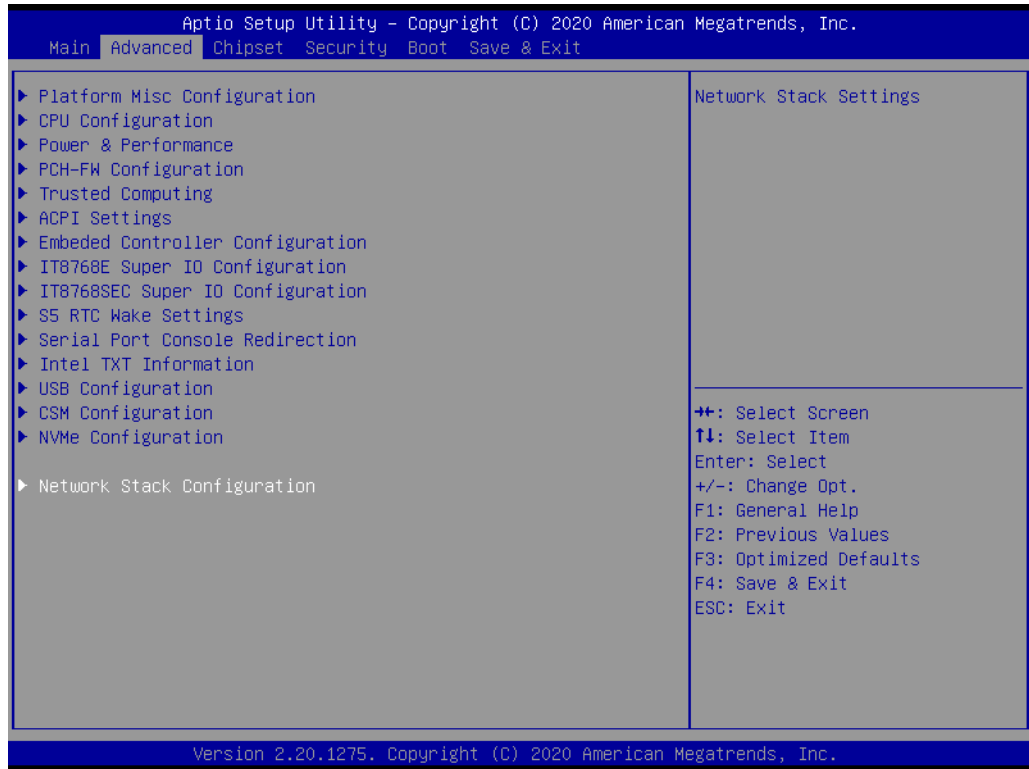

- **Network Stack**  
“Enable or Disable” UEFI Network Stack.

### 3.2.3 Chipset Configuration

Select the Chipset tab from the ARK-3531 setup screen to enter the Chipset BIOS Setup screen. You can display a Chipset BIOS Setup option by highlighting it using the <Arrow> keys. All Plug and Play BIOS Setup options are described in this section. The Plug and Play BIOS Setup screen is shown below.



### 3.2.3.1 Memory Configuration Options

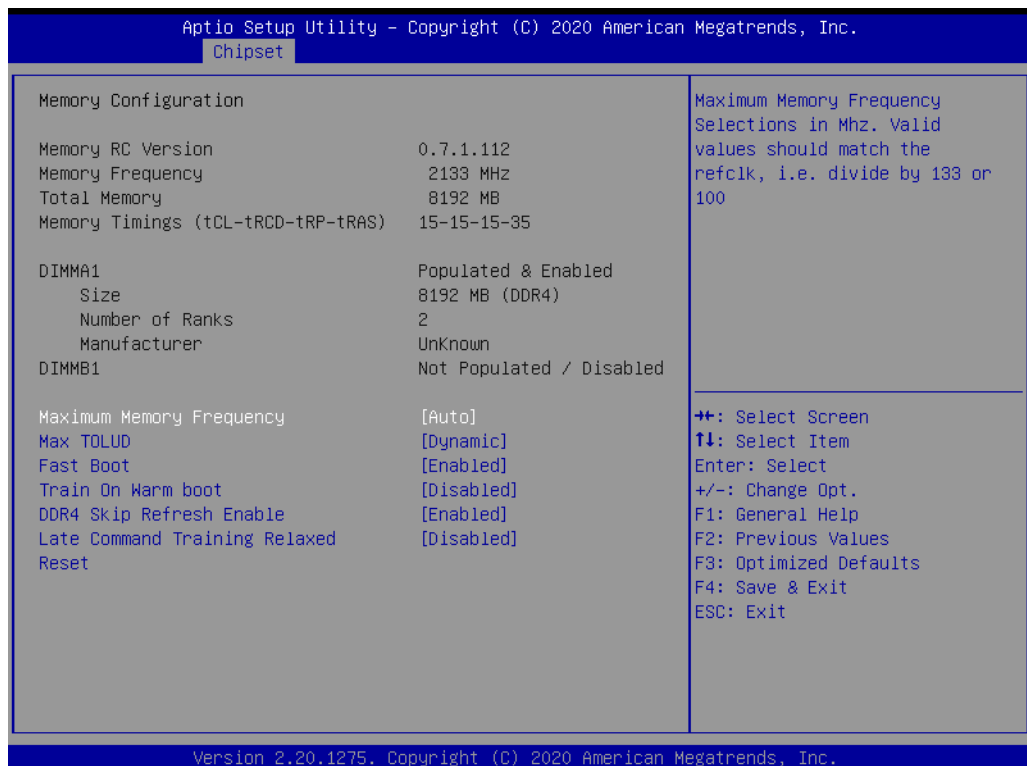

- **Memory Configuration**  
This item allows users to configure memory configuration detail settings.
- **Maximum Memory Frequency**  
Maximum Memory Frequency Selections in Mhz.

- **Max TOLUD**  
Maximum Value of TOLUD. Dynamic assignment would adjust TOLUD automatically based on largest MMIO length of installed graphics controller.
- **Fast Boot**  
Enable/Disable fast path thru the MRC.
- **Train On Warm boot**  
Enable/Disable training on warm boot.
- **DDR4 Skip Refresh Enable**  
Enable/Disable of DDR4 Temperature Controlled Refresh on DRAM. Default is Enabled.
- **Late Command Training Relaxed Reset**  
Enable/Disable Relaxed JEDEC Reset during Late Command Training.

### 3.2.3.2 Graphics Configuration



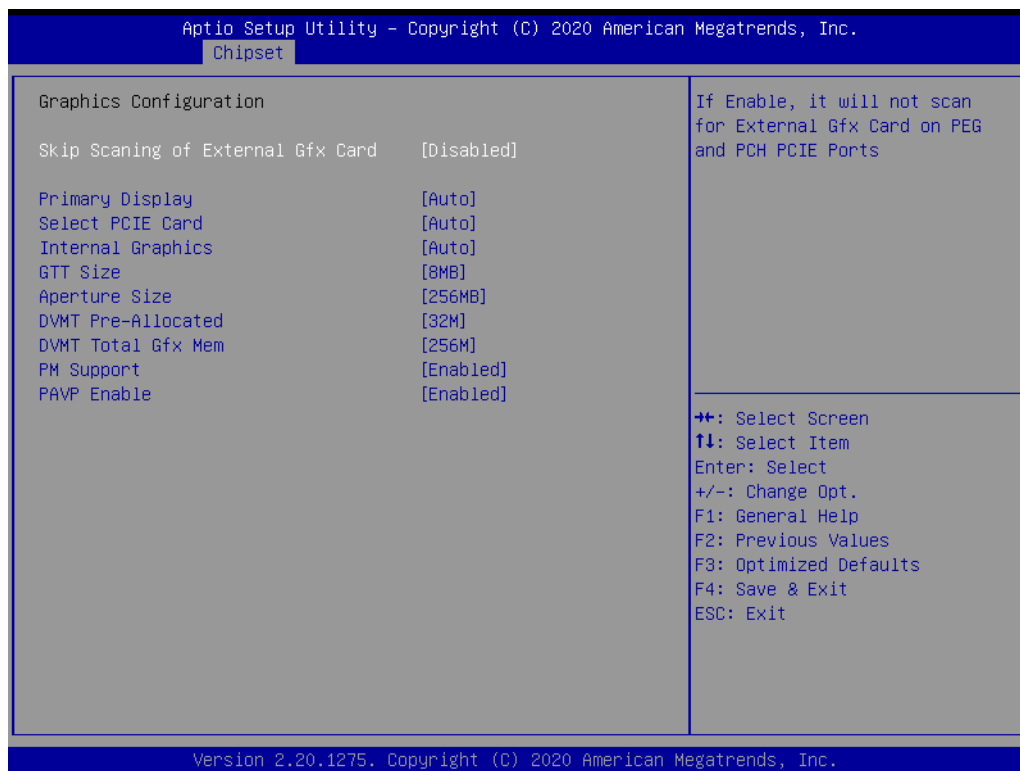

- **Skip Scanning of External Gfx Card**  
If Enabled, it will not scan for External Gfx Card on PEG and PCH PCIE ports.
- **Primary Display**  
Select which of IGFX/PEG/PCI Graphics device should be Primary Display Or select SG for Switchable Gfx.
- **Select PCIE Card**  
Select the card used on the platform.
- **Internal Graphics**  
Keep IGFX enabled based on the setup options.
- **GTT Size**  
Select the GTT Size.
- **Aperture Size**  
Select the Aperture Size.
- **DVMT Pre-Allocated**  
Select DVMT 5.0 Pre-Allocated (Fixed) Graphics Memory size used by the Internal Graphics Device.
- **DVMT Total Gfx Mem**  
Select DVMT 5.0 Total Graphic Memory size used by the Internal Graphics Device.
- **PM Support**  
Enable/Disable PM Support.
- **PAVP Enable**  
Enable/Disable PAVP.

### 3.2.3.3 DMI/OPI Configuration



- **DMI Max Link Speed**  
Set DMI Speed Gen1/Gen2/Gen3.

### 3.2.3.4 PEG Port Configuration

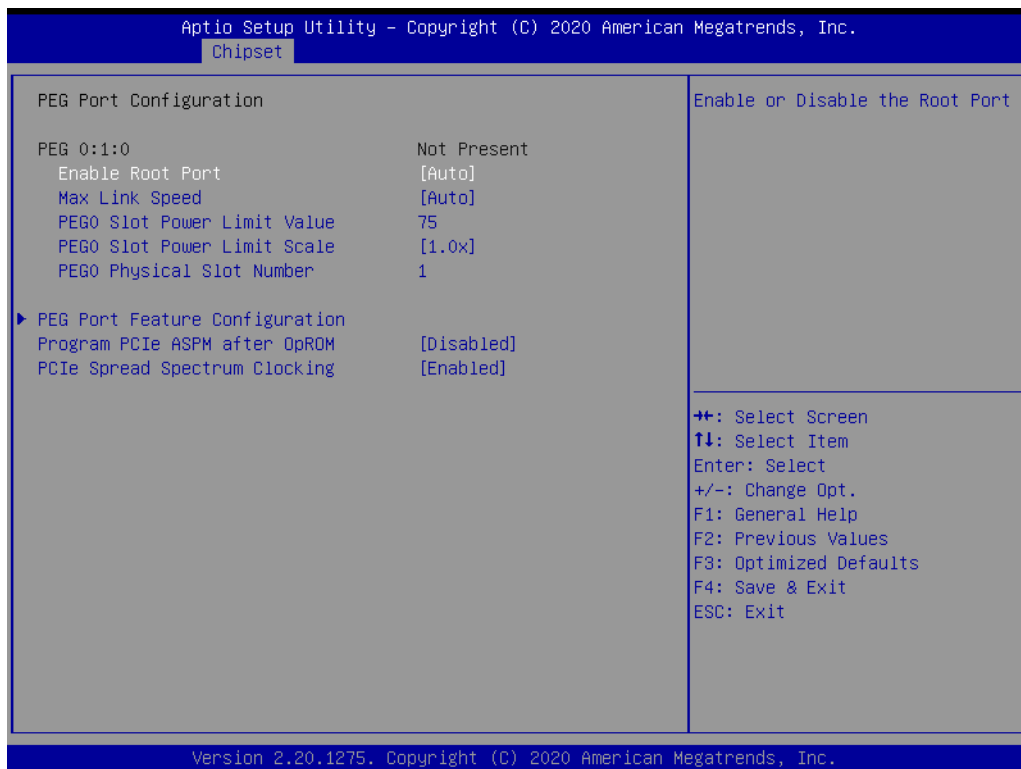



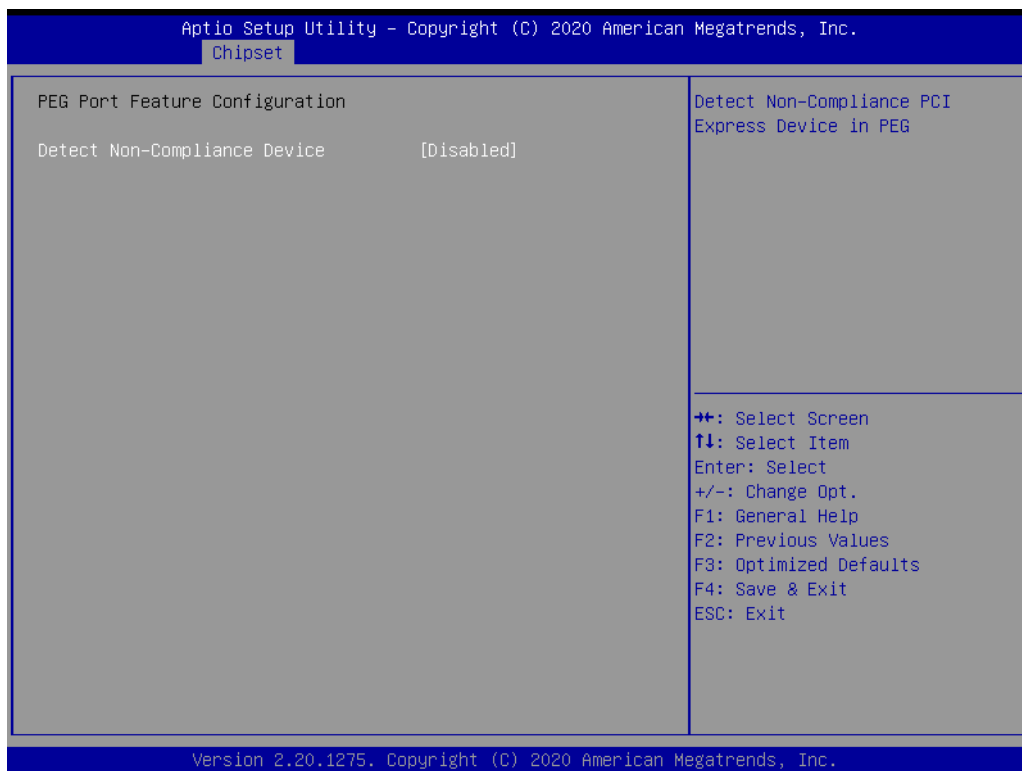

#### PEG Link and Speed Information

- **Enable Root Port**  
Enable or Disable the Root Port.
- **Max Link Speed**  
Configure PEG Max Speed.
- **PEG0 Slot Power Limit Value**  
Sets the upper limit on power supplied by slot. Power limit (in Watts) is calculated by multiplying this value by the Slot Power Limit Scale. Values 0-255.
- **PEG0 Slot Power Limit Scale**  
Select the scale used for the Slot Power Limit Value.
- **PEG0 Physical Slot Number**  
Set the physical slot number attached to this Port. The number has to be globally unique within the chassis. Values 0-8191.
- **Detect Non-Compliance Device**  
Detect Non-Compliance PCI Express Device in PEG.
- **Program PCIe ASPM after OpROM**  
Enabled: PCIe ASPM will be programmed after OpROM.\nDisabled: PCIe ASPM will be programmed before OpROM.
- **PCIe Spread Spectrum Clocking**  
Allows disabling Spread Spectrum Clocking for compliance testing.
- **VT-d**  
VT-d capability.
- **Above 4GB MMIO BIOS assignment**  
Enable/Disable above 4GB MemoryMappedIO BIOS assignment\n\n. This is enabled automatically when Aperture Size is set to 2048MB.
- **Program PCIe ASPM after OpROM**  
Enable PCI Express Active State Power Management settings.
- **PCIe Spread Spectrum Clocking**  
Enable or Disable PCIe Spread Spectrum Clocking.

### 3.2.3.5 PCH-IO Configuration

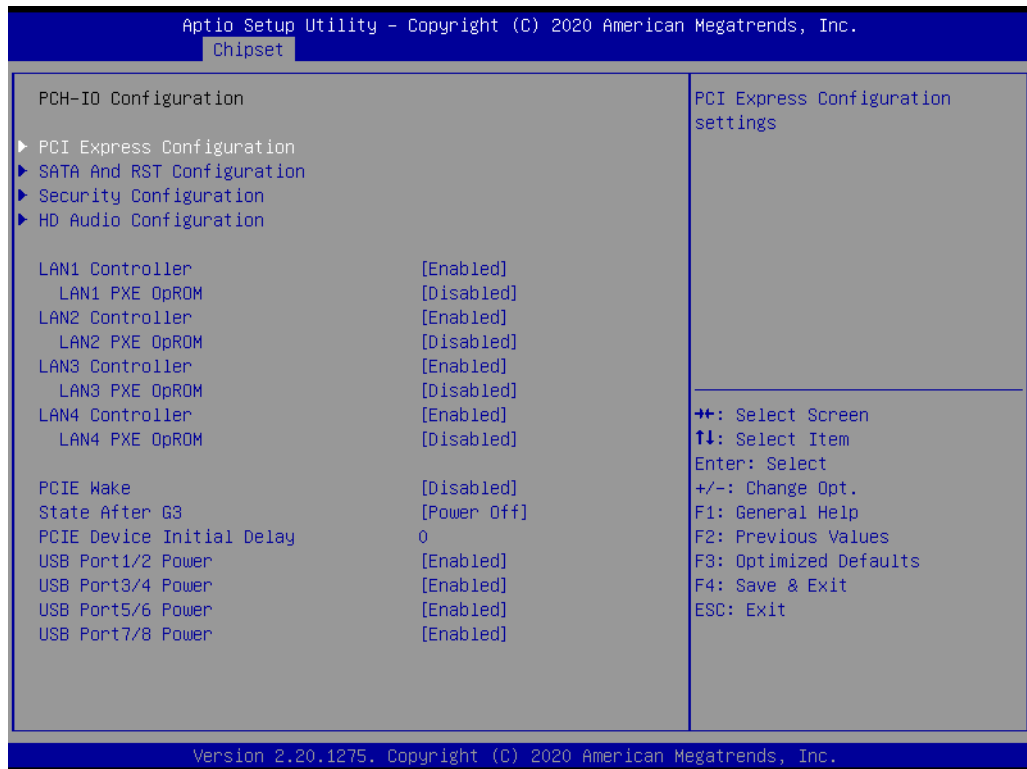

- **LAN Controller**  
"Enable or Disable" LAN controller.
- **LAN Option-ROM**  
"Enable or Disable" LAN boot option for legacy network devices.

- **PCIE Wake**  
“Enable or Disable” PCIE to wake the system from S5. When this item is selected as “Disabled”, Wake on LAN2 function is also disabled.
- **PCIE Wake**  
Enable or Disable PCIE to wake the system from S5.
- **State After G3**  
Specify what state to go to when power is re-applied after a power failure (G3 state).
- **PCIE Device Initial Delay**  
Users can set seconds to delay PCIE device initial time.
- **USB Power**  
Enable or Disable USB standby power.

### 3.2.3.6 PCI Express Configuration

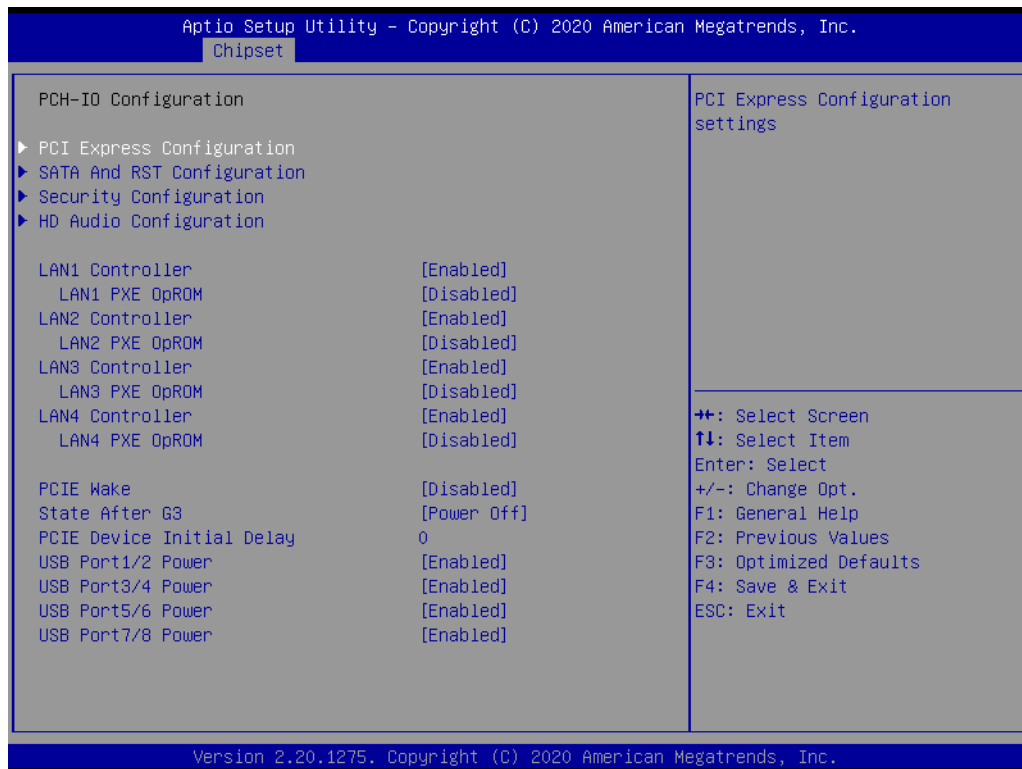

- **PCI Express Clock Gating**  
Enable / Disable PCI Express Clock Gating for each root port.
- **PCIe-USB Glitch W/A**  
Enable / Disable PCIe-USB Glitch W/A.
- **M.2 Setting**  
Set up M.2 related function.

### 3.2.3.7 SATA and RST Configuration

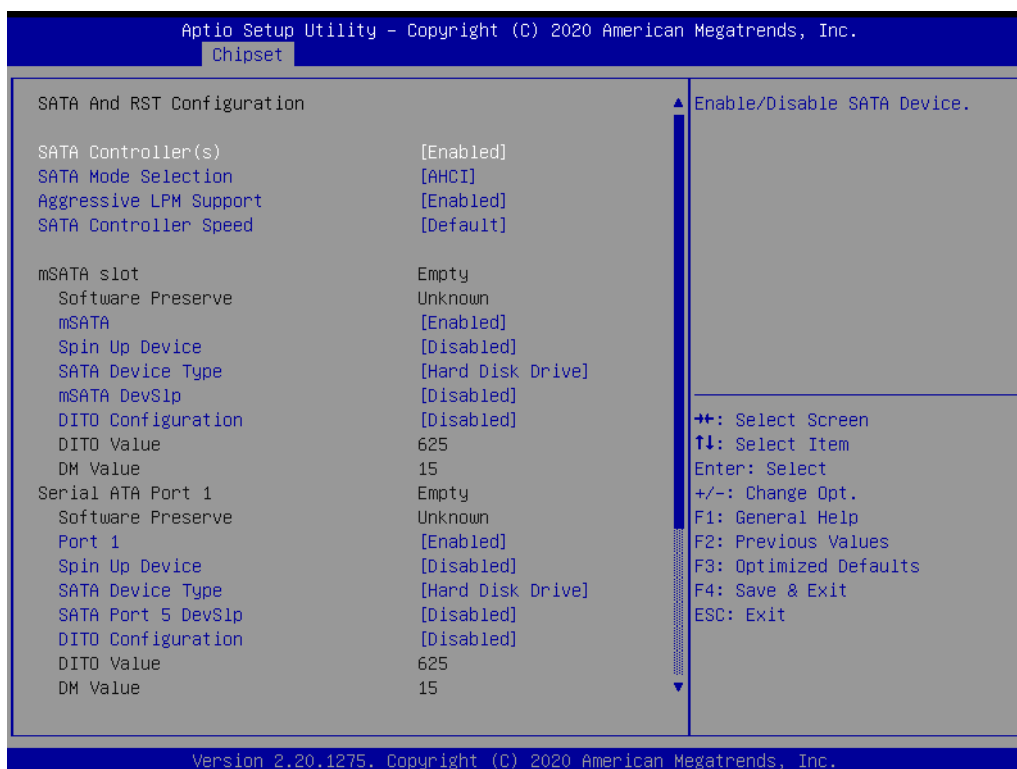
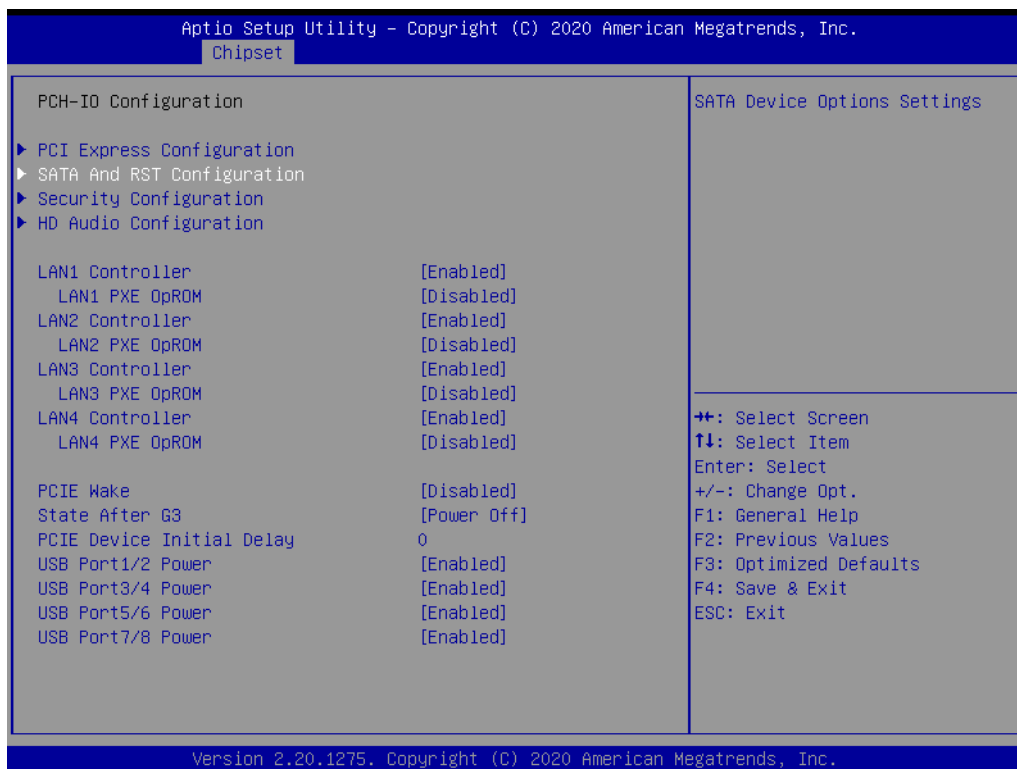

- **SATA Controller**  
Enable / Disable SATA Device.
- **SATA Mode Selection**  
Determine how SATA controllers operate.

- 
- **mSATA Slot**  
Enable / Disable Serial mSATA slot.
  - **Serial ATA Port 1 / Port 2**  
Enable / Disable Serial ATA Port 1 / Port 2.

### 3.2.3.8 Security Configuration

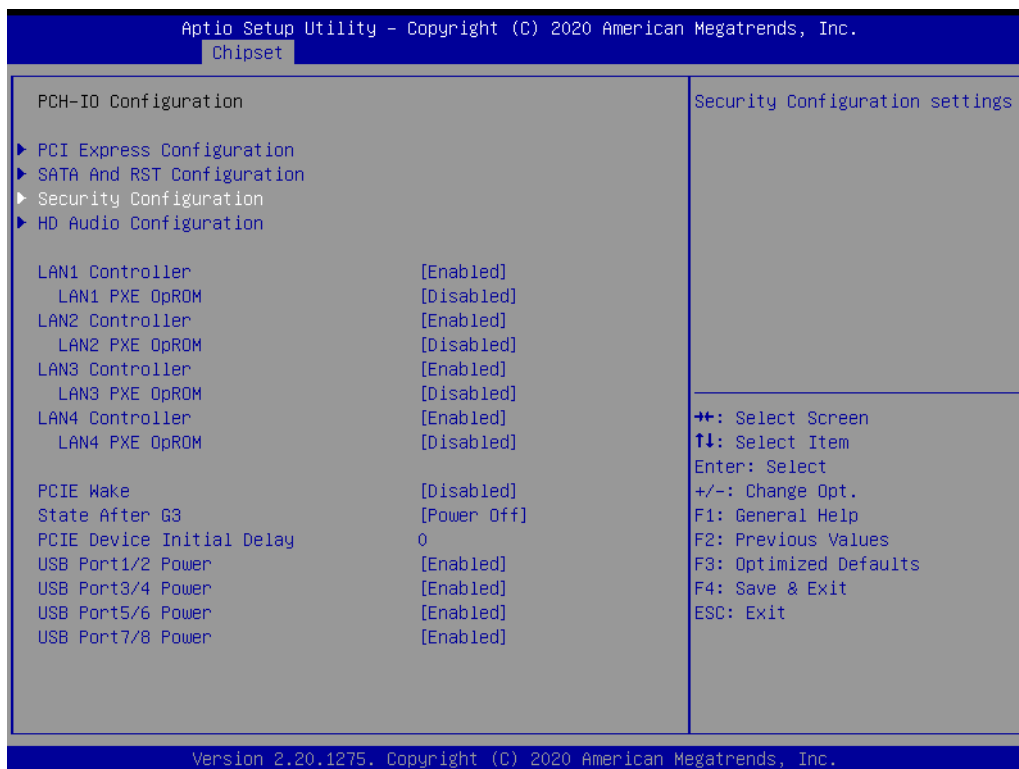

- **RTC Memory Lock**  
Enable will lock bytes 38h-3Fh in the lower/upper 128-byte bank of RTC RAM.
- **BIOS Lock**  
“Enable or Disable” the PCH BIOS Lock Enable feature. Required to be enabled to ensure SMM protection of flash.

### 3.2.3.9 HD Audio Configuration

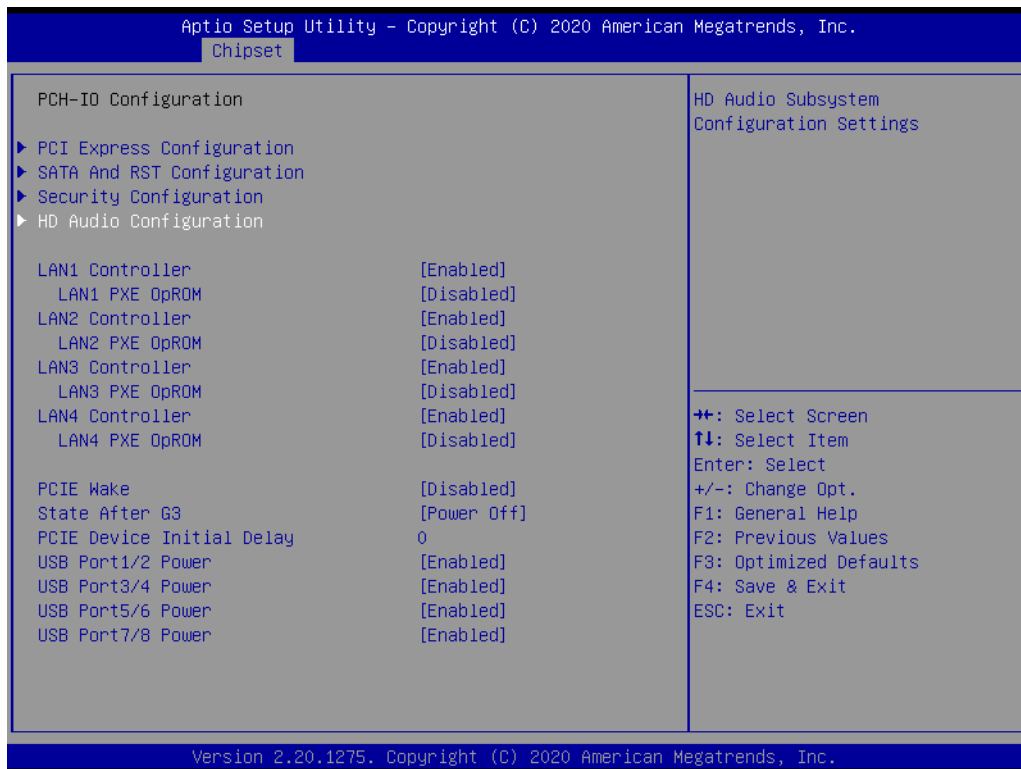

- **HD Audio**  
Control detection of the HD-Audio device. Disable = HDA will be unconditionally disabled. Enable=HDA will be unconditionally enabled.



### 3.2.4 Security

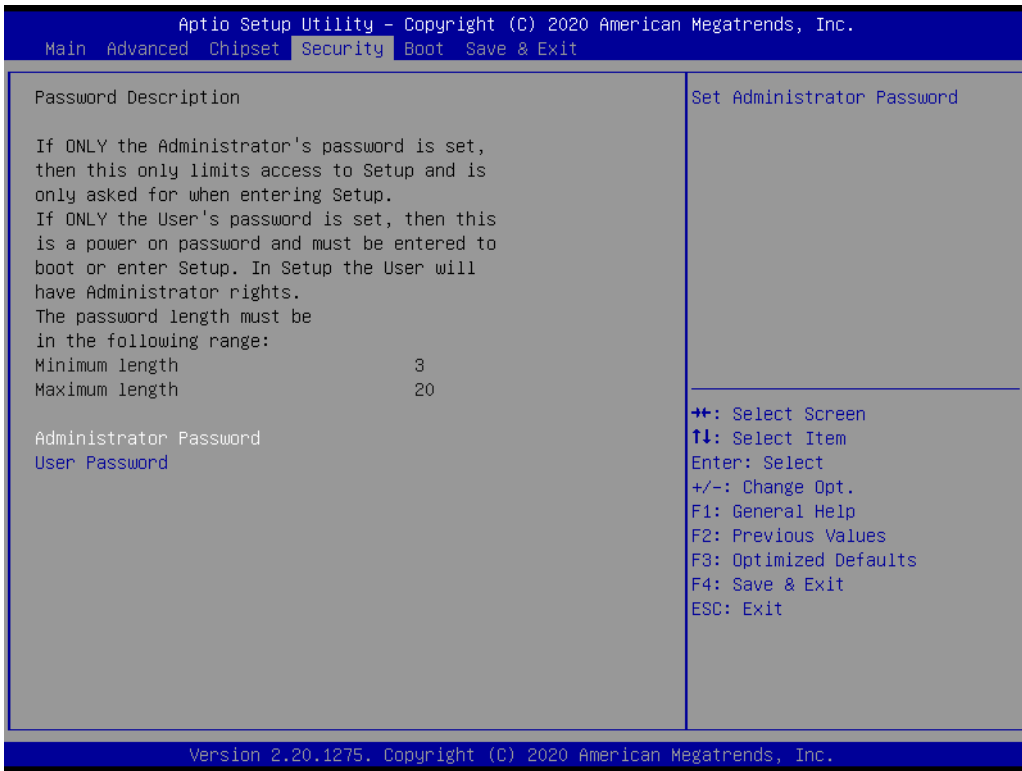

Select Security Setup from the AIMB-786 Setup main BIOS setup menu. All Security Setup options, such as password protection are described in this section. To access the sub menu for the following items, select the item. Note: If only the User's password is set, the user will have Administrator rights. Setting an Administrator password is strongly recommended if you have security concerns.

## 3.2.5 Boot



- **Setup Prompt Timeout**  
Directly key in the number, or use the and <-> keys to adjust the number of seconds to wait for setup activation key.
- **Bootup NumLock State**  
Default state for the NumLock key during power on.
- **Quiet Boot**  
Enable / Disable Quiet Boot option. When enabled, BIOS logo will show in place of POST screen.
- **Boot Option Priorities**  
Set the boot order.

### 3.2.6 Save & Exit

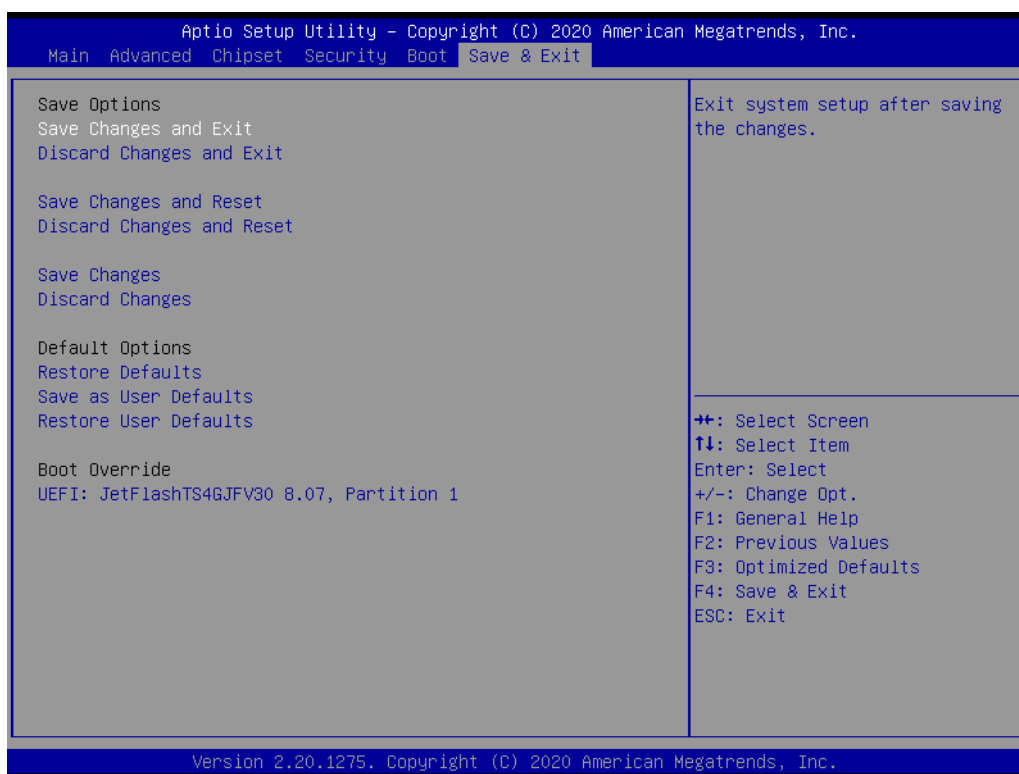

- **Save Changes and Exit**  
 When you complete system configuration, select this option to save your changes, exit BIOS setup, and reboot the computer so the new system configuration parameters can take effect.
  - Select Exit Saving Changes from the Exit menu. The following message will appear: Save Configuration Changes and Exit Now?
  - [Yes] [No].
  - Select Yes or No.
- **Discard Changes and Exit**  
 Select this option to quit Setup without making any permanent changes to the system configuration.
  - Select Exit Discarding Changes from the Exit menu and press . The following message appears:
  - Quit without saving?
  - [Yes] [No].
  - Select Yes to discard changes and exit.
- **Discard Changes**  
 Select Discard Changes from the Exit menu and press <Enter>.



# Appendix **A**

Watchdog Timer  
Sample Code

---

## A.1 EC Watchdog Timer Sample Code

```
EC_Command_Port = 0x29Ah
EC_Data_Port = 0x299h
Write EC HW ram = 0x89
Watch dog event flag = 0x57
Watchdog reset delay time = 0x5E
Reset event = 0x04
Start WDT function = 0x28
=====
.model small
.486p
.stack 256
.data
.code
org 100h
.STARTUp

mov dx, EC_Command_Port
mov al,89h ; Write EC HW ram.
out dx,al

mov dx, EC_Data_Port
mov al, 5Fh ; Watchdog reset delay time low byte (5Eh is high byte) index, Timebase:
100ms
out dx,al

mov dx, EC_Data_Port
mov al, 64h ;Set 10 seconds delay time.
out dx,al

mov dx, EC_Command_Port
mov al,89h ; Write EC HW ram.
out dx,al

mov dx, EC_Data_Port
mov al, 57h ; Watch dog event flag.
out dx,al

mov dx, EC_Data_Port
mov al, 04h ; Reset event.
out dx,al

mov dx, EC_Command_Port
mov al,28h ; start WDT function. (Stop: 0x29, Reset: 0x2A)
out dx,al

.exit
END
```

# Appendix **B**

Fixing the LAN order

## B.1 Problem Statement

When installing Windows 10, the inbox driver will recognize I210 LAN chip and arrange it to the first order. After installing the LAN driver, the first/second/third LAN order will be I210. The fourth is I219.

This doesn't match the LAN sign on the device cabinet.

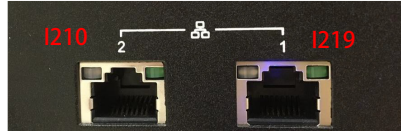

Before users install the LAN driver:

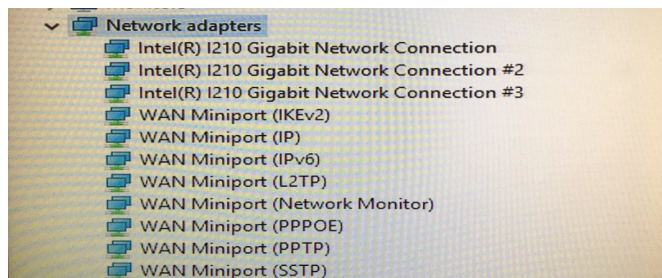

After installing the LAN driver, you will see I219 is set to Ethernet 4.

```
C:\Windows\system32\cmd.exe

Ethernet adapter Ethernet:

    Media State . . . . . : Media disconnected
    Connection-specific DNS Suffix . : 
    Description . . . . . : Intel(R) I210 Gigabit Network Connection
    Physical Address. . . . . : C4-00-AD-54-36-46
    DHCP Enabled. . . . . : Yes
    Autoconfiguration Enabled . . . . : Yes

Ethernet adapter Ethernet 2:

    Media State . . . . . : Media disconnected
    Connection-specific DNS Suffix . : 
    Description . . . . . : Intel(R) I210 Gigabit Network Connection #2
    Physical Address. . . . . : C4-00-AD-54-36-47
    DHCP Enabled. . . . . : Yes
    Autoconfiguration Enabled . . . . : Yes

Ethernet adapter Ethernet 3:

    Media State . . . . . : Media disconnected
    Connection-specific DNS Suffix . : 
    Description . . . . . : Intel(R) I210 Gigabit Network Connection #3
    Physical Address. . . . . : C4-00-AD-54-36-48
    DHCP Enabled. . . . . : Yes
    Autoconfiguration Enabled . . . . : Yes

Ethernet adapter Ethernet 4:

    Media State . . . . . : Media disconnected
    Connection-specific DNS Suffix . : 
    Description . . . . . : Intel(R) Ethernet Connection (7) I219-LM
```

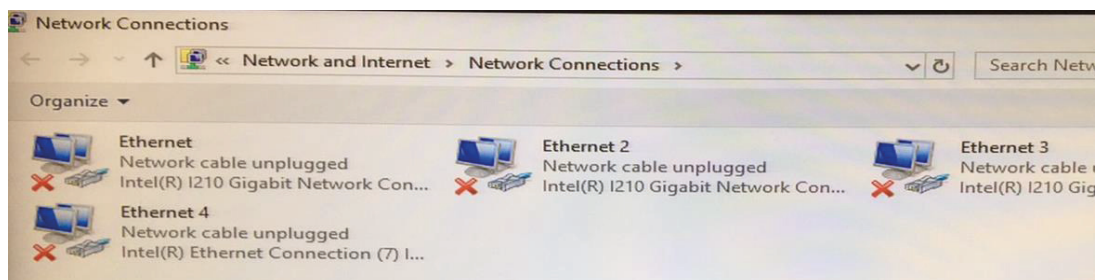



## B.2 Addressing the LAN Order

You have to disable LAN2/3/4 which is I210 LAN chip in the first BIOS screen.

Then install the Win 10 OS. After installing the LAN driver, the order will match the sign on the cabinet.

Disable the LAN 2/3/4 controller in BIOS.(BIOS→Chipset→PCH-IO configuration 2/3/4 controller = Disabled).

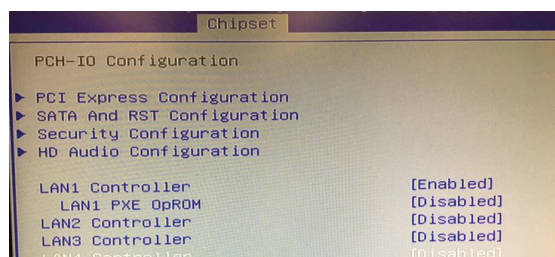

Before installing the LAN driver, you won't see any LAN adapter.

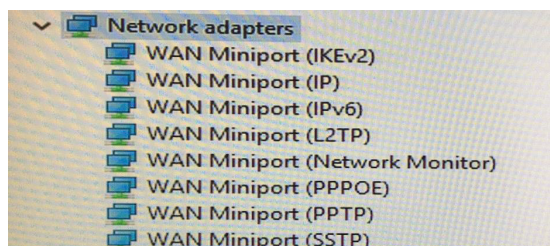

After installing the LAN driver, I219 will be recognized.



Enable LAN2/3/4 controller in BIOS.

Finally, enter the OS to make sure the LAN order matches the sign on the cabinet.

I219 will become the first LAN order.

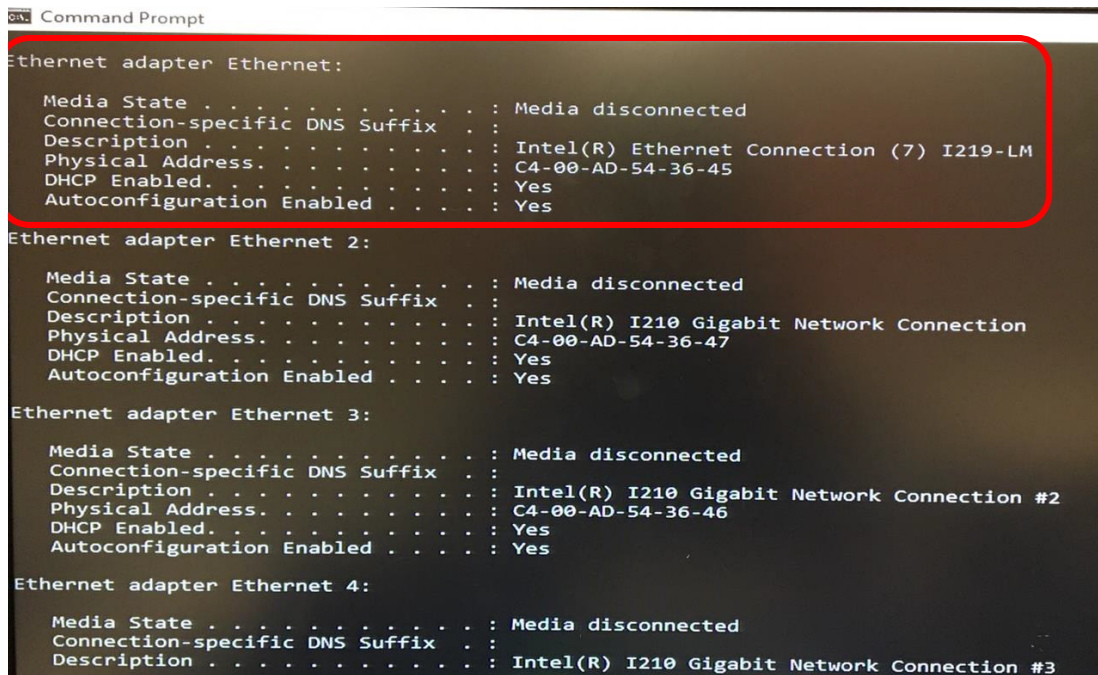
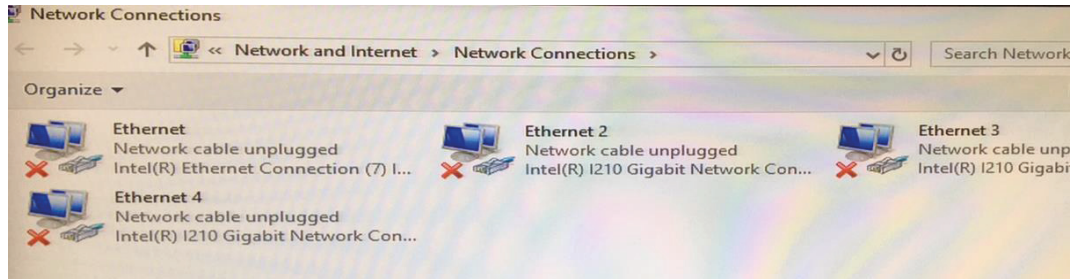



**ADVANTECH**

*Enabling an Intelligent Planet*

**[www.advantech.com](http://www.advantech.com)**

Please verify specifications before quoting. This guide is intended for reference purposes only.

All product specifications are subject to change without notice.

No part of this publication may be reproduced in any form or by any means, electronic, photocopying, recording or otherwise, without prior written permission from the publisher.

All brand and product names are trademarks or registered trademarks of their respective companies.

© Advantech Co., Ltd. 2020