

ASMB-586

**LGA 1151 Intel® Xeon® E and 8th/
9th Gen Core i3/i5/i7 series Micro
ATX Server Board with 4 x PCIe, 6 x
USB 3.1, 8 x SATA3, Quad/Dual
LANs, IPMI**

Copyright

The documentation and the software included with this product are copyrighted 2020 by Advantech Co., Ltd. All rights are reserved. Advantech Co., Ltd. reserves the right to make improvements in the products described in this manual at any time without notice. No part of this manual may be reproduced, copied, translated or transmitted in any form or by any means without the prior written permission of Advantech Co., Ltd. Information provided in this manual is intended to be accurate and reliable. However, Advantech Co., Ltd. assumes no responsibility for its use, nor for any infringements of the rights of third parties, which may result from its use.

Acknowledgements

AMI is a trademark of American Megatrends Inc.

IBM and PC are trademarks of International Business Machines Corporation.

Intel® Xeon, Core i and Pentium® are trademarks of Intel® Corporation.

All other product names or trademarks are properties of their respective owners.

A Message to the Customer

Advantech Customer Services

Each and every Advantech product is built to the most exacting specifications to ensure reliable performance in the harsh and demanding conditions typical of industrial environments. Whether your new Advantech equipment is destined for the laboratory or the factory floor, you can be assured that your product will provide the reliability and ease of operation for which the name Advantech has come to be known. Your satisfaction is our primary concern. Here is a guide to Advantech's customer services. To ensure you get the full benefit of our services, please follow the instructions below carefully.

Technical Support

We want you to get the maximum performance from your products. So if you run into technical difficulties, we are here to help. For the most frequently asked questions, you can easily find answers in your product documentation. These answers are normally a lot more detailed than the ones we can give over the phone.

So please consult this manual first. If you still cannot find the answer, gather all the information or questions that apply to your problem, and with the product close at hand, call your dealer. Our dealers are well trained and ready to give you the support you need to get the most from your Advantech products. In fact, most problems reported are minor and are easily solved over the phone.

In addition, free technical support is available from Advantech engineers every business day. We are always ready to give advice on application requirements or specific information on the installation and operation of any of our products.

Declaration of Conformity

FCC

This device complies with the requirements in part 15 of the FCC rules:

Operation is subject to the following two conditions:

- This device may not cause harmful interference
- This device must accept any interference received, including interference that may cause undesired operation.

This equipment has been tested and found to comply with the limits for a Class B digital device, pursuant to Part 15 of the FCC Rules. These limits are designed to provide reasonable protection against harmful interference when the equipment is operated in a commercial environment. This equipment generates, uses, and can radiate radio frequency energy and, if not installed and used in accordance with the instruction manual, may cause harmful interference to radio communications. Operation of this device in a residential area is likely to cause harmful interference in which case the user will be required to correct the interference at his/her own expense. The user is advised that any equipment changes or modifications not expressly approved by the party responsible for compliance would void the compliance to FCC regulations and therefore, the user's authority to operate the equipment.

Caution! *There is a danger of a new battery exploding if it is incorrectly installed. Do not attempt to recharge, force open, or heat the battery. Replace the battery only with the same or equivalent type recommended by the manufacturer. Discard used batteries according to the manufacturer's instructions.*



Ordering Information

Part Number	Chipset	Memory	LAN	Display	IPMI
ASMB-586G4-00A1	C246	DDR4 288-pin ECC/Non-ECC unbuffered DIMM	4	DVI, HDMI, VGA	Optional
ASMB-586G2-00A1	C246	DDR4 288-pin ECC/Non-ECC unbuffered DIMM	2	DVI, HDMI, VGA	Optional

Product Warranty (2 years)

Advantech warrants to you, the original purchaser, that each of its products will be free from defects in materials and workmanship for two years from the date of purchase.

This warranty does not apply to any products which have been repaired or altered by persons other than repair personnel authorized by Advantech, or which have been subject to misuse, abuse, accident or improper installation. Advantech assumes no liability under the terms of this warranty as a consequence of such events.

Because of Advantech's high quality-control standards and rigorous testing, most of our customers never need to use our repair service. If an Advantech product is defective, it will be repaired or replaced at no charge during the warranty period. For out-of-warranty repairs, you will be billed according to the cost of replacement materials, service time and freight. Please consult your dealer for more details.

If you think you have a defective product, follow these steps:

1. Collect all the information about the problem encountered. (For example, CPU speed, Advantech products used, other hardware and software used, etc.) Note anything abnormal and list any onscreen messages you get when the problem occurs.
2. Call your dealer and describe the problem. Please have your manual, product, and any helpful information readily available.
3. If your product is diagnosed as defective, obtain an RMA (return merchandise authorization) number from your dealer. This allows us to process your return more quickly.
4. Carefully pack the defective product, a fully-completed Repair and Replacement Order Card and a photocopy proof of purchase date (such as your sales receipt) in a shippable container. A product returned without proof of the purchase date is not eligible for warranty service.
5. Write the RMA number visibly on the outside of the package and ship it prepaid to your dealer.

Initial Inspection

Before you begin installing your motherboard, please make sure that the following materials have been shipped:

- 1 Startup manual
- 2 Serial ATA HDD data cables
- 2 Serial ATA HDD power cables
- 1 COM cable for I/O port bracket
- 1 I/O port bracket
- 1 Warranty card

If any of these items are missing or damaged, contact your distributor or sales representative immediately. We have carefully inspected the ASMB-586 mechanically and electrically before shipment. It should be free of marks and scratches and in perfect working order upon receipt. As you unpack the ASMB-586, check it for signs of shipping damage. (For example, damaged box, scratches, dents, etc.) If it is damaged or it fails to meet the specifications, notify our service department or your local sales representative immediately. Also notify the carrier. Retain the shipping carton and packing material for inspection by the carrier. After inspection, we will make arrangements to repair or replace the unit.

Contents

Chapter 1 Hardware Configuration1

1.1	Introduction	2
1.2	Features	2
1.3	Specifications	3
1.3.1	CPU	3
1.3.2	PCH	3
1.3.3	Memory	3
1.3.4	Input/Output	3
1.3.5	Graphics.....	4
1.3.6	Ethernet LAN	4
1.3.7	Industrial Features	4
1.3.8	Mechanical and Environmental Specifications.....	4
1.4	Jumpers and Connectors	5
	Table 1.1: Jumper list	5
	Table 1.2: Connector list.....	6
1.5	Board Layout: Jumper and Connector Locations.....	7
	Figure 1.1 Jumper and Connector Locations.....	7
	Figure 1.2 I/O connectors	7
1.5.1	Onboard LAN LED Definition	8
	Table 1.3: Onboard LAN LED Definition.....	8
1.5.2	Onboard LED (LED2, LED3, LED4).....	8
	Table 1.4: Onboard LED (LED2, LED3, LED4)	8
1.6	ASMB-586 Block Diagram	9
	Figure 1.3 ASMB-586 Block Diagram.....	9
1.7	Safety Precautions	9
1.8	Jumper Settings	10
1.8.1	How to set jumpers	10
	Table 1.5: CMOS clear (JCMOS1).....	10
	Table 1.6: ME update (JME1).....	11
	Table 1.7: Watchdog timer output (JWDT1).....	11
	Table 1.8: USB power switch (JUSB1/JUSB2).....	12
	Table 1.9: Fan mode selection (CPUFAN_SEL1, SYSFAN_SEL1) 12	
	Table 1.10:ATX/AT mode selector (PSON1).....	13
	Table 1.11:PCIEX16_Slot6 link switch (JPEG2, JPEG1)	13
1.9	System Memory	14

Chapter 2 Connecting Peripherals15

2.1	Introduction	16
2.2	USB Ports (LAN1_USB1_2, LAN2_USB3_4, USB5~13).....	16
2.3	USB Power Switch (JUSB1/JUSB2)	17
2.4	Display Connector (HDMI1_VGA1, DVI1).....	18
2.5	Serial Ports (COM1~2).....	19
2.6	External Keyboard & Mouse (KBMS1).....	20
2.7	CPU Fan Connector (CPUFAN0).....	21
2.8	System FAN Connector (SYSFAN0 ~ SYSFAN3)	22
2.9	Front Panel Connectors (JFP1/2/3)	23
2.9.1	Power LED (JFP3 pins 1, 3)	24
2.9.2	External Speaker (JFP2 pins 1, 4, 7, 10).....	24
2.9.3	HDD LED Connector (JFP1 pins 2 & 5).....	24
2.9.4	SNMP SMBus Connector (JFP2 pins 8 & 11).....	24
2.9.5	ATX Soft Power Switch (JFP1 pins 3 & 6).....	24
2.9.6	Reset Connector (JFP1 pins 9 & 12)	24

2.10	Alarm Board Connector (VOLT1).....	25
2.11	Case Open Connector (JCASE1).....	26
2.12	Front Panel LAN Indicator Connector (LANLED1).....	27
2.13	Serial ATA Interface (SATA0~7).....	28
2.14	PCIe x16 Expansion Slot (PCIEX16_SLOT6).....	29
2.15	PCIe x4/x1 Expansion Slot (PCIEX4_SLOT4/7, PCIEX1_SLOT5).....	31
2.16	Auxiliary Power Connector (ATX12V1).....	32
2.17	SPI Flash Connector (SPI_CN1).....	33
2.18	Low Pin Count Connector (LPC1).....	34
2.19	PMBUS Connector (PMBUS1).....	35

Chapter 3 BIOS Operation 37

3.1	Introduction.....	38
	Figure 3.1 Main setup screen.....	38
3.2	Entering BIOS Setup.....	39
3.2.1	Main Menu.....	39
	Figure 3.2 Main setup screen.....	39
3.2.2	System Time / System Date.....	39
3.3	Advanced BIOS Features Setup.....	40
	Figure 3.3 Advanced BIOS features setup screen.....	40
3.3.1	Platform Misc Configuration.....	41
	Figure 3.4 Platform misc configuration screen.....	41
3.3.2	CPU Configuration.....	42
	Figure 3.5 CPU configuration screen.....	42
3.3.3	Power & Performance.....	46
	Figure 3.6 CPU - power management control screen.....	46
3.3.4	PCH-FW Configuration.....	48
	Figure 3.7 PCH-FW configuration screen.....	48
3.3.5	Trusted Computing.....	55
	Figure 3.8 TPM settings screen.....	55
3.3.6	ACPI Settings.....	56
	Figure 3.9 ACPI settings screen.....	56
3.3.7	SMART Settings.....	57
	Figure 3.10 SMART settings screen.....	57
3.3.8	Super IO Configuration.....	58
	Figure 3.11 Super IO configuration screen.....	58
3.3.9	NCT6776 HW Monitor.....	60
	Figure 3.12 PC health status screen.....	60
3.3.10	S5 RTC Wake Settings.....	63
3.3.11	Serial Port Console Redirection.....	64
	Figure 3.13 Serial port console redirection screen.....	64
3.3.12	Intel TXT Information.....	67
	Figure 3.14 Intel TXT information screen.....	67
3.3.13	PCA-COM232/COM485 Super IO Configuration.....	68
	Figure 3.15 Optional PCA-COM configuration screen.....	68
3.3.14	USB Configuration.....	70
	Figure 3.16 USB configuration screen.....	70
3.3.15	CSM Configuration.....	73
	Figure 3.17 CSM configuration screen.....	73
3.3.16	UEFI Network Stack Configuration.....	79
	Figure 3.18 UEFI network stack configuration screen.....	79
3.4	Chipset.....	80
	Figure 3.19 Chipset screen.....	80
3.4.1	System Agent (SA) Configuration.....	81
	Figure 3.20 System agent (SA) configuration screen.....	81
3.4.2	PCH-IO Configuration.....	87
	Figure 3.21 PCH-IO configuration screen.....	87
	Figure 3.22 PCI Express configuration screen.....	89

	Figure 3.23SATA and RST configuration screen.....	91
	Figure 3.24USB configuration screen.....	92
	Figure 3.25Security configuration screen.....	93
	Figure 3.26HD Audio configuration screen.....	94
3.5	Security.....	95
	Figure 3.27Security screen.....	95
3.6	Boot.....	96
	Figure 3.28Boot screen.....	96
3.7	Save & Exit.....	97
	Figure 3.29Save & Exit screen.....	97
3.8	Server Mgmt.....	98
	Figure 3.30Server Mgmt screen.....	98
3.8.1	System Event Log.....	100
3.8.2	BMC Self Test Log.....	102
3.8.3	BMC Network Configuration.....	103

Chapter 4 Driver Installation105

4.1	Before You Begin.....	106
4.2	Introduction.....	106
4.2.1	Chipset.....	106
4.2.2	Graphics.....	106
4.2.3	LAN.....	107
4.2.4	HD Audio.....	107
4.2.5	Intel ME.....	107
4.2.6	SATA RAID.....	107

Appendix A Programming the Watchdog Timer109

A.1	Watchdog Timer Overview.....	110
A.2	Programming the Watchdog Timer.....	110
	Table A.1: Watchdog timer registers.....	112
A.2.1	Example Programs.....	112

Appendix B I/O Pin Assignments.....117

B.1	USB2.0 Header (USB7~12).....	118
	Table B.1: USB2.0 Header (USB7~12).....	118
B.2	USB3.1 Header (USB5_6).....	118
	Table B.2: USB 3.1 Header (USB5_6).....	118
B.3	VGA Connector (VGA1).....	119
	Table B.3: VGA Connector (VGA1).....	119
B.4	RS-232 Interface (COM1~2).....	119
	Table B.4: RS-232 Interface (COM1~2).....	119
B.5	External Keyboard and Mouse Connector (KBMS1).....	120
	Table B.5: External Keyboard and Mouse Connector (KBMS1)....	120
B.6	System Fan Power Connector (SYSFAN0~3).....	120
	Table B.6: Fan Power Connector (SYSFAN0~3).....	120
B.7	Power LED and Keyboard Lock (JFP3).....	120
	Table B.7: Power LED and Keyboard Lock (JFP3).....	120
B.8	External Speaker Connector (JFP2).....	121
	Table B.8: External Speaker Connector (JFP2).....	121
B.9	HDD LED Connector (JFP2).....	121
	Table B.9: HDD LED Connector (JFP2).....	121
B.10	SNMP SMBus Connector (JFP2).....	121
	Table B.10:SNMP SMBus Connector (JFP2).....	121
B.11	ATX Soft Power Switch (JFP1).....	122

	Table B.11:ATX Soft Power Switch (JFP1)	122
B.12	Reset Connector (JFP1)	122
	Table B.12:Reset Connector (JFP1).....	122
B.13	Front Panel Audio Connector (FPAUD1)	122
	Table B.13:Front Panel Audio Connector (FPAUD1)	122
B.14	8-pin Alarm Board Connector (VOLT1).....	123
	Table B.14:8-pin Alarm Board Connector (VOLT1)	123
B.15	Case Open Connector (JCASE1)	123
	Table B.15:Case Open Connector (JCASE1).....	123
B.16	Front Panel LAN LED Connector (LAN_LED1)	123
	Table B.16:LAN LED Connector (LANLED1)	123
B.17	SPI Flash Card Pin Connector (SPI_CN1)	124
	Table B.17:SPI Flash Connector (SPI_CN1).....	124
B.18	GPIO Connector (GPIO1)	124
	Table B.18:GPIO Connector (GPIO1)	124
B.19	SMBUS Connector (SMBUS1)	124
	Table B.19:SMBUS Connector (SMBUS1).....	124
B.20	PMBUS Connector (PMBUS1)	124
	Table B.20:PMBUS Connector (PMBUS1).....	125
B.21	System I/O Ports.....	125
	Table B.21:System I/O Ports	125
B.22	Interrupt Assignments	126
	Table B.22:Interrupt Assignments	126
B.23	1st MB Memory Map	126
	Table B.23:1st MB Memory Map	126

Chapter 1

Hardware
Configuration

1.1 Introduction

ASMB-586 motherboard is designed with the most advanced Intel® C246 PCH for industrial server grade applications that require high-performance. The motherboard supports Intel® Xeon® E & 8th/9th Gen Core i3/i5/i7 processor with DDR4 288-pin 2666/2400/2133 MHz ECC/Non-ECC memory for up to 128 GB. ASMB-586 also provides cost-effective Intel HD graphics integrated on processor, and the graphics VRAM is 1 GB maximum shared memory with 2 GB and above system memory installed. There is one PCIe x16 slot (Gen3 x16 link), and two PCIe x4 slots (Gen3 x4 link), and one PCIe x1 slot (Gen3 x1 link) to fulfill multi-PCIe demands from video surveillance and factory automation markets. In addition, ASMB-586 also comes with four Gigabit Ethernet LAN (G4 version) via dedicated PCIe bus, which offers bandwidth up to 500 MB/s eliminating network bottlenecks.

By using the Intel® C246 chipset, the ASMB-586 offers a variety of features such as eight onboard SATA III interfaces (bandwidth = 600 MB/s) with software RAID, six USB 3.1 and seven USB 2.0 ports. These powerful I/O capabilities ensure even more reliable data storage capabilities and high-speed I/O peripheral connectivity.

The ASMB-586 also adopts Advantech's unique, patented Sleep Mode Control Circuit for AT Power Mode. With all these excellent features and outstanding performance, ASMB-586 is the ideal platform for today's industrial applications.

1.2 Features

- **Triple Display:** One VGA, DVI-D, and HDMI port can be used to implement triple display outputs.
- **PCIe architecture:** One PCIe x16 slot (x16 link), two x4 and one x1 slots from Intel C246 PCH.
- **High Performance I/O capability:** Quad or dual Gigabit LAN via PCIe bus, six USB 3.1 (four Gen2 + two Gen1) and seven USB 2.0 including one Type A 2.0 ports, eight SATA III connectors.
- **Standard Micro-ATX form factor with industrial features:** ASMB-586 provides industrial features like longevity, wide temperature range operation, watchdog timer functions, and more.
- **Automatic power on after power failure:** It is often necessary to have an unattended system come back into operation when power resumes after a power failure. Advantech's industrial server board allows users to set the system to power on automatically without hitting power button. Please refer to the detailed "AT" mode settings by jumper in Section 1.8.1.6.
- **Active Management Technology:** is hardware and firmware technology for remote monitoring and management of networked computers. Intel AMT (iAMT) stores hardware and software information in non-volatile memory. Built-in management provides out-of-band management capabilities, allowing remote discovery and KVM to repair systems after OS failures or when a system has crashed. Alert and event logging features detect problems and quickly reduce downtimes, pro-actively blocking incoming threats, containing infected clients before they impact the network, and pro-actively notifying the user when critical software agents are removed. To enable iAMT, please refer to AMT configuration in BIOS.

1.3 Specifications

1.3.1 CPU

- Supports Xeon E and 8th/9th Gen. Core i3, i5 & i7 CPU in an LGA1151 socket.
- Max. TDP support up to 95 W.

Note! For Microsoft Windows OS, only Windows 10 (64-bit), Windows Server 2016 (64-bit) and 2019 (64-bit) are supported on this platform.



1.3.2 PCH

- **System Chipset:** Intel® C246
- **SATA hard disk drive interface:** Eight on-board SATA III connectors support Advanced Host Controller Interface (AHCI) technology, and Intel Rapid Storage Technology Enterprise (RSTe) supports software RAID 1, 0, 10 and 5 with data transmission rates up to 600 MB/s.

1.3.3 Memory

- **RAM:** Up to 128 GB in four 288-pin DIMM sockets. Supports dual-channel DDR4 ECC/Non-ECC 2666/2400/2133 unbuffered DIMM.

Note! 1. Due to the inherent limitations of the PC architecture, the system may not fully detect 128 GB RAM when 128 GB RAM is installed.



2. A 32-bit OS may not fully detect 4 GB of RAM when 4 GB is installed.

1.3.4 Input/Output

- **PCIe slot:** One PCIe x16 expansion slots (Gen3 x16 link) and two PCIe x4 expansion slots (Gen3 x4 link) and one PCIe x1 expansion slot (Gen3 x1 link).
- **Serial port:** Two serial ports onboard headers (one can be used for rear I/O port bracket via COM cable connection), only supports RS-232.
- **PS/2 Keyboard and mouse connector:** To save rear I/O space, ASMB-586 reserves a 6-pin header on board (KBMS1), and via a cable kit to build two 6-pin mini-DIN connectors for easy connection to a PS/2 keyboard and mouse.
- **USB port:** Supports up to six USB 3.1 ports, four Gen2 ports in rear IO with transmission up to 10Gbps and seven USB 2.0 ports onboard with transmission rates up to 480 Mbps.
- **LPC:** One LPC connector supports Advantech TPM LPC modules and COM 232/422/485 modules.
- **GPIO:** ASMB-586 supports 8-bit GPIO from super I/O for general purpose control applications.

Note! ASMB-586 has an onboard KBMS1 connector for external keyboard/mouse usage. Please purchase an optional PS/2 keyboard/mouse cable (P/N:1700019268-11) and its bracket (P/N:1960063434N000) to be installed on the chassis rear slot.



1.3.5 Graphics

- **Graphics processor:** Integrated Intel HD Graphics.
- **Display memory:** 1 GB maximum shared memory with 2 GB and above system memory installed. (BIOS default is 256MB)
- **DVI-D:** Up to 1920 x 1200 resolution @ 60 Hz refresh rate.
- **D-Sub:** Up to 1920 x 1200 resolution @ 60 Hz refresh rate.
- **HDMI:** Supports HDMI 2.0 up to 4096 x 2160 resolution @ 60 Hz refresh rate.

1.3.6 Ethernet LAN

- **Interface:** Supports four 10/100/1000 Mbps Ethernet port (s) via PCIe bus which provides up to 500 MB/s data transmission rates.
- **Controller:** LAN1: Intel I219-LM; LAN2 ~ 4: Intel I210-AT (LAN2 is BMC shared NIC when the optional IPMI-1000 module is installed; LAN3/4 is for G4 SKU only)

1.3.7 Industrial Features

- **Watchdog timer:** can generate a system reset or NC. The watchdog timer is programmable, with each unit equal to one second or minute (255 levels).
- **IPMI:** Supports IPMI 2.0 via optional IPMI-1000 module (P/N: IPMI-1000-00A2E).

1.3.8 Mechanical and Environmental Specifications

- **Operating temperature:** 0 ~ 60° C (32 ~ 140° F, depending on CPU)
- **Storage temperature:** -40 ~ 85° C (-40 ~ 185° F)
- **Humidity:** 5 ~ 95% non-condensing
- **Power supply voltage:** +3.3 V, +5 V, ±12 V, 5 VSB
- **Power consumption:**
Max. load: +3.3 V @ 3.87 A, +5 V @ 4.11 A, +12 V @ 0.63 A, +12 V (8P) @ 6.28 A, +5 Vsb @ 0.09 A
- **Board size:** 244 x 244 mm (9.6" x 9.6")
- **Board weight:** 0.5 kg (1.123 lb)

1.4 Jumpers and Connectors

Connectors on the ASMB-586 motherboard link it to external devices such as hard disk drives and a keyboard. In addition, the board has a number of jumpers that are used to configure your system for your application.

The tables below lists the functions of each of the jumpers and connectors. Later sections in this chapter give instructions on setting jumpers. Chapter 2 gives instructions for connecting external devices to your motherboard.

Table 1.1: Jumper list

Label	Function
CPUFAN_SEL1, SYSFAN_SEL1	FAN PWM (1-2) / DC mode (2-3)
HDMI_I2C1	For RD debugging
JCASE1	Case open
JCMOS1	CMOS clear
JME1	Intel ME disable jumper for ME/BIOS update
JPEG1, JPEG2	PCIEX16_SLOT6 PCIe link switch between x16 or x8x8 or x8x4x4 (for riser card)
JPEG3	Default (1-2) / reserve for debug (2-3)
JTHR_SEL1	To select on board or external thermistor
JUSB1	Rear window USB 3.1 Gen2 port power source switch between +5 VSB and +5 V
JUSB2	On board USB2.0/3.1 Gen1 port power source switch between +5 VSB and +5 V
JWDT1	Watchdog reset
PERSON1	AT(1-2) / ATX(2-3)

Table 1.2: Connector list

Label	Function
ATXPWR1	ATX 24-pin main power connector (for system)
ATX12V1	8-pin power connector (for CPU)
BAT2	For optional battery kit
BMC1	BMC connector to support IPMI-1000 module (P/N: IPMI-1000-00A2E)
COM1*, COM2	Serial port: RS-232
CPUFAN0	CPU FAN connector
DIMMA0,DIMMA1, DIMMB0,DIMMB1	DDR4 288-pin slot
DVI1	DVI-D connector
EX_THR1	For external thermistor cable kit
FPAUD1	Front Panel Audio Header
GPIO1	8-bit GPIO header
HDMI1_VGA1	HDMI + VGA connector
JFP1	Power switch / Reset connector
JFP2	External speaker / HDD LED connector/ SM Bus connector
JFP3	Keyboard lock and power LED
KBMS1	External keyboard and mouse connector (6-pin)
LAN1_USB1_2, LAN2_USB3_4	LAN1 / USB 3.1 Gen2 port 1, 2 stack connector LAN2 / USB 3.1 Gen2 port 3, 4 stack connector
LAN3_4	LAN3 & LAN4 connector
LANLED1	LAN LED extension connector
LPC1	Low pin count connector for Advantech TPM and RS-232/422/485 modules
PCIEX4_SLOT4	PCIe x4 slot (Gen3 x4 link)
PCIEX1_SLOT5	PCIe x1 slot (Gen3 x1 link)
PCIEX16_SLOT6	PCIe x16 slot (Gen3 x16 link)
PCIEX4_SLOT7	PCIe x4 slot (Gen3 x4 link)
PMBUS1	PMBUS connector to communicate with power supply
SATA0~7	SATA III (6Gb/s)
SGPIO1, SGPIO2	Serial general purpose I/O
SMBUS1	SM Bus from PCH
SPDIF_OUT1	SPDIF audio output pin header
SPI_CN1	SPI flash card pin header (for RMA)
SPI4	BIOS SPI ROM
SYS_LED1	System information LED connector (reserved)
SYSFAN0,SYSFAN1, SYSFAN2,SYSFAN3	System FAN connector
USB7_8, USB9_10, USB11_12	USB 2.0 port (header)
USB13	USB 2.0 port (USB Type A)
USB5_6	USB 3.1 Gen1 port (header)
VOLT1	Voltage display

*COM1 in BIOS is directed to the PCB silk screen as COM1 or COM3.

1.5 Board Layout: Jumper and Connector Locations

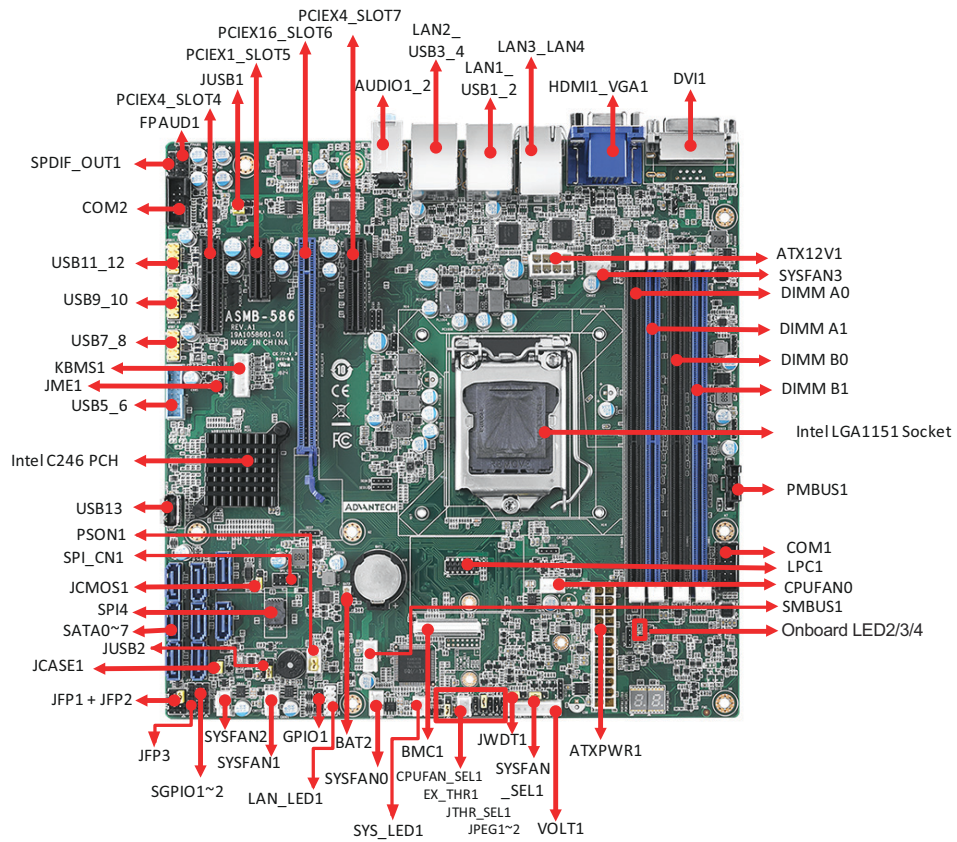

Figure 1.1 Jumper and Connector Locations

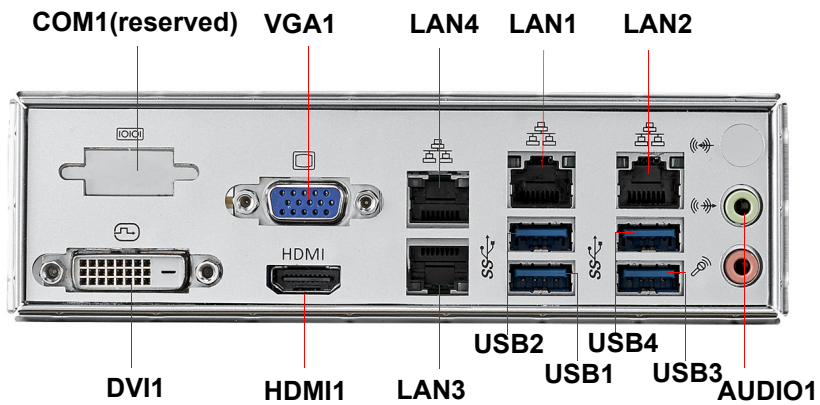

Figure 1.2 I/O connectors

1.5.1 Onboard LAN LED Definition

Table 1.3: Onboard LAN LED Definition

10/100/1000 Mbps LAN Link/Activity LED Scheme

		LAN1 ~ LAN2		LAN3 ~ LAN4	
		Left LED	Right LED	Left LED	Right LED
10 Mbps	Link	Off	Green	Green	Off
	Active	Off	Blinking green	Blinking green	Off
100 Mbps	Link	Amber	Green	Green	Amber
	Active	Amber	Blinking green	Blinking green	Amber
1000 Mbps	Link	Green	Green	Green	Green
	Active	Green	Blinking green	Blinking green	Green
No Link		Off	Off	Off	Off

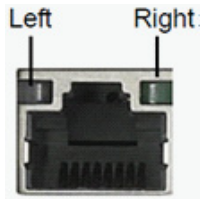

1.5.2 Onboard LED (LED2, LED3, LED4)

The ASMB-586 has onboard power LED for 5V Power, 5V Standby and 3.3V AUX.

Table 1.4: Onboard LED (LED2, LED3, LED4)

LED	Description	LED Definition	
5V_LED2	Power on LED	Off: Power off	On (Green): System is On
5VSB_LED3	Standby LED	Off: No input AC Power	On (Green): System is ON, in sleep mode, or in soft-off mode
3V3DSW_LED4	Deep sleep well LED	Off: No input AC power, deep sleep mode enabled	On (Green): System is ON, in sleep mode, in soft-off mode, or deep sleep mode disable

1.6 ASMB-586 Block Diagram

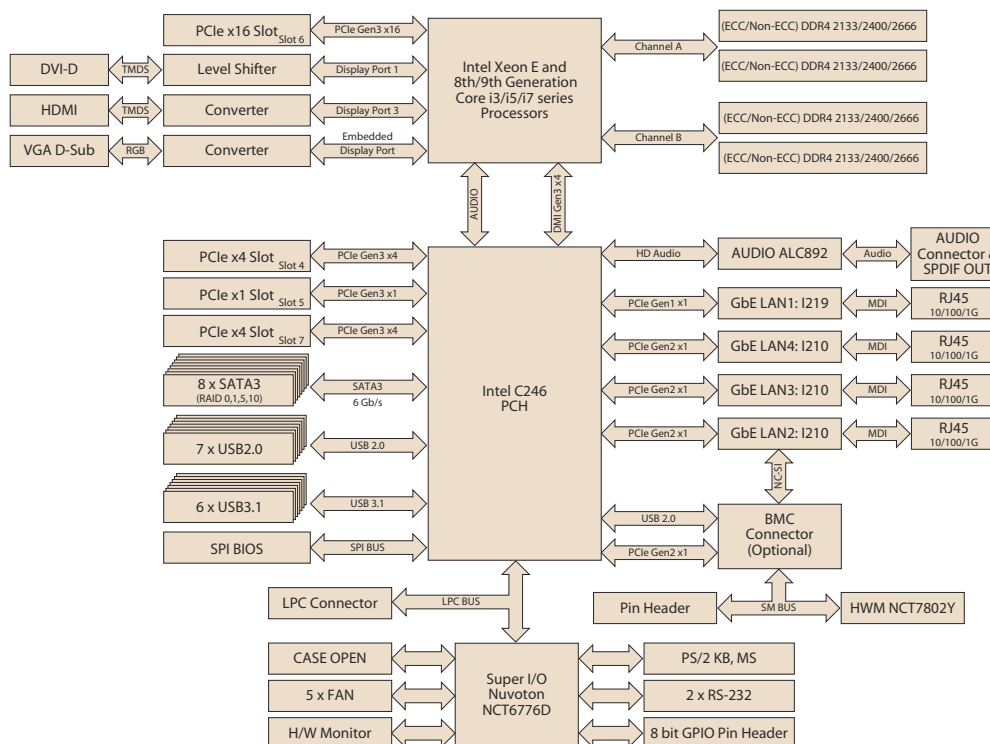

Figure 1.3 ASMB-586 Block Diagram

1.7 Safety Precautions

Warning! Always completely disconnect the power cord from your chassis whenever you work with the hardware. Do not make connections while the power is on. Sensitive electronic components can be damaged by sudden power surges. Only experienced electronics personnel should open the PC chassis.



Caution! Always ground yourself to remove any static charge before touching the motherboard. Modern electronic devices are very sensitive to static electric discharges. As a safety precaution, use a grounding wrist strap at all times. Place all electronic components on a static-dissipative surface or in a static-shielded bag when they are not in the chassis.



Caution! The computer is provided with a battery-powered real-time clock circuit. There is a danger of explosion if battery is incorrectly replaced. Replace only with same or equivalent type recommended by the manufacturer. Discard used batteries according to manufacturer's instructions.



Caution! There is a danger of a new battery exploding if it is incorrectly installed. Do not attempt to recharge, force open, or heat the battery. Replace the battery only with the same or equivalent type recommended by the manufacturer. Discard used batteries according to the manufacturer's instructions.



1.8 Jumper Settings

This section provides instructions on how to configure your motherboard by setting the jumpers. It also includes the motherboard default settings and your options for each jumper.

1.8.1 How to set jumpers

You can configure your motherboard to match the needs of your application by setting the jumpers. A jumper is a metal bridge that closes an electrical circuit. It consists of two metal pins and a small metal clip (often protected by a plastic cover) that slides over the pins to connect them. To “close” (or turn on) a jumper, you connect the pins with the clip. To “open” (or turn off) a jumper, you remove the clip. Sometimes a jumper consists of a set of three pins, labeled 1, 2, and 3. In this case you connect either pins 1 and 2, or 2 and 3. A pair of needle-nose pliers may be useful when setting jumpers.

1.8.1.1 CMOS clear (JCMOS1)

The ASMB-586 motherboard contains a jumper that can erase CMOS data and reset the system BIOS information. Normally this jumper should be set with pins 1-2 closed. If you want to reset the CMOS data, set JCMOS1 to 2-3 closed for just a few seconds, and then move the jumper back to 1-2 closed. This procedure will reset the CMOS to its default setting.

Table 1.5: CMOS clear (JCMOS1)

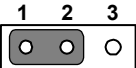
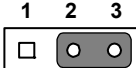
Function	Jumper Setting
* Keep CMOS data	 1-2 closed
Clear CMOS data	 2-3 closed
* Default setting	

1.8.1.2 ME update (JME1)

The ASMB-586 contains a jumper that can update the ME firmware. Normally this jumper should be set with pin 1-2 closed. If you want to update the ME firmware, set JME1 to 2-3 closed to disable ME for the new firmware update.

Table 1.6: ME update (JME1)

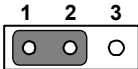
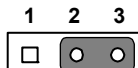
Function	Jumper Setting
*Lock ME update	 1-2 closed
ME update	 2-3 closed
* Default setting	

1.8.1.3 Watchdog timer output (JWDT1)

The ASMB-586 contains a watchdog timer that will reset the CPU. This feature means the ASMB-586 will recover from a software failure or an EMI problem. The JWDT1 jumper settings controls the outcome of what the computer will do in the event the watchdog timer is tripped.

Table 1.7: Watchdog timer output (JWDT1)

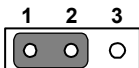
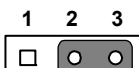
Function	Jumper Setting
*Reset	 1-2 closed
NC	 2-3 closed
* Default setting	

Note! *The interrupt output of the watchdog timer is a low level signal. It will be held low until the watchdog timer is reset.*



1.8.1.4 USB power switch (JUSB1/JUSB2)

The ASMB-586 contains a jumper that can support on board USB ports power source from +5Vsb or +5V. The JUSB1 jumper controls the USB3.1 Gen2 ports of rear. The JUSB2 jumper controls the USB2.0 and 3.1 Gen1 ports of onboard header and connectors. The default setting is 1-2 closed which supports USB stand-by power under S5. When jumper 2-3 is closed, the on board USB port power source will be switched to +5V. If you want to disable USB stand-by power under S5, and under 2-3 closed, it won't support S3 and S4 modes.

Table 1.8: USB power switch (JUSB1/JUSB2)

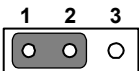
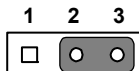
Function	Jumper Setting
*+5Vsb	 1-2 closed
+5V	 2-3 closed
* Default setting	

1.8.1.5 CPU,SYSTEM fan PWM/DC mode selection (CPUFAN_SEL1, SYSFAN_SEL1)

The ASMB-586 contains a jumper that can support PWM or DC mode. Normally this jumper should be set with pin 1-2 closed. If you want to change to DC mode, set CPUFAN_SEL1, SYSFAN_SEL1 to 2-3 closed to disable it.

Table 1.9: Fan mode selection (CPUFAN_SEL1, SYSFAN_SEL1)

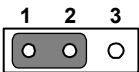
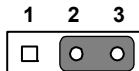
Function	Jumper Setting
*PWM mode	 1-2 closed
DC mode	 2-3 closed
* Default setting	

1.8.1.6 ATX/AT mode selector (PSON1)

The ASMB-586 contains a jumper that can support ATX or AT mode. Normally this jumper should be set with pin 2-3 closed. If you want to change to AT mode, set PSON to 1-2 closed.

Table 1.10: ATX/AT mode selector (PSON1)

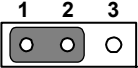
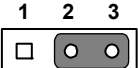
Function	Jumper Setting
AT Mode	 1-2 closed
* ATX Mode	 2-3 closed
* Default setting	

1.8.1.7 PCIe link switch (JPEG1, JPEG2)

The ASMB-586 contains a jumper that can switch one PCIe x16 link on PCIEX16_SLOT6 to two PCIe x8 link or one PCIe x8 + two PCIe x4 link. Default setting with pin 1-2 closed is one x16 on PCIEX16_SLOT6. For jumper settings for riser card support please refer to Section 2.14 PCIe x16 Expansion Slot.

Table 1.11: PCIEX16_Slot6 link switch (JPEG2, JPEG1)

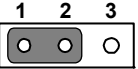
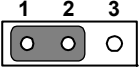
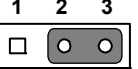
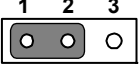
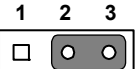
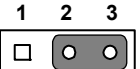
Function	JPEG2	JPEG1
Slot6 PCIe x16*	 1-2 closed	 1-2 closed
Slot6 PCIe x8/x8	 2-3 closed	 1-2 closed
Slot6 PCIe x8/x4/x4	 2-3 closed	 2-3 closed
* Default setting		

1.9 System Memory

ASMB-586 has four 288-pin memory sockets for unbuffered ECC/Non-ECC 2666/2400/2133 MHz memory modules with maximum capacity of 128 GB (Maximum 32 GB for each DIMM).

Note! ASMB-586 does NOT support registered DIMMs (RDIMMs).



Chapter 2

Connecting
Peripherals

2.1 Introduction

You can access most of the connectors from the top of the board as it is being installed in the chassis. If you have a number of cards installed, you may need to partially remove a card to make all the connections.

2.2 USB Ports (LAN1_USB1_2, LAN2_USB3_4, USB5~13)

ASMB-586 provides up to 13 USB ports. USB7~13 are USB 2.0 ports supporting transmission rates up to 480 Mbps, USB1~4 are USB 3.1. Gen2 ports support transmission rates up to 10Gbps, and USB5~6 are USB 3.1 Gen1 ports with transmission rates up to 5Gbps. These ports support Plug & Play and hot swapping for up to 127 external devices and are able to be disabled in BIOS menu.

The ASMB-586 is equipped with two (G2 SKU) or four (G4 SKU) high-performance 1000 Mbps Ethernet LANs. They are supported by all major network operating systems. The RJ-45 jacks on the rear plate provide convenient 1000 Mbps operation. If all USB ports will be used, USB power is recommended to switch to +5V instead of +5VSB.

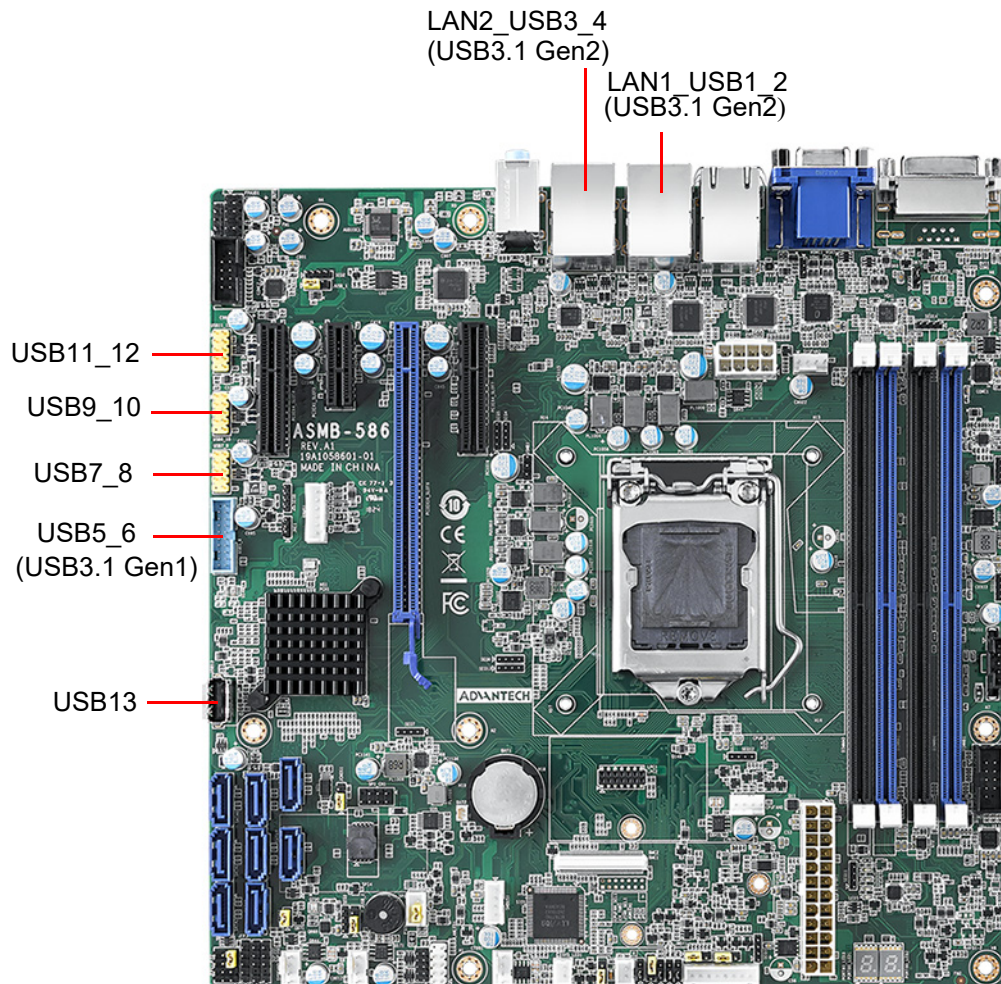

2.3 USB Power Switch (JUSB1/JUSB2)

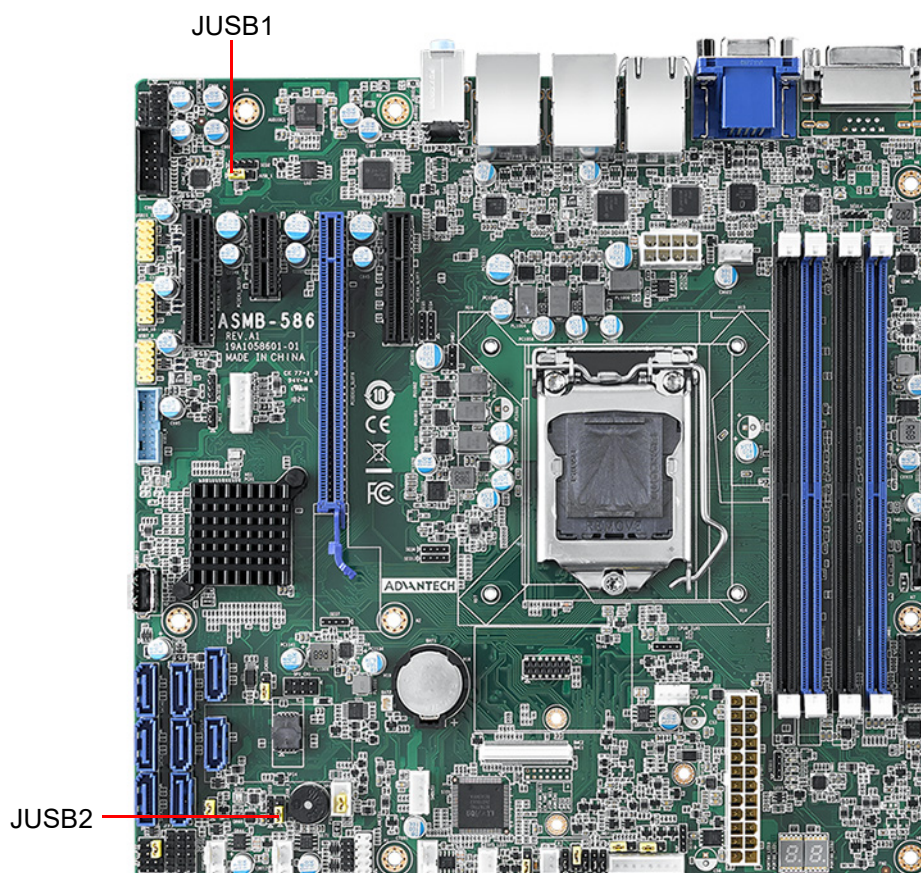

ASMB-586 allows users to set USB power between +5VSB and +5V.

When the jumper is set as +5V, the board doesn't support S3/S4. Refer to Section 1.8.1.4 for details of jumper settings.

Jumper	Function
JUSB1	Rear window USB3.1 Gen2 port power source switch between +5 VSB and +5 V
JUSB2	On board USB2.0/3.1 Gen1 port power source switch between +5 VSB and +5 V

Note! When USB power is switched to +5V, it cannot be connected to a powered KVM.



2.4 Display Connector (HDMI1_VGA1, DVI1)

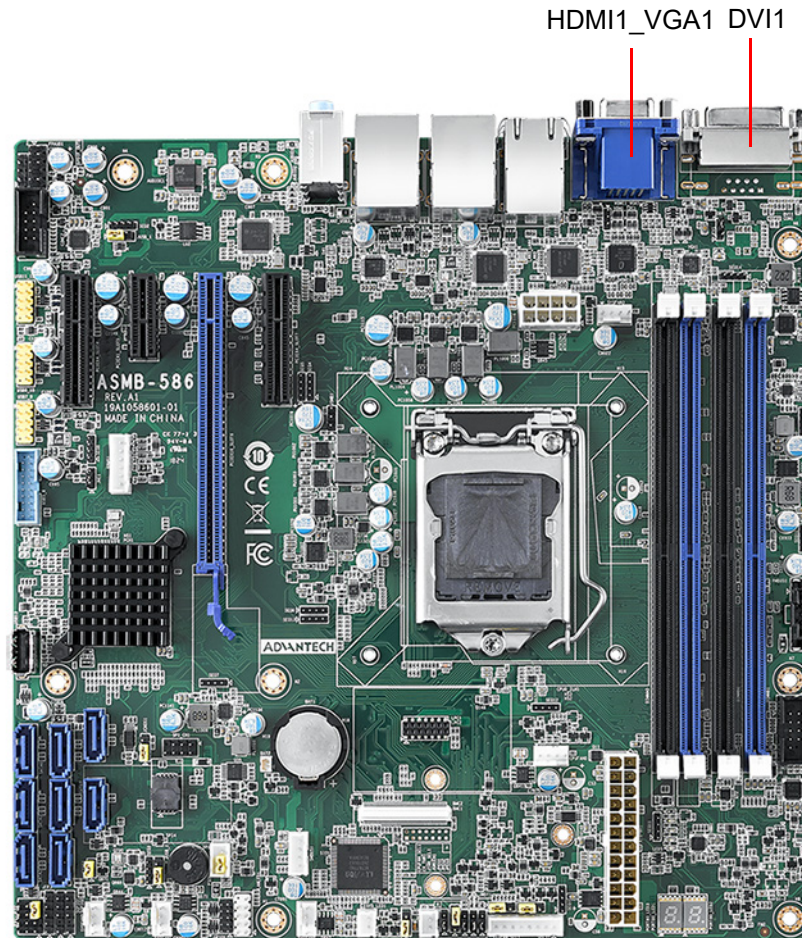

The ASMB-586 is equipped with VGA, DVI-D and HDMI connectors for triple display output. However, results may differ because of OS support limitations.

2.5 Serial Ports (COM1~2)

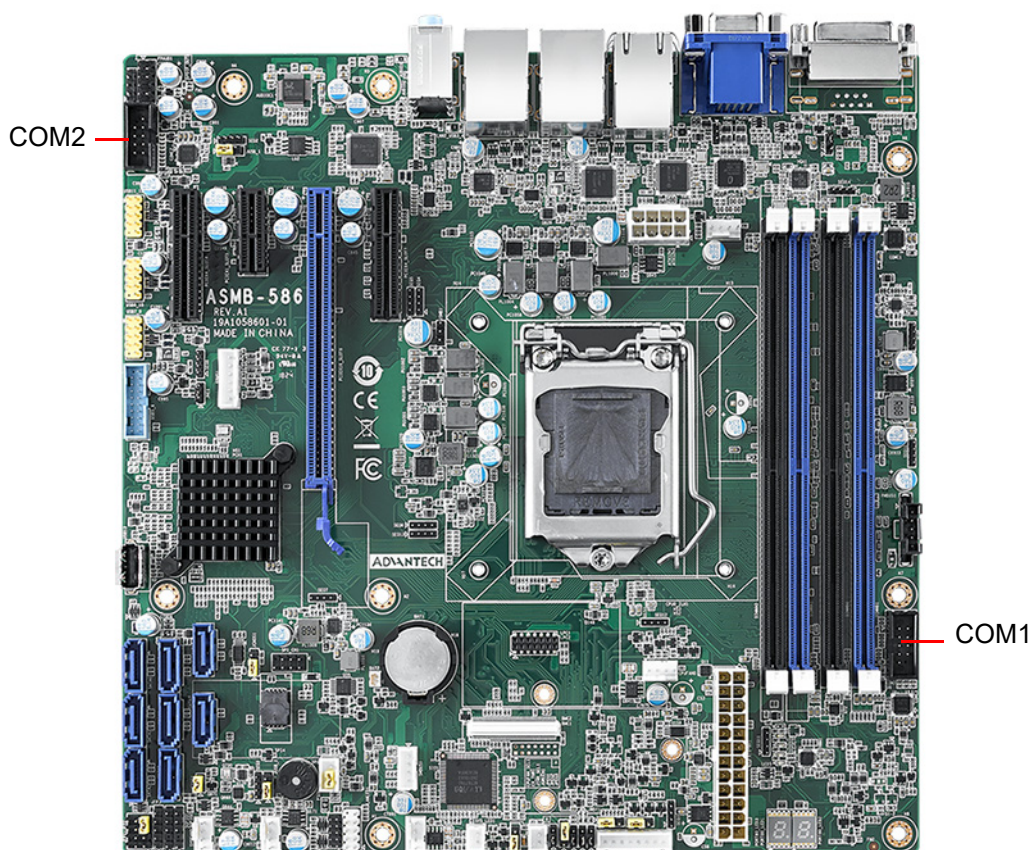

The ASMB-586 offers two serial ports onboard, COM1 and COM2 (one can be connected to rear panel via the dedicated COM cable kit in the accessory box) for the use in a serial mouse, printer or communications network, etc. The IRQ and address ranges for those ports are fixed. However, if you want to disable the port or change these parameters later, you can do this in the system BIOS setup. Different devices implement the RS-232 standards in different ways.

Up to eight COM ports may appear in Windows Devices Managers when all devices are enabled. Besides COM1 and COM2 for RS-232, COM3 is reserved as a virtual COM port for Linux OS users, COM4 is for Intel AMT or IPMI SOL support, COM5~COM8 are additional serial ports for when an optional Advantech COM module for RS-232/422/485 is installed on the LPC1 connector.

2.6 External Keyboard & Mouse (KBMS1)

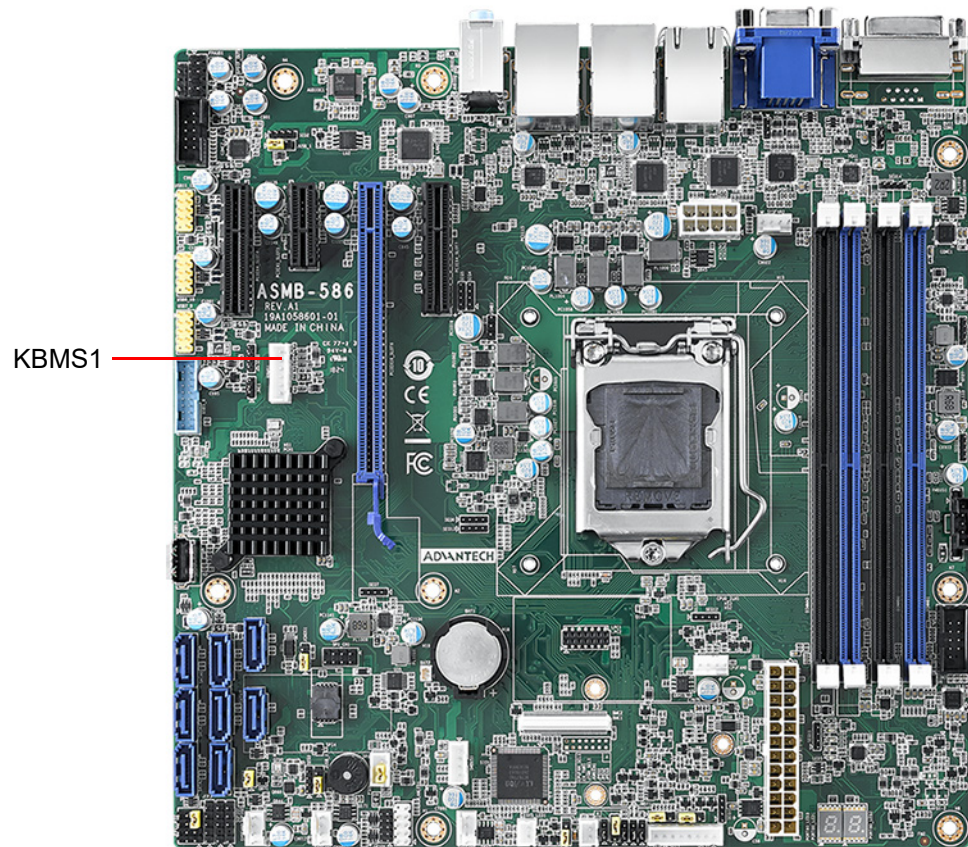

There is an onboard external keyboard and mouse connector on the motherboard. This gives system integrators greater flexibility in designing their systems. A KBMS cable and cable bracket installed in the rear of system are provided as optional. (P/N: 1700019268-11, 1960063434N000)

2.7 CPU Fan Connector (CPUFAN0)

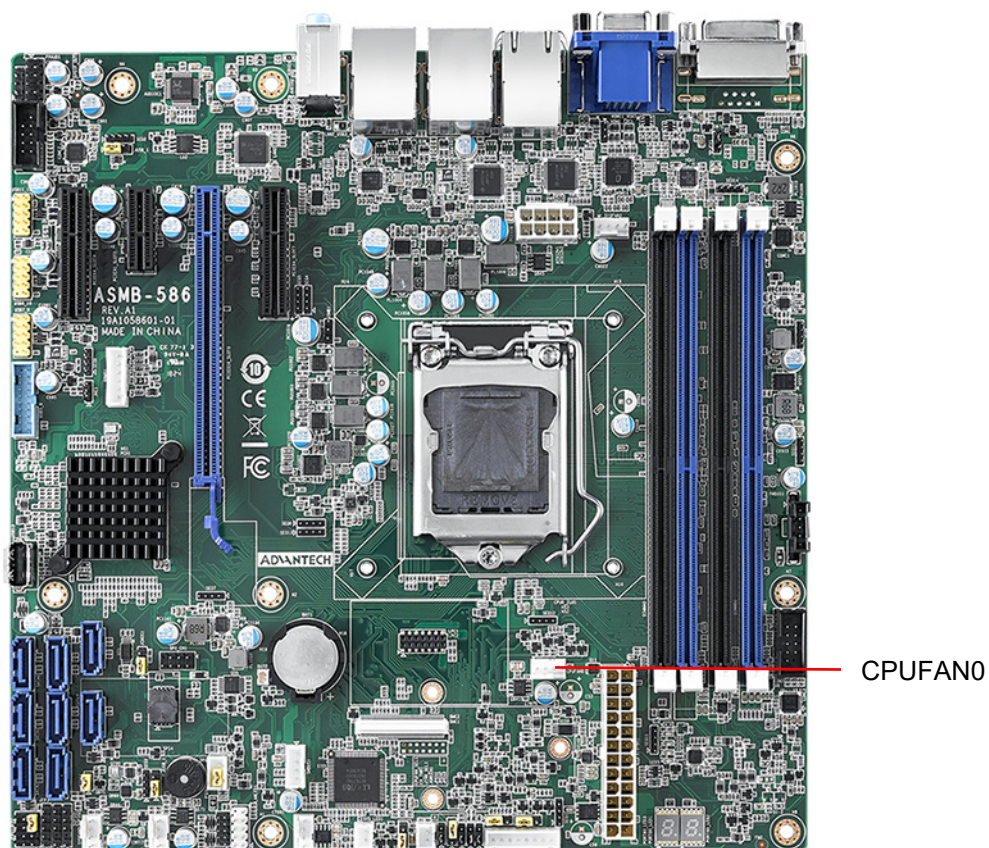

If a fan is used, this connector supports cooling fans that draw up to 2.5A (30W).

2.8 System FAN Connector (SYSFAN0 ~ SYSFAN3)

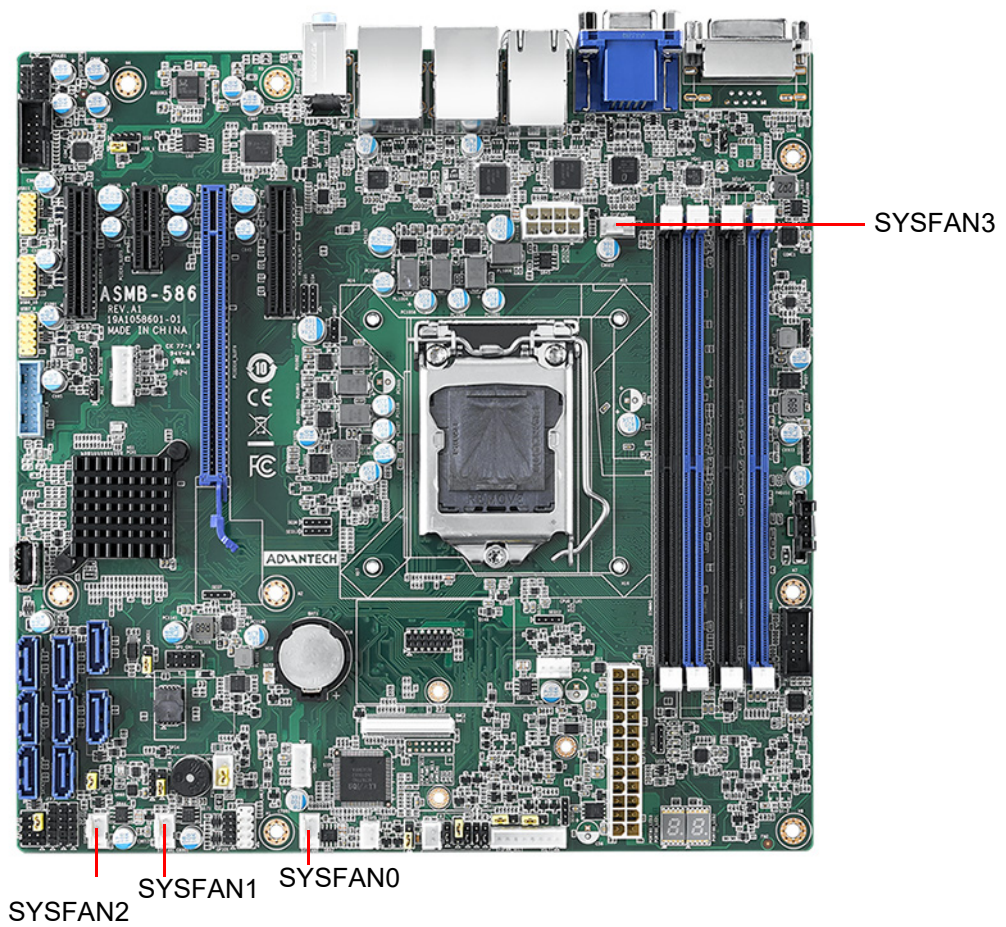

If a fan is used, this connector supports cooling fans that draw up to 2.5A (30W).

2.9 Front Panel Connectors (JFP1/2/3)

There are several external switches and LEDs to monitor and control ASMB-586.

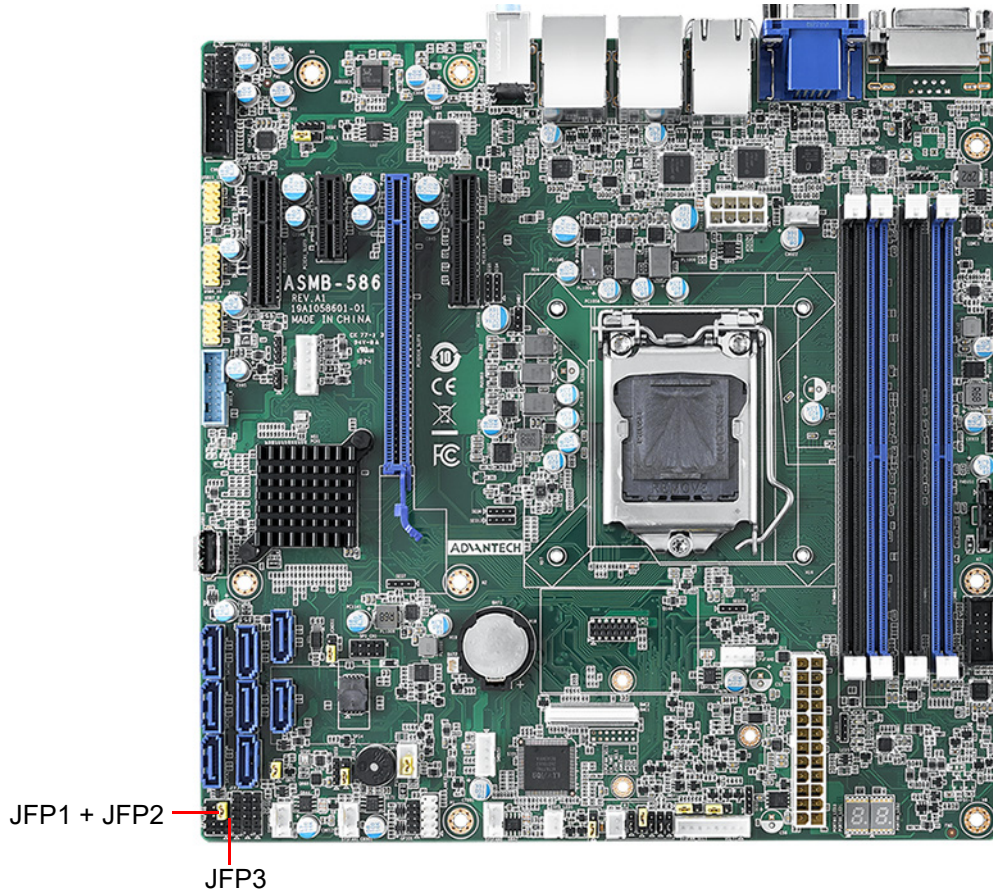

JFP1	3	6	9	12	PWRSW	RESET
&	2(+)	5(-)	8	11		
JFP2	1	4	7	10	SPEAKER	
JFP3	1	2	3	4	PWRLED & KEYLOCK	
	(+)	(-)				

2.9.1 Power LED (JFP3 pins 1, 3)

JFP3 is a 5-pin connector for the power LED. Refer to Appendix B for detailed information on the pin assignments. If an ATX power supply is used, the system's power LED status is as follows.

Power Mode	LED Status
System On	On
System Suspend	Fast Flash (S1, S3) / Slow Flash (S4)
System Off	Off
System Off in deep sleep	Off

2.9.2 External Speaker (JFP2 pins 1, 4, 7, 10)

JFP2 pins 1, 4, 7, 10 connector for an external speaker. The ASMB-586 provides an onboard buzzer as an alternative. To enable the onboard buzzer, set pins 7-10 as closed.

2.9.3 HDD LED Connector (JFP1 pins 2 & 5)

You can connect an LED to connector JFP1 to indicate when the HDD is active.

2.9.4 SNMP SMBus Connector (JFP2 pins 8 & 11)

ASMB-586 supports Advantech Intelligent System Module for providing a platform independent system management. When you're installing a module on ASMB-586, connect it to pins 8 and 11 on JFP2. (Pin 8 is a data pin, pin 11 is a clock pin)

2.9.5 ATX Soft Power Switch (JFP1 pins 3 & 6)

If your computer case is equipped with an ATX power supply, you should connect the power on/off button on your computer case to pins 3 and 6 on JFP1. This connection enables you to turn your computer on and off.

2.9.6 Reset Connector (JFP1 pins 9 & 12)

JFP1 pins 9 & 12 are for a reset button.

2.10 Alarm Board Connector (VOLT1)

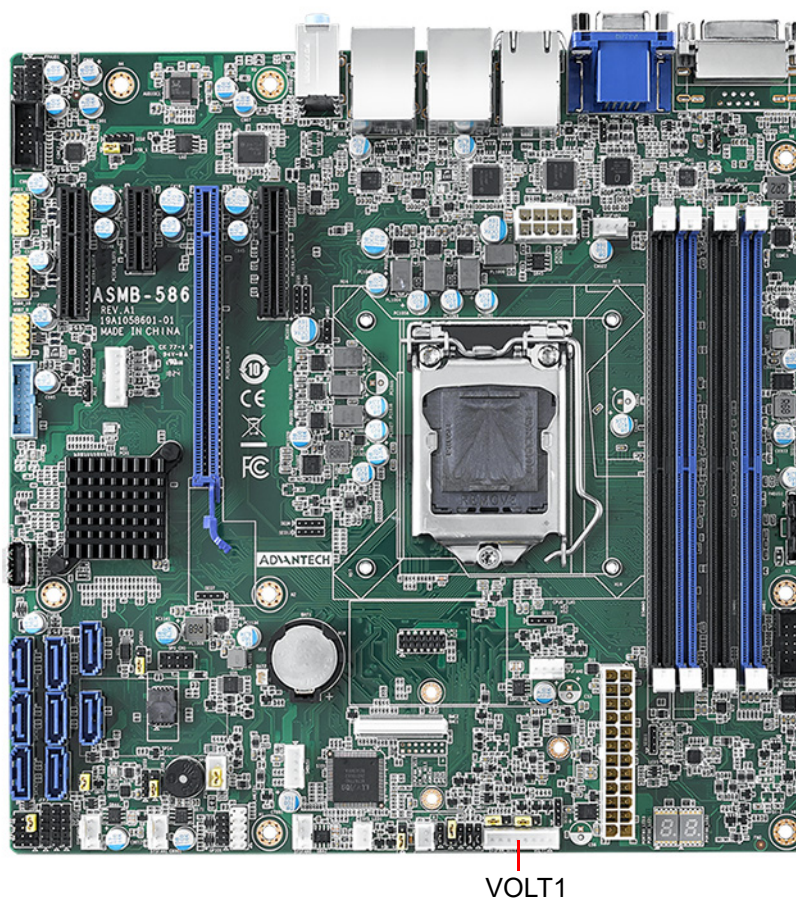

VOLT1 connects to the alarm board of Advantech chassis. This alarm board monitors the input voltage of +12V, +5V, +5Vsb, -5V +3.3V and -12V, and gives warnings if a power supply fails.

2.11 Case Open Connector (JCASE1)

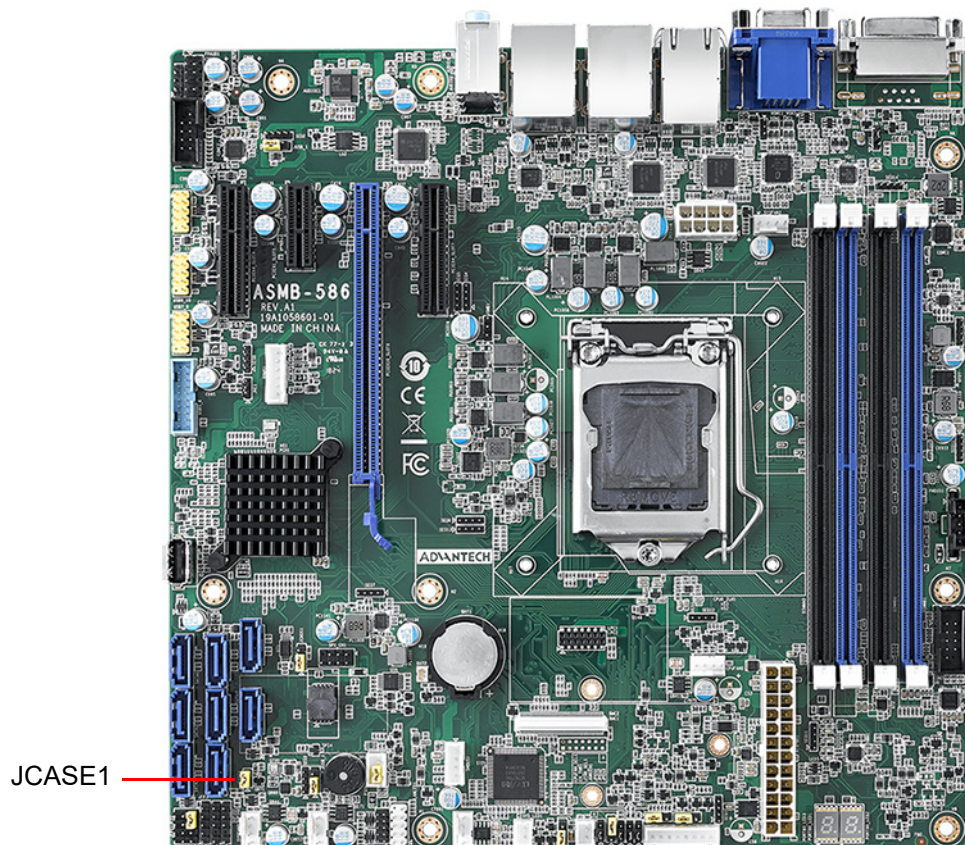

JCASE1 is for chassis with a case open sensor. The default setting of JCASE1 is shorted by jumper and disabled in the BIOS. Before using, please remove the jumper and attach the appropriate cable from the chassis. Then, change the BIOS setting to enable the case open function. Refer to the chapter of HW Monitor in BIOS setting. If the chassis is opened, the BIOS will inform you with a warning message of a chassis intrusion during system reboot and post screen.

2.12 Front Panel LAN Indicator Connector (LANLED1)

LANLED1 is extension connector of LAN1~LAN4.

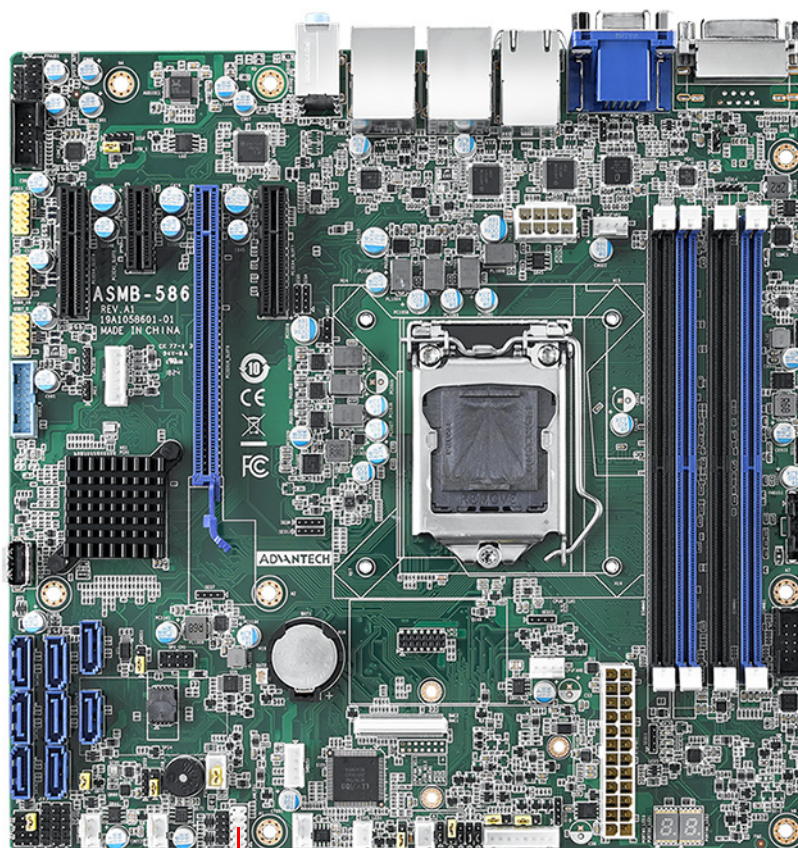

LAN1_LED1

2.13 Serial ATA Interface (SATA0~7)

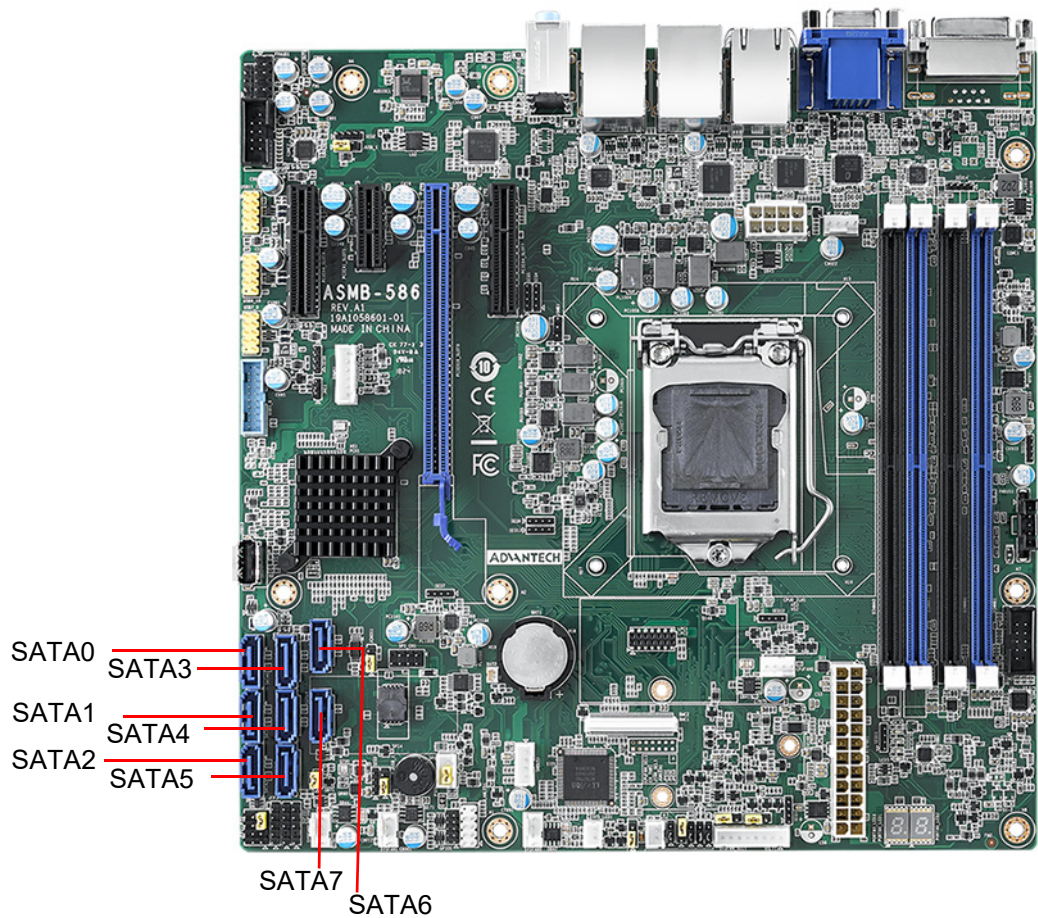

ASMB-586 features eight high performance serial ATA III interfaces (up to 600 MB/s) for massive storage applications. Software RAID 0, 1, 10 & 5 can be supported with Intel RSTe (Rapid Storage Technology Enterprise).

2.14 PCIe x16 Expansion Slot (PCIEX16_SLOT6)

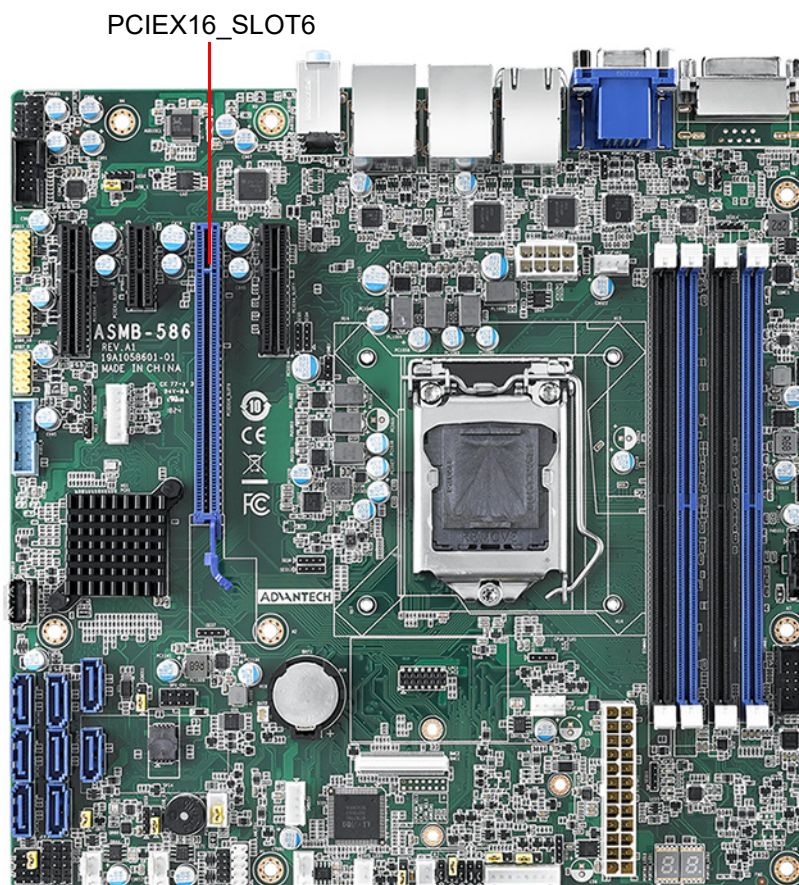

The ASMB-586 provides one PCIe x16 slots (x16 link) for users to install add-on VGA cards when their applications require higher graphics performance than the CPU embedded graphics controller can provide, or for high bandwidth demanding I/O cards, such as frame grabbers, raid cards, and 10G LAN cards.

Note! *Some legacy cards may be incompatible under Windows 10 when CSM configuration in BIOS is set to legacy from the default UEFI mode. Please contact FAE for technical support on this.*

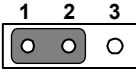
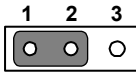
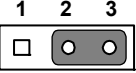
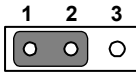
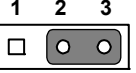
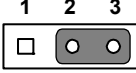

Change JPEG1/JPEG2 jumper setting for slot-6 riser card support:

Function	JPEG1	JPEG2	Riser Card Support
*PCIe x16	 1-2 closed	 1-2 closed	1U: AIMB-RF10F-01A1E 2U: ASMB-RF1F-10A1E AIMB-R43PF-21A1E
PCIe x8/x8	 2-3 closed	 1-2 closed	2U: ASMB-RF3X8-21A1E ASMB-RF348-21A1E ASMB-RF388-21A1E
PCIe x8/x4/x4	 2-3 closed	 2-3 closed	2U: ASMB-RF388-21A1E
* Default setting			

Note! For when installing ASMB-RF348-21A1E riser card and setting PCIe x16 slot in x8/x8 mode. Supports one PCIe x4 (bottom slot) and one PCIe x8 (top slot). The middle PCIe x4 riser card won't work.



2.15 PCIe x4/x1 Expansion Slot (PCIEX4_SLOT4/7, PCIEX1_SLOT5)

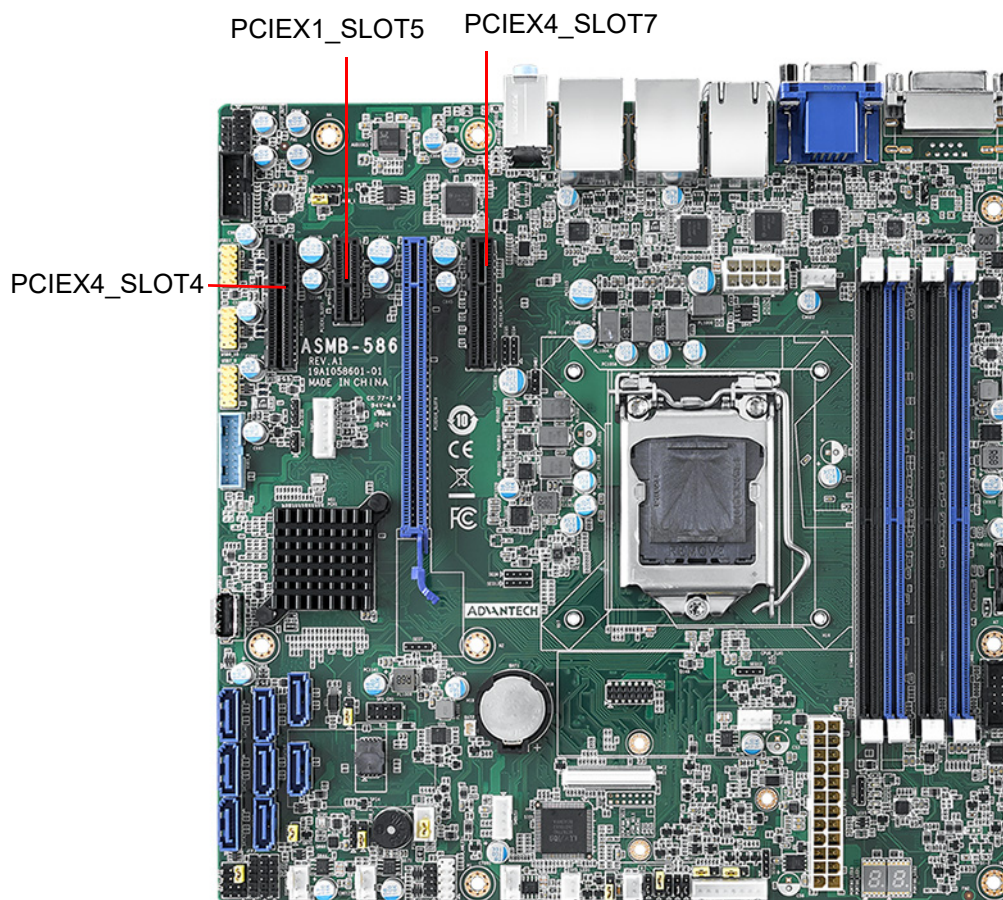

PCIEX4_SLOT4 and PCIEX4_SLOT7 are in Gen3 x4 link speed. PCIEX1_SLOT1 is Gen3 x1 link. Higher speed cards have speed downgrades when used in these slots.

2.16 Auxiliary Power Connector (ATX12V1)

This power connector is used for processors. For a fully configured system, we recommend that you use a power supply unit (PSU) that complies with ATX 12V Specification 2.0 (or later version). Do not forget to connect the 8-pin power plug, or through a 4-pin to 8-pin converted cable (P/N: 1700019748) when there's no 8-pin power plug on the PSU, otherwise, the system will not boot.

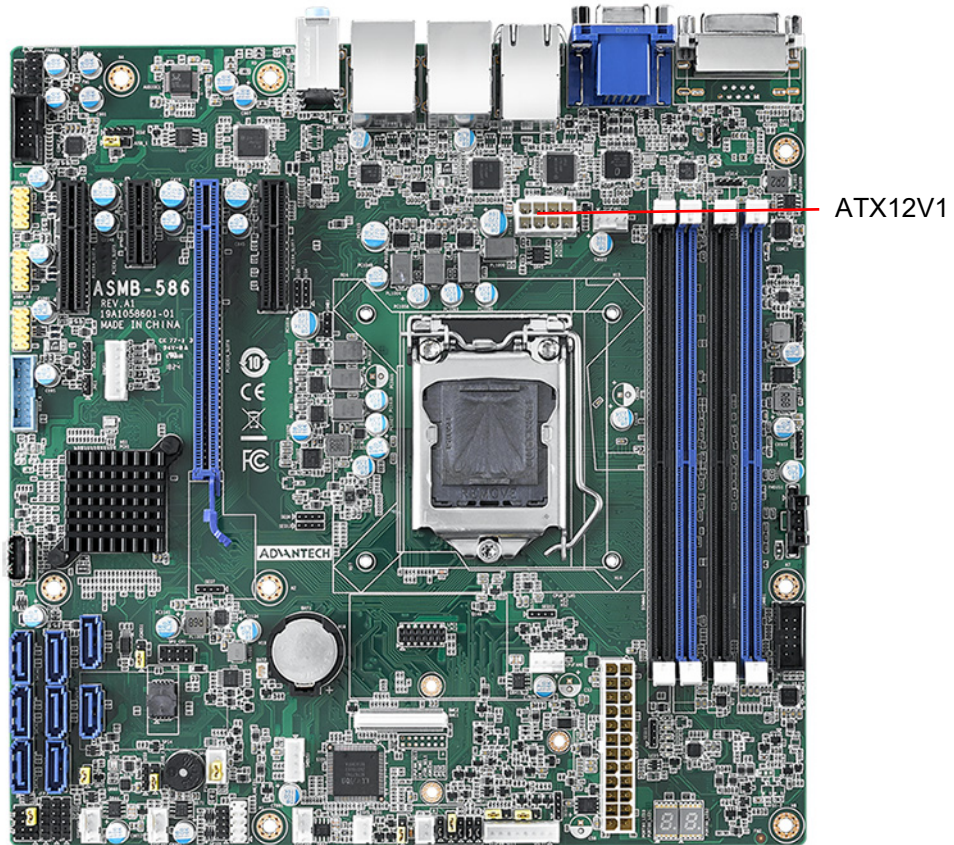

2.17 SPI Flash Connector (SPI_CN1)

SPI flash programmer pin header (for RMA) can flash BIOS while ASMB-586 is not powered on.

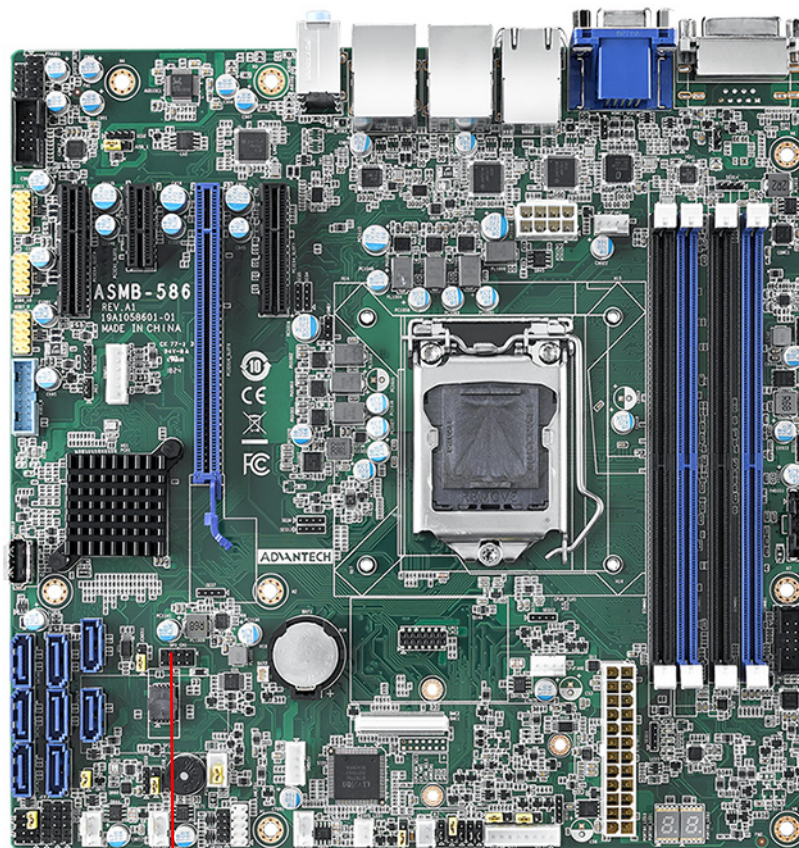

SPI_CN1

2.18 Low Pin Count Connector (LPC1)

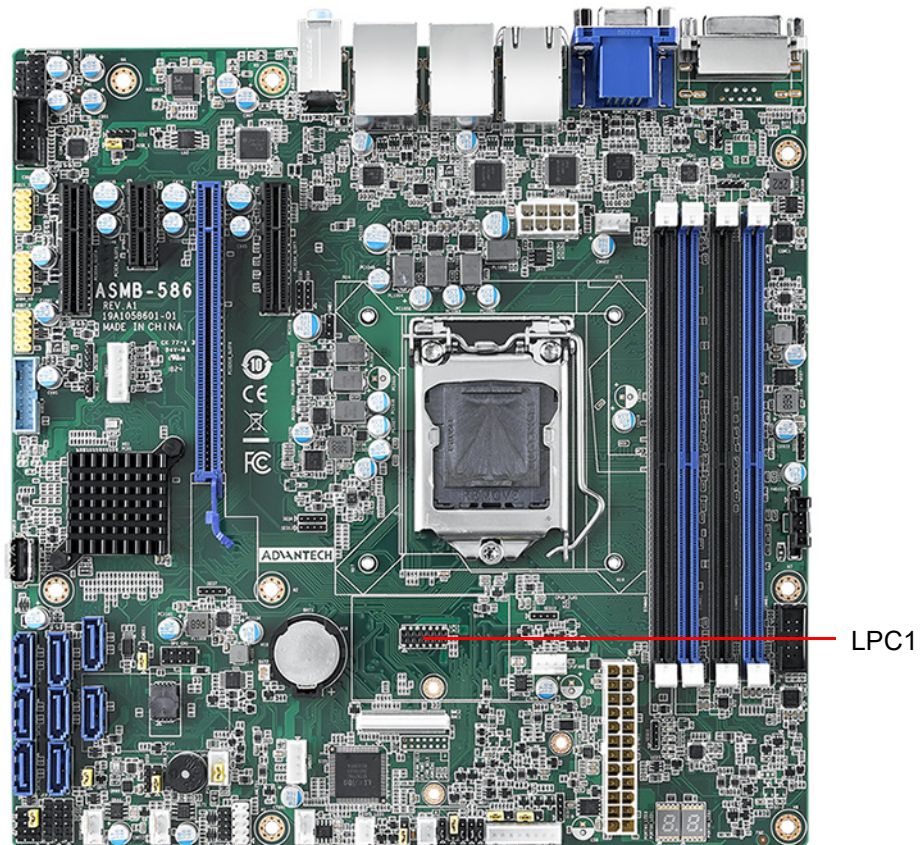

LPC connector on ASMB-586 is reserved for Advantech TPM and COM RS-232/422/485 modules.

Advantech P/N	LPC Module
PCA-TPM-00A1E	TPM 1.2 module
PCA-TPM-00B1E	TPM 2.0 module
PCA-COM232-00A1E	4 ports RS-232 module connect to LPC connector
PCA-COM485-00A1E	4 ports RS-422/485 module connect to LPC connector

2.19 PMBUS Connector (PMBUS1)

PMBUS connector on ASMB-586 is reserved for communication with power supply via BMC. The IPMI module (P/N: IPMI-1000-00A2E) must be installed to enable this feature.

Note! *Please remove the PMbus cable to avoid PMbus and DIMM conflict issue that may happen due to same address of SMbus, if the remote monitoring function with IPMI module is not used. Or, you can contact with an Advantech AE for an alternative solution once it happens.*

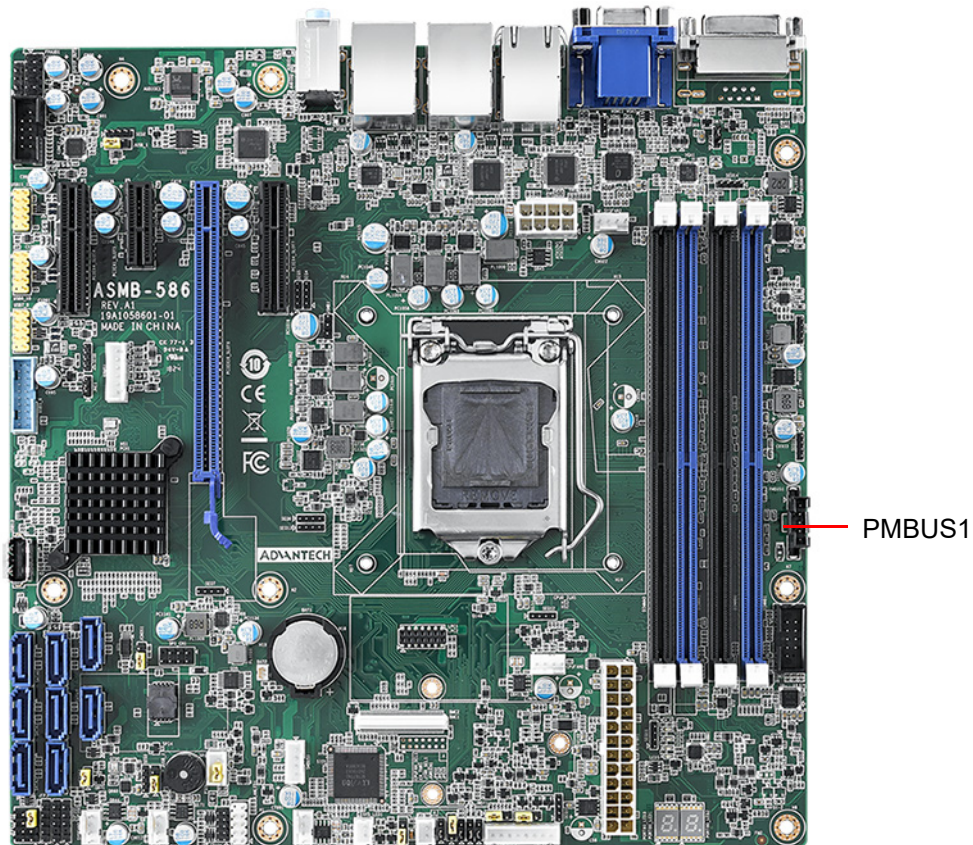

Chapter 3

BIOS Operation

3.1 Introduction

With the AMI BIOS Setup program, you can modify BIOS settings and control the special features of your computer. The Setup program uses a number of menus for making changes and turning the special features on or off. This chapter describes the basic navigation of the ASMB-586 setup screens.



Figure 3.1 Main setup screen

AMI's BIOS ROM has a built-in Setup program that allows users to modify the basic system configuration. This information is stored in NVRAM area so it retains the Setup information when the power is turned off.

3.2 Entering BIOS Setup

Press or <Esc> at bootup to enter AMI BIOS Setup Utility, the Main Menu will appear on the screen. Use arrow keys to select among the items and press <Enter> to accept or enter the sub-menu.

When users first enter the BIOS Setup Utility, they enter the Main setup screen. Users can always return to the Main setup screen by navigating to the Main tab. There are two Main Setup options. They are described in this section. The Main BIOS Setup screen is shown below.

3.2.1 Main Menu

Press or <Esc> at bootup to enter AMI BIOS CMOS Setup Utility, the Main Menu will appear on the screen. Use arrow keys to select among the items and press <Enter> to accept or enter the sub-menu.



Figure 3.2 Main setup screen

The Main BIOS setup screen has two main frames. The left frame displays all the options that can be configured. Grayed-out options cannot be configured; options in blue can be. The right frame displays the key legend.

Above the key legend is an area reserved for a text message. When an option is selected in the left frame, it is highlighted in white. Often a text message will accompany it.

3.2.2 System Time / System Date

Use this option to change the system time and date. Highlight System Time or System Date using the <Arrow> keys. Enter new values through the keyboard. Press the <Tab> key or the <Arrow> keys to move between fields. The date must be entered in MM/DD/YY format. The time must be entered in HH:MM:SS format.

3.3 Advanced BIOS Features Setup

Select the Advanced tab from the ASMB-586 setup screen to enter the Advanced BIOS setup screen. You can select any of the items in the left frame of the screen, such as CPU configuration, to go to the sub menu for that item. You can display an Advanced BIOS Setup option by highlighting it using the <Arrow> keys. All Advanced BIOS Setup options are described in this section. The Advanced BIOS Setup screens are shown below. The sub menus are described on the following pages.

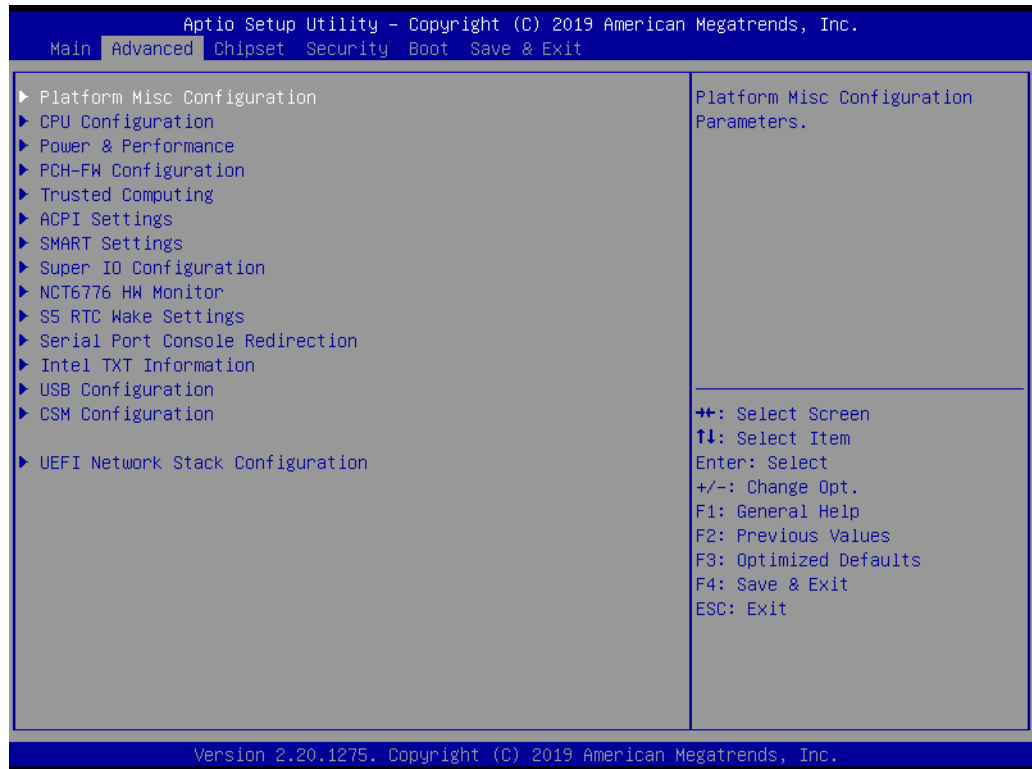

Figure 3.3 Advanced BIOS features setup screen

3.3.1 Platform Misc Configuration

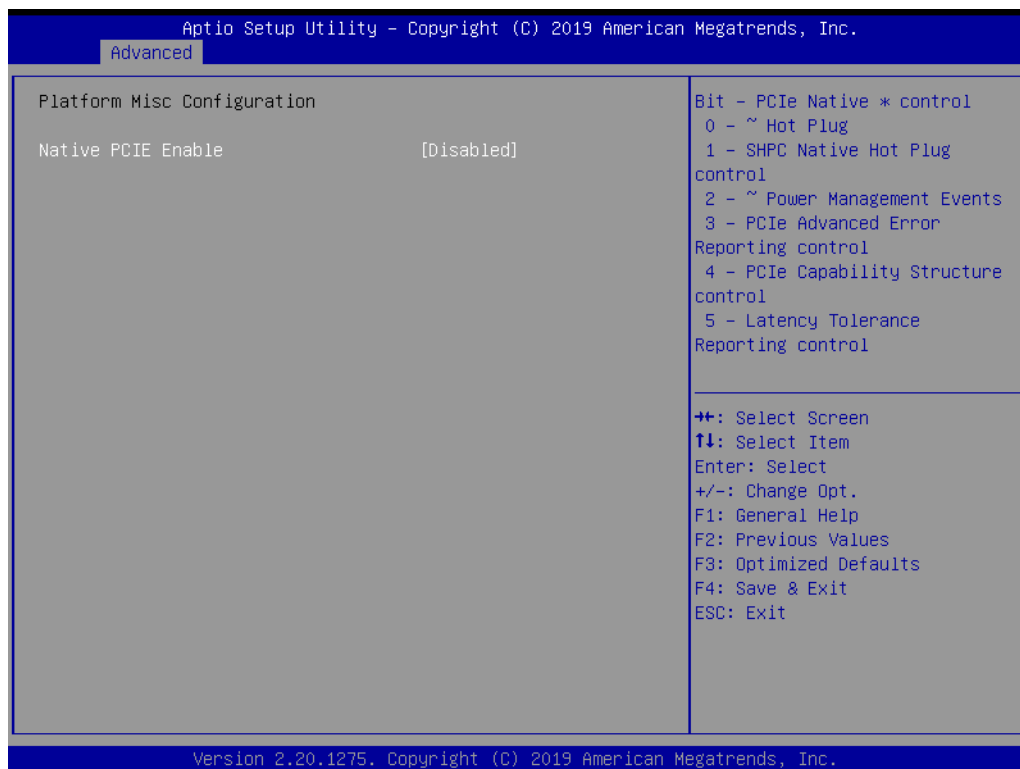
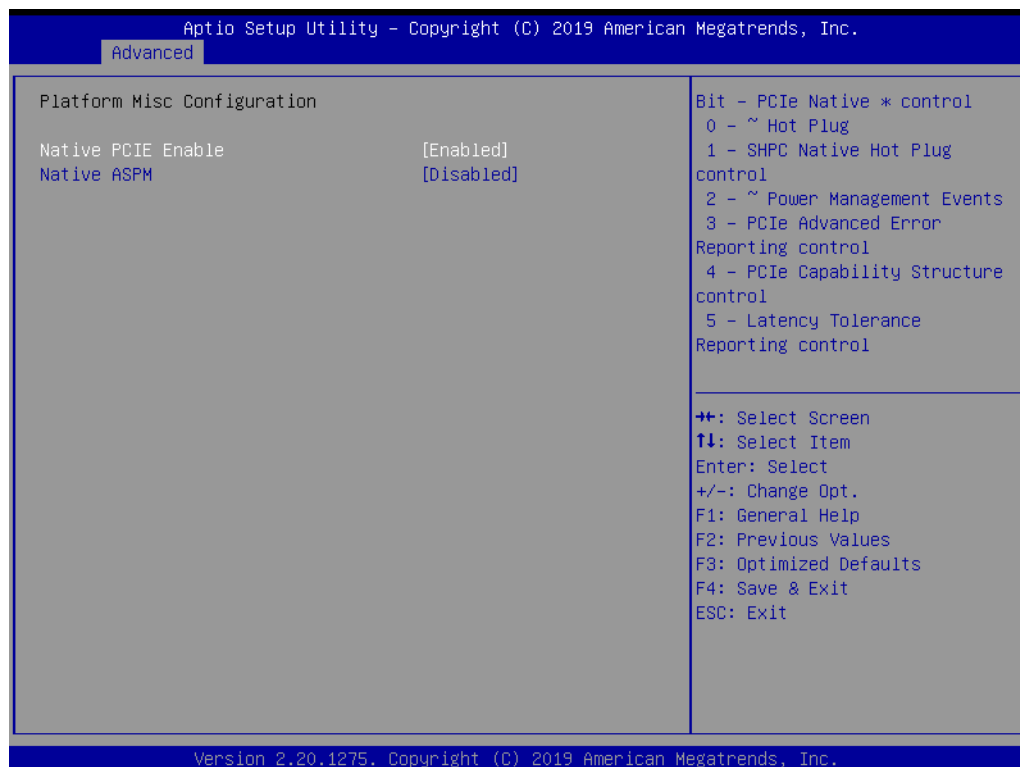

Figure 3.4 Platform misc configuration screen

- Native PCIE Enable**
 Enable/Disable PCIe native control. When changed to enable, 'Native ASPM' can be selected as 'Enabled' for OS control and ASPM or 'Disabled' for BIOS control. Default is disable for BIOS control.



3.3.2 CPU Configuration

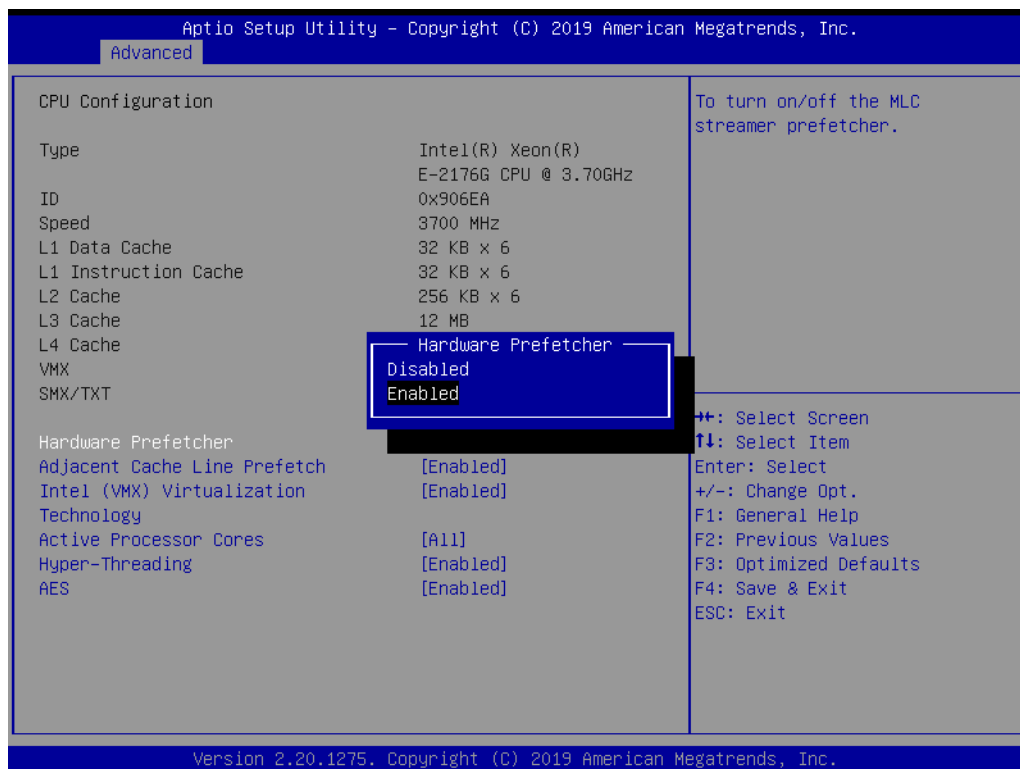

Figure 3.5 CPU configuration screen

■ **Hardware Prefetcher**

To turn on/off the MLC streamer prefetcher.

Hardware Prefetcher is a technique that fetches instructions and/or data from memory into the CPU cache memory well before the CPU needs it, so that it can improve the load-to-use latency. You may choose to enable or disable it.



■ Adjacent Cache Line Prefetch

The Adjacent Cache-Line Prefetch mechanism, like automatic hardware prefetch, operates without programmer intervention. When enabled through the BIOS, two 64-byte cache lines are fetched into a 128-byte sector, regardless of whether the additional cache line has been requested or not. You may choose to enable or disable it.

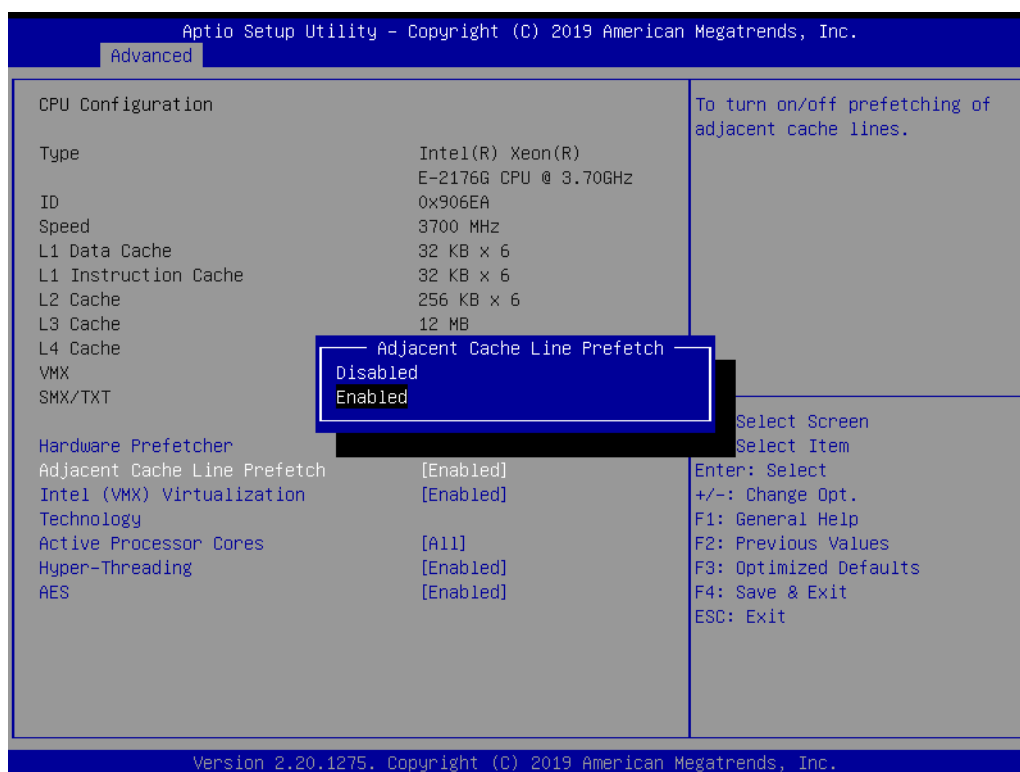

■ **Intel (VMX) Virtualization Technology**

This feature is used to enable or disable the Intel Virtualization Technology (IVT) extension. It allows multiple operating systems to run simultaneously on the same system. It does this by creating virtual machines, each running its own x86 operating system.

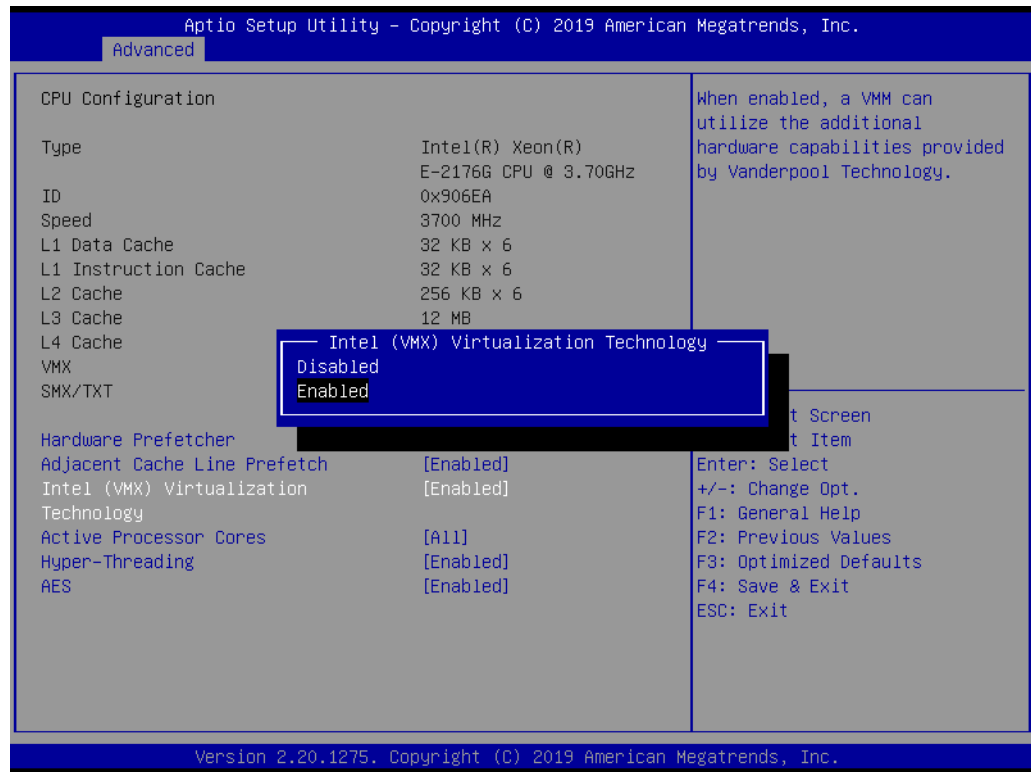

■ **Active Processor Cores**

Number of cores to enable in each processor package.

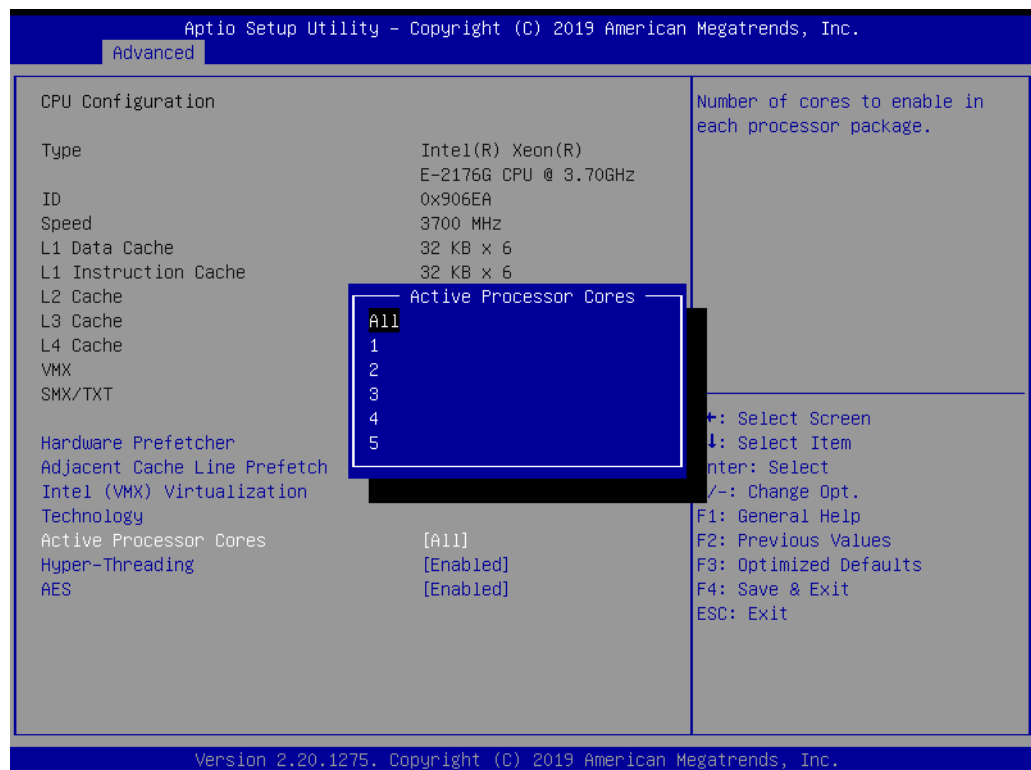

■ Hyper-Threading

Enable or disable a Hyper-Threading processor to optimize as two logical processors, allowing the OS to schedule two threads or processors simultaneously.



■ AES

This item enables or disables CPU advanced encryption standard instructions.



3.3.3 Power & Performance

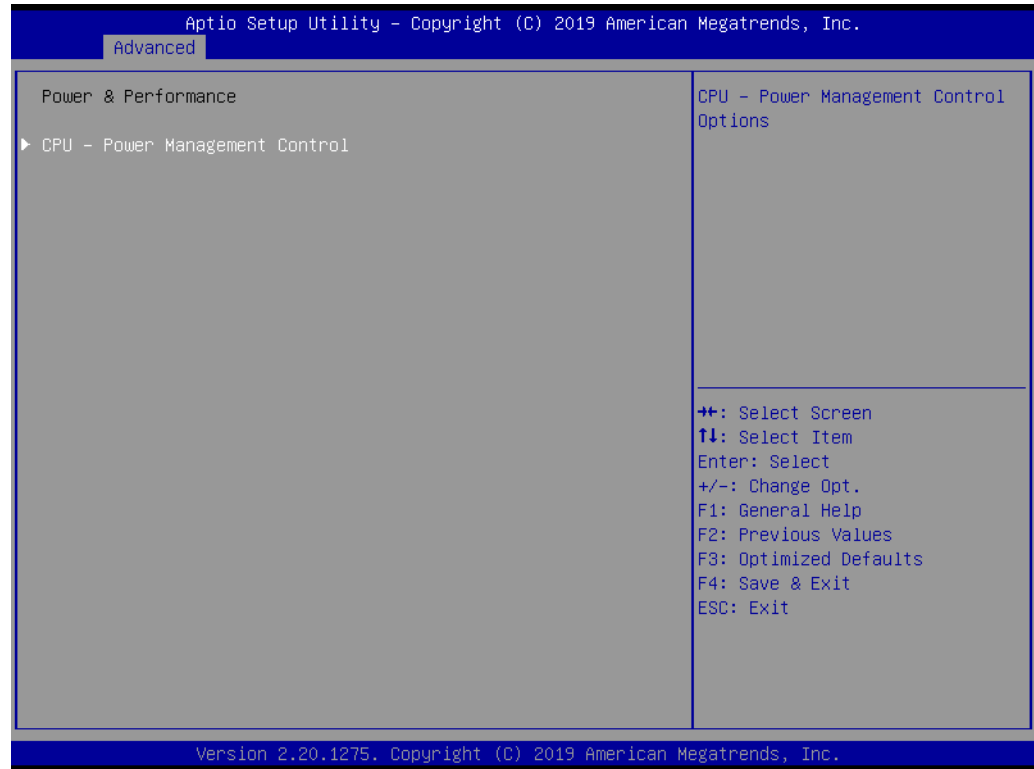
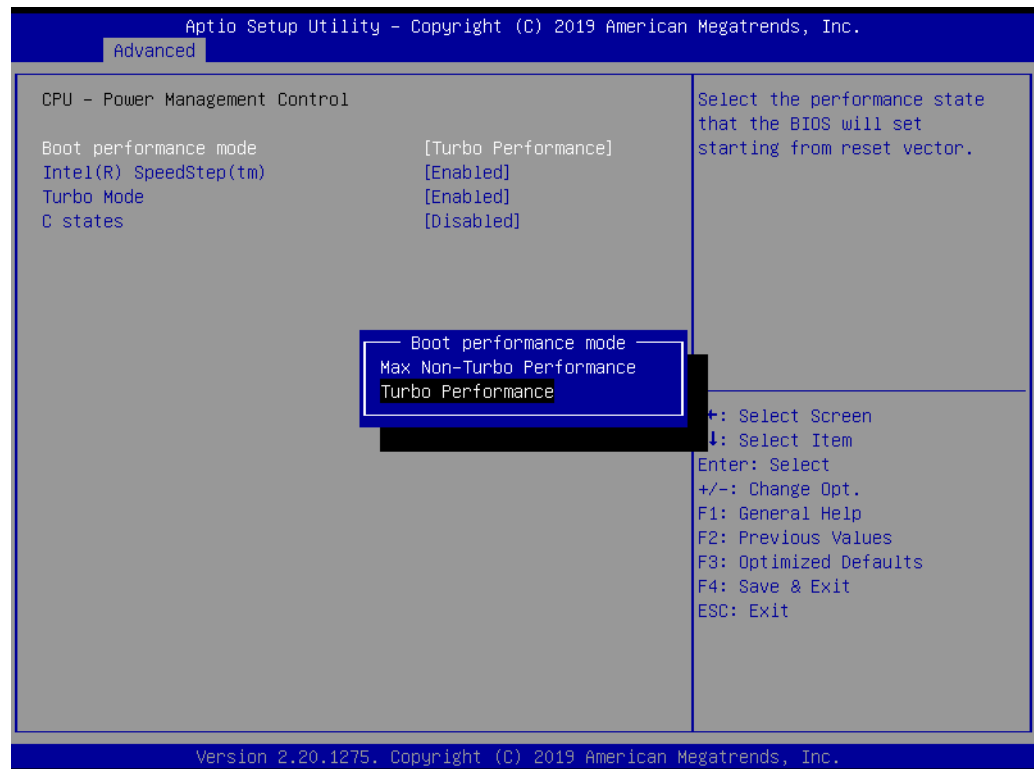

Figure 3.6 CPU - power management control screen

- **Boot performance mode**

Select the performance state that the BIOS will set before OS handoff.



- **Intel (R) SpeedStep (tm)**

Allows more than two frequency ranges to be supported.

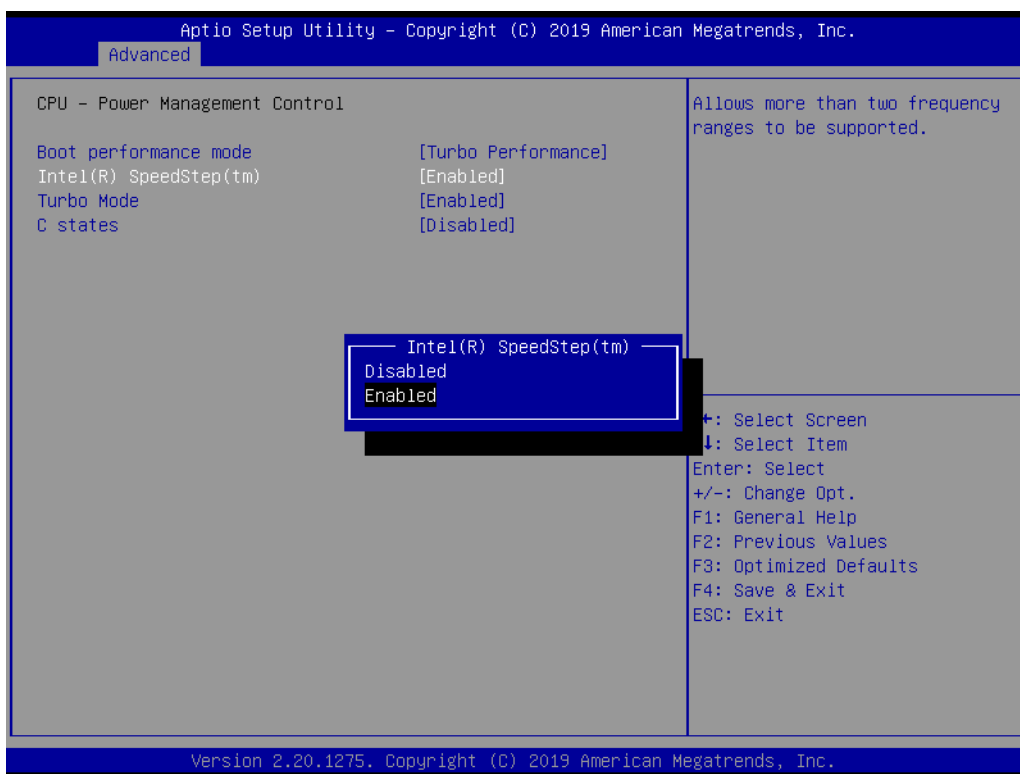

■ Turbo Mode

Enable/Disable processor turbo mode (requires Intel Speed Step or Intel Speed Shift to be available and enabled)

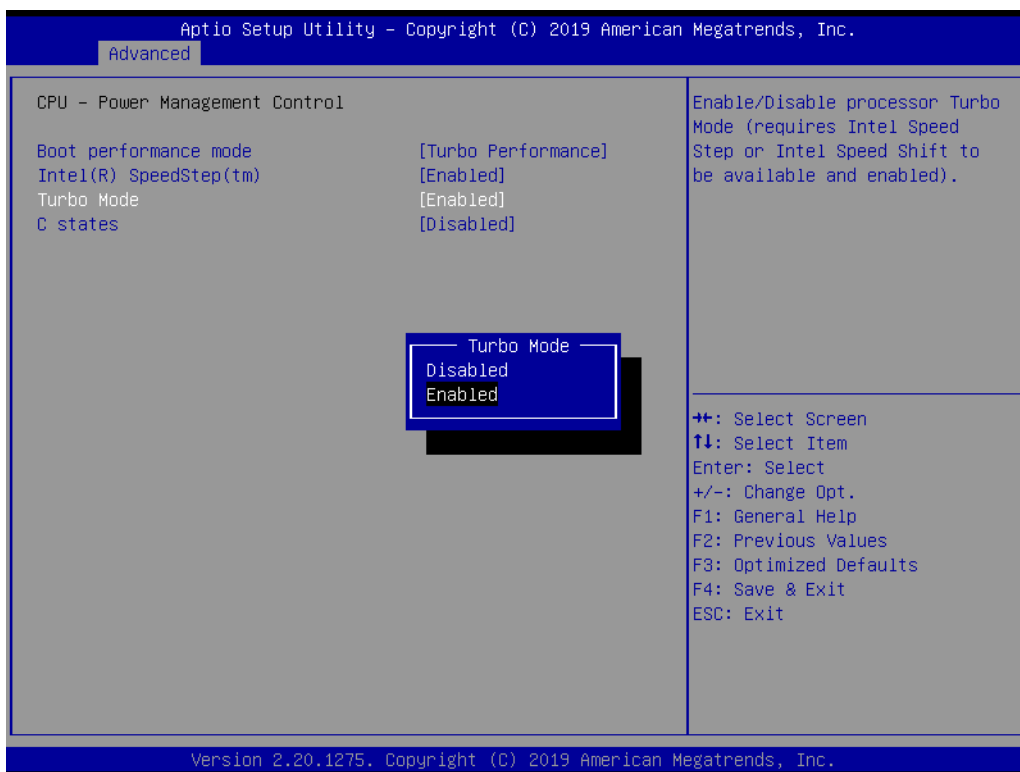

■ **C States**

Enable/Disable CPU power management. Allows CPU to go to C states when not 100% utilized.

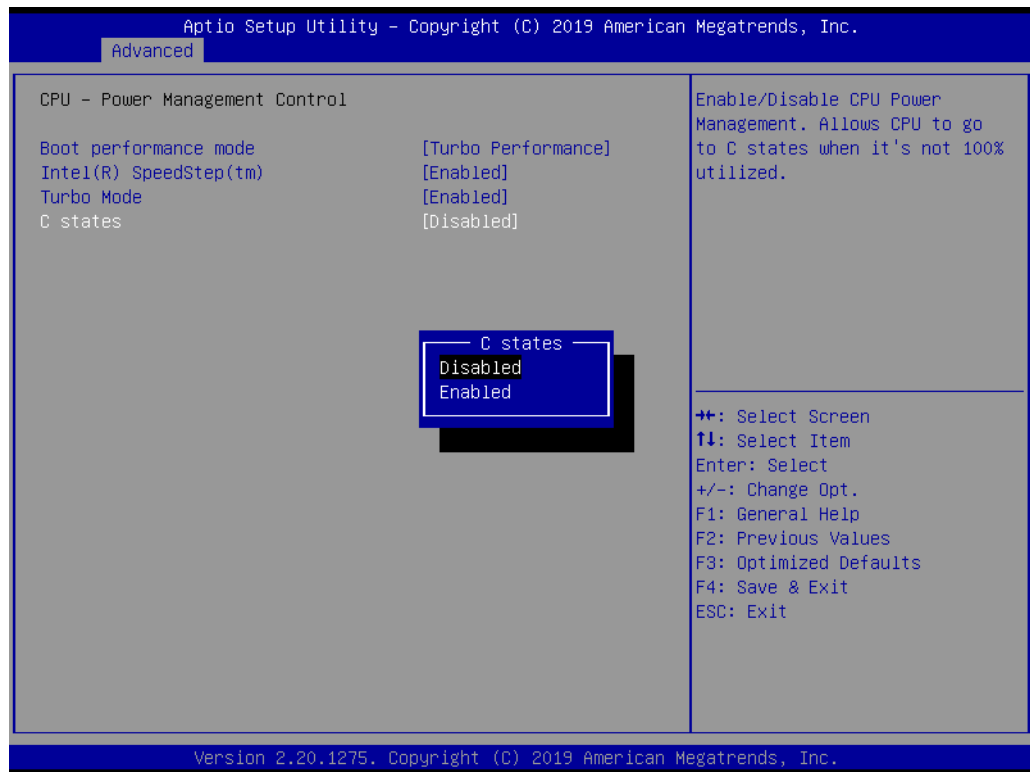

3.3.4 PCH-FW Configuration

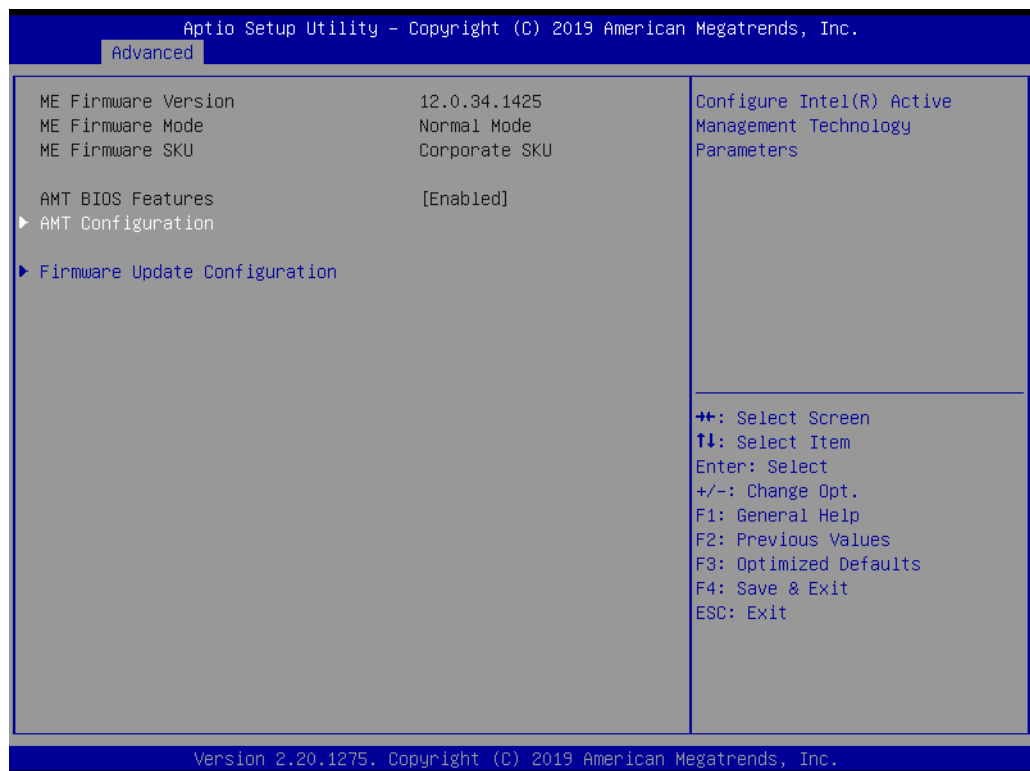

Figure 3.7 PCH-FW configuration screen

This page shows the Intel ME configuration.

3.3.4.1 AMT Configuration

■ ASF support

Enable/Disable alert standard format support.

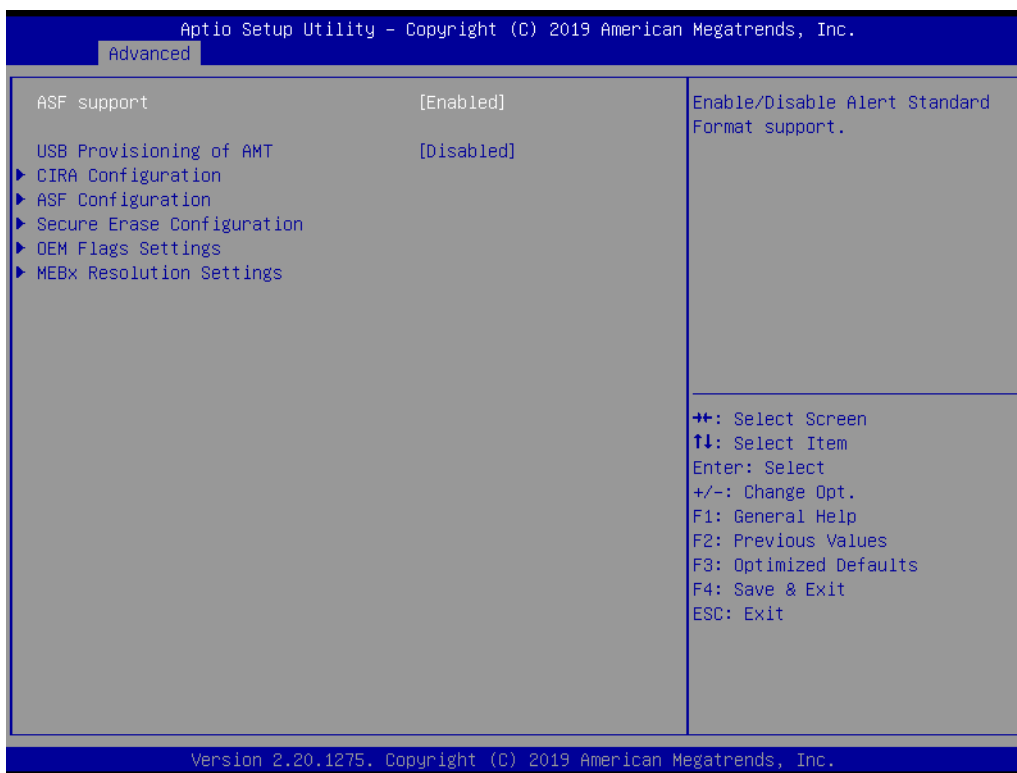

■ USB Provisioning of AMT

Enable/Disable of AMT USB provisioning.

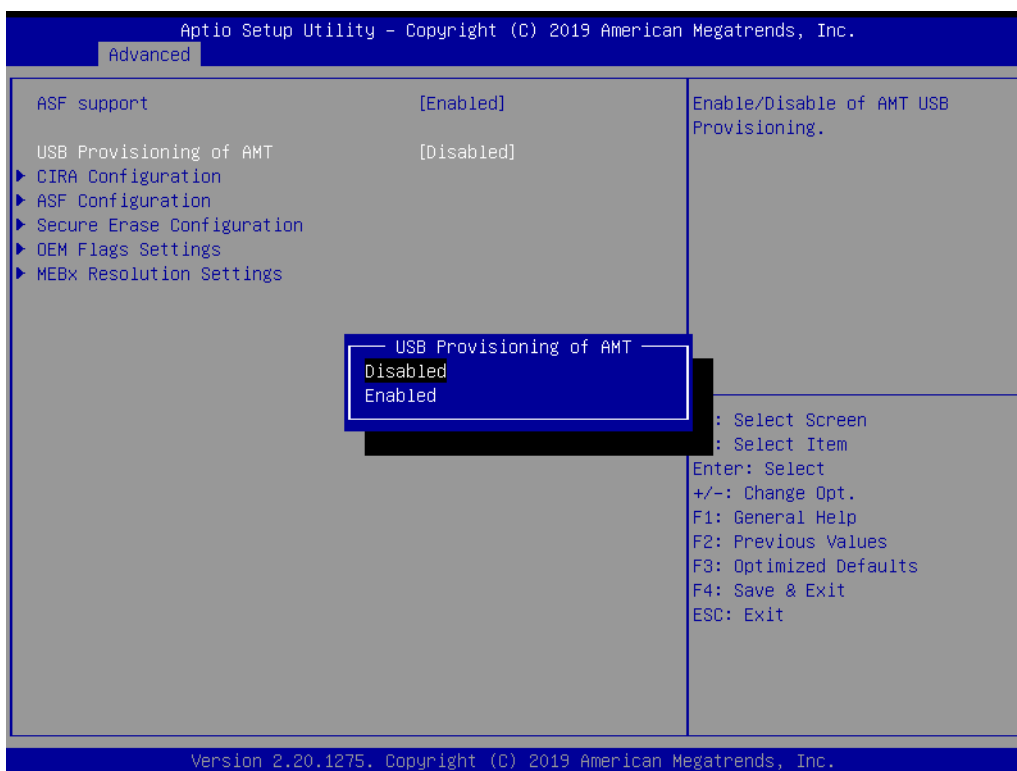

■ CIRA Configuration



- Activate Remote Assistance Process
Trigger CIRA boot.
Network access must be activated first from MEBx setup.

■ ASF Configuration

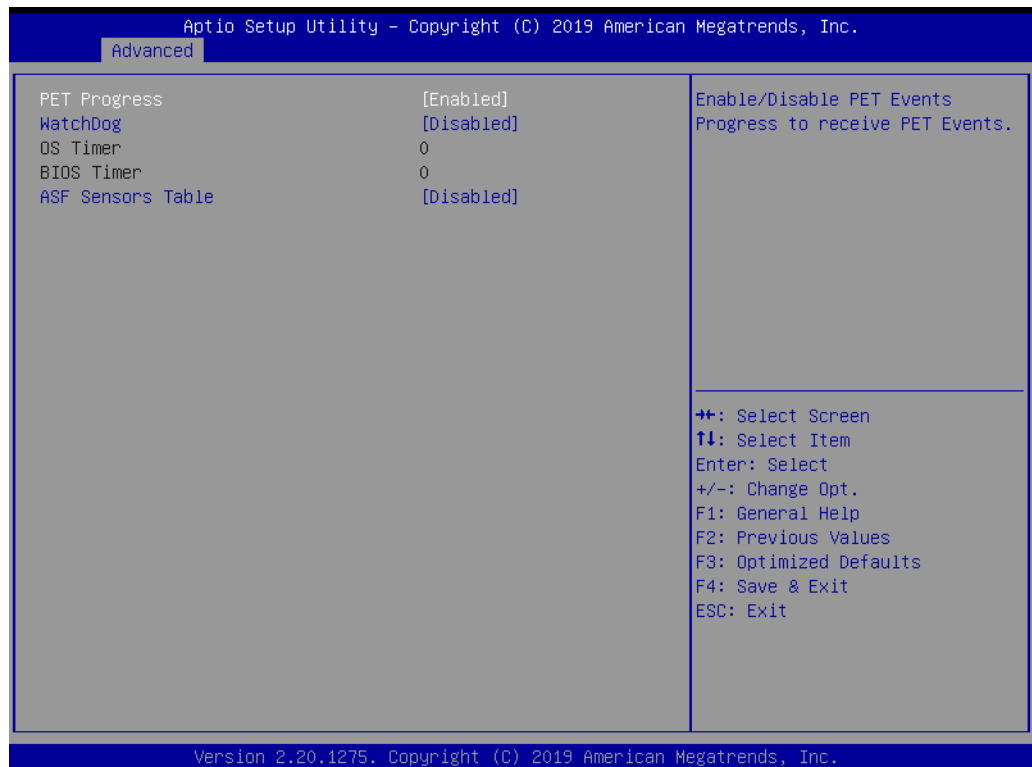

- PET Progress
Enable/Disable PET events progress to receive PET events.
- WatchDog
Enable or disable WatchDog Timer.
- ASF Sensors Table
Adds ASF Sensor Table into ASF ACPI Table.

■ Secure Erase Configuration

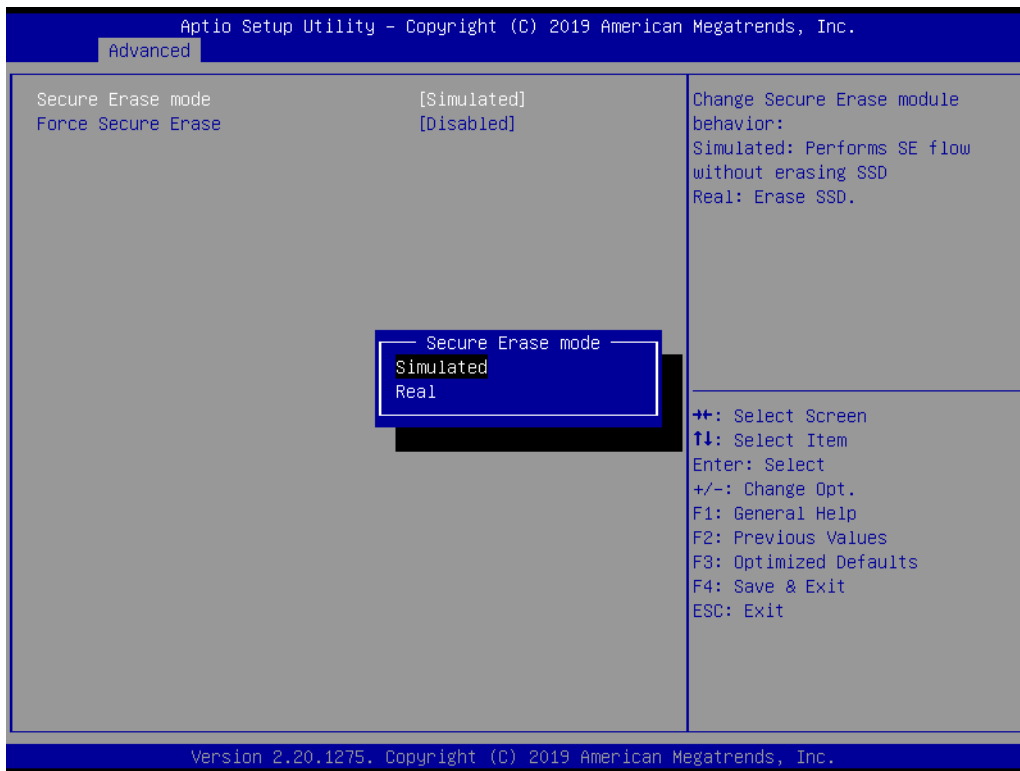

- Secure Erase mode
Change Secure Erase module behavior to 'Simulated' or 'Real'.
- Force Secure Erase
Enable or disable Force Secure Erase on next boot.

■ OEM Flags Settings



- MEBx hotkey Pressed
Enable automatic MEBx hotkey press.
- MEBx Selection Screen
Enable MEBx selection screen with 2 options:
Press 1 to enter ME configuration screens.
Press 2 to initiate a remote connection.
Network Access must be activated from MEBx Setup for this screen to be displayed.
- Hide Unconfigure ME Confirmation Prompt
Hide Unconfigure ME Confirmation Prompt when attempting ME unconfiguration.
- MEBx OEM Debug Menu Enable
Enable OEM debug menu in MEBx.
- Unconfigure ME
Unconfigure ME with resetting MEBx password to default.

■ MEBx Resolution Settings

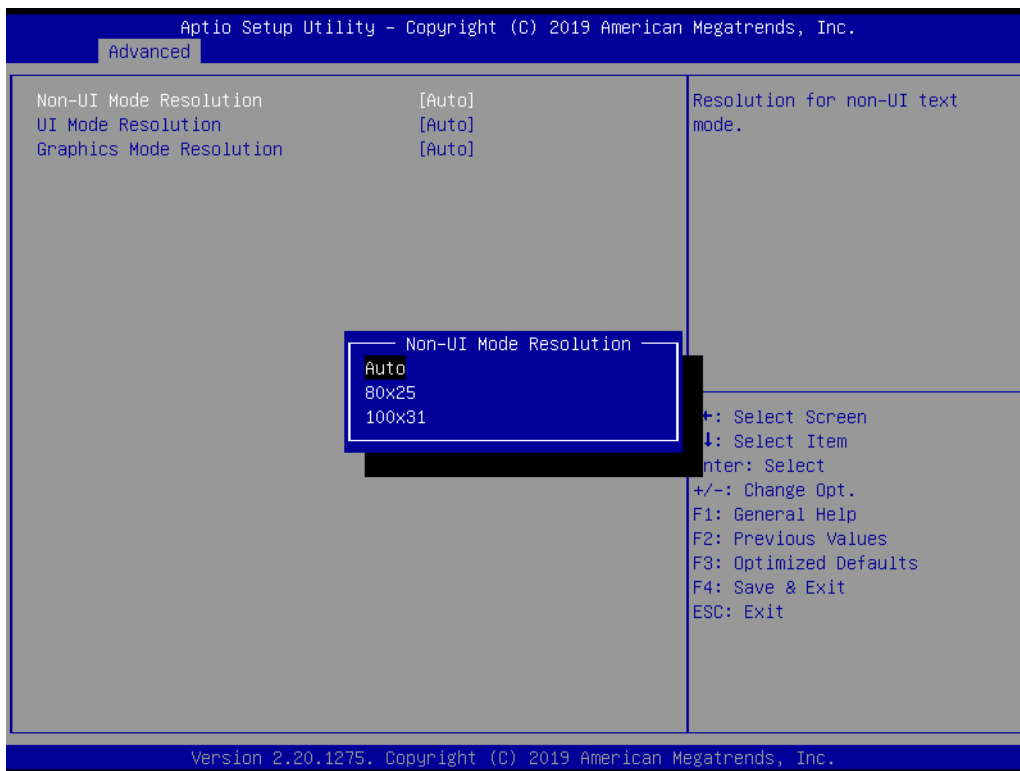

- Non-UI Mode Resolution
Resolution for non-UI text mode.
- UI Mode Resolution
Resolution for UI text mode.
- Graphics Mode Resolution
Resolution for graphics mode.

3.3.4.2 Firmware Update Configuration



- **Me FW Image Re-Flash**
Enable/Disable Me FW image re-flash function.

3.3.5 Trusted Computing

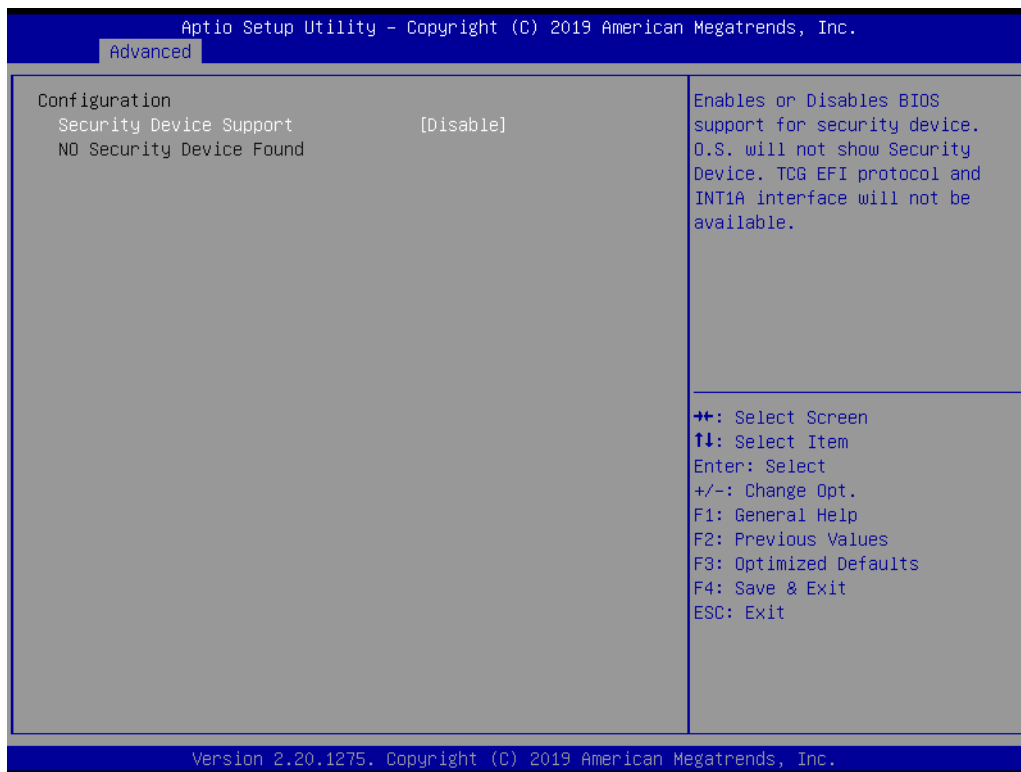

Figure 3.8 TPM settings screen

- Security Device Support**
 Enable or disable TPM support. You can purchase Advantech LPC TPM module to enable TPM function.

3.3.6 ACPI Settings

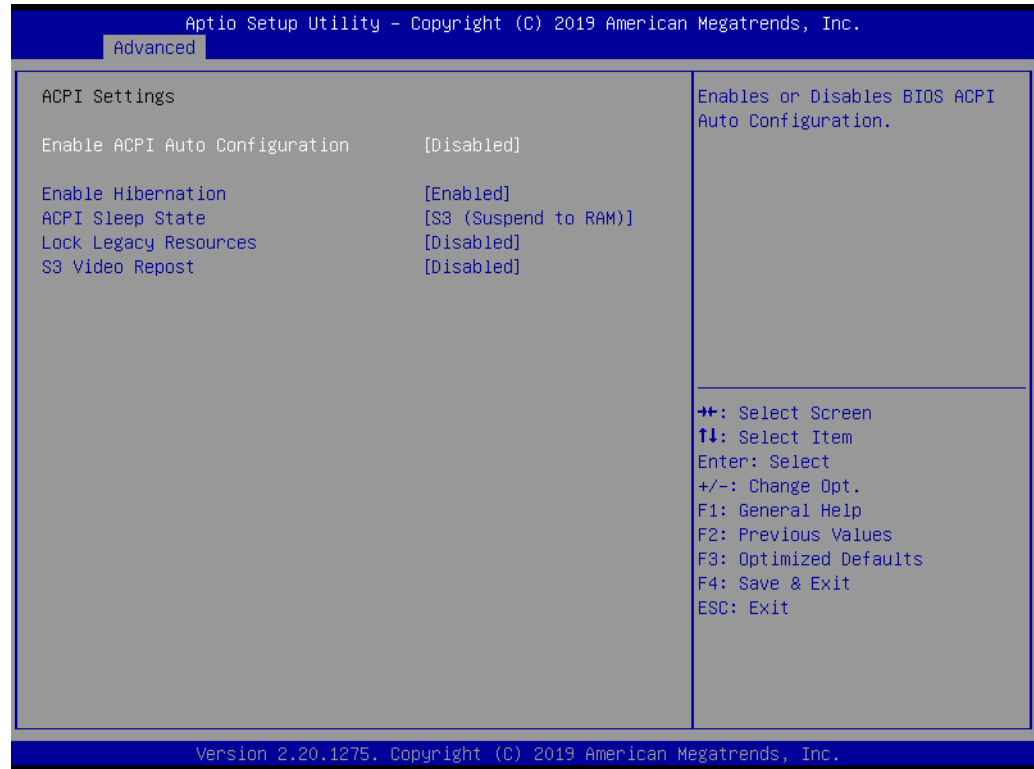

Figure 3.9 ACPI settings screen

- **Enable ACPI Auto Configuration**
Enable or disable BIOS ACPI Auto Configuration.
- **Enable Hibernation**
Enable or disable Hibernate (OS/S4 Sleep State) that may not be effective with some operating systems.
- **ACPI Sleep State**
Specifies the ACPI sleep state when the system enters suspend.
- **Lock Legacy Resources**
Enable or disable Lock Legacy Resources.
- **S3 Video Repost**
Enable or disable S3 video repost.

3.3.7 SMART Settings

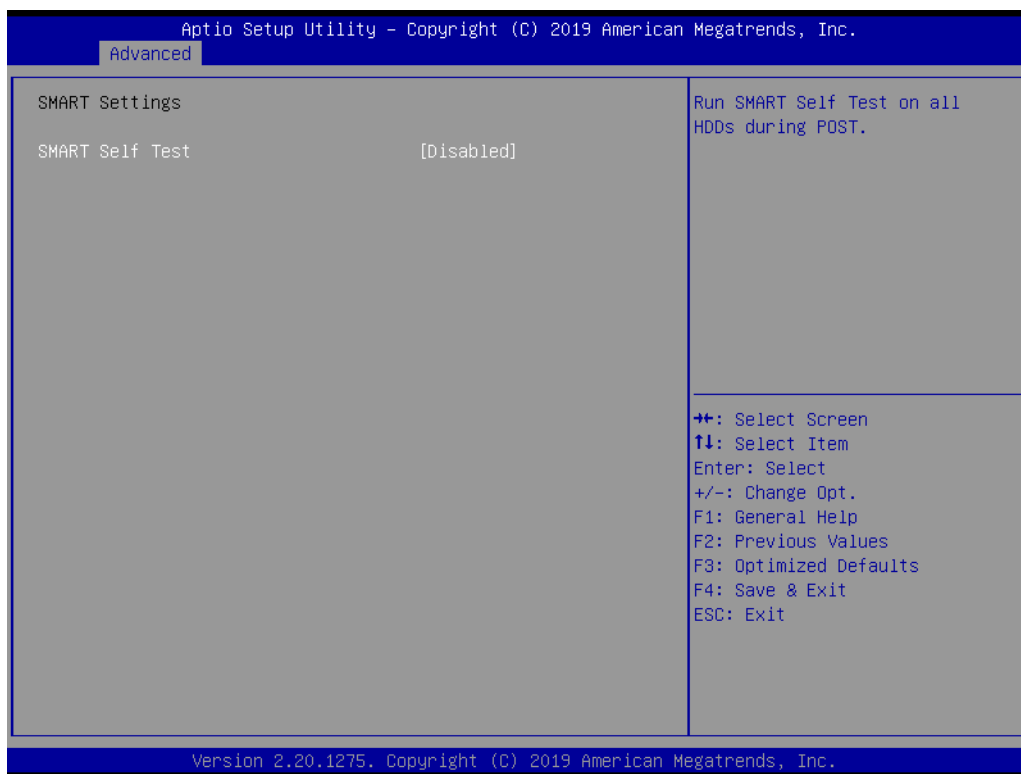

Figure 3.10 SMART settings screen

- **SMART Self Test**
Enable or disable SMART self test on all HDDs during post.

3.3.8 Super IO Configuration

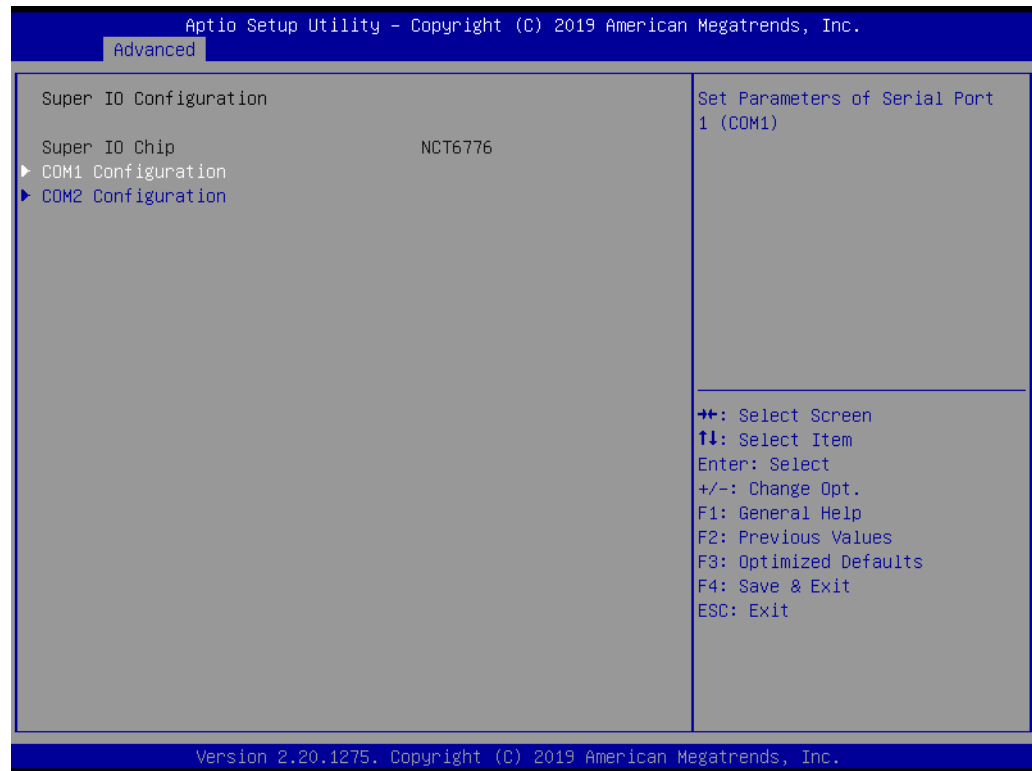
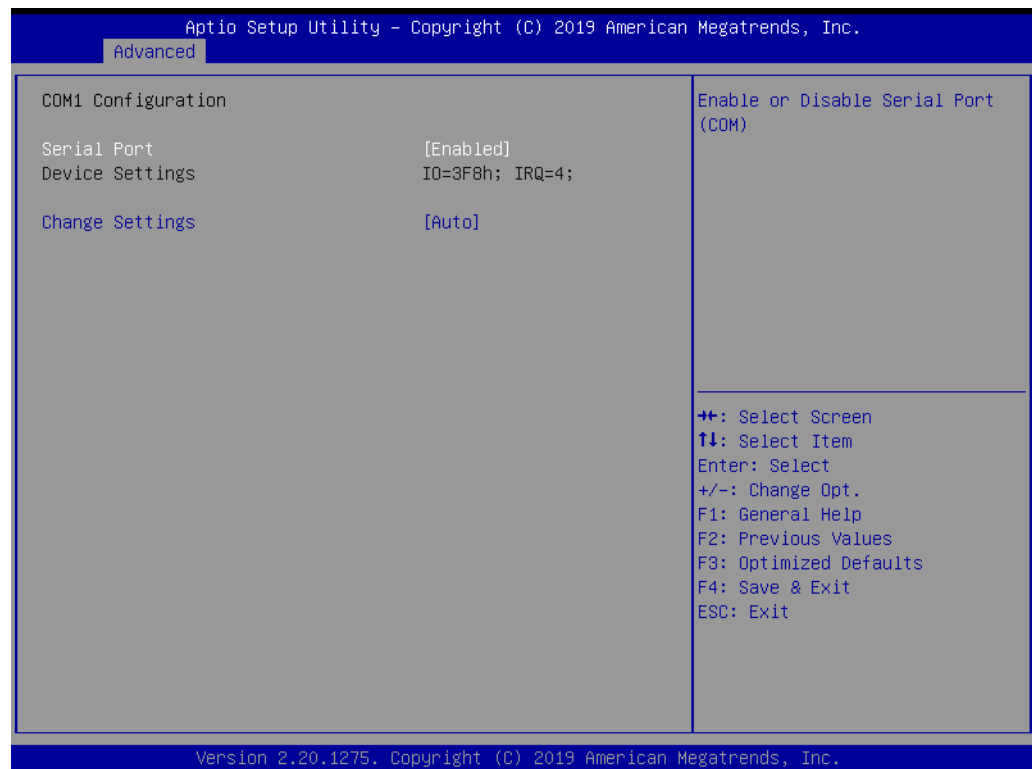
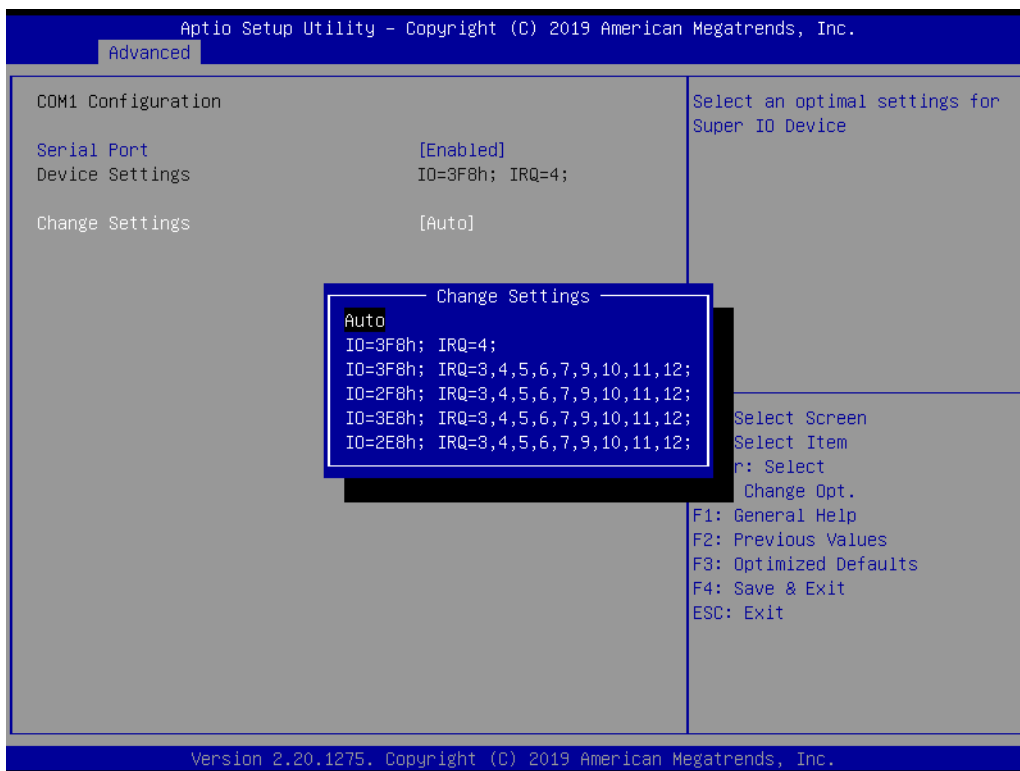

Figure 3.11 Super IO configuration screen

- **COM 1 Configuration**
 - Serial Port
Enable or disable Serial Port (COM1).
 - Change Settings
Select an optimal setting for Super IO Device.





■ COM 2 Configuration

- Serial Port
Enable or disable Serial Port (COM2).
- Change Settings
Select an optimal setting for Super IO Device.

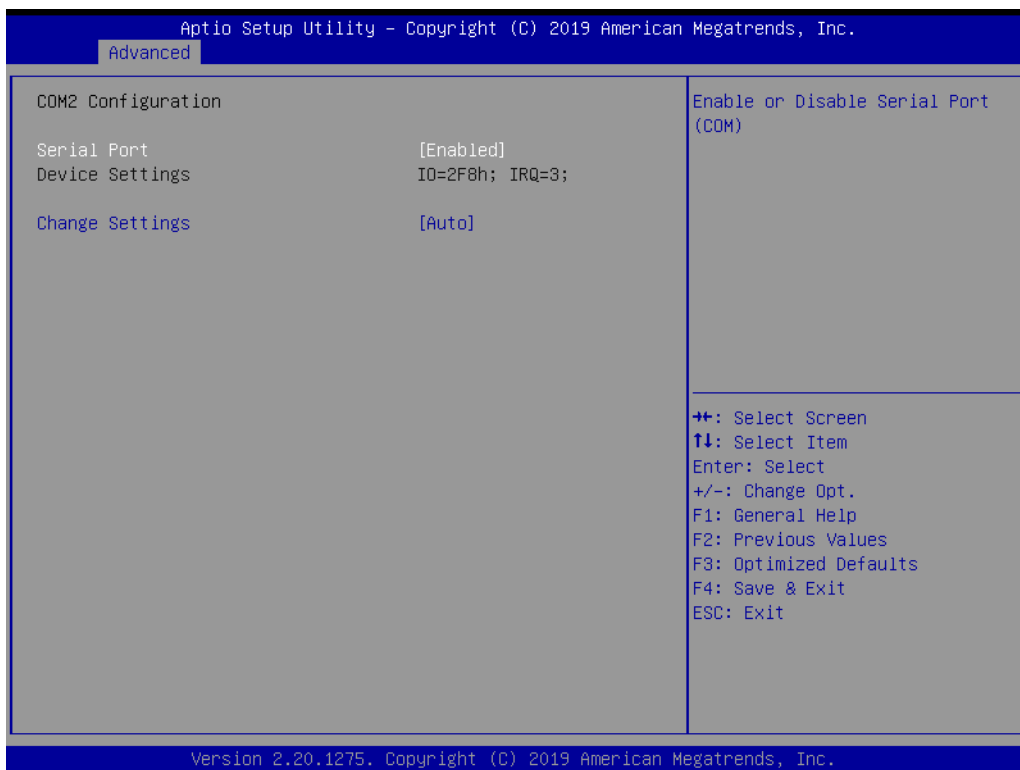

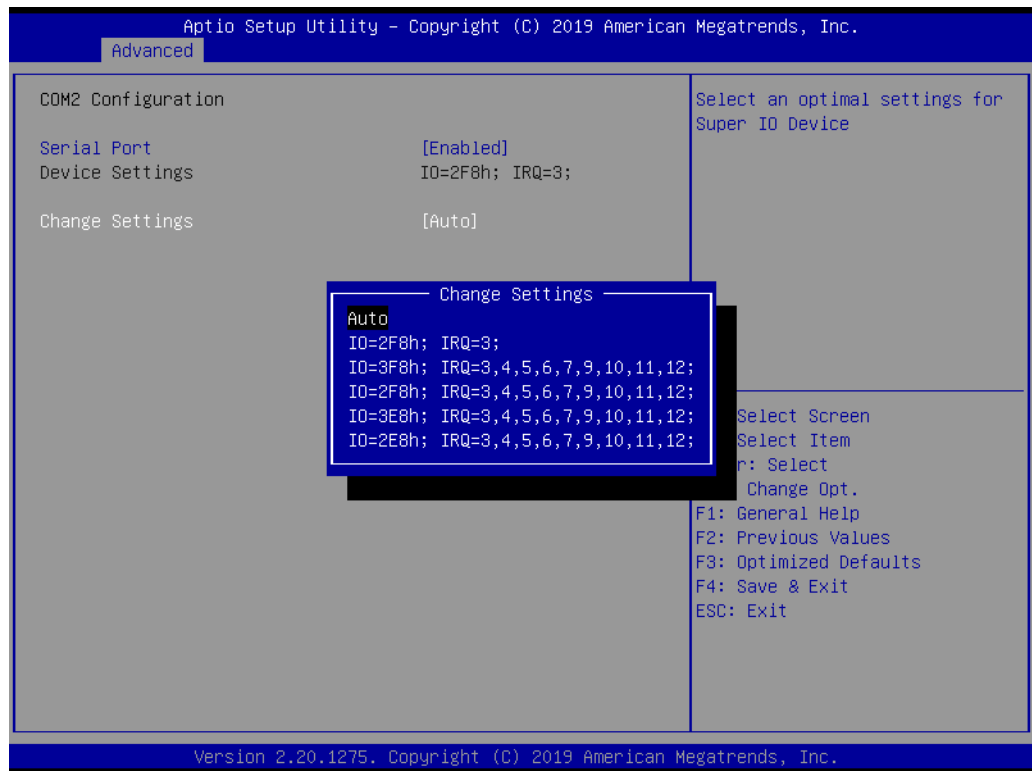

3.3.9 NCT6776 HW Monitor

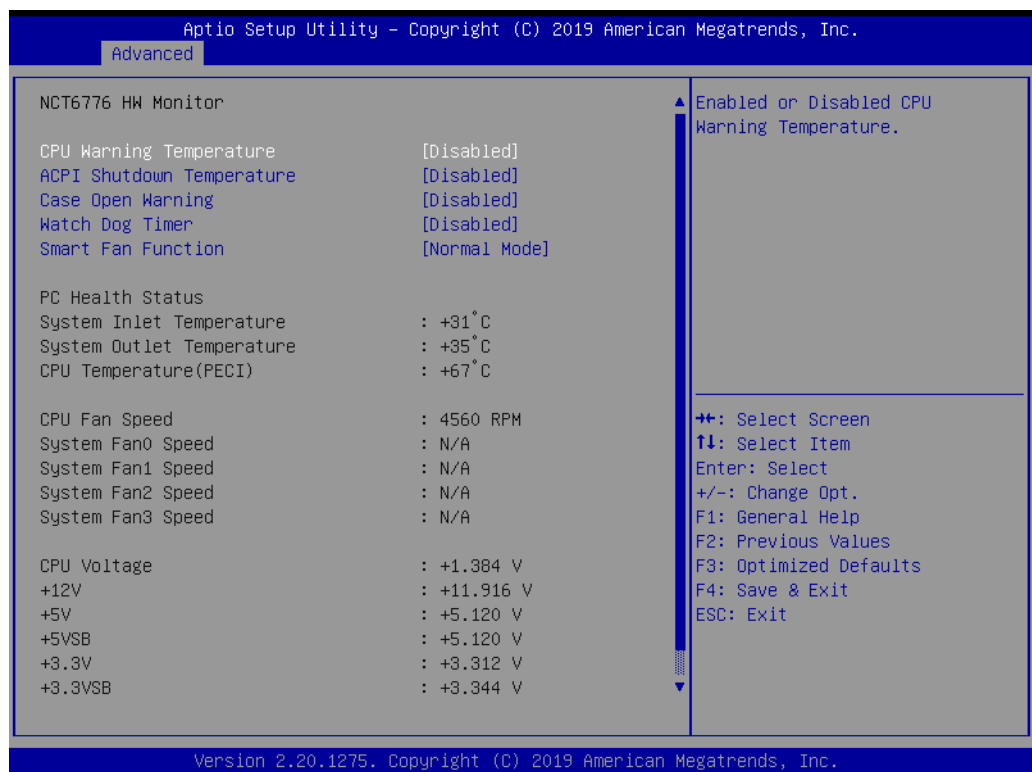
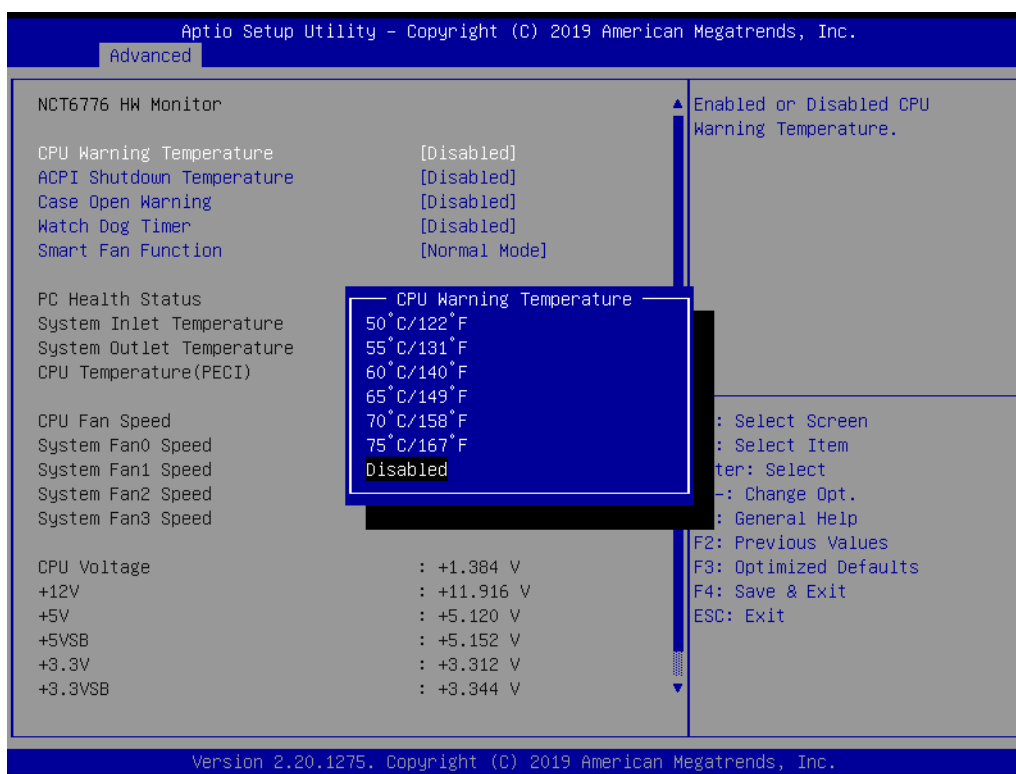

Figure 3.12 PC health status screen

■ CPU Warning Temperature

Use this to set the CPU warning temperature threshold. When the system reaches the warning temperature, the speaker will beep.



■ ACPI Shutdown Temperature

Use this to set the ACPI shutdown temperature threshold. When the system reaches the shutdown temperature, it will be automatically shut down by ACPI OS to protect the system from overheat damage.

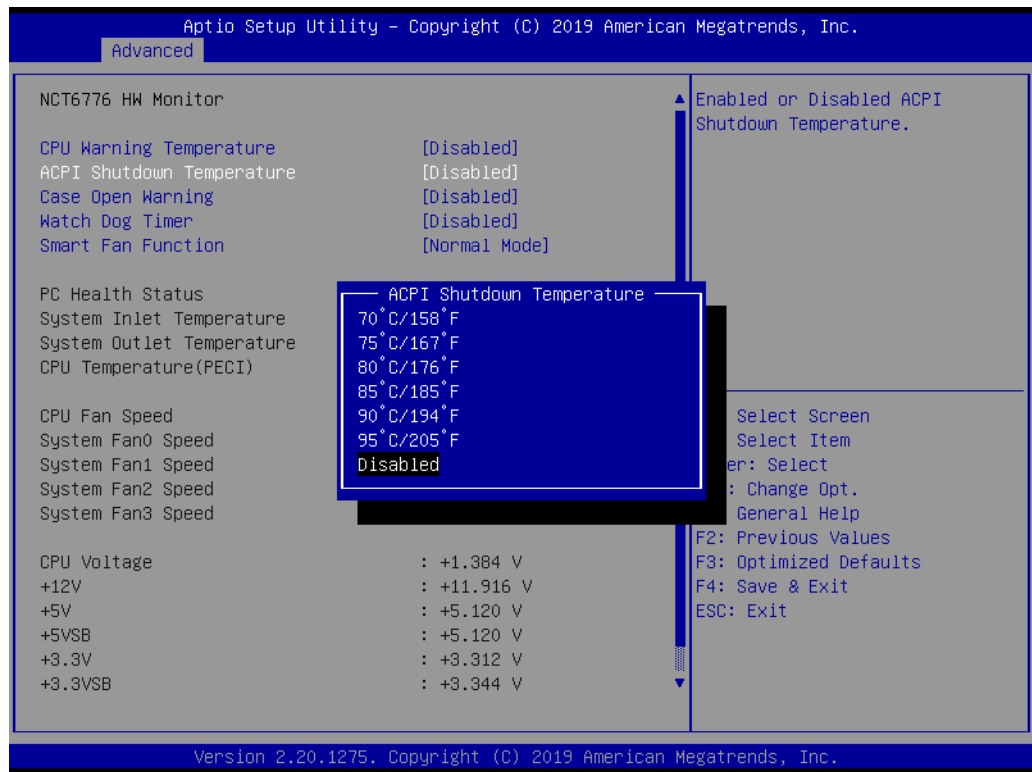

- **Case Open Warning**

Enable/Disable the chassis Intrusion monitoring function. When enabled and the case is opened, a warning message will show on the post screen. Make sure your board is paired with the chassis kit correctly to run this function.

- **Watch Dog Timer**

Enable/Disable Watch Dog Timer function.

- **Smart Fan Function**

ASMB-586 offers three different fan modes:

1. Normal Mode - Enable smart fan for normal system configuration.
2. Quiet Mode - Enable smart fan for quiet system with no expansion cards.
3. Disable - All fans run at full speed.

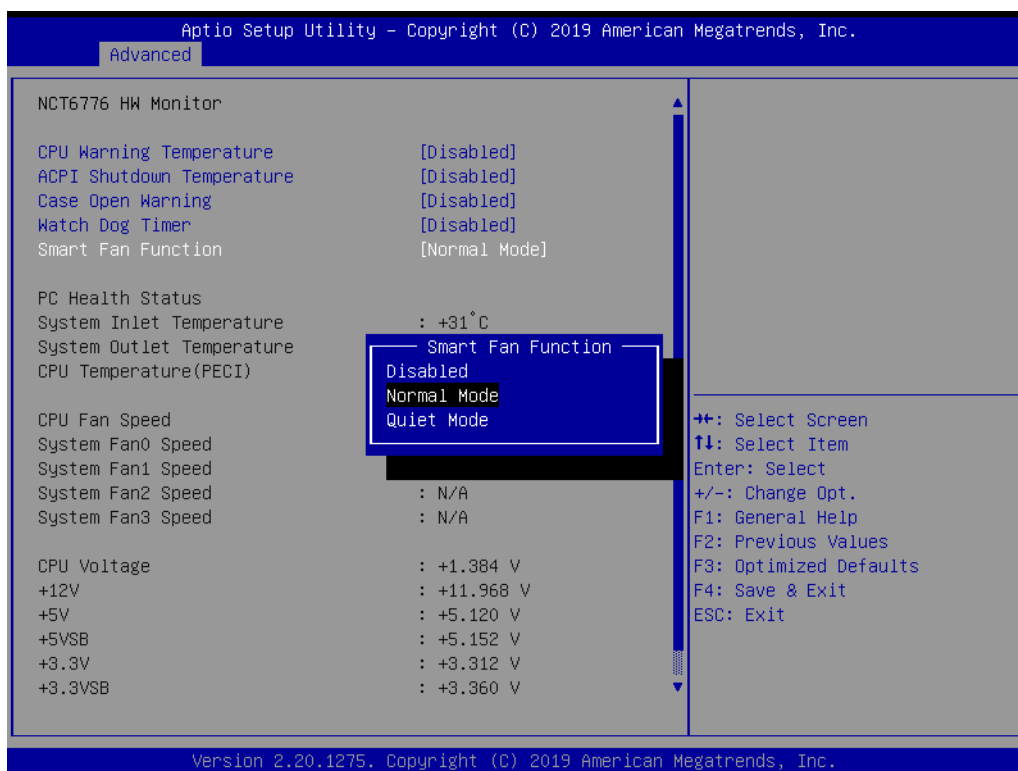

3.3.10 S5 RTC Wake Settings

- Wake system from S5**
 Enable or disable system wake on alarm event. When enabled, system will wake on the hr:min:sec specified.

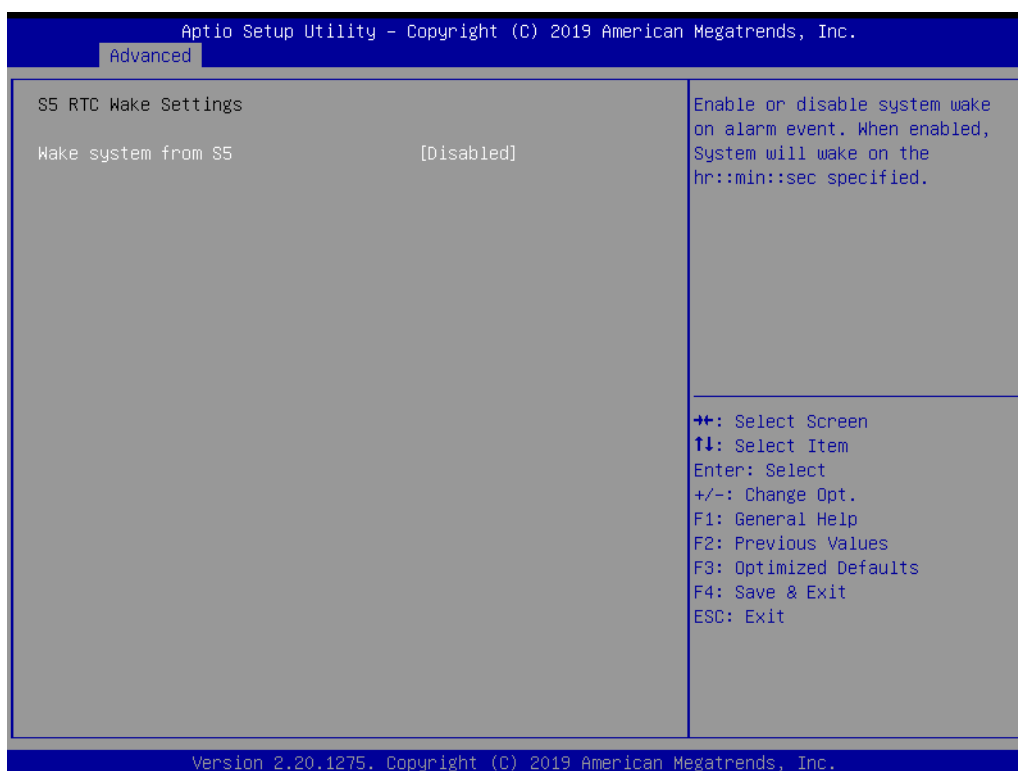

3.3.11 Serial Port Console Redirection

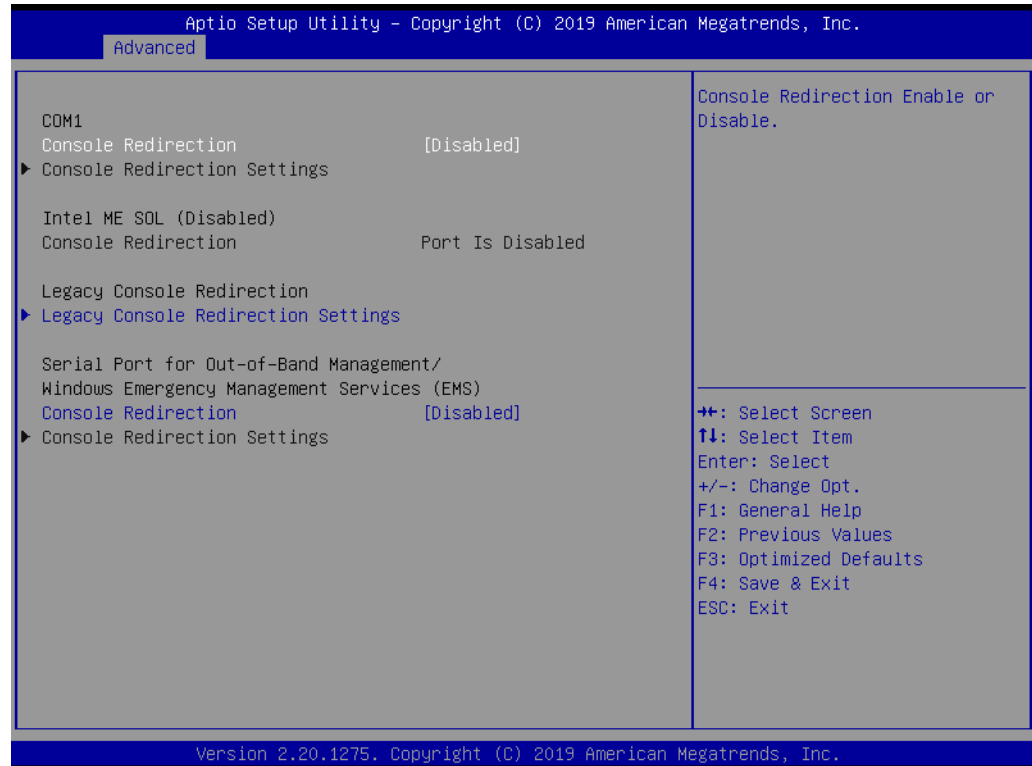
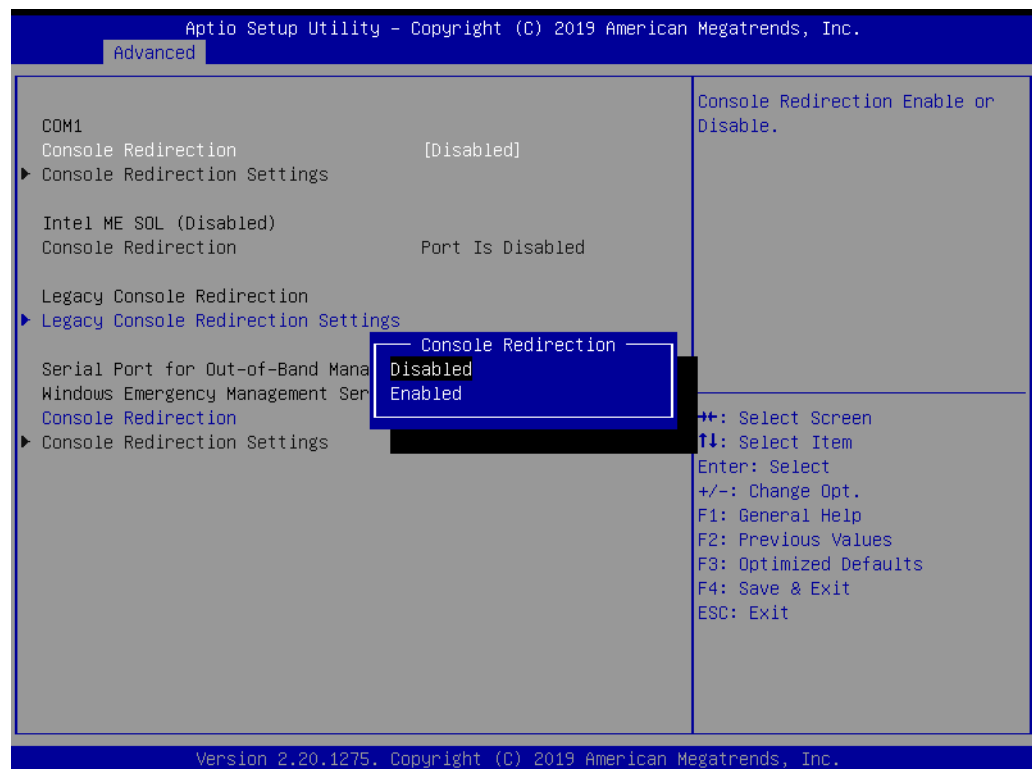
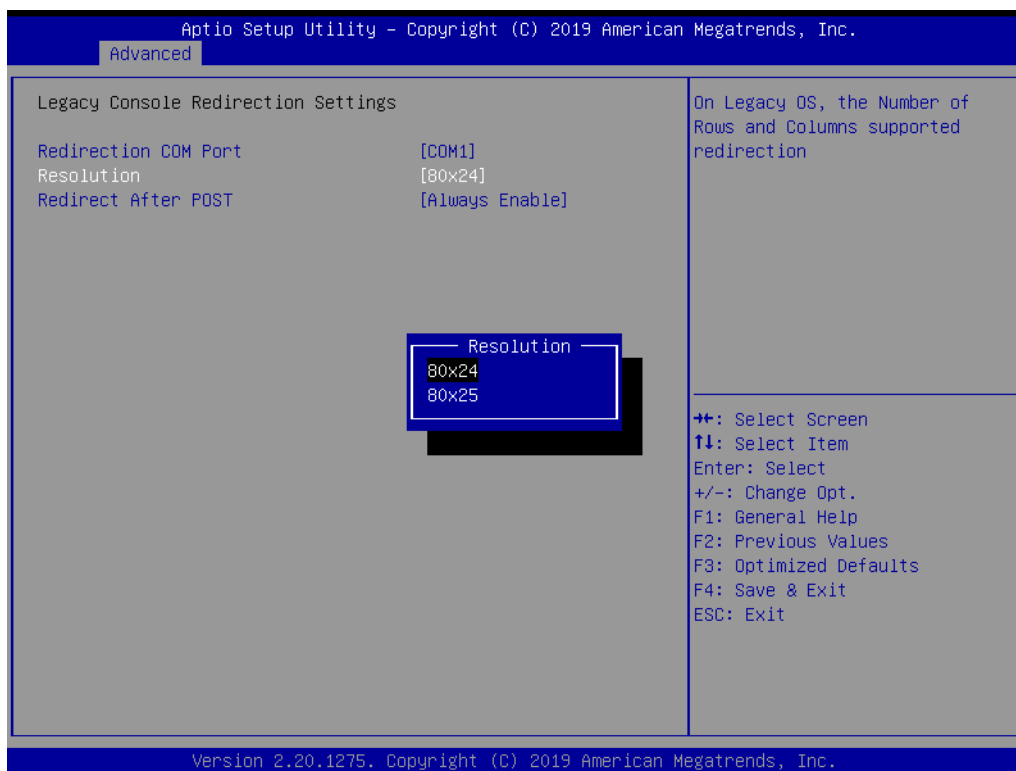
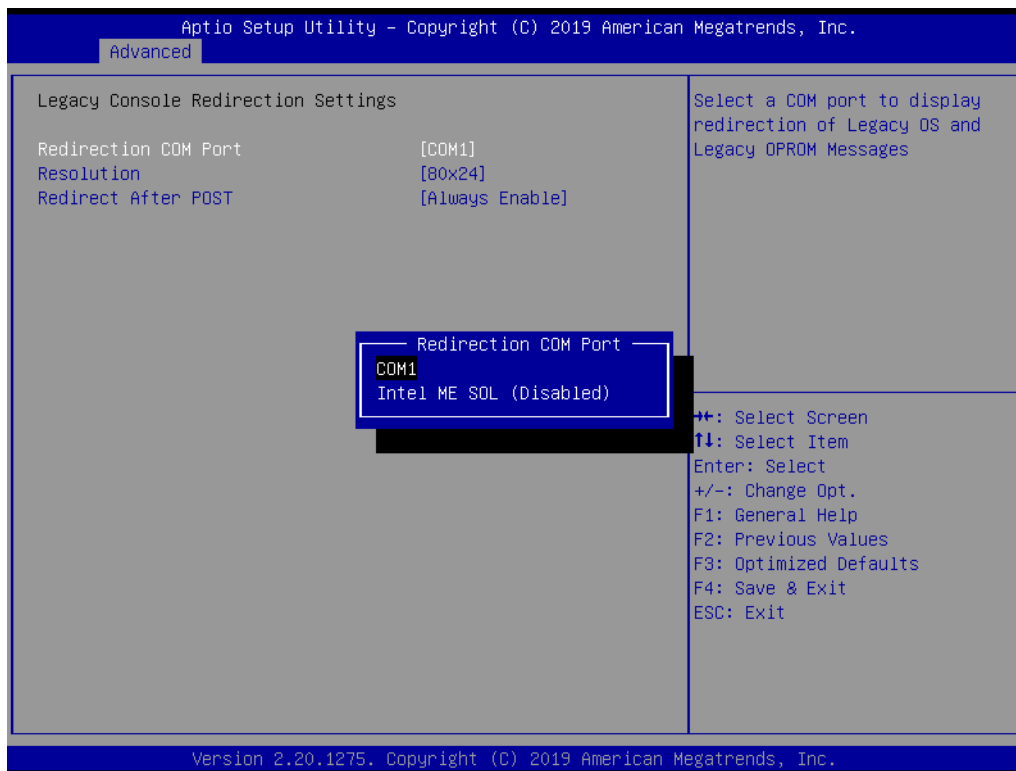

Figure 3.13 Serial port console redirection screen

- **Console Redirection**
Enable or disable the console redirection feature.



Legacy Console Redirection Settings



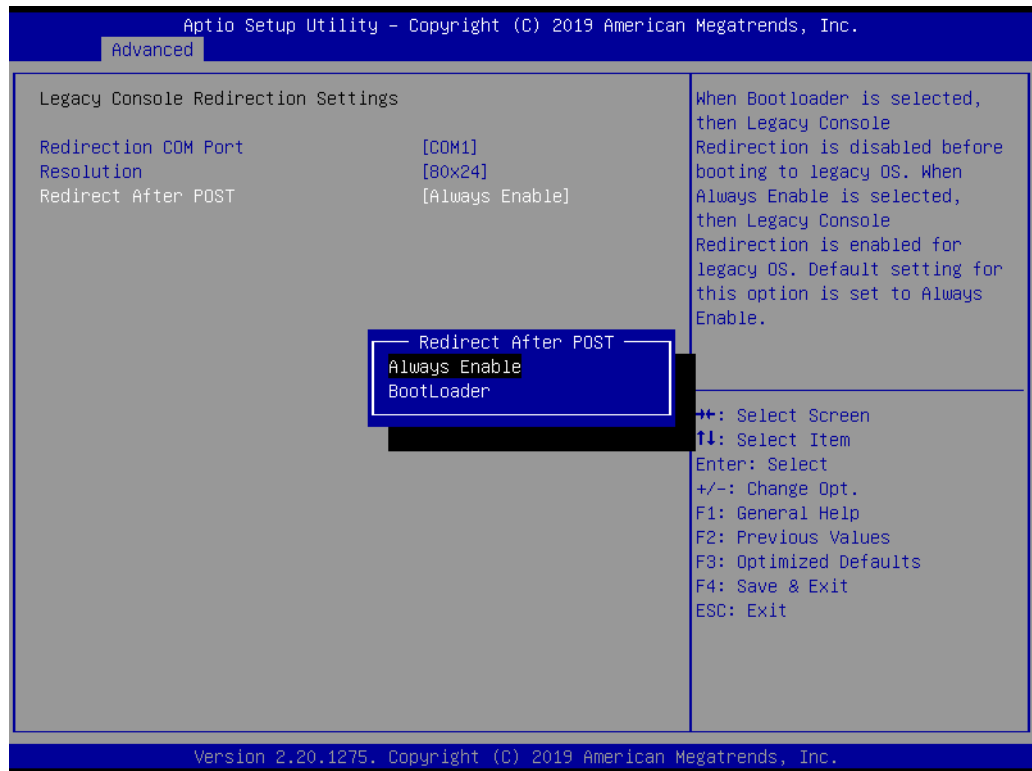

- Redirection COM Port
Select a COM port to display redirection of Legacy OS and Legacy OPROM Messages.
- Resolution
On Legacy OS, the Number of Rows and Columns supported redirection.
- Redirect After POST
When 'Bootloader' is selected, then Legacy Console Redirection is disabled before booting to legacy OS. When 'Always Enable' is selected, then Legacy Console Redirection is enabled for legacy OS.

3.3.12 Intel TXT Information

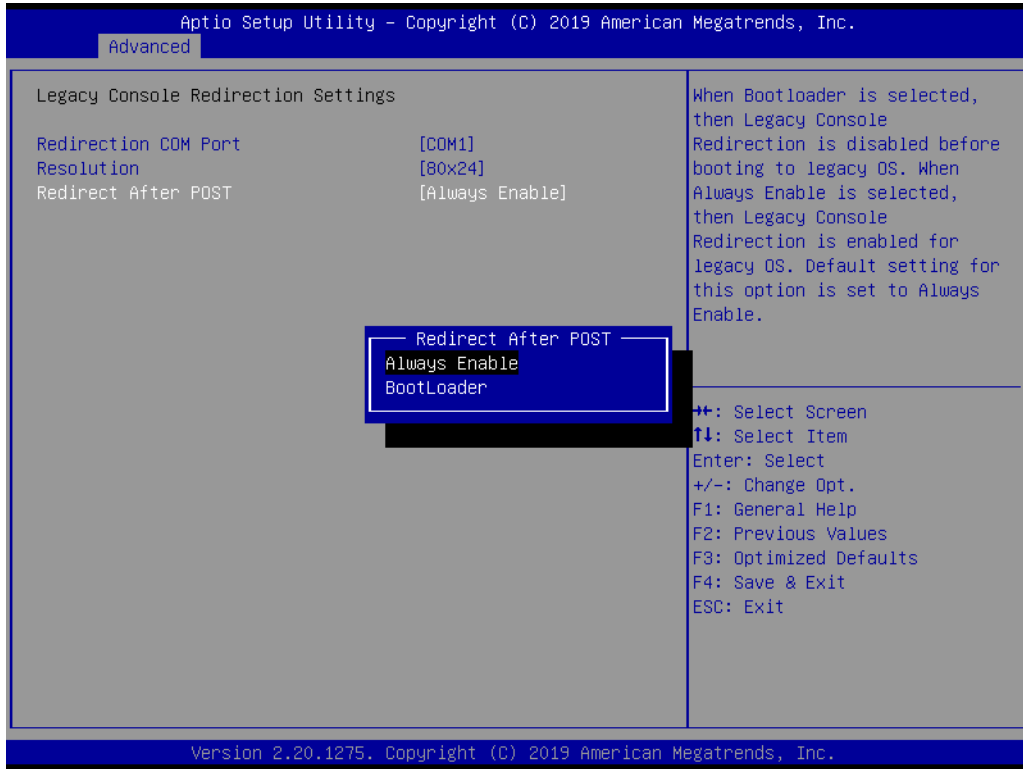

Figure 3.14 Intel TXT information screen

3.3.13 PCA-COM232/COM485 Super IO Configuration

Note! (This item only shows when a PCA COM module is installed)

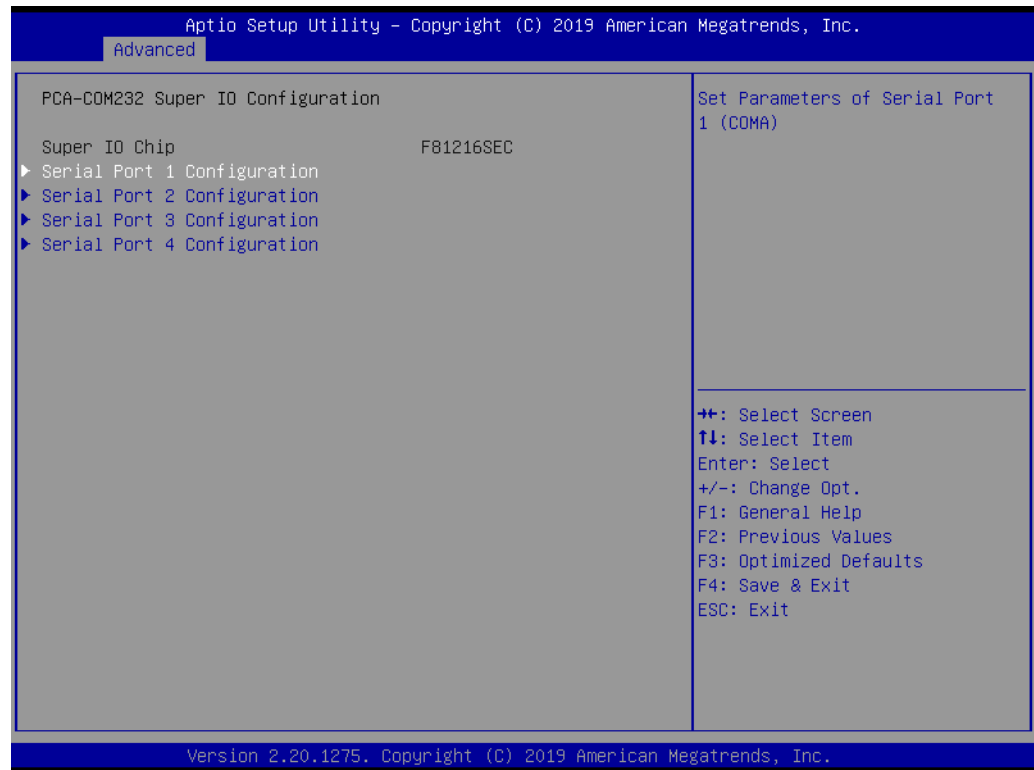
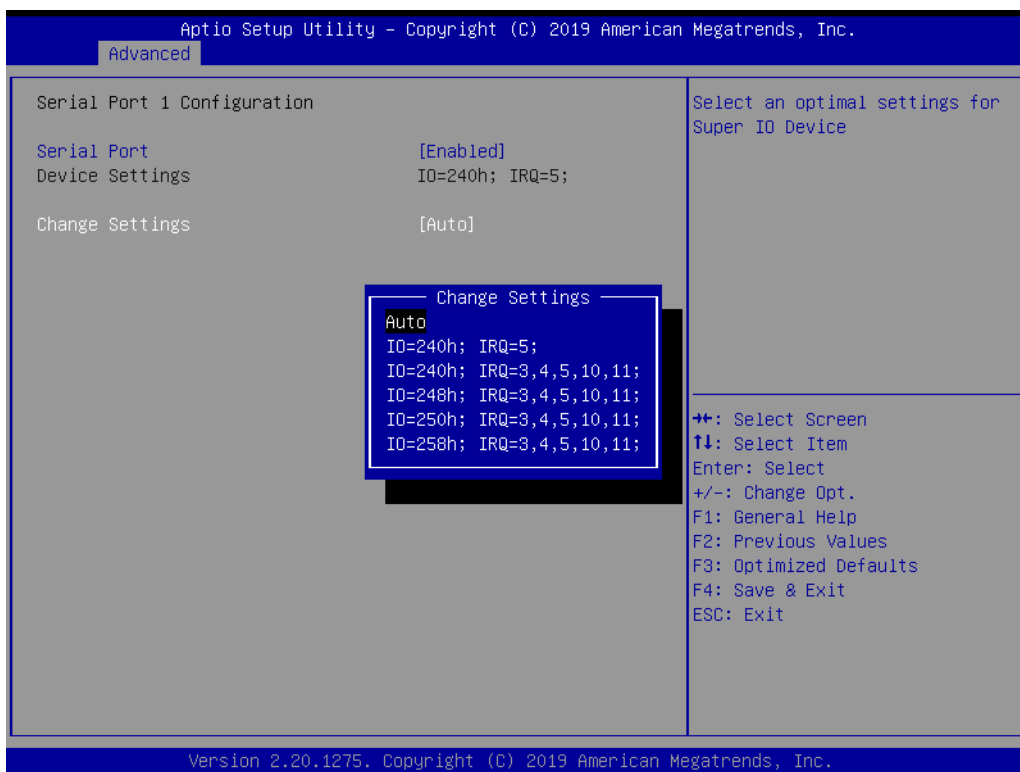
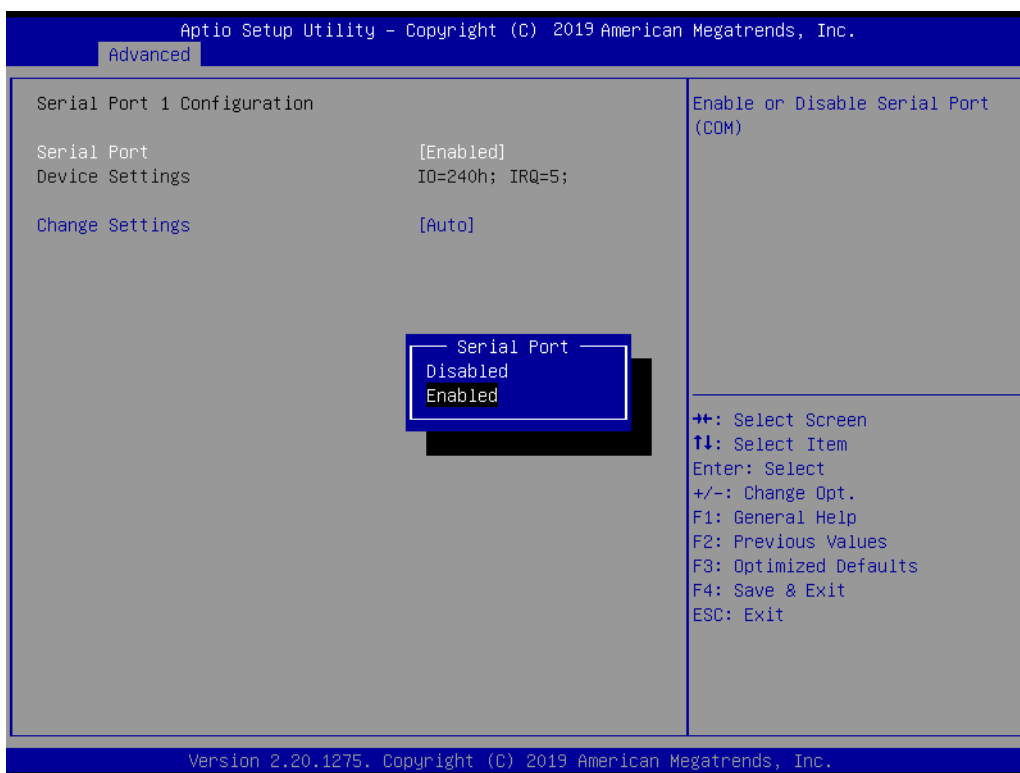

Figure 3.15 Optional PCA-COM configuration screen

ASMB-586 offers extra four COM ports through LPC connector. You need to purchase "PCA-COM232-00A1E" or "PCA-COM485-00A1E" then install it in the LPC connector.



Serial Port 1 Configuration

- **Serial Port**
Enable or Disable Serial Port 1.
- **Change Settings**
Select resource allocation for Serial Port 1.

Serial Port 2 Configuration

- **Serial Port**
Enable or Disable Serial Port 2.
- **Change Settings**
Select resource allocation for Serial Port 2.

Serial Port 3 Configuration

- **Serial Port**
Enable or Disable Serial Port 3.
- **Change Settings**
Select resource allocation for Serial Port 3.

Serial Port 4 Configuration

- **Serial Port**
Enable or Disable Serial Port 4.
- **Change Settings**
Select resource allocation for Serial Port 4.

3.3.14 USB Configuration

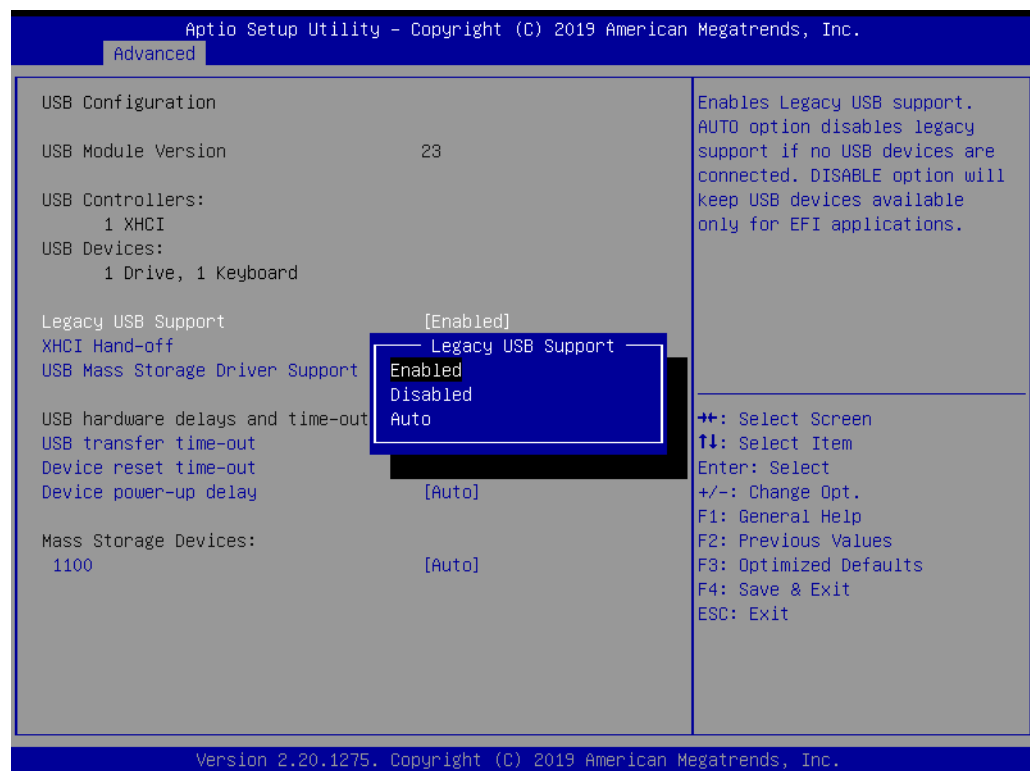
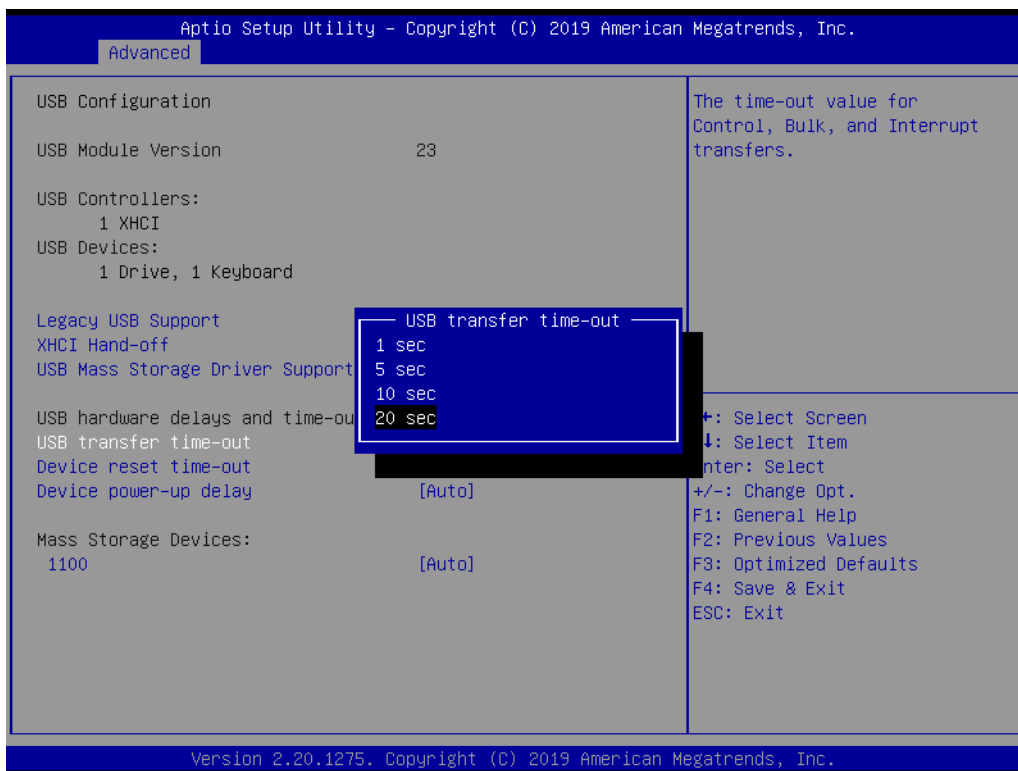

Figure 3.16 USB configuration screen

- **Legacy USB Support**
Enable or disable legacy USB support. 'Auto' option disables legacy support if no USB devices are connected. 'Disable' option will keep USB devices available only for EFI applications. This option is valid after BIOS is set to Legacy from the default UEFI mode.

- **XHCI Hand-off**
This is a workaround for OS without XHCI hand-off support. The XHCI ownership change should be claimed by XHCI driver.
- **USB Mass Storage Driver Support**
Enable or disable USB Mass Storage Driver Support.
- **USB transfer time-out**
The time-out value for Control, Bulk, and Interrupt transfers.



- **Device reset time-out**
USB mass storage device Start Unit command time-out.

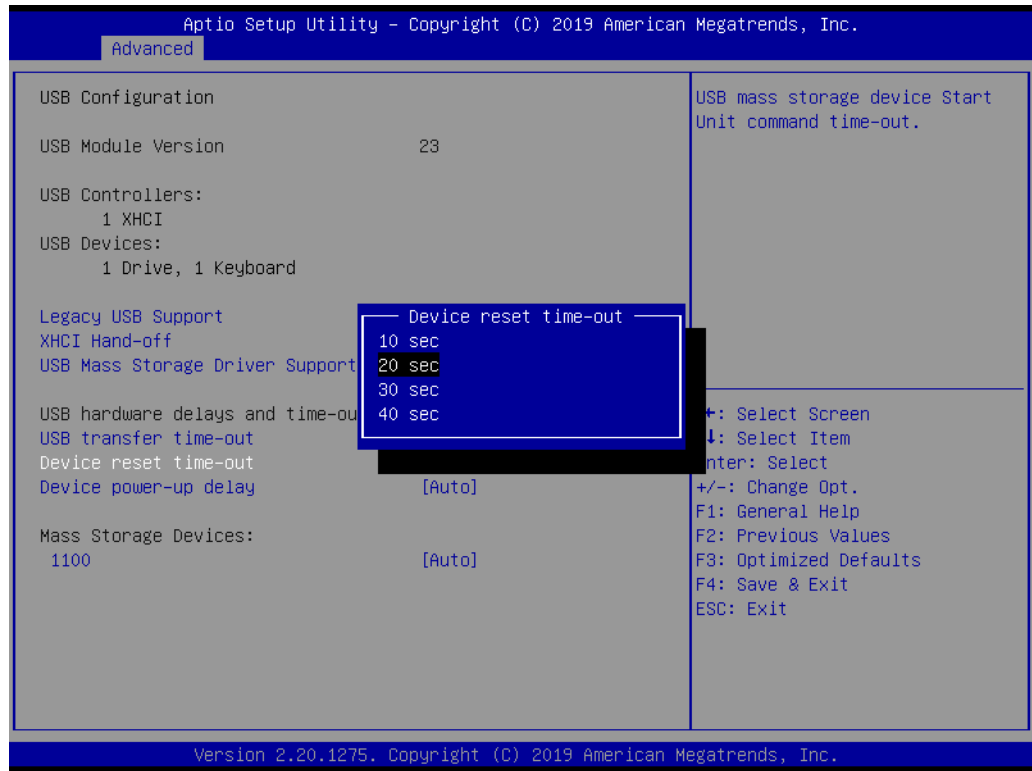

- **Device power-up delay**
Maximum time the device will take before it properly reports itself to the Host Controller. 'Auto' uses default value: for a Root port it is 100 ms, for a Hub port the delay is taken from Hub descriptor.

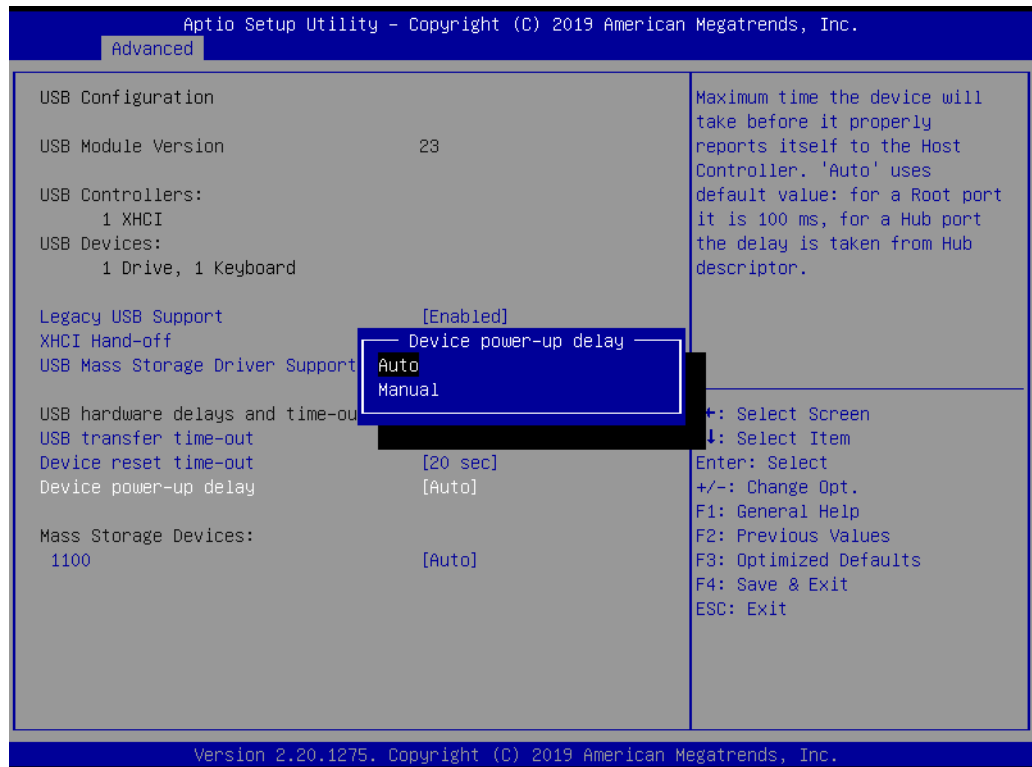

■ Mass Storage Devices

Mass storage device emulation type. 'Auto' enumerates devices according to their media format. Optical drives are emulated as 'CDROM', drives with no media will be emulated according to a drive type.

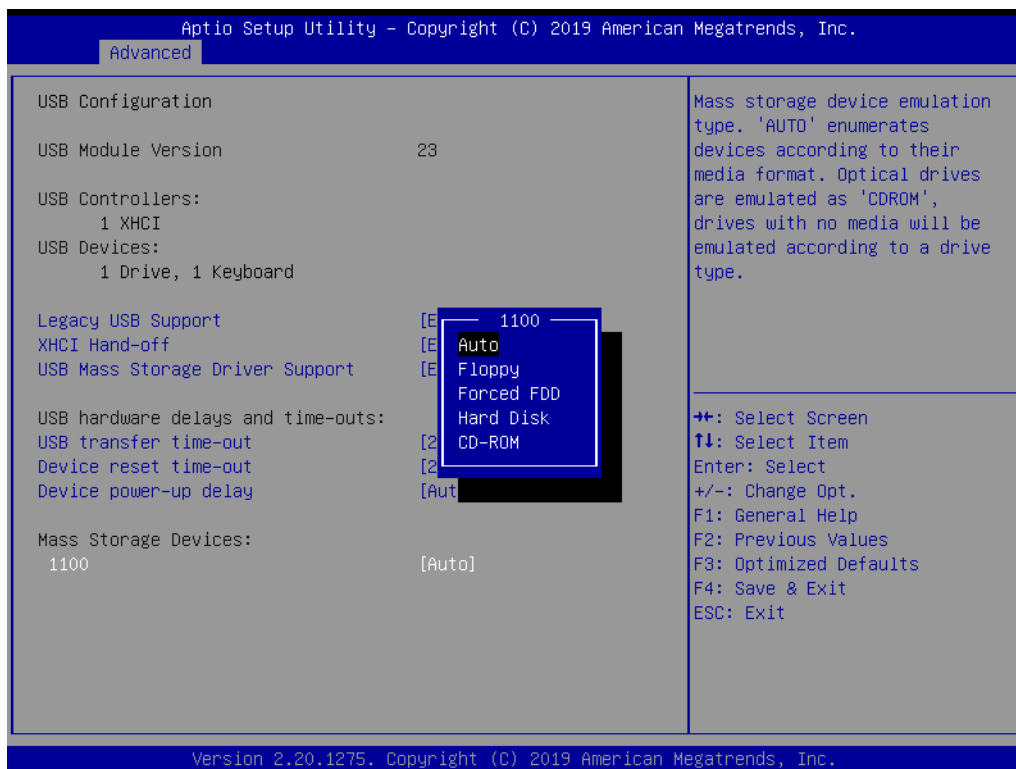

3.3.15 CSM Configuration

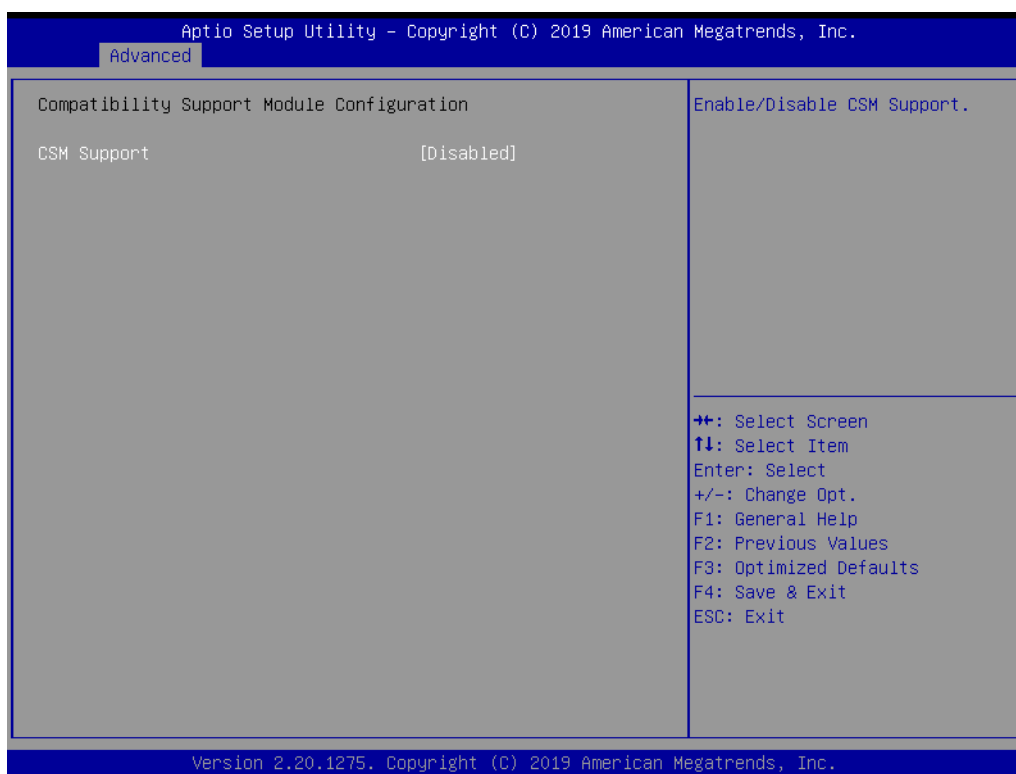
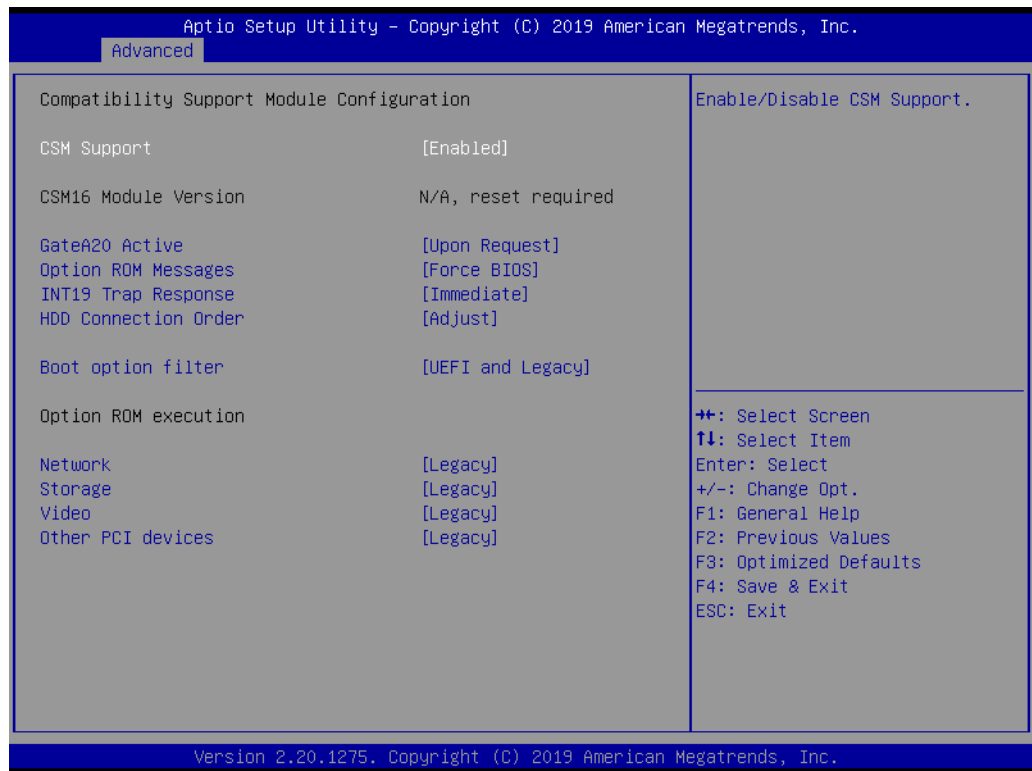
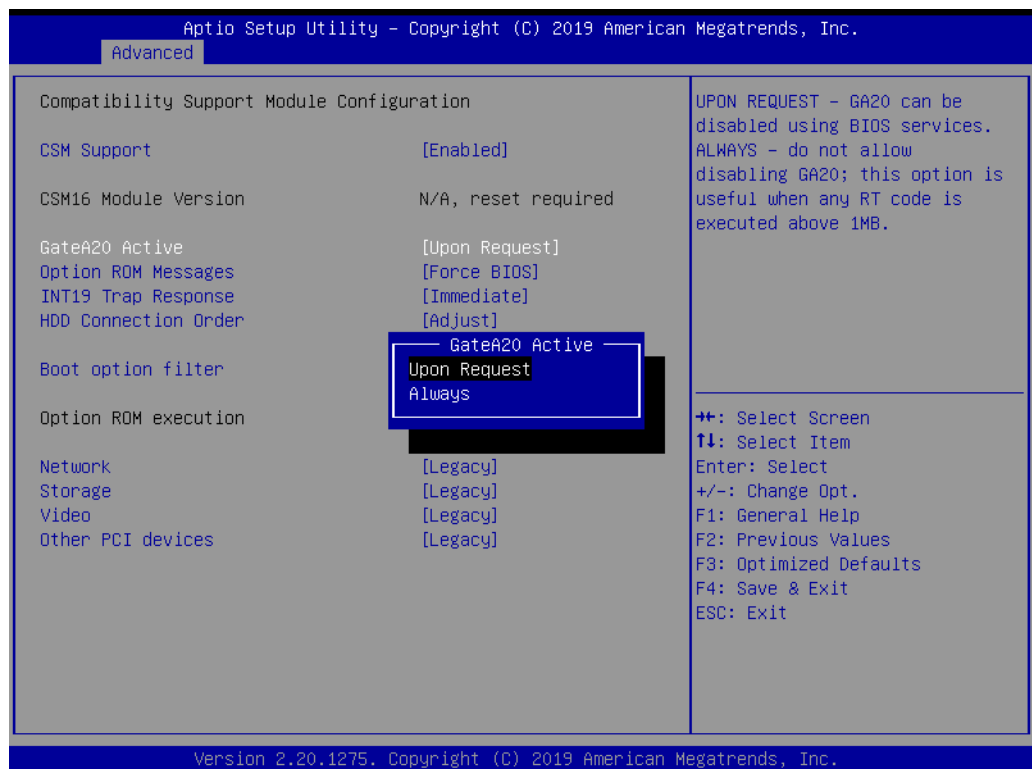

Figure 3.17 CSM configuration screen



- **CSM Support**
Enable or disable CSM (Compatibility Support Module) configuration support. When disabled, the system can only support UEFI mode.
- **GateA20 Active**
This items is useful when RT code is executed above 1MB. When it's set as 'Upon Request', GA20 can be disabled using BIOS services. When it's set as 'Always', it does not allow disabling of GA20.



■ Option ROM Messages

'Force BIOS' or 'Keep Current' to set the display mode for Option ROM.

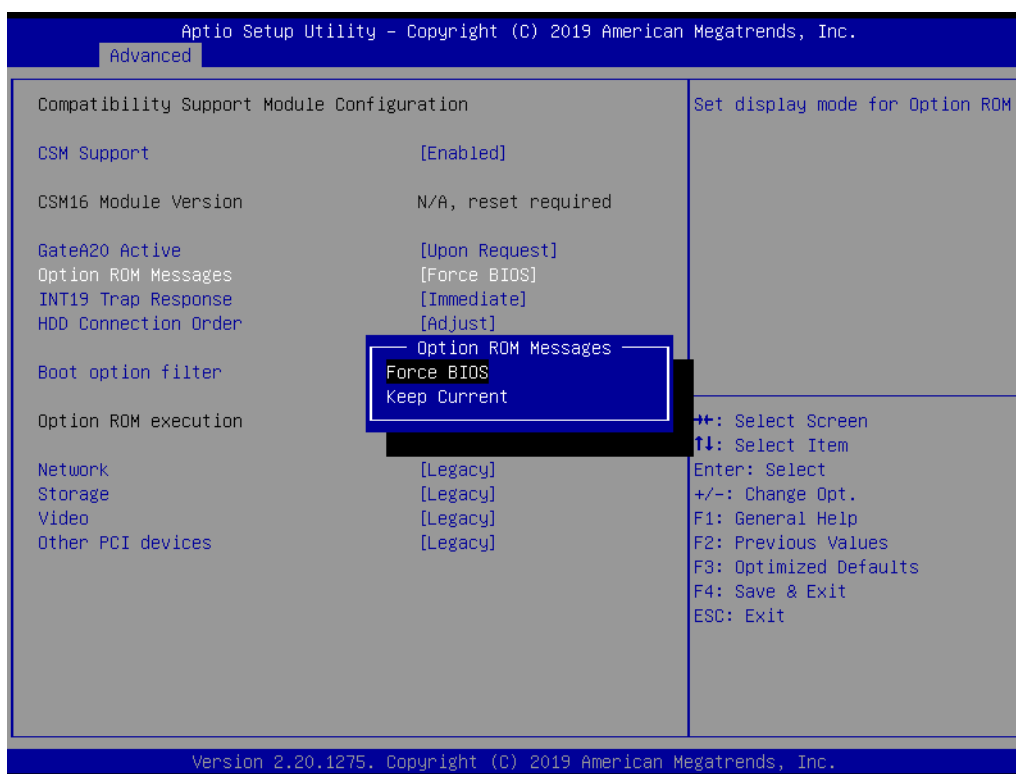

■ INT19 Trap Response

BIOS reaction on INT19 trapping by Option ROM. When it's set as 'Immediate', the trap will be executed right away. When it's set as 'Postponed', the trap will be executed during legacy boot.

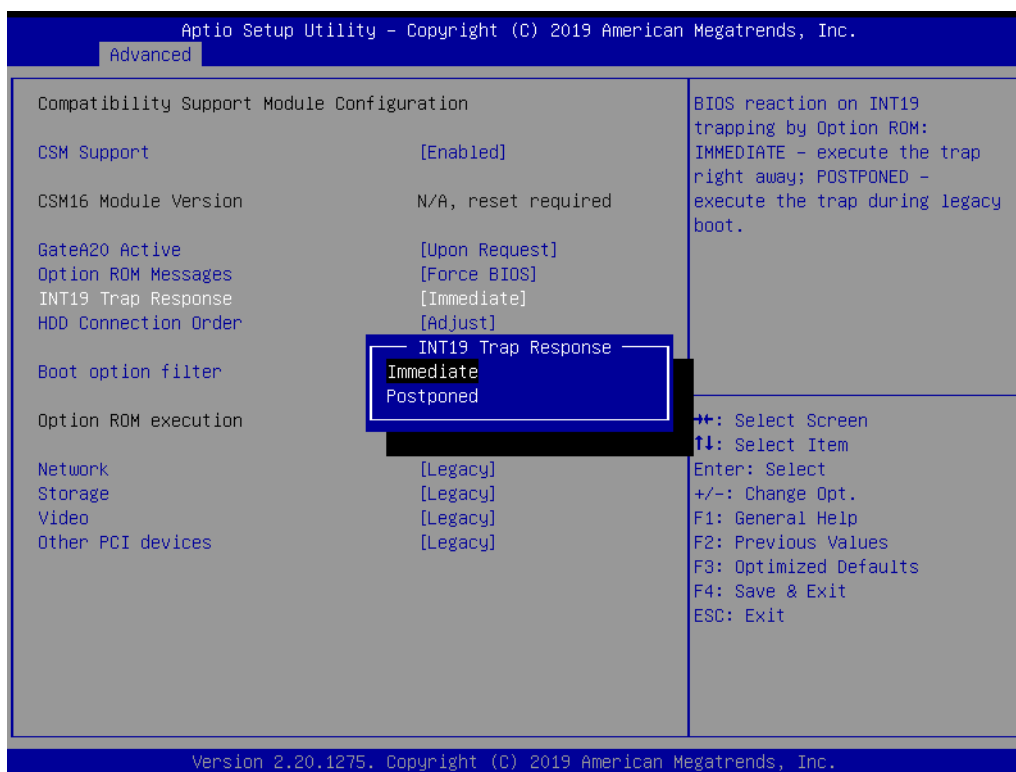

- **HDD Connection Order**
Some OS require HDD handles to be adjusted.

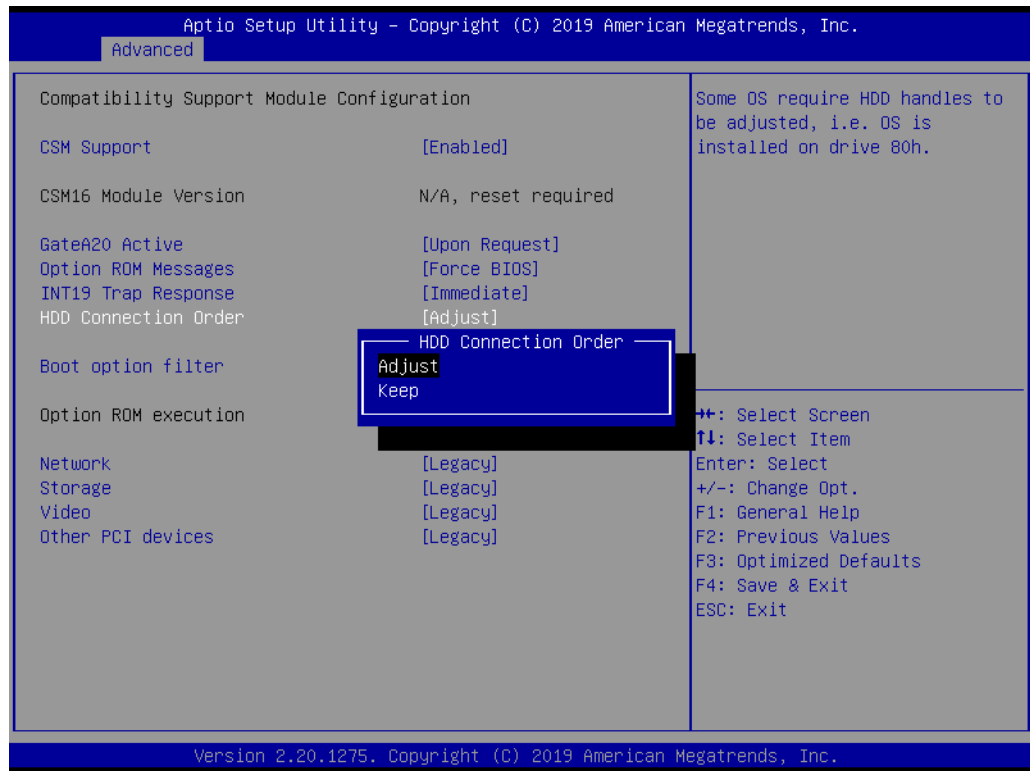

- **Boot option filter**
This option controls Legacy/UEFI ROMs priority.

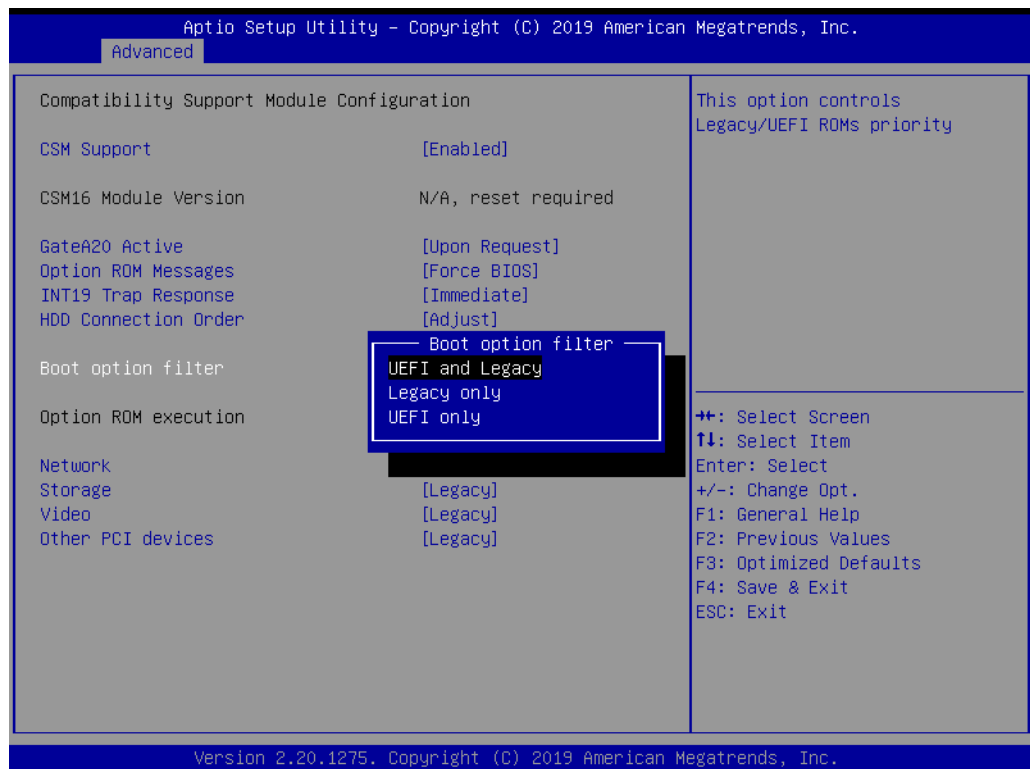

- **Option ROM execution**
- **Network**
Controls the execution of UEFI and Legacy PXE OpROM.

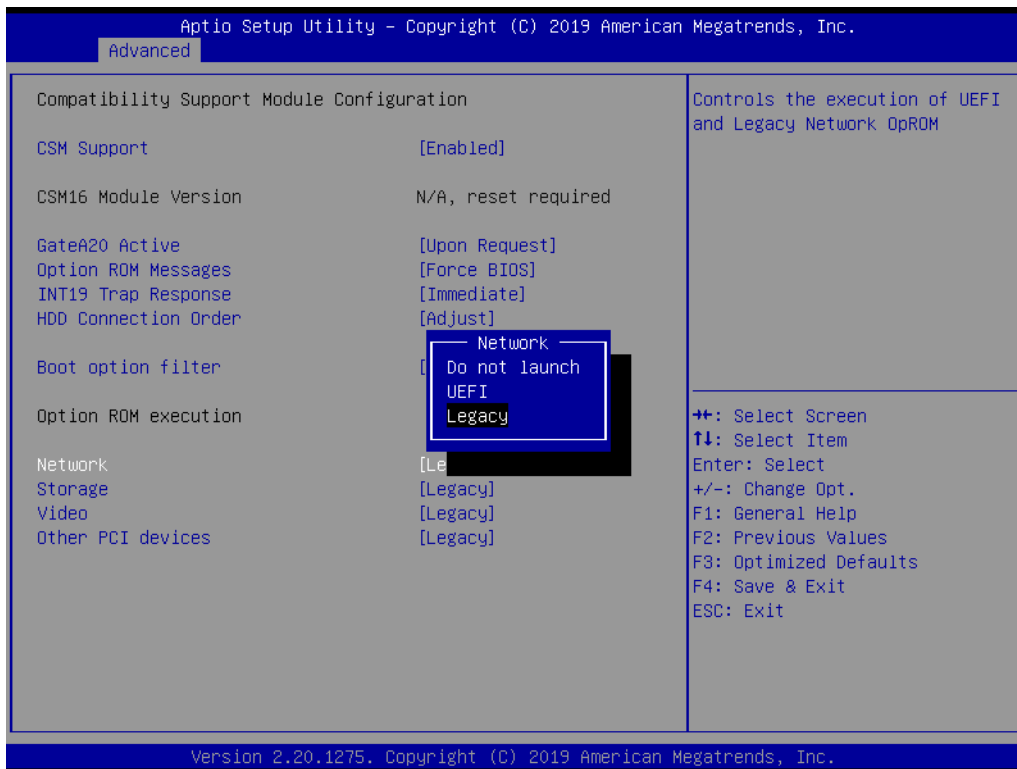

- **Storage**
Controls the execution of UEFI and Legacy Storage OpROM.

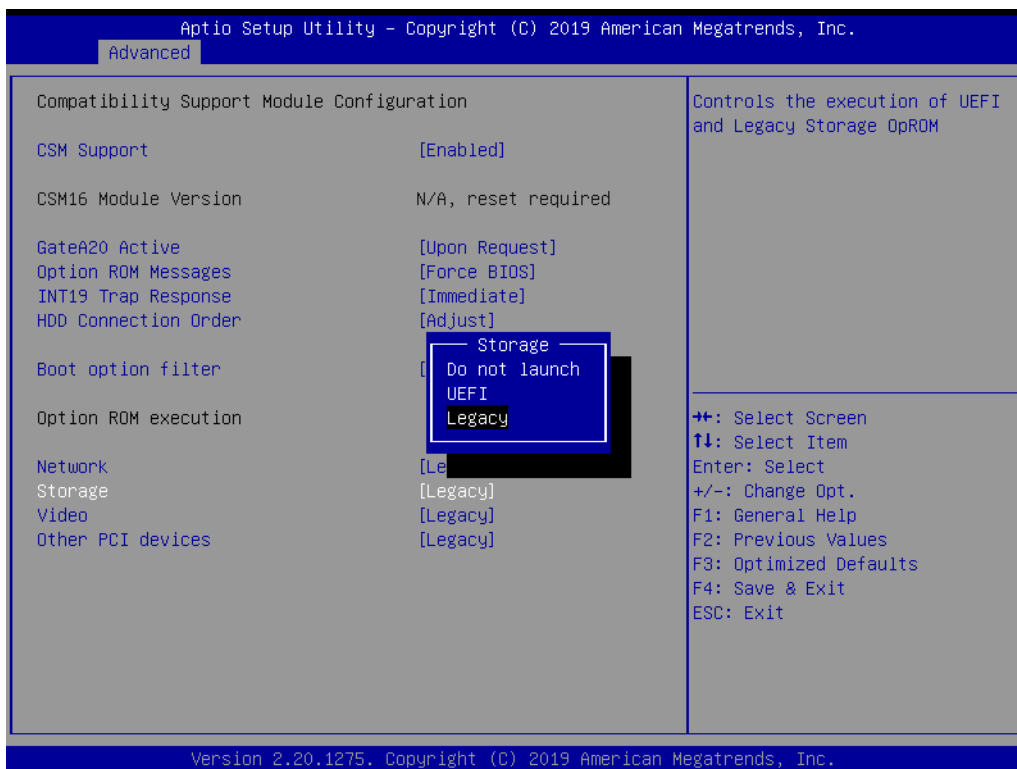

■ **Video**

Controls the execution of UEFI and Legacy Video OpROM.

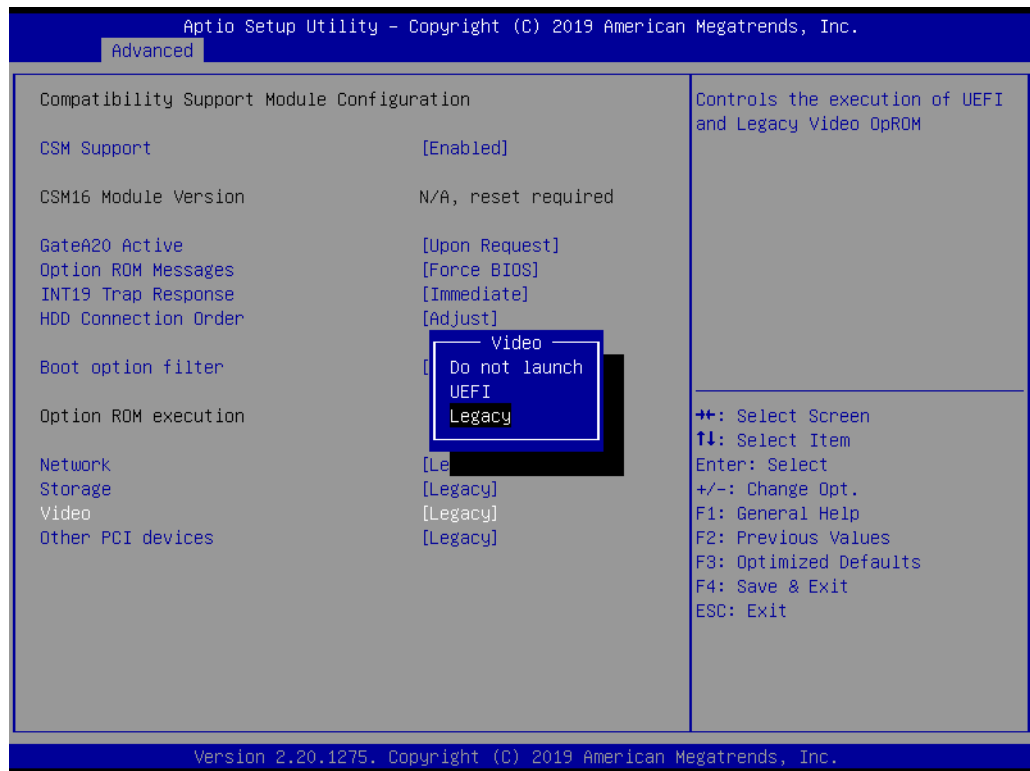

■ **Other PCI devices**

Determines execution of OpROM policy for devices other than Network, Storage or Video.

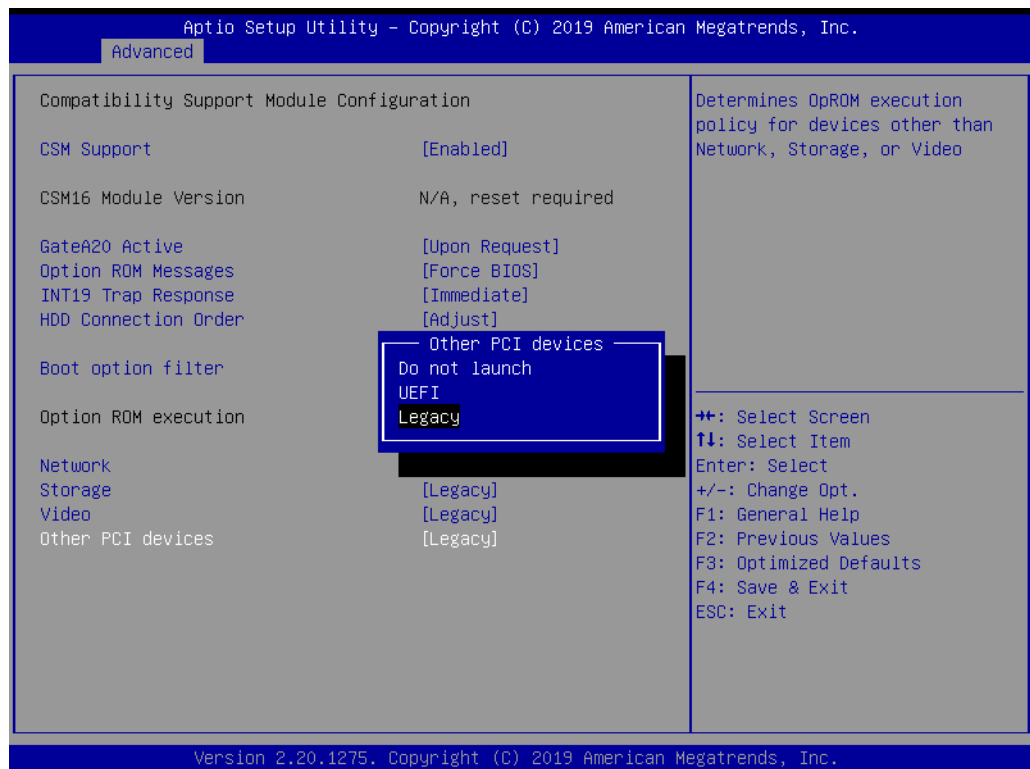

3.3.16 UEFI Network Stack Configuration

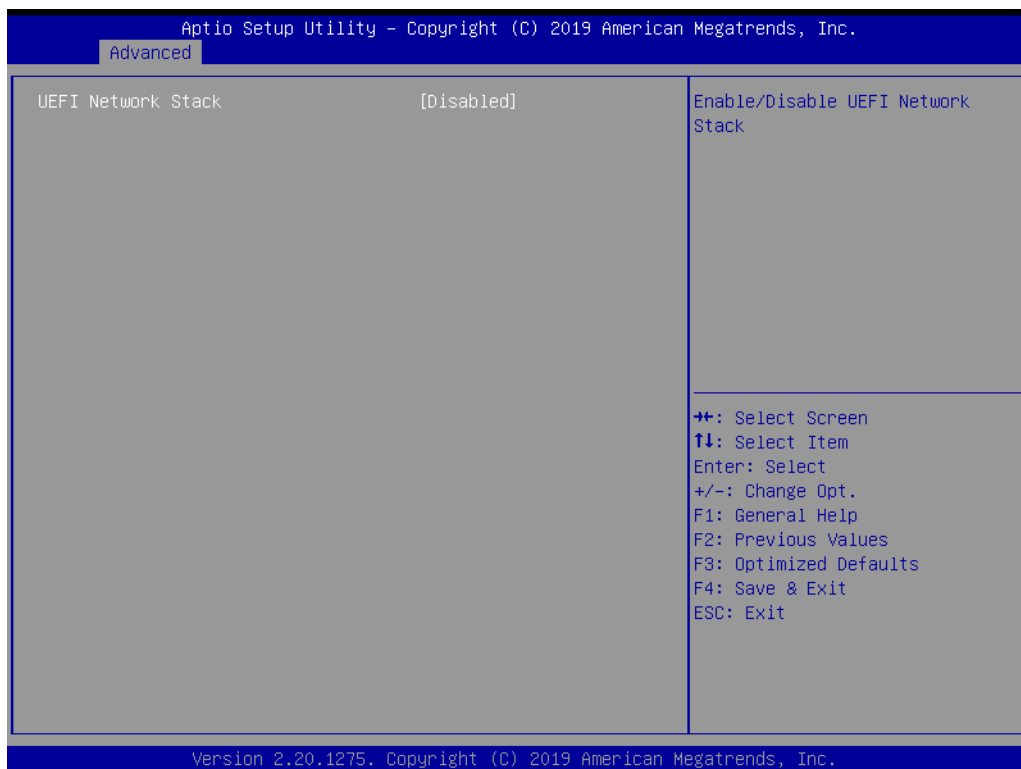
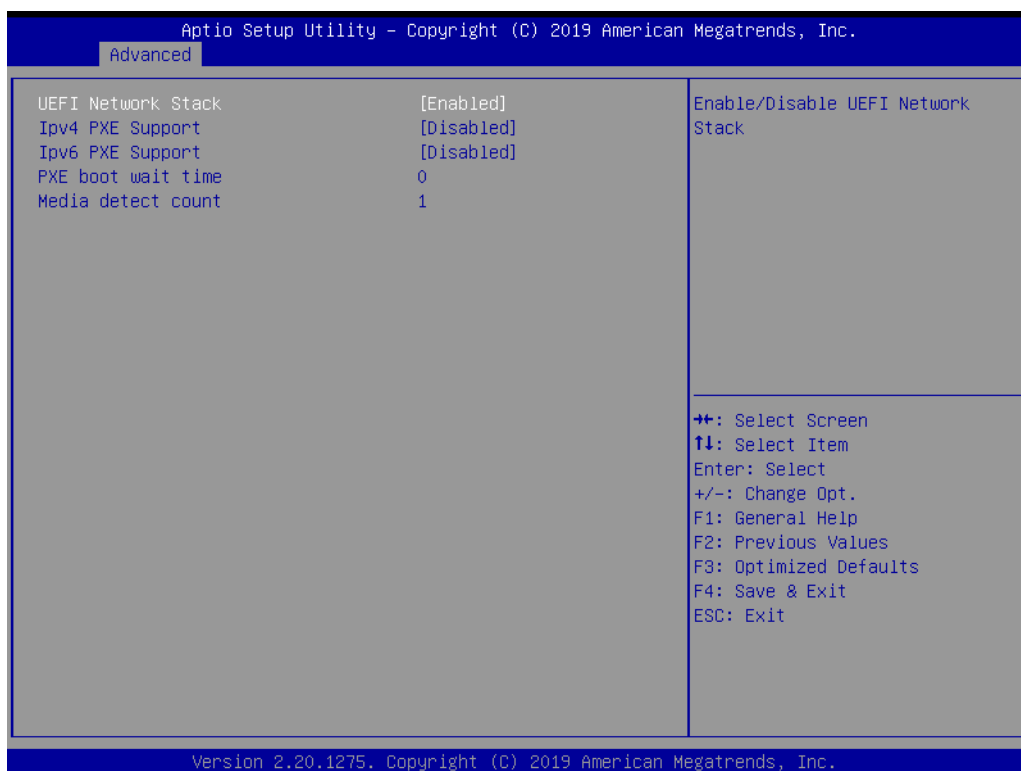

Figure 3.18 UEFI network stack configuration screen



- **UEFI Network Stack**
Enable or Disable UEFI Network Stack.
- **IPv4/IPv6 PXE Support**
Enable or Disable IPv4/IPv6 PXE boot support. If disabled, IPv4/IPv6 PXE boot support will not be available.

- **PXE boot wait time**
Wait time in seconds to press ESC key to abort the PXE boot.
- **Media detect count**
Number of times the presence of media will be checked.

3.4 Chipset

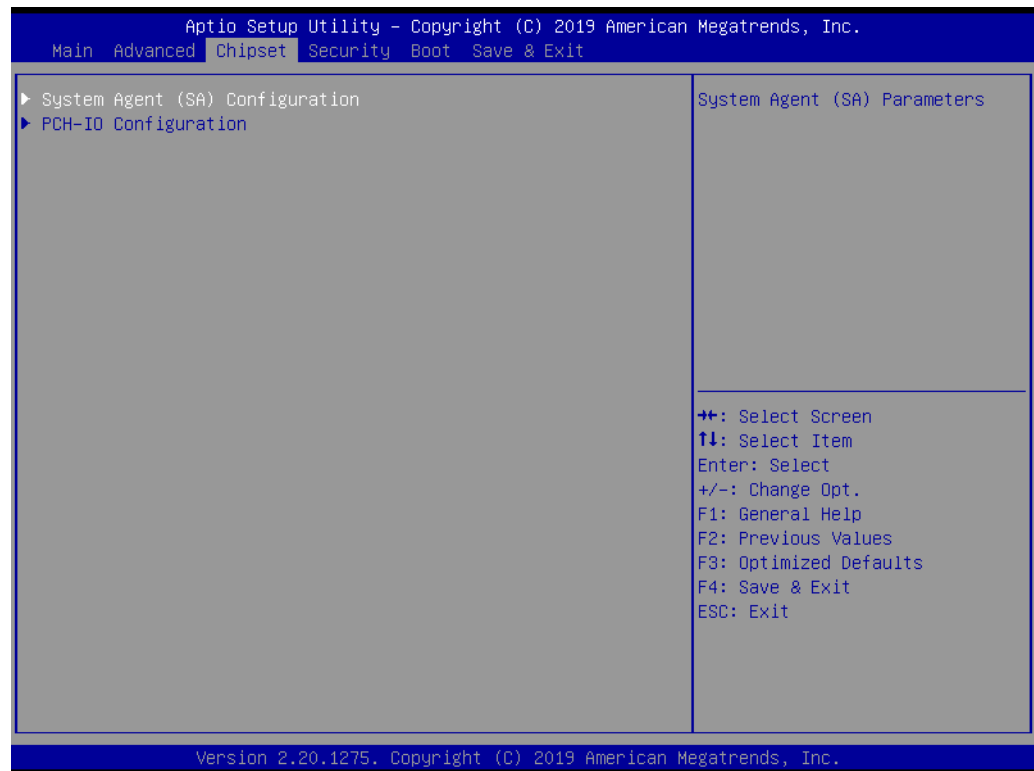

Figure 3.19 Chipset screen

3.4.1 System Agent (SA) Configuration

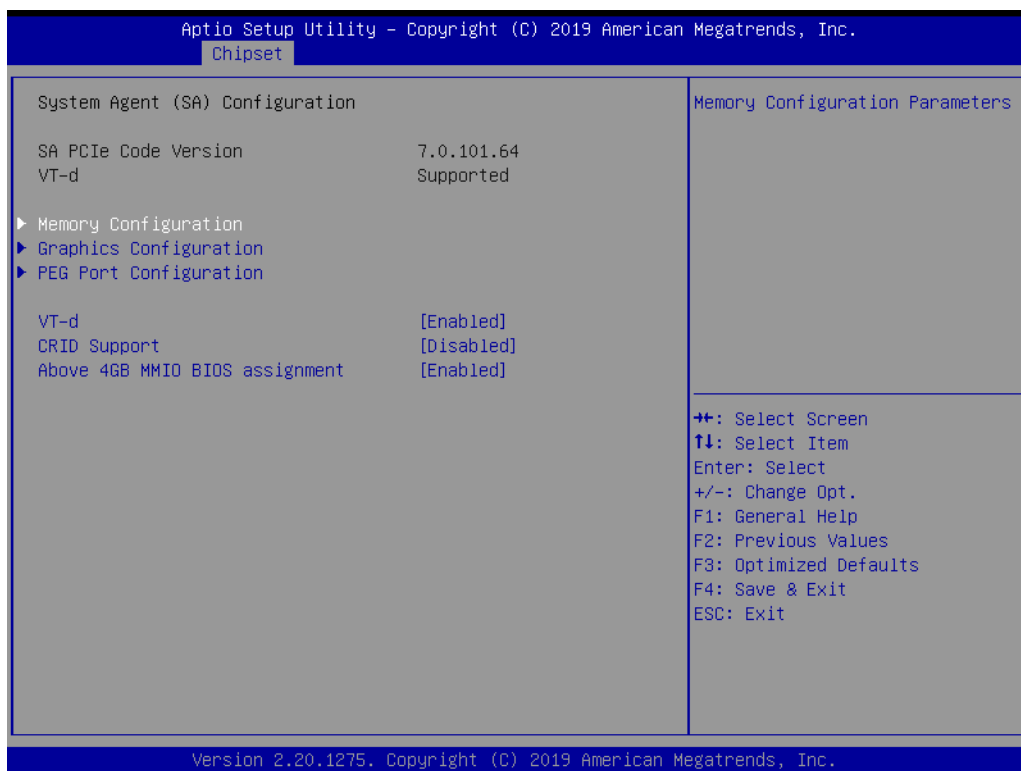
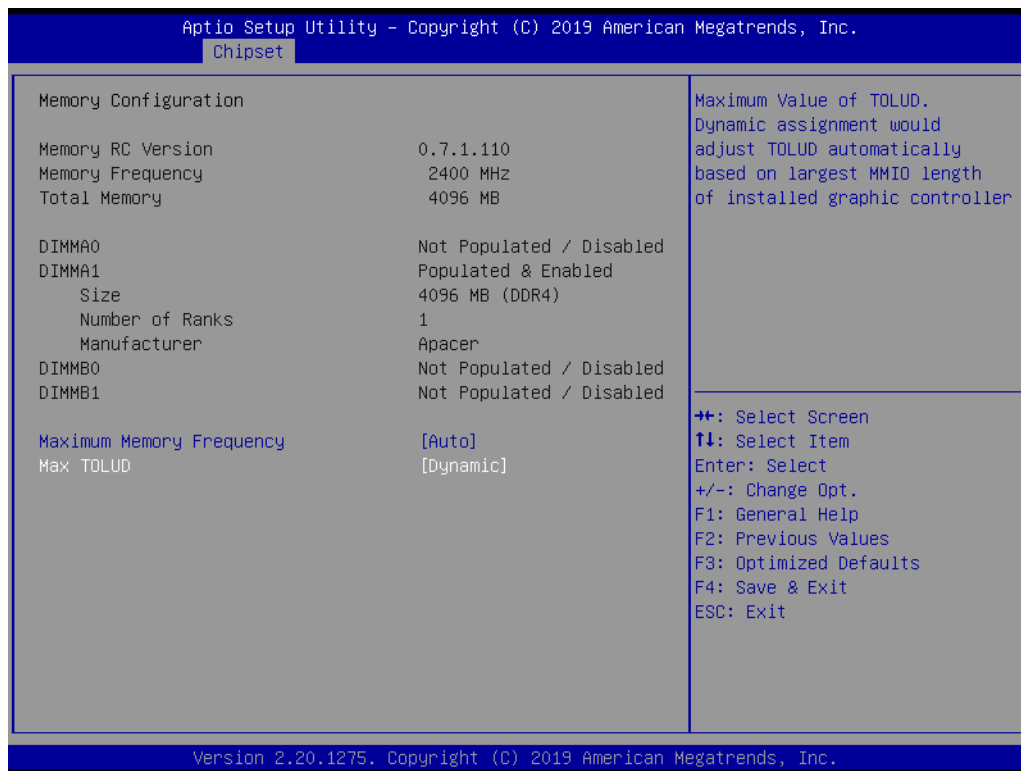

Figure 3.20 System agent (SA) configuration screen

- **VT-d**
Enable or disable VT-d function on MCH.
- **CRID Support**
Enable or disable CRID control for the Intel® Stable Image Platform Program (SIPP).
- **Above 4G MMIO BIOS assignment**
Enable or disable above 4GB Memory Mapped IO BIOS assignment.
This is disabled automatically when the size is set to 2048MB.
Please set "Disabled" when installing VMWare under CSM Disabled.

3.4.1.1 Memory Configuration



- **Maximum Memory Frequency**
Maximum Memory Frequency selections in Mhz. Valid values should match the refclk, e.g, divide by 133 or 100.
- **Max TOLUD**
Maximum Value of TOLUD. Dynamic assignment would adjust TOLUD automatically based on largest MMIO length of installed add-on cards.

3.4.1.2 Graphics Configuration



■ Primary Display

Select Auto/IGFX/PEG/PCI Graphics device as primary display.

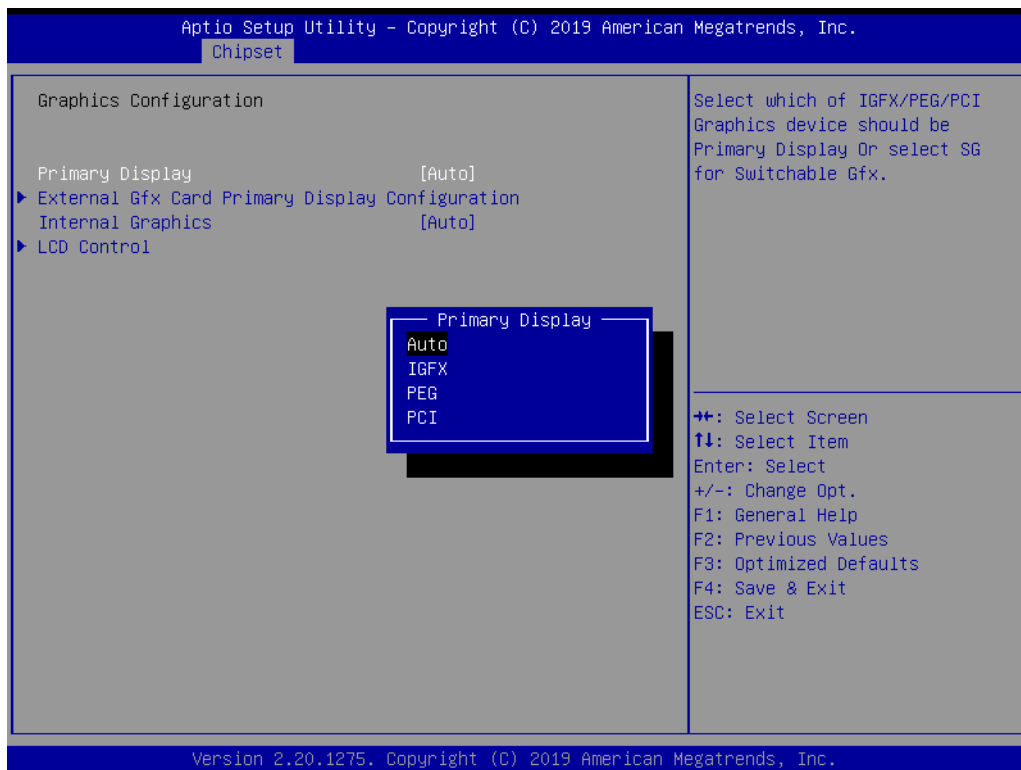

■ External Gfx Card Primary Display Configuration

Select PEG0/PEG1/PEG2/PEG3 Graphics device as Primary PEG. This option is unnecessary to change since ASMB-586 only has one PCIe Slot-6 for external Gfx card.

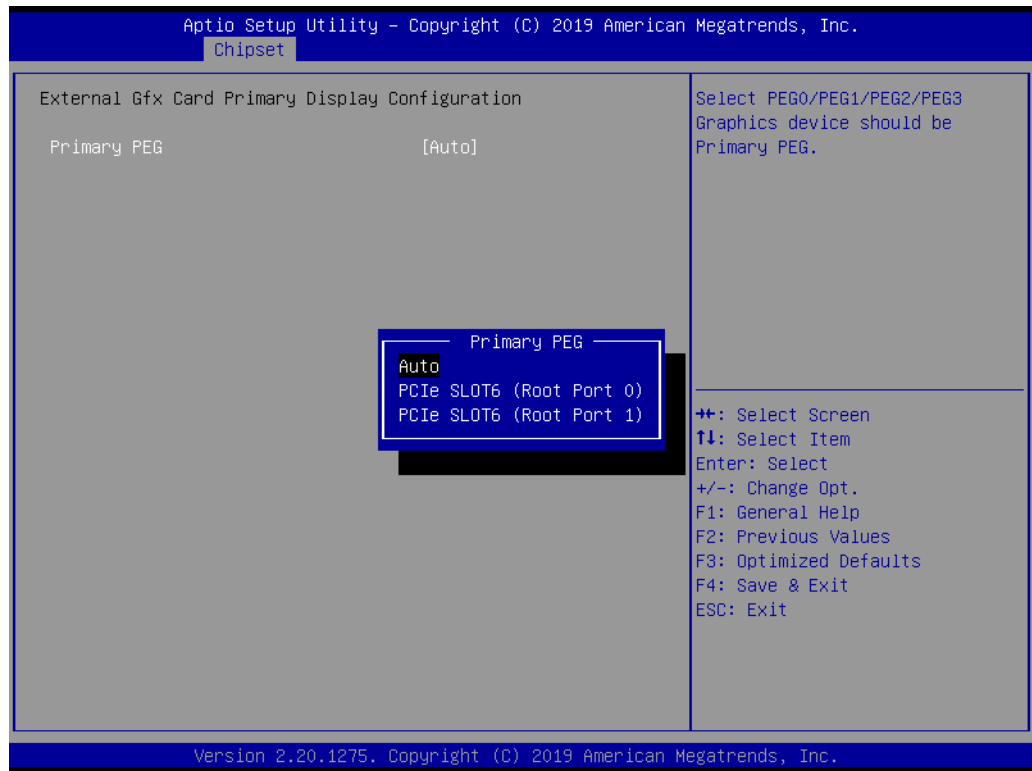

- **Internal Graphics**
Keep IGFX enabled based on the setup options.

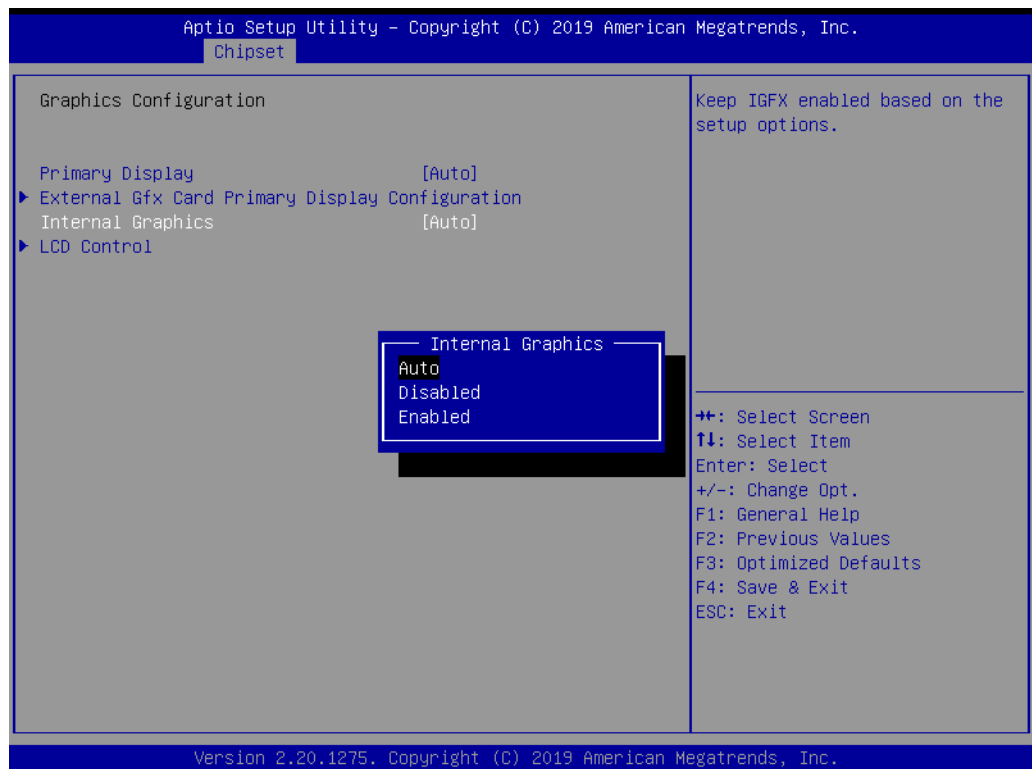

■ LCD Control

Select the video device which will be activated during POST. This has no effect if external graphics are present. Secondary boot display selection will appear based on your selection. VGA mode will be supported only on primary display.

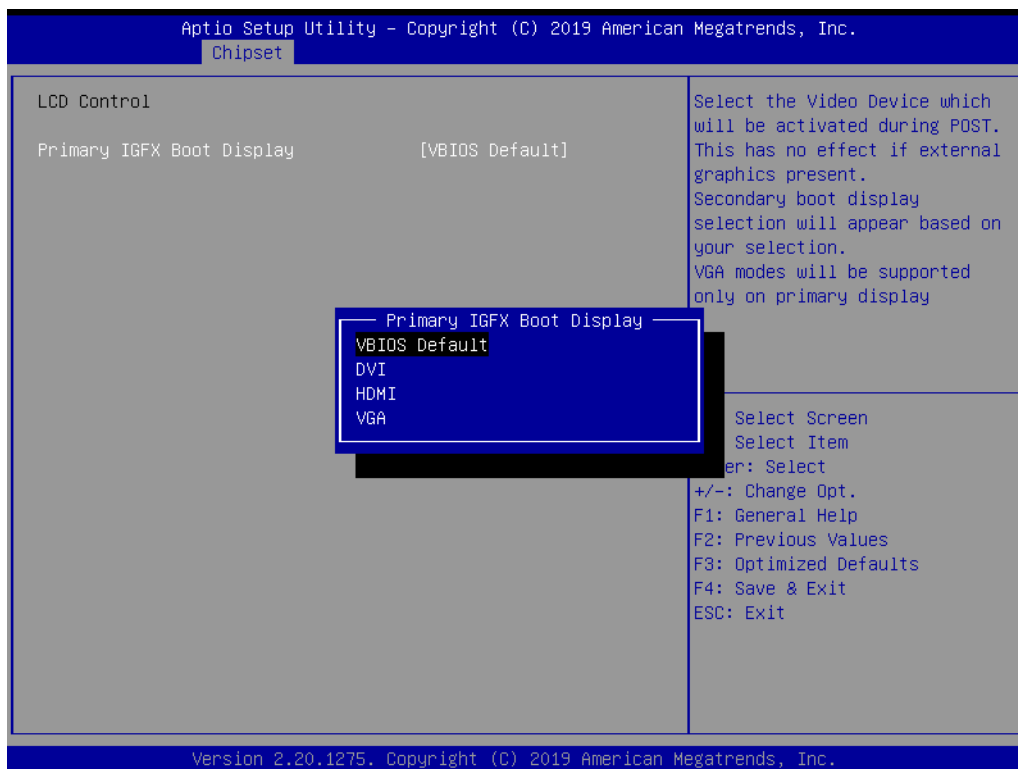

3.4.1.3 PEG Port Configuration

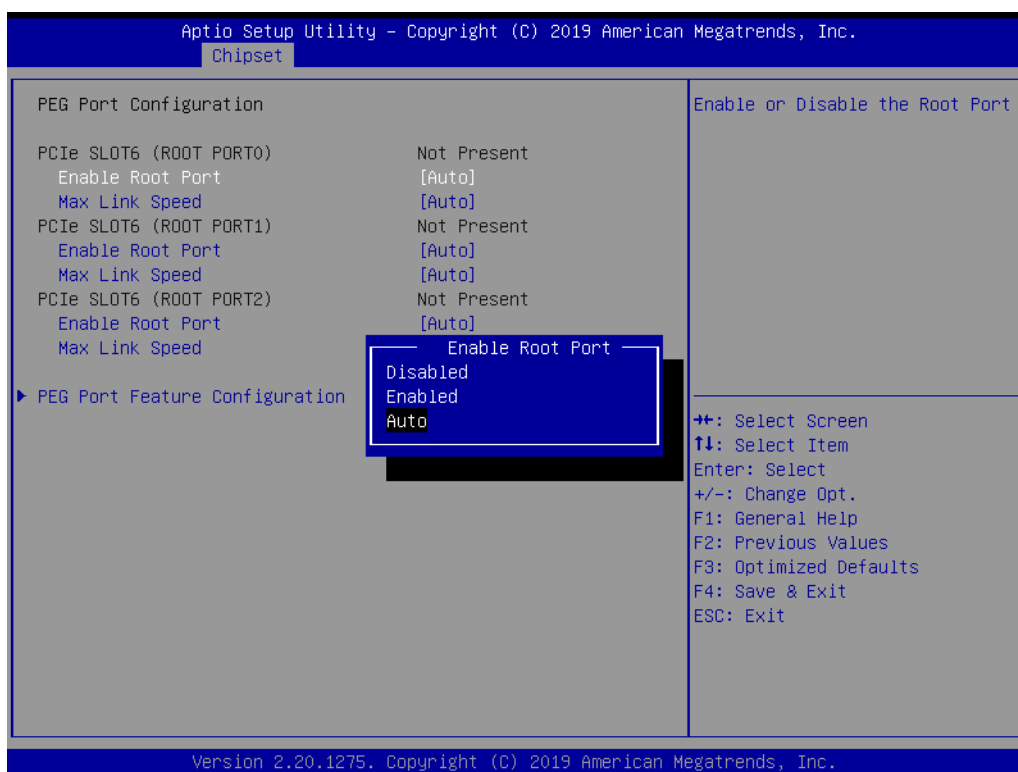

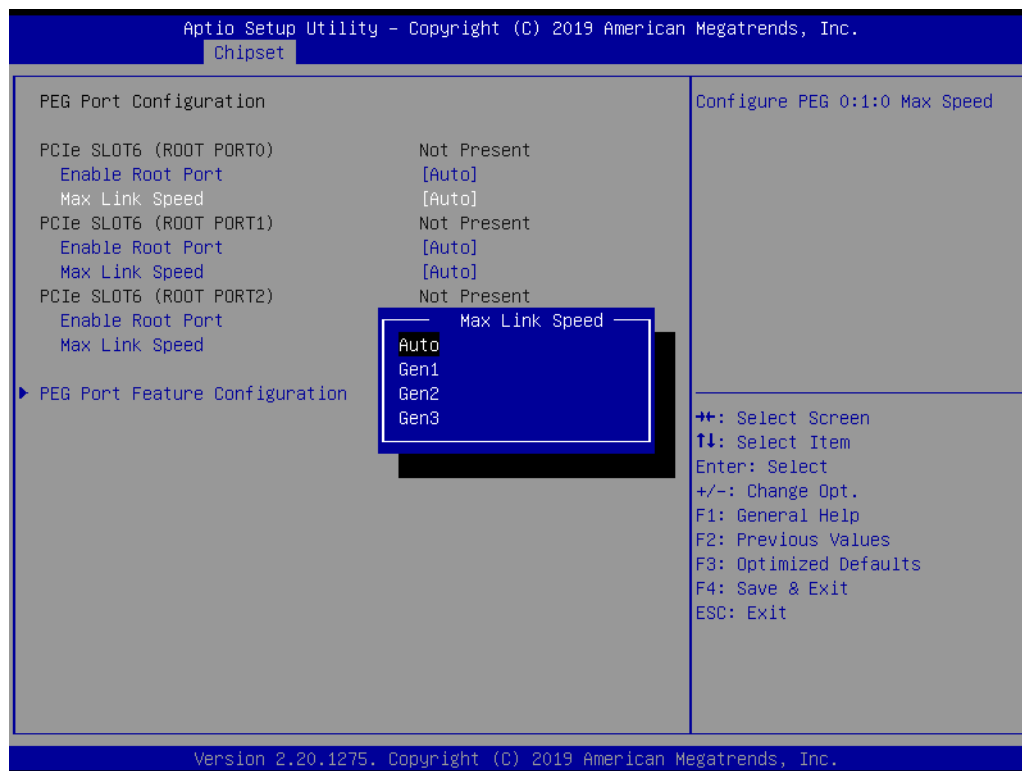

- **PCIe SLOT6 (ROOT PORT0)**
Enable Root Port: Auto/Disabled/Enabled.
Max Link Speed: Configure PEG 0:1:0 Max Speed.
- **PCIe SLOT6 (ROOT PORT1)**
Enable Root Port: Auto/Disabled/Enabled.
Max Link Speed: Configure PEG 0:1:1 Max Speed.
- **PCIe SLOT6 (ROOT PORT2)**
Enable Root Port: Auto/Disabled/Enabled.
Max Link Speed: Configure PEG 0:1:2 Max Speed.
- **PEG Port Feature Configuration**
Detect Non-Compliance PCI Express Device in PEG.

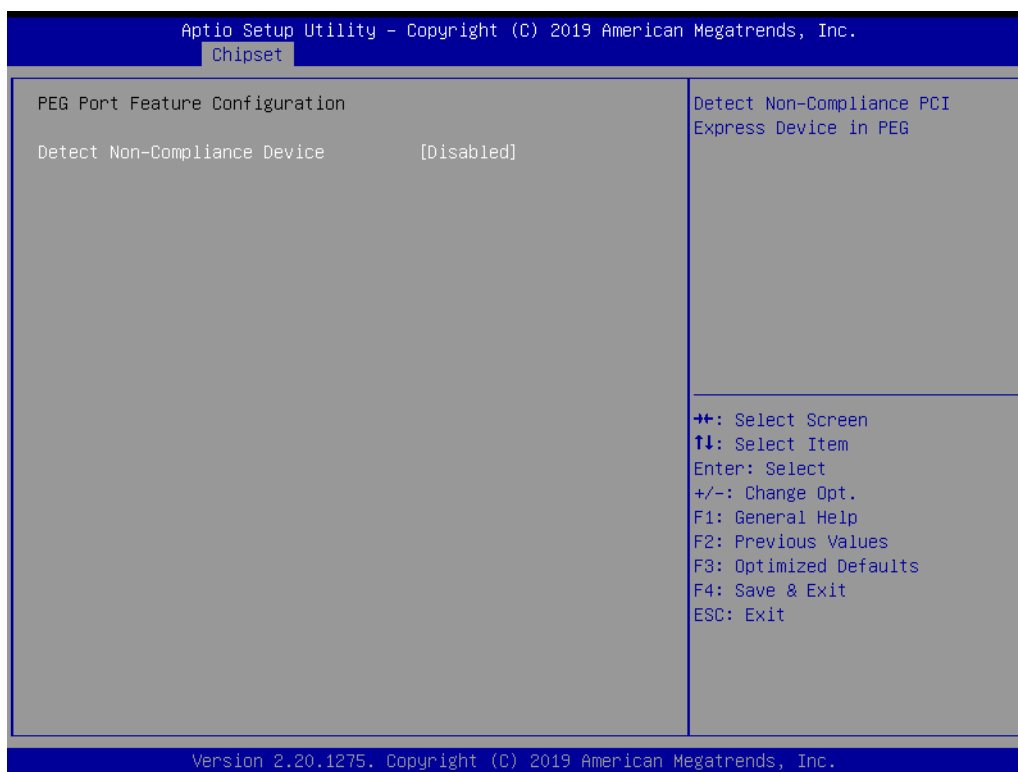

3.4.2 PCH-IO Configuration

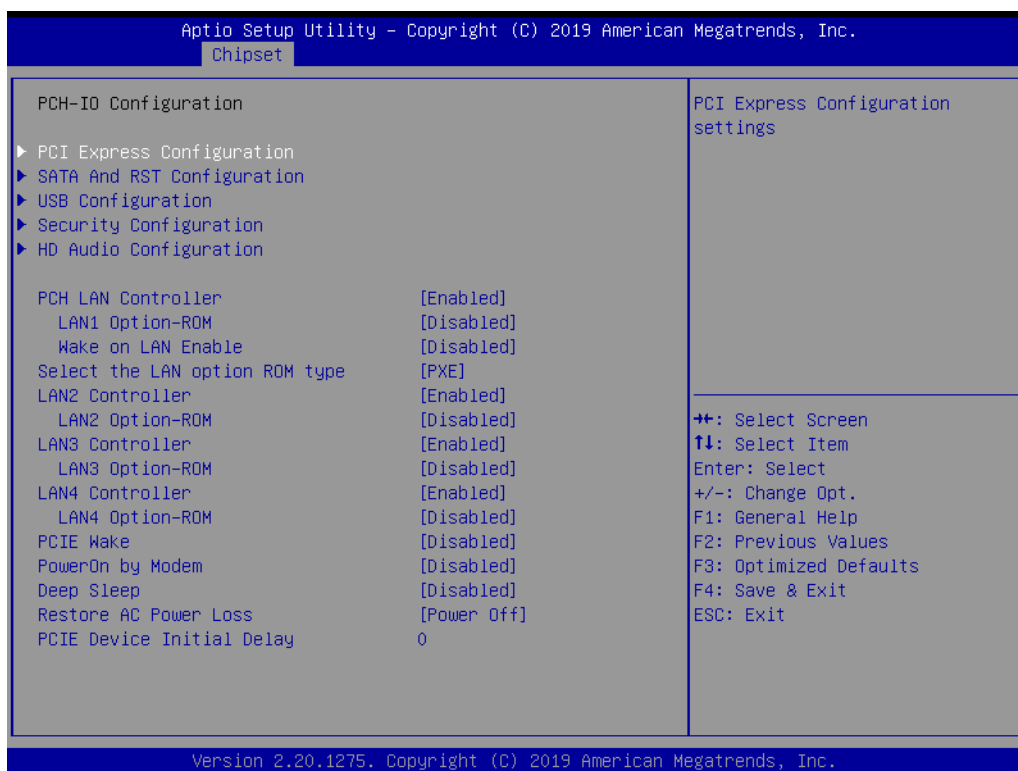

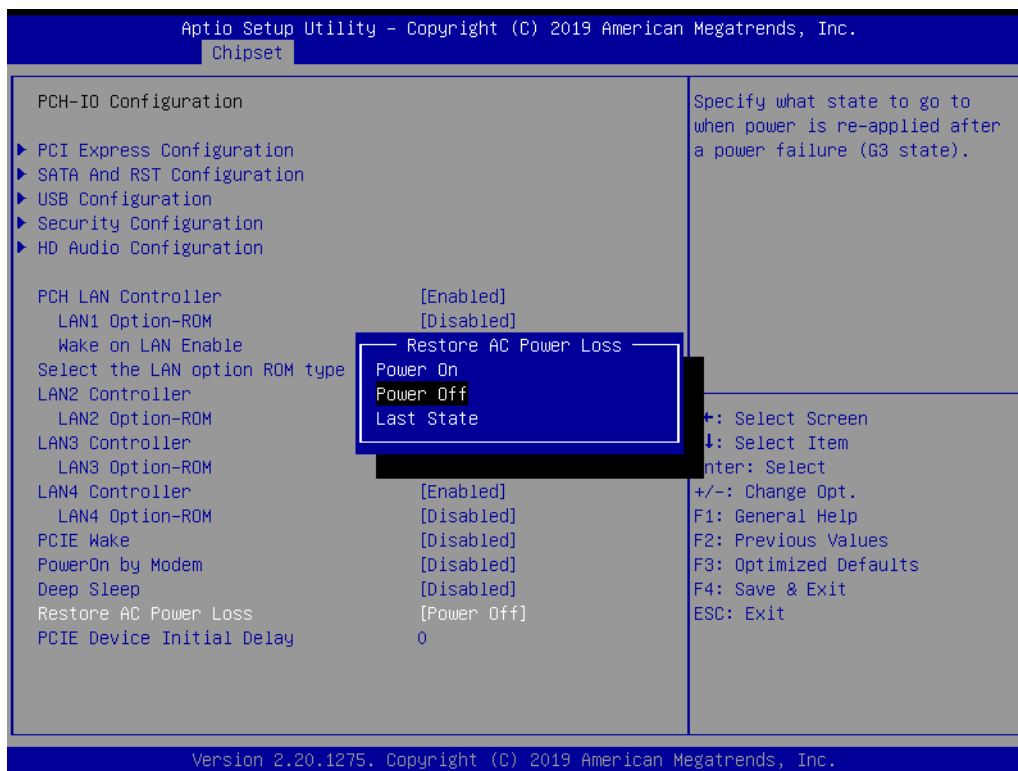

Figure 3.21 PCH-IO configuration screen

- **LAN1 Controller**
Enable or disable onboard NIC.
- **LAN1 Option-ROM**
Enable or disable Boot Options for LAN1 controller.
- **Wake on LAN Enable**
Enable or disable integrated LAN to wake the system for i219 (LAN1).
- **Select the LAN option ROM type**
Select PXE or iSCSI for i210 (LAN2, LAN3, LAN4)
- **LAN2 Controller**
Enable or disable onboard LAN2.
- **LAN2 Option-ROM**
Enable or disable Boot Options for LAN2 controller.
- **LAN3 Controller**
Enable or disable onboard LAN3.
- **LAN3 Option-ROM**
Enable or disable Boot Options for LAN3 controller.
- **LAN4 Controller**
Enable or disable onboard LAN4.
- **LAN4 Option-ROM**
Enable or disable Boot Options for LAN4 controller.
- **PCIE Wake**
Enable or disable PCIE to wake the system from S5.
- **PowerOn by Modem**
Enable or disable PowerOn by Modem
- **Deep Sleep**
Enable or disable Deep Sleep support
- **Restore AC Power Loss**
Select what state to go to when power is re-applied after a power failure (G3 state).

Note!  *When a system enters G3 status with deep S5 enabled, some power supply's 5VSB won't drop until after more than 30 seconds. If "Restore AC Power Loss" is set to "power on", the system won't boot up for 30 seconds after power failure. We recommend the user waits for more than 30 seconds to power on after a power failure. On the other hand, the system will auto power on if power is restored within 30 seconds, before 5VSB actually drops, even if "Restore AC Power Loss" is set to "power off".*



3.4.2.1 PCI Express Configuration

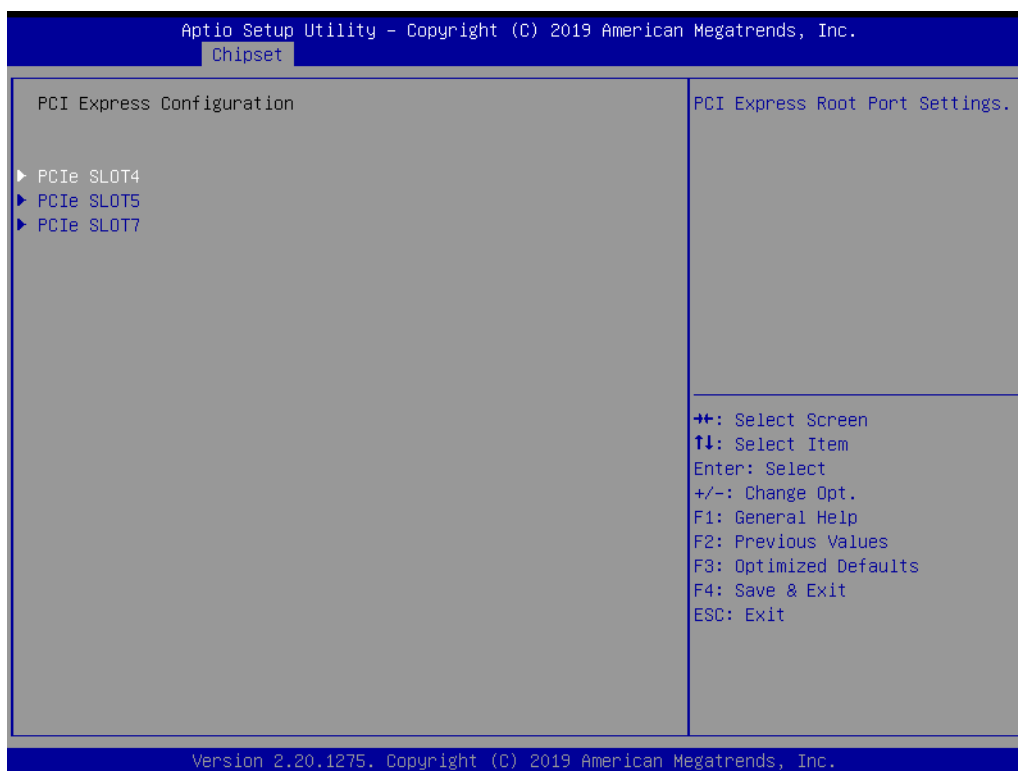
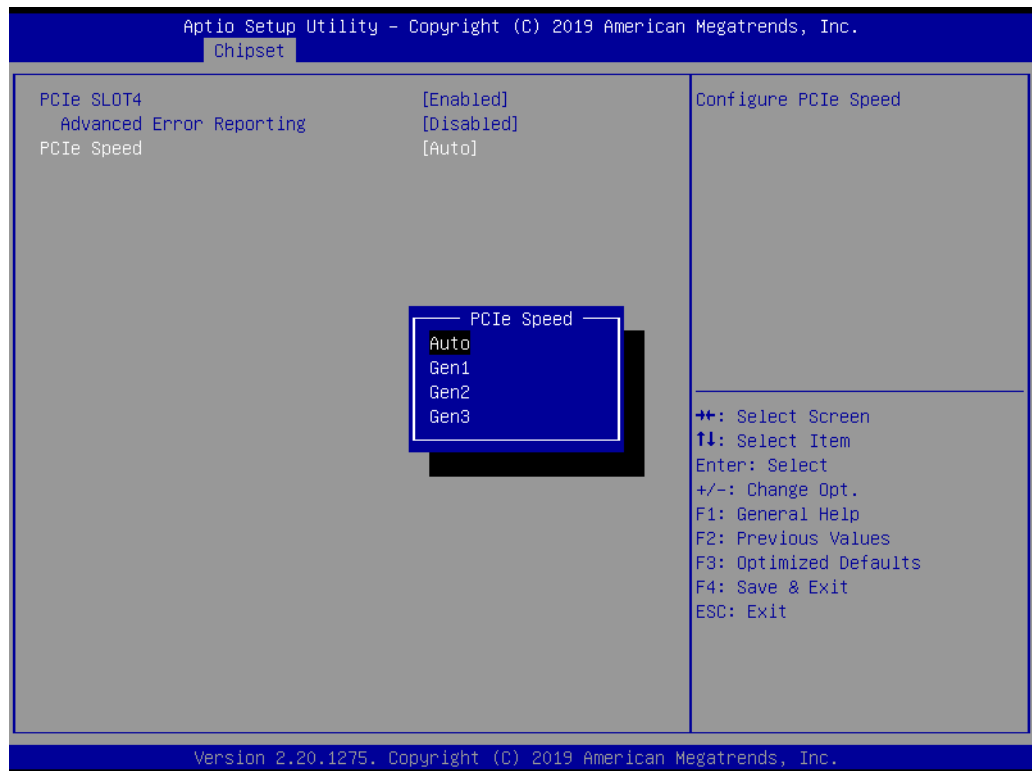

Figure 3.22 PCI Express configuration screen



- **PCIe SLOT4/5/7**
Controls the PCI Express Root Port.
- **Advanced Error Reporting**
Enable or disable advanced error reporting. It may occur system BSOD problem when set to 'Enable' but the PCIe card has no support Advanced Error Reporting (AER) function.
- **PCIe Speed**
Sets PCIe speed for PCI Express slots 4/5/7.

3.4.2.2 SATA And RST Configuration

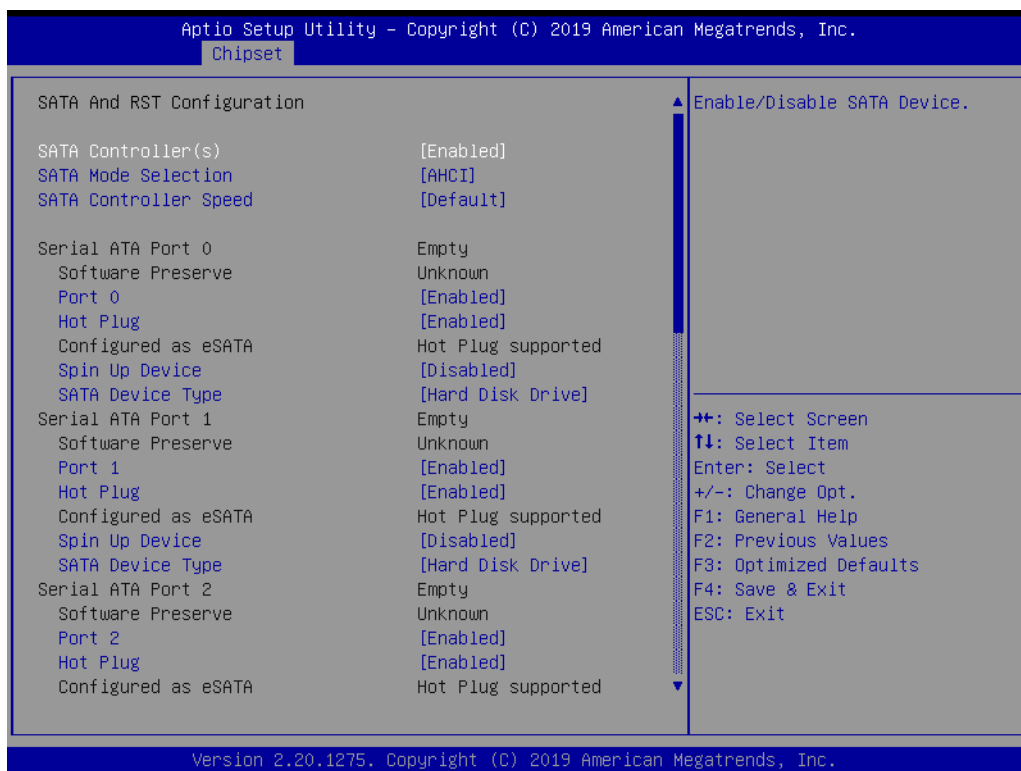

Figure 3.23 SATA and RST configuration screen

- **SATA Controller(s)**
Enable or disable SATA device.
- **SATA Mode Selection**
Set as AHCI or RAID when SATA controllers are enabled.
- **SATA Controller Speed**
Indicates the maximum speed the SATA controller can support.
- **Port 0~7**
Enable or disable SATA port 0~7.
- **Hot Plug**
Designates this port as Hot Pluggable.
- **Spin Up Device**
If enabled for any ports, Staggered Spin Up will be performed and only the drives which have this option enabled will spin up at boot. Otherwise all drives spin up at boot.
- **SATA Device Type**
Identifies the SATA port is connected to Solid State Drive or Hard Disk Drive.

3.4.2.3 USB Configuration

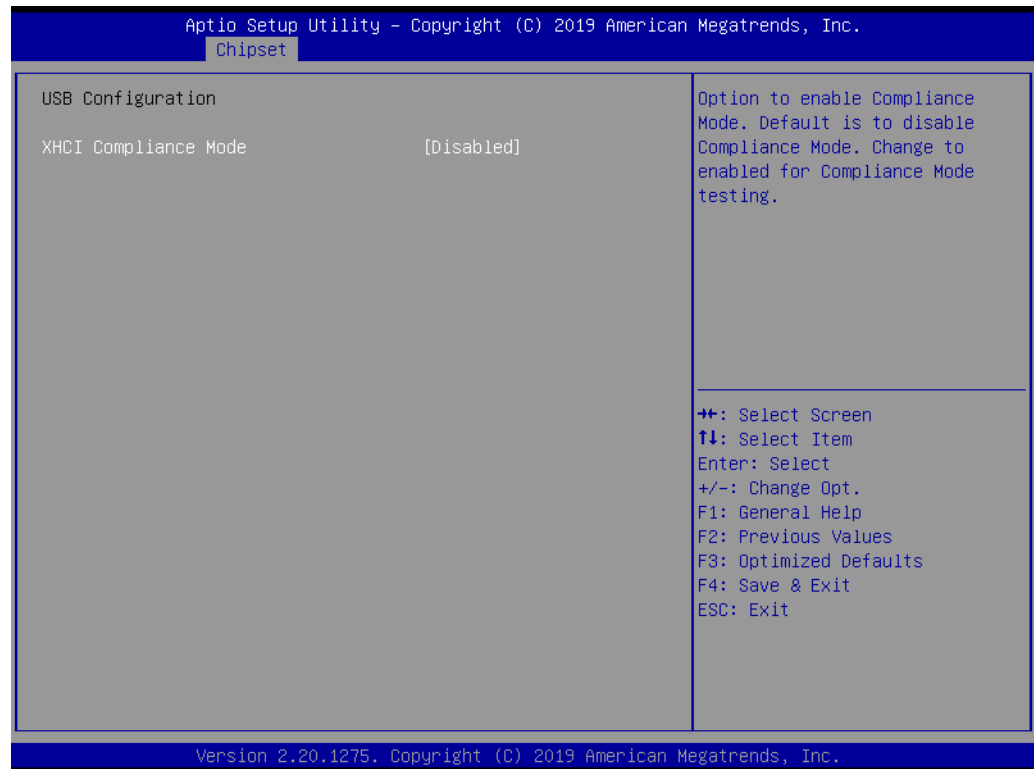

Figure 3.24 USB configuration screen

- **XHCI Disable Compliance Mode**
Enable or disable compliance mode. Default is to disable Compliance Mode. Change to enabled for Compliance Mode testing.

3.4.2.4 Security Configuration

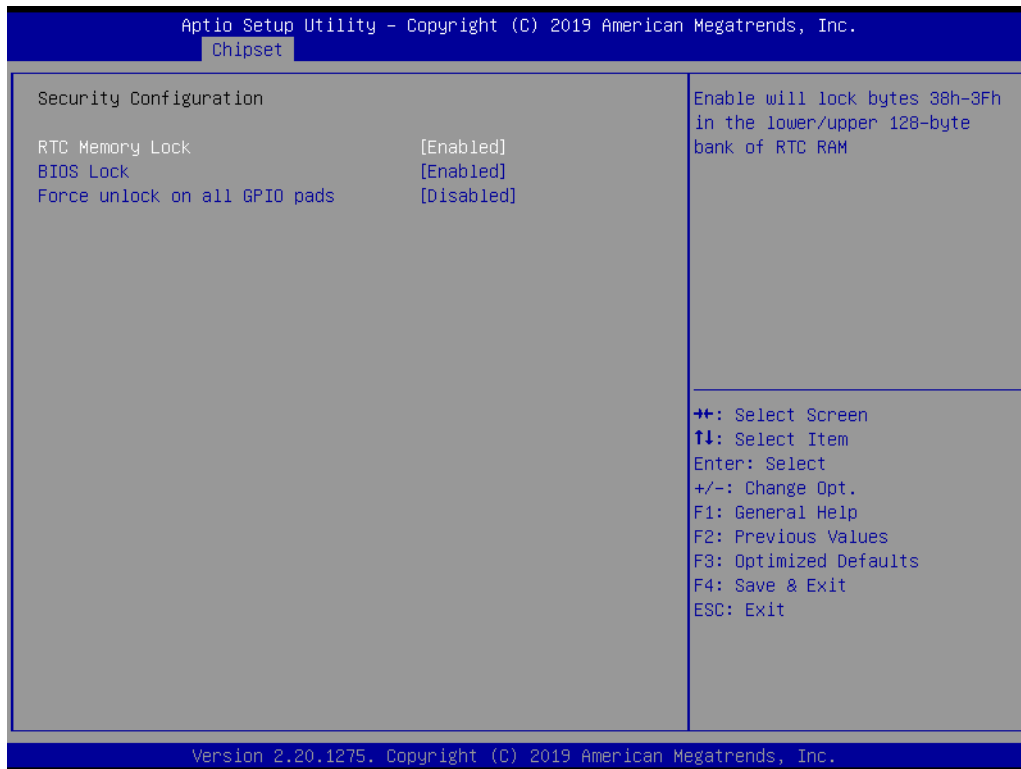

Figure 3.25 Security configuration screen

- **RTC Memory Lock**
Enable will lock bytes 38h-3Fh in the lower/upper 128-byte bank of RTC RaM.
- **BIOS Lock**
Enable or disable the PCH BIOS Lock Enable feature. This item must be enabled to ensure SMM protection of flash.
- **Force unlock on all GPIO pads**
If enabled, BIOS will force all GPIO pads to be in an unlocked state.

3.4.2.5 HD Audio Configuration

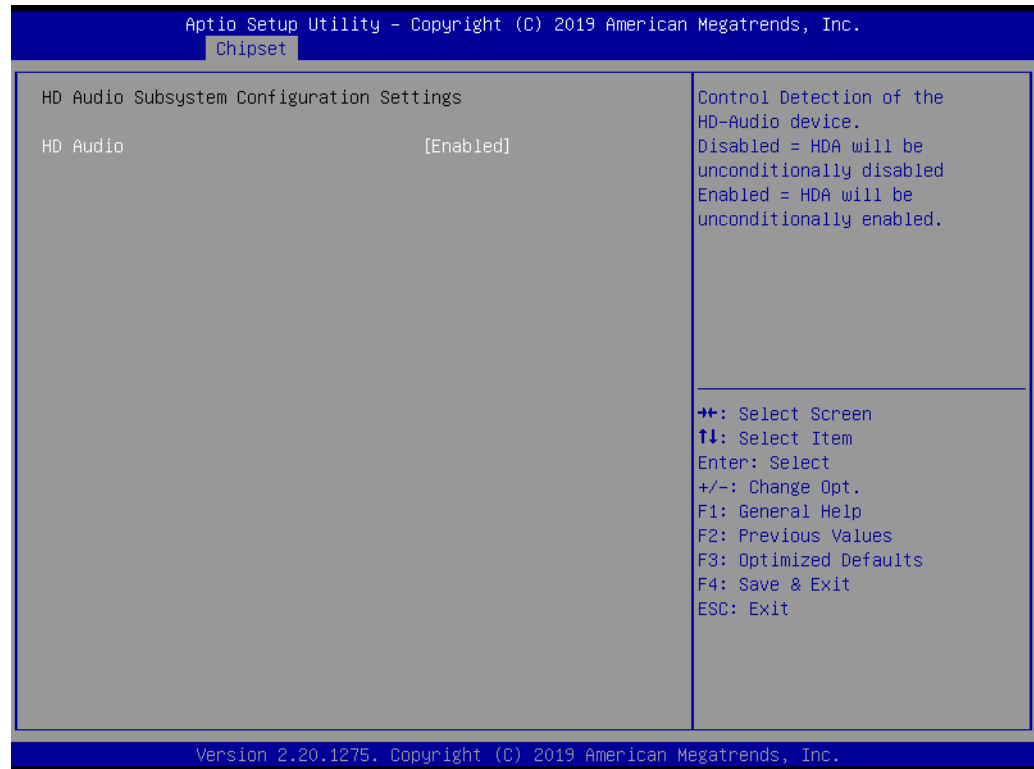

Figure 3.26 HD Audio configuration screen

- **HD Audio**
Controls detection of the HD-Audio device.

3.5 Security

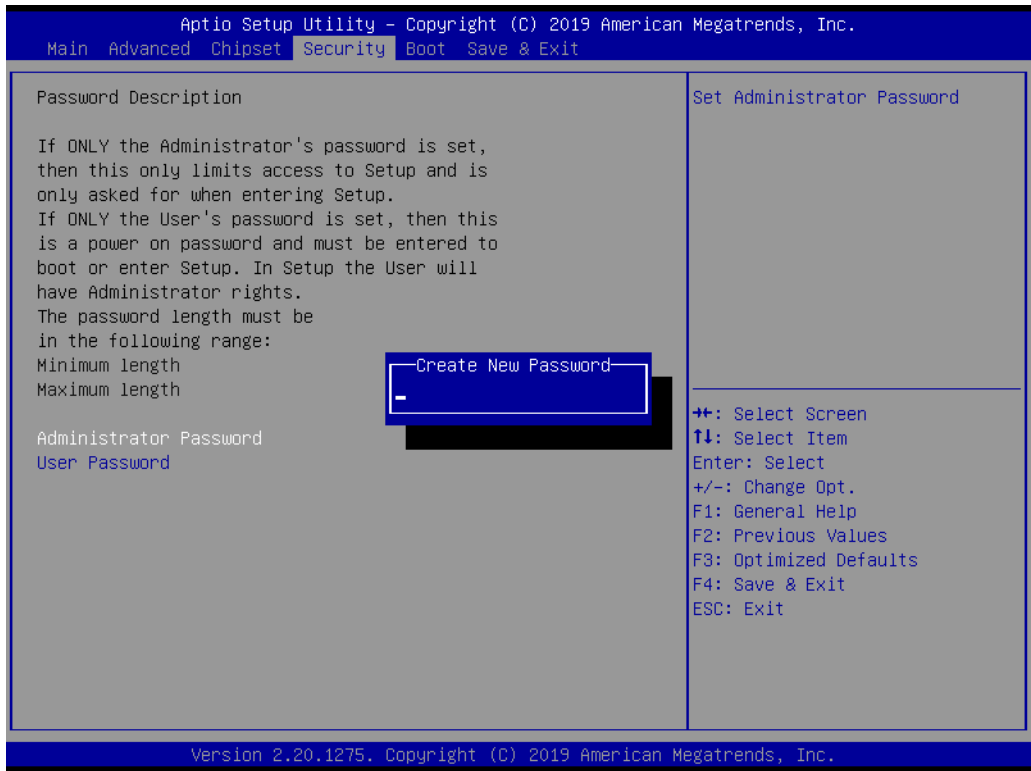
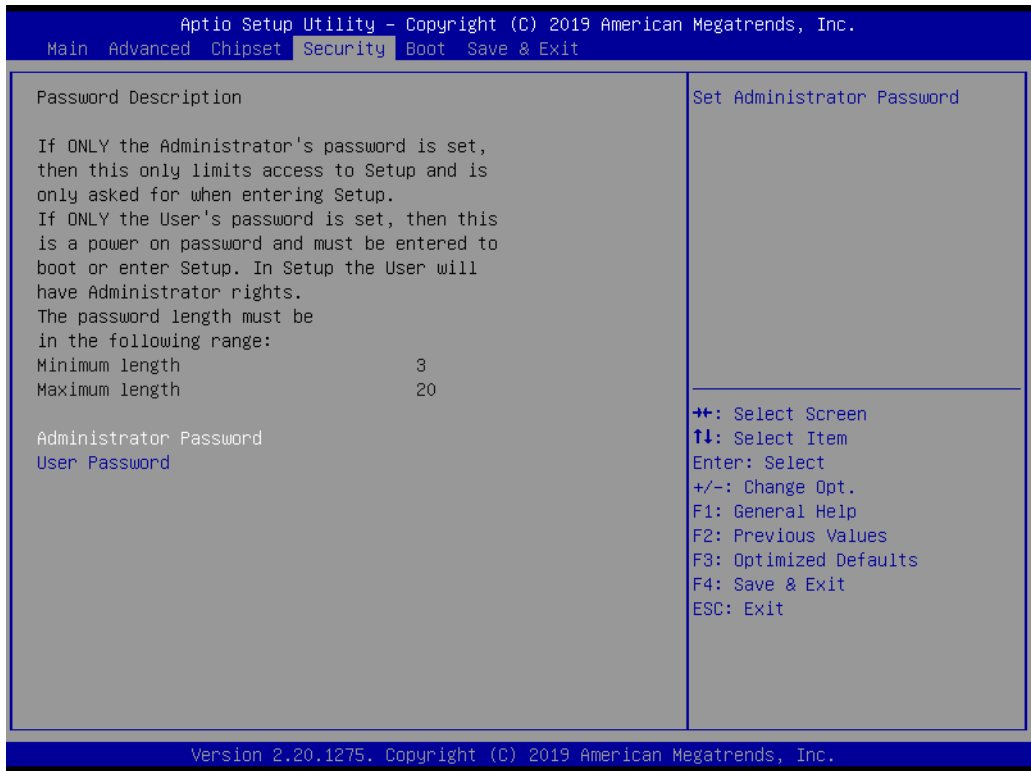

Figure 3.27 Security screen

Select Security Setup from the ASMB-586 setup main BIOS setup menu. All Security Setup options, such as password protection, are described in this section. To access the sub menu for the following items, select the item and press <Enter>.

3.6 Boot



Figure 3.28 Boot screen

- **Setup Prompt Timeout**
Use the <+> and <-> keys to adjust the number of seconds to wait for setup activation key.
- **Bootup NumLock State**
'On' or 'Off' power-on state for the NumLock.
- **Quiet Boot**
If this option is set to Disabled, the BIOS displays normal POST messages. If Enabled, an OEM logo is shown instead of POST messages.
- **Boot Option Priorities**
Choose boot priority from boot device.

Note! UEFI devices can be recognized as default. Set 'Enabled' in CSM Configuration to support legacy devices when needed.



3.7 Save & Exit



Figure 3.29 Save & Exit screen

- **Save Changes and Exit***
When you have completed system configuration, select this option to save your changes, exit BIOS setup and boot into the OS so the new system configuration parameters can take effect.
- **Discard Changes and Exit**
Select this option to quit setup without making any permanent changes to the system configuration.
- **Save Changes and Reset**
When you have completed system configuration, select this option to save your changes, exit BIOS setup and reboot into the computer so the new system configuration parameters can take effect.
- **Discard Changes and Reset**
Select this option to quit setup and reset computer without making any permanent changes to the system configuration.
- **Save Changes**
Select this option to save your changes.
- **Discard Changes**
Select this option to discard your changes.
- **Restore Defaults**
Select this option to restore BIOS configuration as original.
- **Save as User Defaults**
Select this option to save user's configuration.
- **Restore User Defaults**
Select this option to restore BIOS to user's configuration.

■ UEFI: Built-in EFI Shell

This option allows you to attempt to launch the EFI Shell application (shellx64.efi) from one of the available file system devices.

*When you make some critical changes, the system will still reboot even after you choose 'Save Changes and Exit'.

3.8 Server Mgmt

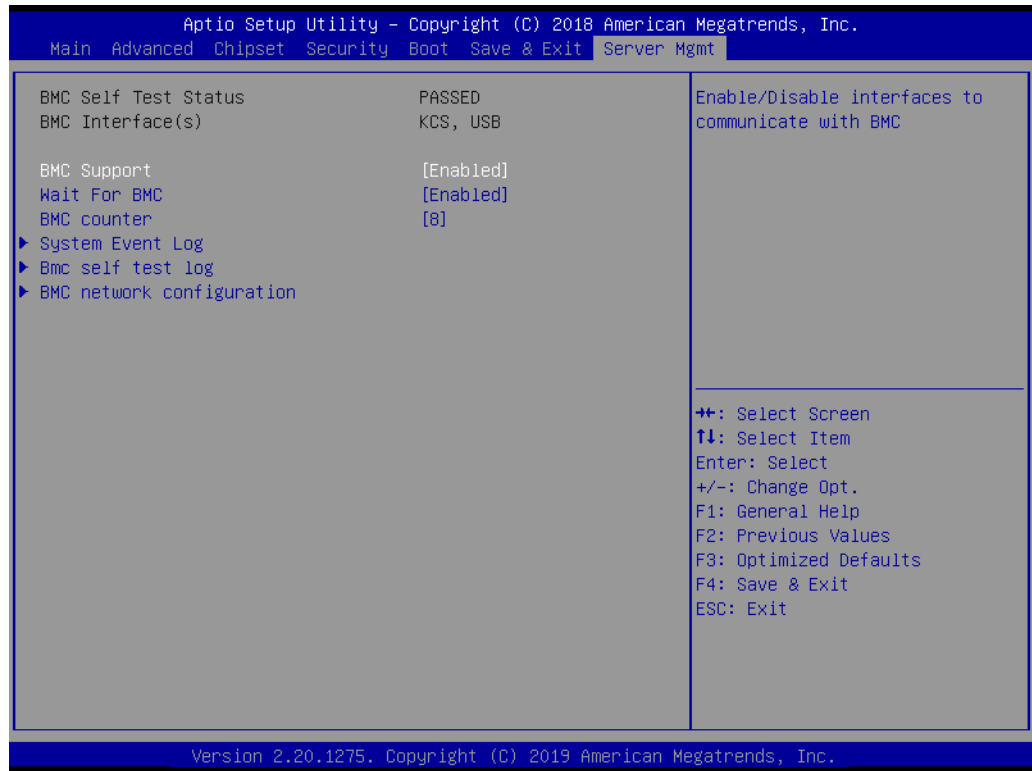
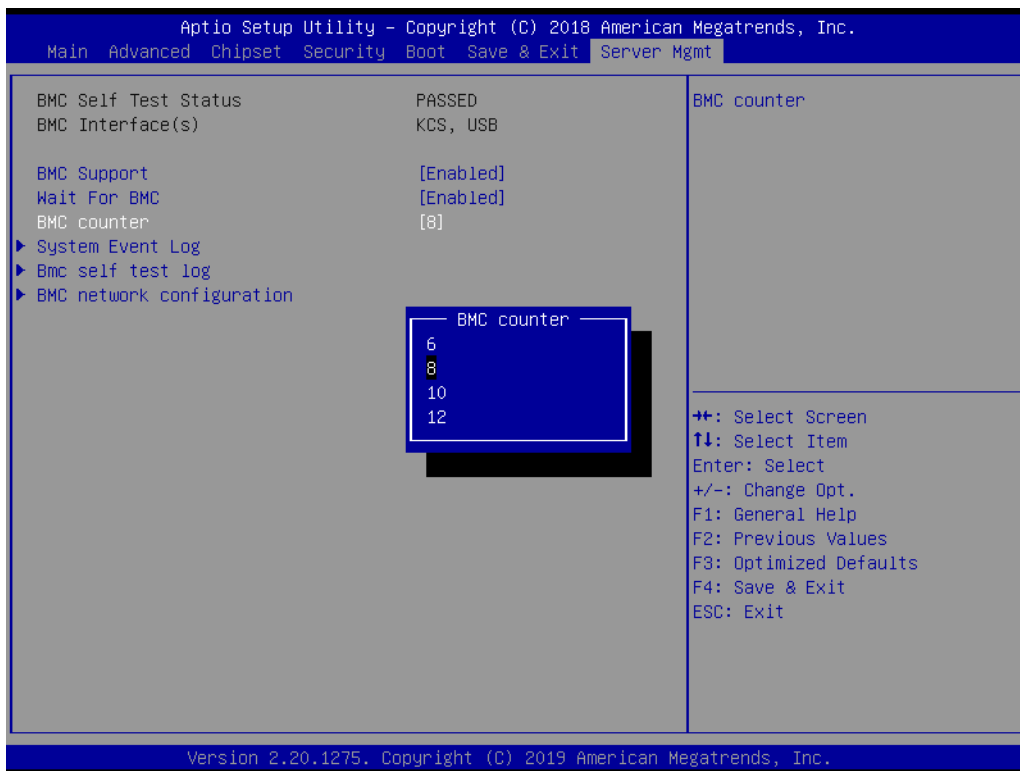

Figure 3.30 Server Mgmt screen



Note! This item only shows when an IPMI module is installed. (P/N: IPMI-1000-00A2E)



- **BMC Support**
Enable or disable interfaces to communicate with BMC.
- **Wait For BMC**
Wait for BMC response for specified time out. BMC starts at the same time when BIOS starts during AC power ON. It takes around 30 seconds to initialize Host to BMC interfaces with beep sound but without display output until initialization is completed.
- **BMC Counter**

3.8.1 System Event Log

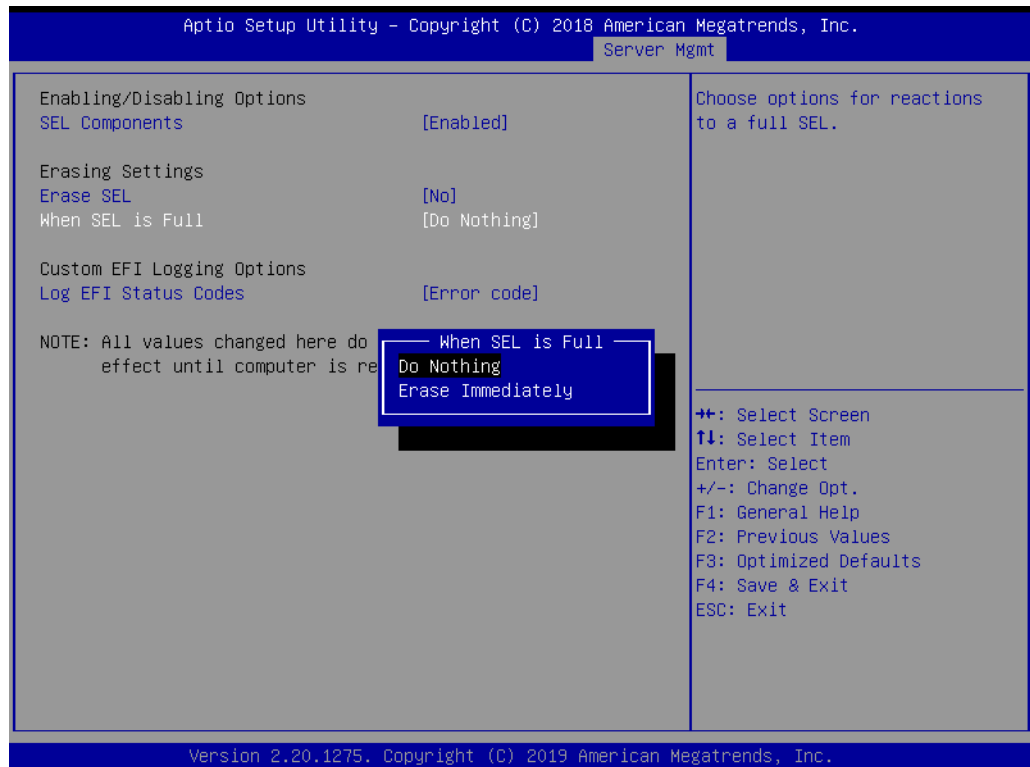
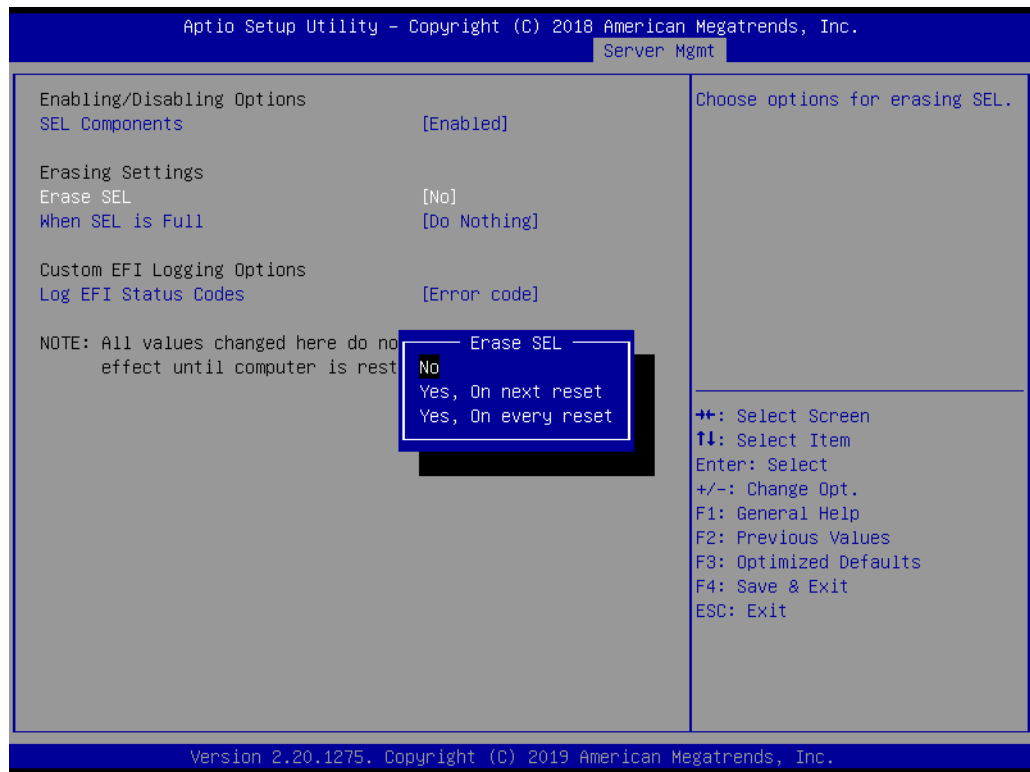

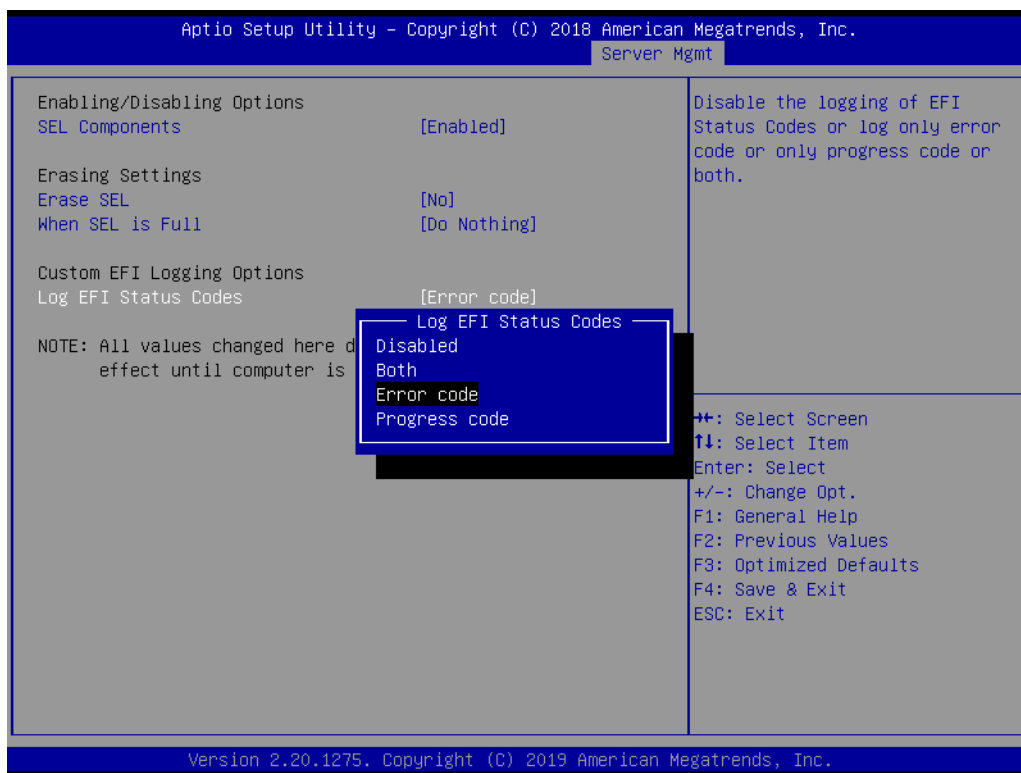

- **SEL Components**
Enable or disable event logging for error/progress codes during boot.
- **Erase SEL**
Choose options for erasing SEL.
- **When SEL is Full**
Choose options for reactions to a full SEL.
- **Log EFI Status Codes**
Disable the logging of EFI status codes or log only error code or progress code or both.

3.8.2 BMC Self Test Log

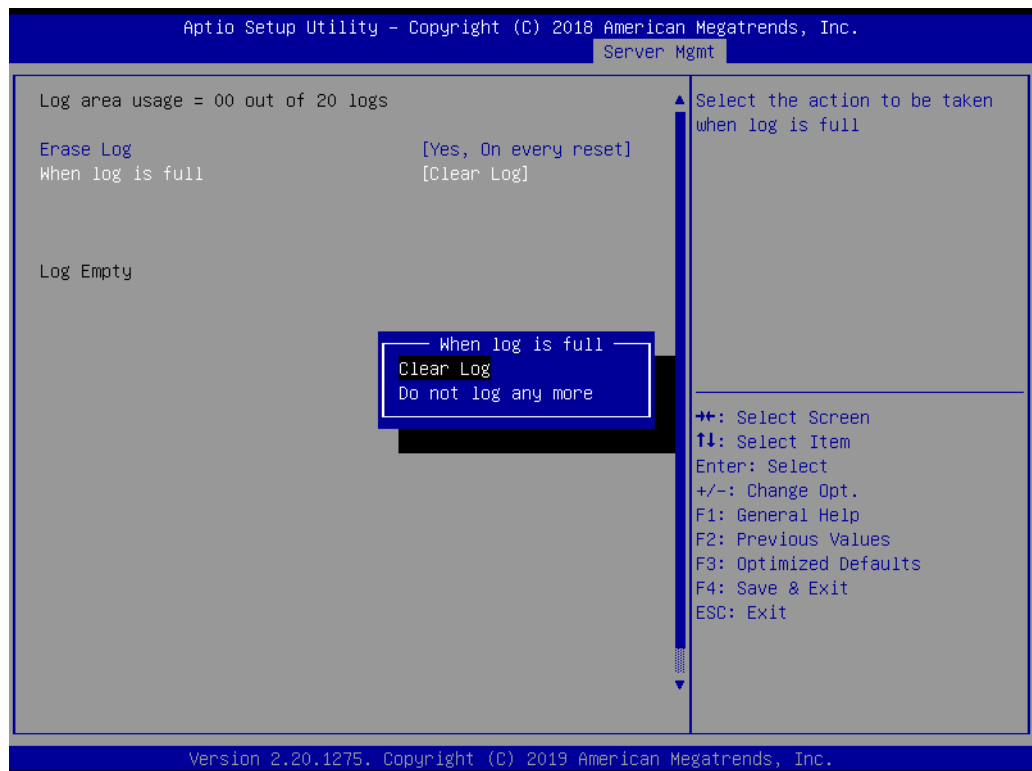
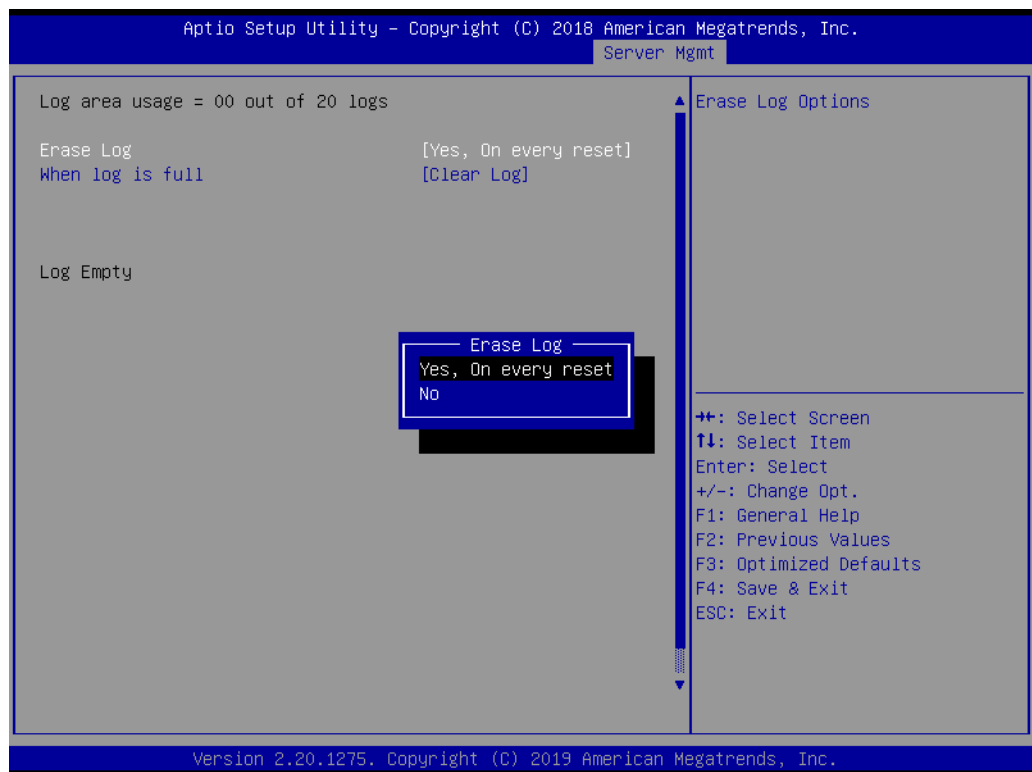

- **Erase Log**
Erase log or not on every reset.
- **When Log is Full**
Clear log or do not log any more when log is full.

3.8.3 BMC Network Configuration

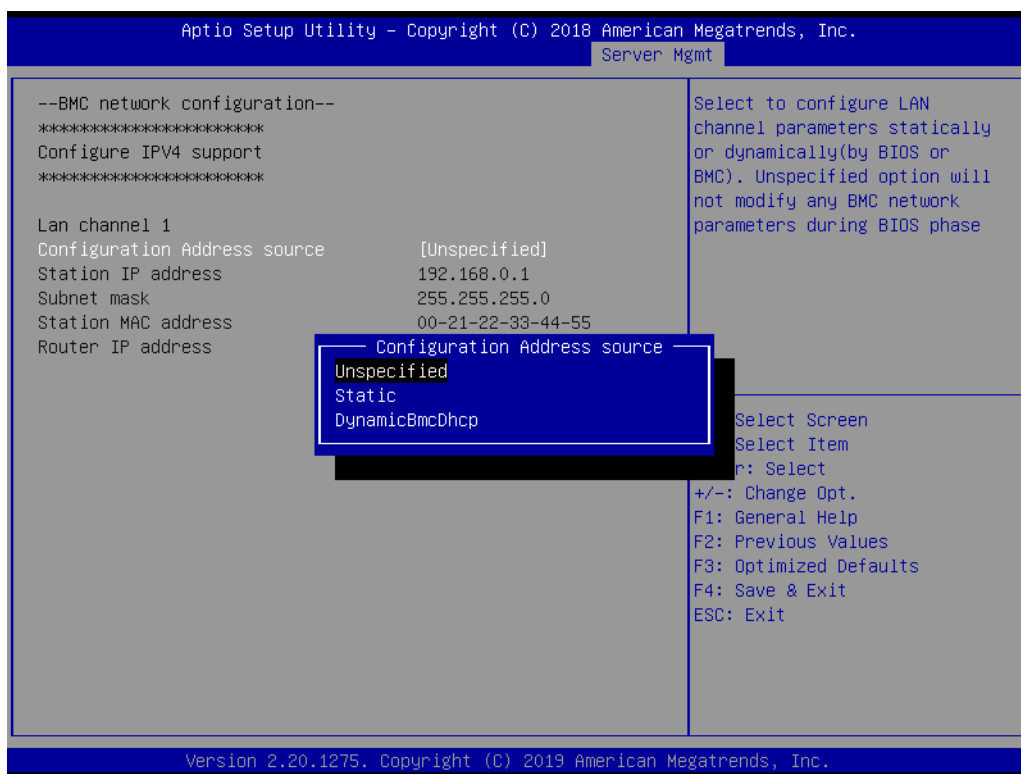

- **Configuration Address Source**

Select to configure LAN channel1 parameters statically or dynamically (by BIOS or BMC). Unspecified option will not modify any BMC network parameters during BIOS phase. ASMB-586 design has reserved LAN2 port as IPMI share NIC.

Chapter 4

Driver Installation

4.1 Before You Begin

To ensure drivers are the most up-to-date, they are downloadable from Advantech's support website for ASMB-586 at: <https://advt.ch/searc8f16d>

Before you begin, it is important to note that most display drivers need to have the relevant software application already installed in the system prior to installing the enhanced display drivers. In addition, many of the installation procedures assume that you are familiar with both the relevant software applications and operating system commands. Review the relevant operating system commands and the pertinent sections of your application software's user manual before performing the installation.

Note! For system stability, installing the drivers in the following sequence is



highly recommended:

- Chipset
- Graphics
- ME
- Other drivers

4.2 Introduction

4.2.1 Chipset

The Intel® Chipset Software Installation (CSI) utility installs the Windows INF files that outline to the operating system how the chipset components will be configured. This is needed for the proper functioning of the following features:

- Serial ATA interface support
- USB 1.1/2.0/3.1 support
- Identification of Intel chipset components in the Device Manager

Note! The chipset driver has to be installed before installing all the other drivers. It is used for the following versions of Windows.



- Windows® Server 2016 (64-bit)
- Windows® Server 2019 (64-bit)
- Windows® 10 (64-bit)
- Windows® 10 (32-bit, only for Intel® Atom™/ Celeron®/ Pentium® Processor)

4.2.2 Graphics

The Intel Xeon E and 8th/9th Gen. Core i3/i5/i7 series processors are embedded with an integrated graphics controller. You need to install the VGA driver to enable this function for an optimized integrated graphic solution. The Intel® Graphics Flexible Display Interface supports versatile display options and a 3D graphics engine. Triple independent displays are supported and enhanced display modes for widescreen flat panels for extended, twin, and clone dual display modes. Optimized 3D support delivers an intensive and realistic visual experience.

4.2.3 LAN

ASMB-586 is equipped with up to four Gigabit Ethernet LANs via dedicated PCI Express x1 lanes (GbE LAN1: Intel I219LM; GbE LAN2~4: Intel I210-AT) that offer bandwidth of up to 500 MB/sec, eliminating the bottleneck of network data flow and incorporating Gigabit Ethernet at 1000 Mbps. Features include:

- 10/100/1000 Mbps Ethernet controller
- 10/100/1000 Mbps triple-speed MAC
- Full duplex at 10, 100, or 1000 Mbps and half duplex at 10 or 100 Mbps
- Wake-on-LAN (WOL) support
- PCIe x1 host interface

The integrated Intel® gigabit Ethernet controller supports all major network operating systems. However, the installation procedure varies with different operating systems. Contact FAE for technical support when you have problem during installation.

Note! Before installing the LAN drivers, make sure the CSI utility has been installed on your system.



4.2.4 HD Audio

ASMB-586 is equipped with a Realtek ALC892 Audio chip. It provides "Line-out" & "Microphone" ports.

4.2.5 Intel ME

The Intel ME software components that need to be installed depend on the system's specific hardware and firmware features. The installer detects the system's capabilities and installs the relevant drivers and applications.

Note! If the Intel® Management Engine (Intel ME) driver has not been successfully installed, you may see an error on a "PCI Simple Communications Controller" in Device Manager.



4.2.6 SATA RAID

To support demanding disk I/O, Intel C246 chipset integrates seven Serial ATA controllers with software RAID 0, 1, 5, 10 capabilities.

RAID 0 striping increases the storage performance and is designed to speed up data transfer rates for disk-intensive applications.

RAID 1 mirroring protects valuable data that might be lost in the event of a hard drive failure.

RAID 5 array contains three or more hard drives where the data is divided into manageable blocks called stripes. Parity is a mathematical method for recreating data that was lost from a single drive, which increases fault-tolerance. The data and parity are striped across all the hard drives in the array. The parity is striped in a rotating sequence to reduce bottlenecks associated with the parity calculations.

RAID 10 array uses four hard drives to create a combination of RAID levels 0 and 1. The data is striped across a two-drive array forming the RAID 0 component. Each of the drives in the RAID 0 array is then mirrored by a RAID 1 component.

Appendix **A**

Programming the
Watchdog Timer

The ASMB-586's watchdog timer can be used to monitor system software operation and take corrective action if the software fails to function within the programmed period. This section describes the operation of the watchdog timer and how to program it.

A.1 Watchdog Timer Overview

The watchdog timer is built in to the super I/O controller NCT6776. It provides the following functions for user programming:

- Can be enabled and disabled by user's program
- Timer can be set from 1 to 255 sec/min.
- Generates an interrupt or resets signal if the software fails to reset the timer before time-out

A.2 Programming the Watchdog Timer

The I/O port address of the watchdog timer is 2E (hex) and 2F (hex). 2E (hex) is the address port. 2F (hex) is the data port. You must first write an address value into address port 2E (hex), and then write/read data to/from the assigned register through data port 2F (hex).

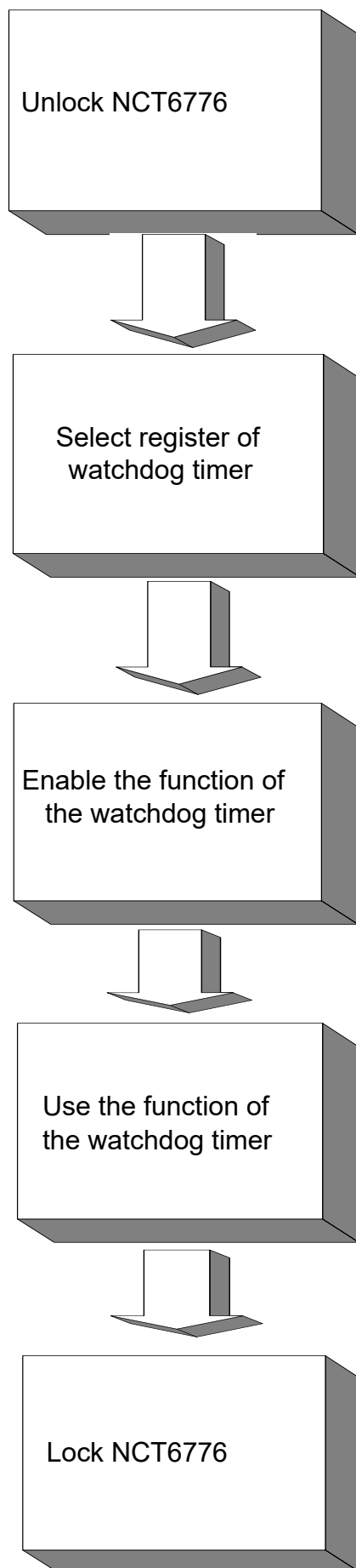

Table A.1: Watchdog timer registers

Address of register (2E)	Read/Write	Value (2F) & description
87 (hex)	-	Write this address to I/O address port 2E (hex) twice to unlock the NCT6776
07 (hex)	write	Write 08 (hex) to select register of watchdog timer.
30 (hex)	write	Write 01 (hex) to enable the function of the watchdog timer. Disabled is set as default.
F5 (hex)	write	Set seconds or minutes as units for the timer. Write 0 to bit 3: set seconds as counting unit. [default]. Write 1 to bit 3: set minutes as counting unit. Write 1 to bit 4: Watchdog timer count mode is 1000 times faster. If bit 3 is 0, the count mode is 1/1000 seconds mode. If bit 3 is 1, the count mode is 1/1000 minutes mode.
F6 (hex)	write	0: stop timer [default] 01 ~ FF (hex): The amount of the count, in seconds or minutes, depends on the value set in register F5 (hex). This number decides how long the watchdog timer waits for strobe before generating an interrupt or reset signal. Writing a new value to this register can reset the timer to count with the new value.
F7 (hex)	read/write	Bit 6: Write 1 to enable keyboard to reset the timer, 0 to disable. [default] Bit 5: Write 1 to generate a timeout signal immediately and automatically return to 0. [default=0] Bit 4: Read status of watchdog timer, 1 means timer is "timeout".
AA (hex)	-	Write this address to I/O port 2E (hex) to lock NCT6776.

A.2.1 Example Programs

Enable watchdog timer and set 10 seconds as the timeout interval

```

;-----
Mov dx,2eh ; Unlock NCT6776
Mov al,87h
Out dx,al
Out dx,al
;-----
Mov al,07h ; Select registers of watchdog timer
Out dx,al
Inc dx
in al,dx
Or al,08h
Out dx,al
;-----
Dec dx; Enable the function of watchdog timer
Mov al,30h
Out dx,al
Inc dx
Mov al,01h
Out dx,al
;-----

```

```

Dec dx ; Set second as counting unit
Mov al,0f5h
Out dx,al
Inc dx
In al,dx
And al,not 08h
Out dx,al
;-----
Dec dx ; Set timeout interval as 10 seconds and start counting
Mov al,0f6h
Out dx,al
Inc dx
Mov al,10; 10 minutes
Out dx,al
;-----
Dec dx ; lock NCT6776
Mov al,0aah
Out dx,al
Enable watchdog timer and set 5 minutes as the timeout interval
;-----
Mov dx,2eh ; unlock NCT6776
Mov al,87h
Out dx,al
Out dx,al
;-----
Mov al,07h ; Select registers of watchdog timer
Out dx,al
Inc dx
In al,dx
Or al,08h
Out dx,al
;-----
Dec dx ; Enable the function of watchdog timer
Mov al,30h
Out dx,al
Inc dx
Mov al,01h
Out dx,al
;-----
Dec dx ; Set minute as counting unit
Mov al,0f5h
Out dx, al
Inc dx
In al,dx
Or al, 08h

```

```

Out dx,al
;-----
Dec dx ; Set timeout interval as 5 minutes and start counting
Mov al,0f6h
Out dx,al
Inc dx
Mov al,5; 5 minutes
Out dx,al
;-----
Dec dx ; lock NCT6776
Mov al,0aah
Out dx,al
Enable watchdog timer to be reset by mouse
;-----
Mov dx,2eh ; unlock NCT6776
Mov al,87h
Out dx,al
Out dx,al
;-----
Mov al,07h ; Select registers of watchdog timer
Out dx,al
Inc dx
Mov al,08h
Out dx,al
;-----
Dec dx ; Enable the function of watchdog timer
Mov al,30h
Out dx,al
Inc dx
In al,dx
Or al,01h
Out dx,al
;-----
Dec dx ; Enable watchdog timer to be reset by mouse
Mov al,0f7h
Out dx,al
Inc dx
In al,dx
Or al,80h
Out dx,al
;-----
Dec dx ; lock NCT6776
Mov al,0aah
Out dx,al
Enable watchdog timer to be reset by keyboard

```

```

;-----
Mov dx,2eh ; unlock NCT6776
Mov al,87h
Out dx,al
Out dx,al
;-----
Mov al,07h ; Select registers of watchdog timer
Out dx,al
Inc dx
Mov al,08h
Out dx,al
;-----
Dec dx ; Enable the function of watchdog timer
Mov al,30h
Out dx,al
Inc dx
Mov al,01h
Out dx,al
;-----
Dec dx ; Enable watchdog timer to be strobed reset by keyboard
Mov al,0f7h
Out dx,al
Inc dx
In al,dx
Or al,40h
Out dx,al
;-----
Dec dx ; lock NCT6776
Mov al,0aah
Out dx,al
Generate a time-out signal without timer counting
;-----
Mov dx,2eh ; unlock NCT6776
Mov al,87h
Out dx,al
Out dx,al
;-----
Mov al,07h ; Select registers of watchdog timer
Out dx,al
Inc dx
Mov al,08h
Out dx,al
;-----
Dec dx ; Enable the function of watchdog timer
Mov al,30h

```

```
Out dx,al
Inc dx
In al,dx
Or al,01h
Out dx,al
;-----
Dec dx ; Generate a time-out signal
Mov al,0f7h
Out dx,al ;Write 1 to bit 5 of F7 register
Inc dx
In al,dx
Or al,20h
Out dx,al
;-----
Dec dx ; lock NCT6776
Mov al,0aah
Out dx,al
```

Appendix **B**

I/O Pin Assignments

B.1 USB2.0 Header (USB7~12)

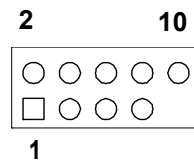

Table B.1: USB2.0 Header (USB7~12)

Pin	Signal	Pin	Signal
1	+5V_USB	2	+5V_USB
3	USB2_D1-	4	USB2_D2-
5	USB2_D1+	6	USB2_D2+
7	GND	8	GND
9	Key	10	N/C

B.2 USB3.1 Header (USB5_6)

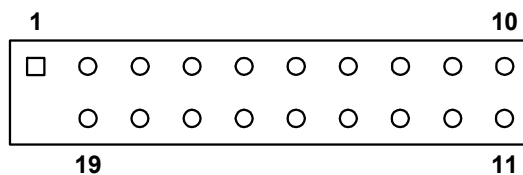

Table B.2: USB 3.1 Header (USB5_6)

Pin	Signal	Pin	Signal
1	+5V_USB	20	Key
2	USB3_RX_D1-	19	+5V_USB
3	USB3_RX_D1+	18	USB3_RX_D2-
4	GND	17	USB3_RX_D2+
5	USB3_TX_D1-	16	GND
6	USB3_TX_D1+	15	USB3_TX_D2-
7	GND	14	USB3_TX_D2+
8	USB2_D1-	13	GND
9	USB2_D1+	12	USB2_D2-
10	USB_OC	11	USB2_D2+

B.3 VGA Connector (VGA1)

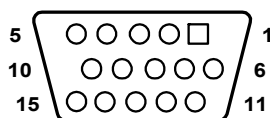

Table B.3: VGA Connector (VGA1)

Pin	Signal	Pin	Signal
1	RED	9	VCC
2	GREEN	10	GND
3	BLUE	11	N/C
4	N/C	12	SDA
5	GND	13	H-SYNC
6	GND	14	V-SYNC
7	GND	15	SCL
8	GND		

B.4 RS-232 Interface (COM1~2)

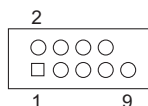

Table B.4: RS-232 Interface (COM1~2)

COM1/COM2	
Pin	Signal
1	DCD
2	DSR
3	RXD
4	RTS
5	TXD
6	CTS
7	DTR
8	RI
9	GND

B.5 External Keyboard and Mouse Connector (KBMS1)

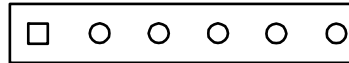

Table B.5: External Keyboard and Mouse Connector (KBMS1)

Pin	Signal
1	KB CLK
2	KB DATA
3	MS DATA
4	GND
5	VCC
6	MS CLK

B.6 System Fan Power Connector (SYSFAN0~3)

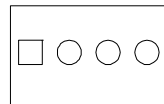

Table B.6: Fan Power Connector (SYSFAN0~3)

Pin	Signal
1	GND
2	+12 V
3	DETECT
4	PWM

B.7 Power LED and Keyboard Lock (JFP3)

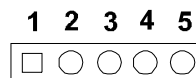

Table B.7: Power LED and Keyboard Lock (JFP3)

Pin	Signal
1	LED power + (3.3 V)
2	NC
3	LED power -
4	#keylock
5	Ground

B.8 External Speaker Connector (JFP2)

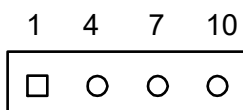

Table B.8: External Speaker Connector (JFP2)

Pin	Signal
1	SPK_VCC (+)
4	SPK_OBS
7	SPK_BUZ
10	SPK_OUT (-)

B.9 HDD LED Connector (JFP2)

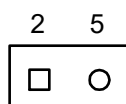

Table B.9: HDD LED Connector (JFP2)

Pin	Signal
2	HDD_LED+
5	HDD_LED-

B.10 SNMP SMBus Connector (JFP2)

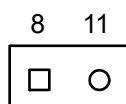

Table B.10: SNMP SMBus Connector (JFP2)

Pin	Signal
8	HWM_SDA
11	HWM_SCL

B.11 ATX Soft Power Switch (JFP1)

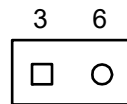

Table B.11: ATX Soft Power Switch (JFP1)

Pin	Signal
3	PWR-BTN
6	GND

B.12 Reset Connector (JFP1)

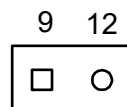

Table B.12: Reset Connector (JFP1)

Pin	Signal
9	RST-BTN
12	GND

B.13 Front Panel Audio Connector (FPAUD1)

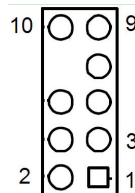

Table B.13: Front Panel Audio Connector (FPAUD1)

Pin	Signal	Pin	Signal
1	MIC2_L	2	AGND
3	MIC2_R	4	PRESENSE
5	LINE2_R	6	MIC2_JD
7	FRONT-IO_JD	8	Key
9	LINE2_L	10	LINE2_JD

B.14 8-pin Alarm Board Connector (VOLT1)

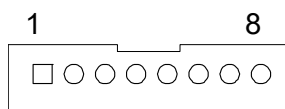

Table B.14: 8-pin Alarm Board Connector (VOLT1)

Pin	Signal	Pin	Signal
1	5VSB	5	VCC
2	GND	6	VCC3
3	GND	7	-12V
4	-5V	8	+12V

B.15 Case Open Connector (JCASE1)

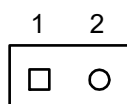

Table B.15: Case Open Connector (JCASE1)

Pin	Signal
1	CASEOP
2	GND

B.16 Front Panel LAN LED Connector (LAN_LED1)

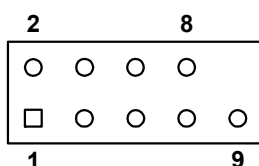

Table B.16: LAN LED Connector (LANLED1)

Pin	Signal	Pin	Signal
1	LAN1_LED_ACT#	2	LAN2_LED_ACT#
3	VCC3	4	VCC3
5	LAN3_LED_ACT#	6	LAN4_LED_ACT#
7	VCC3	8	VCC3
9	NC	10	N/C

B.17 SPI Flash Card Pin Connector (SPI_CN1)

Table B.17: SPI Flash Connector (SPI_CN1)

Pin	Signal	Pin	Signal
1	+3VSB	2	GND
3	SPI_CS#	4	SPI_CLK
5	SPI_MISO	6	SPI_MOSI
7	N/A	8	NC

B.18 GPIO Connector (GPIO1)

Table B.18: GPIO Connector (GPIO1)

Pin	Signal	Pin	Signal
1	SIO_GPIO0	2	SIO_GPIO4
3	SIO_GPIO1	4	SIO_GPIO5
5	SIO_GPIO2	6	SIO_GPIO6
7	SIO_GPIO3	8	SIO_GPIO7
9	VCC_GPIO0	10	GND

B.19 SMBUS Connector (SMBUS1)

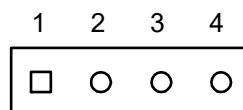

Table B.19: SMBUS Connector (SMBUS1)

Pin	Signal
1	+5V
2	Clock
3	Data
4	GND

B.20 PMBUS Connector (PMBUS1)



Table B.20: PMBUS Connector (PMBUS1)

Pin	Signal
1	SMB_SCL_PM
2	SMB_SDA_PM
3	SMB_ALT_PM
4	GND
5	+3.3V

B.21 System I/O Ports

Table B.21: System I/O Ports

Addr. range (Hex)	Device
000-01F	DMA controller
020-021	Interrupt controller 1, programmable interrupt controller
022-03F	Motherboard resources
040-043	System timer
060-060	Standard PS/2 Keyboard
064-064	Standard PS/2 Keyboard
070-077	Real-time clock, non-maskable interrupt (NMI) mask
081-091	DMA controller
0A0-0A1	Interrupt controller 2, programmable interrupt controller
0C0-0DF	DMA controller
0F0-0F0	Numeric data processor
A35-A36	On-board hardware monitor
2F8-2FF	Serial port 2
778-77F	Printer port (LPT1)
3B0-3BB	Intel HD Graphics
3C0-3DF	Intel HD Graphics
3F8-3FF	Serial port 1

B.22 Interrupt Assignments

Table B.22: Interrupt Assignments

Priority	Interrupt#	Interrupt source
1	NMI	Parity error detected
2	IRQ0	Interval timer
3	IRQ1	PS/2 Keyboard
-	IRQ2	Interrupt from controller 2 (cascade)
4	IRQ8	Real-time clock
5	IRQ9	Cascaded to INT 0A (IRQ 2)
6	IRQ10	Intel 8 series/C226 Chipset Family SMBus Controller
7	IRQ11	Available
8	IRQ12	PS/2 mouse
9	IRQ13	Numeric data processor
10	IRQ14	Available
11	IRQ15	Available
12	IRQ3	Serial communication port 2
13	IRQ4	Serial communication port 1
14	IRQ5	Available
15	IRQ6	Available
16	IRQ7	Parallel port 1 (print port)

B.23 1st MB Memory Map

Table B.23: 1st MB Memory Map

Addr. range (Hex)	Device
E0000h - FFFFFh	BIOS
D0000h - DFFFFh	Unused
C0000h - CFFFFh	VGA BIOS
A0000h - BFFFFh	Video Memory
00000h - 9FFFFh	Base memory

ADVANTECH

Enabling an Intelligent Planet

www.advantech.com

Please verify specifications before quoting. This guide is intended for reference purposes only.

All product specifications are subject to change without notice.

No part of this publication may be reproduced in any form or by any means, electronic, photocopying, recording or otherwise, without prior written permission of the publisher.

All brand and product names are trademarks or registered trademarks of their respective companies.

© Advantech Co., Ltd. 2020