



**User Manual**

## **IDP31-215W Series**

**21.5" Wide Screen Industrial  
ProFlat Projected Capacitive  
Touch Monitor**

**ADVANTECH**

*Enabling an Intelligent Planet*

---

## Copyright

The documentation and the software included with this product are copyrighted 2018 by Advantech Co., Ltd. All rights are reserved. Advantech Co., Ltd. reserves the right to improve the products described in this manual at any time without notice. No part of this manual may be reproduced, copied, translated, or transmitted in any form, or by any means, without the prior written permission of Advantech Co., Ltd. The information provided in this manual is intended to be accurate and reliable. However, Advantech Co., Ltd. assumes no responsibility for its use, nor for any infringements of the rights of third parties that may result from its use.

## Acknowledgements

Intel and Pentium are trademarks of Intel Corporation.

Microsoft Windows and MS-DOS are registered trademarks of Microsoft Corp.

All other product names or trademarks are properties of their respective owners.

## Product Warranty (2 years)

Advantech warrants the original purchaser that all of its products will be free from defects in materials and workmanship for two years from the date of purchase.

This warranty does not apply to any products that have been repaired or altered by persons other than repair personnel authorized by Advantech, or products that have been subject to misuse, abuse, accident, or improper installation. Under the terms of this warranty, Advantech assumes no liability for the consequence of such events.

Because of Advantech's high quality-control standards and rigorous testing, most customers never need to use our repair service. If an Advantech product is defective, it will be repaired or replaced free of charge during the warranty period. For out-of-warranty repairs, customers will be billed according to the cost of the replacement materials, service time, and freight. Please consult your dealer for more details.

If you suspect that your product is defective, follow the steps outlined below.

1. Collect all the information about the problem encountered. (For example, CPU speed, Advantech products used, other hardware and software used, etc.) Note anything abnormal and list any onscreen messages displayed when the problem occurs.
2. Call your dealer and describe the problem. Please have your manual, product, and all relevant information readily available.
3. If your product is diagnosed as defective, obtain a return merchandise authorization (RMA) number from your dealer. This allows us to process your return more quickly.
4. Carefully pack the defective product, a completed Repair and Replacement Order Card, and a proof of purchase date (such as a photocopy of your sales receipt) in a shippable container. Products returned without a proof of purchase date are not eligible for warranty service.
5. Write the RMA number clearly on the outside of the package and ship it prepaid to your dealer.

Part Number: 2006215W00

Printed in Taiwan

Edition 1

March 2018

# Declaration of Conformity

## CE

This product has passed the CE test for environmental specifications. Test conditions for passing included the equipment being operated within an industrial enclosure. In order to protect the product from damage due to electrostatic discharge (ESD) or electromagnetic interference (EMI) leakage, we strongly recommend the use of CE-compliant industrial enclosure products.

## FCC Class A

This equipment has been tested and found to comply with the limits for a Class A digital device, pursuant to part 15 of the FCC Rules. These limits are designed to provide reasonable protection against harmful interference when the equipment is operated in a commercial environment. This equipment generates, uses, and can radiate radio frequency energy and, if not installed and used in accordance with the instruction manual, may cause harmful interference to radio communications. Operation of this equipment in a residential area is likely to cause harmful interference. In such cases, users are required to correct the interference at their own expense.

# Technical Support and Assistance

1. Visit the Advantech website at <http://support.advantech.com> to obtain the latest product information.
2. Contact your distributor, sales representative, or Advantech's customer service center for technical support or additional assistance. Please have the following information ready before calling:
  - Product name and serial number
  - Description of your peripheral attachments
  - Description of your software (operating system, version, application software, etc.)
  - Comprehensive description of the problem
  - The exact wording of any error messages

---

## Warnings, Cautions, and Notes

**Warning!** Warnings indicate conditions that if not observed can result in personal injury!



**Caution!** Cautions are included to prevent hardware damage or data losses.



New batteries are at risk of exploding if incorrectly installed. Do not attempt to recharge, force open, or heat the battery. Replace the battery only with the same or equivalent type recommended by the manufacturer. Discard used batteries according to the manufacturer's instructions.

**Note!** Notes provide additional optional information.



## Document Feedback

To assist us in improving this manual, we welcome all comments and constructive criticism. Please send all feedback in writing to [support@advantech.com](mailto:support@advantech.com)

# Safety Instructions

1. Read these safety instructions carefully.
2. Retain this user manual for future reference.
3. Disconnect this equipment from all AC outlets before cleaning. Use a damp cloth to clean the equipment. Do not use liquid or spray detergents.
4. For plugable equipment, the power outlet socket should be located near the equipment and easily accessible.
5. Protect the equipment from humidity.
6. Place this equipment on a reliable surface during installation. Dropping or letting the equipment fall may cause damage.
7. The openings of the enclosure are for air convection. Prevent the equipment from overheating. Do not cover the openings.
8. Ensure that the voltage is correct before connecting the equipment to a power outlet.
9. Position the power cord away from high-traffic areas. Do not place anything over the power cord.
10. All cautions and warnings on the equipment should be noted.
11. If idle for a long duration, disconnect the equipment from the power source to avoid damage from transient overvoltage.
12. Never pour liquid into an opening. This may cause fire or electrical shock.
13. Never open the equipment. For safety reasons, the equipment should only be opened by qualified service personnel.
14. If one of the following occurs, have the equipment checked by service personnel:
  - The power cord or plug is damaged.
  - Liquid has penetrated into the equipment.
  - The equipment has been exposed to moisture.
  - The equipment is malfunctioning or does not function according to the user manual.
  - The equipment has been dropped or damaged.
  - The equipment shows obvious signs of breakage.
15. Do not store this equipment in an environment where the temperature fluctuates below  $-20\text{ }^{\circ}\text{C}$  ( $-4\text{ }^{\circ}\text{F}$ ) or above  $60\text{ }^{\circ}\text{C}$  ( $140\text{ }^{\circ}\text{F}$ ) because this could damage the equipment. The equipment should be stored in a controlled environment.
16. The sound pressure level at the operator's position does not exceed 70 dB (A) in accordance with IEC 704-1:1982.

DISCLAIMER: These instructions are provided according to IEC 704-1. Advantech disclaims all responsibility for the accuracy of any statements contained herein.

**Caution!** *Information regarding the adapter output rating (12 V<sub>DC</sub>, 5 A/18 W min) is provided in the user manual to assist with adaptor selection if a power adapter is not shipped with the unit.*





# Contents

<b>Chapter 1</b>	<b>Overview .....</b>	<b>1</b>
1.1	Introduction .....	2
1.2	Features .....	2
1.3	Applications .....	2
1.4	Product Photos .....	2
1.5	Naming Rule .....	3
<b>Chapter 2</b>	<b>System Setup .....</b>	<b>5</b>
2.1	Specifications .....	6
2.2	Rear Mount Assembly .....	7
2.3	Packing List .....	7
<b>Chapter 3</b>	<b>Touchscreen .....</b>	<b>9</b>
3.1	OSD Functions .....	10
3.2	OSD Menu Details .....	11
3.2.1	Luminance .....	11
3.2.2	Image Setup .....	12
3.2.3	Color Temperature .....	14
3.2.4	OSD Setup .....	15
3.2.5	Extra .....	16
3.3	Touch Drivers .....	19
<b>Appendix A</b>	<b>Troubleshooting .....</b>	<b>21</b>
A.1	Introduction .....	22
A.2	Troubleshooting .....	22





# Chapter 1

## Overview

- Introduction
- Features
- Applications
- Product Photos
- Naming Rule

---

## 1.1 Introduction

Advantech's IDP31-215W series is a brand new Industrial ProFlat Touch Monitor, designed for quick and easy integration for different applications, such as public signage, front of house information, medical and point-of-sale.

## 1.2 Features

- 21.5" Full HD panel with LED backlight, offering 20 ~ 30% power savings
- 0 ~ 45 °C operating temperature
- Special design of the Projected Capacitive Touchscreen
- All new ProFlat design with the front glass from edge to edge
- Rear VESA mounting (100 x 100 mm)

## 1.3 Applications

Application scenarios

- KIOSK / POI machine
- Transportation machine
- Ticketing machine
- Financial ATM
- Entertainment / Gaming / Slot machine
- Human-Machine Interface equipment controller monitor
- Public communication machine
- Public advertisement machine

## 1.4 Product Photos

Front View

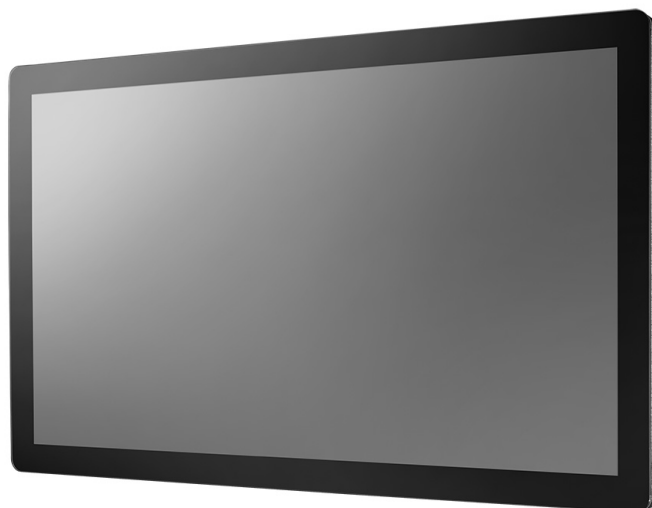

## 1.5 Naming Rule

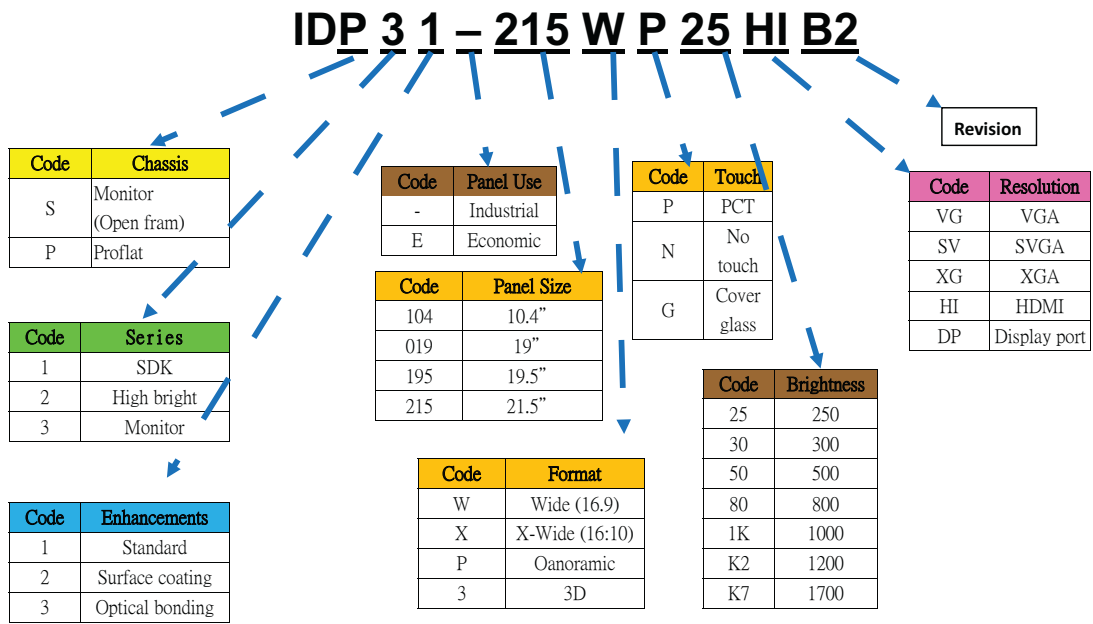



# Chapter 2

## System Setup

- Specifications
- Dimensions
- Rear Mount Assembly
- Cable Clamp
- Packing List

## 2.1 Specifications

**Note!** The IDP31-215W offers the following features.



Unless otherwise indicated, all the specifications listed below are subject to change without prior notification.

	Model	IDP31-215W
<b>Display</b>	Size	21.5" LED panel
	Resolution	1920 x 1080 (Full HD)
	Viewing Angle	178°/178° (H/V)
	Brightness	250 (cd/m <sup>2</sup> )
	Color Support	16.7 M colors
	Contrast Ratio	1000:1
	Response Time	25 [msec]
	Backlight Life	30,000 hrs
<b>Touch</b>	Touchscreen Type	Projected capacitive
	Surface Hardness	6H
	Durability	10 million touches
	Transparency	86%
<b>Environment</b>	Operating Temperature	0 ~ 45 °C
	Storage Temperature	-20 ~ 60 °C
	Humidity	90% @ 40 °C, non-condensing
<b>System</b>	I/O	HDMI x 1; VGA x 1; DVI-D x 1 Audio x 1 (audio output 3W) 12 VDC Jack x 1; USB x 1
	OSD	Keys: Power On/Off, Menu/Enter, Left/Up, Right/Down, Exit/Auto, Source Menu Functions: Brightness, Contrast, Screen Settings, Color Temperature, OSD Language, Reset, Auto Adjust
	Power Input	12V <sub>DC</sub> ± 5% with barrel connector (5.5 x 2.5 mm)
	Power Consumption	16.95 W

## 2.2 Rear Mount Assembly

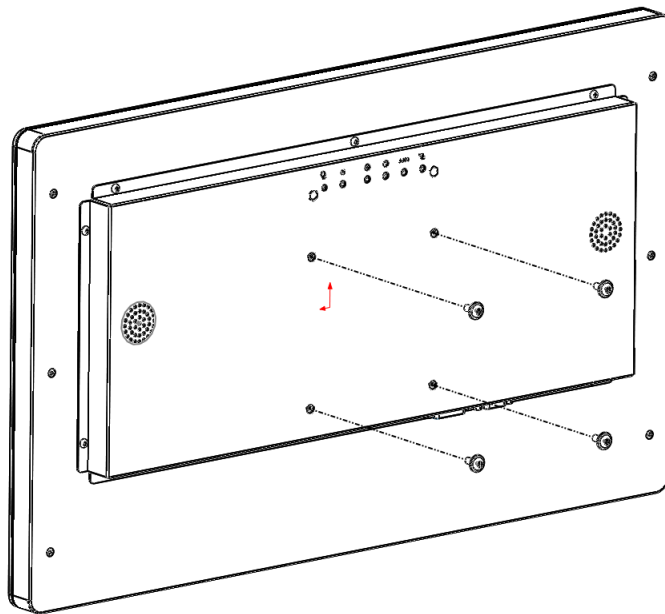

**Note!** Suggested screws M4x10L



## 2.3 Packing List

- 1 x VGA cable 15P (M), 1.8 meter
- 1 x USB-A(M)/USB-A (M), 1.8 meter
- 1 x 60 W 12 V<sub>DC</sub> power adapter (upon request)
- 1 x Power cord (upon request)
- 1 x DVI cable, 2.0 meter (upon request)
- 1 x HDMI cable, 1.2 or 1.5 meter (upon request)

**Note!** The accessory cables listed above may differ according to SKU.







# Chapter 3

## Touchscreen

- OSD Functions
- Touch Drivers

## 3.1 OSD Functions

IDP31-215W is equipped with 1920 x 1080 display resolution and the following OSD features:

<b>Buttons</b>	<b>Description</b>
Power	Turn the monitor power ON or OFF
Menu	Activate the OSD menu Select
Auto/Exit	Automatically adjust the clock, phase H-position and V-position
Value Up/Down	Move the selector to the previous option Reduce the value of the selected option

### **LED Function**

DPMS ON	Green
DPMS STANDBY	Orange
DPMS OFF	Red

<b>Hot Key</b>	<b>Function</b>
Value Up	Volume
Value Down	ECO mode

## 3.2 OSD Menu Details

### 3.2.1 Luminance

#### Contrast

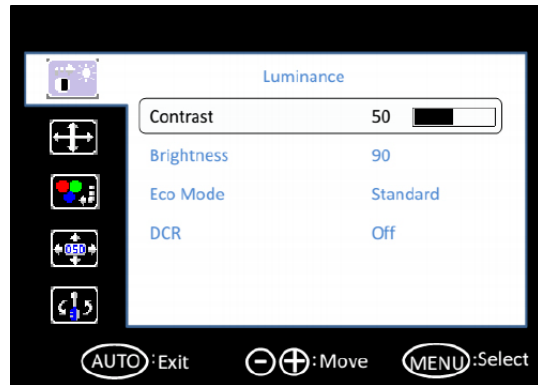
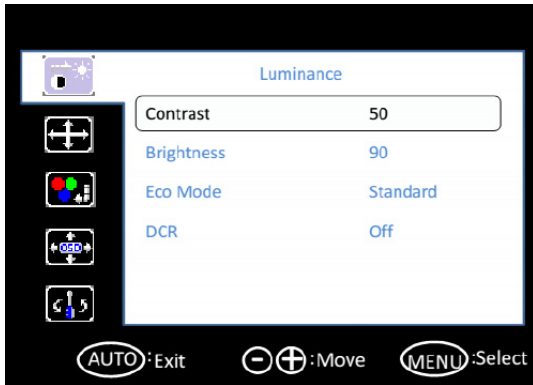

#### Brightness

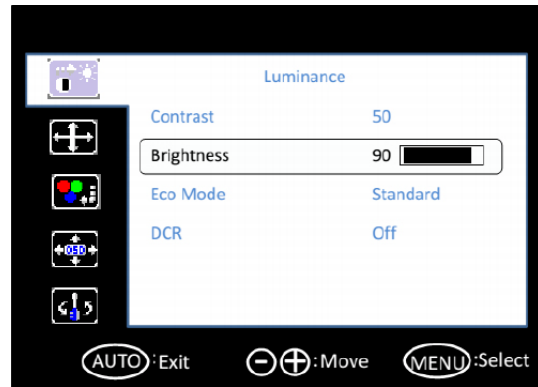
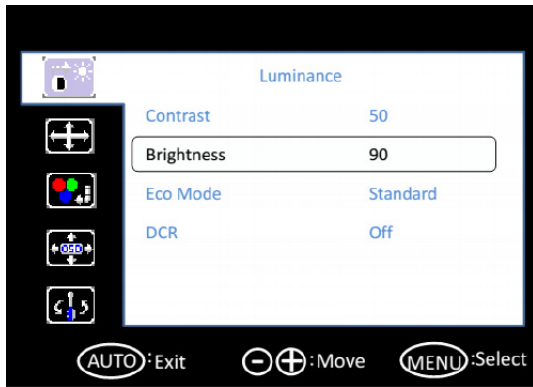

#### Eco Mode

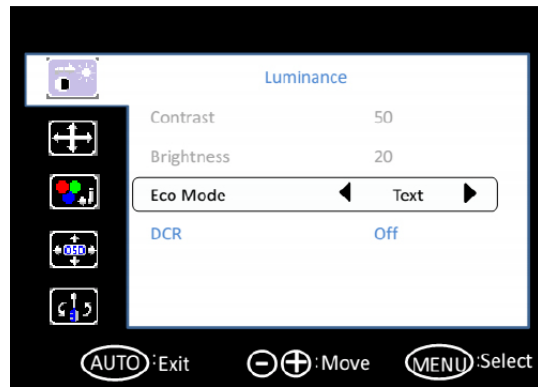
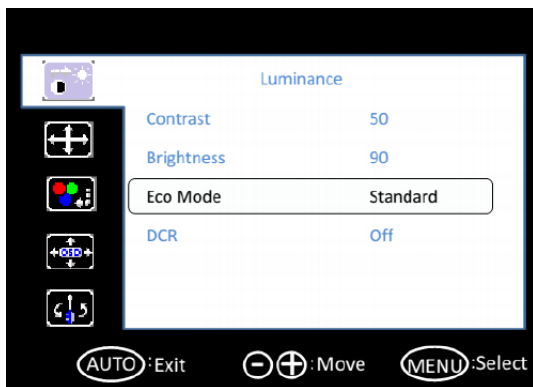

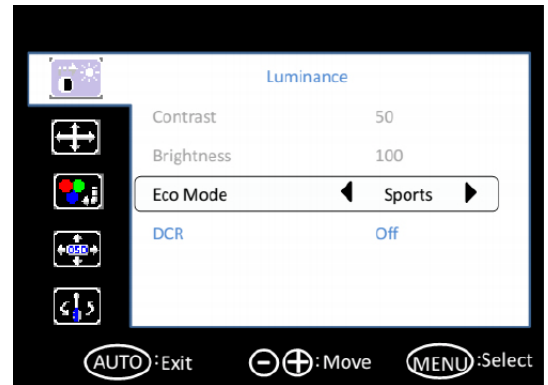
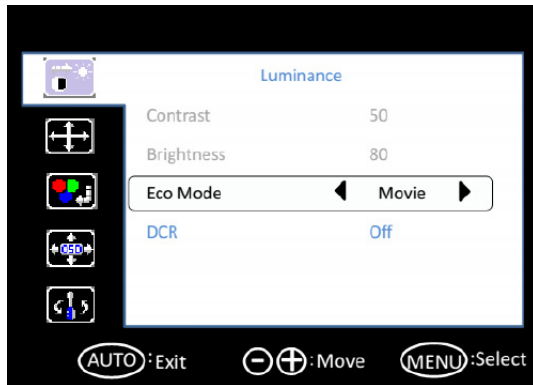
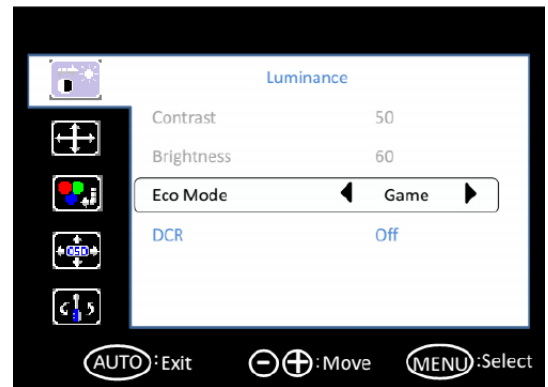
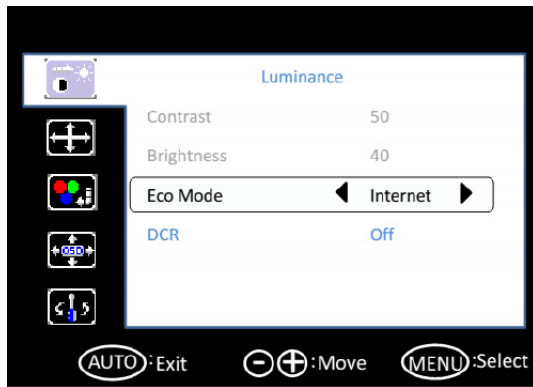

### DCR

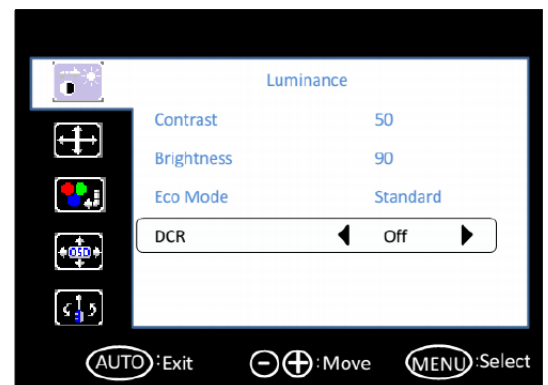
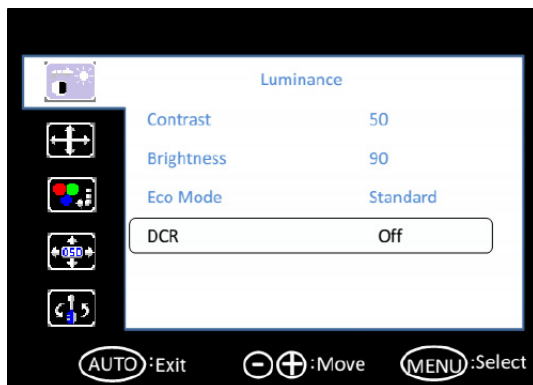

## 3.2.2 Image Setup

### Clock

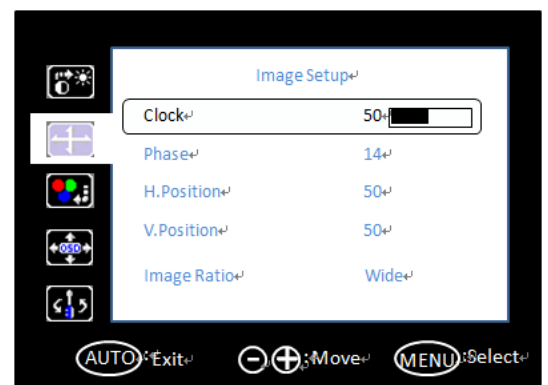
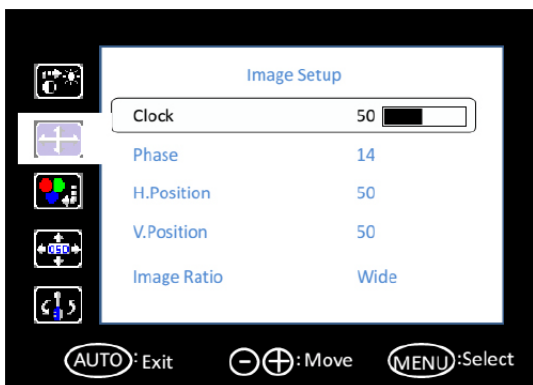

## Phase

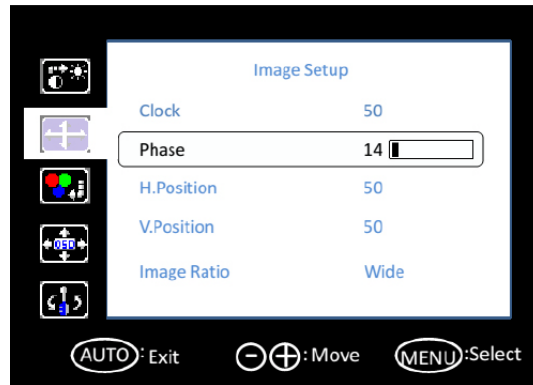
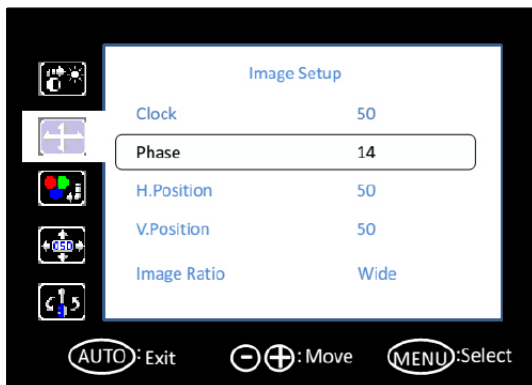

## H. Position



## V. Position

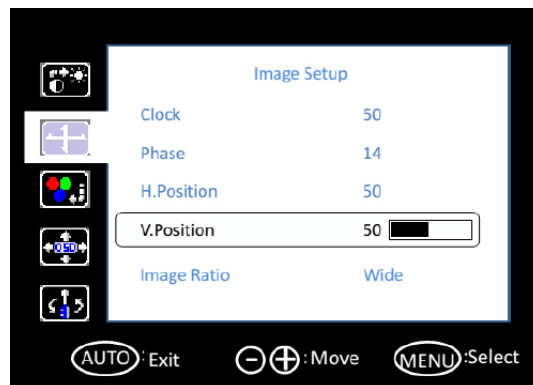
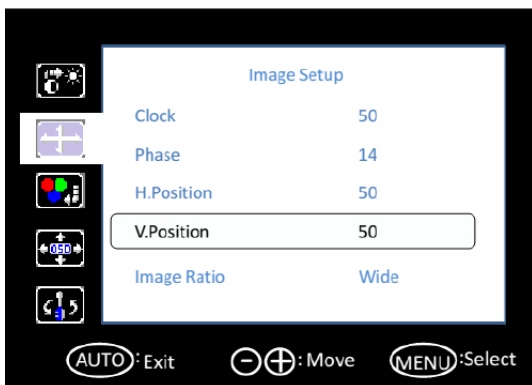

## Image Ratio

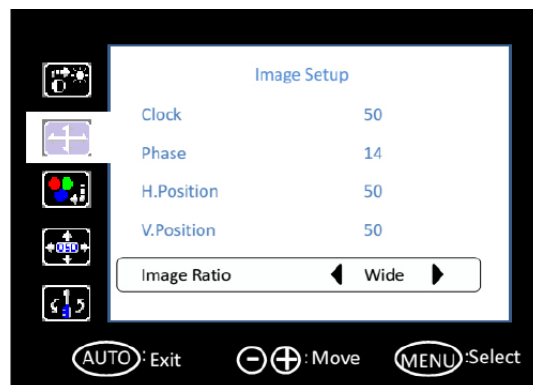
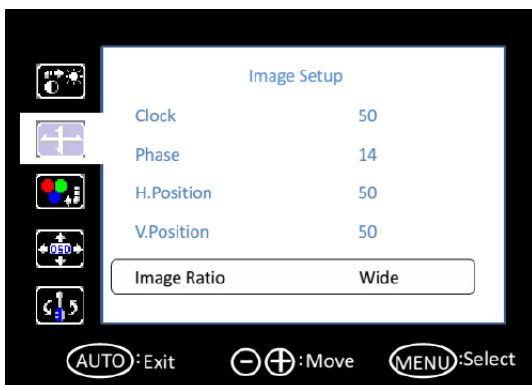

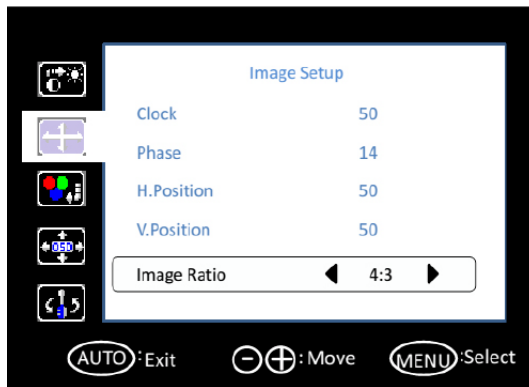

### 3.2.3 Color Temperature

#### Color Temperature

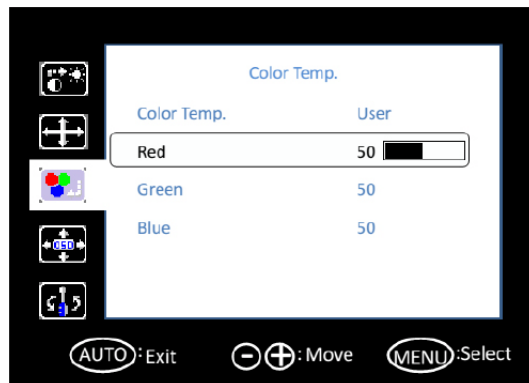
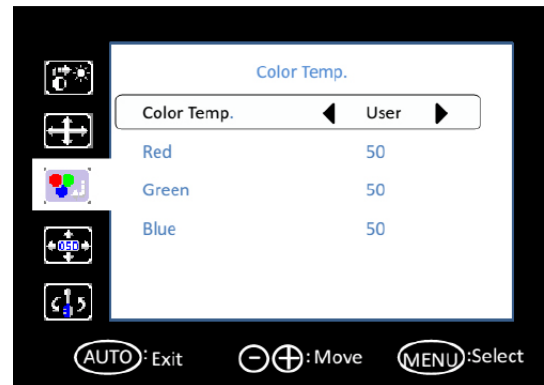
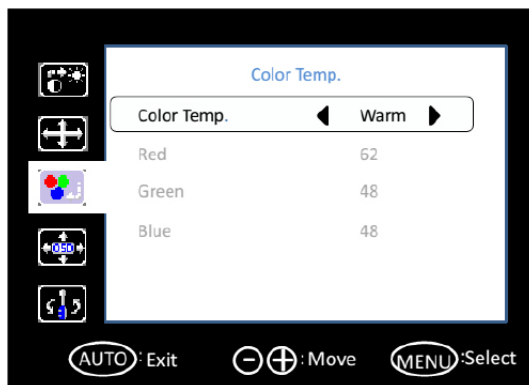
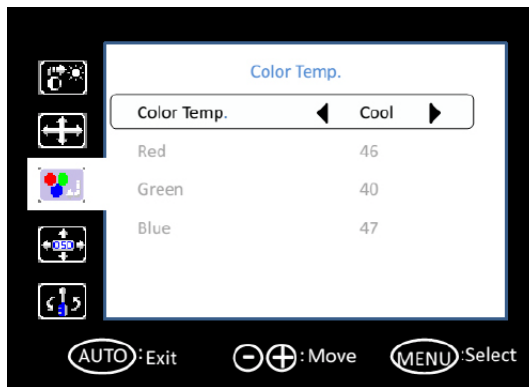

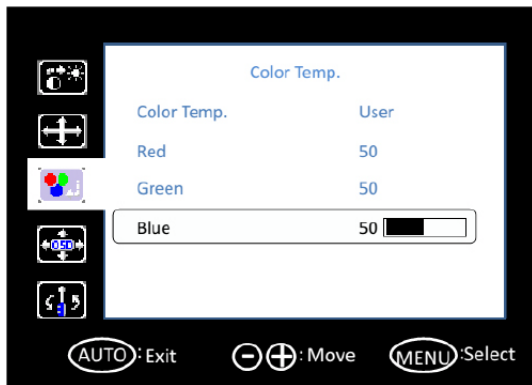

### 3.2.4 OSD Setup

#### H. Position

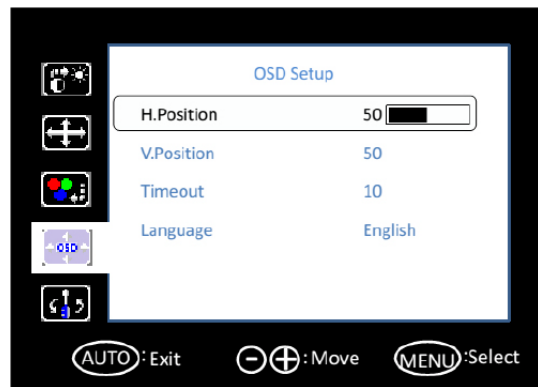
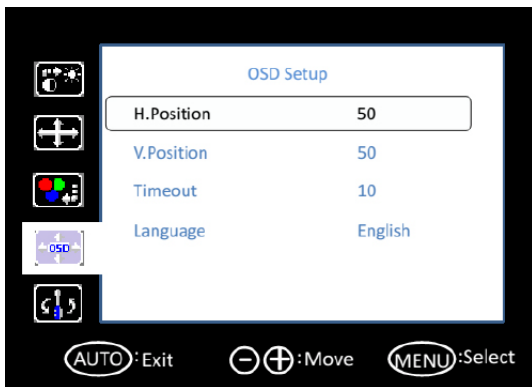

#### V. Position

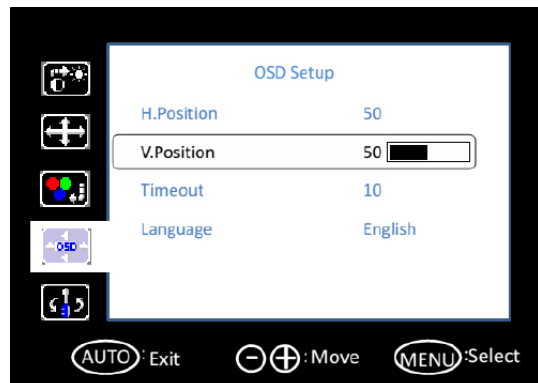
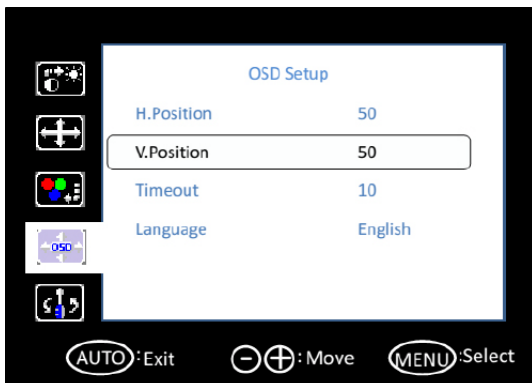

#### Timeout

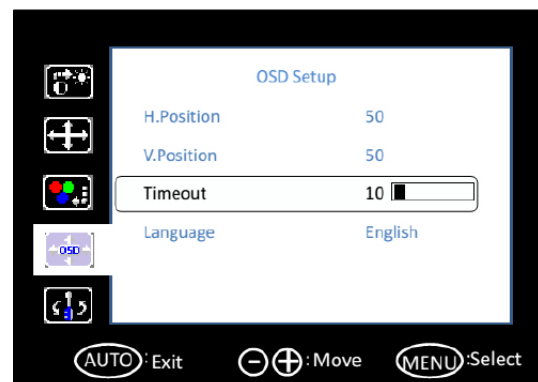
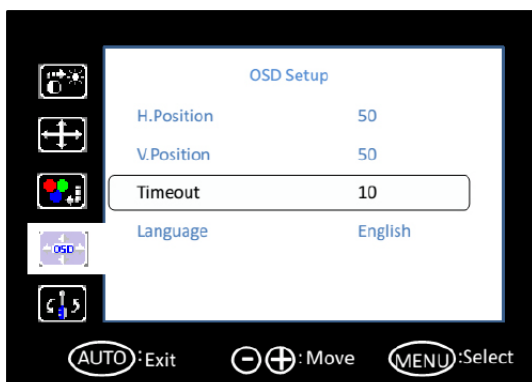

## Language



## 3.2.5 Extra

### Input Select

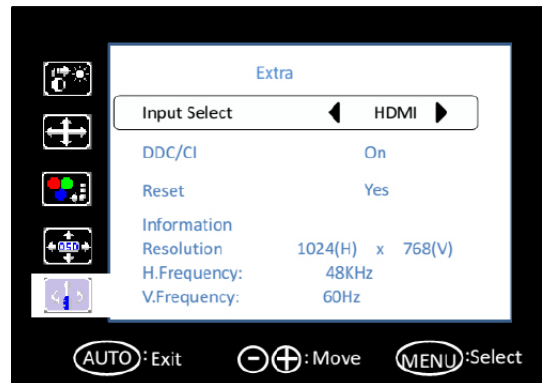
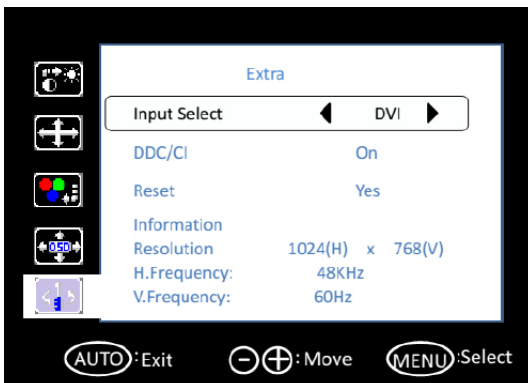
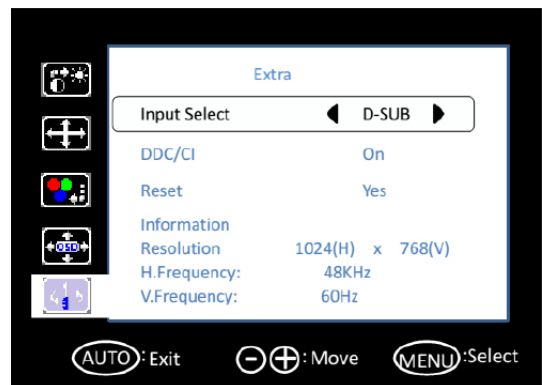
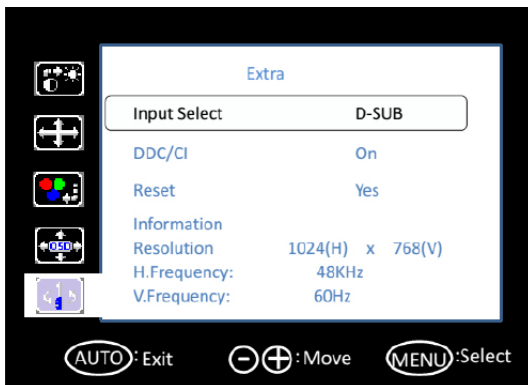



### DDC/CI

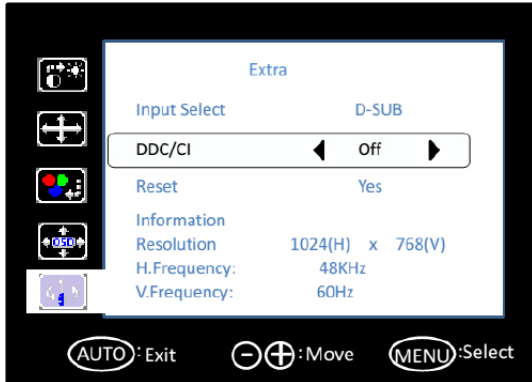
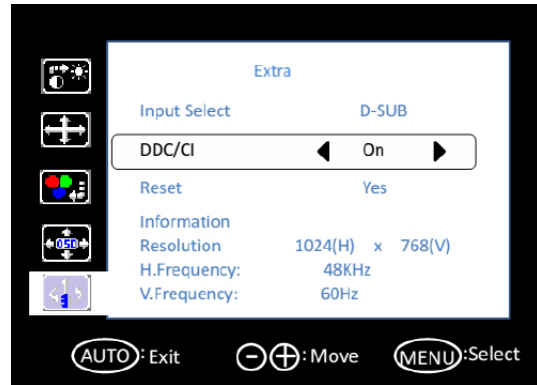
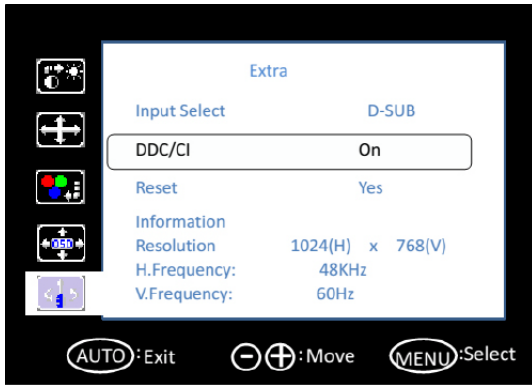

### Reset

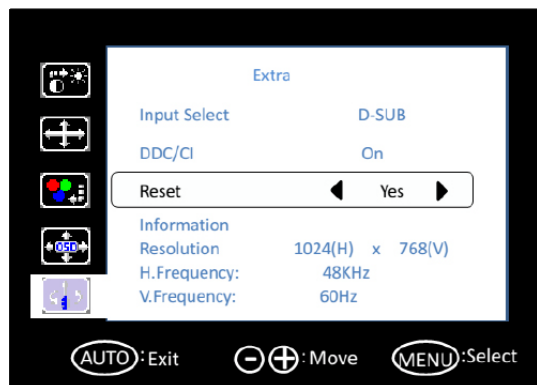
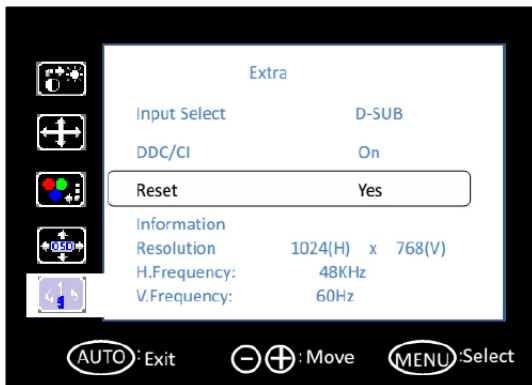

Layer 1	Layer 2	Layer 3	Comment	Default Value
Luminance	Contrast	0	Adjust contrast	50
		100		
	Brightness	0	Adjust brightness (backlight)	90
		100		
	ECO Mode	Standard		Standard
		Sport		
		Movie		
		Game		
		Internet		
		Text		
DCR	On	Set dynamic contrast ratio	Off	
	Off			
Image setup	Clock	0	Adjust clock latency of output capture window	Depends on the input resolution
		100		
	Phase	0	Adjust clock phase of output capture window	Depends on the input resolution
		100		
	H. Position	0	Adjust horizontal position of output capture window	50
		100		
V. Position	0	Adjust vertical position of output capture window	50	
	100			
Image Ratio	Wide	Adjust aspect ratio to full screen	Wide	
	4:3	Adjust aspect ratio to 4:3 screen		
Color Temperature	Color Temp.	Warm -->	Adjust color temperature to warm	User
		Normal -->	Adjust color temperature to normal	
		Cool -->	Adjust color temperature to cool	
		User -->	Adjust color temperature to user defined	
OSD Setup	H. Position	0	Adjust OSD horizontal position	50
		100		
	V. Position	0	Adjust OSD vertical position	50
		100		
	Timeout	5	Set OSD timeout counter	10
		100		
Language	English	Set OSD display language	English	
	Spanish			
	French			
	Portuguese			
	Russian			
	简体中文			
	繁體中文			
	Korean			

Extra	Input Select	D-Sub	Set input source	Depends on the input source
		HDMI		
		DVI		
	DDC/CI	On Off	Set DDC/CI function on/off	On
Reset	Yes	Set user setting reset	On	
	No			
Information	Resolution	Display current source information	Depends on the input source	
	H. Frequency			
	V. Frequency			

### 3.3 Touch Drivers

The touchscreen driver is available online at the Advantech website. Use the following link to access the driver: <http://support.advantech.com/support/default.aspx>



# Appendix **A**

## Troubleshooting

---

## A.1 Introduction

If the monitor is malfunctioning or does not operate according to the user manual, refer to the following instructions before calling the Advantech service center.

If unable to correct the faults using the instructions provided below, please contact your distributor or the Advantech service center.

## A.2 Troubleshooting

### **The image is displayed incorrectly/the full screen image does not appear**

- Ensure that the screen resolution on the motherboard is correct.

### **The screen image is not centered**

- Adjust the horizontal and vertical position of the OSD or select the “Auto” option for automatic adjustment.

### **Out of range**

- If an “Out of Range” message appears onscreen, this indicates that the display output signal is not compatible with the LCD display (for example, the output resolution exceeds the LCD display resolution).
- Adjust the BIOS settings to match the correct resolution.

### **No signal**

- The display is powered on but is not receiving or displaying output signals from the computer. Check all power switches, power cables, and VGA signal cables and ensure that both ends of all cables are properly connected.

### **Going to sleep**

- If the system goes to sleep, either the display has been set to power-saving mode or is experiencing a sudden signal disconnection problem. Check the BIOS system settings and/or Windows configuration. Then check both ends of the power cable connected to the computer.



**ADVANTECH**

*Enabling an Intelligent Planet*

**[www.advantech.com](http://www.advantech.com)**

Please verify specifications before quoting. This guide is intended for reference purposes only.

All product specifications are subject to change without notice.

No part of this publication may be reproduced in any form or by any means, such as electronically, by photocopying, recording, or otherwise, without prior written permission from the publisher.

All brand and product names are trademarks or registered trademarks of their respective companies.

© Advantech Co., Ltd. 2018