

## MIO-3260

**Intel® Atom™ E3825 & Celeron® N2930 Pico-ITX SBC, DDR3L, 18/24-bit LVDS, VGA, DP/HDMI, 1 GbE, Full-size Mini PCIe, 4 USB, 2 COM, SMBus, I2C, mSATA & MIOe**

---

## Copyright

The documentation and the software included with this product are copyrighted 2017 by Advantech Co., Ltd. All rights are reserved. Advantech Co., Ltd. reserves the right to make improvements in the products described in this manual at any time without notice.

No part of this manual may be reproduced, copied, translated or transmitted in any form or by any means without the prior written permission of Advantech Co., Ltd. Information provided in this manual is intended to be accurate and reliable. However, Advantech Co., Ltd. assumes no responsibility for its use, nor for any infringements of the rights of third parties, which may result from its use.

## Acknowledgements

AMI is a trademark of AMI Software International, Inc.

Intel® is a trademark of Intel® Technologies, Inc.

IBM, PC/AT, PS/2 and VGA are trademarks of International Business Machines Corporation.

Intel® and Atom™ are trademarks of Intel® Corporation.

Microsoft® Windows® is a registered trademark of Microsoft Corp.

All other product names or trademarks are properties of their respective owners.

## Product Warranty (2 years)

Advantech warrants to you, the original purchaser, that each of its products will be free from defects in materials and workmanship for two years from the date of purchase.

This warranty does not apply to any products which have been repaired or altered by persons other than repair personnel authorized by Advantech, or which have been subject to misuse, abuse, accident or improper installation. Advantech assumes no liability under the terms of this warranty as a consequence of such events.

Because of Advantech's high quality-control standards and rigorous testing, most of our customers never need to use our repair service. If an Advantech product is defective, it will be repaired or replaced at no charge during the warranty period. For out-of-warranty repairs, you will be billed according to the cost of replacement materials, service time and freight. Please consult your dealer for more details.

If you think you have a defective product, follow these steps:

1. Collect all the information about the problem encountered. (For example, CPU speed, Advantech products used, other hardware and software used, etc.) Note anything abnormal and list any onscreen messages you get when the problem occurs.
2. Call your dealer and describe the problem. Please have your manual, product, and any helpful information readily available.
3. If your product is diagnosed as defective, obtain an RMA (return merchandise authorization) number from your dealer. This allows us to process your return more quickly.
4. Carefully pack the defective product, a fully-completed Repair and Replacement Order Card and a photocopy proof of purchase date (such as your sales receipt) in a shippable container. A product returned without proof of the purchase date is not eligible for warranty service.
5. Write the RMA number visibly on the outside of the package and ship it prepaid to your dealer.

---

# Declaration of Conformity

## CE

This product has passed the CE test for environmental specifications. Test conditions for passing included the equipment being operated within an industrial enclosure. In order to protect the product from being damaged by ESD (Electrostatic Discharge) and EMI leakage, we strongly recommend the use of CE-compliant industrial enclosure products.

## FCC Class A

This equipment has been tested and found to comply with the limits for a Class A digital device, pursuant to Part 15 of the FCC Rules. These limits are designed to provide reasonable protection against harmful interference when the equipment is operated in a commercial environment. This equipment generates, uses, and can radiate radio frequency energy and, if not installed and used in accordance with the instruction manual, may cause harmful interference to radio communications. Operation of this device in a residential area is likely to cause harmful interference in which case the user will be required to correct the interference at his/her own expense. The user is advised that any equipment changes or modifications not expressly approved by the party responsible for compliance would void the compliance to FCC regulations and therefore, the user's authority to operate the equipment.

**Caution!** *There is a danger of a new battery exploding if it is incorrectly installed. Do not attempt to recharge, force open, or heat the battery. Replace the battery only with the same or equivalent type recommended by the manufacturer. Discard used batteries according to the manufacturer's instructions.*



## Technical Support and Assistance

1. Visit the Advantech web site at [www.advantech.com/support](http://www.advantech.com/support) where you can find the latest information about the product.
2. Contact your distributor, sales representative, or Advantech's customer service center for technical support if you need additional assistance. Please have the following information ready before you call:
  - Product name and serial number
  - Description of your peripheral attachments
  - Description of your software (operating system, version, application software, etc.)
  - A complete description of the problem
  - The exact wording of any error messages

## Packing List

Before installation, please ensure the following items have been shipped:

- 1 MIO-3260 SBC
- 1 Startup manual
- Cables:

Part Number	Description
1700006291	SATA cable 7P 30 cm w/ right angle
1700023340-01*	Power Cable 2*2P-4.2/2*4P-2.0 10cm
1700023339-01*	Inverter and SATA power Cable 2*3P-2.0/1*5P-1.25 15cm
1700023341-01*	VGA Cable 15P(F)/2*6P-2.0 15CM
1700019000*	USB Cable 2*5P-2.0/USB-A(F)*2 w/Bracket 26CM w/ Locked (for CN5)
1700002172*	USB Cable 2*5P-2.0/USB-A(F) 17CM (for CN10)
1700019001*	LAN Cable RJ-45/2*5P-2.0 15cm w/locked
1700019584*	Audio Cable 2*5P-2.0/Audio JACK*3 20cm
1701200220*	COM Cable 2*10P-2.0/D-SUB 9P(M)*2 22CM

- Heatsink:

1960063455T001	99.5 x 70.5 x 15.7 mm
----------------	-----------------------

- Stud & Screw

Part Number	Description
9666226200E	Stud and screw pack, including:
1935031500	Screw R/S D=5.3 H=2 + M3*15L, 4 pcs
1910002303	POST F=M3*5.0L M=M3*4L B=5.0 H=8.0 Cu, 4 pcs
193B0204C0	Screw F/S D=3.5 H=0.8 + M2*4L, 2 pcs
9666226300E*	Stud and screw pack, including:
1935031500	Screw R/S D=5.3 H=2 + M3*15L, 4 pcs
1910002596-01	Stud F=M3*10L M=M3*5L B=5 H=19, 4 pcs
193B0204C0	Screw F/S D=3.5 H=0.8 + M2*4L, 2 pcs

\* Only for MIO-3260C-S8A1E

## Ordering Information

Model Number	Description
MIO-3260L-S3A1E	Intel® Atom™ SoC E3825, fanless, LVDS, SATA, mini PCIe, MIOe, 64-pin
MIO-3260L-S8A1E	Intel® Celeron® SoC N2930, fanless, LVDS, SATA, mini PCIe, MIOe, 64-pin
MIO-3260C-S8A1E	Intel® Celeron® SoC N2930, fanless, LVDS, mini PCIe, MIOe, Box Wafer

## Optional Accessories

Part No.	Description
1960065074N001	Heat Spreader (99.5 x 70.5 x 11.2 mm)
MIOE-DB2100-00A1E	MIO-3260 Evaluation Board
1700024079-01	LAN w/LED cable RJ45-8P8C/2*7P-2.0 15cm (Only for MIO-3260C, LAN w/LED connector is supported by request)

---

## Safety Instructions

1. Read these safety instructions carefully.
2. Keep this User Manual for later reference.
3. Disconnect this equipment from any AC outlet before cleaning. Use a damp cloth. Do not use liquid or spray detergents for cleaning.
4. For plug-in equipment, the power outlet socket must be located near the equipment and must be easily accessible.
5. Keep this equipment away from humidity.
6. Put this equipment on a reliable surface during installation. Dropping it or letting it fall may cause damage.
7. The openings on the enclosure are for air convection. Protect the equipment from overheating. **DO NOT COVER THE OPENINGS.**
8. Make sure the voltage of the power source is correct before connecting the equipment to the power outlet.
9. Position the power cord so that people cannot step on it. Do not place anything over the power cord.
10. All cautions and warnings on the equipment should be noted.
11. If the equipment is not used for a long time, disconnect it from the power source to avoid damage by transient overvoltage.
12. Never pour any liquid into an opening. This may cause fire or electrical shock.
13. Never open the equipment. For safety reasons, the equipment should be opened only by qualified service personnel.
14. If one of the following situations arises, get the equipment checked by service personnel:
  - The power cord or plug is damaged.
  - Liquid has penetrated into the equipment.
  - The equipment has been exposed to moisture.
  - The equipment does not work well, or you cannot get it to work according to the user's manual.
  - The equipment has been dropped and damaged.
  - The equipment has obvious signs of breakage.
15. **DO NOT LEAVE THIS EQUIPMENT IN AN ENVIRONMENT WHERE THE STORAGE TEMPERATURE MAY GO BELOW -20° C (-4° F) OR ABOVE 60° C (140° F). THIS COULD DAMAGE THE EQUIPMENT. THE EQUIPMENT SHOULD BE IN A CONTROLLED ENVIRONMENT.**
16. **CAUTION: DANGER OF EXPLOSION IF BATTERY IS INCORRECTLY REPLACED. REPLACE ONLY WITH THE SAME OR EQUIVALENT TYPE RECOMMENDED BY THE MANUFACTURER, DISCARD USED BATTERIES ACCORDING TO THE MANUFACTURER'S INSTRUCTIONS.**

The sound pressure level at the operator's position according to IEC 704-1:1982 is no more than 70 dB (A).

**DISCLAIMER:** This set of instructions is given according to IEC 704-1. Advantech disclaims all responsibility for the accuracy of any statements contained herein.

## Safety Precaution - Electricity

Follow these simple precautions to protect yourself from harm and the products from damage.

- To avoid electrical shock, always disconnect the power from your PC chassis before you work on it. Don't touch any components on the CPU card or other cards while the PC is on.
- ESD (electrostatic discharge) can cause either catastrophic or latent damage in sensitive electronic components. Take appropriate measures to ensure that any accumulated body charge is removed before accessing electronic devices. A static-safe workbench is ideal.





# Contents

<b>Chapter 1</b>	<b>General Introduction .....</b>	<b>1</b>
1.1	Introduction .....	2
1.2	Specifications .....	2
1.2.1	General Specifications .....	2
1.2.2	Functional Specifications .....	3
1.2.3	Mechanical Specifications .....	4
1.2.4	Electrical Specifications .....	4
1.2.5	Environmental Specifications .....	4
1.3	Function Block Diagram .....	5
<b>Chapter 2</b>	<b>H/W Installation.....</b>	<b>7</b>
2.1	Jumpers .....	8
2.1.1	Jumper Description .....	8
2.1.2	Jumper List .....	8
	Table 2.1: Jumper List .....	8
2.1.3	Jumper Settings .....	8
	Table 2.2: J1: LCD Power/Auto Power on .....	8
	Table 2.3: J2: Mini PCIE / mSATA Select .....	9
2.2	Connectors .....	9
2.2.1	Connector List .....	9
2.2.2	Connector Settings .....	9
2.3	Mechanical .....	10
2.3.1	Jumper and Connector Locations .....	10
	Figure 2.1 MIO-3260 Connector Location (Top Side).....	10
	Figure 2.2 MIO-3260L Connector Location (Bottom Side) .....	10
	Figure 2.3 MIO-3260C Connector Location (Bottom Side).....	11
2.3.2	Board Dimensions .....	11
	Figure 2.4 MIO-3260 Mechanical Drawing (Top View).....	11
	Figure 2.5 MIO-3260L Mechanical Drawing (Bottom View).....	12
	Figure 2.6 MIO-3260C Mechanical Drawing (Bottom View) .....	12
	Figure 2.7 MIO-3260 Mechanical Drawing (Side View with Heat-sink).....	12
	Figure 2.8 MIO-3260 Mechanical Drawing (Side View with Heat-spreader) .....	13
2.3.3	Quick Installation Guide .....	13
2.3.4	Optional Thermal Solution - Heat Spreader .....	14
<b>Chapter 3</b>	<b>BIOS Settings.....</b>	<b>15</b>
3.1	BIOS Setup .....	16
3.2	Entering Setup .....	17
3.2.1	Main Setup .....	17
3.2.2	Advanced BIOS Features Setup .....	18
3.2.3	Chipset configuration .....	31
3.2.4	Security .....	40
3.2.5	Boot .....	41
3.2.6	Save & Exit .....	42
<b>Chapter 4</b>	<b>S/W Introduction &amp; Installation .....</b>	<b>43</b>
4.1	S/W Introduction.....	44

4.2	Driver Installation .....	44
4.2.1	Driver Installation .....	44
4.3	Value-Added Software Services .....	44
4.3.1	SUSI Introduction.....	44
4.3.2	Software APIs .....	44
4.3.3	SUSI Installation .....	45
4.3.4	SUSI Sample Programs.....	47

## **Appendix A      PIN Assignments ..... 59**

A.1	Jumper Setting.....	60
	Table A.1: Jumper List.....	60
A.2	Connectors.....	60
	Table A.2: J1: LCD Power/Auto Power On.....	60
	Table A.3: J2: Mini PCIE / mSATA Select .....	60
	Table A.4: 64-Pin Connector B.....	65

## **Appendix B      WDT & GPIO ..... 77**

B.1	Watchdog Timer Sample Code.....	78
B.2	GPIO Sample Code .....	79

## **Appendix C      System Assignments..... 81**

C.1	System I/O Ports.....	82
	Table C.1: System I/O Ports .....	82
C.2	1st MB Memory Map.....	82
	Table C.2: 1st MB Memory Map .....	82
C.3	Interrupt Assignments .....	83
	Table C.3: Interrupt assignments.....	83

# Chapter 1

## General Introduction

This chapter gives background information on the MIO-3260.

Sections include:

- Introduction
- Product Features
- Specifications

---

## 1.1 Introduction

MIO-3260 is a MI/O-Ultra SBC (Single Board Computer) with embedded Intel® Atom™ E3825 1.33GHz or Celeron® N2930 1.83GHz processor. MIO-3260 can support DDR3L memory up to 8 GB, and has one LVDS, one SATA connector and full size miniPCIe or mSATA slot on board. There is no rear I/O on the coastline; expansion is via 4 x USB2.0, USB 3.0/2.0, 2 x PCIe x1, LPC, HD audio line in/line out/mic in, DP or HDMI, 5 x VSB/12 VSB power, inverter, VGA, GbE, SMBus, I2C, HDD/Power LED, GPIO, 2 x RS-232/422/485, and 12 VDC input interfaces via two 64-pin internal connectors (MIO-3260L SKU) or cables (MIO-3260C SKU) and Advantech's innovative MIOe extension slot. MIO-3260 is a cost-effective solution with high integration flexibility. Customers can efficiently make a carrier board or I/O module to expand specific I/O or extend I/O functions to fulfill various vertical market demands.

## 1.2 Specifications

### 1.2.1 General Specifications

- **CPU:** Intel® Atom™ E3825 & Celeron® N2930
- **BIOS:** AMI EFI 64 Mbit Flash BIOS
- **System Memory:** DDR3L, 1333 MHz for N2930, 1066 MHz for E3825, up to 8 GB
- **Internal I/O Interface:** 1 x LVDS and 1 x SATA
- **Expansion Interface:**
  - 1 x Full-size mini-PCIe slot (Supports mSATA, Mini PCIe card or USB interface module, default support mSATA, selected by jumper)
  - 1 x MIOe connector: supports USB3.0, SMBus, LPC, 2 x PCIe x1, Line out, DisplayPort (or HDMI, supported by request), +5Vsb/+12Vsb power, Power On, Reset
  - 64-pin connector A for MIO-3260L: 12 VDC input, Inverter, VGA, 2 x USB2.0, 1GbE w/ LED
  - Box Wafer for MIO-3260C: 12 VDC input, Inverter w/SATA power, VGA, 2 x USB2.0, 1 GbE (GbE w/LED supported by request)
  - 64-pin connector B: SMBus, I2C, Power/Reset button, HDD/Power LED, 2 x USB2.0, 8-bit GPIO, HD Audio Line-in, Line out, Mic-in, 2 x RS-232/422/485
- **Battery:** Lithium 3 V / 210 mA

## 1.2.2 Functional Specifications

<b>Processor</b>	<ul style="list-style-type: none"> <li>■ Intel® Atom™ E3825 &amp; Celeron® N2930 SoC</li> <li>■ Frequency <ul style="list-style-type: none"> <li>– N2930 1.83 GHz/ CPU Burst 2.16GHz</li> <li>– E3825 1.33 GHz</li> </ul> </li> <li>■ Manufacturing Technology: 22 nm</li> <li>■ L2 cache: 2 MB (N2930)/ 1 MB (E3825)</li> </ul>
<b>Memory</b>	<ul style="list-style-type: none"> <li>■ Supports DDR3L, 1333 MHz (N2930), DDR3L 1066 MHz (E3825), up to 8 GB</li> <li>■ SODIMM Socket: 204-pin SODIMM socket type *1</li> </ul>
<b>Graphic Engine</b>	<ul style="list-style-type: none"> <li>■ Directx* 11, OGL 3.0, OCL 1.1, OGL ES 2.0</li> <li>■ Hardware decode/ acceleration: <ul style="list-style-type: none"> <li>– Encode: H264, MPEG2</li> <li>– Decode: H264, MPEG2, VC-1, WMV9</li> </ul> </li> </ul>
<b>Display</b>	<ul style="list-style-type: none"> <li>■ LVDS (on board): 18/24 bit, 1440 x 900 at 60 Hz</li> <li>■ VGA (by 64pin or box wafer connector): 2560 x 1600 at 60 Hz</li> <li>■ DisplayPort (by MIOe connector): 2560 x 1600 at 60 Hz (HDMI supported by request)</li> <li>■ Dual independent display: LVDS+VGA or LVDS+DP/HDMI or VGA+DP/HDMI</li> </ul>
<b>Audio</b>	<ul style="list-style-type: none"> <li>■ High Definition Audio (HD) ALC-888S codec</li> <li>■ Up to 2 channel of PCM (Pulse Code Modulation) audio output</li> <li>■ Support Line-out, Line-in, Mic-in by 64-pin connector</li> </ul>
<b>PCI-Express Interface</b>	<ul style="list-style-type: none"> <li>■ 4 PCI-Express x1 Lanes</li> <li>■ Lane 1 &amp; 2: MIOe connector</li> <li>■ Lane 3: Full-size Mini PCIe connector</li> <li>■ Lane 4: Intel i210 GbE controller</li> </ul>
<b>SATA Interface</b>	<ul style="list-style-type: none"> <li>■ 1 x mSATA by mini-PCIe socket</li> <li>■ 1 x SATAII (Max. Data transfer rate 300 MB/s)</li> </ul>
<b>USB Interface</b>	<ul style="list-style-type: none"> <li>■ 4 x USB 2.0 by 64pin or box wafer connectors</li> <li>■ 1 x USB 3.0/2.0 by MIOe connector</li> <li>■ Transmission speeds up to 480 Mbps (USB 2.0) / 5 Gbps (USB 3.0)</li> </ul>
<b>Power Management</b>	<ul style="list-style-type: none"> <li>■ Full ACPI (Advanced Configuration and Power Interface) 3.0</li> <li>■ Supports S0, S3, S4, S5</li> <li>■ Support wake on LAN</li> </ul>
<b>BIOS</b>	AMI EFI 64 Mbit Flash BIOS via SPI
<b>Ethernet</b>	<ul style="list-style-type: none"> <li>■ Controller: Intel® i210 (GbE1)</li> <li>■ Compliant with IEEE 802.3, IEEE 802.3u, IEEE 802.3z, IEEE 802.ab</li> <li>■ Supports 10/100/1000 Mbps</li> <li>■ Support by 64pin or box wafer connector</li> <li>■ Supports wake on LAN</li> </ul>
<b>Serial ports</b>	<ul style="list-style-type: none"> <li>■ Controller: SMSC SCH 3114</li> <li>■ 2 x RS-232/422/485 serial ports with ESD protection: air gap ± 15 kV, contact ± 8 kV</li> </ul>

<b>GPIO</b>	■ Controller: SMSC SCH 3114
	■ 8-Bit (programming) through Super I/O, by 64pin
	■ 5 V tolerance
<b>SMBus</b>	64-pin connector support
<b>I2C</b>	64-pin connector support
<b>LPC</b>	MIOe connector support

## 1.2.3 Mechanical Specifications

### 1.2.3.1 Dimensions (mm)

L100 mm x W72 mm (3.9" x 2.8")

### 1.2.3.2 Height on top (mm)

15.7 mm (including heatsink)

### 1.2.3.3 Height under bottom (mm)

8.5 mm

### 1.2.3.4 Weight (g)

MIO-3260L: 0.35 kg (0.77 lb), MIO-3260C: 0.55 kg (1.21 lb), weight of total package.

## 1.2.4 Electrical Specifications

**Power Supply Type:** Single 12 V DC power input (supports DC power hot plug).

### 1.2.4.1 Power supply voltage

- Single 12 V input  $\pm 10\%$
- Total peripheral power supply output: 5 V @ 3 A for CPU board and MIOe module total. 12 V @ 2 A for MIOe module alone.

### 1.2.4.2 Power consumption

- **Typical in Windows 8.1 Pro:**  
MIO-3260L-S3A1E: 4.47 W  
MIO-3260L-S8A1E: 5.08 W  
MIO-3260C-S8A1E: 4.22 W
- **Max in Windows 8.1 Pro.:**  
MIO-3260L-S3A1E: 7.13 W  
MIO-3260L-S8A1E: 9.73 W  
MIO-3260C-S8A1E: 8.71 W

### 1.2.4.3 RTC battery

- **Typical Voltage:** 3.0 V
- **Normal discharge capacity:** 210 mAh

## 1.2.5 Environmental Specifications

### 1.2.5.1 Operating humidity

40 °C @ 95% RH Non-Condensing

### 1.2.5.2 Operating temperature

0 ~ 60 °C (32~140 °F)

**1.2.5.3 Storage humidity**  
60 °C @ 95% RH Non-Condensing

**1.2.5.4 Storage temperature**  
-40 ~ 85 °C (-40 ~ 185 °F)

### 1.3 Function Block Diagram

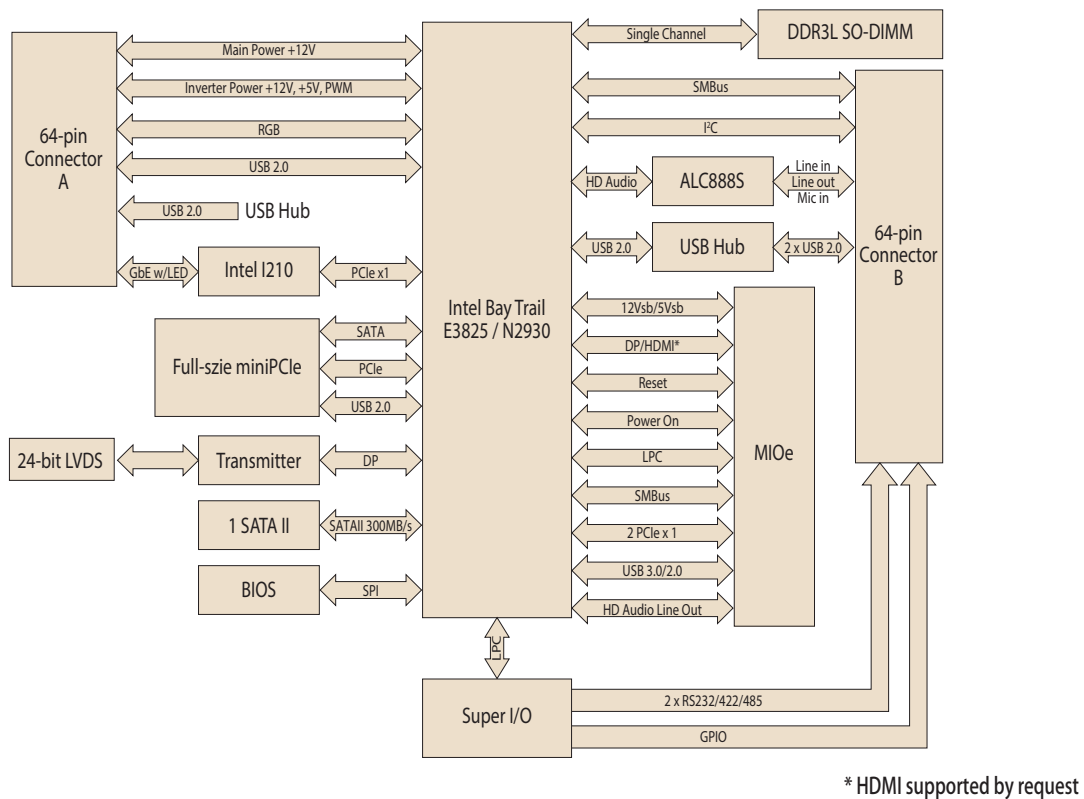





# Chapter 2

## H/W Installation

This chapter explains the setup procedures of the MIO-3260 hardware, including instructions on setting jumpers and connecting peripherals, as well as switches, indicators and mechanical drawings. Be sure to read all safety precautions before you begin the installation procedure.

## 2.1 Jumpers

### 2.1.1 Jumper Description

Cards can be configured by setting jumpers. A jumper is a metal bridge used to close an electric circuit. It consists of two metal pins and a small metal clip (often protected by a plastic cover) that slides over the pins to connect them. To close a jumper, you connect the pins with the clip. To open a jumper, you remove the clip. Sometimes a jumper will have three pins, labeled 1, 2 and 3. In this case you would connect either pins 1 and 2, or 2 and 3.

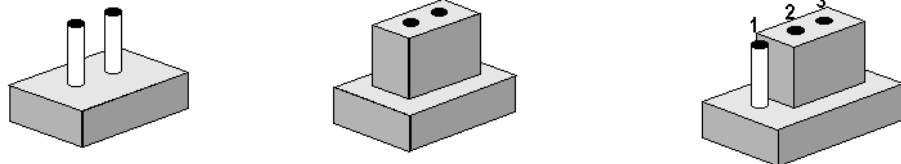

The jumper settings are schematically depicted in this manual as follows.



A pair of needle-nose pliers may be helpful when working with jumpers. If you have any doubts about the best hardware configuration for your application, contact your local distributor or sales representative before you make any changes. Generally, you simply need a standard cable to make most connections.

**Warning!** To avoid damaging the computer, always turn off the power supply before setting jumpers.



### 2.1.2 Jumper List

**Table 2.1: Jumper List**

J1	LCD Power / Auto Power on
J2	Mini PCIE / mSATA Select

### 2.1.3 Jumper Settings

**Table 2.2: J1: LCD Power/Auto Power on**

<b>Part Number</b>	1653003260
<b>Footprint</b>	HD_3x2P_79
<b>Description</b>	PIN HEADER 3*2P 180D(M) 2.0mm SMD SQUARE PIN
<b>Setting</b>	<b>Function</b>
(1-2)	+5V
(3-4) (default)	+3.3V
(5-6) (default)	Auto Power On

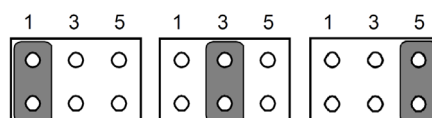

**Table 2.3: J2: Mini PCIE / mSATA Select**

<b>Part Number</b>	1653002101-03
<b>Footprint</b>	HD_2x1P_79_H236_D
<b>Description</b>	PIN HEADER 1X2P 2.00mm 180D(M) DIP 1140-000-02SN
<b>Setting</b>	<b>Function</b>
(Open)	mSATA
(Closed) (default)	Mini PCIE

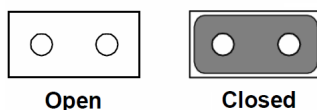

## 2.2 Connectors

### 2.2.1 Connector List

Label	Function
CN4	64-Pin Connector A
CN5	64-Pin Connector B
CN6	DDR3L SO-DIMM
CN7	12V Power Input*
CN8	Inverter Power Output/Internal SATA Power*
CN9	VGA*
CN10	USB 2.0 x 2*
CN11	Gigabit Ethernet*
CN11_1	Gigabit Ethernet with LED**
CN14	SATA
CN16	Mini PCIE/mSATA
CN29	MIOe
CN31	18/24-bit LVDS Panel

\*Only for MIO-3260C-S8A1E

\*\*Supported by request

### 2.2.2 Connector Settings

#### 2.2.2.1 Battery Connector (BH1)

MIO-3260 supports Lithium 3 V/210 mA H CR2032 battery with wire via battery connector (BH1).

**Note!** How to clear CMOS: (Follow these steps)



1. Turn off system power.
2. Unplug CR2032 battery cable on BH1.
3. Wait for 15secs, or short BH1 pin1-2.
4. Connect battery cable on BH1.
5. Turn on system power.

## 2.3 Mechanical

### 2.3.1 Jumper and Connector Locations

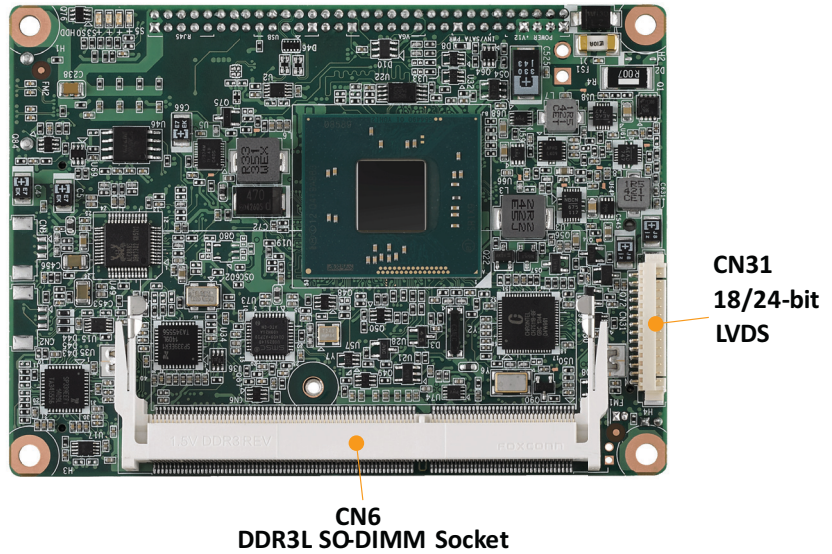

Figure 2.1 MIO-3260 Connector Location (Top Side)

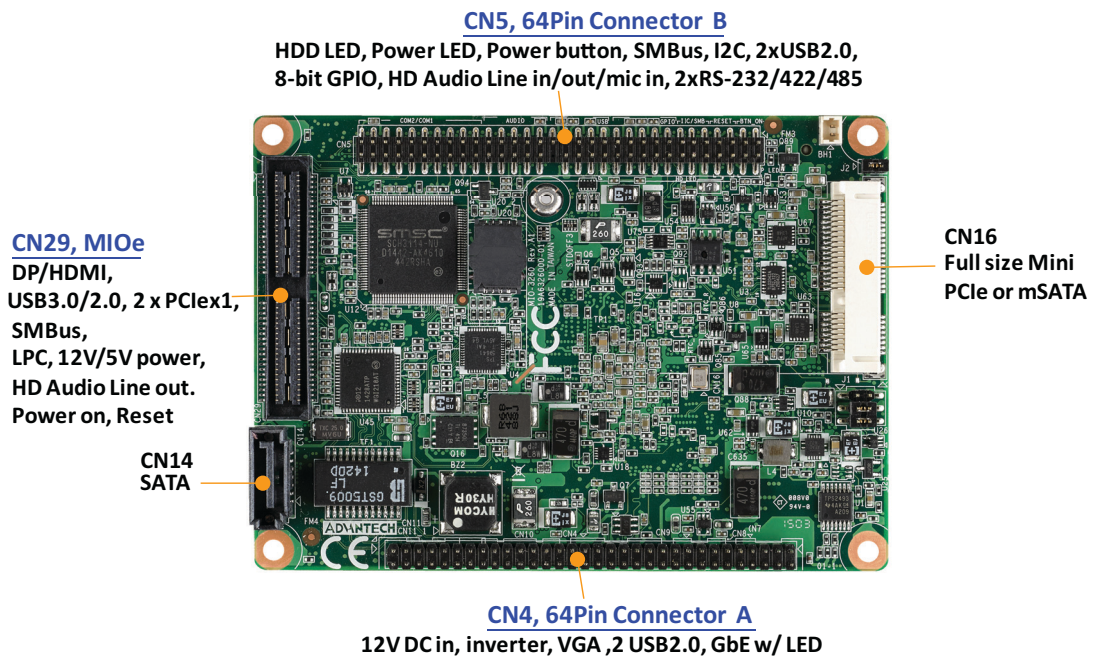

Figure 2.2 MIO-3260L Connector Location (Bottom Side)

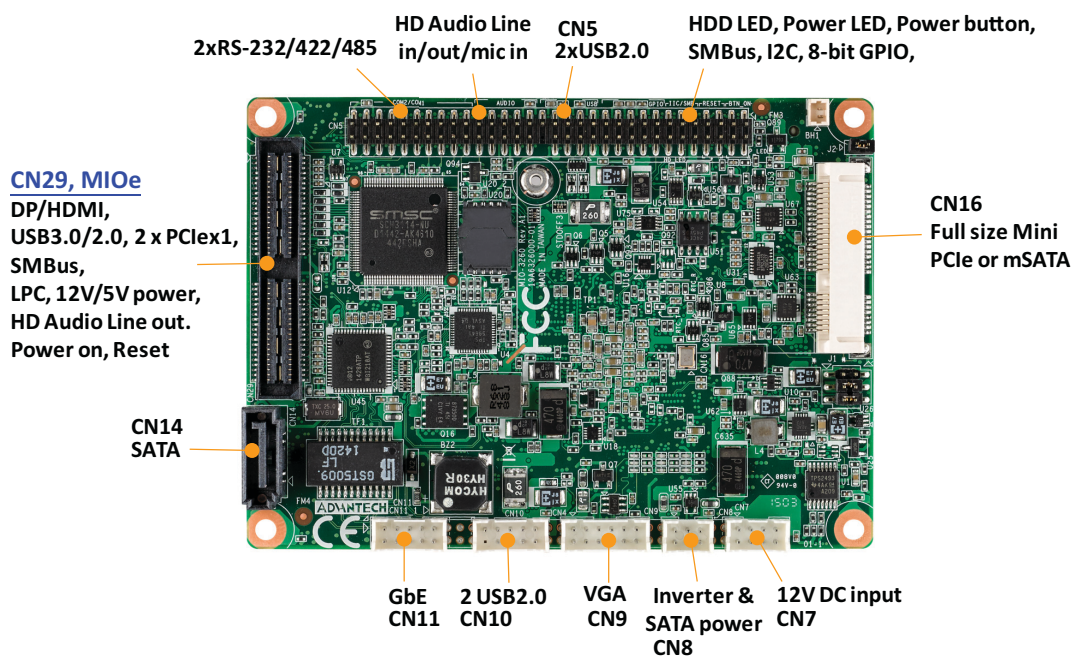

Figure 2.3 MIO-3260C Connector Location (Bottom Side)

## 2.3.2 Board Dimensions

### 2.3.2.1 CPU Board Drawing

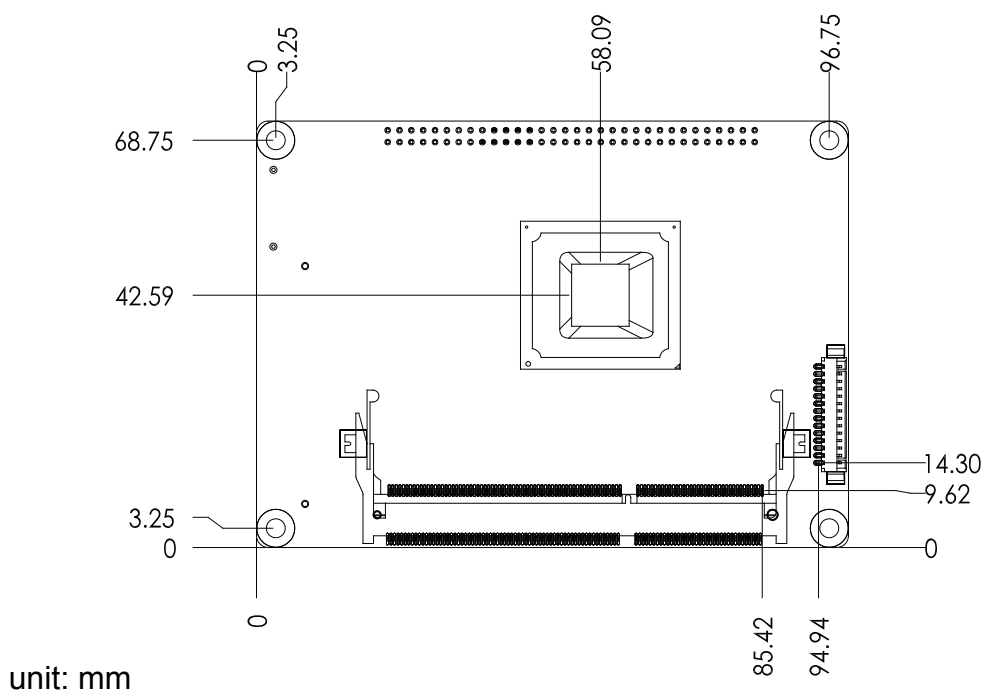
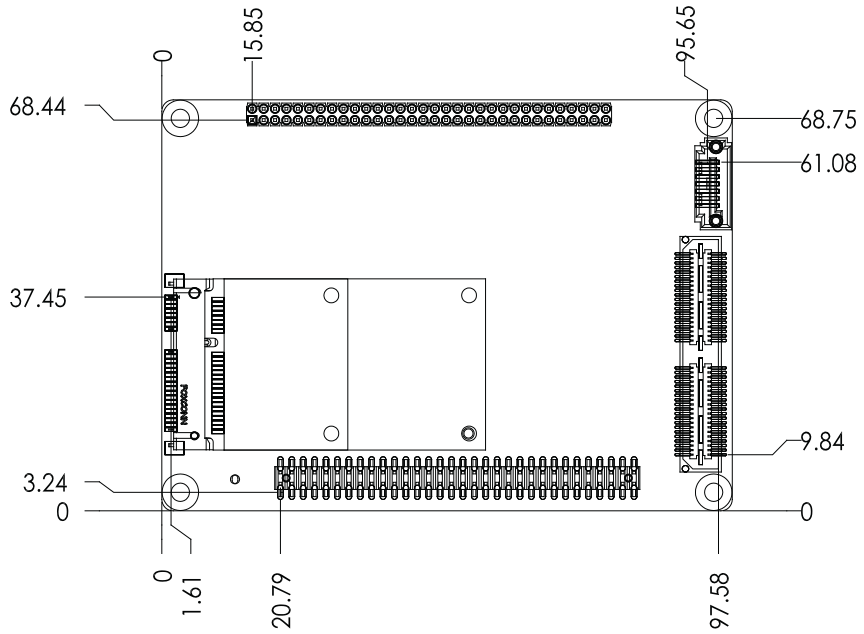
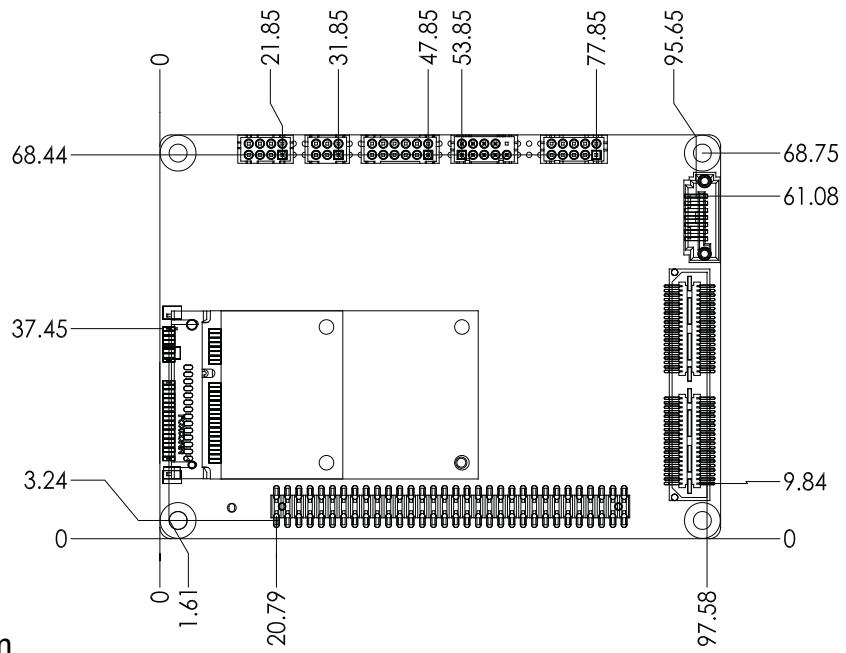

Figure 2.4 MIO-3260 Mechanical Drawing (Top View)



unit: mm

**Figure 2.5 MIO-3260L Mechanical Drawing (Bottom View)**



unit: mm

**Figure 2.6 MIO-3260C Mechanical Drawing (Bottom View)**

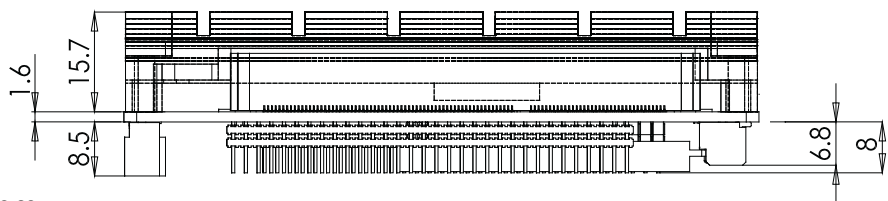

unit: mm

**Figure 2.7 MIO-3260 Mechanical Drawing (Side View with Heatsink)**

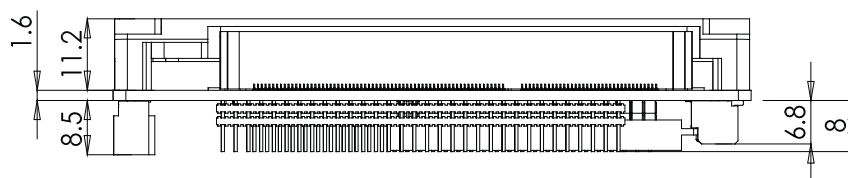

unit: mm

**Figure 2.8 MIO-3260 Mechanical Drawing (Side View with Heatspreader)**

### 2.3.3 Quick Installation Guide

A heatsink is in the white box, please take it out and remove the protective paper from the thermal pads.

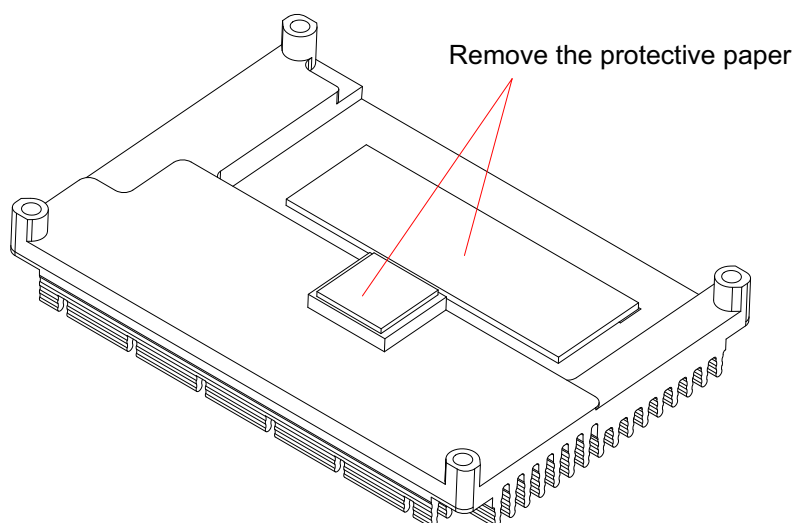

There are also four screws inside the white box, please install the DRAM in the SODIMM socket first, then screw the heatsink into place as per illustration below:

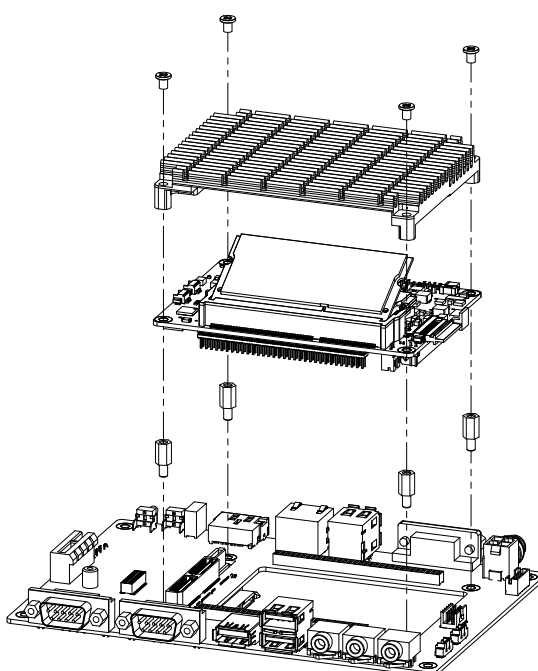

---

### 2.3.4 Optional Thermal Solution - Heat Spreader

MIO-3260 has an optional heat spreader to make whole system more compact. Using a heat spreader to conduct heat to your chassis can help a lot when the system is extra compact or has limited space for heat convection. Here are some guidelines for the heat spreader:

1. For best heat conduction, the gap between the chassis and heat spreader should be small; the smaller the better.
2. The height of the existing heat spreader is 11.2mm (Advantech P/N: 1960065074N001). If you need some other height to fit the chassis better, Advantech can customize it for you. (Please contact our sales department for details.)
3. Thermal grease and screws are provided in heat spreader kit. Thermal grease helps conduction if the chassis is quite close to heat spreader. Another suggestion is to use a thermal pad if the chassis isn't close enough to the heat spreader. (The gap should be less than 3mm for better heat transfer.)



# Chapter 3

BIOS Settings

## 3.1 BIOS Setup

AMIBIOS has been integrated into a megaload of motherboards for decades. With the AMIBIOS setup program, users can modify BIOS settings and control various system features. This chapter describes the basic navigation of the MIO-3260 BIOS setup screens.

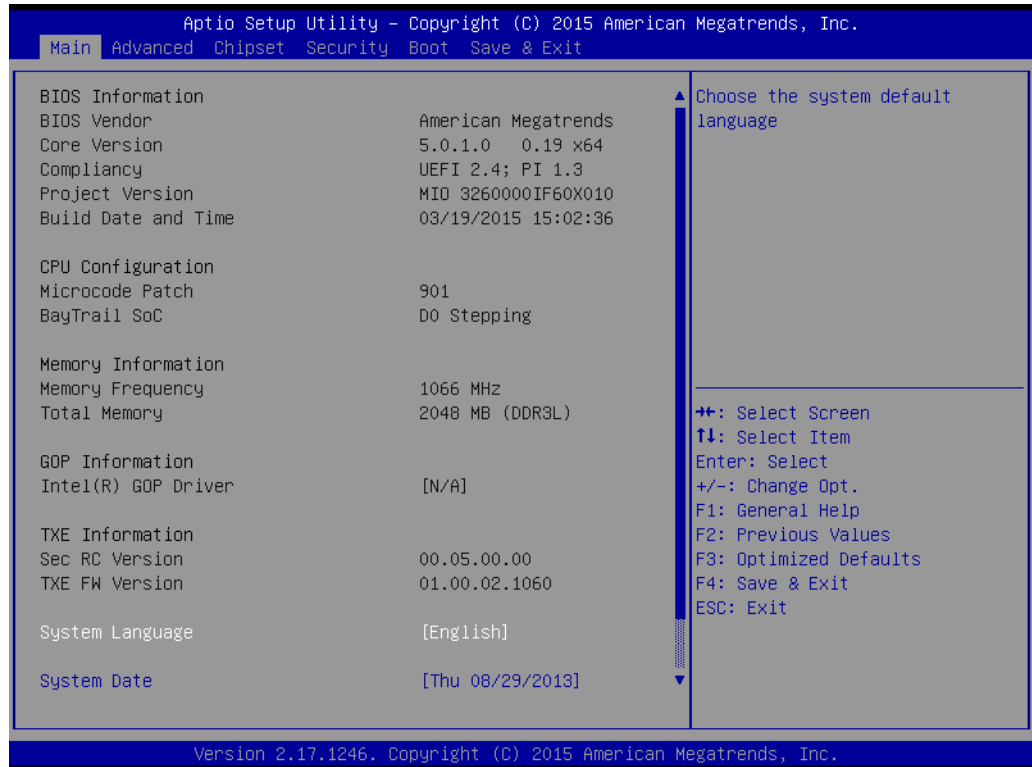

AMI's BIOS ROM has a built-in Setup program that allows users to modify the basic system configuration. This information is stored in flash ROM so it retains the Setup information when the power is turned off.

**Note!** *Default BIOS is supported for 64-bit OS installation, BIOS for 32-bit OS is supported by project, please contact sales representative for details.*



## 3.2 Entering Setup

Turn on the computer and check for the patch code. If there is a number assigned to the patch code, it means that the BIOS supports your CPU. If there is no number assigned to the patch code, please contact an Advantech application engineer to obtain an up-to-date patch code file. This will ensure that your CPU's system status is valid. After ensuring that you have a number assigned to the patch code, press <DEL> and you will immediately be allowed to enter Setup.

### 3.2.1 Main Setup

When users first enter the BIOS Setup Utility, users will enter the Main setup screen. Users can always return to the Main setup screen by selecting the Main tab. There are two Main Setup options. They are described in this section. The Main BIOS Setup screen is shown below.

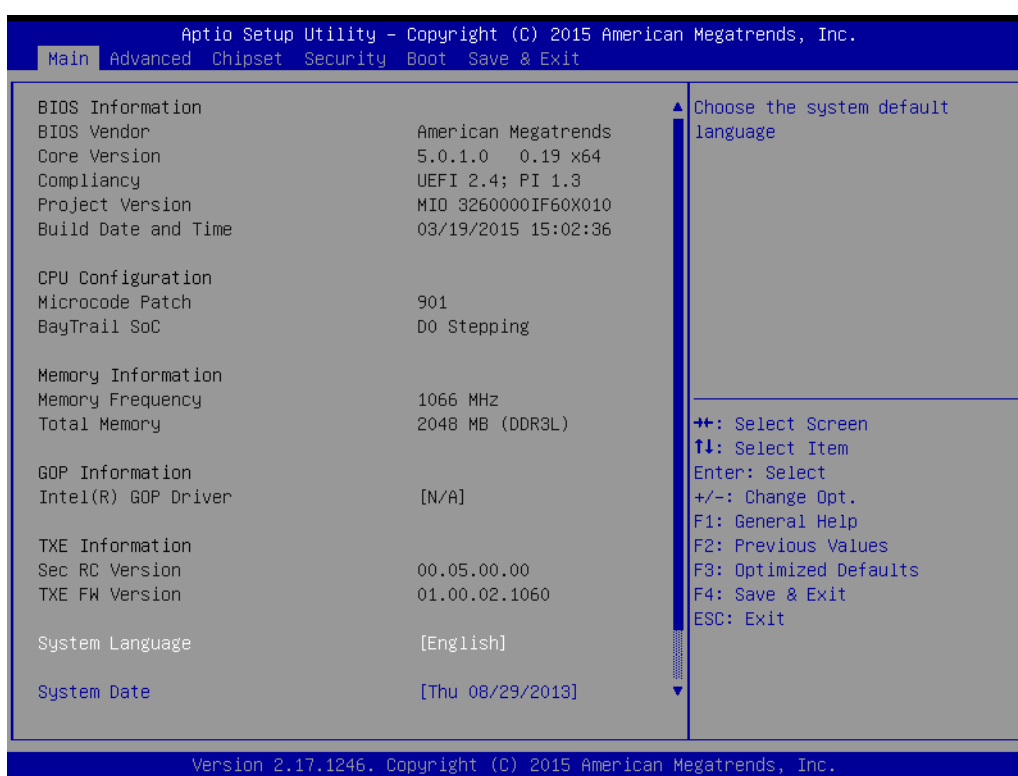

The Main BIOS setup screen has two main frames. The left frame displays all the options that can be configured. Grayed-out options cannot be configured; options in blue can. The right frame displays the key legend.

Above the key legend is an area reserved for a text message. When an option is selected in the left frame, it is highlighted in white. Often a text message will accompany it.

#### ■ System time / System date

Use this option to change the system time and date. Highlight System Time or System Date using the <Arrow> keys. Enter new values through the keyboard. Press the <Tab> key or the <Arrow> keys to move between fields. The date must be entered in MM/DD/YY format. The time must be entered in HH:MM:SS format.

### 3.2.2 Advanced BIOS Features Setup

Select the Advanced tab from the MIO-3260 setup screen to enter the Advanced BIOS Setup screen. Users can select any item in the left frame of the screen, such as CPU Configuration, to go to the sub menu for that item. Users can display an Advanced BIOS Setup option by highlighting it using the <Arrow> keys. All Advanced BIOS Setup options are described in this section. The Advanced BIOS Setup screens are shown below. The sub menus are described on the following pages.

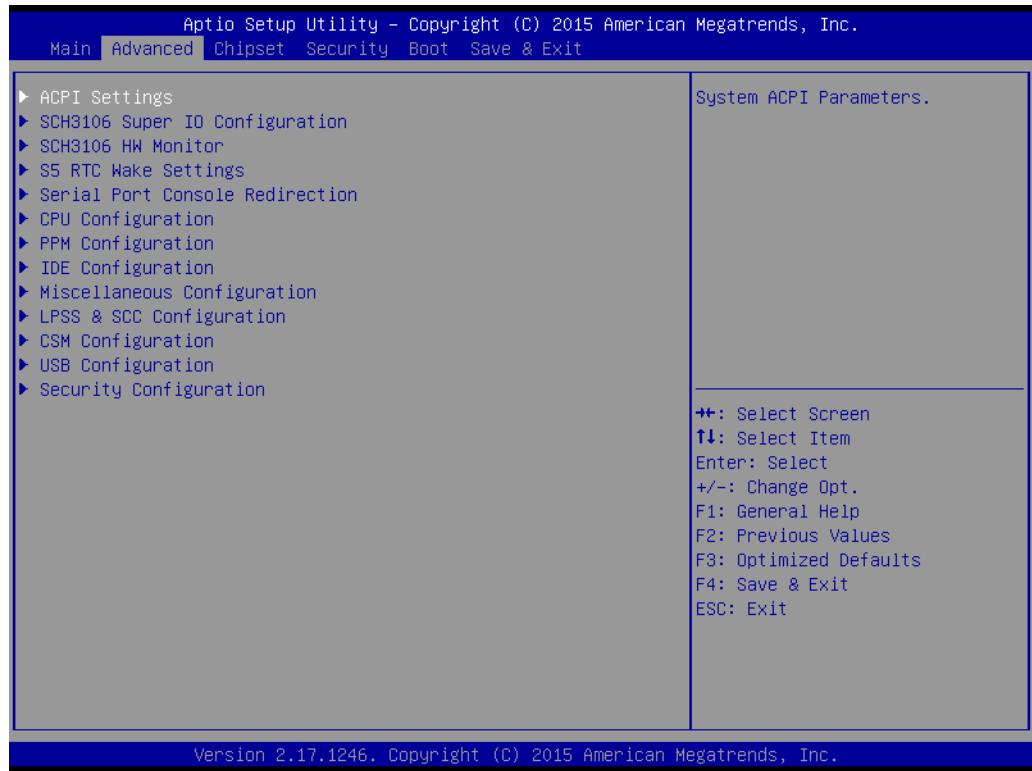

### 3.2.2.1 ACPI Settings Configuration

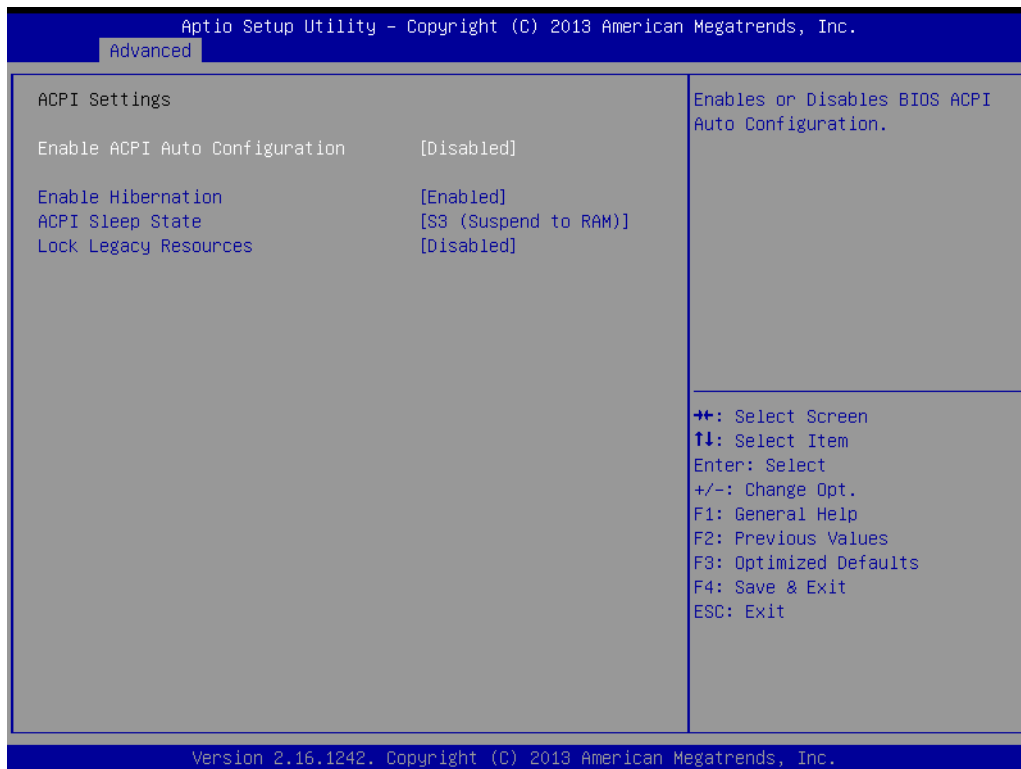

- **Enable ACPI Auto Configuration**  
Enables or disables BIOS ACPI auto configuration.
- **Enable Hibernation**  
Enables or Disables System ability to Hibernate (OS/S4 Sleep State). This option may be not effective with some OS.
- **ACPI Sleep State**  
Select the highest ACPI sleep state the system will enter when the SUSPEND button is pressed.
- **Lock Legacy Resources**  
Enables or Disables Lock on Legacy Resources

### 3.2.2.2 Super I/O configuration



- **Serial Port 1 Configuration**  
Set Parameters of Serial Port 1 (COMA)
- **Serial Port 2 Configuration**  
Set Parameters of Serial Port 2 (COMB)

### 3.2.2.3 H/W monitor

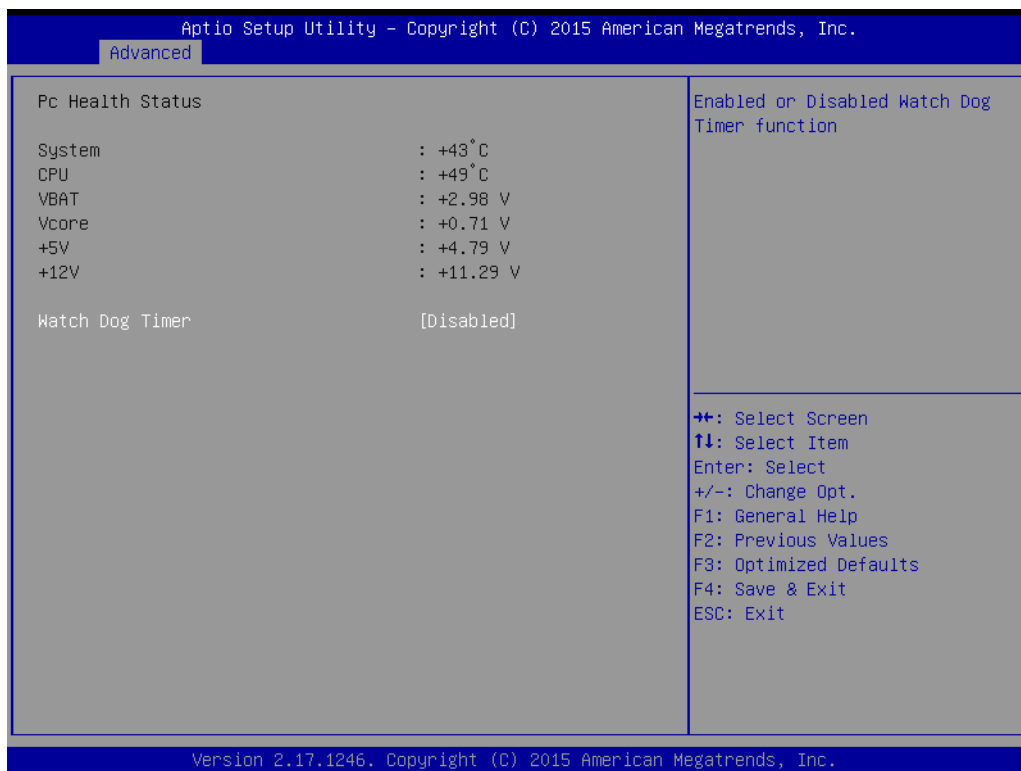

- **PC Health Status**  
This page displays all the information about system temperature/voltage.
- **Watch Dog Timer**  
This item allows users to enable or disable the Watch Dog Timer function.

### 3.2.2.4 S5 RTC wake settings



- **Wake system with Fixed Time**  
Enable or disable system wake on alarm event. Selecting FixedTime, the system will wake on the hr:min:sec specified. Selecting DynamicTime, the system will wake on the current time + Increase minute(s).



### 3.2.2.5 Serial port console redirection

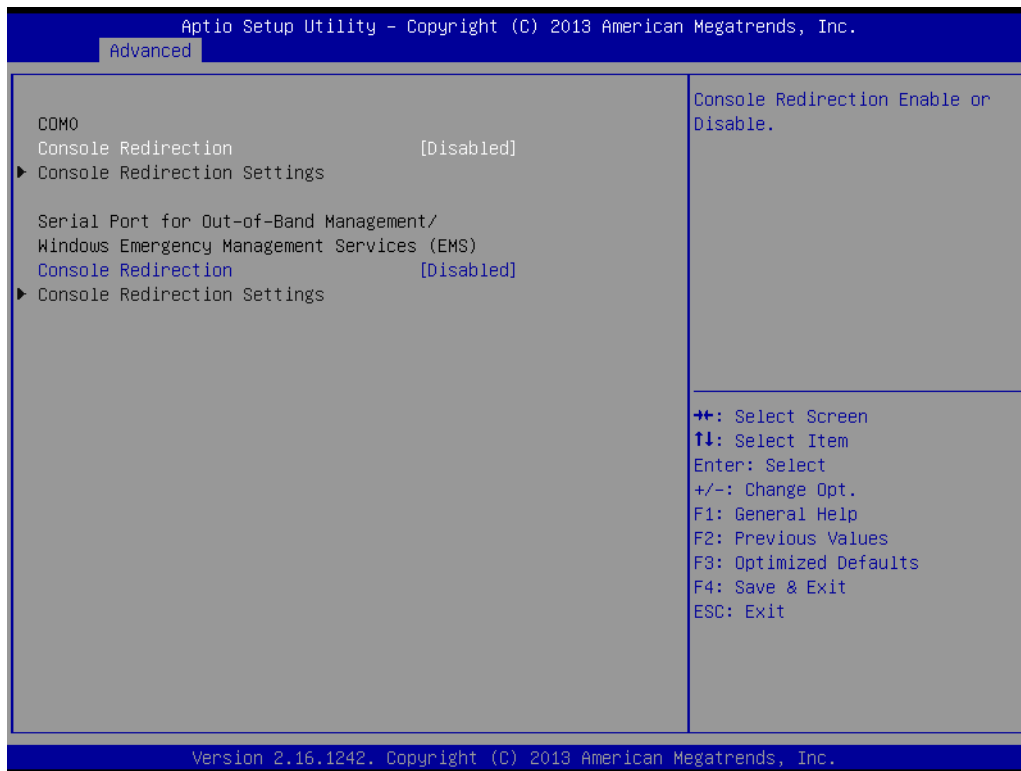

- **Console Redirection**  
This item allows users to enable or disable console redirection for Microsoft Windows Emergency Management Services (EMS).
- **Console Redirection**  
This item allows users to configure console redirection detail settings.

### 3.2.2.6 CPU configuration



- **PPS Support**  
This item allows you to enable or disable the ACPI \_PPC, \_PSS, and \_PCT objects.
- **Limit CPUID Maximum**  
Disabled for Windows XP.
- **Execute Disable Bit**  
XD can prevent certain classes of malicious buffer overflow attacks when combined with a supporting OS (Windows Server 2003 SP1, Windows XP SP2, SuSE Linux 9.2, RedHat Enterprise 3 Update 3.)
- **Intel® Virtualization Technology**  
When enabled, a VMM can utilize the additional hardware capabilities provided by Vanderpool Technology.
- **Power Technology**  
Enables power management features.

### 3.2.2.7 PPM configuration

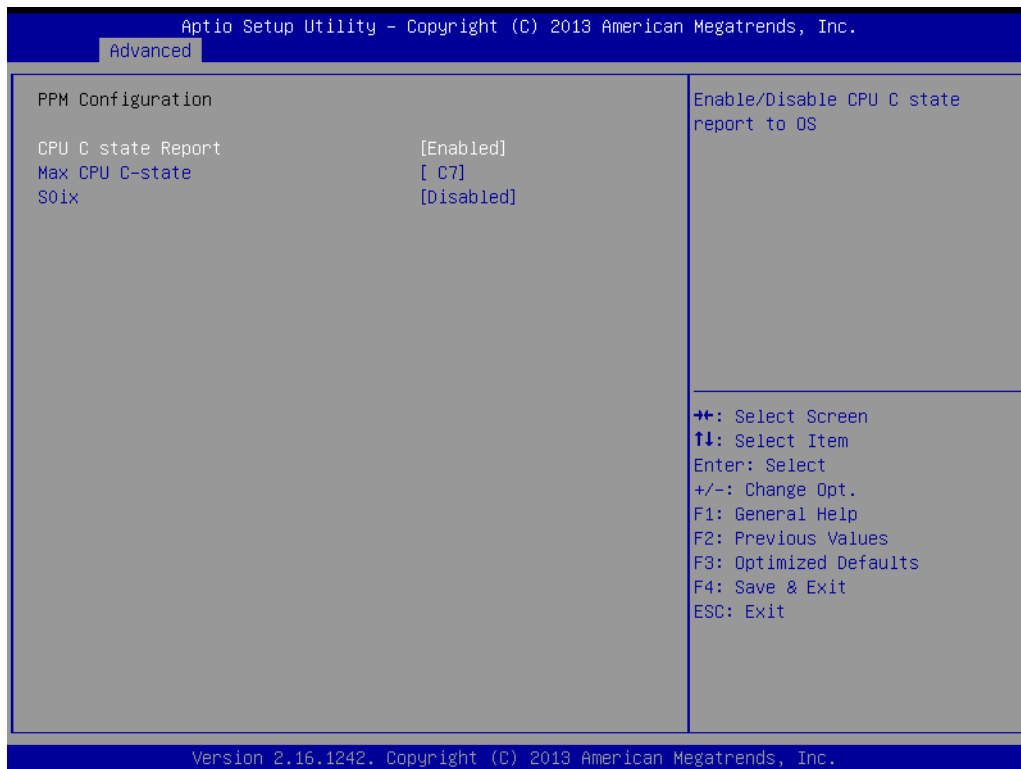

- **CPU C state Report**  
Enable/Disable CPU C state report to OS.
- **Max CPU C-state**  
This option controls Max C states that the processor will support.
- **S0ix**  
Enable/Disable CPU S0ix state.

### 3.2.2.8 IDE configuration

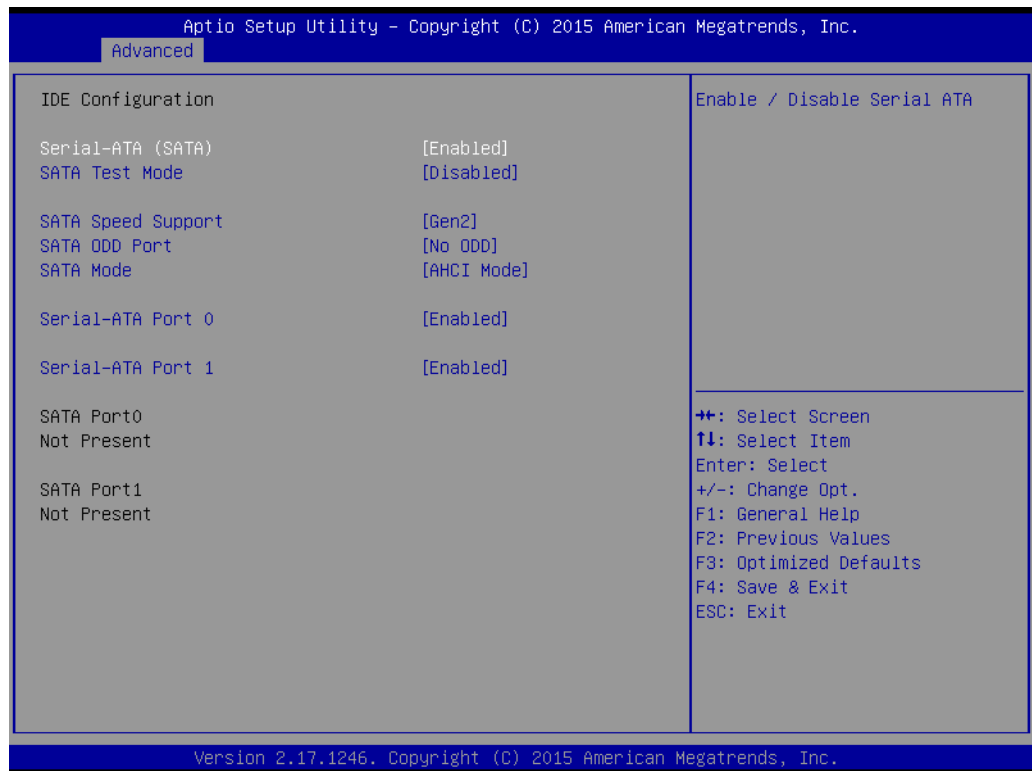

- **Serial-ATA (SATA)**  
Enable / Disable Serial ATA.
- **SATA Test Mode**  
Test Mode Enable / Disable.
- **SATA Speed Support**  
SATA Speed Supports Gen1 or Gen2.
- **SATA ODD Port**  
SATA ODD is Port0 or Port1.
- **SATA Mode**  
Select IDE / AHCI.
- **Serial-ATA Port 0**  
Enable / Disable Serial ATA Port 0.

### 3.2.2.9 Miscellaneous configuration



- **OS Selection**  
OS Selection to choose Windows 8.x / Windows 7.

### 3.2.2.10 CSM configuration

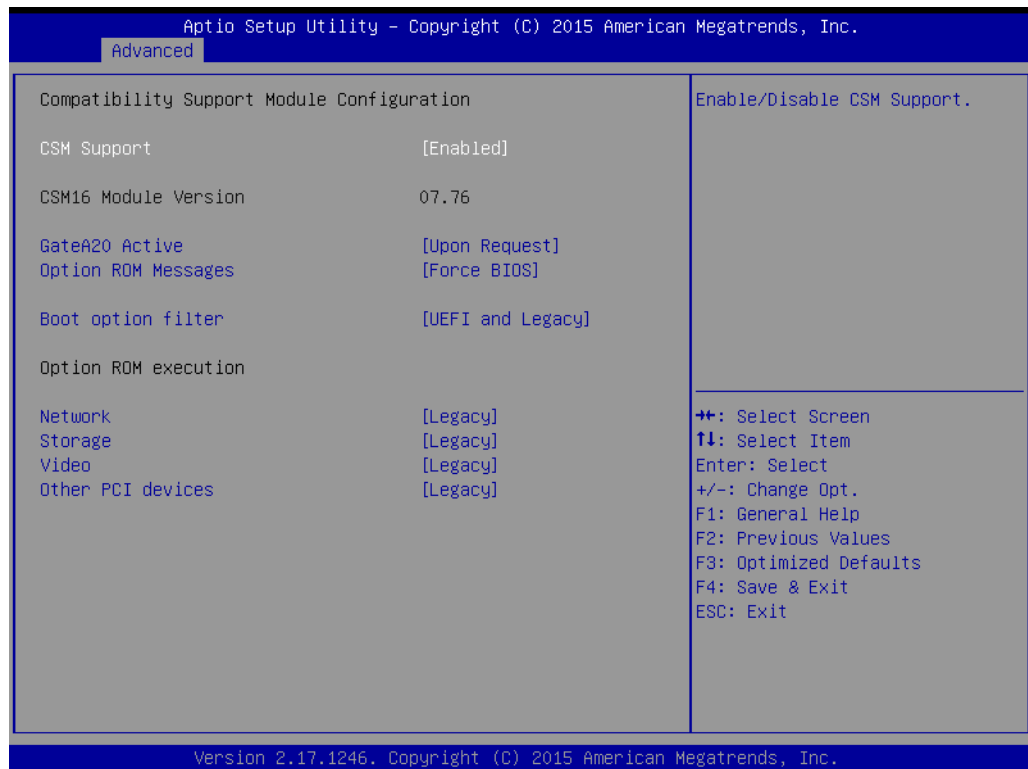

- **CSM Support**  
Enable/Disable CSM support.
- **GateA20 Active**  
Upon Request - GA20 can be disabled using BIOS services otherwise GA20 cannot be disabled; this option is useful when any RT code is executed above 1 MB.
- **Option ROM Messages**  
Set display mode for Option ROM.
- **Boot option filter**  
This option controls Legacy/UEFI ROM priority.
- **Network**  
Controls the execution of UEFI and Legacy PXE OpROM.
- **Storage**  
Controls the execution of UEFI and Legacy Storage OpROM.
- **Video**  
Controls the execution of UEFI and Legacy Video OpROM.
- **Other PCI devices**  
Determines OpROM execution policy for devices other than Network, Storage, or Video.

### 3.2.2.11 USB configuration

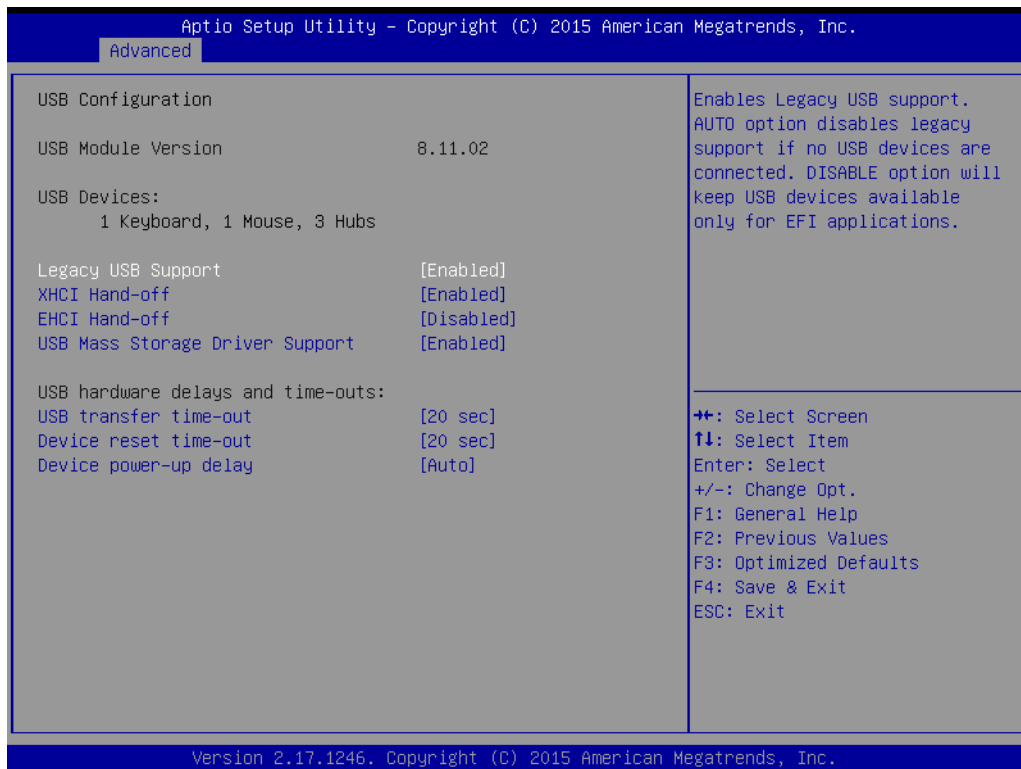

- **Legacy USB Support**  
Enables support for legacy USB. Auto option disables legacy support if no USB devices are connected. DISABLE option will keep USB devices available only for EFI applications.
- **XHCI Hand-Off**  
This is a workaround for OS without XHCI hand-off support. The XHCI ownership change should be claimed by the XHCI driver.
- **EHCI Hand-Off**  
This is a workaround for OS without EHCI hand-off support. The EHCI ownership change should be claimed by EHCI driver.
- **USB Mass Storage Driver Support**  
This item allows you to enable or disable the USB mass storage device support.
- **Device reset time-out**  
USB mass storage device start unit command time-out.
- **Device power-up delay**  
Maximum time the device will take before it properly reports itself to the host controller. "Auto" uses default value: for a Root port it is 100 ms, for a hub port the delay is taken from hub descriptor.

### 3.2.2.12 Security configuration

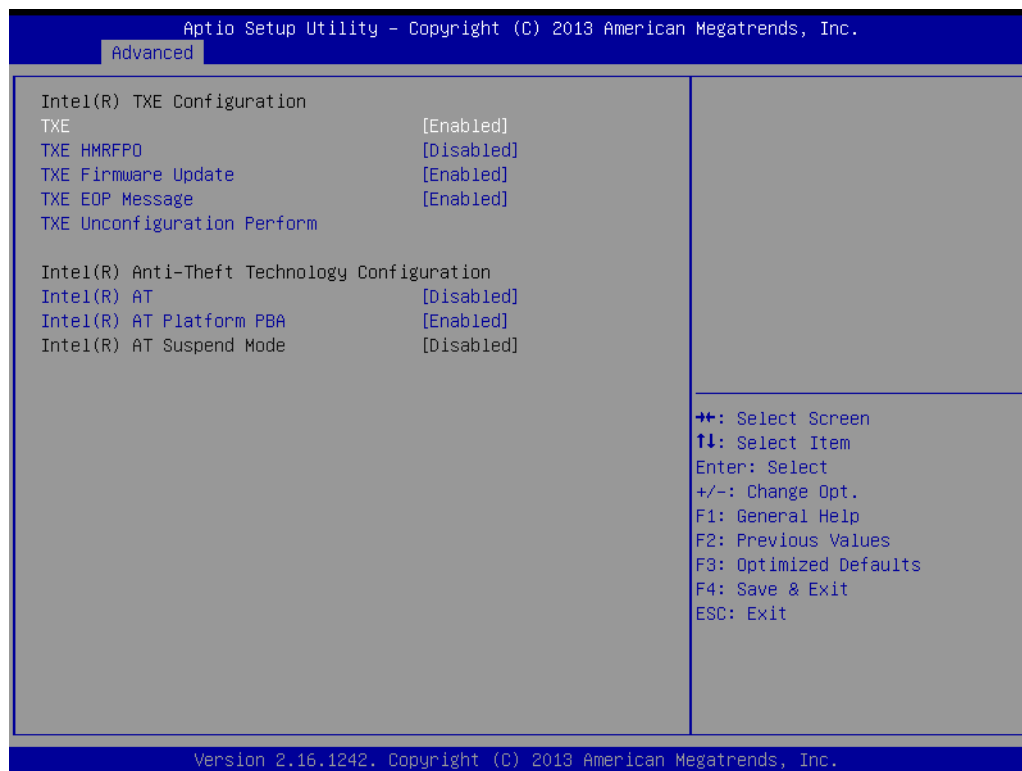

- **SMART Self Test**  
This item allows you to enable or disable the SMART self test function.
- **TXE**
- **TXE HMRFPD Disable**
- **TXE Firmware Update**
- **TXE EOP Message**  
Send EOP Message before entering the OS.
- **TXE Unconfiguration Perform**  
Revert TXE settings to factory defaults.
- **Intel(R) AT**  
Enable/Disable BIOS AT code from running.
- **Intel(R) AT Platform PBA**  
Enable/Disable BIOS AT code from running.



### 3.2.3 Chipset configuration

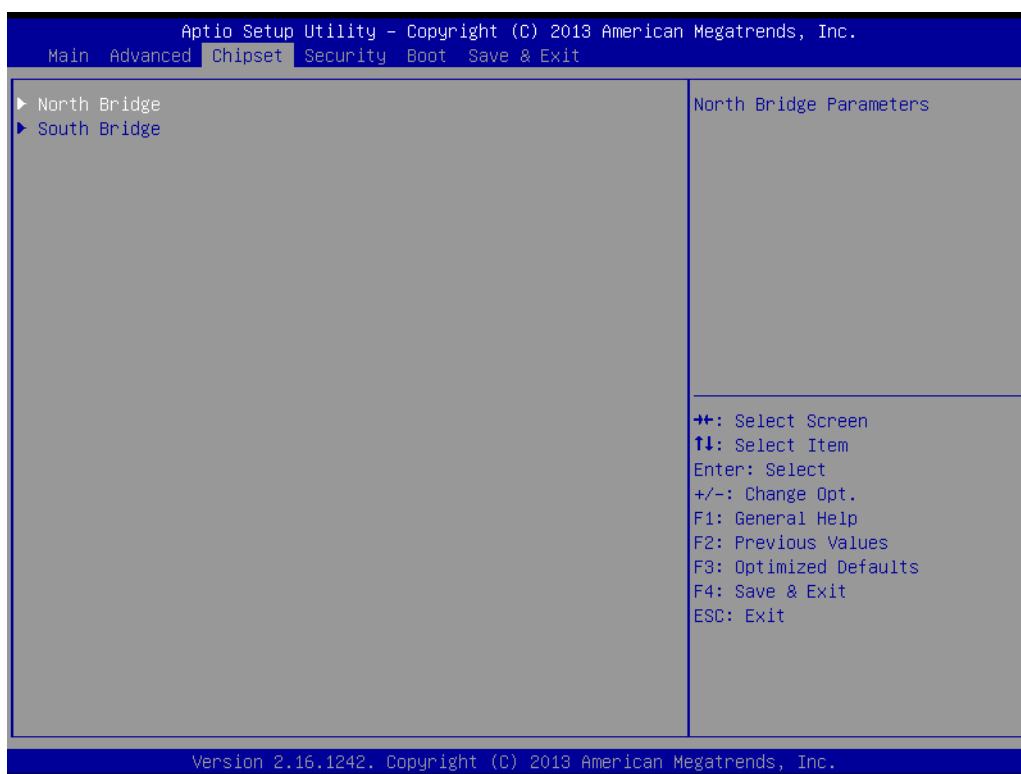

- **North Bridge**  
Details for North Bridge items.
- **LVDS Config Select**  
Details on display items.

### 3.2.3.1 North bridge

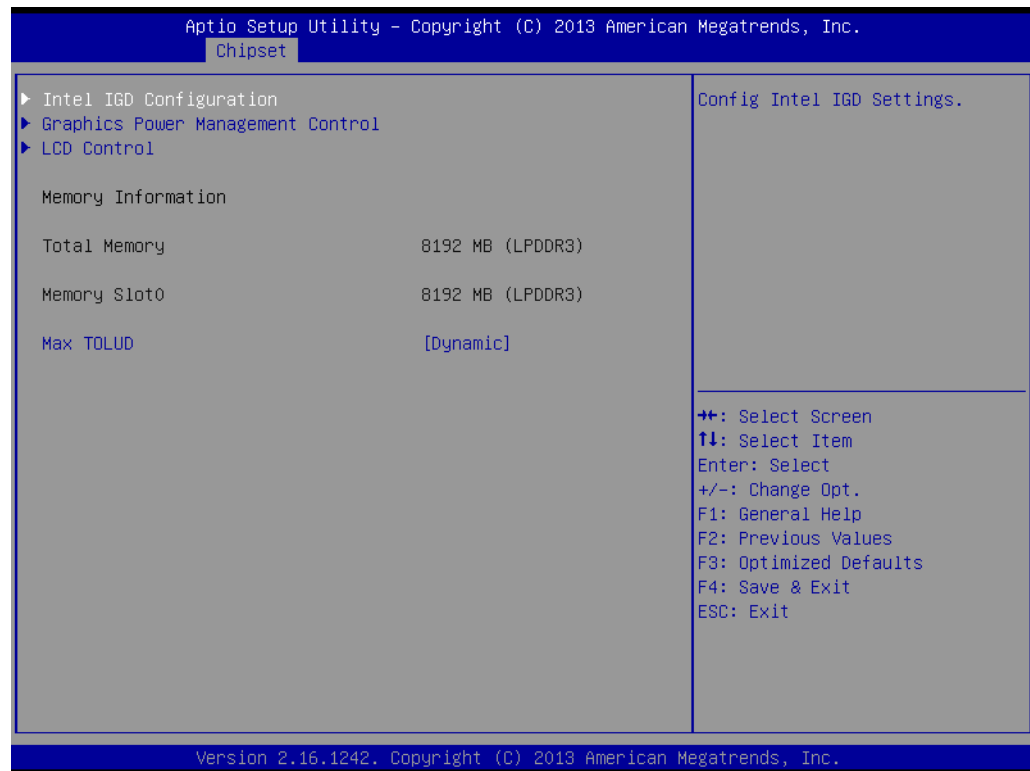

- **Intel IGD Configuration**  
Config Intel IGD settings.
- **Graphics Power Management Control**  
Graphics Power Management Control options.
- **LCD Control**  
LCD Control.
- **Max TOLUD**  
Maximum value of TOLUD.

### 3.2.3.2 Intel IGD configuration

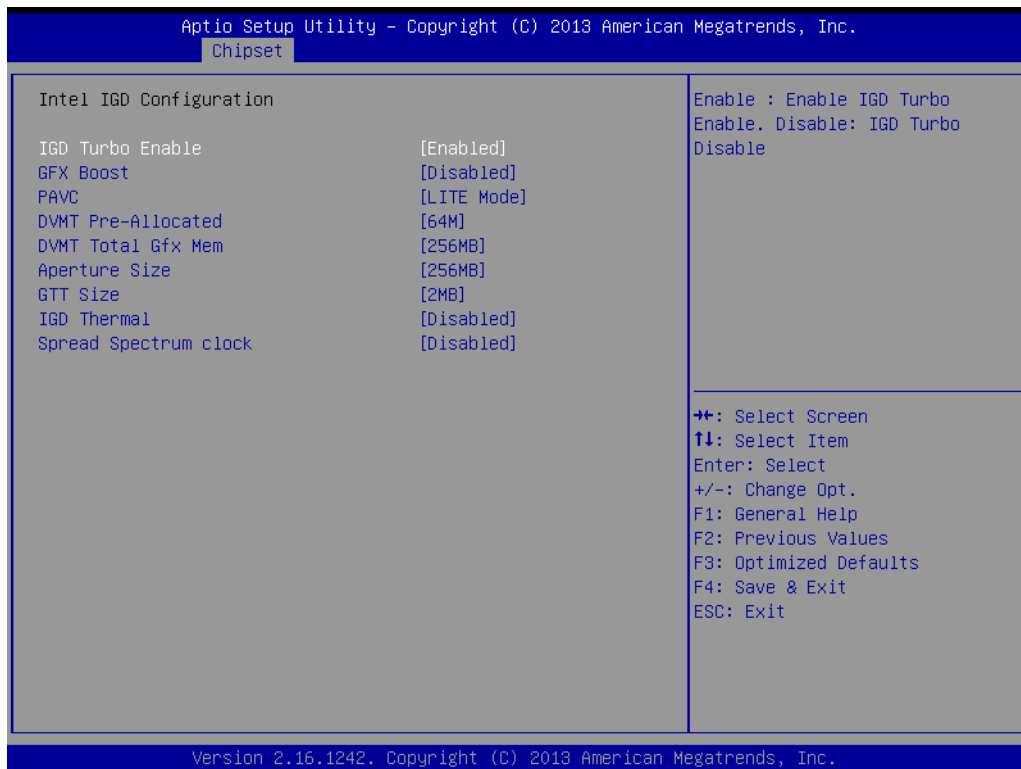

- **Intel IGD Configuration**  
Config Intel IGD settings.
- **IGD Turbo Enable**  
Enable: Enable IGD Turbo Enable. Disable: IGD Turbo Disable
- **GFX Boost**  
Enable/Disable GFX boost.
- **PAVC**  
Enable/Disable protected audio video control.
- **DVMT Pre-Allocated**  
Select DVMT 5.0 Pre-Allocated (Fixed) graphics memory size used by the Internal graphics device.
- **DVMT Total Gfx Mem**  
Select DVMT 5.0 total graphic memory size used by the internal graphics device.
- **Aperture Size**  
Select the aperture size.
- **GTT Size**  
Select the GTT size.
- **IGD Thermal**  
Enable/Disable IGD thermal.
- **Spread Spectrum clock**  
Enable/Disable spread spectrum clock.

### 3.2.3.3 Graphics power management control

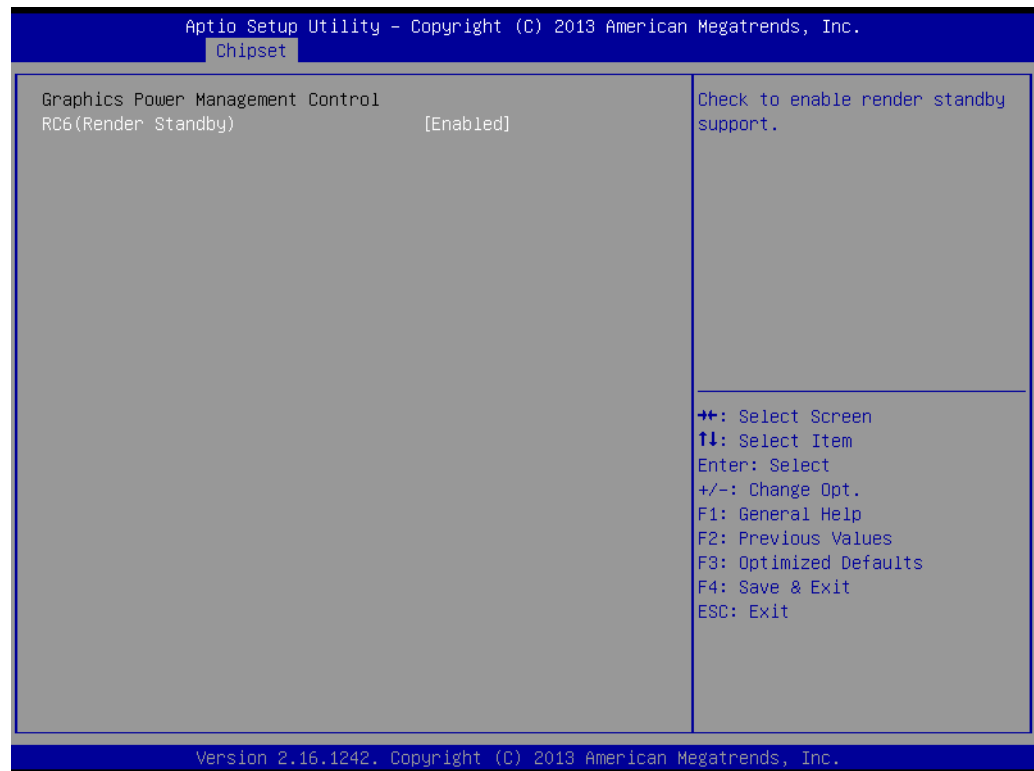

- **RC6 (Render Standby)**  
Check to enable render standby support.

### 3.2.3.4 LCD control



- **Primary IGFX Boot Display**  
Select the video device which will be activated during POST. This has no effect if external graphics are present. Secondary boot display selection will appear based on your selection. VGA modes will be supported only on the primary display.
- **LVDS Panel Type**

### 3.2.3.5 South bridge

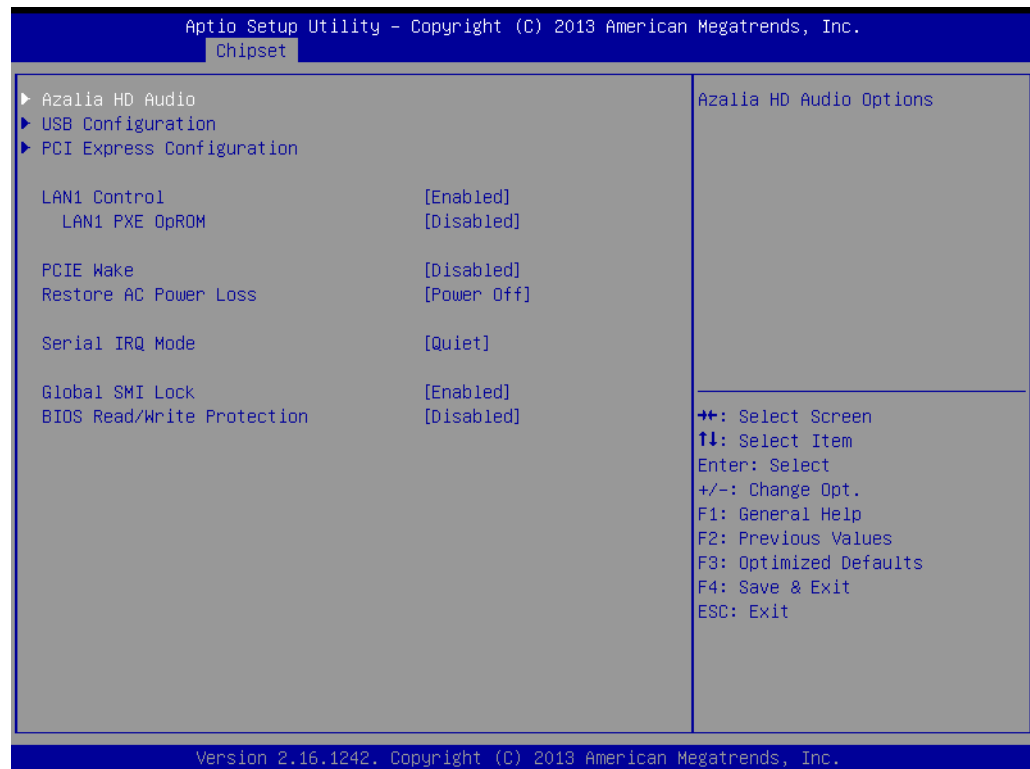

- **SB SATA Configuration**  
Options for SATA configuration.
- **SB USB Configuration**  
Options for SB USB configuration.
- **SB HD Azalia Configuration**  
Options for SB HD Azalia.
- **PCI-E Port**  
Options for PCI-E devices control.
- **Restore on AC Power Loss**  
This item allows you to select system restore states in case of AC power loss.
- **Azalia HD Audio**  
Azalia HD audio options.
- **USB Configuration**  
USB configuration settings.
- **PCI Express Configuration**  
PCI Express configuration settings.
- **LAN1 Control**  
Enable or Disable the LAN1.
- **LAN1 PXE OpROM**  
Enable or Disable boot option for LAN1 controller.
- **PCIE Wake**  
Enable or Disable PCIE to wake the system from S5.
- **Restore AC Power Loss**  
Select AC power state when the power is re-applied after a power failure.
- **Serial IRQ Mode**

Configure Serial IRQ Mode.

- **Global SMI Lock**  
Enable or Disable SMI lock.
- **BIOS Read/Write Protection**  
Enable or Disable BIOS SPI region read/write protect.

### 3.2.3.6 Azalia HD audio

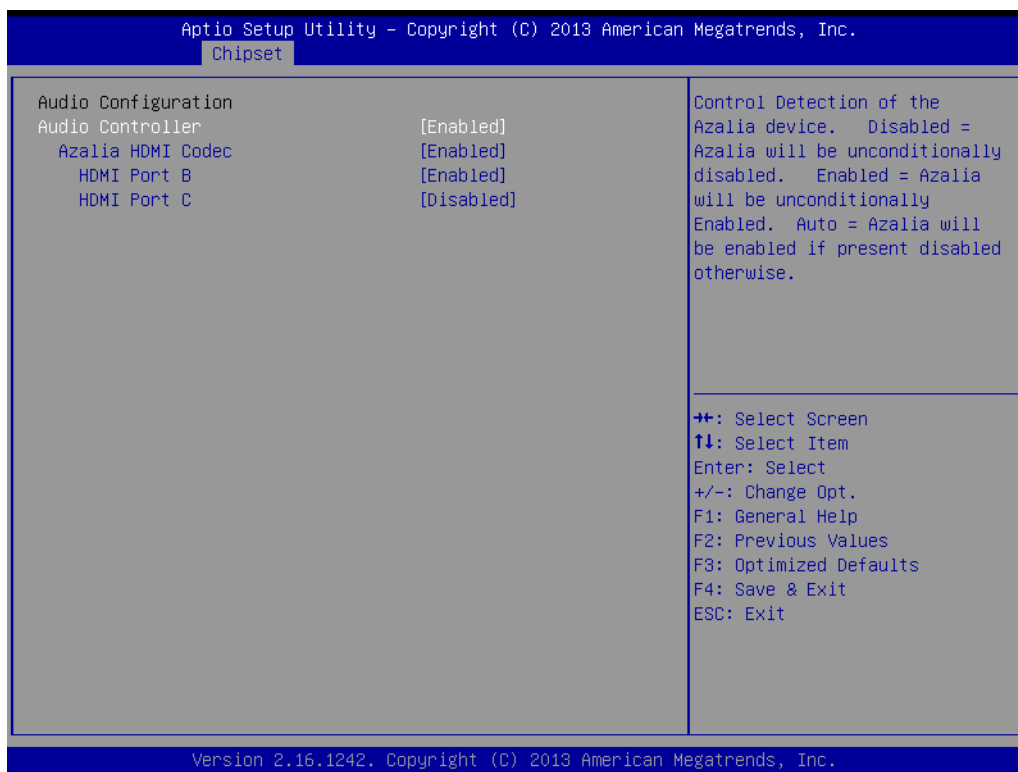

- **Audio Controller**  
Control Detection of the Azalia device. Disabled = Azalia will be unconditionally disabled. Enabled = Azalia will be unconditionally Enabled. Auto = Azalia will be enabled if present, disabled otherwise.
- **Azalia HDMI Codec**  
Enable/Disable internal HDMI codec for Azalia.
- **HDMI Port B**  
Enable/Disable HDMI Port B.
- **HDMI Port C**  
Enable/Disable HDMI Port C.

### 3.2.3.7 USB configuration

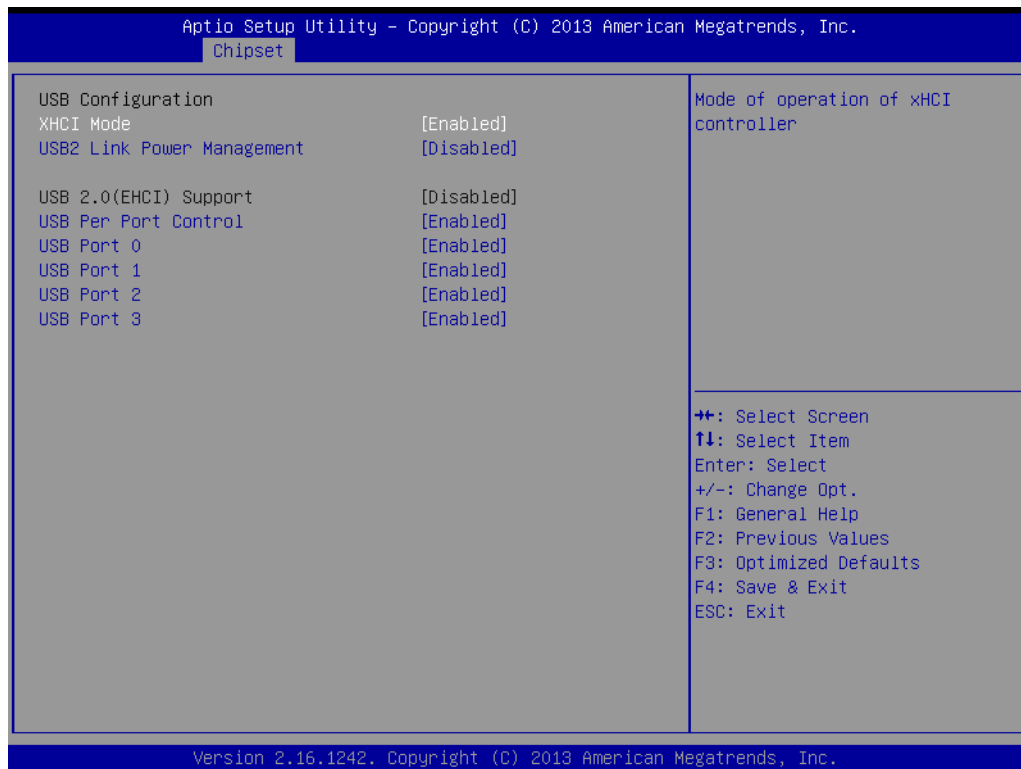

- **XHCI Mode**  
Mode of operation of xHCI controller.
- **USB2 Link Power Management**  
Enable/Disable USB2 Link Power Management.
- **USB 2.0(EHCI) Support**  
Controls the USB EHCI (USB 2.0) functions. One EHCI controller must always be enabled.
- **USB Per Port Control**  
Control each of the USB ports (0~3). Enable: Enable USB per port; Disable: Use USB port X settings.



### 3.2.3.8 PCI Express configuration

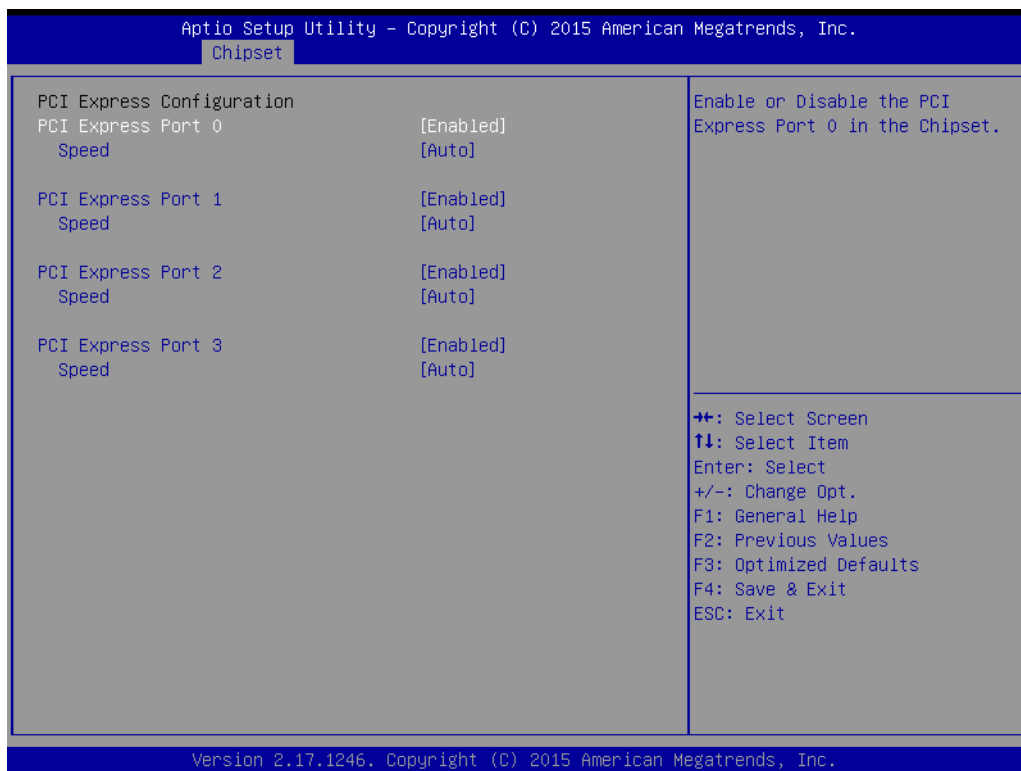

- **PCI Express Port 0**  
Enable or Disable the PCI Express Port 0 in the chipset.
- **Speed**  
Configures PCIe port speed

## 3.2.4 Security

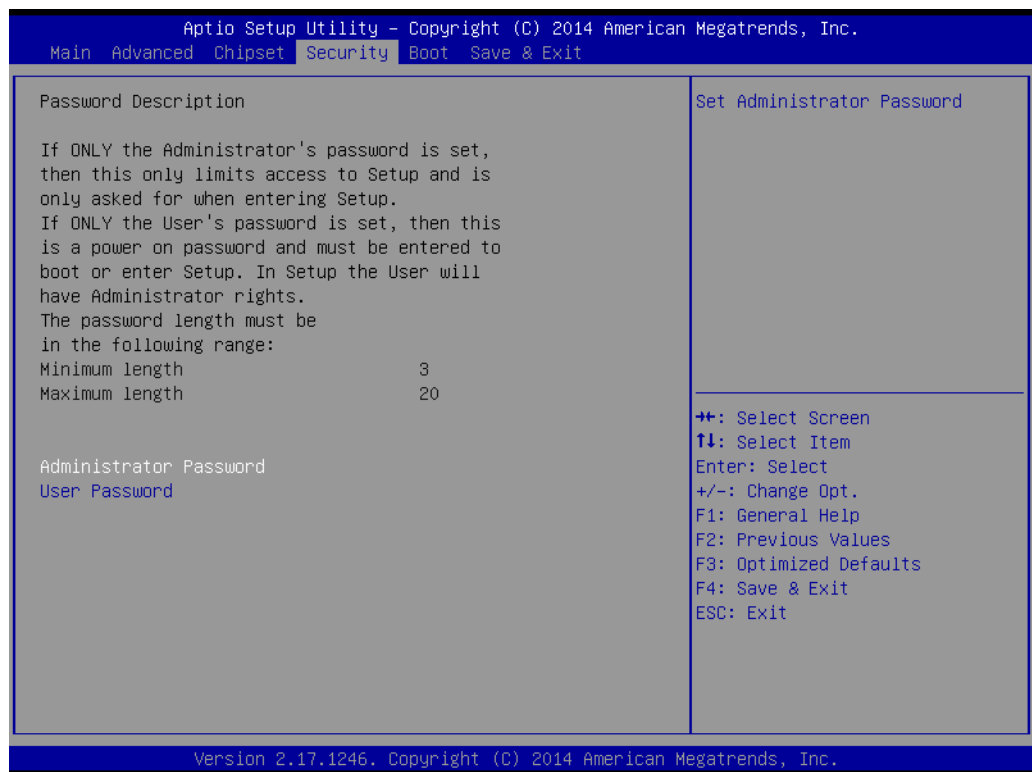

Select Security Setup from the MIO-3260 Setup main BIOS setup menu. All Security Setup options, such as password protection and virus protection, are described in this section. To access the sub menu for the following items, select the item and press <Enter>.

- **Change Administrator / User Password**

## 3.2.5 Boot

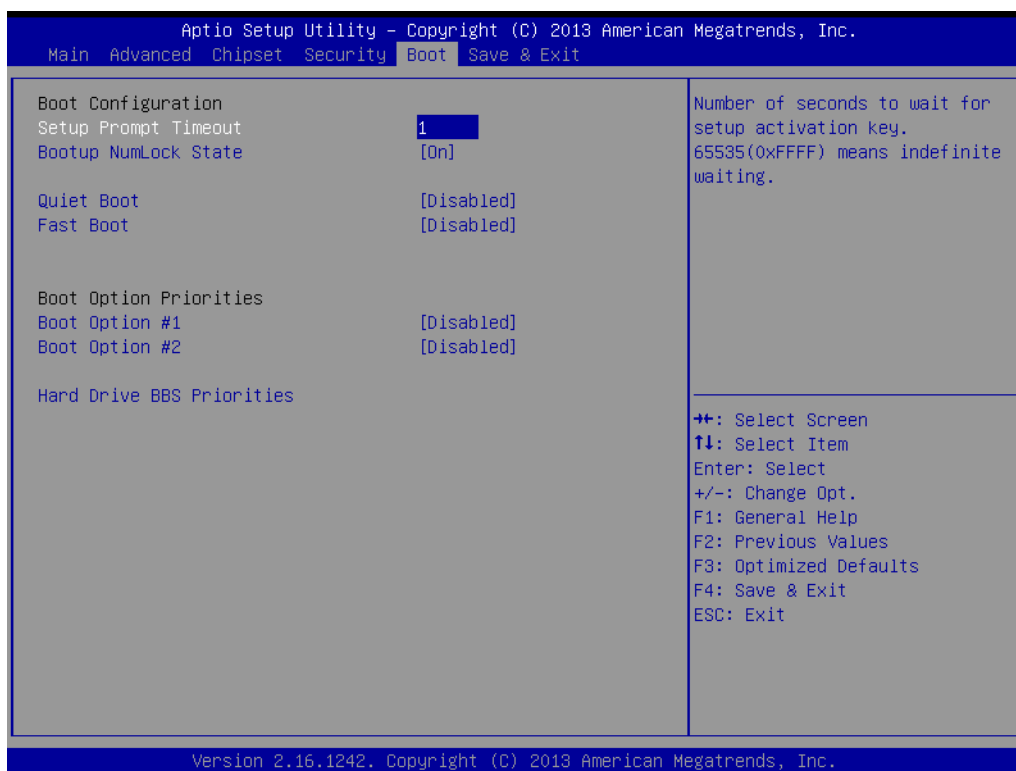

- **Setup Prompt Timeout**  
Number of seconds that the firmware will wait before initiating the original default boot selection. A value of 0 indicates that the default boot selection is to be initiated immediately on boot. A value of 65535(0xFFFF) indicates that firmware will wait for user input before booting. This means the default boot selection is not automatically started by the firmware.
- **Bootup NumLock State**  
Select the keyboard NumLock state.
- **Quiet Boot**  
Enables or disables the Quiet Boot option.
- **Fast Boot**  
Enables or disables boot with initialization of a minimal set of devices required to launch active boot option. Has no effect for BBS boot options.
- **Boot Option #1**  
Sets the system boot order.

## 3.2.6 Save & Exit

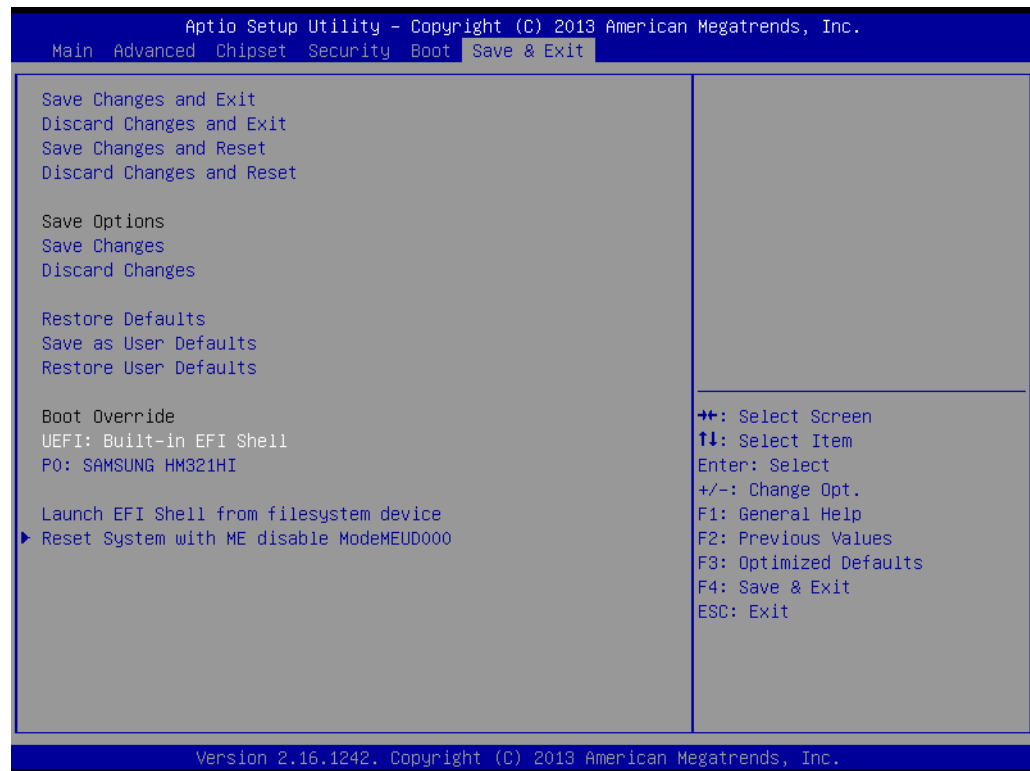

- **Save Changes and Exit**  
This item allows you to exit system setup after saving the changes.
- **Discard Changes and Exit**  
This item allows you to exit system setup without saving any changes.
- **Save Changes and Reset**  
This item allows you to reset the system after saving the changes.
- **Discard Changes and Reset**  
This item allows you to reset system setup without saving any changes.
- **Save Changes**  
This item allows you to save changes done so far to any of the options.
- **Discard Changes**  
This item allows you to discard changes done so far to any of the options.
- **Restore Defaults**  
This item allows you to restore/load default values for all the options.
- **Save as User Defaults**  
This item allows you to save the changes done so far as user defaults.
- **Restore User Defaults**  
This item allows you to restore the user defaults to all the options.
- **Boot Override**  
Boot device select can override your boot priority.

# Chapter 4

S/W Introduction &  
Installation

---

## 4.1 S/W Introduction

The mission of Advantech Embedded Software Services is to "Enhance quality of life with Advantech platforms and Microsoft® Windows® embedded technology." We enable Windows embedded software products on Advantech platforms to more effectively support the embedded computing community. Our goal is to make Windows embedded software solutions easily and widely available to the embedded computing community.

## 4.2 Driver Installation

### 4.2.1 Driver Installation

To install the drivers, please download drivers that need to be installed from Advantech website at [www.advantech.com/support](http://www.advantech.com/support), then launch setup file under each function folder and follow Driver Setup instructions to complete the process.

## 4.3 Value-Added Software Services

Software API: An interface that defines the ways by which an application program may request services from libraries and/or operating systems. It provides not only the underlying drivers required but also a rich set of user-friendly, intelligent and integrated interfaces; this speeds development, enhances security, and offers add-on value for Advantech platforms.

### 4.3.1 SUSI Introduction

To make hardware easier and more convenient to access for programmers, Advantech has released an API (Application Programming Interface) suite in the form of a program library. The program Library is called Secured and Unified Smart Interface or SUSI for short.

In modern operating systems, user space applications cannot access hardware directly. Drivers are required to access hardware. Different operating systems usually define different interfaces for drivers. This means that user space applications call different functions for hardware access in different operating systems. To provide a uniform interface for accessing hardware, an abstraction layer is built on top of the drivers and SUSI is such an abstraction layer. SUSI provides a uniform API for application programmers to access the hardware functions in different Operating Systems and on different Advantech hardware platforms.

Application programmers can invoke the functions exported by SUSI instead of calling the drivers directly. The benefit of using SUSI is portability. The same set of APIs is defined for different Advantech hardware platforms. Also, the same API set is implemented in different Operating Systems. This user's manual describes some sample programs and the API in SUSI. The hardware functions currently supported by SUSI can be grouped into a few categories including Watchdog, I<sup>2</sup>C, SMBus, GPIO, and VGA control. Each SUSI API category is briefly described below.

### 4.3.2 Software APIs

#### 4.3.2.1 The GPIO API

General Purpose Input/Output is a flexible parallel interface that allows a variety of custom connections. It allows users to monitor the level of signal input or set the output status to switch on/off a device. Our API also provides Programmable GPIO, which allows developers to dynamically set the GPIO input or output status.

#### 4.3.2.2 The SMBus API

The System Management Bus (SMBus) is a two-wire interface defined by Intel® Corporation in 1995. It is based on the same principles of operation as I<sup>2</sup>C and is used in personal computers and servers for low-speed system management communications. Nowadays, it can be seen in many types of embedded systems. As with other APIs in SUSI, the SMBus API is available on many platforms including Windows 7.

#### 4.3.2.3 The I<sup>2</sup>C API

I<sup>2</sup>C is a bi-directional two wire bus that was developed by Phillips for use in their televisions in the 1980s. Today, I2C is used in all types of embedded systems.

The I<sup>2</sup>C API allows a developer to interface a Windows 7 or CE PC to a downstream embedded system environment and transfer serial messages using the I2C protocols, allowing multiple simultaneous device control.

#### 4.3.2.4 The Display Control API

There are two kinds of VGA control APIs, backlight on/off control, and brightness control. Backlight on/off control allows a developer to turn the backlight on or off, and to control brightness smoothly.

1. Backlight Control: The Backlight API allows a developer to turn the backlight (screen) on/off in an embedded device.
2. Brightness Control: The Brightness Control API allows a developer to interface with an embedded device to easily control brightness.

#### 4.3.2.5 The Watchdog API

A watchdog timer (abbreviated as WDT) is a hardware device which triggers an action, e.g. rebooting the system, if the system does not reset the timer within a specific period of time. The WDT API in SUSI provides developers with functions such as starting the timer, resetting the timer, and setting the timeout value if the hardware requires customized timeout values.

#### 4.3.2.6 The Hardware Monitor API

The hardware monitor (abbreviated as HWM) is a system health supervision capability achieved by placing certain I/O chips along with sensors for inspecting targets for certain condition indexes, such as fan speed, temperature, voltage, etc.

However, due to the inaccuracy among many commercially available hardware monitoring chips, Advantech has developed a unique scheme for hardware monitoring - achieved by using a dedicated micro-processor with algorithms specifically designed for providing accurate, real-time and reliable data content; helping protect your system in a more reliable manner.

### 4.3.3 SUSI Installation

SUSI supports many different operating systems. Each subsection below describes how to install SUSI and related software on a specific operating system. Please refer to the subsection matching your operating system.

#### 4.3.3.1 Windows 7

In Windows 7, you can install the library, drivers, and demo programs onto the platform easily using the installation tool—The SUSI Library Installer. After the installer has executed, the SUSI Library and related files for Windows 7 can be found in the target installation directory. The files are listed in the following table.

Directory	Contents
\Library	<ul style="list-style-type: none"> <li>■ <b>Susi.lib</b> Library for developing the applications on Windows 7.</li> <li>■ <b>Susi.dll</b> Dynamic library for SUSI on Windows 7.</li> </ul>
\Demo	<ul style="list-style-type: none"> <li>■ <b>SusiDemo.EXE</b> Demo program on Windows 7.</li> <li>■ <b>Susi.dll</b> Dynamic library for SUSI on Windows 7.</li> </ul>
\Demo\SRC	Source code of the demo program on Windows 7.

The following section illustrates the installation process.

**Note!** *The SUSI Library Installer screen shot below is an example only. Your screen may vary depending on your particular version.*



1. Extract Susi.zip.
2. Double-click the "Setup.exe" file.



The installer searches for a previous installation of the SUSI Library. If it locates one, a dialog box opens asking whether you want to modify, repair or remove the software. If a previous version is located, please see the [Maintenance Setup] section. If no previous version is located, an alternative window appears. Click Next.



## 4.3.4 SUSI Sample Programs

### Sample Programs

The sample programs demonstrate how to incorporate SUSI into your program. The sample programs run in graphics mode in Windows® 7, and are described in the subsections below.

### Windows Graphics Mode

Each demo application contains an executable file SusiDemo.exe, a shared library Susi.dll and source code within the release package. SusiDemo.exe is an executable file and it requires the shared library, Susi.dll, to demonstrate the SUSI functions. The source code of SusiDemo.exe must be compiled under Microsoft Visual C++ 6.0 on Windows 7. Developers must add the header file Susi.h and library Susi.lib to their own projects when they want to develop something with SUSI.

### SusiDemo.exe

The SusiDemo.exe test application is an application which uses all functions of the SUSI Library. It has five major function blocks: Watchdog, GPIO, SMBus and VGA control. The following screen shot appears when you execute SusiDemo.exe. You can click function tabs to select test functions respectively. Some function tabs will not show on the test application if your platform does not support such functions. For a complete support list, please refer to Appendix A. We describe the steps to test all functions of this application.

### Information

This page contains the available system information which SUSI gathers from the device.

By the appearance of the information, user can learn whether the SUSI libraries and drivers are installed well and loaded successfully.

Driver version and Library version show the major SUSI version (4.0) and the revision number (12921).

If there is any problem, it is recommended that you send a screenshot of this page or key in the information displayed here to your local FAE.

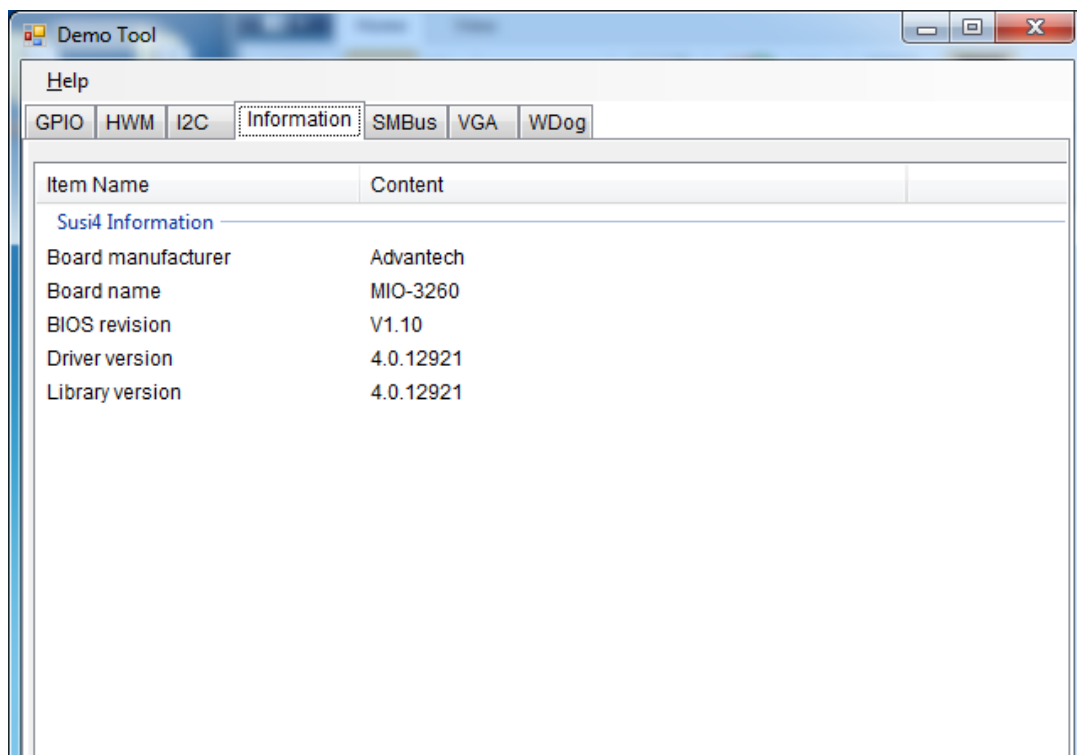



- **GPIO Pin Selection**
  - In **single-pin mode**, you can set and get one pin at a time. Select pin number from Pin number menu to set and get its individual value; pins are numbered from 0 to the total number of GPIO pins minus 1.
  - In **multi-pin mode**, you can set and get the entire bank of pins at a time. Select bank number from Bank number menu to set and get all values of an entire bank pins.
- **Supported Inputs/Outputs of GPIO Pins**
  - Supported inputs and outputs indicate whether each pin is available or controllable as an input and an output. 1 means it does support that transmission direction. For example in the figure above, the board only supports 8 pins of GPIO in bank 0.
- **Mask of GPIO Pins**
  - Mask defines which of its pins is enabling (bit 1) or disabling (bit 0) for set/get of both Direction and Level.
  - Before the setting of direction and level of GPIO pins, mask should be filled with a mask value, and mask cannot be all zeros.
- **Direction Setting**
  - Direction defines the I/O direction of pins: 1 as input and 0 as output.
  - Click Set/Get button to set/get the Direction value.
- **Level Setting**
  - Level defines the level of pins, 1 stands for high level and 0 stands for low level.
  - Click Set/Get button to set/get the Level value. Please note that when the direction of a pin is set as 1, setting Level will not work for it.

### Hardware Monitor

Hardware monitor will read out all accessible hardware sensors for voltage, temperature, fan speed and board current, and record the minimum and maximum values.

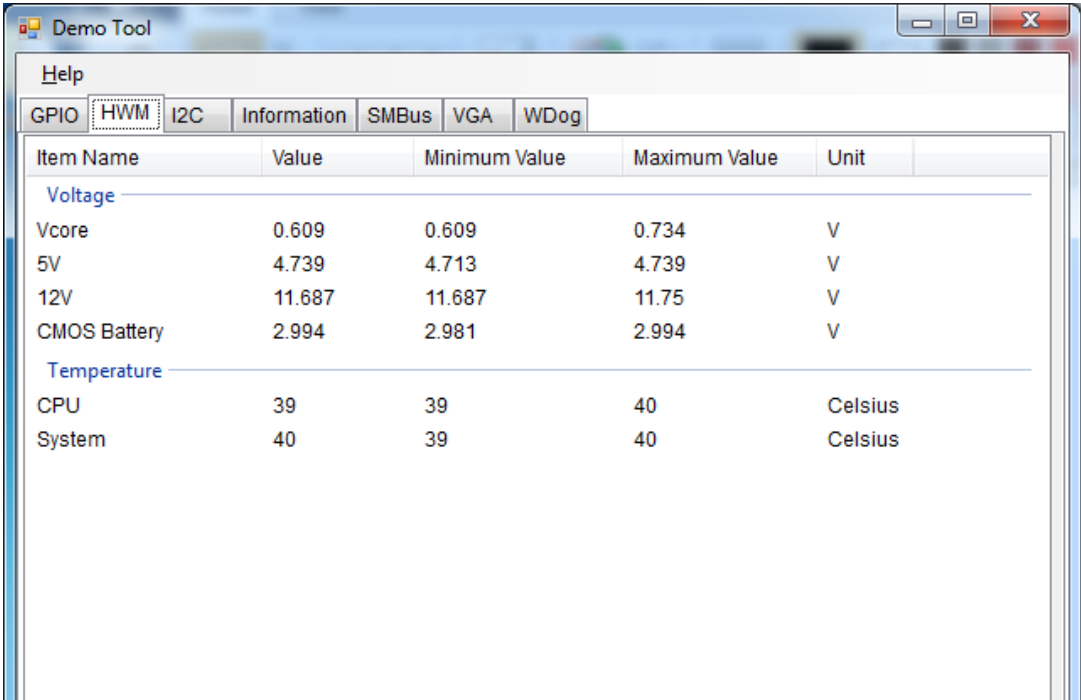

The screenshot shows a window titled "Demo Tool" with a "Help" menu and several tabs: GPIO, HWM (selected), I2C, Information, SMBus, VGA, and WDog. The HWM tab displays a table of hardware monitor data.

Item Name	Value	Minimum Value	Maximum Value	Unit
<b>Voltage</b>				
Vcore	0.609	0.609	0.734	V
5V	4.739	4.713	4.739	V
12V	11.687	11.687	11.75	V
CMOS Battery	2.994	2.981	2.994	V
<b>Temperature</b>				
CPU	39	39	40	Celsius
System	40	39	40	Celsius

## I<sup>2</sup>C

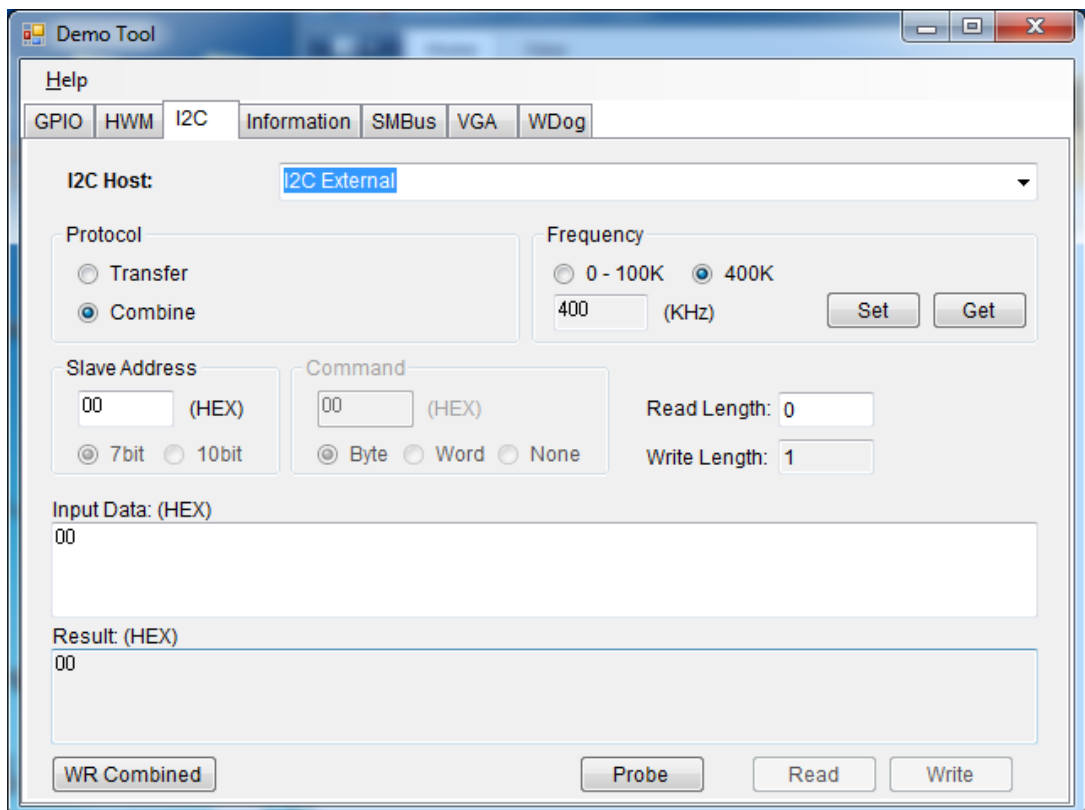
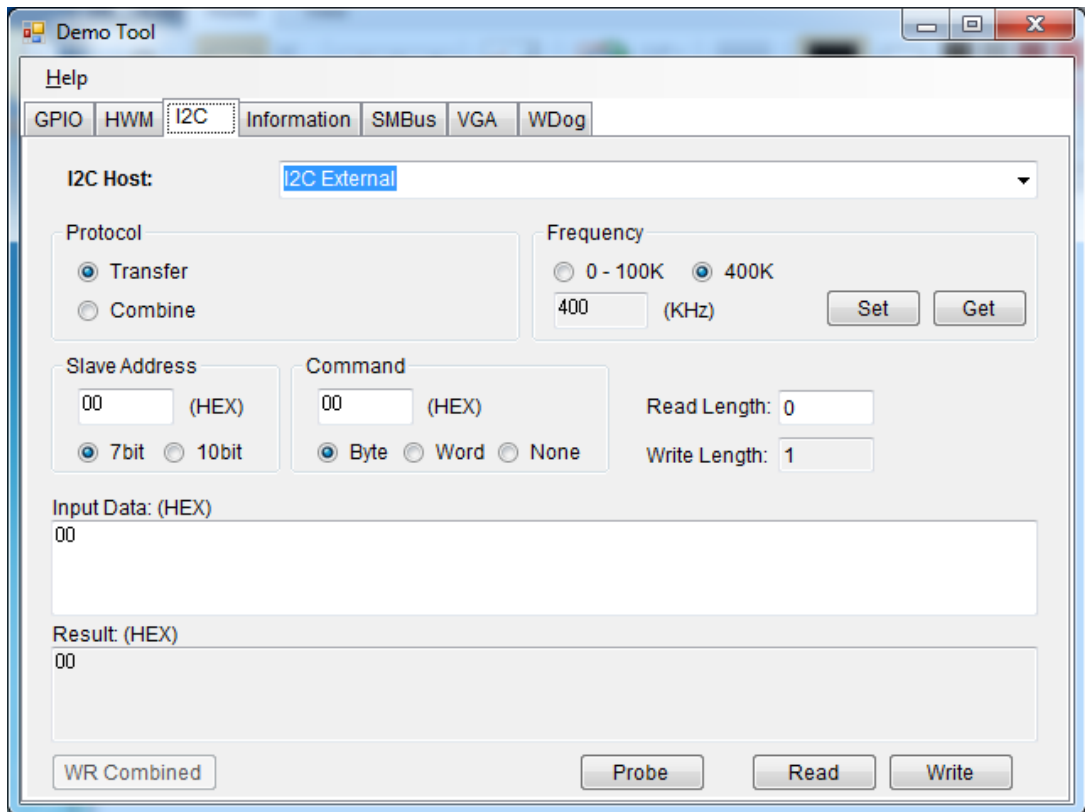

- **Starting of I2C**
  - Select an I2C host, before the starting of any operation.
- **I2C Protocol: Transfer and Combine**
  - Choose the protocols, Transfer or Combine, by clicking the radio button.
  - When selecting Transfer protocol, the Read and Write button will be functional (Otherwise they will be disabled). For how to read/write through this protocol, refer to for section Read from I2C Device and section Write to I2C Device more details.
  - When selecting as Combine protocol, WR Combined button will be functional (Otherwise it will be disabled). For how to read/write through this protocol, refer to section Write/Read Combined for more details.
- **I2C Frequency**
  - Click Get button to get the current frequency of I2C, and the Set button to set your desired value for frequency.
  - Select radio 0-100k button to insert a value of frequency between 0 to 100 KHz, or select 400kHz to directly fill in the frequency as 400kHz.
- **Slave address of the I2C Device**
  - Select radio button of 7-bit or 10-bit for the slave address, and insert an address of the device on I2C. If you'd like to know the address of the existing device, see section Probe for I2C Device for more details.
  - Text box of slave address will prevent you from inserting a value that is out of range.
- **Command/Offset of the I2C Device**
  - Select radio button of Byte, Word or None for the Command.
  - Text box of command will prevent you inserting a value that is out of range; Text box in command region will limit the value in FF h for Byte mode and FFFF h for Word mode; when mode None is selected, the text box will be disabled.
- **Probe for I2C Device**
  - The Probe function will do an address scan of the selected host, each detected address stand for a slave address of a slave device connected to the I2C.
  - The detected address will be shown in the result text box in 7-bit or 10-bit format, depending on your selection of the radio buttons of slave address.
- **Read from I2C Device**
  - Insert the specified slave address and command. For more details of these, please refer to Slave address and Command.
  - Insert the length of data you'd like to read in text box Read Length, and then click the Read button for read/receive operation.
  - The read result will be shown in the Result text box.

---

■ **Write to I2C Device**

- Insert the specified slave address and command. For more details of these, please refer to Slave address and Command.
- Insert the data to be written in the text box Input Data, for notes for text box Input Data and text box Write Length please see the details in (2) and (3) of section Notices for the inputs.
- Click the Write button for write/send operation.
- The write result will be shown in the Result text box.

■ **Write/Read Combined**

- Insert the specified slave address and command. For more detail of these, please refer to Slave address and Command.
- You can either read or write data, or read and write data at the same time in this operation; therefore, either the data for read or write should be provided. For reading, read length should be provided. For writing, input data should be provided. For notes for text box Input Data and text box Write Length please see the details in (2) and (3) in Note below.
- Click WR Combined button to do Read/Write combined operations.
- The read/write result will be shown in the Result text box.

**Note!**



1. *Required values should be provided; grayed out text box indicates that it does not need an input value and the text box will not be editable.*
2. *Text box Write Length will automatically count the length of the data inserted in the Input Data text box.*
3. *Text box Input Data allows inputs of characters [0-9], [a-f], [A-F] and space only. When you are inserting multiple bytes, add a space to let the program know that you are going to insert the next byte data.*

## SMBus

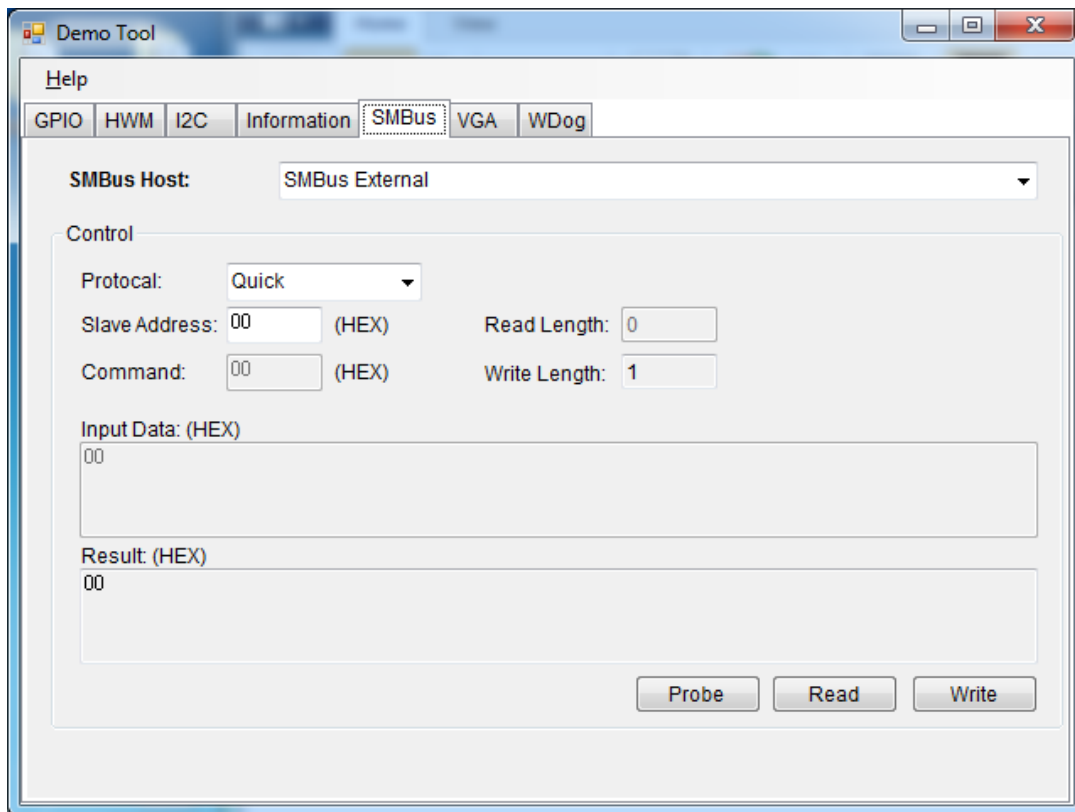

- **Starting SMBus**
  - Select an SMBus host, before starting any SMBus operation.
- **SMBus Protocol**
  - Choose one of the protocols for SMBus from the Protocol pull-down menu; supported protocols include Quick, Byte, Byte Data, Word Data, Block, and I<sup>2</sup>C Block.
  - For each protocol, any required value should be provided; grayed out text box indicates that it does not need an input value and the text box will not be editable.
- **Slave Address of SMBus Device**
  - Insert the slave address of the desired device on SMBus in Slave Address text box. If you'd like to know the address of the existing device, see section Probe for SMBus Device for more details.
  - Slave Address must be an 8- bit value, where the last bit is a variable value. For example, the address of a slave device is 0x69, then you should insert D2 or D3; setting D2 (1101 0010) or D3 (1101 0011) will get the same results.
- **Read from SMBus Device**
  - Insert the specified slave address and command. For more detail of slave address, please refer to Slave Address.
  - Insert the length of data you'd like to read in text box Read Length, and then click Read button for read/receive operation.
  - The read result will be shown in the Result text box.

---

■ **Write to SMBus Device**

- Insert the specified slave address and command. For more details on slave address, please refer to Slave Address.
- Insert the data to be written in text box Input Data, notes for text box Input Data, and text box Write Length; please see the details in (2) and (3) of section Notices for the inputs.
- Click Write button for write/send operation.
- The write result will be shown in the Result text box.

■ **Probe for SMBus Device**

- The Probe function is for address scan of the selected target device, each detected address stands for a slave address of a slave device connected to the SMBus.
- The detected address will be shown in the Result text box in an 8-bit format; for example, if a slave address is 0x69, then it will be shown as D2.

**Note!**



1. *Required values should be provided; grayed out text box indicates that it does not need an input value and the text box will not be editable.*
2. *Text box Write Length will automatically count the length of the data inserted in the Input Data text box.*
3. *Text box Input Data allows inputs of characters [0-9], [a-f], [A-F] and space only. When you are inserting multiple bytes, add a space to let the program know that you are going to insert the next byte data.*



## VGA

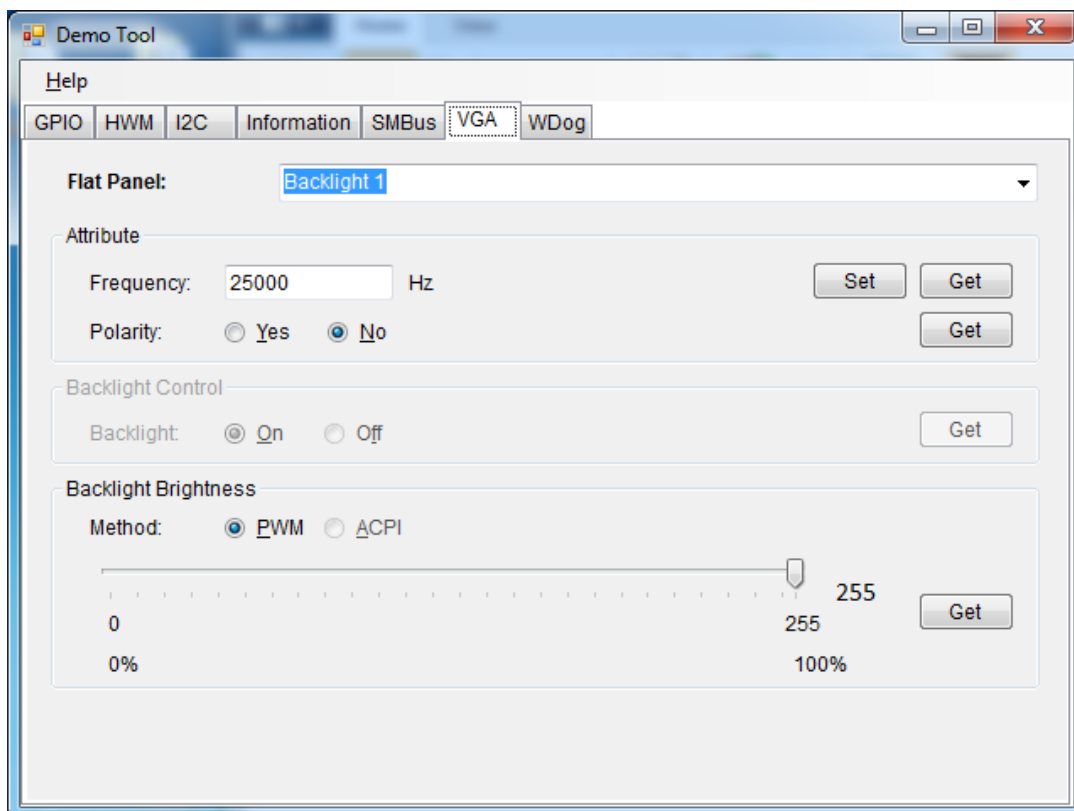

- **Starting of VGA**
  - Select the target panel from the Flat Panel menu.
  - Click Get button of each function to get its current value.
- **Backlight Attribute Settings**
  - For frequency, click Set/Get button aside to set/get the desired value.
  - For polarity, select Yes/No radio buttons to set polarity on/off. If polarity is not controllable, the Yes/No radio buttons will be un-clickable.
- **Backlight ON/OFF**
  - In Backlight Control region, select On/Off radio button to turn on/off. If backlight On/Off is not controllable, the radio buttons will be unclickable.
  - Click Get button to get its current On/Off status.
- **Brightness Adjustment**
  - In Backlight Brightness region, select PWM/ACPI radio button to select the brightness control method. If the backlight control method is not available, the radio button will be un-clickable.
  - Adjust the slider to adjust the brightness value.
  - Click the Get button to get the current brightness value.

## Watchdog Timer

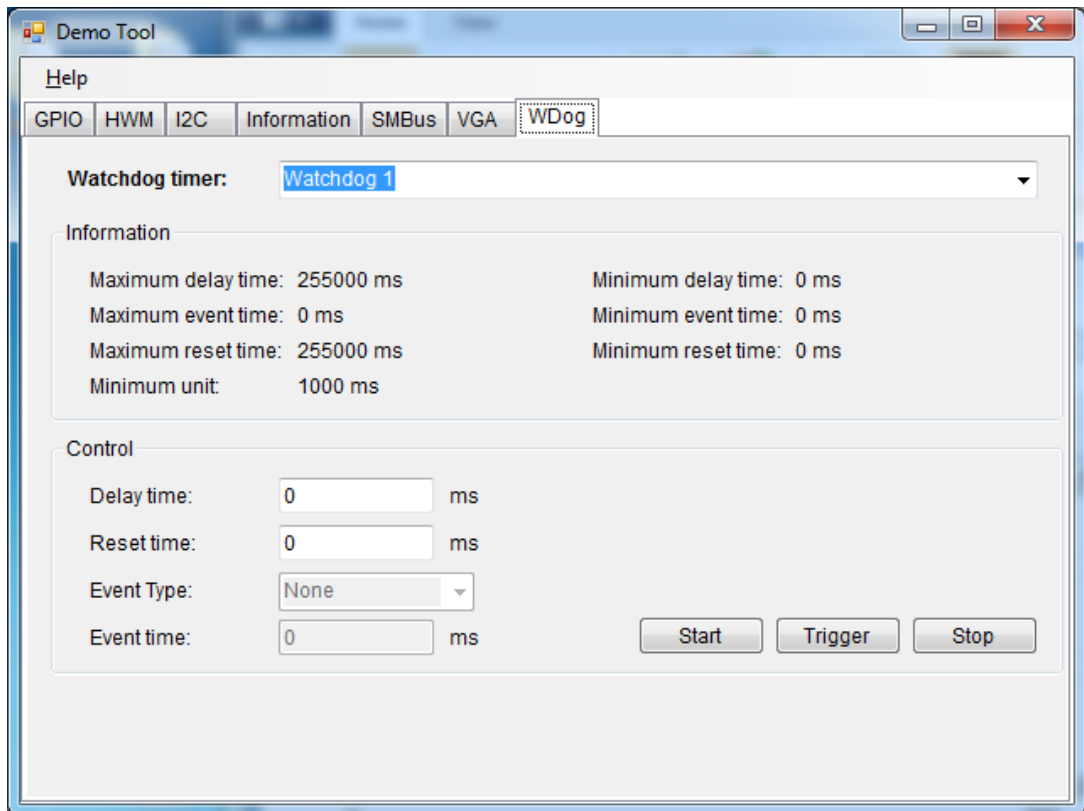

### ■ Time Setting Information

The upper region shows the information for watchdog timer, including supported minimum unit, maximum time and minimum time of delay, event and reset time in milliseconds. Any input value out of the range will lead the SUSI API returning an error/failed message. Minimum unit indicated that when setting any of the value in watchdog, all of them should be an integer multiple of minimum unit.

#### **Example of Time Setting:**

Take the figure above as an example; the supported max delay time is 6553.5 seconds, the min delay time is 0 second, and the min unit time is 0.1 second (100 milliseconds), and every value setting should be an integer multiple of 100 milliseconds. Therefore, you cannot set 150ms as a time here.

### ■ Delay Time Setting

- Set the delay time within range of max/min delay time; for the details of value settings, please refer to section Information of Time Setting.

### ■ Reset Time Setting

- Set the reset time within range of max/min reset time; for the detail of value setting, please refer to section Information of Time Setting.
- As the watchdog timer reaches the end of reset time, the reset process of the board will be started.

### ■ Event Type and Event Time Setting

- Event Type includes None, IRQ, SCI, and Power Button. Event time will be editable when event type is selected as IRQ, SCI, or Power Button, when Event type is None, you don't need to insert the event time.
- Set the event time within range of max/min event time; for the detail of value setting, please refer to section Information of Time Setting.

- As the watchdog timer reaches the end of event time, the event of selected event type will be triggered. If the event is selected as IRQ, a callback function will be called; in our demo program, the callback function will display a message box with texts "Get IRQ Event".
- Some boards will not support event time, in these cases, text box event type and event time will be disabled.
- 
- **Watchdog Timer Control**
  - Start Timer: When all settings are ready, click Start button to start watchdog timer.
  - Trigger Timer: When watchdog timer is started and the delay time ends, click Trigger button to reset/restart the timer.
  - Stop Timer: When watchdog timer has started, clicking the Stop button will completely stop the timer.



# Appendix **A**

## PIN Assignments

## A.1 Jumper Setting

**Table A.1: Jumper List**

J1	LCD Power / Auto Power on
J2	Mini PCIE / mSATA Select

## A.2 Connectors

Label	Function
CN4	64Pin Connector A
CN5	64Pin Connector B
CN6	DDR3L SO-DIMM
CN7	12V Power Input*
CN8	Inverter Power Output/Internal SATA Power*
CN9	VGA*
CN10	USB 2.0 x 2*
CN11	Gigabit Ethernet*
CN11_1	Gigabit Ethernet with LED**
CN14	SATA
CN16	Mini PCIE/mSATA
CN29	MIOe
CN31	18/24-bit LVDS Panel

\*Only for MIO-3260C-S8A1E

\*\*Supported by request

**Table A.2: J1: LCD Power/Auto Power On**

<b>Part Number</b>	1653003260
<b>Footprint</b>	HD_3x2P_79
<b>Description</b>	PIN HEADER 3*2P 180D(M) 2.0mm SMD SQUARE PIN
<b>Setting</b>	<b>Function</b>
(1-2)	+5 V
(3-4) (default)	+3.3 V
(5-6) (default)	Auto Power On

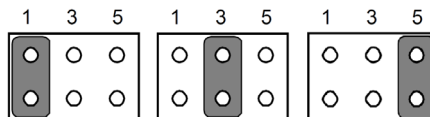

**Table A.3: J2: Mini PCIE / mSATA Select**

<b>Part Number</b>	1653002101-03
<b>Footprint</b>	HD_2x1P_79_H236_D
<b>Description</b>	PIN HEADER 1X2P 2.00mm 180D(M) DIP 1140-000-02SN
<b>Setting</b>	<b>Function</b>
(Open)	mSATA

(Closed) (default)	Mini PCIE
--------------------	-----------

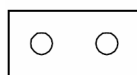

Open

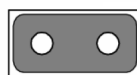

Closed

<b>CN4</b>	<b>64Pin Connector A</b>
<b>Part Number</b>	1653005294-01
<b>Footprint</b>	HD_32x2P_79_21N22050-64S22B
<b>Description</b>	PIN HEADER 2x32P 2.0mm 180D(M) DIP 21N22050-64S2
<b>Pin</b>	<b>Pin Name</b>
1	+V12_DC_IN
2	GND
3	+V12_DC_IN +
4	GND
5	+V12_DC_IN
6	GND
7	+V12_DC_IN
8	GND
9	GND
10	GND
11	GND
12	GND
13	+V5_INVERTER
14	GND
15	LVDS0_ENABKL
16	LVDS0_VBR
17	+V12_INVERTER
18	GND
19	GND
20	GND
21	GND
22	GND
23	VGA_DDAT
24	VGA_DCLK
25	GND
26	GND
27	VGA_R
28	VGA_G
29	VGA_B
30	GND
31	GND_VGA
32	+V5_VGA
33	VGA_HS
34	VGA_VS
35	GND
36	GND

37	GND
38	GND
39	+V5_USB01
40	+V5_USB01
41	USB0_z_P-
42	USB1_z_P-
43	USB0_z_P+
44	USB1_z_P+
45	GND
46	GND
47	GND_IO
48	NC
49	GND
50	GND
51	LINK100#_LED
52	LINK1000#_LED
53	ACT_LED+
54	ACT#_LED
55	LAN0_M0+
56	LAN0_M0-
57	LAN1_M1+
58	LAN1_M1-
59	LAN1_M2+
60	LAN1_M2-
61	LAN1_M3+
62	LAN3_M3-
63	GNDT1
64	GNDT1



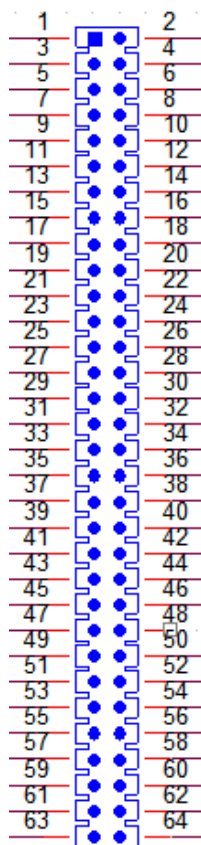

<b>CN5</b>	<b>64Pin Connector B</b>
<b>Part Number</b>	1653006017-01
<b>Footprint</b>	HD_32x2P_79_2HOLD_21N20250
<b>Description</b>	PIN HEADER 2x32P 2.0mm 180D(M) SMD 21N20250-64M2
<b>Pin</b>	<b>Pin Name</b>
1	PSIN#
2	Power LED+
3	GND
4	Power LED-
5	Reset
6	HD LED+
7	GND
8	HD LED-
9	GND
10	+V5_SMB
11	SMB_DAT
12	SMB_CLK
13	I2C_DAT
14	I2C_CLK
15	+V5SB
16	GPIO4
17	GPIO0
18	GPIO5
19	GPIO1

20	GPIO6
21	GPIO2
22	GPIO7
23	GPIO3
24	GND
25	+V5_USB23
26	+V5_USB23
27	USB3_z_P-
28	USB2_z_P-
29	USB3_z_P+
30	USB2_z_P+
31	GND
32	GND
33	GND_IO
34	
35	LOUTR
36	LINR
37	GND_AUD
38	GND_AUD
39	LOUTL
40	LINL
41	GND_AUD
42	GND_AUD
43	MIC1R
44	MIC1L
45	COM0_DCD#
46	COM0_DSR#
47	COM0_RXD
48	COM0_RTS#
49	COM0_TXD
50	COM0_CTS#
51	COM0_DTR#
52	COM0_RI#
53	GND
54	GND
55	COM1_DCD#
56	COM1_DSR#
57	COM1_RXD
58	COM1_RTS#
59	COM1_TXD
60	COM1_CTS#
61	COM1_DTR#
62	COM1_RI#
63	GND
64	GND

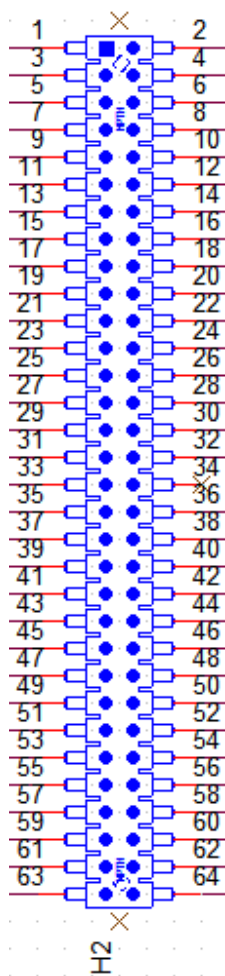
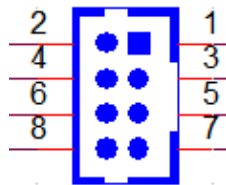

Table A.4: 64-Pin Connector B

Pin	RS-232 Signal Name	RS-422 Signal Name	RS-485 Signal Name
1	DCD	Tx-	DATA-
2	RxD	Tx+	DATA+
3	TxD	Rx+	NC
4	DTR	Rx-	NC
5	GND	GND	GND
6	DSR	NC	NC
7	RTS	NC	NC
8	CTS	NC	NC
9	RI	NC	NC
45	COM0_DCD#	TX-	DATA-
46	COM0_DSR#	NC	NC
47	COM0_RXD	Tx-	DATA+
48	COM0_RTS#	NC	NC
49	COM0_TXD	Rx+	NC
50	COM0_CTS#	NC	NC
51	COM0_DTR#	Rx-	NC
52	COM0_RI#	NC	NC

<b>CN6</b>	<b>DDR3L SO-DIMM</b>
<b>Part Number</b>	1651002083
<b>Footprint</b>	DDR3_204P_AS0A626-JA
<b>Description</b>	DDR3 SODIMM H=9.2mm 204P SMD AS0A626-HARN-7H

<b>CN7</b>	<b>+12V POWER_IN</b>
<b>Part Number</b>	1655003684
<b>Footprint</b>	WF_4x2P_79_BOX_RD1_D
<b>Description</b>	WAFER BOX 2x4P 2.0mm 180D(M) DIP 24W2140-08S10
<b>Pin</b>	<b>Pin Name</b>
1	+V12_DC_IN
2	GND
3	+V12_DC_IN +
4	GND
5	+V12_DC_IN
6	GND
7	+V12_DC_IN
8	GND



<b>CN8</b>	<b>Inverter Power Output / Internal SATA Power</b>
<b>Part Number</b>	1655000025
<b>Footprint</b>	WF_3x2P_79_BOX_D
<b>Description</b>	WAFER BOX 3x2P 2.0mm 180D(M) DIP 2005-2ws-6
<b>Pin</b>	<b>Pin Name</b>
1	+V12_INVERTER
2	GND
3	LVDS0_ENABKL
4	LVDS0_VBR
5	+V5_INVERTER
6	GND

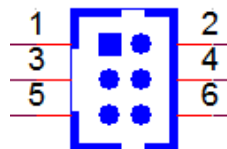

<b>CN9</b>	<b>VGA</b>
------------	------------

<b>Part Number</b>	1655000026
<b>Footprint</b>	WF_6x2P_79_BOX_D
<b>Description</b>	WAFER 6x2P 2.0mm 180D(M) DIP 2005-2WS-12
<b>Pin</b>	<b>Pin Name</b>
1	VGA_HS
2	VGA_VS
3	GND_VGA
4	+V5_VGA
5	VGA_B
6	GND
7	VGA_R
8	VGA_G
9	GND
10	GND
11	VGA_DDAT
12	VGA_DCLK



<b>CN10</b>	<b>USB 2.0 x 2</b>
<b>Part Number</b>	1655002182
<b>Footprint</b>	WF_5x2P_79_BOX_N10_D
<b>Description</b>	WAFER BOX 2x5P 2.0mm 180D(M) DIP 24W2140
<b>Pin</b>	<b>Pin Name</b>
1	+V5_+V5SB
2	+V5_+V5SB
3	USB0_z_P-
4	USB1_z_P-
5	USB0_z_P+
6	USB1_z_P+
7	GND
8	GND
9	GND_IO

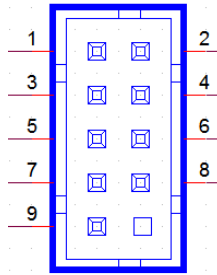

<b>CN11</b>	<b>Gigabit Ethernet</b>
<b>Part Number</b>	1655000197
<b>Footprint</b>	WF_5x2P_79_BOX_D_P1R
<b>Description</b>	WAFER BOX 2x5P 2.00mm 180D(M) DIP 24W2140-10S10
<b>Pin</b>	<b>Pin Name</b>
1	GNDT1
2	GNDT1
3	LAN1_M3+
4	LAN1_M3-
5	LAN1_M2+
6	LAN1_M2-
7	LAN1_M1+
8	LAN1_M1-
9	LAN1_M0+
10	LAN1_M0-

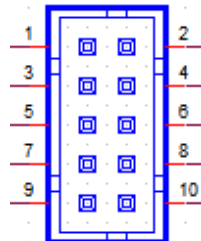

<b>CN11_1</b>	<b>Gigabit Ethernet with LED*</b>
<b>Part Number</b>	1655003483
<b>Footprint</b>	WF_7x2P_79_BOX_D
<b>Description</b>	WAFER BOX 2x7P 2.00mm 180D(M) DIP 24W2140-14S10
<b>Pin</b>	<b>Pin Name</b>
1	GNDT1
2	GNDT1
3	LAN1_M3+
4	LAN1_M3-
5	LAN1_M2+
6	LAN1_M2-
7	LAN1_M1+
8	LAN1_M1-

9	LAN1_M0+
10	LAN1_M0-
11	LAN1_ACT
12	LAN1_ACT#
13	LAN1_LINK100#
14	LAN1_LINK1000#

\*Supported by request

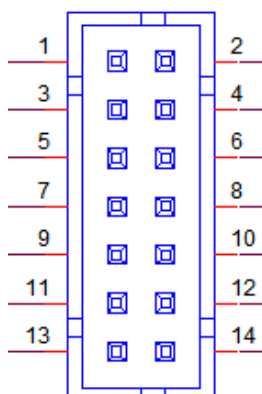

<b>CN14</b>	<b>SATA</b>
<b>Part Number</b>	1654011616-01
<b>Footprint</b>	SATA_7P_WATF-07DBN6SB1U
<b>Description</b>	Serial ATA 7P 1.27mm 180D(M) SMD WATF-07DBLSB1UW
<b>Pin</b>	<b>Pin Name</b>
1	GND
2	TX+
3	TX-
4	GND
5	RX-
6	RX+
7	GND

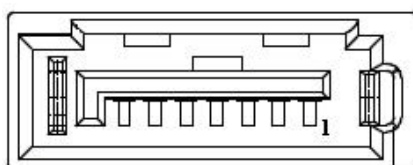

<b>CN16</b>	<b>Mini PCIE/mSATA</b>
<b>Part Number</b>	1654002538
<b>Footprint</b>	H285P5-MTH_MT_H177
<b>Description</b>	MINI PCI E 52P 6.8mm 90D SMD AS0B226-S68Q-7H

<b>Pin</b>	<b>Pin Name</b>
1	WAKE#
2	+V3.3_MINICARD
3	NC
4	GND
5	NC
6	+1.5V
7	NC
8	NC
9	GND
10	NC
11	NC
12	NC
13	NC
14	NC
15	GND
16	NC
17	NC
18	GND
19	NC
20	W_DISABLE#
21	GND
22	PLTRST#
23	mSATA_mPCIE_RX-
24	+V3.3_MINICARD
25	mSATA_mPCIE_RX+
26	GND
27	GND
28	+1.5V
29	GND
30	SMB_CLK
31	mSATA_mPCIE_TX-
32	SMB_DAT
33	mSATA_mPCIE_TX+
34	GND
35	GND
36	USB D-
37	GND
38	USB D+
39	+V3.3_MINICARD
40	GND
41	+V3.3_MINICARD
42	NC
43	GND
44	NC
45	NC
46	NC
47	NC



48	+1.5V
49	NC
50	GND
51	NC
52	+V3.3_MINICARD

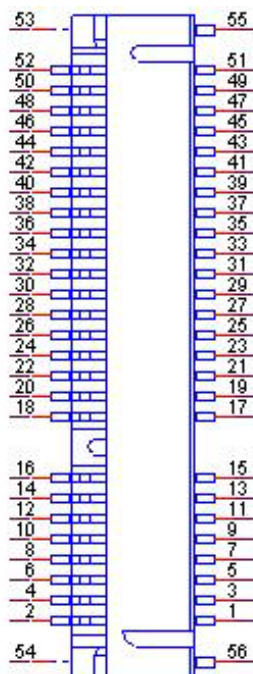

<b>CN29</b>	<b>MIOe</b>
<b>Part Number</b>	1654006235
<b>Footprint</b>	MIOE_CPUSIDE
<b>Description</b>	B/B Conn. 40x2P 0.8mm 180D(F) SMD QSE-040-01-L-D
<b>Pin</b>	<b>Pin Name</b>
1	GND
2	GND
3	PCIE_RX0+
4	PCIE_TX0+
5	PCIE_RX0-
6	PCIE_TX0-
7	GND
8	GND
9	PCIE_RX1+
10	PCIE_TX1+
11	PCIE_RX1-
12	PCIE_TX1-
13	GND
14	GND
15	PCIE_RX2+
16	PCIE_TX2+
17	PCIE_RX2-
18	PCIE_TX2-

19	GND
20	GND
21	PCIE_RX3+
22	PCIE_TX3+
23	PCIE_RX3-
24	PCIE_TX3-
25	GND
26	GND
27	PCIE_CLK+
28	LOUTL
29	PCIE_CLK-
30	LOUTR
31	GND
32	AGND
33	SMB_CLK
34	NC
35	SMB_DAT
36	NC
37	PCIE_WAKE#
38	NC
39	RESET#
40	NC
41	SLP_S3#
42	CLK33M
43	NC
44	LPC_AD0
45	DDP_HPD
46	LPC_AD1
47	GND
48	LPC_AD2
49	DDP_AUX+
50	LPC_AD3
51	DDP_AUX-
52	LPC_DRQ#0
53	GND
54	LPC_SERIRQ
55	DDP0_MIO_TX0+
56	LPC_FRAME#
57	DDP0_MIO_TX0-
58	GND
59	GND
60	USB0_D+
61	DDP0_MIO_TX1+
62	USB0_D-
63	DDP0_MIO_TX1-
64	GND
65	GND
66	USB1_D+/USB_SSTX+

67	DDP0_MIO_TX2+
68	USB1_D-/USB_SSTX-
69	DDP0_MIO_TX2-
70	GND
71	GND
72	USB2_D+/USB_SSRX+
73	DDP0_MIO_TX3+
74	USB2_D-/USB_SSRX-
75	DDP0_MIO_TX3-
76	GND
77	GND
78	USB_OC#
79	+12VSB
80	+12VSB
83	GND
84	GND
85	GND
86	GND
87	+5VSB
88	+5VSB
89	+5VSB
90	+5VSB

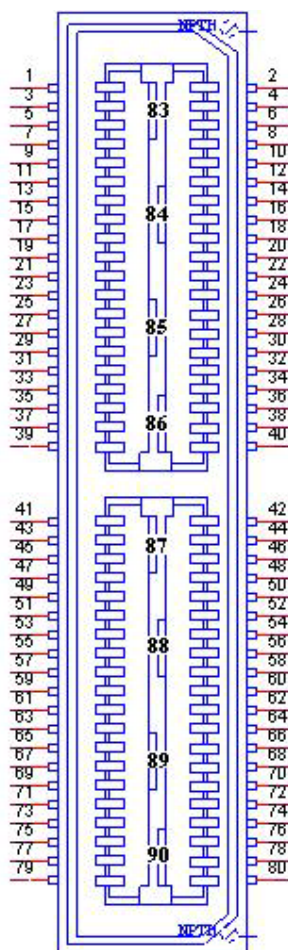

<b>CN31</b>	<b>18/24-bit LVDS Panel</b>
<b>Part Number</b>	1655000753
<b>Footprint</b>	WF14P_49_BOX_RA_85204-14001
<b>Description</b>	WAFER BOX 14x1P 1.25mm 90D(M) SMD 85204-14001
<b>Pin</b>	<b>Pin Name</b>
1	GND
2	GND
3	LVDS0_CLK-
4	LVDS0_CLK+
5	LVDS0_D3-
6	LVDS0_D3+
7	LVDS0_D2-
8	LVDS0_D2+
9	LVDS0_D1-
10	LVDS0_D1+
11	LVDS0_D0-
12	LVDS0_D0+
13	+5V or +3.3V
14	+5V or +3.3V

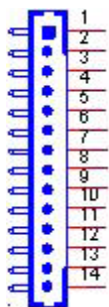



# Appendix **B**

WDT & GPIO

## B.1 Watchdog Timer Sample Code

### Watchdog function:

The SCH3114 Runtime base I/O address is A00h  
Setting WatchDog time value location at offset 66h  
If set value "0", it is mean disable WatchDog function.

```
Superio_GPIO_Port = A00h
mov dx,Superio_GPIO_Port + 66h
mov al,00h
out dx,al
.model small
.486p
.stack 256
.data
SCH3114_IO EQU A00h
.code
org 100h
.STARTup
;=====
;47H
;enable WDT function bit [0]=0Ch
;=====
mov dx,SCH3114_IO + 47h
mov al,0Ch
out dx,al
;=====
;65H
;bit [1:0]=Reserved
;bit [6:2]Reserve=00000
;bit [7] WDT time-out Value Units Select
;Minutes=0 (default) Seconds=1
;=====
mov dx,SCH3114_IO + 65h;
mov al,080h
out dx,al
;=====
;66H
;WDT timer time-out value
;bit[7:0]=0~255
;=====
mov dx,SCH3114_IO + 66h
mov al,01h
out dx,al
;=====
;bit[0] status bit R/W
;WD timeout occurred =1;WD timer counting = 0
```



```

;=====
mov dx,SCH3114_IO + 68h
mov al,01h
out dx,al
.exit
END

```

## B.2 GPIO Sample Code

The SCH3114 Runtime base I/O address is A00h

```

.model small
.486p
.stack 256
.data
SCH3114_IO EQU A00h
.code
org 100h
.STARTup
;=====
; Configuration GPIO as GPI or GPO by below register:
; GPIO0 = 23H, GPIO4 = 27H
; GPIO1 = 24H, GPIO5 = 29H
; GPIO2 = 25H, GPIO6 = 2AH
; GPIO3 = 26H, GPIO7 = 2BH
; Set 00H as output type, set 01H as input type
;=====
;=====
; Register 4BH configuration GPO value as high or low:
; 1 = HIGH
; 0 = LOW
;=====
mov dx,SCH3114_IO + 23h      ;GPIO 0
mov al,00h                  ;Set GPIO 0 as output type
out dx,al
mov dx,SCH3114_IO + 4Bh
mov al,01h                  ;Set GPIO 0 as high value.
out dx,al
.exit
END

```



# Appendix **C**

## System Assignments

## C.1 System I/O Ports

**Table C.1: System I/O Ports**

Addr. Range (Hex)	Device
20-2D	Interrupt Controller
2E - 2F	Motherboard resources
30 - 3D	Interrupt Controller
40 - 43	System timer
4E - 4F	Motherboard resources
50 - 53	System timer
61 - 67	Motherboard resources
70 - 77	System CMOS/real time clock
80 - 92	Motherboard resources
A0 - B1	Interrupt Controller
B2 - B3	Motherboard resources
B4 - BD	Interrupt Controller
2F8 - 2FF	COM2
3B0 - 3DF	Intel® HD Graphics
3F8 - 3FF	COM1
400 - 47F	Motherboard resources
4D0 - 4D1	Interrupt Controller
500-57F	Motherboard resources

## C.2 1st MB Memory Map

**Table C.2: 1st MB Memory Map**

Addr. Range (Hex)	Device
A0000h - BFFFFh	IntelQ® HD Graphics
A0000h - BFFFFh	PCI Bus
C0000h - DFFFFh	PCI Bus
E0000h - FFFFFh	PCI Bus
90400000 - 905FFFFFF	Intel® Trusted Execution Engine Interface
E0000000 - FEFFFFFF	System resources

## C.3 Interrupt Assignments

**Table C.3: Interrupt assignments**

<b>Interrupt#</b>	<b>Interrupt Source</b>
NMI	Parity error detected
IRQ0	System timer
IRQ1	Using SERIRQ, Keyboard Emulation
IRQ2	Slave controller INTR output
IRQ3	Communications Port (COM2)
IRQ4	Communications Port (COM1)
IRQ5	Available
IRQ6	Available
IRQ7	Available
IRQ8	Internal RTC or HPET
IRQ9	Microsoft ACPI-Compliant System
IRQ10	Available
IRQ11	SMBus Port
IRQ12	Available
IRQ13	Numeric data processor
IRQ14	SATA controller
IRQ15	SATA controller

**ADVANTECH**

*Enabling an Intelligent Planet*

**[www.advantech.com](http://www.advantech.com)**

Please verify specifications before quoting. This guide is intended for reference purposes only.

All product specifications are subject to change without notice.

No part of this publication may be reproduced in any form or by any means, electronic, photocopying, recording or otherwise, without prior written permission of the publisher.

All brand and product names are trademarks or registered trademarks of their respective companies.

© Advantech Co., Ltd. 2017