

User Manual

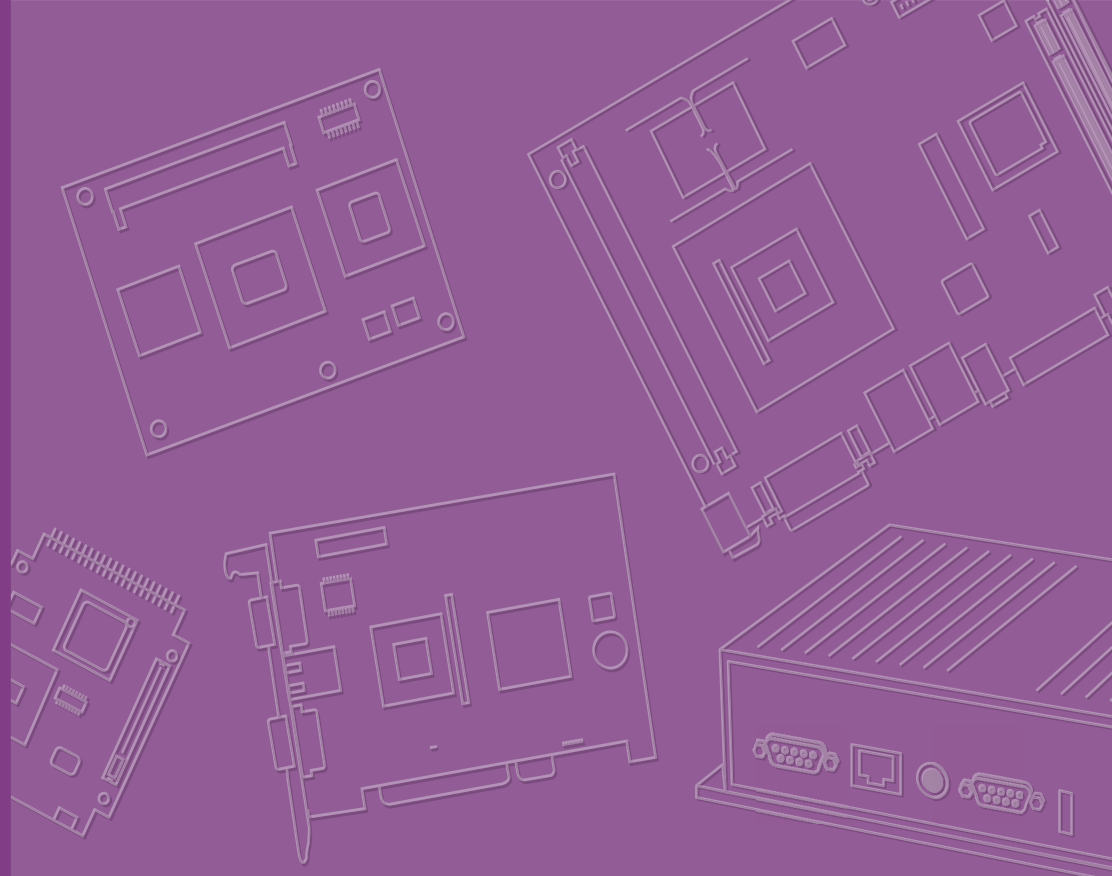

SOM-5898

ADVANTECH

Enabling an Intelligent Planet

Copyright

The documentation and the software included with this product are copyrighted 2018 by Advantech Co., Ltd. All rights are reserved. Advantech Co., Ltd. reserves the right to make improvements in the products described in this manual at any time without notice. No part of this manual may be reproduced, copied, translated or transmitted in any form or by any means without the prior written permission of Advantech Co., Ltd. Information provided in this manual is intended to be accurate and reliable. However, Advantech Co., Ltd. assumes no responsibility for its use, nor for any infringements of the rights of third parties, which may result from its use.

Acknowledgements

Intel and Pentium are trademarks of Intel Corporation.

Microsoft Windows and MS-DOS are registered trademarks of Microsoft Corp.

All other product names or trademarks are properties of their respective owners.

Product Warranty (2 years)

Advantech warrants to you, the original purchaser, that each of its products will be free from defects in materials and workmanship for two years from the date of purchase.

This warranty does not apply to any products which have been repaired or altered by persons other than repair personnel authorized by Advantech, or which have been subject to misuse, abuse, accident or improper installation. Advantech assumes no liability under the terms of this warranty as a consequence of such events.

Because of Advantech's high quality-control standards and rigorous testing, most of our customers never need to use our repair service. If an Advantech product is defective, it will be repaired or replaced at no charge during the warranty period. For out-of-warranty repairs, you will be billed according to the cost of replacement materials, service time and freight. Please consult your dealer for more details.

If you think you have a defective product, follow these steps:

1. Collect all the information about the problem encountered. (For example, CPU speed, Advantech products used, other hardware and software used, etc.) Note anything abnormal and list any onscreen messages you get when the problem occurs.
2. Call your dealer and describe the problem. Please have your manual, product, and any helpful information readily available.
3. If your product is diagnosed as defective, obtain an RMA (return merchandise authorization) number from your dealer. This allows us to process your return more quickly.
4. Carefully pack the defective product, a fully-completed Repair and Replacement Order Card and a photocopy proof of purchase date (such as your sales receipt) in a shippable container. A product returned without proof of the purchase date is not eligible for warranty service.
5. Write the RMA number visibly on the outside of the package and ship it prepaid to your dealer.

Declaration of Conformity

CE

This product has passed the CE test for environmental specifications when shielded cables are used for external wiring. We recommend the use of shielded cables. This kind of cable is available from Advantech. Please contact your local supplier for ordering information.

CE

This product has passed the CE test for environmental specifications. Test conditions for passing included the equipment being operated within an industrial enclosure. In order to protect the product from being damaged by ESD (Electrostatic Discharge) and EMI leakage, we strongly recommend the use of CE-compliant industrial enclosure products.

FCC Class B

Note: This equipment has been tested and found to comply with the limits for a Class B digital device, pursuant to part 15 of the FCC Rules. These limits are designed to provide reasonable protection against harmful interference in a residential installation. This equipment generates, uses and can radiate radio frequency energy and, if not installed and used in accordance with the instructions, may cause harmful interference to radio communications. However, there is no guarantee that interference will not occur in a particular installation. If this equipment does cause harmful interference to radio or television reception, which can be determined by turning the equipment off and on, the user is encouraged to try to correct the interference by one or more of the following measures:

- Reorient or relocate the receiving antenna.
- Increase the separation between the equipment and receiver.
- Connect the equipment into an outlet on a circuit different from that to which the receiver is connected.
- Consult the dealer or an experienced radio/TV technician for help.

FM

This equipment has passed the FM certification. According to the National Fire Protection Association, work sites are classified into different classes, divisions and groups, based on hazard considerations. This equipment is compliant with the specifications of Class I, Division 2, Groups A, B, C and D indoor hazards.

Technical Support and Assistance

1. Visit the Advantech website at <http://support.advantech.com> where you can find the latest information about the product.
2. Contact your distributor, sales representative, or Advantech's customer service center for technical support if you need additional assistance. Please have the following information ready before you call:
 - Product name and serial number
 - Description of your peripheral attachments
 - Description of your software (operating system, version, application software, etc.)
 - A complete description of the problem
 - The exact wording of any error messages

Warnings, Cautions and Notes

Warning! *Warnings indicate conditions, which if not observed, can cause personal injury!*



Caution! *Cautions are included to help you avoid damaging hardware or losing data. e.g.*



There is a danger of a new battery exploding if it is incorrectly installed. Do not attempt to recharge, force open, or heat the battery. Replace the battery only with the same or equivalent type recommended by the manufacturer. Discard used batteries according to the manufacturer's instructions.

Note! *Notes provide optional additional information.*



Document Feedback

To assist us in making improvements to this manual, we would welcome comments and constructive criticism. Please send all such - in writing to: support@advantech.com

Packing List

Before setting up the system, check that the items listed below are included and in good condition. If any item does not accord with the table, please contact your dealer immediately.

- SOM-5898 CPU module
- 1960081253T001 Heatspreader for SOM-5898

Safety Instructions

1. Read these safety instructions carefully.
2. Keep this User Manual for later reference.
3. Disconnect this equipment from any AC outlet before cleaning. Use a damp cloth. Do not use liquid or spray detergents for cleaning.
4. For plug-in equipment, the power outlet socket must be located near the equipment and must be easily accessible.
5. Keep this equipment away from humidity.
6. Put this equipment on a reliable surface during installation. Dropping it or letting it fall may cause damage.
7. The openings on the enclosure are for air convection. Protect the equipment from overheating. **DO NOT COVER THE OPENINGS.**
8. Make sure the voltage of the power source is correct before connecting the equipment to the power outlet.
9. Position the power cord so that people cannot step on it. Do not place anything over the power cord.
10. All cautions and warnings on the equipment should be noted.
11. If the equipment is not used for a long time, disconnect it from the power source to avoid damage by transient overvoltage.
12. Never pour any liquid into an opening. This may cause fire or electrical shock.
13. Never open the equipment. For safety reasons, the equipment should be opened only by qualified service personnel.
14. If one of the following situations arises, get the equipment checked by service personnel:
 - The power cord or plug is damaged.
 - Liquid has penetrated into the equipment.
 - The equipment has been exposed to moisture.
 - The equipment does not work well, or you cannot get it to work according to the user's manual.
 - The equipment has been dropped and damaged.
 - The equipment has obvious signs of breakage.
15. **DO NOT LEAVE THIS EQUIPMENT IN AN ENVIRONMENT WHERE THE STORAGE TEMPERATURE MAY GO BELOW -20° C (-4° F) OR ABOVE 60° C (140° F). THIS COULD DAMAGE THE EQUIPMENT. THE EQUIPMENT SHOULD BE IN A CONTROLLED ENVIRONMENT.**
16. **CAUTION: DANGER OF EXPLOSION IF BATTERY IS INCORRECTLY REPLACED. REPLACE ONLY WITH THE SAME OR EQUIVALENT TYPE RECOMMENDED BY THE MANUFACTURER, DISCARD USED BATTERIES ACCORDING TO THE MANUFACTURER'S INSTRUCTIONS.**

The sound pressure level at the operator's position according to IEC 704-1:1982 is no more than 70 dB (A).

DISCLAIMER: This set of instructions is given according to IEC 704-1. Advantech disclaims all responsibility for the accuracy of any statements contained herein.

Safety Precaution - Static Electricity

Follow these simple precautions to protect yourself from harm and the products from damage.

- To avoid electrical shock, always disconnect the power from your PC chassis before you work on it. Don't touch any components on the CPU card or other cards while the PC is on.
- Disconnect power before making any configuration changes. The sudden rush of power as you connect a jumper or install a card may damage sensitive electronic components.

Contents

Chapter 1	General Information	1
1.1	Introduction	2
	Table 1.1: Acronyms.....	3
1.2	Functional Block Diagram	4
1.3	Product Specification	5
	1.3.1 Compliance	5
	1.3.2 Feature List.....	5
	1.3.3 Processor System.....	6
	1.3.4 Memory	6
	1.3.5 Graphics/Audio	6
	1.3.6 Expansion Interface	7
	1.3.7 Serial Bus.....	7
	1.3.8 I/O	7
	1.3.9 Power Management.....	9
	1.3.10 Environment.....	9
	1.3.11 MTBF	10
	1.3.12 OS Support (duplicate with SW chapter)	10
	1.3.13 Advantech iManager	10
	1.3.14 Power Consumption.....	10
	1.3.15 Performance	11
	1.3.16 Selection Guide w/ P/N	11
	1.3.17 Packing list.....	11
	1.3.18 Development Board	11
	1.3.19 Optional Accessories	11
	1.3.20 Pin Description.....	11
Chapter 2	Mechanical Information	13
2.1	Board Information.....	14
	Figure 2.1 Board chips identify – Front.....	14
	Figure 2.2 Board chips identify – Rear	14
2.1.1	Connector List.....	15
	Table 2.1: FAN1 Fan	15
2.2	Mechanical Drawing.....	15
	Figure 2.3 Board Mechanical Drawing – Front	15
	Figure 2.4 Board Mechanical Drawing – Rear.....	16
	Figure 2.5 Board Mechanical Drawing – Side	16
2.3	Assembly Drawing	17
	Figure 2.6 Assembly Drawing.....	17
2.4	Assembly Drawing	18
	Figure 2.7 CPU 4C+2 Height and Tolerance.....	18
	Figure 2.8 PCH Height and Tolerance.....	18
Chapter 3	BIOS Operation	19
3.1	Introduction	20
	Figure 3.1 Setup program initial screen.....	20
3.2	Entering Setup	21
3.2.1	Main Setup.....	21
	Figure 3.2 Main setup screen	21
3.2.2	Advanced BIOS Features Setup.....	22
	Figure 3.3 Advanced BIOS features setup screen	22
	Figure 3.4 CPU Configuration.....	23

	Figure 3.5 CPU - Power Management Control	24
	Figure 3.6 CPU - Power Management Control	25
	Figure 3.7 GT - Power Management Control	26
	Figure 3.8 PCH-FW Configuration	27
	Figure 3.9 AMT Configuration	28
	Figure 3.10 CIRA Configuration	29
	Figure 3.11 ASF Configuration	30
	Figure 3.12 Secure Erase Configuration	31
	Figure 3.13 OEM Flag Settings	32
	Figure 3.14 MEBx Resolution Settings	33
	Figure 3.15 Firmware Update Configuration	34
	Figure 3.16 PTT Configuration	35
	Figure 3.17 Trusted Computing	36
	Figure 3.18 ACPI Settings	37
	Figure 3.19 iManager Configuration	38
	Figure 3.20 Serial Port 1 Configuration	39
	Figure 3.21 Serial Port 2 Configuration	40
	Figure 3.22 Hardware Monitor	41
	Figure 3.23 W83627DHGSEC Super IO Configuration	42
	Figure 3.24 Serial Port 3 Configuration	43
	Figure 3.25 Serial Port 4 Configuration	44
	Figure 3.26 Parallel Port Configuration	45
	Figure 3.27 Serial Port Console Redirection	46
	Figure 3.28 Serial Port Console Redirection	47
	Figure 3.29 Network Stack Configuration	48
	Figure 3.30 CSM Configuration	49
	Figure 3.31 NVMe Configuration	50
	Figure 3.32 USB Configuration	51
3.2.3	Chipset Setup	52
	Figure 3.33 Chipset Setup	52
	Figure 3.34 System Agent (SA) Configuration	53
	Figure 3.35 Memory Configuration	54
	Figure 3.36 Graphics Configuration	55
	Figure 3.37 LCD Control	56
	Figure 3.38 Intel® Ultrabook Event Support	57
	Figure 3.39 PEG Port Configuration	58
	Figure 3.40 PEH Port Feature Configuration	59
	Figure 3.41 PCH-IO Configuration	60
	Figure 3.42 PCI Express Configuration	61
	Figure 3.43 PCI Express Root Port [0..7]	62
	Figure 3.44 SATA And RST Configuration	63
	Figure 3.45 USB Configuration	64
	Figure 3.46 Security Configuration	65
	Figure 3.47 HD Audio Configuration	66
3.2.4	Security Chipset	67
	Figure 3.48 Security Chipset	67
3.2.5	Boot Setup	68
	Figure 3.49 Boot Setup	68
3.2.6	Save & Exit	69
	Figure 3.50 Save & Exit	69

Chapter 4 S/W Introduction & Installation..... 71

4.1	S/W Introduction	72
4.2	Driver Installation	72
	4.2.1 Windows Driver Setup	72
	4.2.2 Other OS	72
4.3	Advantech iManager	72

Appendix A	Pin Assignment	75
A.1	SOM-5898 Type 6 Pin Assignment.....	76
Appendix B	Watchdog Timer	81
B.1	Programming the Watchdog Timer	82
Appendix C	Programming GPIO	83
C.1	GPIO Register.....	84
Appendix D	System Assignments	85
D.1	System I/O Ports	86
	Table D.1: Table D.1: System I/O ports	86
D.2	DMA Channel Assignments	87
	Table D.2: Table D.2: DMA Channel Assignments	87
D.3	Interrupt Assignments	87
	Table D.3: Table D.3: Interrupt Assignments	87
D.4	1st MB Memory Map	88
	Table D.4: Table D.4: 1st MB Memory Map.....	88

Chapter 1

General Information

This chapter gives background information on the SOM-5898 CPU Computer on Module.

Sections include:

- Introduction
- Functional Block Diagram
- Product Specification

1.1 Introduction

SOM-5898 is equipped with Intel® 7th Generation Core™/ Xeon processors, which are manufactured on Intel14nm process technology. SOM-5898 ECC/non-ECC memory supports DDR4 2400MT/s with 1.2V power design, and up to 32GB dual channel. SOM-5898 not only supports higher memory bandwidth, but also performs better performance, with 33% better battery life than previous. Furthermore, SOM-5898 is able to support 8 x PCIe1 as well as PCIe x1, x2, x4, x8 configured devices if requested. Most important of all, SOM-5898 will adopt 28mm low profile cooler and supports a CPU TDP up to 45watt at 60°C ambient (optional accessory). This is suitable for high I/O designs with high performance requirements, such as ultra sound, military, broadcasting, and industrial automation fields.

Compared with previous platforms there is a 10% growth in processor performance for SOM-5898, and up to 30% better 3D graphics. It supports Quad/ Dual core with GT2, DX12, OpenGL 5.0, and OpenCL 2.1 functions. It also supports multiple displays, such as dual display and triple display configurations, as well as HDMI/DisplayPorts with 4K2K resolution. Dual channel LVDS at 1920x1080 full HD resolution is also available.

Advantech iManager (SUSI4) was designed to satisfy a variety of embedded application requirements such as multi-level watchdog timer, voltage and temperature monitoring, thermal protection and mitigation through processor throttling, LCD backlight on/off, brightness control, and embedded storage. Combined with Advantech SUSI Access, it can remotely monitor and control devices through internet for easy maintenance. All Advantech COM Express modules integrate iManager and SUSI Access to benefit customer's applications. SOM-5898 is suitable for computing intensive designs, thermal sensitive designs, and I/O demanding applications.

Table 1.1: Acronyms

Term	Define
AC'97	Audio CODEC (Coder-Decoder)
ACPI	Advanced Configuration Power Interface – standard to implement power saving modes in PC-AT systems
BIOS	Basic Input Output System – firmware in PC-AT system that is used to initialize system components before handing control over to the operating system
CAN	Controller-area network (CAN or CAN-bus) is a vehicle bus standard designed to allow microcontrollers to communicate with each other within a vehicle without a host computer
DDI	Digital Display Interface – containing DisplayPort, HDMI/DVI, and SDVO
EAPI	Embedded Application Programmable Interface Software interface for COM Express® specific industrial function <ul style="list-style-type: none"> – System information – Watchdog timer – I2C Bus – Flat Panel brightness control – User storage area – GPIO
GbE	Gigabit Ethernet
GPIO	General purpose input output
HDA	Intel High Definition Audio (HD Audio) refers to the specification released by Intel in 2004 for delivering high definition audio that is capable of playing back more channels at higher quality than AC'97
I2C	Inter Integrated Circuit – 2 wire (clock and data) signaling scheme allowing communication between integrated circuit, primarily used to read and load register values
ME	Management Engine
PC-AT	“Personal Computer – Advanced Technology” – an IBM trademark term used to refer to Intel based personal computer in 1990s
PEG	PCI Express Graphics
RTC	Real Time Clock – battery backed circuit in PC-AT systems that keeps system time and date as well as certain system setup parameters
SPD	Serial Presence Detect – refers to serial EEPROM on DRAMs that has DRAM Module configuration information
TPM	Trusted Platform Module, chip to enhance the security features of a computer system
UEFI	Unified Extensible Firmware Interface
WDT	Watch Dog Timer

1.2 Functional Block Diagram

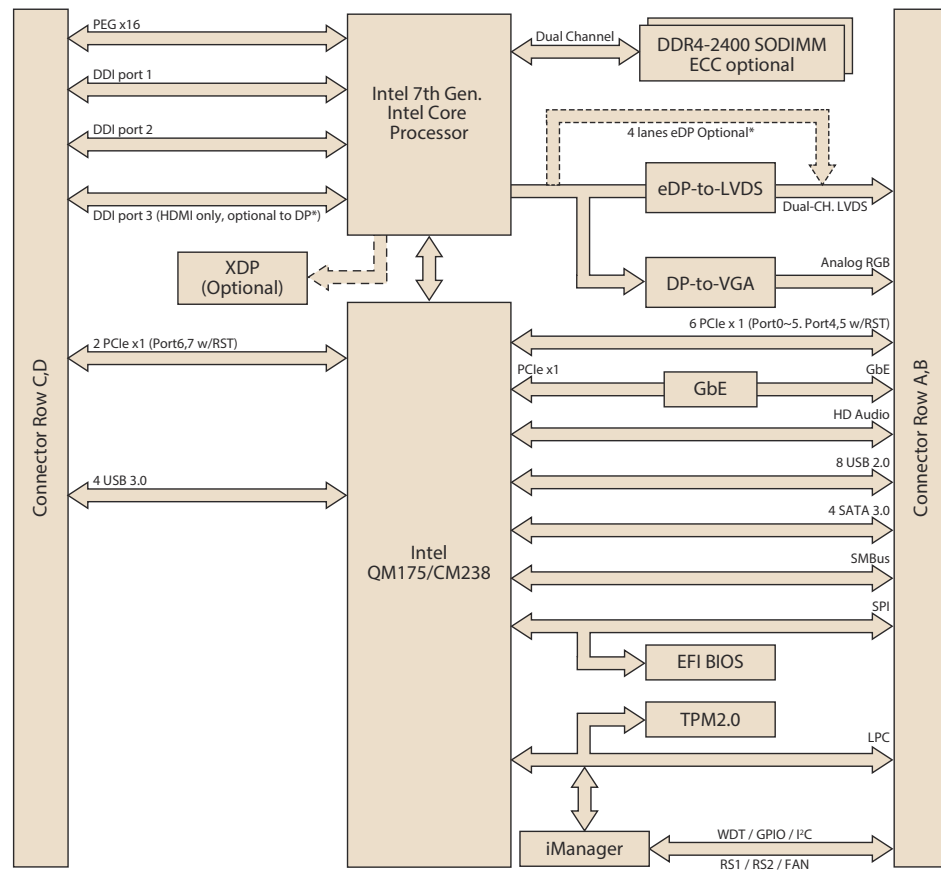

***Display Configuration Table**

Default	DDI1 (DP++)	DDI2 (DP++)	DDI3 (HDMI only)	LVDS	VGA
Optional	DDI1 (DP++)	DDI2 (DP++)	DDI3 (DP++)	eDP (4 lanes)	

1.3 Product Specification

1.3.1 Compliance

- PICMG COM.0 (COM Express) Revision 2.1
- Basic Size – 125 x 95mm
- Pin-out Type 6 compatible

1.3.2 Feature List

Feature Type	Connector Row	Feature	Type 6 Define		SOM-5898
			Max.	Min.	
Display	A-B	LVDS Channel A (18/24-bit)	1	0	1
	A-B	LVDS Channel B (18/24-bit)	1	0	1
	A-B	eDP (muxed on LVDS Channel A)	1	0	1
	A-B	VGA	1	0	1
Expansion	A-B	PCI Express x1	6	1	8
	A-B	LPC	1	1	1
Serial	A-B	SMBus	1	1	1
	A-B	I2C Bus	1	1	1
	A-B	Serial Port	2	0	2
	A-B	CAN Bus (muxed on SER1)	1	0	1
I/O	A-B	LAN Port 0 (Gigabit Ethernet)	1	1	1
	A-B	SATA	4	1	4
	A-B	USB2.0	8	4	8
	A-B	USB Client	1	0	0
	A-B	HD Audio	1	0	1
	A-B	SPI Bus	2	1	1
	A-B	General Purpose I/O (GPIO)	8	8	8
	A-B	SDIO (muxed on GPIO)	1	0	0
	A-B	Express Card Support	2	1	2
	A-B	Watchdog Timer Output	1	0	1
	A-B	Speaker Out	1	1	1
	A-B	External BIOS ROM Support	2	0	2
	A-B	Power Button Support	1	1	1
	A-B	Power Good	1	1	1
	A-B	VCC_5V_SBY Contacts	4	4	4
	A-B	Sleep	1	0	1
	A-B	Thermal Protection	1	0	1
	A-B	Lid Input	1	0	1
	A-B	Battery Low Alarm	1	0	1
	A-B	Suspend/Wake Signals	3	0	3
A-B	Fan PWM / Tachometer	2	0	2	
A-B	Trusted Platform Modules	1	0	1	
Display	C-D	Digital Display Interfaces 1 - 3	3	0	3
I/O	C-D	PEG (PCI Express x16)	1	0	1
	C-D	PCI Express x1	2	0	2
	C-D	USB3.0	4	0	4

1.3.3 Processor System

CPU	Std. Freq.	Max. Turbo Freq.	Core	Cache (MB)	TDP(W)
i7-7820EQ	3.0GHz	3.7GHz	4	8	45
i5-7440EQ	2.9GHz	3.6GHz	4	6	45
i5-7442EQ	2.1GHz	2.9GHz	4	6	25
i3-7100E	2.9GHz	NA	2	3	35
i3-7102E	2.1GHz	NA	2	3	25
E3-1505M V6	3.0GHz	4.0GHz	4	8	45
E3-1505L V6	2.2GHz	3.0GHz	4	8	25
E3-1501M V6	2.9GHz	3.6GHz	4	8	45
E3-1501L V6	2.2GHz	2.9GHz	4	8	25

1.3.4 Memory

Dual channels 2 sockets support DDR4 2400MHz up to 32GB (supported ECC)

Maximum support 16G + 16G on each socket

1.3.5 Graphics/Audio

Graphic Core: Intel® Gen9 HD/P630 Graphic supports DX12, OGL5.0, OCL2.1, and MPEG2, HEVC/H265, VC1/WMV9 HW decode/encode/transcode acceleration.

CPU	Graphic Core	Base Freq.	Max Freq.
i7-7820EQ	Gen9 HD Graphic	350MHz	1000MHz
i5-7440EQ	Gen9 HD Graphic	350MHz	1000MHz
i5-7442EQ	Gen9 HD Graphic	350MHz	1000MHz
i3-7100E	Gen9 HD Graphic	350MHz	950MHz
i3-7102E	Gen9 HD Graphic	350MHz	950MHz
E3-1505M V6	HD Graphic P630	350MHz	1100MHz
E3-1505L V6	HD Graphic P630	350MHz	1000MHz
E3-1501M V6	HD Graphic P630	350MHz	1000MHz
E3-1501L V6	HD Graphic P630	350MHz	1000MHz

1.3.6 Expansion Interface

1.3.6.1 PCIe x1

PCI Express x1: Supports default 8 x PCIe x1 compliant ports Gen3 (8.0 GT/s) specification, configurable to PCIe x4 or PCIe x2. Several configurable combinations may need BIOS modification. Please contact to Advantech sales or FAE for more details.

Type 6	Row A,B				Row C,D			
	P0	P1	P2	P3	P4	P5	P6	P7
Default	X1	X1	X1	X1	X1	X1	X1	X1
Option 1	Config.	X1	X1	X2	X1	X1	X2	
Option 2		X2		X2		X2	X2	
Option 3			X4			X4		

1.3.6.2 LPC

Supports Low Pin Count (LPC) 1.1 specification, without DMA or bus mastering. Allow to connect Super I/O, embedded controller, or TPM. LPC clock is 25MHz.

1.3.7 Serial Bus

1.3.7.1 SMBus

Supports SMBus 2.0 specification with Alert pin.

1.3.7.2 I2C Bus

Supports I2C bus 8-bit and 10-bit address modes, at both 100KHz and 400KHz.

1.3.8 I/O

1.3.8.1 Gigabit Ethernet

Ethernet: Intel I219LM Gigabit LAN supports 10/100/1000 Mbps Speed.

1.3.8.2 SATA

Supports 4 x ports SATA Gen3 (6.0 Gb/s), backward compliant to SATA Gen2 (3.0 Gb/s) and Gen1 (1.5 Gb/s). Maximum data rate is 600 MB/s. Supports AHCI 1.3 mode.

1.3.8.3 USB3.0/USB2.0

4 x ports USB3.0 (5.0 Gbps) and 4 x ports USB2.0 (480 Mbps) which are backward compatible to USB1x. For USB3.0, supports LPM (U0, U1, U2, and U3) to save power.

1.3.8.4 USB3.0

Type 6	P0	P1	P2	P3
SoC	P0	P1	P2	P3
Type 6	OC_01		OC_23	
SoC USB_OC#	OC_0		OC_2	

1.3.8.5 USB2.0

Type 6	P0	P1	P2	P3
SoC	P0	P1	P2	P3
Type 6	OC_01		OC_23	
SoC USB_OC#	OC_0		OC_2	

1.3.8.6 SPI Bus

Supports BIOS flash only. SPI clock can be 50MHz, 33MHz, or 20MHz, capacity up to 16MB.

1.3.8.7 GPIO

8 x programmable general purpose Input or output (GPIO).

1.3.8.8 Watchdog

Supports multi-level watchdog time-out output. Provides 1-65535 levels, from 100ms to 109.22 minutes intervals.

1.3.8.9 Serial port

2 ports 2-wire serial ports (Tx/Rx) with 16550 UART compliance.

- Programmable FIFO or character mode
- 16-byte FIFO buffer on transmitter and receiver in FIFO mode
- Programmable serial-interface characteristics: 5, 6, 7, or 8-bit character
- Even, odd, or no parity bit selectable
- 1, 1.5, or 2 stop bit selectable
- Baud rates up to 115.2K

1.3.8.10 Express Card

Two sets of Express Card control signals including card detection and reset following PICMG COM Express R2.1 specification.

1.3.8.11 TPM

Supports TPM 2.0 module by default.

1.3.8.12 Smart Fan

Supports 2 x Fan PWM control signals and 2 x tachometer inputs for fan speed detection. Provides one on module with connector and the other to the carrier board, both following PICMG COM Express R2.1 specification.

1.3.8.13 BIOS

BIOS chip is on module by default. Also allows the user to place the BIOS chip on the carrier board with an appropriate design and jumper setting on BIOS_DIS#[1:0].

BIOS_DIS0#	BIOS_DIS#1	Boot up destination/function
Open	Open	Boot from Module's SPI BIOS
Open	GND	SPI_CS0# to Carrier Board, SPI_CS1# to Module
GND	GND	SPI_CS0# to Module, SPI_CS1# to Carrier Board

Note! *If system COMS is cleared, we strongly suggest to go BIOS setup menu and load default setting the first time of boot up.*



1.3.9 Power Management

1.3.9.1 Power Supply

Supports both ATX and AT power modes. VSB is for suspend power and can be optional if standby (suspend-to-RAM) support is not needed. RTC Battery may be optional too if keeping time/date is not required.

VCC: 8.5V (9V-5%) – 20V (19V+5%)

VSB: 5V +/- 5% (Suspend power)

RTC Battery Power: 2.0V – 3.3V

1.3.9.2 PWROK

Power OK from the main power supply. A high value indicates that the power is good. This signal can be used to hold off the module startup to allow carrier based FPGAs or other configurable devices time to be programmed.

1.3.9.3 Power Sequence

According to PICMG COM Express R 2.1 specification

1.3.9.4 Wake Event

Various wake-up events allow the user to apply to different scenarios.

- Wake-on-LAN(WOL): Wake to S0 from S3/S4/S5
- USB Wake: Wake to S0 from S3/S4
- PCIe Device Wake: depends on user inquiry and may need customized BIOS
- LPC Wake: depends on user inquiry and may need customized BIOS

1.3.9.5 Advantech S5 ECO Mode (Deep Sleep Mode)

Advantech iManager provides additional features to allow the system enter a very low suspend power mode – S5 ECO mode. In this mode, the module will cut all power including suspend and active power into the chipset and keep an on-module controller active, which means the battery pack can last longer. While this mode is enabled in BIOS, the system (or module) only allows a power button to boot rather than others such as WOL.

1.3.10 Environment

1.3.10.1 Temperature

- Operating: 0 ~ 60° C (32 ~ 140° F), with an active heatsink under 0.7m/s air flow chamber
- Storage: -40 ~ 85° C (-40 ~ 185° F)

1.3.10.2 Humidity

- Operating: 40° C @ 95% relative humidity, non-condensing
- Storage: 60° C @ 95% relative humidity, non-condensing

1.3.10.3 Vibrations

IEC60068-2-64: Random vibration test under operation mode, 3.5Grms

1.3.10.4 Drop Test (Shock)

Federal Standard 101 Method 5007 test procedure with standard packing

1.3.10.5 EMC

CE EN55022 Class B and FCC Certifications: validate with standard development boards in Advantech chassis.

1.3.11 MTBF

Please refer to Advantech SOM-5898 Series Reliability Prediction Reporton website:
Link: <http://com.advantech.com>

1.3.12 OS Support (duplicate with SW chapter)

The mission of Advantech Embedded Software Services is to "Enhance quality of life with Advantech platforms and Microsoft Windows embedded technology." We enable Windows Embedded software products on Advantech platforms to more effectively support the embedded computing community. Customers are freed from the hassle of dealing with multiple vendors (Hardware suppliers, System integrators, Embedded OS distributor) for projects. Our goal is to make Windows Embedded Software solutions easily and widely available to the embedded computing community.

To install the drivers, please connect to internet and browse the website <http://support.advantech.com.tw> to download the setup file.

1.3.13 Advantech iManager

Support APIs for GPIO, smart fan control, multi-stage watchdog timer and output, temperature sensor, hardware monitor, etc. Follow by PICMG EAPI 1.0 specification that provides backward compatibility.

1.3.14 Power Consumption

Power Consumption Table (Watt.)						
VCC=12V, VSB=5V	Active Power Domain			Suspend Power Domain		Mechanical off
Power State	S0 Max. Load	S0 Burn-in	S0 Idle	S5	S5 Deep Sleep	RTC (uA)
SOM-5898C7-H0A1	52.1W	48.1W	6.8W	0.232W	0.020W	4.64uA

Hardware Configurations:

1. MB: SOM-5898C7-H0A1 (PCB_A101-1)
2. DRAM: 16GB DDR4 2400MHz *2
3. Carrier board: SOM-DB5800 A201-2

Test Condition:

1. Test temperature: room temperature (about 25°C)
2. Test voltage: rated voltage DC +12.0V
3. Test loading:
 - 3.1 Maximum load mode: According to Intel thermal/power test tools
 - 3.2 Burn-in mode: BurnInTest V8.1 Pro(1013)(CPU, RAM, 2D&3D Graphics and Disk with 100%)
 - 3.3 Idle mode: DUT power management off and no running any program.
4. OS: Windows 10 Enterprise

1.3.15 Performance

For reference performance or benchmark data that compares with other modules, please refer to “Advantech COM Performance & Power Consumption Table”.

1.3.16 Selection Guide w/ P/N

Part No.	CPU	Freq.	Cores	CPU TDP	DDR4 Memory	Thermal Solution	Operating Temperature
SOM-5898C7-H0A1	i7-7820EQ	3.0	4	45W	non-ECC	Active	0 ~ 60 °C

1.3.17 Packing list

Part No.	Description	Quantity
-	SOM-5898 CPU module	1
1960081253T001	Heatspreader	1

1.3.18 Development Board

Part No.	Description
SOM-DB5800-00A2E	COMe Devel. Board Type6 pint-out Rev. A2

1.3.19 Optional Accessories

Part No.	Description
1960048820N001	Semi-Cooler 125 x 95 x 33 mm with 12V FAN
1960073941T001	DHCS with 12V internal fan (125 x 95 x 28.3 mm)
1960073941T011	DHCS with 12V external fan (125 x 95 x 43 mm)

* Test conditions follow Advantech regulations and procedures.

1.3.20 Pin Description

Advantech provides useful checklists for schematic design and layout routing. In schematic checklist, it will specify detail about each pin electrical properties and how to connect for different user scenes. In layout checklist, it will specify the layout constraints and recommendations for trace length, impedance, and other necessary information during design.

Please contact your nearest Advantech branch office or call for getting the design documents and further advance supports.

Chapter 2

Mechanical Information

This chapter gives mechanical information on the SOM-5898 CPU Computer on Module Module.

Sections include:

- Board Information
- Mechanical Drawing
- Assembly Drawing

2.1 Board Information

The figures below indicate the main chips on SOM-5898 Computer-on-Module. Please aware of these positions while designing the customer's own carrier board to avoid mechanical violence and thermal solutions contacts for best thermal performance.

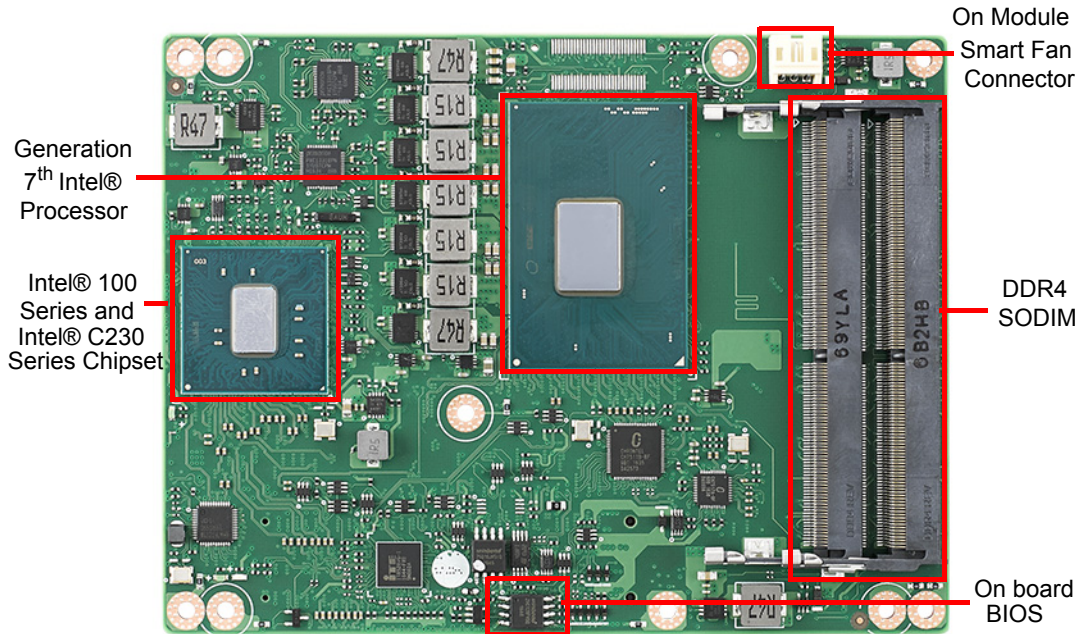

Figure 2.1 Board chips identify – Front

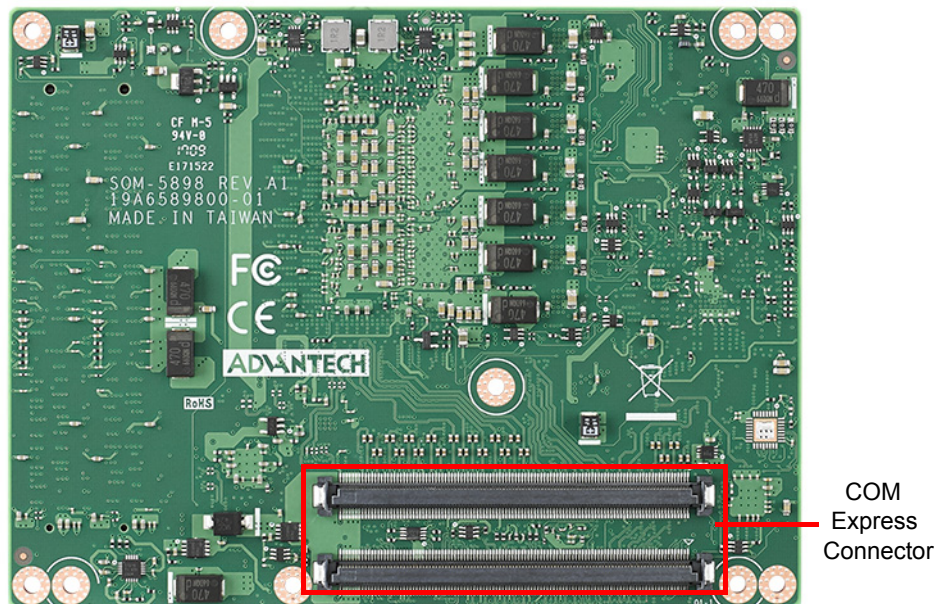
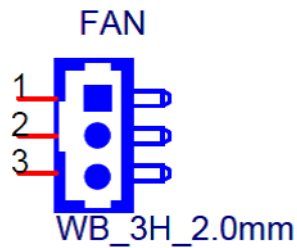

Figure 2.2 Board chips identify – Rear

2.1.1 Connector List

Table 2.1: FAN1 Fan

FAN1	Fan
Description	Wafer 2.0mm 3P 90D(M)DIP 2001-WR-03-LF W/Lock
Pin	Pin Name
1	Fan Tacho-Input
2	Fan Out
3	GND



2.2 Mechanical Drawing

For more detail about 2D/3D models, please find on Advantech COM support service website <http://com.advantech.com>.

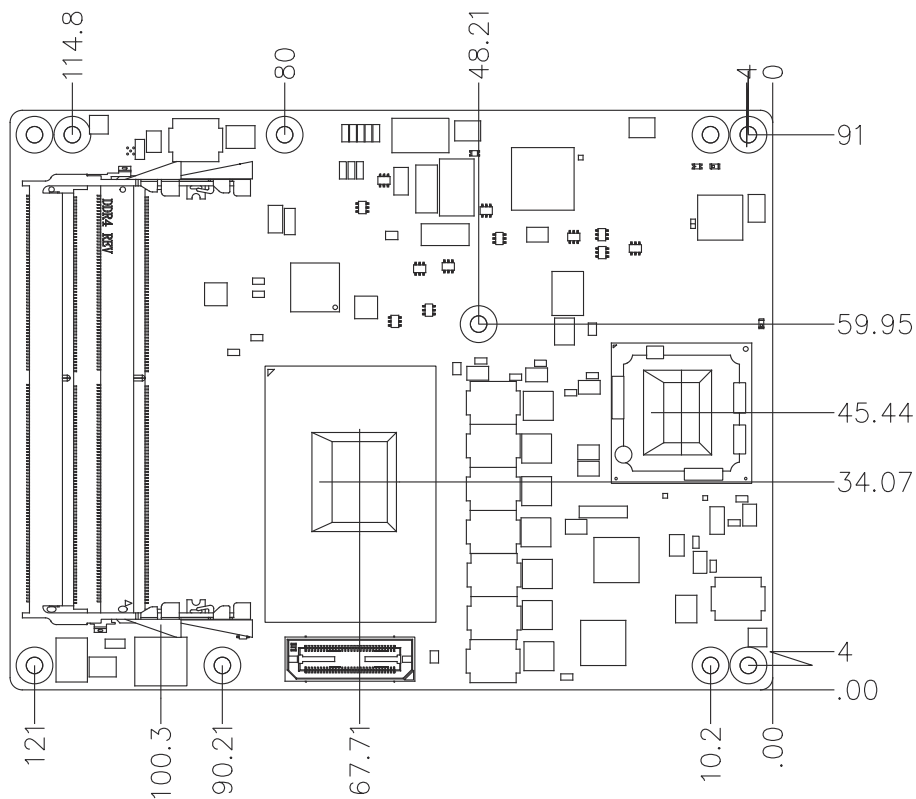

Figure 2.3 Board Mechanical Drawing – Front

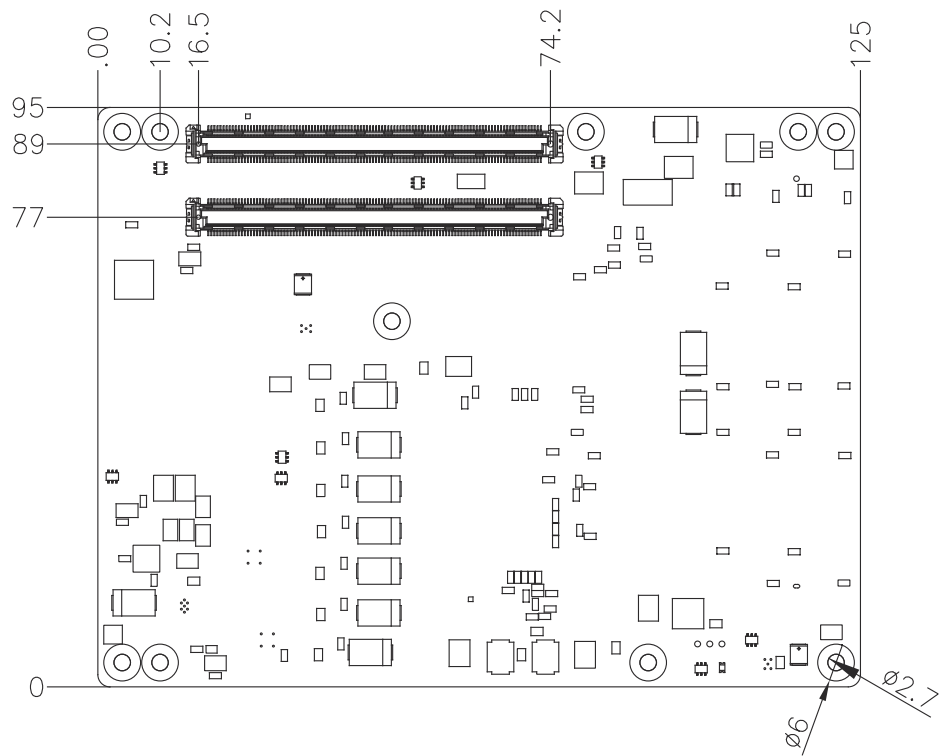

Figure 2.4 Board Mechanical Drawing – Rear

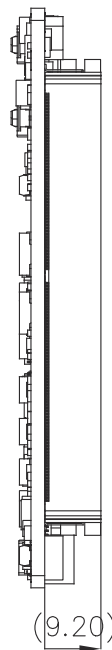

Figure 2.5 Board Mechanical Drawing – Side

2.3 Assembly Drawing

These figures demonstrate the assembly order from thermal module, COM module to carrier board.

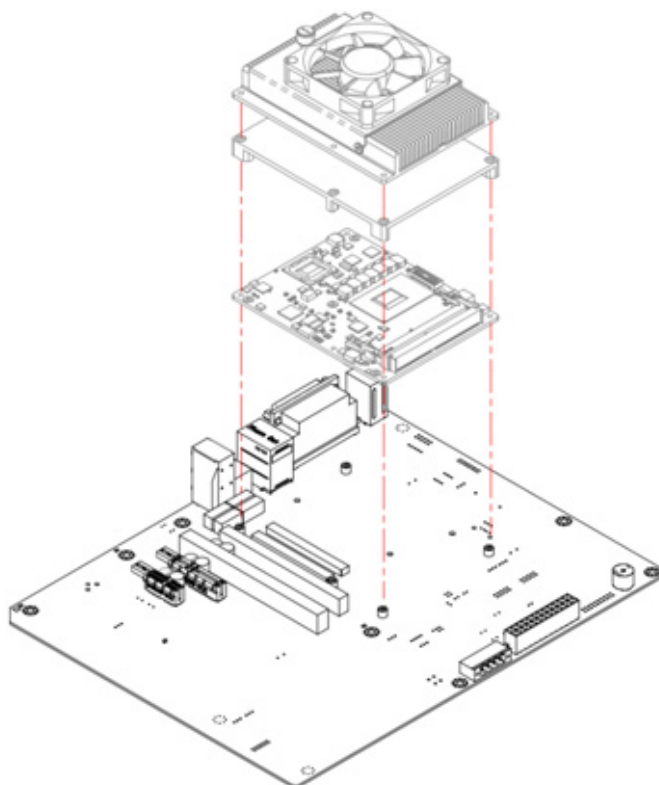

Figure 2.6 Assembly Drawing

There are 4 reserved screw holes for SOM-5898 to be pre-assembled with a heat spreader.

2.4 Assembly Drawing

Please consider the CPU and chip height tolerance when designing your thermal solution.

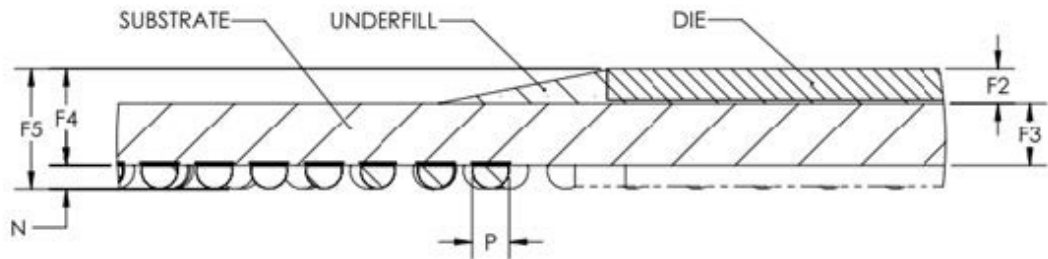

Figure 2.7 CPU 4C+2 Height and Tolerance

(For all other SKUs please contact Advantech sales or FAE for more details)

F5	1.45	± 0.1	PRE SMT PACKAGE HEIGHT
	1.395	± 0.09	POST SMT TOTAL STACKUP HEIGHT BASED ON LIMITED DATA FROM INTEL REFERENCE BOARD DESIGN

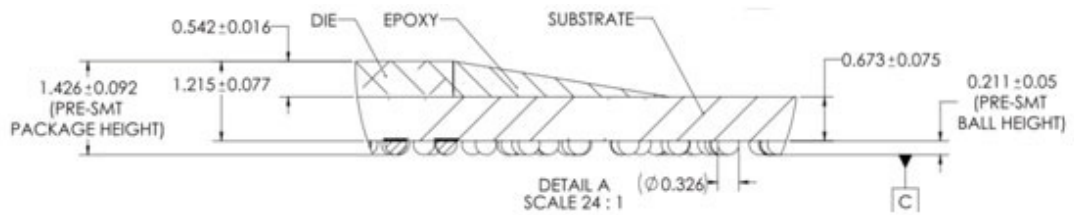

Figure 2.8 PCH Height and Tolerance

Chapter 3

BIOS Operation

This chapter gives BIOS setup information for the SOM-5898 CPU computer-on module.

Sections include:

- Introduction
- Entering Setup

3.1 Introduction

AMI BIOS has been integrated into many motherboards for over a decade. With the AMI BIOS Setup Utility, users can modify BIOS settings and control various system features. This chapter describes the basic navigation of the BIOS Setup Utility.



Figure 3.1 Setup program initial screen

AMI's BIOS ROM has a built-in Setup program that allows users to modify the basic system configuration. This information is stored in flash ROM so it retains the Setup information when the power is turned off.

3.2 Entering Setup

Turn on the computer and then press or <ESC> to enter Setup menu.

3.2.1 Main Setup

When users first enter the BIOS Setup Utility, users will enter the Main setup screen. Users can always return to the Main setup screen by selecting the Main tab. There are two Main Setup options. They are described in this section. The Main BIOS Setup screen is shown below.



Figure 3.2 Main setup screen

The Main BIOS setup screen has two main frames. The left frame displays all the options that can be configured. Grayed-out options cannot be configured; options in blue can. The right frame displays the key legend.

Above the key legend is an area reserved for a text message. When an option is selected in the left frame, it is highlighted in white. Often a text message will accompany it.

■ System time / System date

Use this option to change the system time and date. Highlight System Time or System Date using the <Arrow> keys. Enter new values through the keyboard. Press the <Tab> key or the <Arrow> keys to move between fields. The date must be entered in MM/DD/YY format. The time must be entered in HH:MM:SS format.

3.2.2 Advanced BIOS Features Setup

Select the Advanced tab from the SOM-5898 setup screen to enter the Advanced BIOS Setup screen. Users can select any item in the left frame of the screen, such as CPU Configuration, to go to the sub menu for that item. Users can display an Advanced BIOS Setup option by highlighting it using the <Arrow> keys. All Advanced BIOS Setup options are described in this section. The Advanced BIOS Setup screens are shown below. The sub menus are described on the following pages.

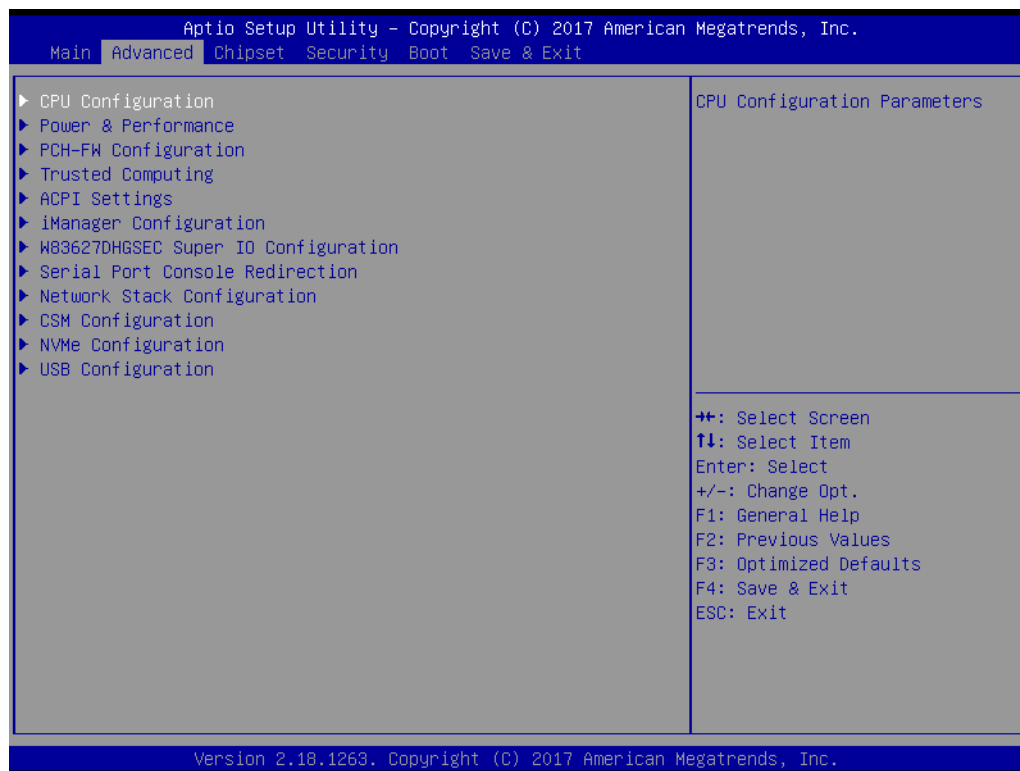

Figure 3.3 Advanced BIOS features setup screen

- **CPU Configuration**
CPU Configuration Parameters.
- **Power & Performance**
Power & Performance Options.
- **PCH-FW Configuration**
Configure Management Engine Technology Parameters.
- **Trusted Computing**
Trusted Computing Settings.
- **ACPI Settings**
System ACPI Parameters.
- **iManager Configuration**
iManager Parameters.
- **W83627DHGSEC Super IO Configuration**
System Super IO Chip Parameters.
- **Serial Port Console Redirection**
Serial Port Console Redirection.
- **Network Stack Configuration**
Network Stack Settings.

- **CSM Configuration**
CSM configuration: Enables or disables, Option ROM execution settings, etc.
- **NVMe Configuration**
NVMe Device Options Settings.
- **USB Configuration**
USB Configuration Parameters.

3.2.2.1 CPU Configuration



Figure 3.4 CPU Configuration

- **Intel (VMX) Virtualization Technology**
When enabled, a VMM can utilize the additional hardware capabilities provided by Vanderpool Technology.
- **Active Processor Cores**
Number of cores to enable in each processor package.
- **Hyper-Threading**
Enabled for Windows XP and Linux (OS optimized for Hyper-Threading Technology) and Disabled for other OS (OS not optimized for Hyper-Threading Technology).
- **AES**
Enables or disables AES (Advanced Encryption Standard).

3.2.2.2 Power & Performance

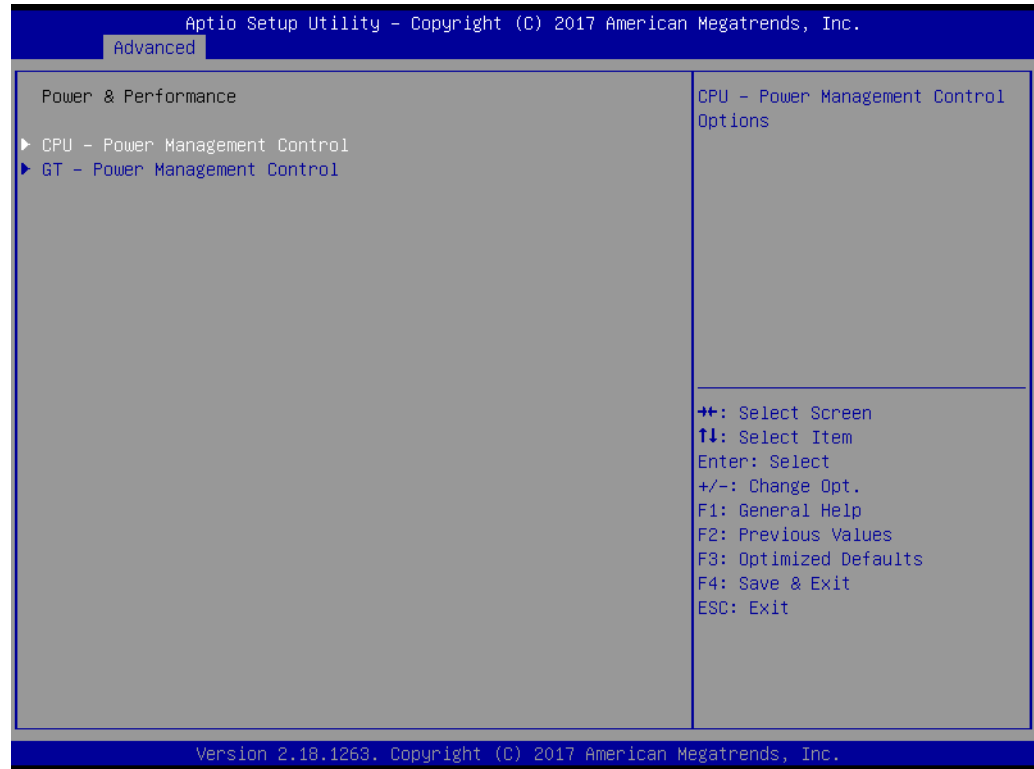

Figure 3.5 CPU - Power Management Control

- **CPU - Power Management Control**
CPU - Power Management Control Options.
- **GT - Power Management Control**
GT - Power Management Control Options.

CPU - Power Management Control



Figure 3.6 CPU - Power Management Control

- **Boot performance mode**
Selects the performance state that the BIOS will set starting from reset vector.
- **Intel(R) SpeedStep(tm)**
Allows more than two frequency ranges to be supported.
- **Turbo Mode**
Enables or disables processor Turbo Mode (requires EMTTM enabled too).
AUTO means enabled, unless max turbo ratio is bigger than 16 - SKL A0 W/A.

GT - Power Management Control

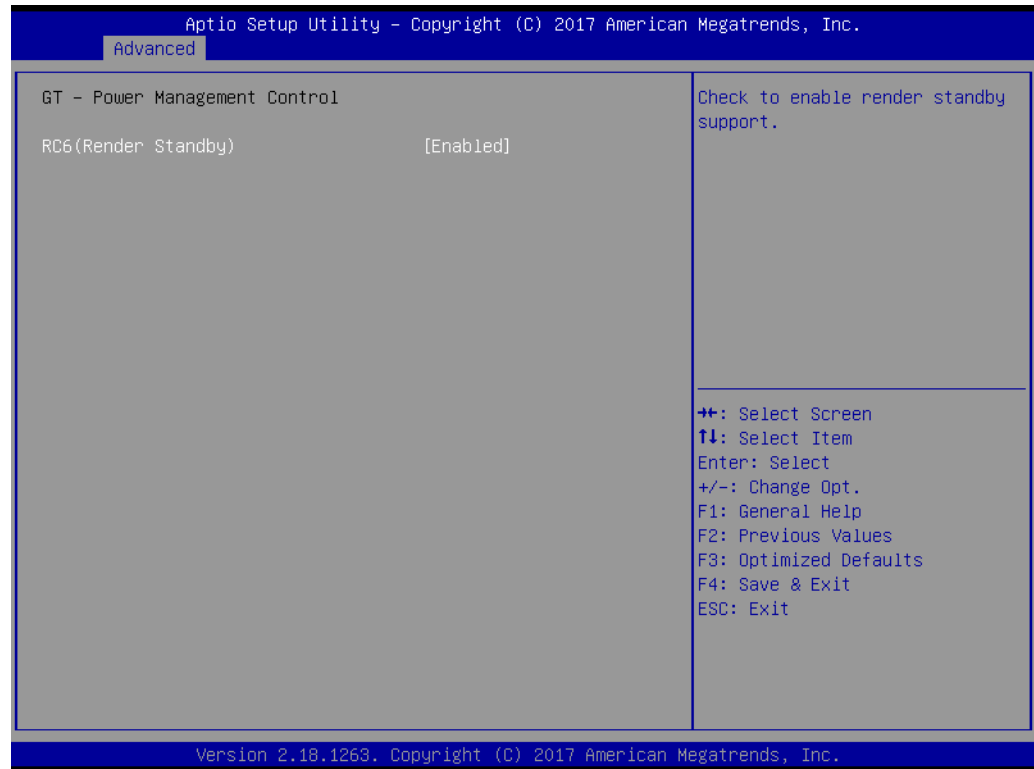

Figure 3.7 GT - Power Management Control

- **RC6 (Render Standby)**
Check to enable render standby support.

3.2.2.3 PCH-FW Configuration

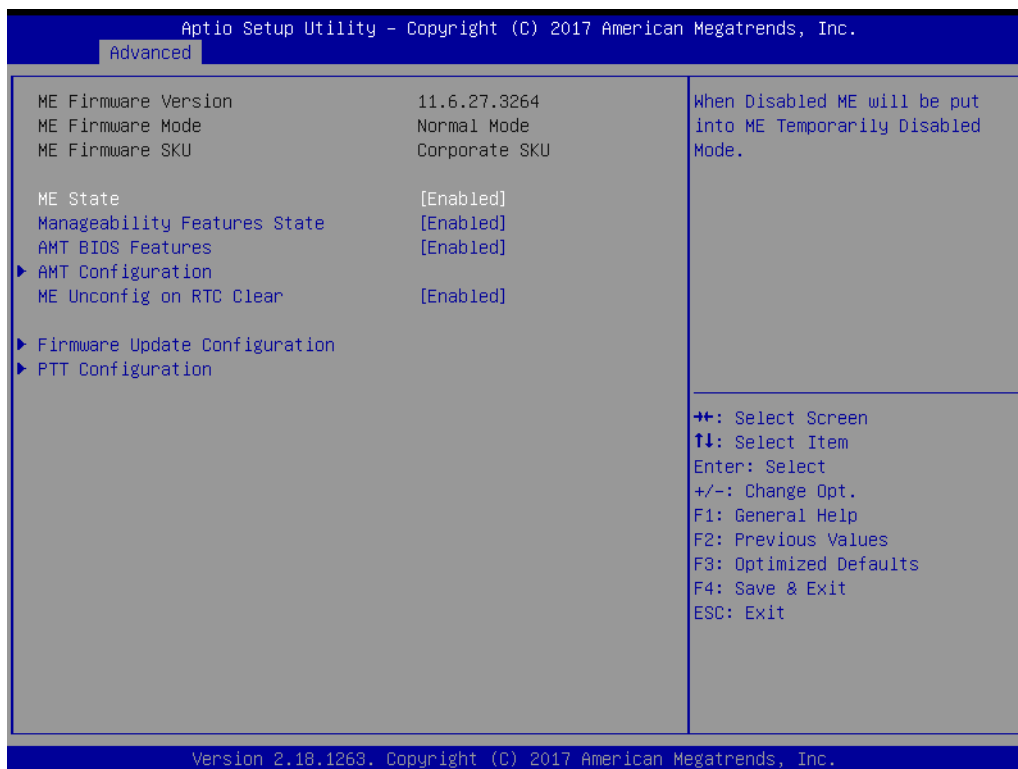

Figure 3.8 PCH-FW Configuration

- **PCH-FW Configuration**

When Disabled ME will be put into ME Temporarily Disabled Mode.

- **Manageability Features State**

Enables or disables Intel(R) Manageability features.

Note! *This option disables/enables Manageability Features support in FW.*



To disable support platform must be in an unprovisioned state first.

- **AMT BIOS Features**

When disabled AMT BIOS features are no longer supported and user is no longer able to access MEBx Setup.

Note! *This option does not disable manageability features in FW.*



- **AMT Configuration**

Configure Intel(R) Active Management Technology Parameters.

- **ME Unconfig on RTC Clear**

When Disabled ME will not be unconfigured on RTC Clear.

- **Firmware Update Configuration**

Configure Management Engine Technology Parameters.

- **PTT Configuration**

Configure PTT.

AMT Configuration



Figure 3.9 AMT Configuration

- **ASF support**
Enables or disables Alert Standard Format support.
- **USB Provisioning of AMT**
Enables or disables of AMT USB Provisioning.
- **CIRA Configuration**
Configure Remote Assistance Process parameters.
- **ASF Configuration**
Configure Alert Standard Format parameters.
- **Secure Erase Configuration**
Secure Erase Configuration menu.
- **OEM Flags Settings**
Configure OEM Flags.
- **MEBx Resolution Settings**
Resolution settings for MEBx display modes.

– CIRA Configuration

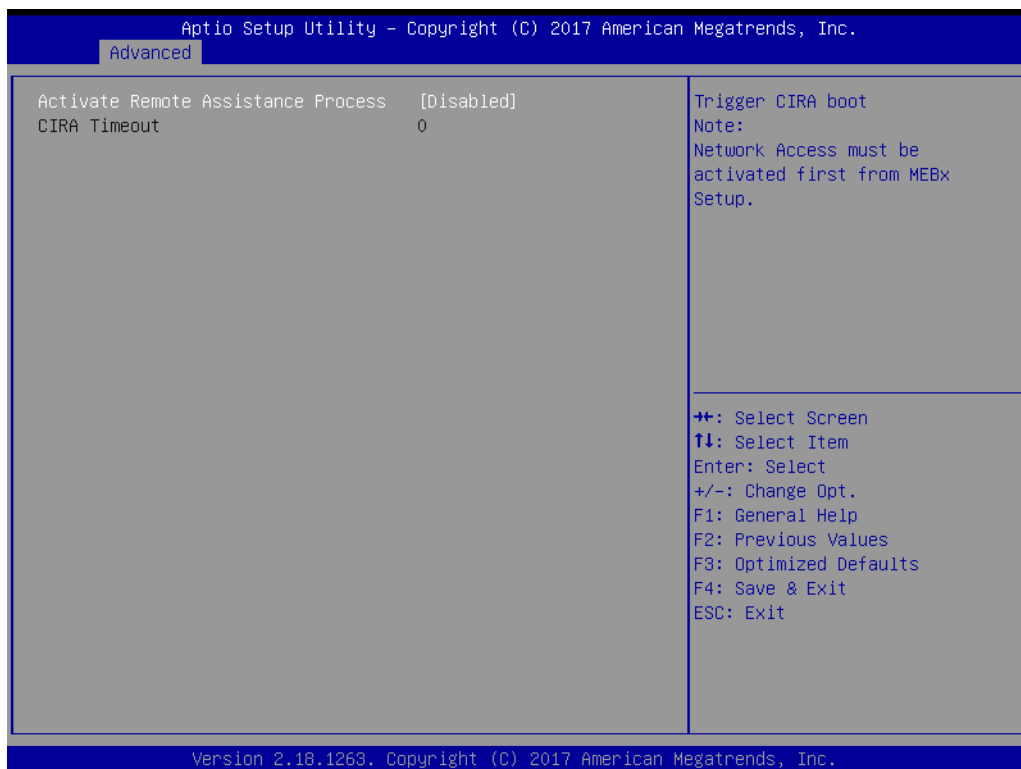

Figure 3.10 CIRA Configuration

- **Activate Remote Assistance Process**

Trigger CIRA boot.

Note! *Network Access must be activated first from MEBx Setup.*



- **CIRA Timeout**

OEM defined timeout for MPS connection to be established.

0 - use the default timeout value of 60 seconds.

255 - MEBx waits until the connection succeeds.

– ASF Configuration

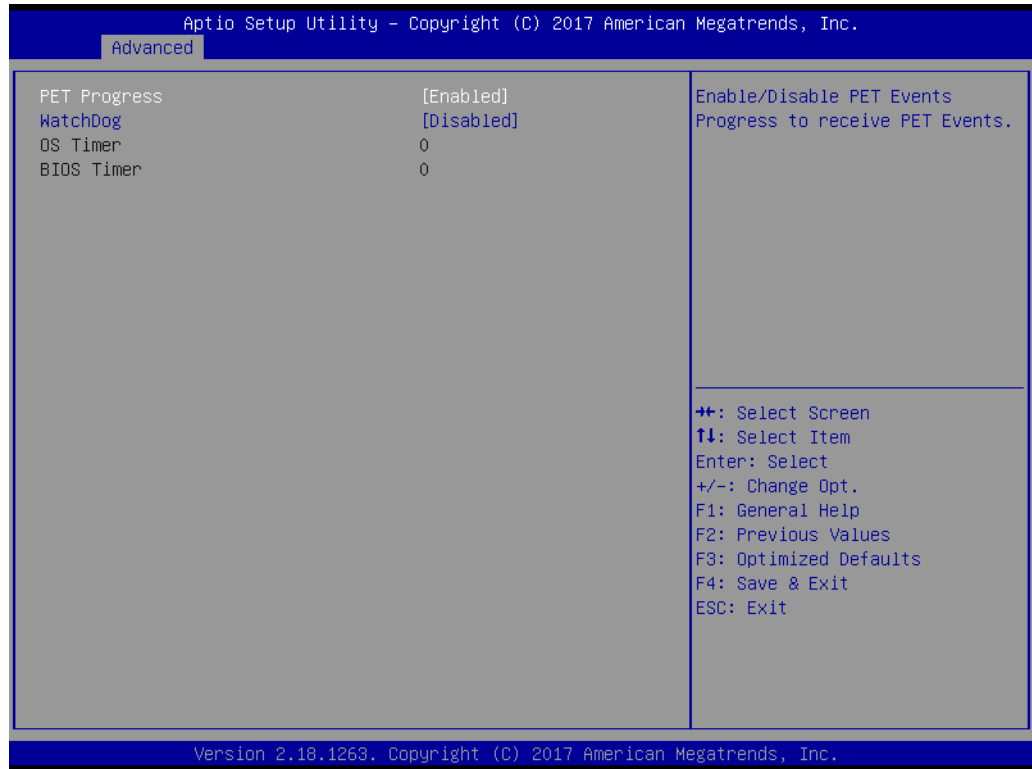

Figure 3.11 ASF Configuration

- **Hardware Monitor Information**
This item shows Hardware information parameters.

– Secure Erase Configuration

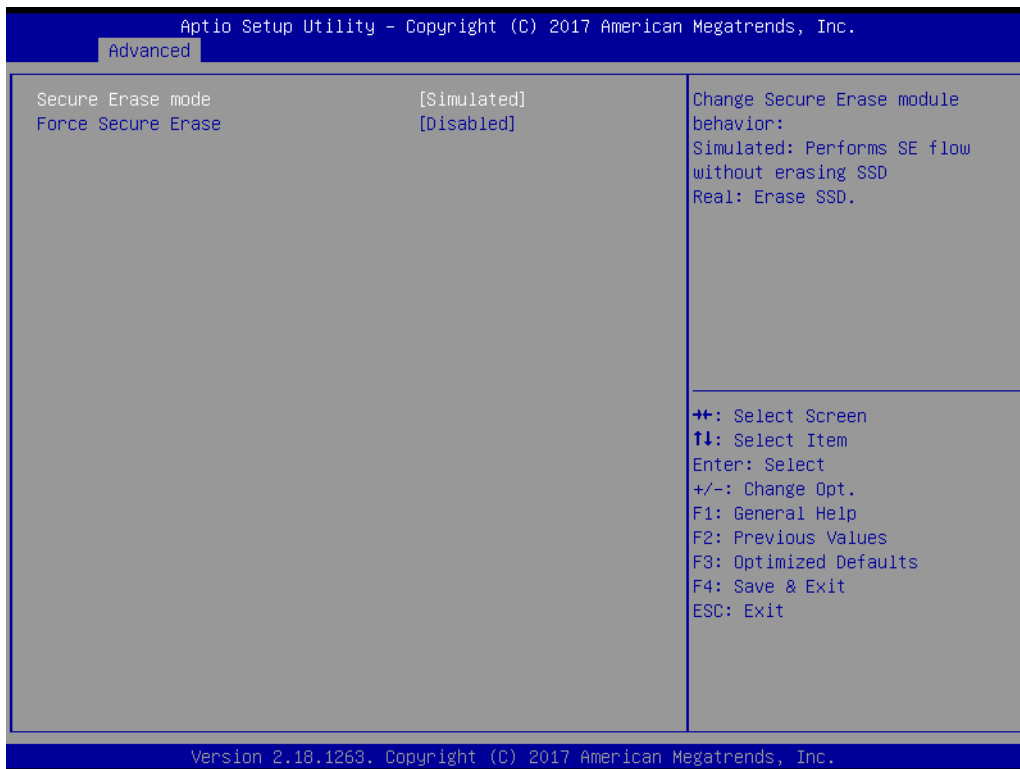

Figure 3.12 Secure Erase Configuration

- **Secure Erase mode**
Change Secure Erase module behavior:
 - Simulated: Performs SE flow without erasing SSD
 - Real: Erase SSD.
- **Force Secure Erase**
Force Secure Erase on next boot.

– OEM Flag Settings

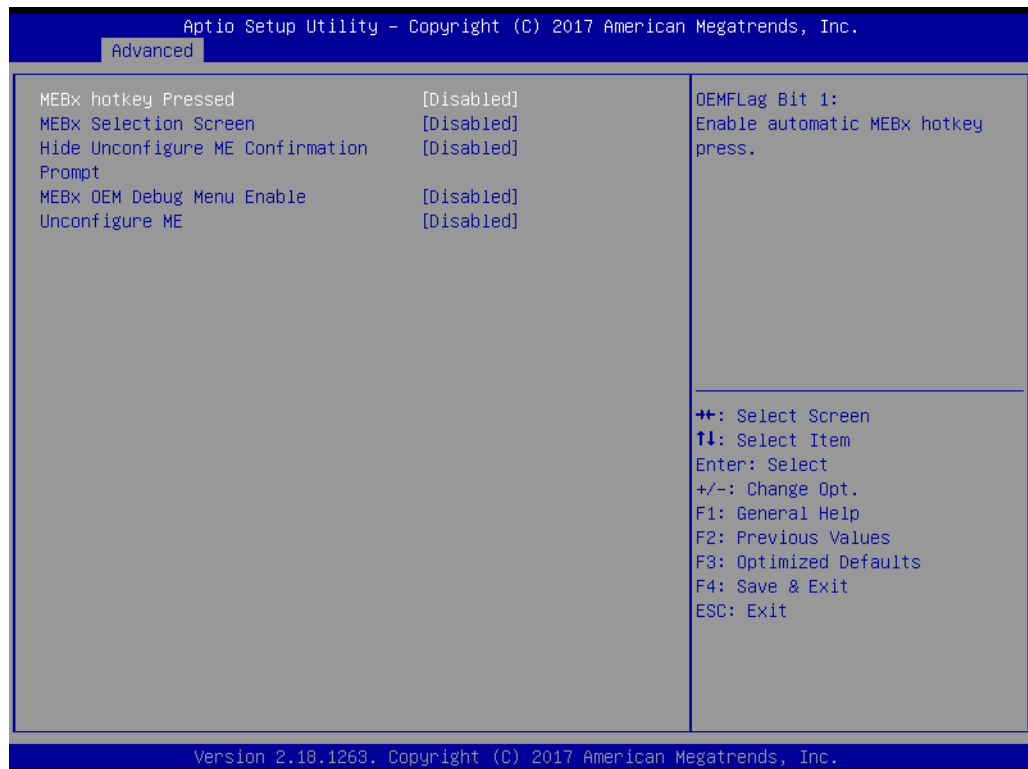

Figure 3.13 OEM Flag Settings

- **MEBx hotkey Pressed**
OEMFLag Bit 1: Enable automatic MEBx hotkey press.
- **MEBx Selection Screen**
OEMFLag Bit 2: Enable MEBx selection screen with 2 options:
 - Press 1 to enter ME Configuration Screens
 - Press 2 to initiate a remote connection

Note! *Network Access must be activated from MEBx Setup for this screen to be displayed.*



- **Hide Unconfigure ME Confirmation Prompt**
OEMFLag Bit 6: Hide Unconfigure ME confirmation prompt when attempting ME unconfiguration.
- **MEBx OEM Debug Menu Enable**
OEMFLag Bit 14: Enable OEM debug menu in MEBx.
- **Unconfigure ME**
OEMFLag Bit 15: Unconfigure ME with resetting MEBx password to default.

– MEBx Resolution Settings

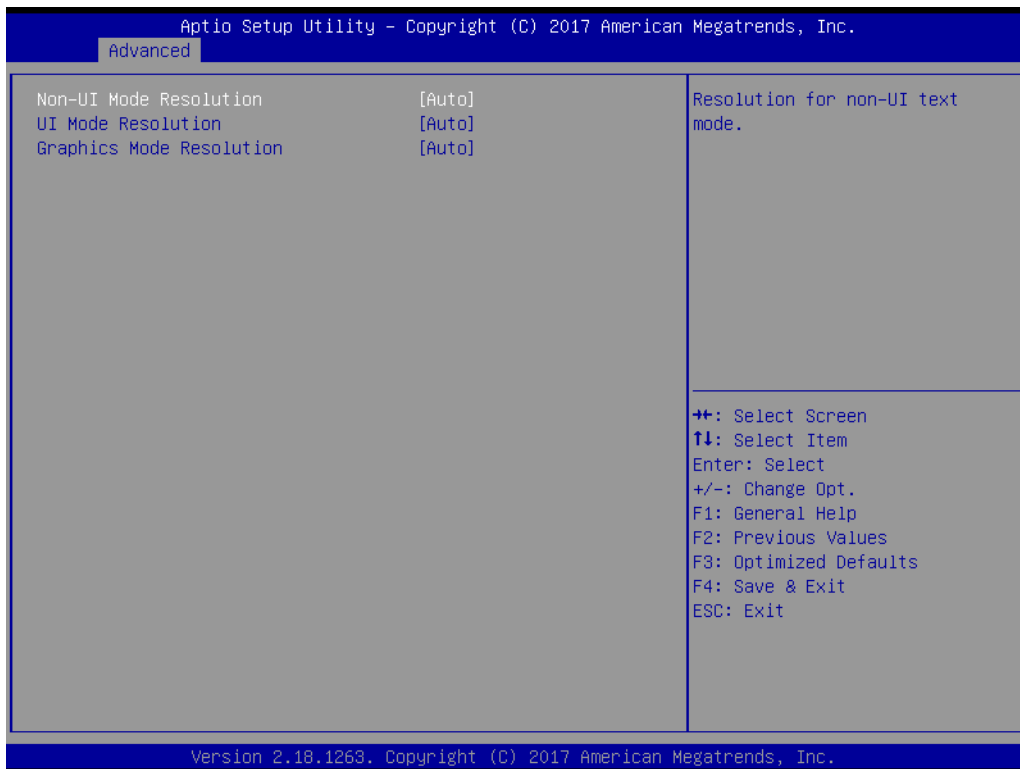

Figure 3.14 MEBx Resolution Settings

- **Non-UI Mode Resolution**
Resolution for non-UI text mode.
- **UI Mode Resolution**
Resolution for UI text mode.
- **Graphics Mode Resolution**
Resolution for graphics mode.

Firmware Update Configuration

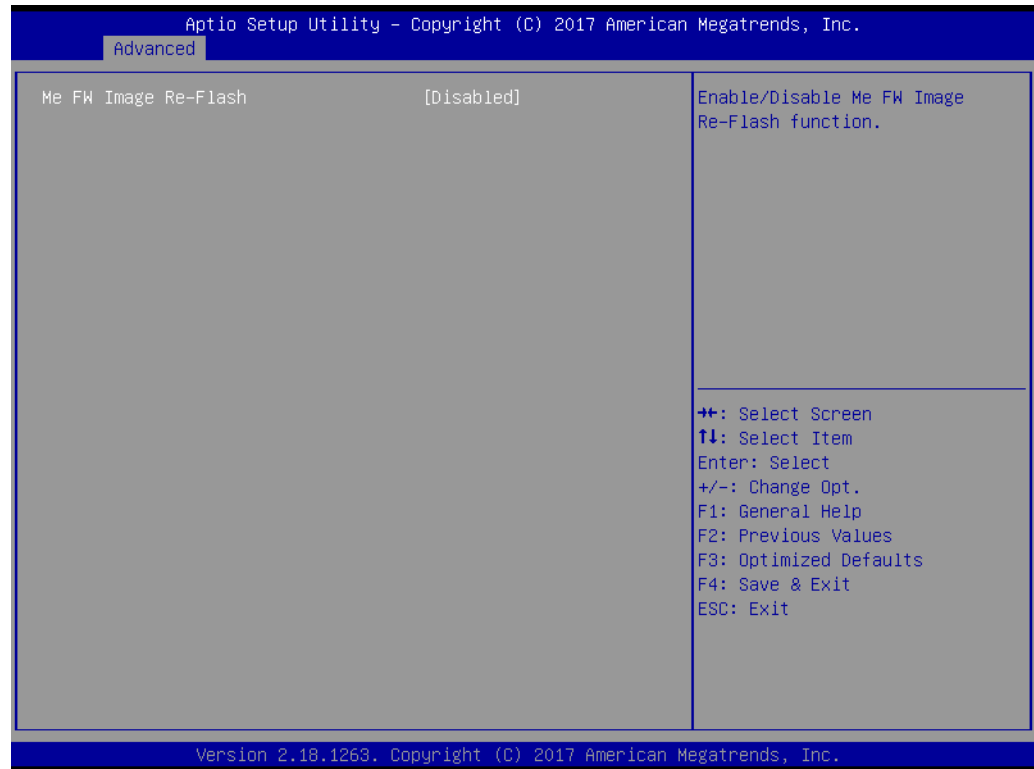

Figure 3.15 Firmware Update Configuration

- **Me FW Image Re-Flash**
Enables or disables Me FW Image Re-Flash function.

PTT Configuration

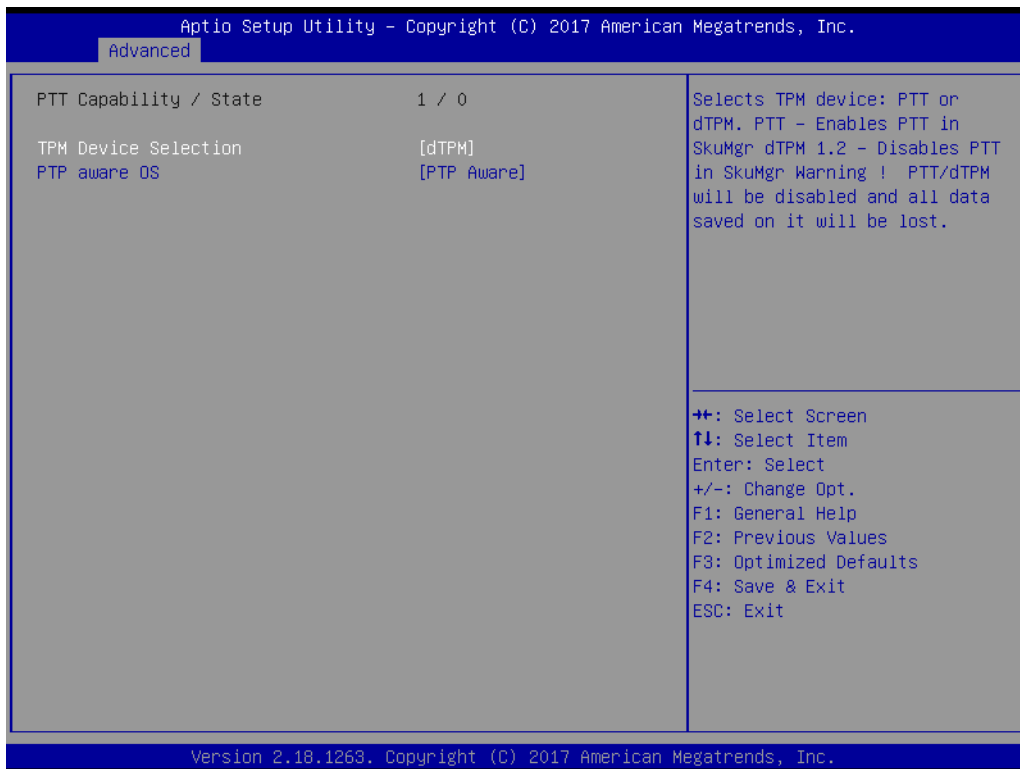

Figure 3.16 PTT Configuration

- **TPM Device Selection**
 Selects TPM device: PTT or dTPM.
 PTT - Enables PTT in SkuMgr dTPM 1.2 - Disables PTT in SkuMgr Warning!
 PTT/dTPM will be disabled and all data saved on it will be lost.
- **PTP aware OS**
 Select whether or not the OS you will boot to will be PTP aware.

3.2.2.4 Trusted Computing

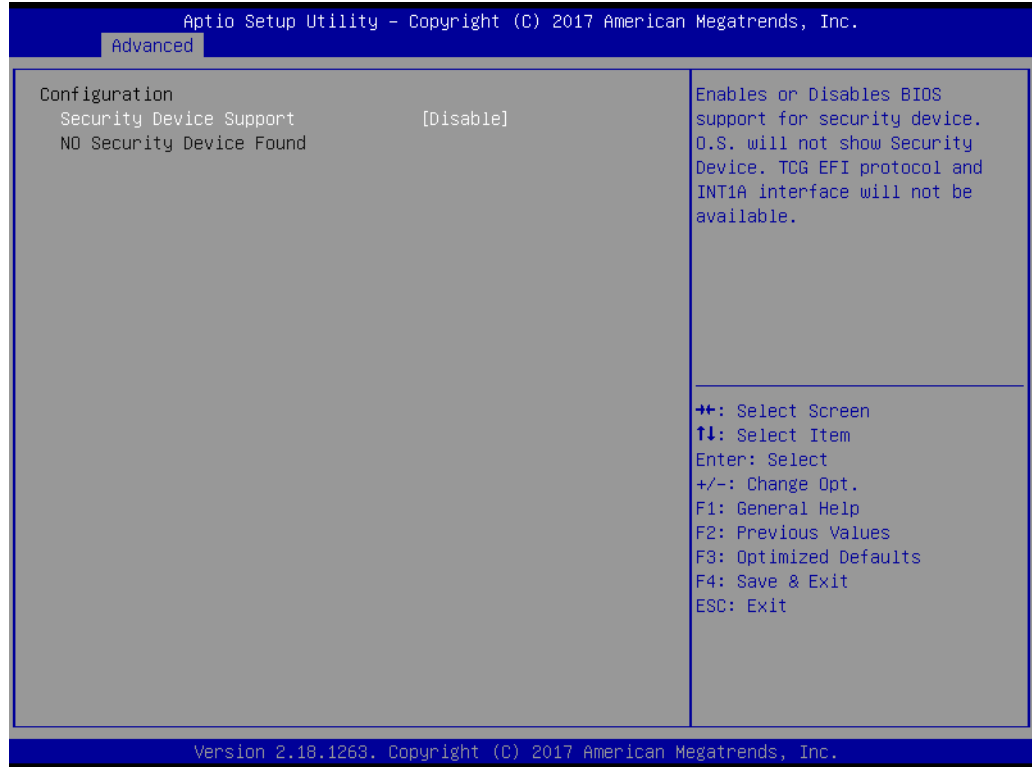

Figure 3.17 Trusted Computing

- **Security Device Support**
Enables or disables BIOS support for security device. OS will not show Security Device. TCG EFI protocol and INT1A interface will not be available.

3.2.2.5 ACPI Settings

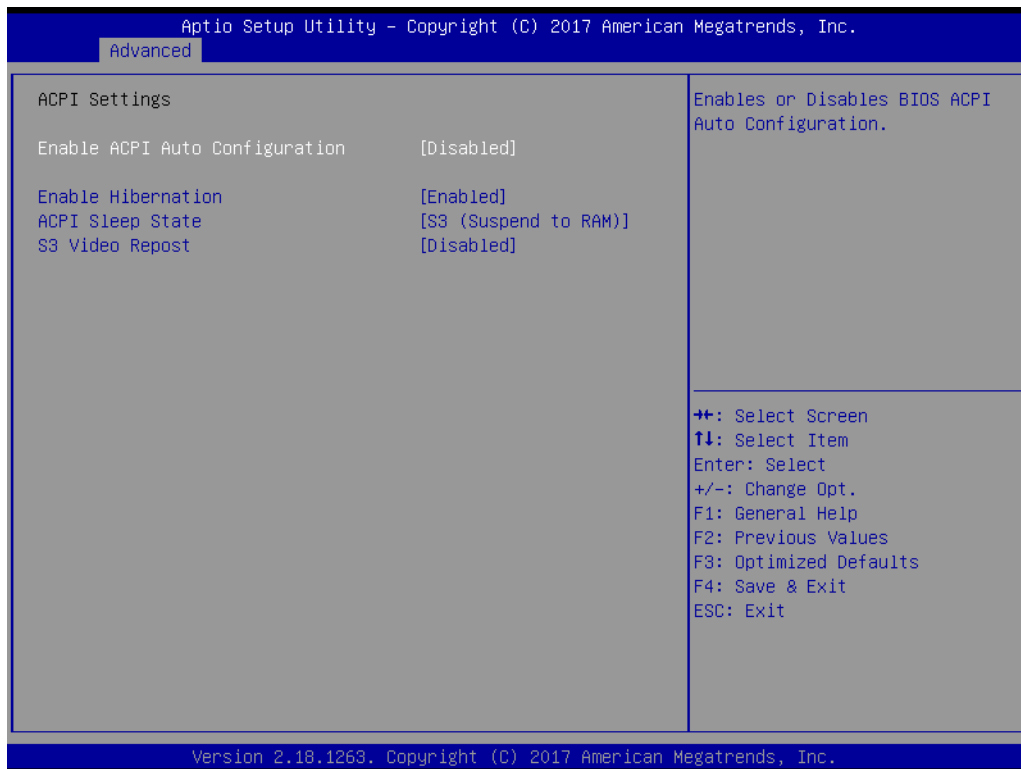

Figure 3.18 ACPI Settings

- **Enable ACPI Auto Configuration**
Enables or disables BIOS ACPI Auto Configuration.
- **Enable Hibernation**
Enables or disables system ability to hibernate (OS/S4 Sleep State). This option may be not effective with some operating systems.
- **ACPI Sleep State**
Selects the highest ACPI sleep state the system will enter when the SUSPEND button is pressed.
- **S3 Video Repost**
Enable or Disable S3 Video Repost.

3.2.2.6 iManager Configuration

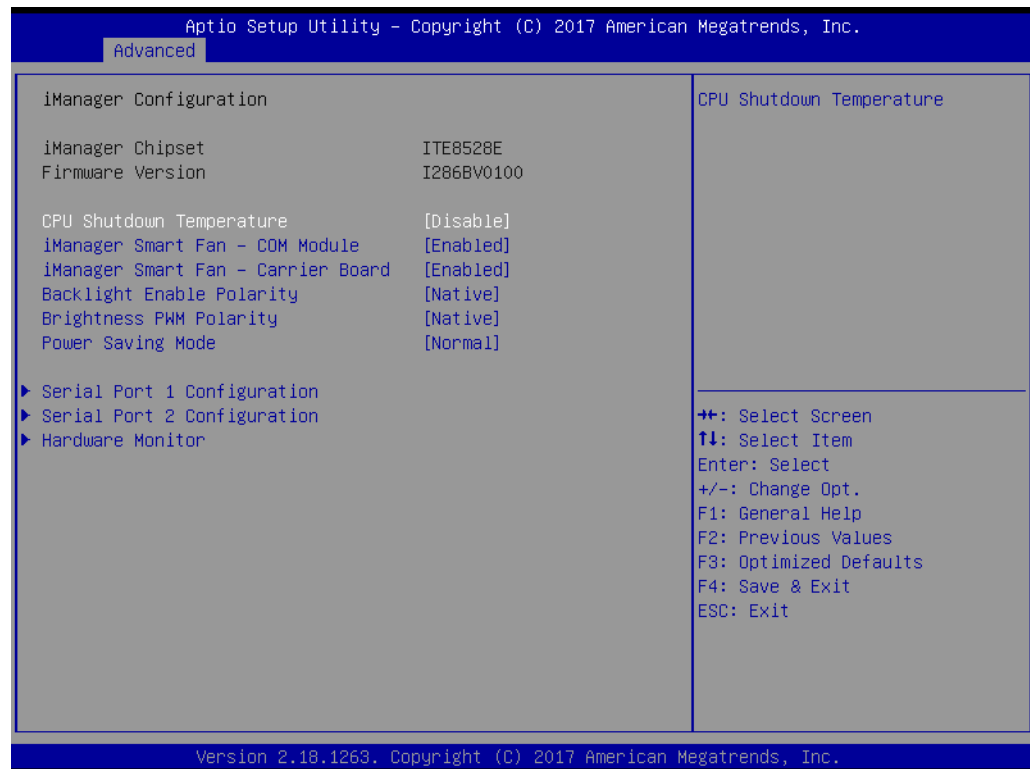

Figure 3.19 iManager Configuration

- **CPU Shutdown Temperature**
Enables or disables CPU Shutdown Temperature.
- **iManager Smart Fan - COM Module**
Control iManager Smart FAN function.
- **iManager Smart Fan - Carrier Board**
Control iManager Smart FAN Carrier Board function.
- **Backlight Enable Polarity**
Switch Backlight Enable Polarity for Native or Invert
- **Brightness PWM Polarity**
Backlight Control Brightness PWM Polarity for Native or Invert
- **Power Saving Mode**
Select ITE8518 Power Saving Mode
- **Serial Port 1 Configuration**
Set Parameters of Serial Port 1 (COMA).
- **Serial Port 2 Configuration**
Set Parameters of Serial Port 2 (COMB).
- **Hardware Monitor**
Monitor hardware status.

Serial Port 1 Configuration

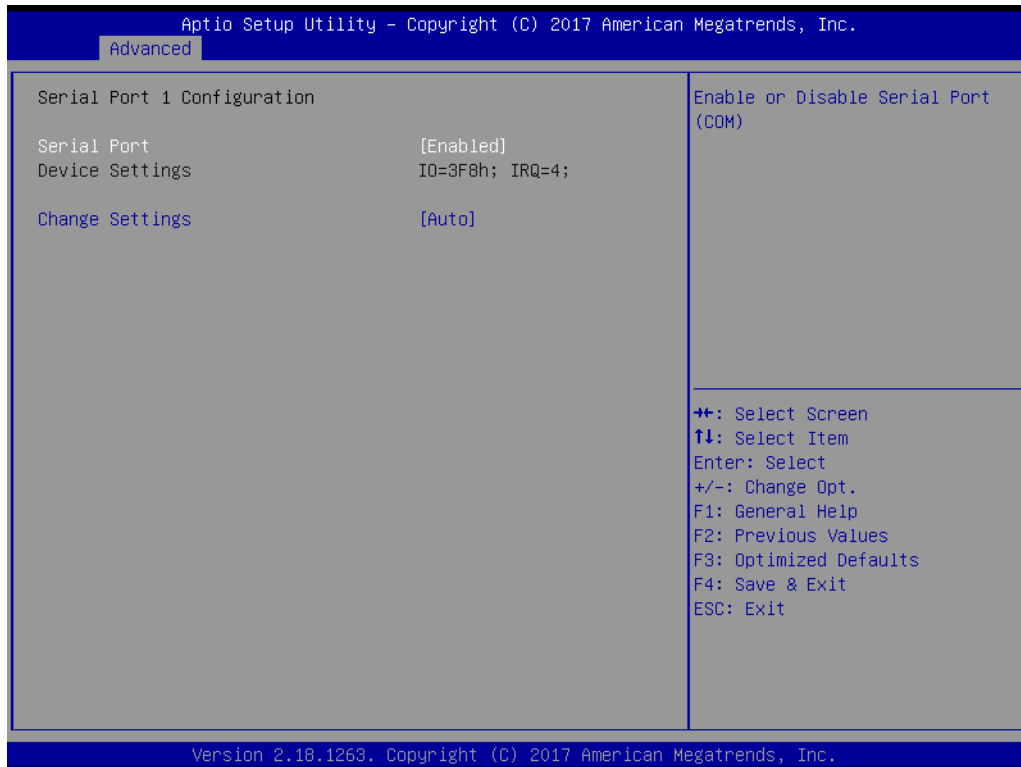

Figure 3.20 Serial Port 1 Configuration

- **Serial Port**
Enable or Disable Serial Port (COM).
- **Device Settings**
Set Parameters of Serial Port 1 (COMA).

Serial Port 2 Configuration



Figure 3.21 Serial Port 2 Configuration

- **Serial Port**
Enable or Disable Serial Port (COM).
- **Device Settings**
Set Parameters of Serial Port 2 (COMB).

Hardware Monitor

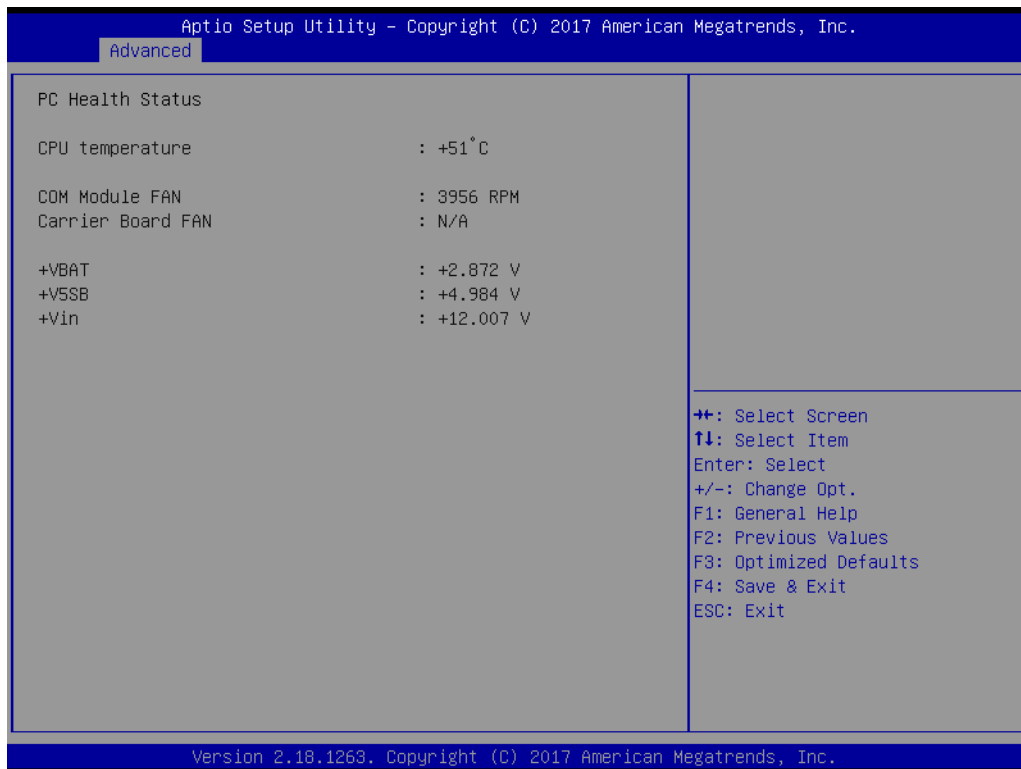

Figure 3.22 Hardware Monitor

3.2.2.7 W83627DHGSEC Super IO Configuration

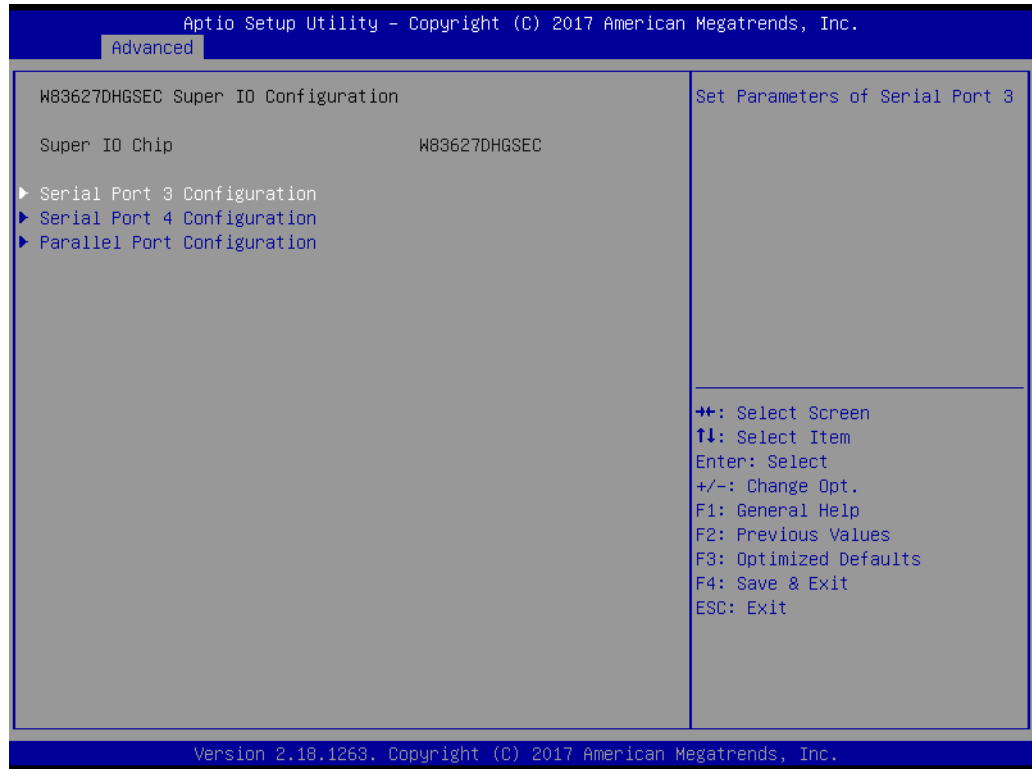

Figure 3.23 W83627DHGSEC Super IO Configuration

- **Serial Port 3 Configuration**
Set parameters of Serial Port 3.
- **Serial Port 4 Configuration**
Set parameters of Serial Port 4.
- **Parallel Port Configuration**
Set parameters of Parallel Port (LPT/LPTE).

Serial Port 3 Configuration

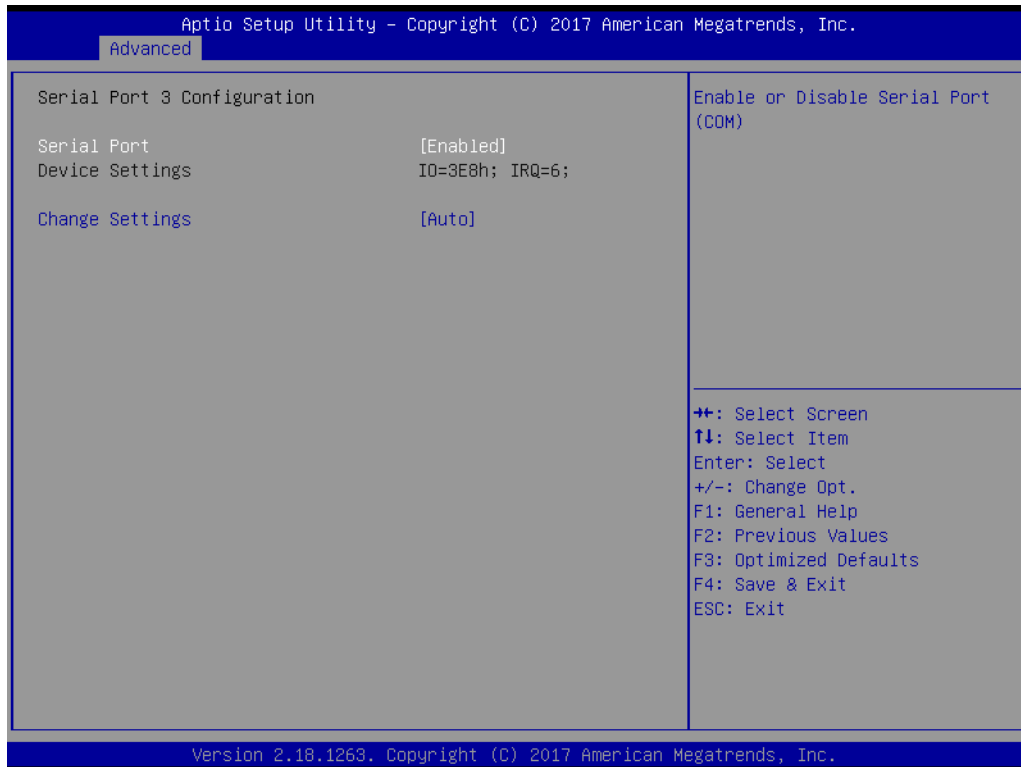

Figure 3.24 Serial Port 3 Configuration

- **Serial Port**
Enable or Disable Serial Port (COM).
- **Change Settings**
Select an optimal setting for Super IO device.

Serial Port 4 Configuration

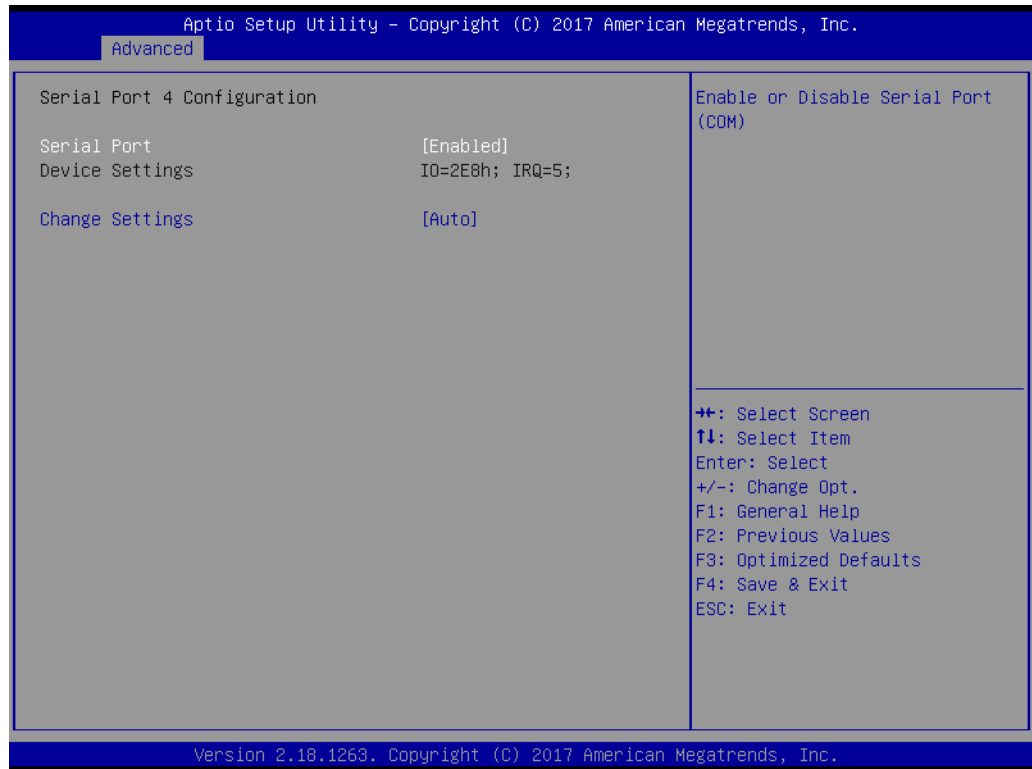

Figure 3.25 Serial Port 4 Configuration

- **Serial Port**
Enable or Disable Serial Port (COM).
- **Change Settings**
Select an optimal setting for Super IO device.

Parallel Port Configuration

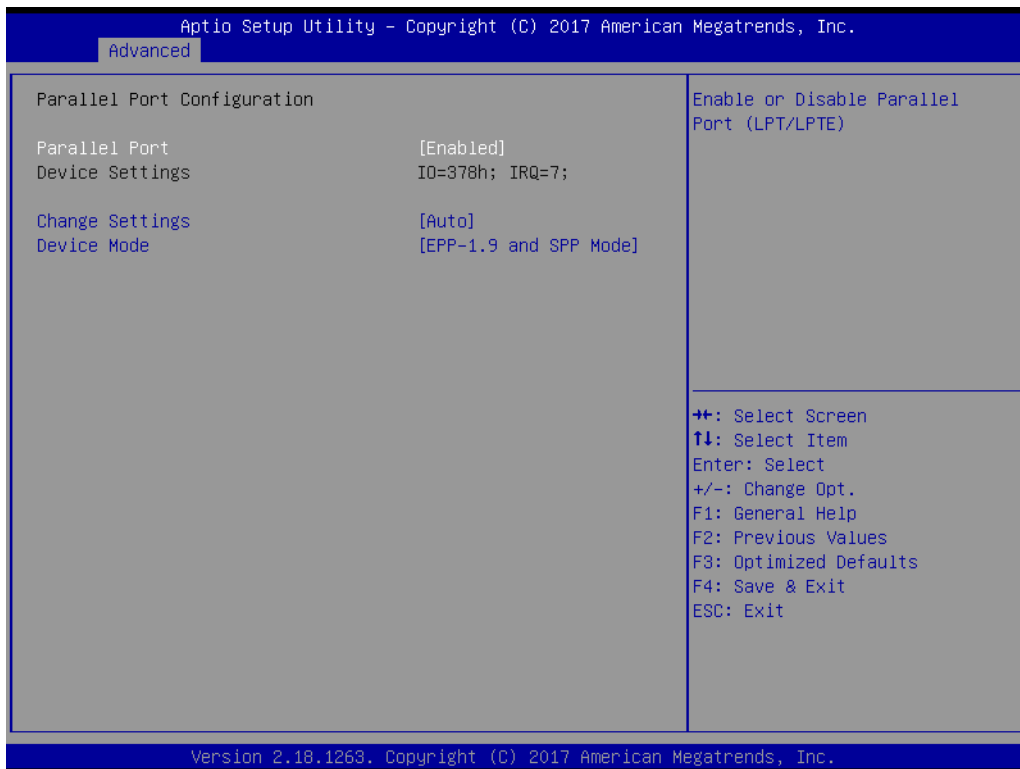

Figure 3.26 Parallel Port Configuration

- **Parallel Port**
Enable or Disable Parallel Port (LPT/LPTE).
- **Change Settings**
Select an optimal setting for Super IO device.
- **Device Mode**
Change the Printer Port mode.

3.2.2.8 Serial Port Console Redirection

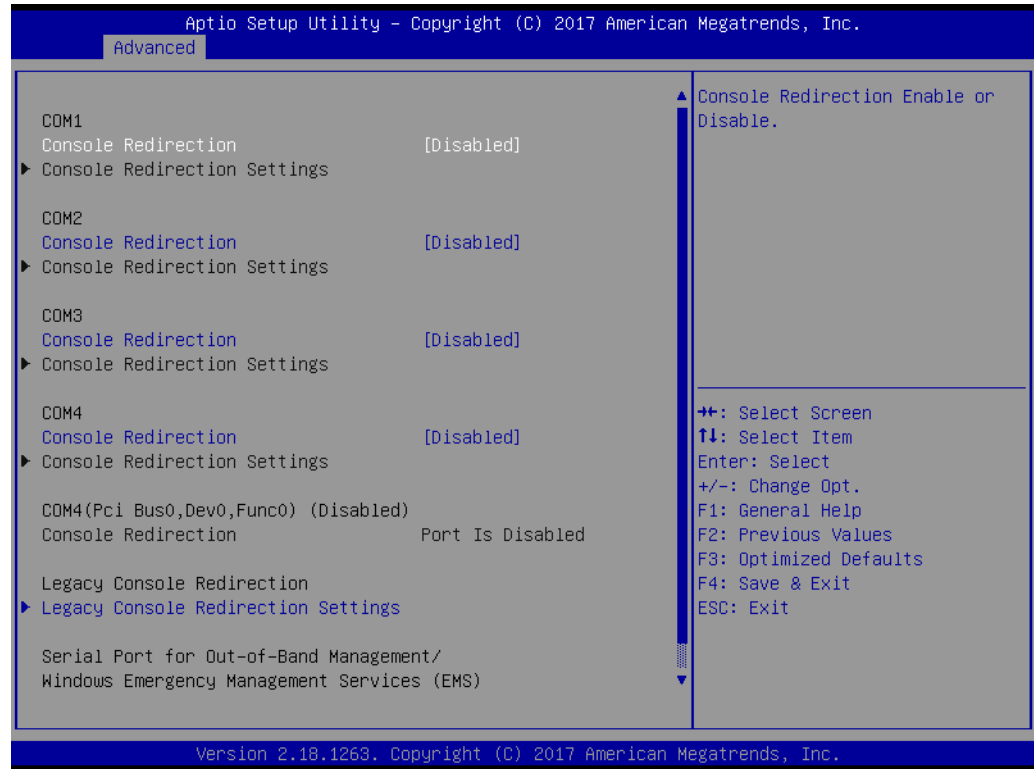

Figure 3.27 Serial Port Console Redirection

- **Console Redirection (COM1 ~ COM4)**
Console Redirection Enable or Disable.
- **Legacy Console Redirection Settings**
Legacy Console Redirection Settings.

Legacy Console Redirection Settings



Figure 3.28 Serial Port Console Redirection

- **Redirection COM Port**
Select a COM port to display redirection of Legacy OS and Legacy OPROM Messages.
- **Resolution**
On Legacy OS, the Number of Rows and Columns supported redirection.
- **Redirect After POST**
When Bootloader is selected, then Legacy Console Redirection is disabled before booting to legacy OS. When Always Enable is selected, then Legacy Console Redirection is enabled for legacy OS. Default setting for this option is set to Always Enable.

3.2.2.9 Network Stack Configuration

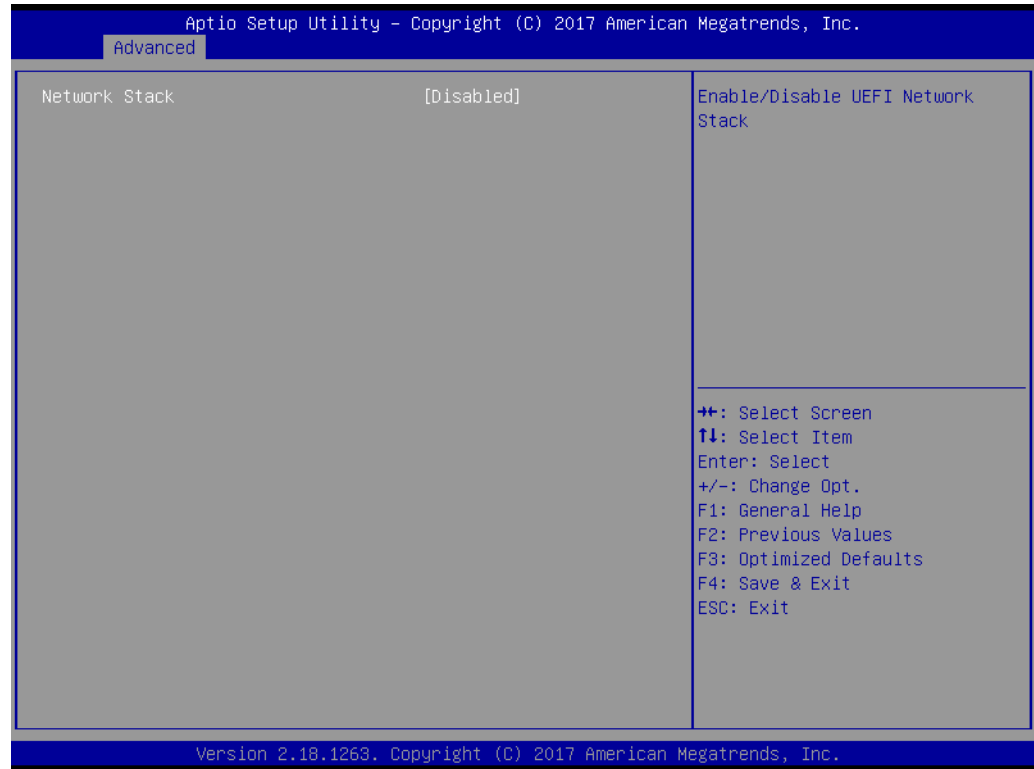

Figure 3.29 Network Stack Configuration

- **Network Stack**
Enables or disables UEFI Network Stack.

3.2.2.10 CSM Configuration

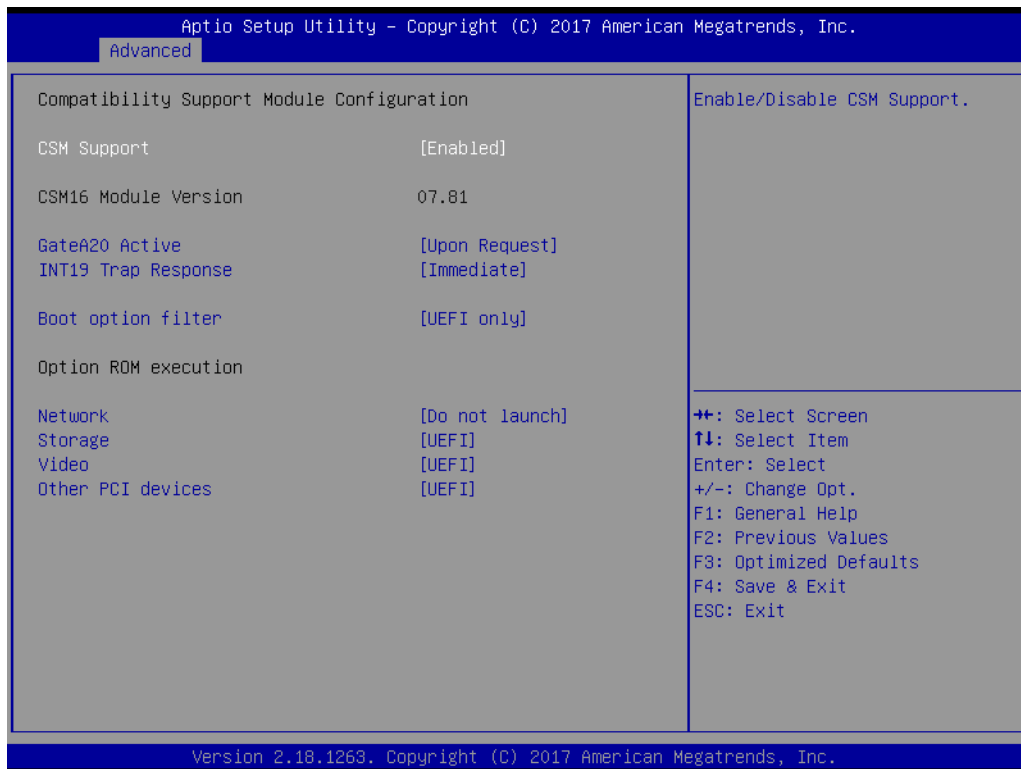

Figure 3.30 CSM Configuration

- **CSM Support**
Enables or disables CSM support.
- **GateA20 Active**
UPON REQUEST- GA20 can be disabled using BIOS services. Do not allow disabling of GA20; this option is useful when any RT code is executed above 1MB.
- **INT19 Trap Response**
BIOS reaction on INT19 trapping by Option ROM. IMMEDIATE- execute the trap right away; POSTPONED- execute the trap during legacy boot.
- **Boot option filter**
This option controls Legacy/UEFI ROMs priority.
- **Network**
Controls the execution of UEFI and Legacy PXE OpROM.
- **Storage**
Controls the execution of UEFI and Legacy Storage OpROM.
- **Video**
Controls the execution of UEFI and Legacy Video OpROM.
- **Other PCI devices**
Determines OpROM execution policy for devices other than network, storage, or video.

3.2.2.11 NVMe Configuration

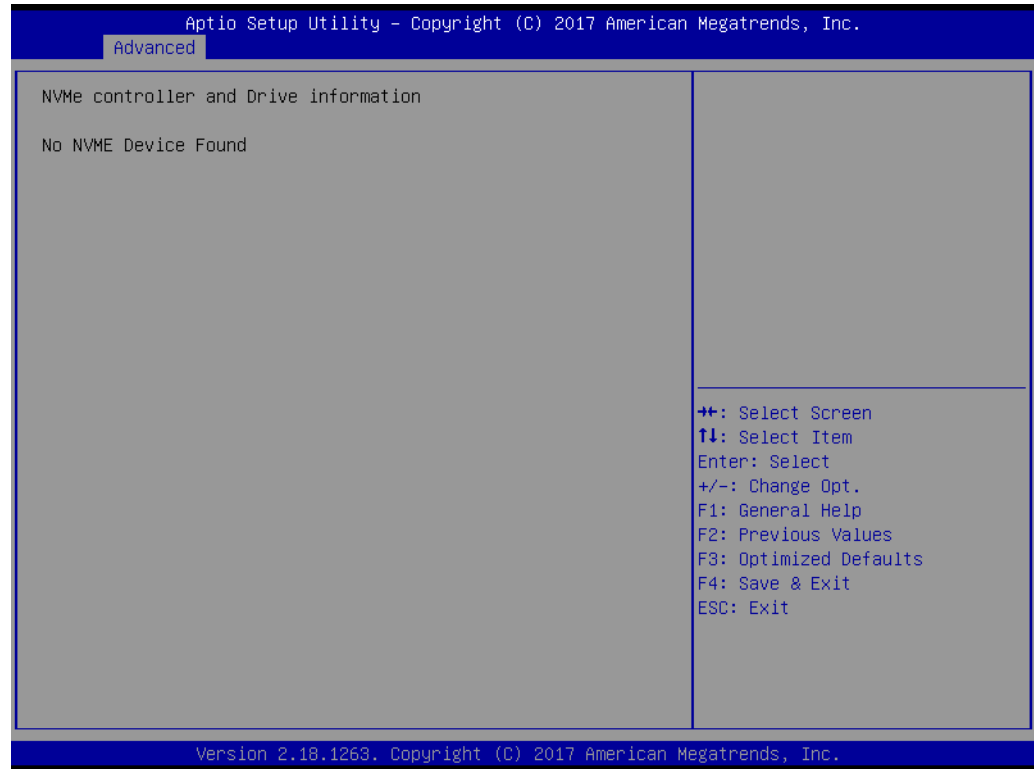

Figure 3.31 NVMe Configuration

3.2.2.12 USB Configuration

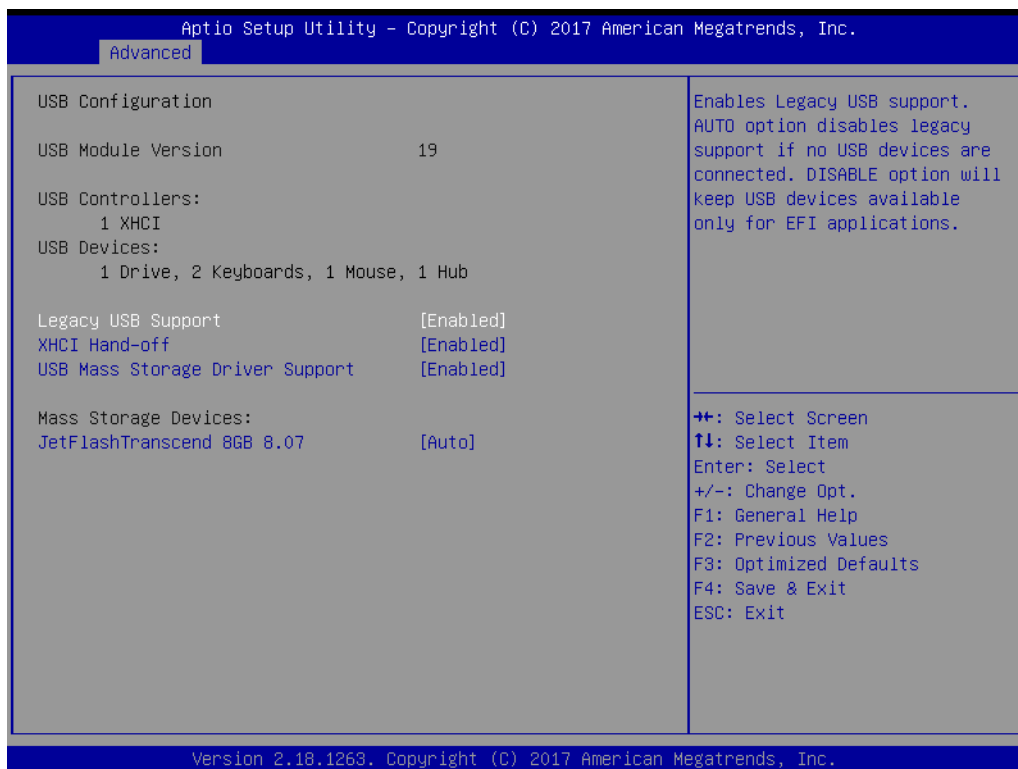

Figure 3.32 USB Configuration

- **Legacy USB Support**
Enables Legacy USB support. Auto option disables legacy support if no USB devices are connected. Disable option will keep USB devices available only for EFI applications.
- **XHCI Hand-off**
This is a workaround for OS without XHCI hand-off support. The XHCI ownership change should be claimed by XHCI driver.
- **USB Mass Storage Driver Support**
Enables or disables USB Mass Storage Driver Support.

3.2.3 Chipset Setup



Figure 3.33 Chipset Setup

- **System Agent (SA) Configuration**
System Agent (SA) parameters.
- **PCH-IO Configuration**
PCH parameters.

3.2.3.1 System Agent (SA) Configuration

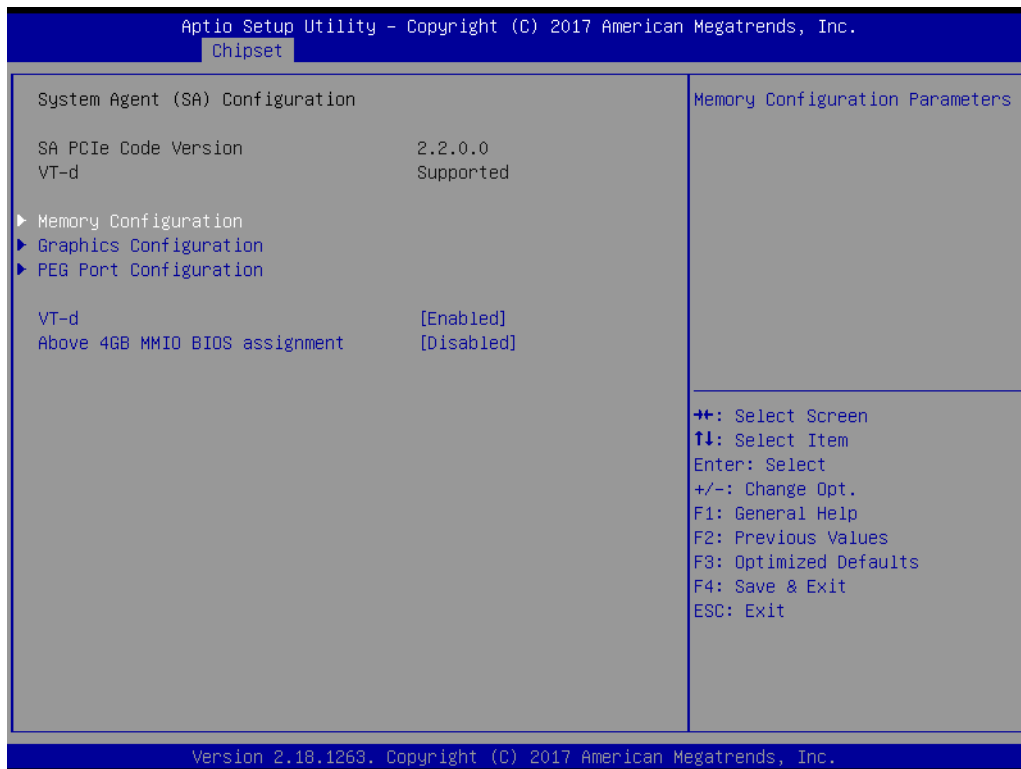

Figure 3.34 System Agent (SA) Configuration

- **Memory Configuration**
Memory Configuration parameters.
- **Graphics Configuration**
Graphics Configuration.
- **PEG Port Configuration**
PEG Port Options.
- **VT-d**
VT-d capability.
- **Above 4GB MMIO BIOS assignment**
Enables or disables above 4GB Memory Mapped IO BIOS assignment.
This is enabled automatically when aperture size is set to 2048MB.

Memory Configuration

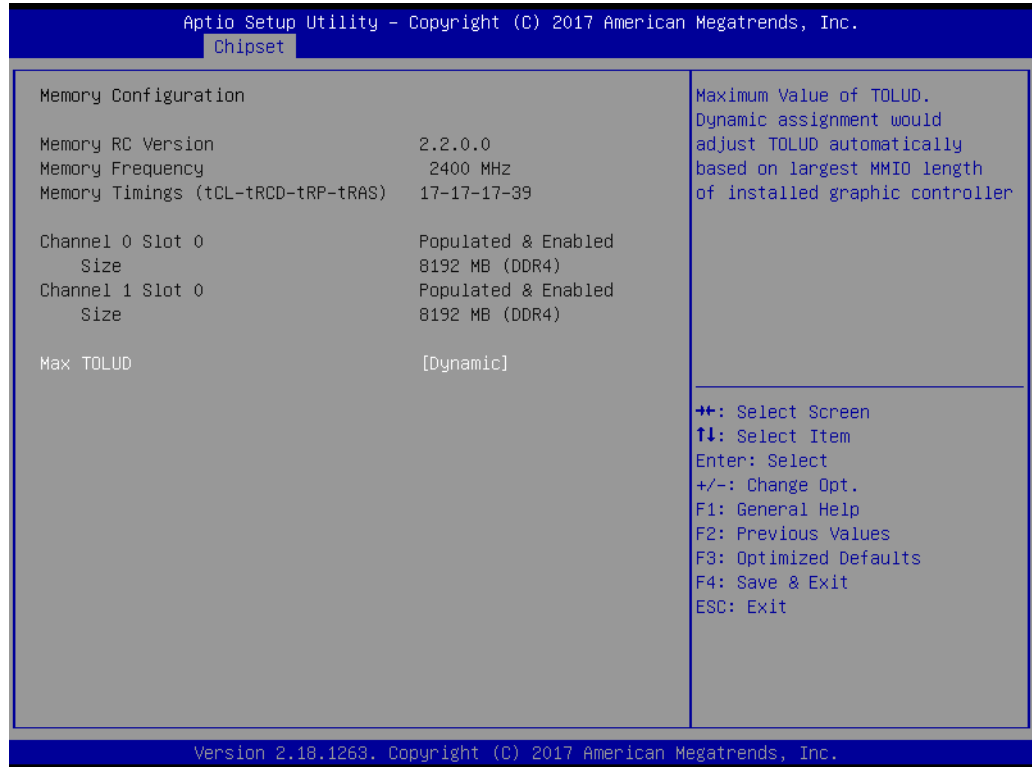

Figure 3.35 Memory Configuration

- **Max TOLUD**

Maximum value of TOLUD. Dynamic assignment would adjust TOLUD automatically based on largest MMIO length of installed graphic controller.

Graphics Configuration

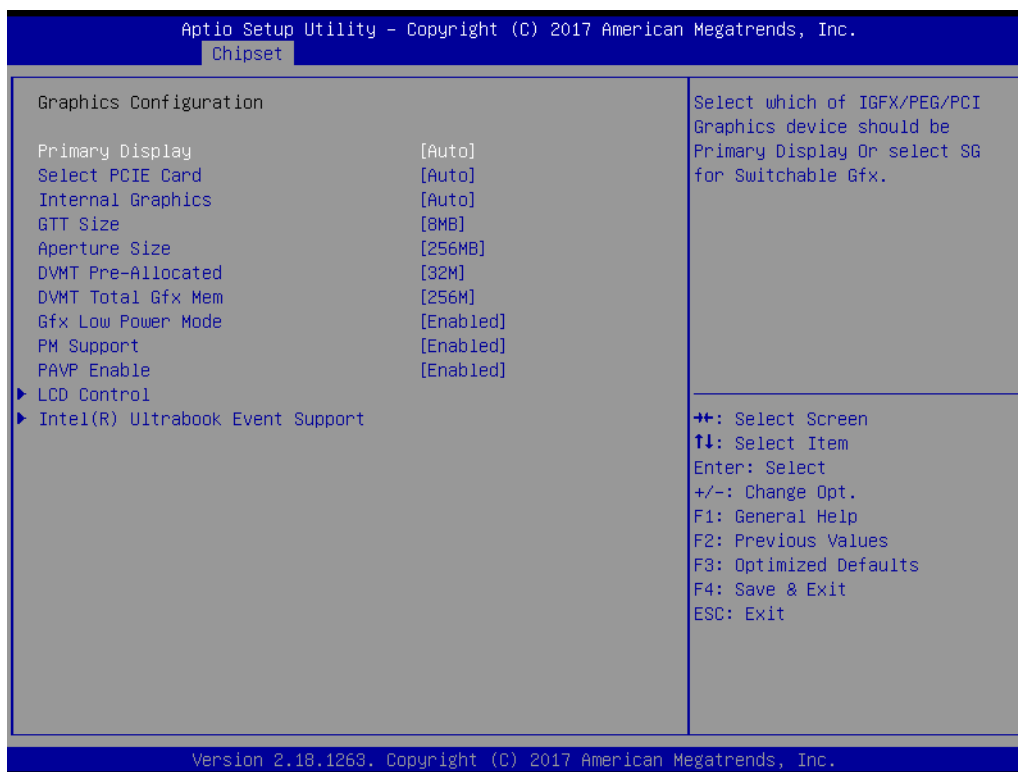

Figure 3.36 Graphics Configuration

- **Primary Display**
Selects which IGFX/PEG/PCI graphics device should be primary display or select SG for switchable Gfx.
- **Select PCIE Card**
Selects the card used on the platform Auto: Skip GPIO based Power Enable to dGPU Elk Creek 4: dGPU Power Enable = ActiveLow PEG Eva: dGPU Power Enable = ActiveHigh.
- **Internal Graphics**
Keep IGFX enabled based on the setup options.
- **GTT Size**
Selects the GTT Size.
- **Aperture Size**
Selects the Aperture Size.

Note! *Above 4GB MMIO BIOS assignment is automatically enabled when selecting 2048MB aperture. To use this feature, please disable CSM support.*



- **DVMT Pre-Allocated**
Select DVMT 5.0 Pre-Allocated (Fixed) graphics memory size used by the Internal Graphics Device.
- **DVMT Total Gfx Mem**
Select DVMT5.0 Total Graphic Memory size used by the internal graphics device.
- **Gfx Low Power Mode**

This option is applicable for SFF only.

- **PM Support**
Enables or disables PM support.
- **PAVP Enable**
Enables or disables PAVP.
- **LCD Control**
LCD Control.
- **Intel(R) Ultrabook Event Support**
Intel(R) Ultrabook Event Support.

– LCD Control

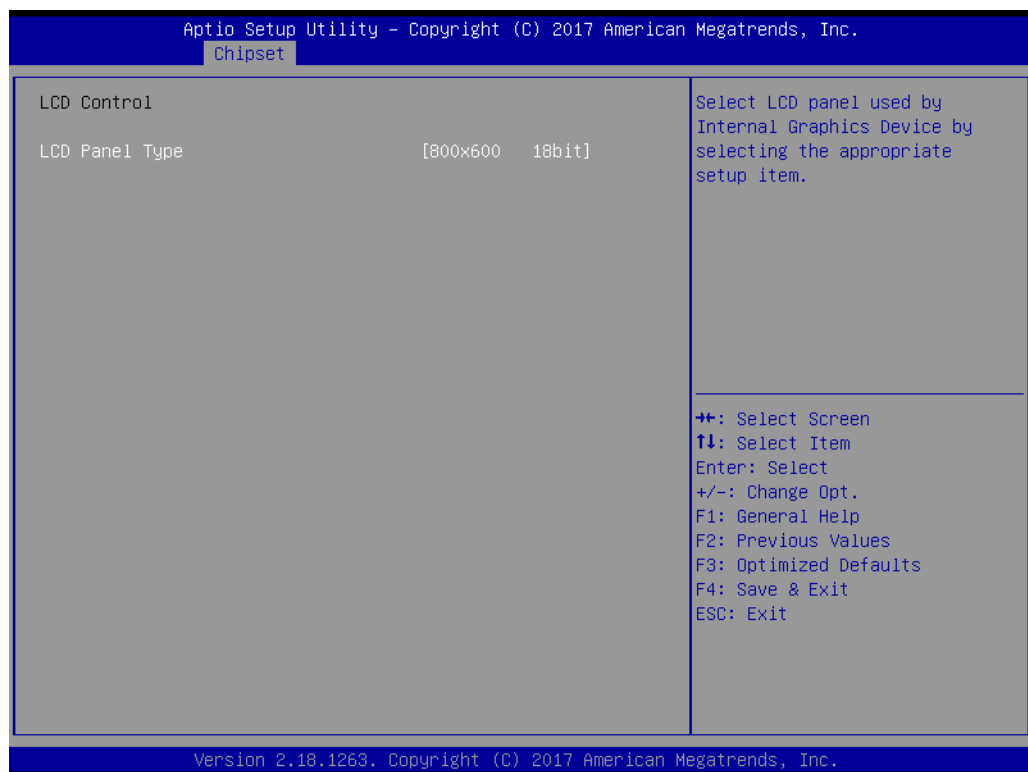
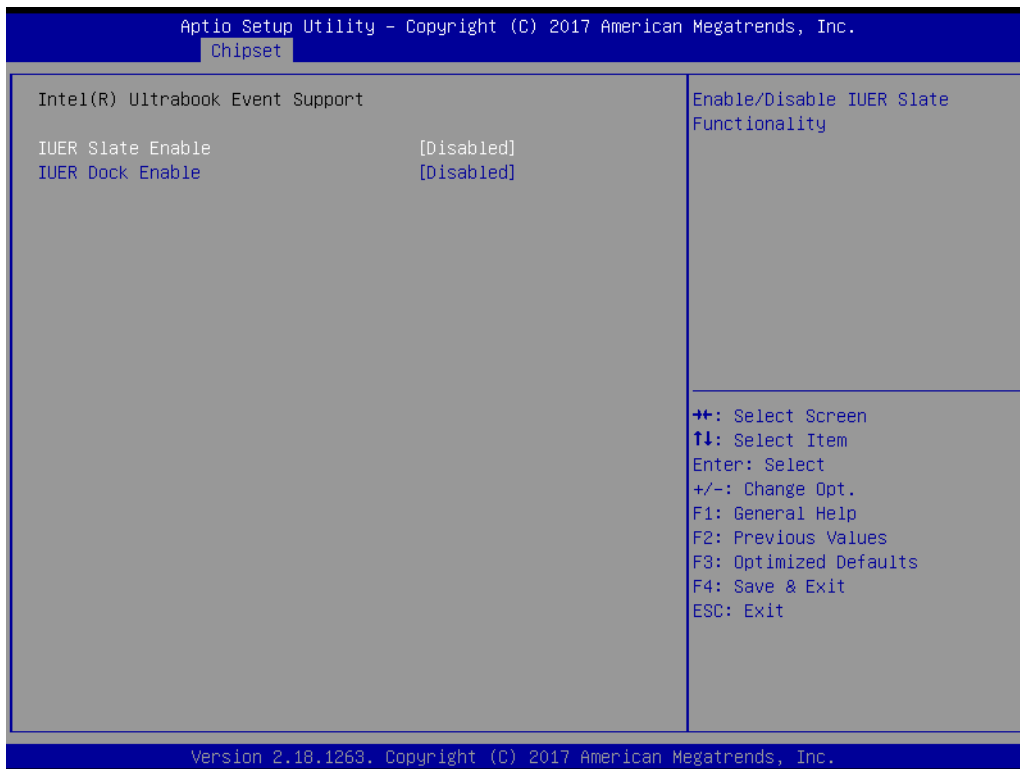

Figure 3.37 LCD Control

- **LCD Panel Type**
Select LCD panel used by Internal Graphics Device by selecting the appropriate setup item.

– Intel® Ultrabook Event Support

**Figure 3.38 Intel® Ultrabook Event Support**

- **IUER Slate Enable**
Enables or disables IUER slate functionality.
- **IUER Dock Enable**
Enables or disables IUER dock functionality.

PEG Port Configuration

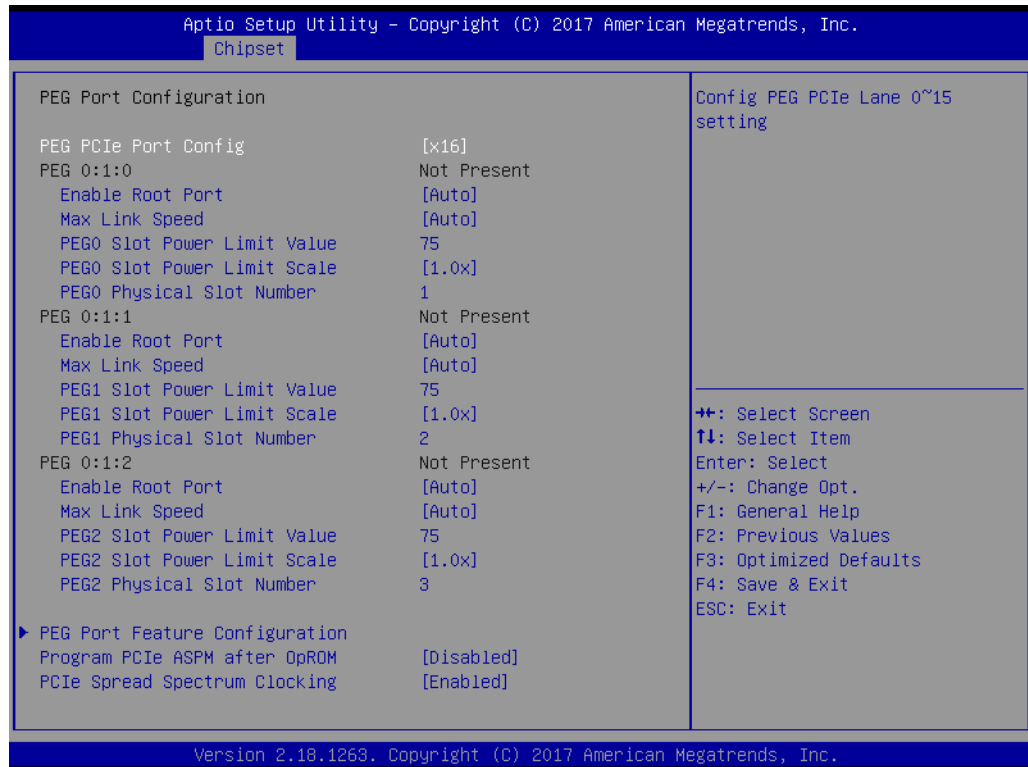

Figure 3.39 PEG Port Configuration

- **PEG PCIe Port Config**
Config PEG PCIe Lane 0~15 setting.
- **Enable Root Port**
Enable or disable the Root Port.
- **Max Link Speed**
Configure PEG 0:1:[0..2] Max Speed.
- **PEG[0..2] Slot Power Limit Scale**
Select the scale used for the Slot Power Limit Value.
- **PEG Port Feature Configuration**
PEG Port Feature Configuration.
- **Program PCIe ASPM after OpROM**
Enabled: PCIe ASPM will be programmed after OpROM. Disabled: PCIe ASPM will be programmed before OpROM.
- **PCIe Spread Spectrum Clocking**
Allows disabling Spread Spectrum Clocking for compliance testing.

– PEG Port Feature Configuration

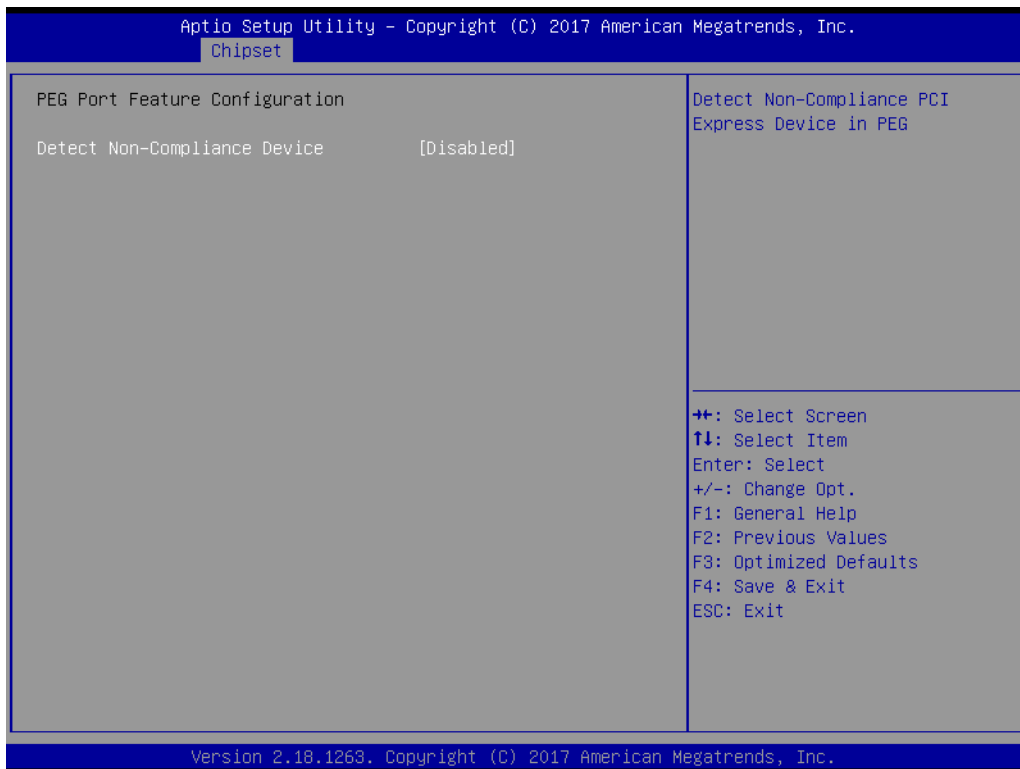

Figure 3.40 PEH Port Feature Configuration

- **Detect Non-Compliance Device**
Detect Non-Compliance PCI Express Device. If enabled, it will take more time at POST.

3.2.3.2 PCH-IO Configuration

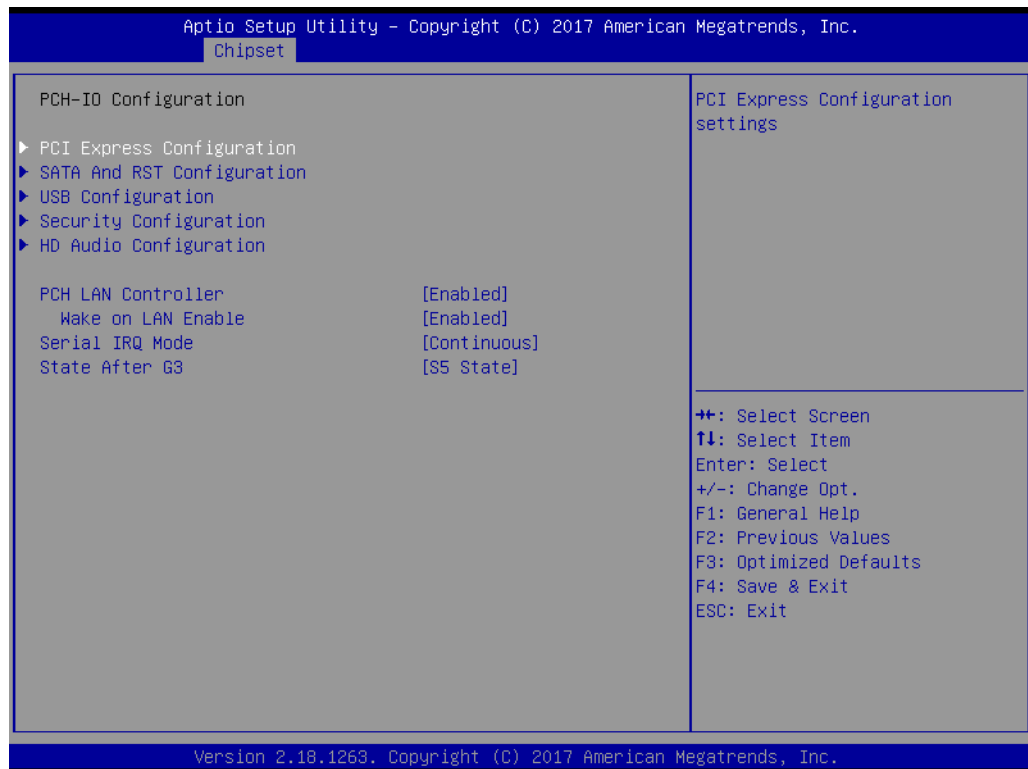

Figure 3.41 PCH-IO Configuration

- **PCI Express Configuration**
PCI Express Configuration.
- **SATA And RST Configuration**
SATA device options settings.
- **USB Configuration**
USB Configuration settings.
- **Security Configuration**
Security Configuration settings.
- **HD Audio Configuration**
HD Audio Configuration settings.
- **PCH LAN Controller**
Enables or disables onboard NIC.
- **Wake on LAN Enable**
Enables or disables integrated LAN to wake the system.
- **Serial IRQ Mode**
Configure Serial IRQ Mode.
- **State After G3**
Specify what state to go to when power is re-applied after a power failure (G3 state).

PCI Express Configuration

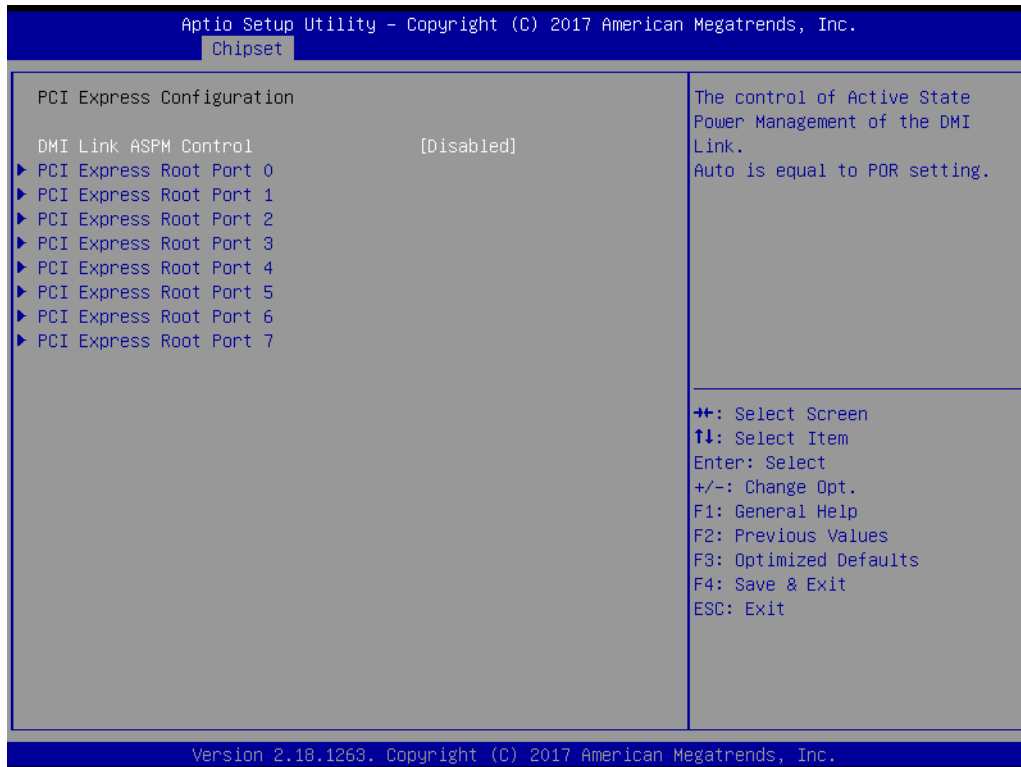

Figure 3.42 PCI Express Configuration

- **DMI Link ASPM Control**

The control of Active State Power Management of the DMI Link. Auto is equal to POR setting.

– PCI Express Root Port [0..7]

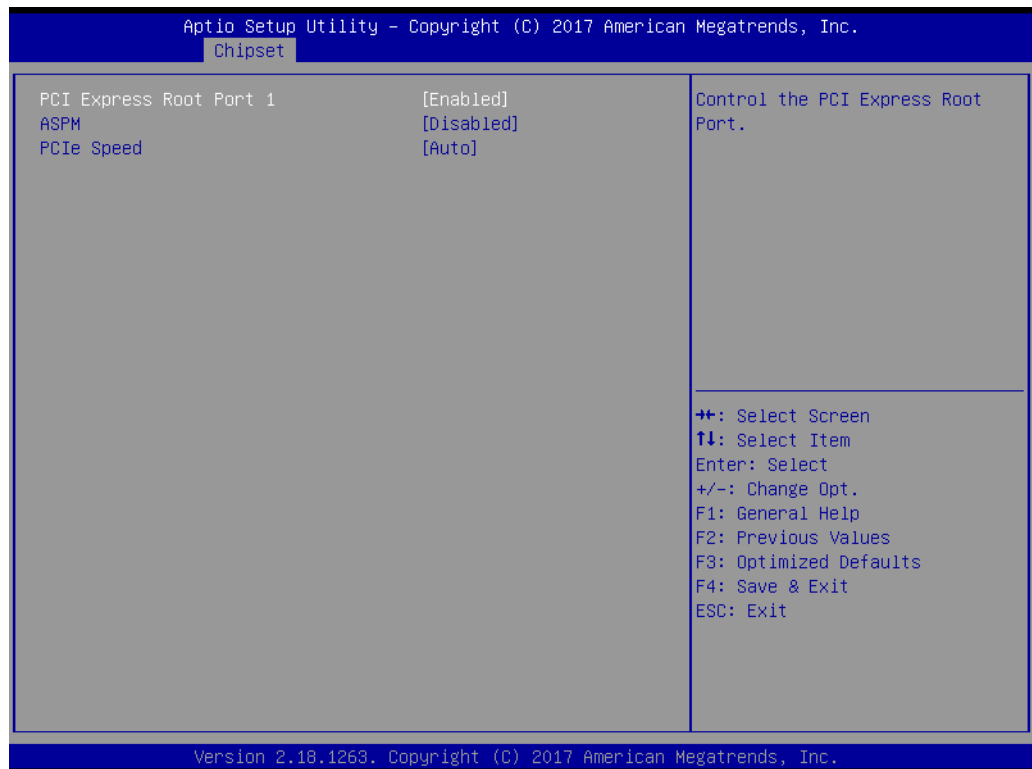

Figure 3.43 PCI Express Root Port [0..7]

- **PCI Express Root Port [0..7]**
PCI Express Root Port [0..7] settings.
- **ASPM**
Set the ASPM Level: Forces L0s - force all links to L0s state AUTO - BIOS auto configure DISABLE - Disables ASPM.
- **PCIe Speed**
Configure PCIe Speed.

SATA And RST Configuration

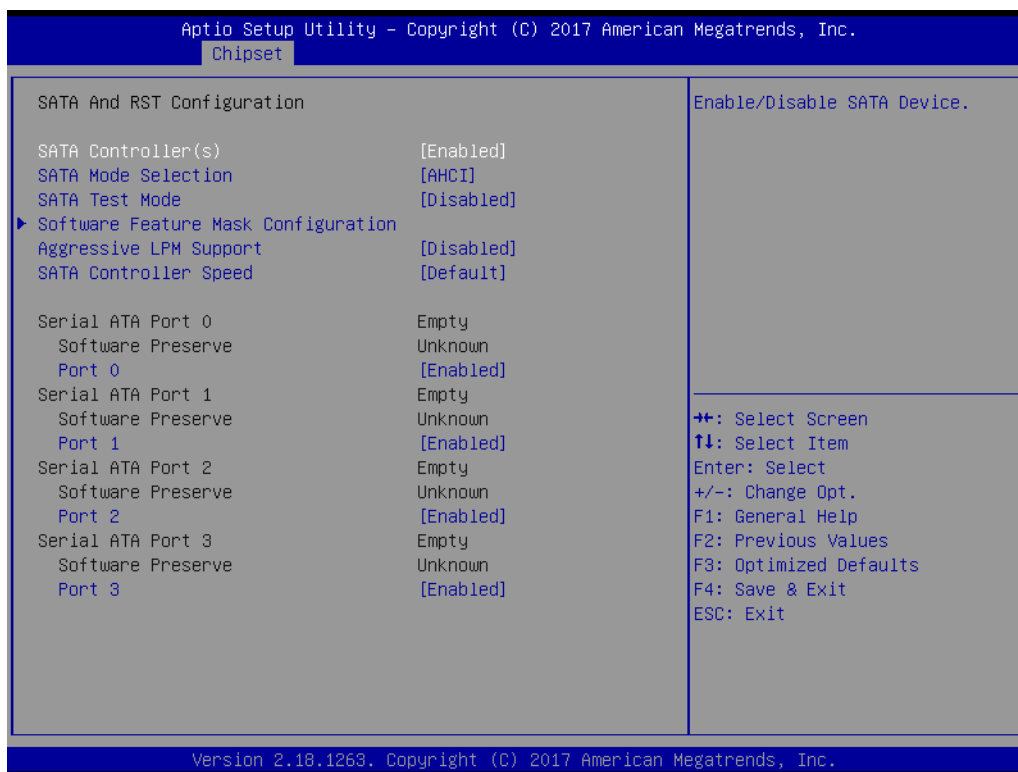

Figure 3.44 SATA And RST Configuration

- **SATA Controller(s)**
Enables or disables SATA Device.
- **SATA Mode Selection**
Determines how SATA controller(s) operate.
- **SATA Test Mode**
Test Mode enables or disables (Loop Back).
- **Software Feature Mask Configuration**
RST Legacy OROM/RST UEFI driver will refer to the SWFM configuration to enable or disable the storage features.
- **Aggressive LPM Support**
Enable PCH to aggressively enter link power state.
- **SATA Controller Speed**
Indicates the maximum speed the SATA controller can support.
- **Port [0..4]**
Enable or disable SATA port.

USB Configuration

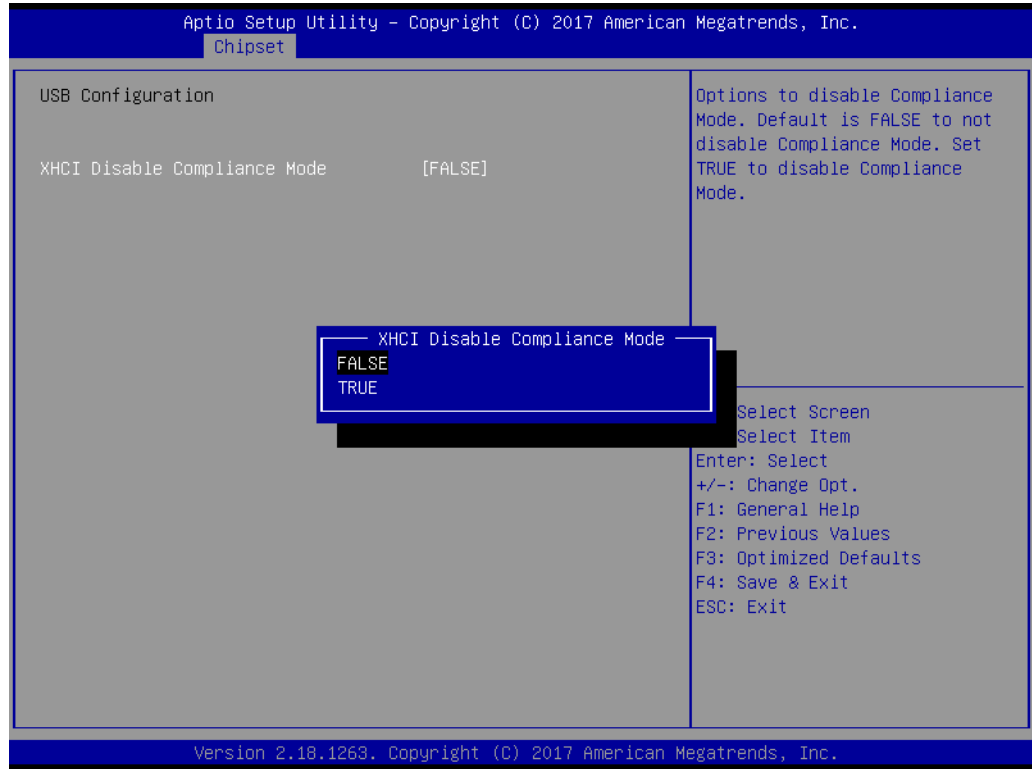

Figure 3.45 USB Configuration

- **XHCI Disable Compliance Mode**
Options to disable Compliance Mode. Default is FALSE to not disable Compliance Mode. Set TRUE to disable Compliance Mode.

Security Configuration

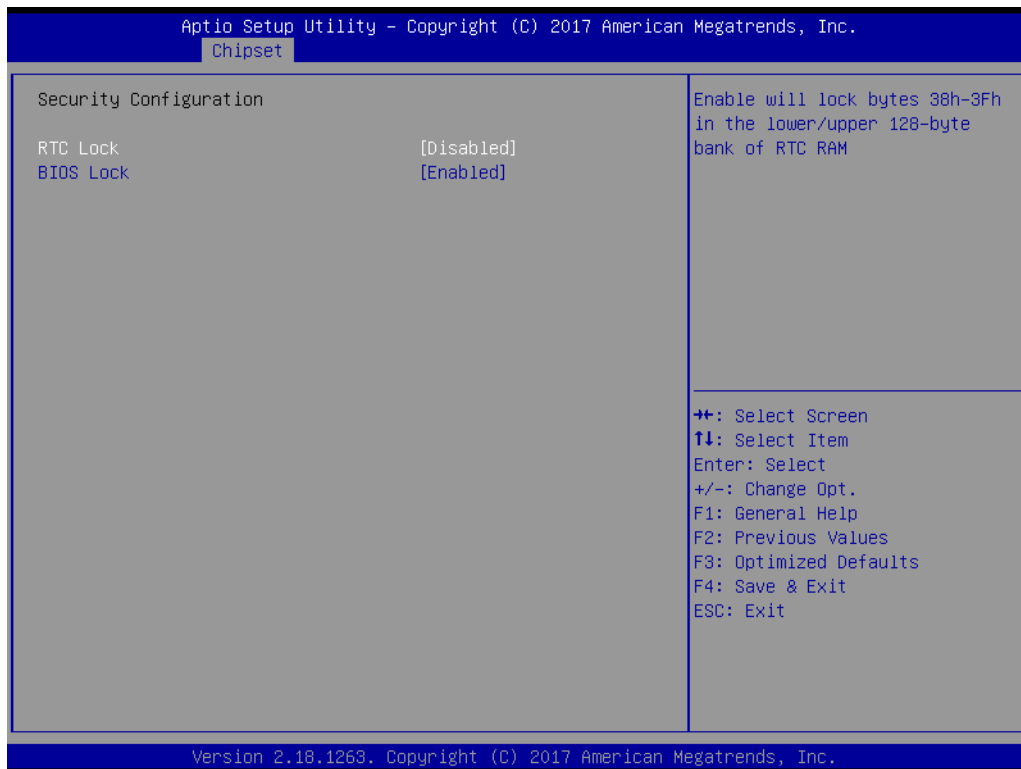

Figure 3.46 Security Configuration

- **RTC Lock**
Enable will lock bytes 38h-3Fh in the lower/upper 128-byte bank of RTC RAM.
- **BIOS Lock**
Enables or disables the PCH BIOS Lock enable feature. Required to be enabled to ensure SMM protection of flash.

HD Audio Configuration

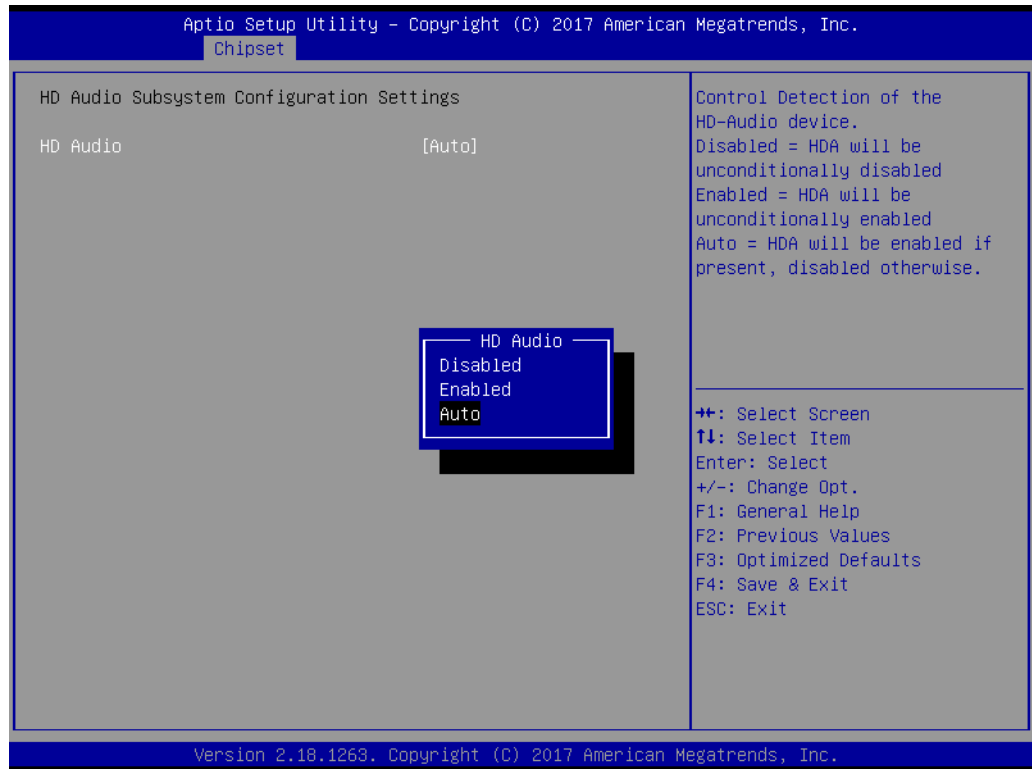

Figure 3.47 HD Audio Configuration

- **HD Audio**
Control Detection of the HD-Audio device.
Disabled = HDA will be unconditionally disabled.
Enabled = HDA will be unconditionally enabled.
Auto = HDA will be enabled if present, disabled otherwise.

3.2.4 Security Chipset



Figure 3.48 Security Chipset

- **Administrator Password**
Set Administrator Password.
- **User Password**
Set User Password.

3.2.5 Boot Setup

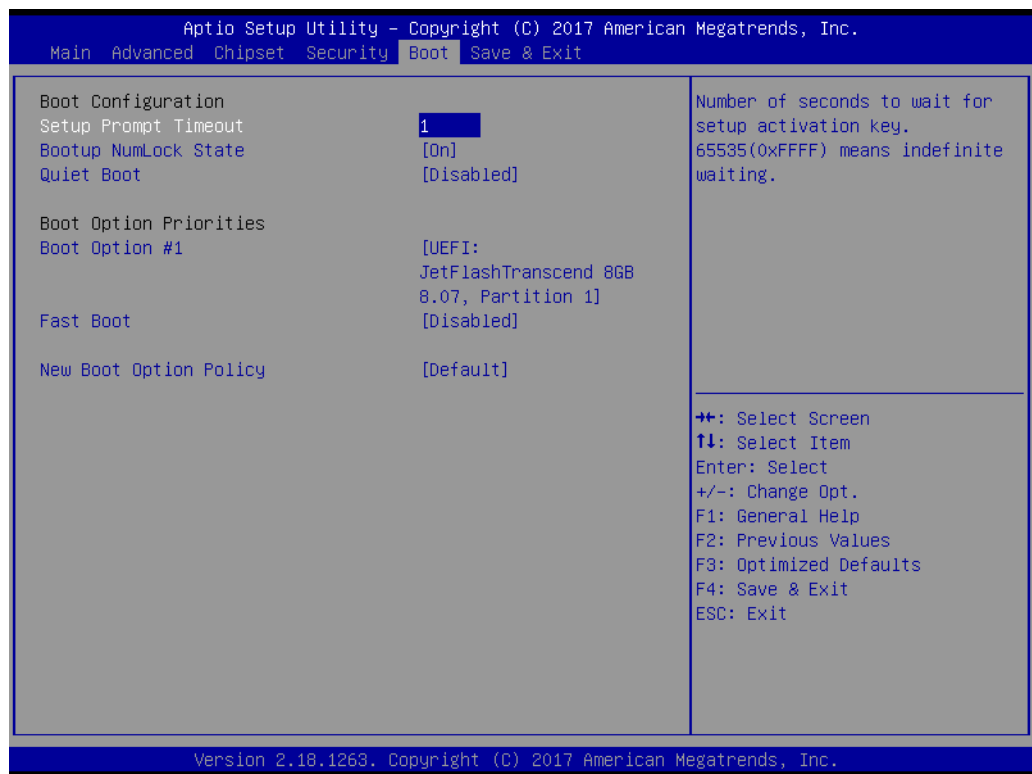

Figure 3.49 Boot Setup

- **Setup Prompt Timeout**
Number of seconds to wait for setup activation key. 65535(0xFFFF) means indefinite waiting.
- **Bootup NumLock State**
Select the keyboard NumLock State.
- **Quiet Boot**
Enables or disables Quiet Boot option.
- **Boot Option #**
Select whether or not the OS you will boot to will be PTP aware.
- **Fast Boot**
Enables or disables boot with initialization of a minimal set of devices required to launch active boot option. Has no effect for BBS boot options.
- **New Boot Option Policy**
Controls the placement of newly detected UEFI boot options.

3.2.6 Save & Exit

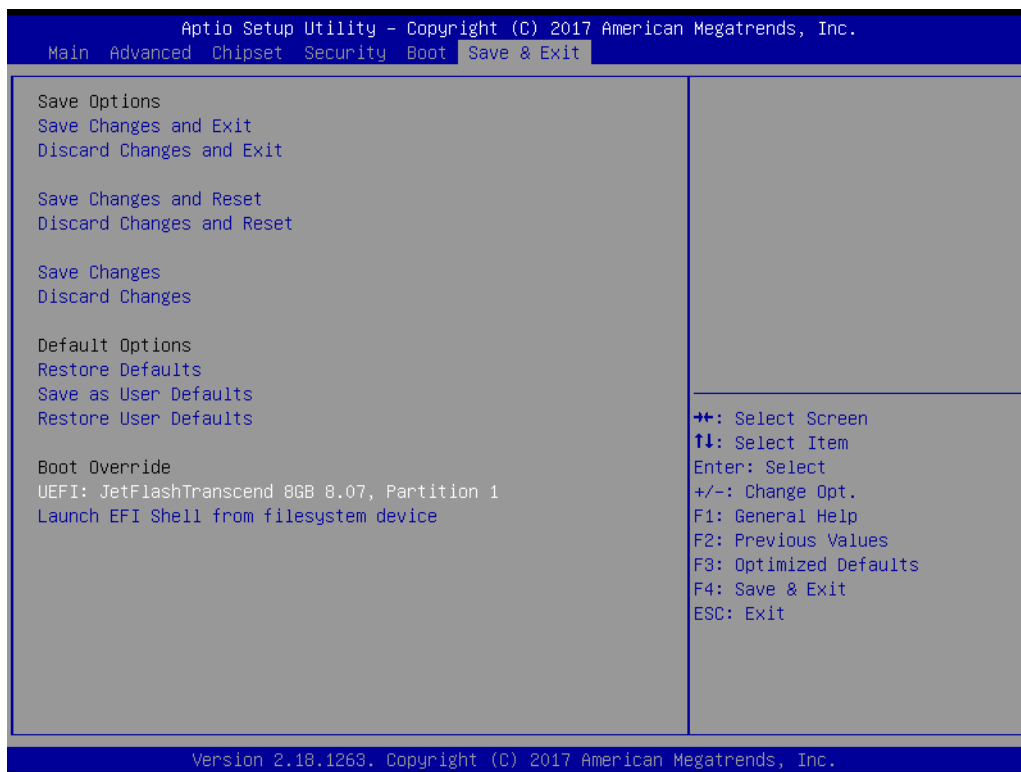

Figure 3.50 Save & Exit

- **Save Changes and Exit**
Exit system setup after saving the changes.
- **Discard Changes and Exit**
Exit system setup without saving any changes.
- **Save Changes**
Save Changes done so far to any of the setup options.
- **Discard Changes**
Discard Changes done so far to any of the setup options.
- **Restore Defaults**
Restore/Load Default values for all the setup options.
- **Save as User Defaults**
Save the changes done so far as User Defaults.
- **Restore User Defaults**
Restore the User Defaults to all the setup options.

Chapter 4

S/W Introduction & Installation

- S/W Introduction
- Driver Installation
- Advantech iManager

4.1 S/W Introduction

The mission of Advantech Embedded Software Services is to "Enhance quality of life with Advantech platforms and Microsoft Windows embedded technology." We enable Windows Embedded software products on Advantech platforms to more effectively support the embedded computing community. Customers are freed from the hassle of dealing with multiple vendors (Hardware suppliers, System integrators, Embedded OS distributor) for projects. Our goal is to make Windows Embedded Software solutions easily and widely available to the embedded computing community.

4.2 Driver Installation

The Intel Chipset Software Installation (CSI) utility installs the Windows INF files that outline to the operating system how the chipset components will be configured.

4.2.1 Windows Driver Setup

To install the drivers on a windows-based operation system, please connect to internet and browse the website <http://support.advantech.com.tw> and download the drivers that you want to install and follow Driver Setup instructions to complete the installation.

4.2.2 Other OS

To install the drivers for Linux or other OS, please connect to internet and browse the website <http://support.advantech.com.tw> to download the setup file.

4.3 Advantech iManager

Advantech's platforms come equipped with iManager, a micro controller that provides embedded features for system integrators. Embedded features have been moved from the OS/BIOS level to the board level, to increase reliability and simplify integration.

iManager runs whether the operating system is running or not; it can count the boot times and running hours of the device, monitor device health, and provide an advanced watchdog to handle errors just as they happen. iManager also comes with a secure & encrypted EEPROM for storing important security key or other customer define information. All the embedded functions are configured through API and provide corresponding utilities to demonstrate. These APIs comply with PICMG EAPI (Embedded Application Programmable Interface) specification and unify in the same structures. It makes these embedded features easier to integrate, speed up developing schedule, and provide the customer's software continuity while upgrade hardware. More detail of how to use the APIs and utilities, please refer to Advantech iManager 2.0 Software API User Manual.

Control



GPIO

General Purpose Input/Output is a flexible parallel interface that allows a variety of custom connections. It allows users to monitor the level of signal input or set the output status to switch on/off a device. Our API also provides Programmable GPIO, which allows developers to dynamically set the GPIO input or output status.



SMBus

SMBus is the System Management Bus defined by Intel® Corporation in 1995. It is used in personal computers and servers for low-speed system management communications. The SMBus API allows a developer to interface a embedded system environment and transfer serial messages using the SMBus protocols, allowing multiple simultaneous device control.



I2C

I2C is a bi-directional two wire bus that was developed by Philips for use in their televisions in the 1980s. The I2C API allows a developer to interface with an embedded system environment and transfer serial messages using the I2C protocols, allowing multiple simultaneous device control.

Display



Brightness Control

The Brightness Control API allows a developer to interface with an embedded device to easily control brightness.



Backlight

The Backlight API allows a developer to control the backlight (screen) on/off in an embedded device.

Monitor



Watchdog

A watchdog timer (WDT) is a device that performs a specific operation after a certain period of time if something goes wrong and the system does not recover on its own. A watchdog timer can be programmed to perform a warm boot (restarting the system) after a certain number of seconds.



Hardware Monitor

The Hardware Monitor (HWM) API is a system health supervision API that inspects certain condition indexes, such as fan speed, temperature and voltage.



Hardware Control

The Hardware Control API allows developers to set the PWM (Pulse Width Modulation) value to adjust fan speed or other devices; it can also be used to adjust the LCD brightness.

Power Saving



CPU Speed

Make use of Intel SpeedStep technology to reduce power power consumption. The system will automatically adjust the CPU Speed depending on system loading.



System Throttling

Refers to a series of methods for reducing power consumption in computers by lowering the clock frequency. These APIs allow the user to lower the clock from 87.5% to 12.5%.

Appendix **A**

Pin Assignment

This appendix gives you the information about the hardware pin assignment of the SOM-5898 CPU System on Module.

Sections include:

- SOM-5898 Type 6 Pin Assignment

A.1 SOM-5898 Type 6 Pin Assignment

This section gives SOM-5898 pin assignment on COM Express connector which compliant with COMR.0 R2.1 Type 6 pin-out definitions. More details about how to use these pins and get design reference. Please contact to Advantech for design guide, checklist, reference schematic, and other hardware/software support.

SOM-5898 Row A,B			
A1	GND (FIXED)	B1	GND (FIXED)
A2	GBE0_MDI3-	B2	GBE0_ACT#
A3	GBE0_MDI3+	B3	LPC_FRAME#
A4	GBE0_LINK100#	B4	LPC_AD0
A5	GBE0_LINK1000#	B5	LPC_AD1
A6	GBE0_MDI2-	B6	LPC_AD2
A7	GBE0_MDI2+	B7	LPC_AD3
A8	GBE0_LINK#	B8	N/A
A9	GBE0_MDI1-	B9	N/A
A10	GBE0_MDI1+	B10	LPC_CLK
A11	GND (FIXED)	B11	GND (FIXED)
A12	GBE0_MDI0-	B12	PWRBTN#
A13	GBE0_MDI0+	B13	SMB_CK
A14	N/A	B14	SMB_DAT
A15	SUS_S3#	B15	SMB_ALERT#
A16	SATA0_TX+	B16	SATA1_TX+
A17	SATA0_TX-	B17	SATA1_TX-
A18	SUS_S4#	B18	SUS_STAT#
A19	SATA0_RX+	B19	SATA1_RX+
A20	SATA0_RX-	B20	SATA1_RX-
A21	GND (FIXED)	B21	GND (FIXED)
A22	SATA2_TX+	B22	SATA3_TX+
A23	SATA2_TX-	B23	SATA3_TX-
A24	SUS_S5#	B24	PWR_OK
A25	SATA2_RX+	B25	SATA3_RX+
A26	SATA2_RX-	B26	SATA3_RX-
A27	BATLOW#	B27	WDT
A28	(S)ATA_ACT#	B28	N/A
A29	HDA_SYNC	B29	HDA_SDIN1
A30	HDA_RST#	B30	HDA_SDIN0
A31	GND (FIXED)	B31	GND (FIXED)
A32	HDA_BITCLK	B32	SPKR
A33	HDA_SDOUT	B33	I2C_CK
A34	BIOS_DIS0#	B34	I2C_DAT
A35	THRMTRIP#	B35	THRM#
A36	USB6-	B36	USB7-
A37	USB6+	B37	USB7+
A38	USB_6_7_OC#	B38	USB_4_5_OC#
A39	USB4-	B39	USB5-
A40	USB4+	B40	USB5+

A41	GND (FIXED)	B41	GND (FIXED)
A42	USB2-	B42	USB3-
A43	USB2+	B43	USB3+
A44	USB_2_3_OC#	B44	USB_0_1_OC#
A45	USB0-	B45	USB1-
A46	USB0+	B46	USB1+
A47	VCC_RTC	B47	EXCD1_PERST#
A48	EXCD0_PERST#	B48	EXCD1_CPPE#
A49	EXCD0_CPPE#	B49	SYS_RESET#
A50	LPC_SERIRQ	B50	CB_RESET#
A51	GND (FIXED)	B51	GND (FIXED)
A52	PCIE_TX5+	B52	PCIE_RX5+
A53	PCIE_TX5-	B53	PCIE_RX5-
A54	GPI0	B54	GPO1
A55	PCIE_TX4+	B55	PCIE_RX4+
A56	PCIE_TX4-	B56	PCIE_RX4-
A57	GND	B57	GPO2
A58	PCIE_TX3+	B58	PCIE_RX3+
A59	PCIE_TX3-	B59	PCIE_RX3-
A60	GND (FIXED)	B60	GND (FIXED)
A61	PCIE_TX2+	B61	PCIE_RX2+
A62	PCIE_TX2-	B62	PCIE_RX2-
A63	GPI1	B63	GPO3
A64	PCIE_TX1+	B64	PCIE_RX1+
A65	PCIE_TX1-	B65	PCIE_RX1-
A66	GND	B66	WAKE0#
A67	GPI2	B67	WAKE1#
A68	PCIE_TX0+	B68	PCIE_RX0+
A69	PCIE_TX0-	B69	PCIE_RX0-
A70	GND (FIXED)	B70	GND (FIXED)
A71	LVDS_A0+	B71	LVDS_B0+
A72	LVDS_A0-	B72	LVDS_B0-
A73	LVDS_A1+	B73	LVDS_B1+
A74	LVDS_A1-	B74	LVDS_B1-
A75	LVDS_A2+	B75	LVDS_B2+
A76	LVDS_A2-	B76	LVDS_B2-
A77	LVDS_VDD_EN	B77	LVDS_B3+
A78	LVDS_A3+	B78	LVDS_B3-
A79	LVDS_A3-	B79	LVDS_BKLT_EN
A80	GND (FIXED)	B80	GND (FIXED)
A81	LVDS_A_CK+	B81	LVDS_B_CK+
A82	LVDS_A_CK-	B82	LVDS_B_CK-
A83	LVDS_I2C_CK	B83	LVDS_BKLT_CTRL
A84	LVDS_I2C_DAT	B84	VCC_5V_SBY
A85	GPI3	B85	VCC_5V_SBY
A86	N/A	B86	VCC_5V_SBY
A87	eDP_HPD	B87	VCC_5V_SBY
A88	PCIE_CLK_REF+	B88	BIOS_DIS1#

A89	PCIE_CLK_REF-	B89	VGA_RED
A90	GND (FIXED)	B90	GND (FIXED)
A91	SPI_POWER	B91	VGA_GRN
A92	SPI_MISO	B92	VGA_BLU
A93	GPO0	B93	VGA_HSYNC
A94	SPI_CLK	B94	VGA_VSYNC
A95	SPI_MOSI	B95	VGA_I2C_CK
A96	TPM_PP	B96	VGA_I2C_DAT
A97	N/A	B97	SPI_CS#
A98	SER0_TX	B98	N/A
A99	SER0_RX	B99	N/A
A100	GND (FIXED)	B100	GND (FIXED)
A101	SER1_TX	B101	FAN_PWMOUT
A102	SER1_RX	B102	FAN_TACHIN
A103	LID#	B103	SLEEP#
A104	VCC_12V	B104	VCC_12V
A105	VCC_12V	B105	VCC_12V
A106	VCC_12V	B106	VCC_12V
A107	VCC_12V	B107	VCC_12V
A108	VCC_12V	B108	VCC_12V
A109	VCC_12V	B109	VCC_12V
A110	GND (FIXED)	B110	GND (FIXED)
SOM-5898			
Row C,D			
C1	GND (FIXED)	D1	GND (FIXED)
C2	GND	D2	GND
C3	USB_SSRX0-	D3	USB_SSTX0-
C4	USB_SSRX0+	D4	USB_SSTX0+
C5	GND	D5	GND
C6	USB_SSRX1-	D6	USB_SSTX1-
C7	USB_SSRX1+	D7	USB_SSTX1+
C8	GND	D8	GND
C9	USB_SSRX2-	D9	USB_SSTX2-
C10	USB_SSRX2+	D10	USB_SSTX2+
C11	GND (FIXED)	D11	GND (FIXED)
C12	USB_SSRX3-	D12	USB_SSTX3-
C13	USB_SSRX3+	D13	USB_SSTX3+
C14	GND	D14	GND
C15	N/A	D15	DDI1_CTRLCLK_AUX+
C16	N/A	D16	DDI1_CTRLDATA_AUX-
C17	N/A	D17	N/A
C18	N/A	D18	N/A
C19	PCIE_RX6+	D19	PCIE_TX6+
C20	PCIE_RX6-	D20	PCIE_TX6-
C21	GND (FIXED)	D21	GND (FIXED)
C22	PCIE_RX7+	D22	PCIE_TX7+
C23	PCIE_RX7-	D23	PCIE_TX7-
C24	DDI1_HPD	D24	N/A

C25	N/A	D25	N/A
C26	N/A	D26	DDI1_PAIR0+
C27	N/A	D27	DDI1_PAIR0-
C28	N/A	D28	N/A
C29	N/A	D29	DDI1_PAIR1+
C30	N/A	D30	DDI1_PAIR1-
C31	GND (FIXED)	D31	GND (FIXED)
C32	DDI2_CTRLCLK_AUX+	D32	DDI1_PAIR2+
C33	DDI2_CTRLCLK_AUX-	D33	DDI1_PAIR2-
C34	DDI2_DDC_AUX_SEL	D34	DDI1_DDC_AUX_SEL
C35	N/A	D35	N/A
C36	DDI3_CTRLCLK_AUX+	D36	DDI1_PAIR3+
C37	DDI3_CTRLCLK_AUX-	D37	DDI1_PAIR3-
C38	DDI3_DDC_AUX_SEL	D38	N/A
C39	DDI3_PAIR0+	D39	DDI2_PAIR0+
C40	DDI3_PAIR0-	D40	DDI2_PAIR0-
C41	GND (FIXED)	D41	GND (FIXED)
C42	DDI3_PAIR1+	D42	DDI2_PAIR1+
C43	DDI3_PAIR1-	D43	DDI2_PAIR1-
C44	DDI3_HPD	D44	DDI2_HPD
C45	N/A	D45	N/A
C46	DDI3_PAIR2+	D46	DDI2_PAIR2+
C47	DDI3_PAIR2-	D47	DDI2_PAIR2-
C48	N/A	D48	N/A
C49	DDI3_PAIR3+	D49	DDI2_PAIR3+
C50	DDI3_PAIR3-	D50	DDI2_PAIR3-
C51	GND (FIXED)	D51	GND (FIXED)
C52	PEG_RX0+	D52	PEG_TX0+
C53	PEG_RX0-	D53	PEG_TX0-
C54	N/A	D54	PEG_LANE_RV#
C55	PEG_RX1+	D55	PEG_TX1+
C56	PEG_RX1-	D56	PEG_TX1-
C57	N/A	D57	TYPE2#
C58	PEG_RX2+	D58	PEG_TX2+
C59	PEG_RX2-	D59	PEG_TX2-
C60	GND (FIXED)	D60	GND (FIXED)
C61	PEG_RX3+	D61	PEG_TX3+
C62	PEG_RX3-	D62	PEG_TX3-
C63	N/A	D63	N/A
C64	N/A	D64	N/A
C65	PEG_RX4+	D65	PEG_TX4+
C66	PEG_RX4-	D66	PEG_TX4-
C67	N/A	D67	GND
C68	PEG_RX5+	D68	PEG_TX5+
C69	PEG_RX5-	D69	PEG_TX5-
C70	GND (FIXED)	D70	GND (FIXED)
C71	PEG_RX6+	D71	PEG_TX6+
C72	PEG_RX6-	D72	PEG_TX6-

C73	GND	D73	GND
C74	PEG_RX7+	D74	PEG_TX7+
C75	PEG_RX7-	D75	PEG_TX7-
C76	GND	D76	GND
C77	N/A	D77	N/A
C78	PEG_RX8+	D78	PEG_TX8+
C79	PEG_RX8-	D79	PEG_TX8-
C80	GND (FIXED)	D80	GND (FIXED)
C81	PEG_RX9+	D81	PEG_TX9+
C82	PEG_RX9-	D82	PEG_TX9-
C83	N/A	D83	N/A
C84	GND	D84	GND
C85	PEG_RX10+	D85	PEG_TX10+
C86	PEG_RX10-	D86	PEG_TX10-
C87	GND	D87	GND
C88	PEG_RX11+	D88	PEG_TX11+
C89	PEG_RX11-	D89	PEG_TX11-
C90	GND (FIXED)	D90	GND (FIXED)
C91	PEG_RX12+	D91	PEG_TX12+
C92	PEG_RX12-	D92	PEG_TX12-
C93	GND	D93	GND
C94	PEG_RX13+	D94	PEG_TX13+
C95	PEG_RX13-	D95	PEG_TX13-
C96	GND	D96	GND
C97	N/A	D97	PEG_ENABLE#
C98	PEG_RX14+	D98	PEG_TX14+
C99	PEG_RX14-	D99	PEG_TX14-
C100	GND (FIXED)	D100	GND (FIXED)
C101	PEG_RX15+	D101	PEG_TX15+
C102	PEG_RX15-	D102	PEG_TX15-
C103	GND	D103	GND
C104	VCC_12V	D104	VCC_12V
C105	VCC_12V	D105	VCC_12V
C106	VCC_12V	D106	VCC_12V
C107	VCC_12V	D107	VCC_12V
C108	VCC_12V	D108	VCC_12V
C109	VCC_12V	D109	VCC_12V
C110	GND (FIXED)	D110	GND (FIXED)

Appendix **B**

Watchdog Timer

This appendix gives you the information about the watchdog timer programming on the SOM-5898 CPU System on Module.

Sections include:

- Watchdog Timer Programming

B.1 Programming the Watchdog Timer

Trigger Event	Note
IRQ	(BIOS setting default disable)**
NMI	N/A
SCI	Power button event
Power Off	Support
H/W Restart	Support
WDT Pin Activate	Support

** WDT new driver support automatically select available IRQ number from BIOS, and then set to EC. Only Win10 support it.

In other OS, it will still use IRQ number from BIOS setting as usual.

For details, please refer to iManager & Software API User Manual.

Appendix **C**

Programming GPIO

This Appendix gives the illustration of the General Purpose Input and Output pin setting.

Sections include:

- System I/O ports

C.1 GPIO Register

GPIO Byte Mapping	H/W Pin Name
BIT0	GPO0
BIT1	GPO1
BIT2	GPO2
BIT3	GPO3
BIT4	GPI0
BIT5	GPI1
BIT6	GPI2
BIT7	GPI3

For details, please refer to iManager & Software API User Manual.

Appendix **D**

System Assignments

This appendix gives you the information about the system resource allocation on the SOM-5898 CPU System on Module.

Sections include:

- System I/O ports
- DMA Channel Assignments
- Interrupt Assignments
- 1st MB Memory Map

D.1 System I/O Ports

Table D.1: Table D.1: System I/O ports

Addr.Range(Hex)	Device
0000-0CF7	PCI Express Root Complex
0020-0021	Programmable interrupt controller
0024-0025	Programmable interrupt controller
0028-0029	Programmable interrupt controller
002C-002D	Programmable interrupt controller
002E-002F	Motherboard resources
0030-0031	Programmable interrupt controller
0034-0035	Programmable interrupt controller
0038-0039	Programmable interrupt controller
003C-003D	Programmable interrupt controller
0040-0043	System timer
004E-004F	Motherboard resources
0050-0053	System timer
0060-0060	Standard PS/2 Keyboard
0061-0061	Motherboard resources
0062-0062	Microsoft ACPI-Compliant Embedded Controller
0063-0063	Motherboard resources
0064-0064	Standard PS/2 Keyboard
0065-0065	Motherboard resources
0066-0066	Microsoft ACPI-Compliant Embedded Controller
0067-0067	Motherboard resources
0070-0070	Motherboard resources
0070-0077	System CMOS/real time clock
0080-0080	Motherboard resources
0092-0092	Motherboard resources
00A0-00A1	Programmable interrupt controller
00A4-00A5	Programmable interrupt controller
00A8-00A9	Programmable interrupt controller
00AC-00AD	Programmable interrupt controller
00B0-00B1	Programmable interrupt controller
00B2-00B3	Motherboard resources
00B4-00B5	Programmable interrupt controller
00B8-00B9	Programmable interrupt controller
00BC-00BD	Programmable interrupt controller
00F0-00F0	Numeric data processor
029C-029D	Motherboard resources
02E8-02EF	Communications Port (COM4)
02F8-02FF	Communications Port (COM2)
0378-037F	Printer Port (LPT1)
03E8-03EF	Communications Port (COM3)
03F8-03FF	Communications Port (COM1)
04D0-04D1	Programmable interrupt controller
0680-069F	Motherboard resources

Table D.1: Table D.1: System I/O ports

0800-087F	Motherboard resources
0A00-0A0F	Motherboard resources
0A10-0A1F	Motherboard resources
0D00-FFFF	PCI Express Root Complex
164E-164F	Motherboard resources
1800-18FE	Motherboard resources
1854-1857	Motherboard resources
D000-EFFF	Intel(R) 100 Series/C230 Series Chipset Family PCI Express Root Port
F000-F03F	Microsoft Basic Display Adapter
F040-F05F	Intel 100 Series/C230 Series Chipset Family SMBus
F060-F07F	Standard SATA AHCI Controller
F080-F083	Standard SATA AHCI Controller
F090-F097	Standard SATA AHCI Controller
FF00-FFFE	Motherboard resources
FFFF-FFFF	Motherboard resources

D.2 DMA Channel Assignments

Table D.2: Table D.2: DMA Channel Assignments

Channel	Function
3	Printer Port (LPT1)

D.3 Interrupt Assignments

Table D.3: Table D.3: Interrupt Assignments

Interrupt#	Interrupt Source
IRQ 0	System Timer
IRQ 1	Standard PS/2 Keyboard
IRQ 3	Communications Port (COM2)
IRQ 4	Communications Port (COM1)
IRQ 5	Communications Port (COM4)
IRQ 6	Communications Port (COM3)
IRQ 8	System CMOS/real time clock
IRQ 13	Numeric data processor
IRQ 14	Motherboard resources
IRQ 54~511	Microsoft ACPI-Compliant System
IRQ11	Ethernet Controller
IRQ 11	Intel(R) 100 Series/C230 Series Chipset Family Thermal subsystem
IRQ 11	Intel(R) 100 Series/C230 Series Chipset Family SMBus
IRQ 16	High Definition Audio Controller
IRQ FFFFFFFC (-4)	Intel(R) Management Engine Interface
IRQ FFFFFFFD (-3)	Intel(R) USB 3.0 eXtensible Host Controller – 1.0 (Microsoft)
IRQ FFFFFFFE (-2)	Standard SATA AHCI Controller

D.4 1st MB Memory Map

Table D.4: Table D.4: 1st MB Memory Map

Addr. Range (Hex)	Device
0x000A0000-0x000BFFFF	PCI Express Root Complex
0x90000000-0xDFFFFFFF	PCI Express Root Complex
0xC0000000-0xCFFFFFFF	Microsoft Basic Display Adapter
0xD0000000-0xD09FFFFF	Intel(R) 100 Series/C230 Series Chipset Family PCI Express Root Port
0xDD000000-0xDE0FFFFF	Intel(R) 100 Series/C230 Series Chipset Family PCI Express Root Port
0xDE000000-0xDEFFFFFF	Microsoft Basic Display Adapter
0xDF000000-0xDF01FFFF	Ethernet Controller
0xDF020000-0xDF02FFFF	High Definition Audio Controller
0xDF030000-0xDF03FFFF	Intel(R) USB 3.0 eXtensible Host Controller – 1.0 (Micro- soft)
0xDF040000-0xDF043FFF	High Definition Audio Controller
0xDF044000-0xDF047FFF	Intel(R) 100 Series/C230 Series Chipset Family PMC
0xDF048000-0xDF049FFF	Standard SATA AHCI Controller
0xDF04A000-0xDF04A0FF	Intel(R) 100 Series/C230 Series Chipset Family SMBus
0xDF04B000-0xDF04B7FF	Standard SATA AHCI Controller
0xDF04C000-0xDF04C0FF	Standard SATA AHCI Controller
0xDF04E000-0xDF04EFFF	Intel(R) 100 Series/C230 Series Chipset Family Thermal subsystem
0xDFFE0000-0xDFFFFFFF	Motherboard resources
0xE0000000-0xEFFFFFFF	Motherboard resources
0xFD000000-0xFDABFFFF	Motherboard resources
0xFD000000-0xFE7FFFFF	PCI Express Root Complex
0xFDAC0000-0xFDACFFFF	Motherboard resources
0xFDAD0000-0xFDADFFFF	Motherboard resources
0xFD AE0000-0xFD AEFFFF	Motherboard resources
0xFDAF0000-0xFDAFFFFF	Motherboard resources
0xFDB00000-0xFDFFFFFF	Motherboard resources
0xFE000000-0xFE01FFFF	Motherboard resources
0xFE036000-0xFE03BFFF	Motherboard resources
0xFE03D000-0xFE03FFFF	Motherboard resources
0xFE40F000-0xFE40FFFF	Intel(R) Management Engine Interface
0xFE410000-0xFE7FFFFF	Motherboard resources
0xFED00000-0xFED003FF	High precision event timer
0xFED10000-0xFED17FFF	Motherboard resources
0xFED18000-0xFED18FFF	Motherboard resources
0xFED19000-0xFED19FFF	Motherboard resources
0xFED20000-0xFED3FFFF	Motherboard resources
0xFED45000-0xFED8FFFF	Motherboard resources
0xFED90000-0xFED93FFF	Motherboard resources
0xFEE00000-0xFEEFFFFFFF	Motherboard resources
0xFF000000-0xFFFFFFFF	Motherboard resources

ADVANTECH

Enabling an Intelligent Planet

www.advantech.com

Please verify specifications before quoting. This guide is intended for reference purposes only.

All product specifications are subject to change without notice.

No part of this publication may be reproduced in any form or by any means, electronic, photocopying, recording or otherwise, without prior written permission of the publisher.

All brand and product names are trademarks or registered trademarks of their respective companies.

© Advantech Co., Ltd. 2018