

User Manual

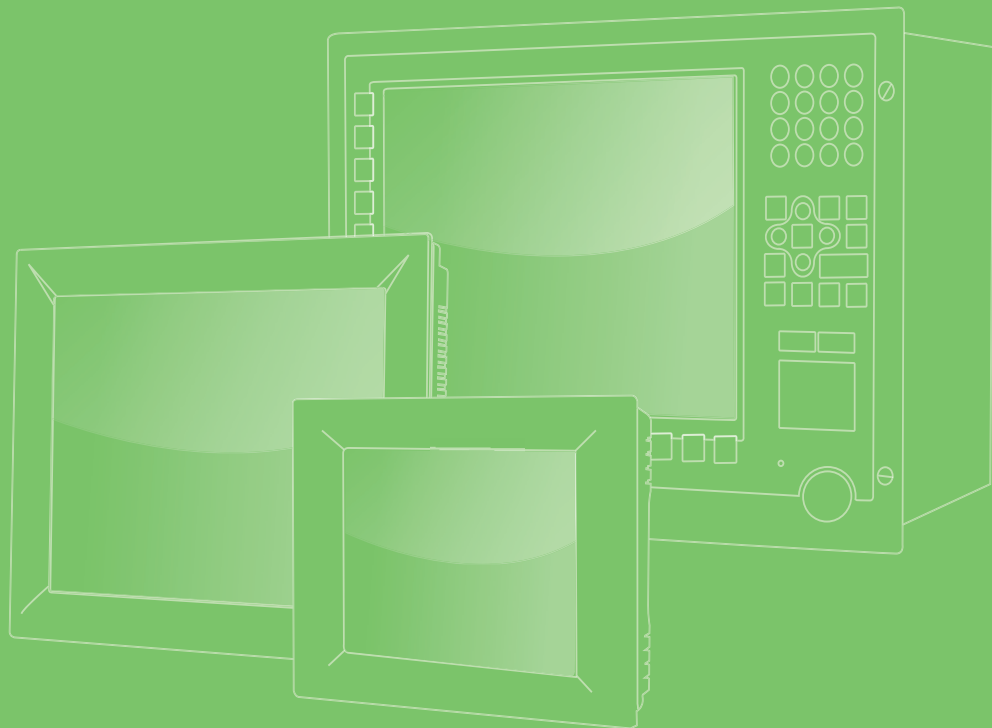

# TPC-xx51T-x3BE 電腦

Industrial Touch Panel  
Computers with Intel® Atom™  
Processors or Intel® Celeron®  
Processors

**ADVANTECH**

*Enabling an Intelligent Planet*

---

## Copyright

The documentation and the software included with this product are copyrighted 2019 by Advantech Co., Ltd. All rights are reserved. Advantech Co., Ltd. reserves the right to make improvements in the products described in this manual at any time without notice. No part of this manual may be reproduced, copied, translated or transmitted in any form or by any means without the prior written permission of Advantech Co., Ltd. Information provided in this manual is intended to be accurate and reliable. However, Advantech Co., Ltd. assumes no responsibility for its use, nor for any infringements of the rights of third parties, which may result from its use.

## Acknowledgements

Intel and Pentium are trademarks of Intel Corporation.

Microsoft Windows and MS-DOS are registered trademarks of Microsoft Corp.

All other product names or trademarks are properties of their respective owners.

This manual covers the following models:

**TPC-1251T-E3BE**

**TPC-1551T-E3BE**

## Product Warranty (2 years)

Advantech warrants to you, the original purchaser, that each of its products will be free from defects in materials and workmanship for two years from the date of purchase.

This warranty does not apply to any products which have been repaired or altered by persons other than repair personnel authorized by Advantech, or which have been subject to misuse, abuse, accident or improper installation. Advantech assumes no liability under the terms of this warranty as a consequence of such events.

Because of Advantech's high quality-control standards and rigorous testing, most of our customers never need to use our repair service. If an Advantech product is defective, it will be repaired or replaced at no charge during the warranty period. For out-of-warranty repairs, you will be billed according to the cost of replacement materials, service time and freight. Please consult your dealer for more details.

If you think you have a defective product, follow these steps:

1. Collect all the information about the problem encountered. (For example, CPU speed, Advantech products used, other hardware and software used, etc.) Note anything abnormal and list any onscreen messages you get when the problem occurs.
2. Call your dealer and describe the problem. Please have your manual, product, and any helpful information readily available.
3. If your product is diagnosed as defective, obtain an RMA (return merchandise authorization) number from your dealer. This allows us to process your return more quickly.
4. Carefully pack the defective product, a fully-completed Repair and Replacement Order Card and a photocopy proof of purchase date (such as your sales receipt) in a shippable container. A product returned without proof of the purchase date is not eligible for warranty service.

Part No. 2003025160

Printed in Taiwan

Edition 1

May 2019

5. Write the RMA number visibly on the outside of the package and ship it prepaid to your dealer.

## Declaration of Conformity

### CE

This product has passed the CE test for environmental specifications when shielded cables are used for external wiring. We recommend the use of shielded cables. This kind of cable is available from Advantech. Please contact your local supplier for ordering information.

### FCC Class A

Note: This equipment has been tested and found to comply with the limits for a Class A digital device, pursuant to part 15 of the FCC Rules. These limits are designed to provide reasonable protection against harmful interference when the equipment is operated in a commercial environment. This equipment generates, uses, and can radiate radio frequency energy and, if not installed and used in accordance with the instruction manual, may cause harmful interference to radio communications. Operation of this equipment in a residential area is likely to cause harmful interference in which case the user will be required to correct the interference at his own expense.

### 甲類警語：

警告使用者：這是甲類資訊產品，在居住的環境中使用時，可能會造成射頻干擾，在這種情況下，使用者會被要求採取某些適當對策。

## Technical Support and Assistance

1. Visit the Advantech web site at [www.advantech.com/support](http://www.advantech.com/support) where you can find the latest information about the product.
2. Contact your distributor, sales representative, or Advantech's customer service center for technical support if you need additional assistance. Please have the following information ready before you call:
  - Product name and serial number
  - Description of your peripheral attachments
  - Description of your software (operating system, version, application software, etc.)
  - A complete description of the problem
  - The exact wording of any error messages

## Warnings, Cautions and Notes

**Warning!** Warnings indicate conditions, which if not observed, can cause personal injury!



**Caution!** *Cautions are included to help you avoid damaging hardware or losing data. e.g.*



*There is a danger of a new battery exploding if it is incorrectly installed. Do not attempt to recharge, force open, or heat the battery. Replace the battery only with the same or equivalent type recommended by the manufacturer. Discard used batteries according to the manufacturer's instructions.*

**Note!** *Notes provide optional additional information.*



## Document Feedback

To assist us in making improvements to this manual, we would welcome comments and constructive criticism. Please send all such - in writing to: [support@advan-tech.com](mailto:support@advan-tech.com)

## Safety Instructions

1. Read these safety instructions carefully.
2. Keep this User Manual for later reference.
3. Disconnect this equipment from any AC outlet before cleaning. Use a damp cloth. Do not use liquid or spray detergents for cleaning.
4. For plug-in equipment, the power outlet socket must be located near the equipment and must be easily accessible.
5. Keep this equipment away from humidity.
6. Put this equipment on a reliable surface during installation. Dropping it or letting it fall may cause damage.
7. The openings on the enclosure are for air convection. Protect the equipment from overheating. **DO NOT COVER THE OPENINGS.**
8. Make sure the voltage of the power source is correct before connecting the equipment to the power outlet.
9. Position the power cord so that people cannot step on it. Do not place anything over the power cord.
10. All cautions and warnings on the equipment should be noted.
11. If the equipment is not used for a long time, disconnect it from the power source to avoid damage by transient overvoltage.
12. Never pour any liquid into an opening. This may cause fire or electrical shock.
13. Never open the equipment. For safety reasons, the equipment should be opened only by qualified service personnel.
14. If one of the following situations arises, get the equipment checked by service personnel:
  - The power cord or plug is damaged.
  - Liquid has penetrated into the equipment.
  - The equipment has been exposed to moisture.
  - The equipment does not work well, or you cannot get it to work according to the user's manual.
  - The equipment has been dropped and damaged.
  - The equipment has obvious signs of breakage.

15. DO NOT LEAVE THIS EQUIPMENT IN AN ENVIRONMENT WHERE THE STORAGE TEMPERATURE MAY GO BELOW -20° C (-4° F) OR ABOVE 60° C (140° F). THIS COULD DAMAGE THE EQUIPMENT. THE EQUIPMENT SHOULD BE IN A CONTROLLED ENVIRONMENT.
16. CAUTION: DANGER OF EXPLOSION IF BATTERY IS INCORRECTLY REPLACED. REPLACE ONLY WITH THE SAME OR EQUIVALENT TYPE RECOMMENDED BY THE MANUFACTURER, DISCARD USED BATTERIES ACCORDING TO THE MANUFACTURER'S INSTRUCTIONS.
17. The equipment is intended for installation only in a wall or cabinet where both these conditions apply: access can only be gained by SERVICE PERSONS or by USERS who have been instructed about the reasons for the restrictions applied to the location and about any precautions that shall be taken; and access is through the use of a TOOL or lock and key, or other means of security, and is controlled by the authority responsible for the location.

The sound pressure level at the operator's position according to IEC 704-1:1982 is no more than 70 dB (A).

DISCLAIMER: This set of instructions is given according to IEC 704-1. Advantech disclaims all responsibility for the accuracy of any statements contained herein.

**Caution!** *Danger of explosion if battery is incorrectly replaced. Replace only with the same or equivalent type recommended by the manufacturer. Dispose of used batteries according to the manufacturer's instructions.*



*Danger d'explosion si la pile est remplacée de façon incorrecte. Remplacez seulement avec le même type ou équivalent recommandé par le fabricant. disposer des piles usagées selon les instructions du fabricant.*

## 安全指示

1. 請仔細閱讀此安全操作說明。
2. 請妥善保存此用戶手冊供日後參考。
3. 用濕抹布清洗設備前，請確認拔除電源線。請勿使用液體或去污噴霧劑清洗設備。
4. 對於使用電源線的設備，設備周圍必須有容易接觸到的電源插座。
5. 請勿在潮濕環境中使用設備。
6. 請在安裝前確保設備放置在可靠的平面上，意外摔落可能會導致設備損壞。
7. 設備機殼的開孔適用於空氣對流，從而防止設備過熱。
8. 請勿覆蓋開孔。
9. 當您連接設備到電源插座前，請確認電源插座的電壓符合要求。
10. 請將電源線布置在人們不易絆倒的位置，請勿在電源線上覆蓋任何雜物。
11. 請注意設備上所有的警告標示。
12. 如果長時間不使用設備，請拔除與電源插座的連結，避免設備被超標的電壓波動損壞。
13. 請勿讓任何液體流入通風口，以免引起火災或短路。
14. 請勿自行打開設備。為了確保您的安全，請透過經認證的工程師來打開設備。
15. 如欲下列情況，請由專業人員維修：
  - 電源線或插頭損壞；
  - 設備內部有液體流入；
  - 設備曾暴露在過度潮濕環境中使用；
  - 設備無法正常工作，或您無法透過用戶手冊來正常工作；

- 
- 設備摔落或損壞；
  - 設備有明顯外觀損壞。
16. 請勿將設備放置在超出建議溫度範圍的環境，即不要低於  $-20^{\circ}\text{C}$  ( $-4^{\circ}\text{F}$ ) 或高於  $60^{\circ}\text{C}$  ( $140^{\circ}\text{F}$ )，否則可能會造成設備損壞。
  17. 注意：若電池更換不正確，將有爆炸危險。因此，只可以使用製造商推薦的同一種或者同等型號的電池進行替換。請按照製造商的指示處理舊電池。
  18. 根據 IEC 704-1:1982 規定，操作員所在位置音量不可高於 70 分貝。
  19. 限制區域：請勿將設備安裝於限制區域使用。
  20. 免責聲明：該安全指示符合 IEC 704-1 要求。研華公司對其內容之準確性不承擔任何法律責任。
  21. 使用過度恐傷害視力。使用 30 分鐘請休息 10 分鐘。
  22. 未滿 2 歲幼兒不看螢幕，2 歲以上每天看螢幕不要超過 1 小時。
  23. 本產品於國內裝置使用時，其電源僅限使用機架電源模組所提供直流電源輸入，不得使用交流電源及附加其他電源轉換裝置提供電源，其電源輸入電壓及電流請依說明書規定使用。

# Contents

<b>Chapter 1</b>	<b>General Information .....</b>	<b>1</b>
1.1	Introduction .....	2
1.2	Specifications .....	2
1.2.1	System Kernel.....	2
1.2.2	I/O Ports.....	2
1.2.3	O/S support.....	2
1.2.4	Safety and Environment.....	3
1.3	LCD Specifications.....	3
	Table 1.1: LCD Specifications .....	3
1.4	Touchscreen Specifications .....	4
1.5	Power .....	4
1.6	I/O Port Arrangement.....	4
	Figure 1.1 I/O Port Arrangement .....	4
1.7	Panel Mounting .....	5
1.8	Dimensions and Cutout.....	5
	Figure 1.2 TPC-1551T Dimensions .....	6
	Figure 1.3 TPC-1251T Dimensions .....	7
<b>Chapter 2</b>	<b>System Setup .....</b>	<b>9</b>
2.1	Transport and Unpacking.....	10
2.2	System Setup .....	11
	Figure 2.1 Unpack the Package .....	11
	Figure 2.2 Power Connector and Power Lines .....	12
	Figure 2.3 Power Receptor & Button Pin Assignment .....	12
2.2.1	Installing the Drivers .....	13
2.3	Panel Mounting .....	13
2.4	VESA Mounting.....	14
2.5	Cabinet Installation and Earth Grounding setup .....	15
2.6	Power/Digital Ground and Earth/Ground .....	16
<b>Chapter 3</b>	<b>Features in Windows Embedded .....</b>	<b>17</b>
3.1	Features in Windows Embedded .....	18
3.2	Enhanced Write Filter (EWF) .....	18
3.3	File-Based Write Filter (FBWF).....	19
3.4	HORM .....	20
<b>Appendix A</b>	<b>Serial Port Settings .....</b>	<b>23</b>
A.1	Jumper, Dip switch and Connector location.....	24
A.1.1	Board Placement .....	24
A.2	Jumper setting and Description.....	24
A.2.1	CMOS Clear Function (CN1) .....	24
	Table A.1: CMOS Clear Function (CN1).....	24
A.3	Connector Pin Definition .....	25
A.3.1	SATA connector (CN12).....	25
	Table A.2: 1654004659 Serial ATA 7P 1.27mm 180D(M) DIP WATM-07DBN4A3B83.12 .....	25
A.3.2	SATA Power connector (CN8).....	25
	Table A.3: WAFER BOX 4P 2.50mm 180D(M) DIP 24W1170- 04S10-01 .....	25

A.3.3	Mini PCIE slot (MINIPCIE).....	26
	Table A.4: 1654002538 MINI PCI E 52P 6.8mm 90D SMD AS0B226-S68N7H Supports PCI1.1, PCI1.2 Power Definition .....	26
A.3.4	Power in connector (CN18) .....	27
	Table A.5: 1652003104 PLUG-IN BLOCK 3P 5.08mm 90D(M) DIP ME050-50803.....	27
A.3.5	LAN RJ45 connector (CN7,CN8).....	28
	Table A.6: 1652002996 PHONE JACK RJ45 14P 90D(M) DIP RTA-195AAK1A .....	28
	Table A.7: LED .....	28
A.3.6	USB connector (CN10).....	28
	Table A.8: 1654010199 USB Conn. 2.0+3.0 13P 90D(F) DIP UEA1112C-UHS6-4 .....	28
A.3.7	COM1 RS232 connector (CN15).....	29
	Table A.9: 1654000056 D-SUB Conn. 9P 90D(M) DIP 070241MR009S200ZU.....	29
A.3.8	COM2 RS232/422/485 connector (CN16).....	29
	Table A.10:1654000056 D-SUB Conn. 9P 90D(M) DIP 070241MR009S200ZU.....	29

## Appendix B Driver Installation and Configuration.. 31

B.1	Intel Chipset Software Installation Utility Installation.....	32
B.2	Intel Graphics Driver Installation .....	34
B.3	LAN Driver Installation .....	36
B.4	Intel® Trusted Execution Engine DriverInstallation.....	39
B.5	Windows 7 USB 3.0 Driver Installation .....	41
B.6	Advantech EC Driver Installation .....	44
B.7	Advantech EC Brightness Control Tool Installation .....	46
B.8	Advantech EC Watchdog Timer Driver Installation.....	48
B.9	Advantech LMsensor Driver Installation .....	51

## Appendix C BIOS Setup ..... 53

C.1	Entering Setup .....	54
	C.1.1 Main Setup.....	54
	C.1.2 Advanced BIOS Features Setup.....	56
	C.1.3 Chipset Configuration .....	68
	C.1.4 Security.....	69
	C.1.5 Boot .....	70
	C.1.6 Save & Exit .....	71



# Chapter 1

General Information

## 1.1 Introduction

The TPC-XX51T Touch Panel Computer is a state-of-the-art Human Machine Interface featuring displays ranging from 12" and 15" and Intel Atom™ E3845 1.9 GHz / Intel® Celeron J1900 2.0GHz Quad-core Processor.

**The key features are as follows:**

- **True-flat touch screen**  
The TPC-XX51T is a true-flat touch screen designed with IP66 front protection.
- **Fanless**  
By using a low-power processor, the system does not have to rely on fans, which often are unreliable and cause dust to circulate inside the equipment.
- **Wide operating temperature (E38xx series only)**  
The TPC-XX51T series supports -20 ~ 60°C wide operating temperature solution to provide flexibility in harsh environments.
- **Bright Display**  
The TFT LED LCD display suits industrial demands for clear interfaces. Wide Operating Temperature & Isolation Protection.

## 1.2 Specifications

### 1.2.1 System Kernel

- **CPU:** Intel® Atom™ E3845 1.9 GHz Processor /(Optional) Intel® Celeron J1900 2 GHz Quad-core Processor
- **BIOS:** AMI UEFI BIOS
- **VGA:** Integrated in Intel® Atom™ E3845 /Intel® Celeron J1900 2 GHz Quad-core Processor
- **Ethernet:** 10/100/1000Base-T x 2
- **Watchdog Timer:** EC watchdog timer; 1.0 second timeout
- **Storage:**  
mSATA via mPCIe  
2.5" SATA HDD/SSD slot x

### 1.2.2 I/O Ports

- 1 x RS-232, 1 x RS-232/422/485
- 1 x USB 3.0
- 3 x USB 2.0
- 1 x Full-size Mini PCIe Card supporting mSATA storage

### 1.2.3 O/S support

- Microsoft® Windows
  - WES7 64-bit
  - WEC7 (IDE configuration must set SATA Mode to IDE Mode in BIOS for booting successfully)
  - Windows 7 32-bit/64-bit
  - Windows 10 32-bit/64-bit

## 1.2.4 Safety and Environment

### Safety

- FCC Class A
- CE certificated
- The front bezel is compliant with IP66 for true flat models and IP65 for the TPCs with the traditional front bezel

### Environment

- **Operating Temperature:**
  - -20 ~ 60°C (-4 ~ 140°F)
- **Storage Temperature:**
  - -30 ~ 70°C (-22 ~ 158°F)
- **Humidity:** 40°C @ 10~95% relative humidity (non-condensing)
- **Vibration:**
  - With SSD:** 1 Grms (5 ~ 500 Hz) (Operating, random vibration)

## 1.3 LCD Specifications

**Table 1.1: LCD Specifications**

	TPC-1251T	TPC-1551T
Display Type	TFT LED LCD	TFT LED LCD
Size	12.1"	15"
Maximum Resolution	1024 x 768 (XGA)	1024 x 768 (XGA)
Maximum Colors	262K/16.2 M	1.62M
Viewing Angle (CR≥10)	160°/140°	176°/176°
Luminance (cd / m2)	500	300
Contrast Ratio	700:1	2000:1
Operating Temperature	-30 ~ 70°C	-30 ~ 80°C
Backlight Lifetime	50,000 hours	70,000 hours
Backlight	LED	LED

**Note!** *There might be several bright or dark pixels on the LCD. This phenomenon is normal in today's LCD manufacturing. Inspection criteria are following specifications defined by LCD vendor.*



## 1.4 Touchscreen Specifications

- **Touch Type:** 5- wire Resistive
- **Base Glass Construction:** Tempered glass
- **Resolution:** (follows the resolution of the system)
- **Light Transmission:** 80% ± 3% (Measured by BYK-Gardner)
- **Controller:** USB Interface
- **Lifespan:** 1 million touches at single point

**Note!** Touchscreen ITO maybe crash duo to heavy usage.



## 1.5 Power

- **Input Voltage:** 24V<sub>DC</sub> +/- 20% (the fuse will become an open circuit if the input level exceeds 32 V<sub>DC</sub>)
- **Typical:**
  - TPC-1251T: 24 V<sub>DC</sub> @ 1.9Amp
  - TPC-1551T: 24 V<sub>DC</sub> @ 1.7Amp

## 1.6 I/O Port Arrangement

The arrangement of the I/O ports is shown in Figure 1.1

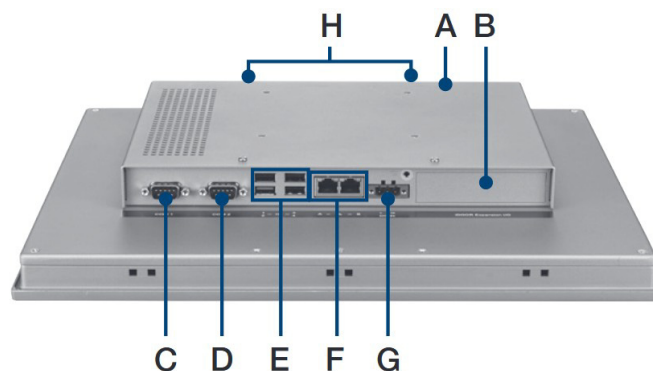

- |                        |                      |
|------------------------|----------------------|
| A. Default HDD/SSD Bay | E. USB 2.0 & 3.0     |
| B. iDoor slot          | F. LAN (10/100/1000) |
| C. RS-232              | G. Power Receptor    |
| D. RS-232/422/485      | H. Antenna Opening   |

**Figure 1.1 I/O Port Arrangement**

## 1.7 Panel Mounting

1. There is a rubber waterproof gasket on the AL front bezel. Make sure the waterproof gasket is in position before installing TPC into the panel opening.
2. Install the TPC into the panel opening.
3. Take the clamps and long screws from the accessory box. Hook the clamps to the holes around the four sides of the bezel. Insert the screws into every clamp and fasten them. These screws will push the mounting panel and fix the unit.
4. The suggested mounting panel thickness is less than 6 mm (0.236").

## 1.8 Dimensions and Cutout

### TPC-1251T Series

- **Weight:** 2.55kg
- **Dimensions (W x H x D):** 311.8 x 301.6 x 55.4 (12.28" x 11.87" x 2.18")
- **Cutout:** 303 x 229 mm (11.93 x 9.02 in)

### TPC-1551T Series

- **Weight:** 3.9 kg
- **Dimensions (W x H x D):** 383.2 x 307.3 x 61.1 mm (15.09" x 12.10" x 2.41")
- **Cutout:** 374.5 x 298.5 mm (14.74 x 11.75 in)

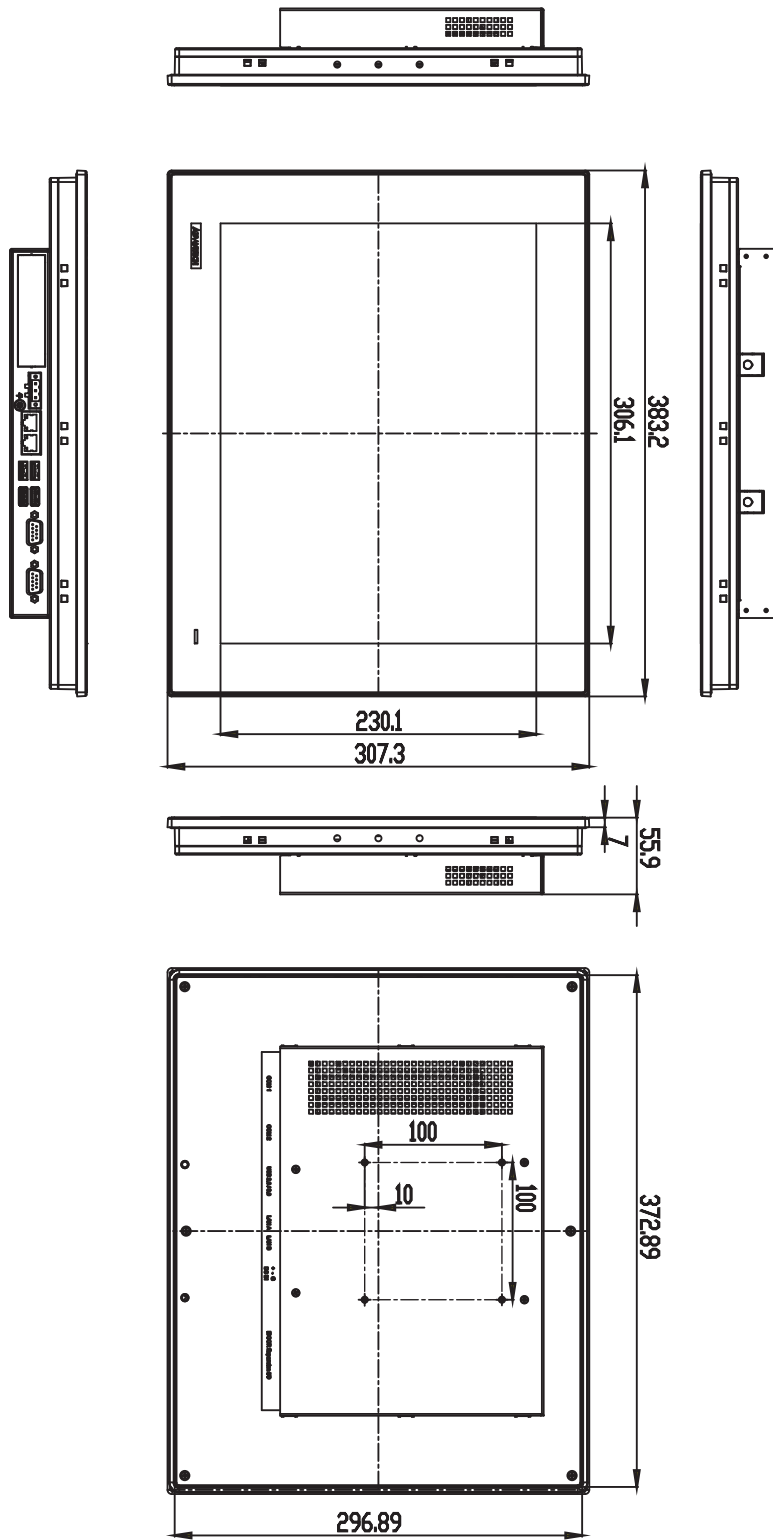

**Figure 1.2 TPC-1551T Dimensions**

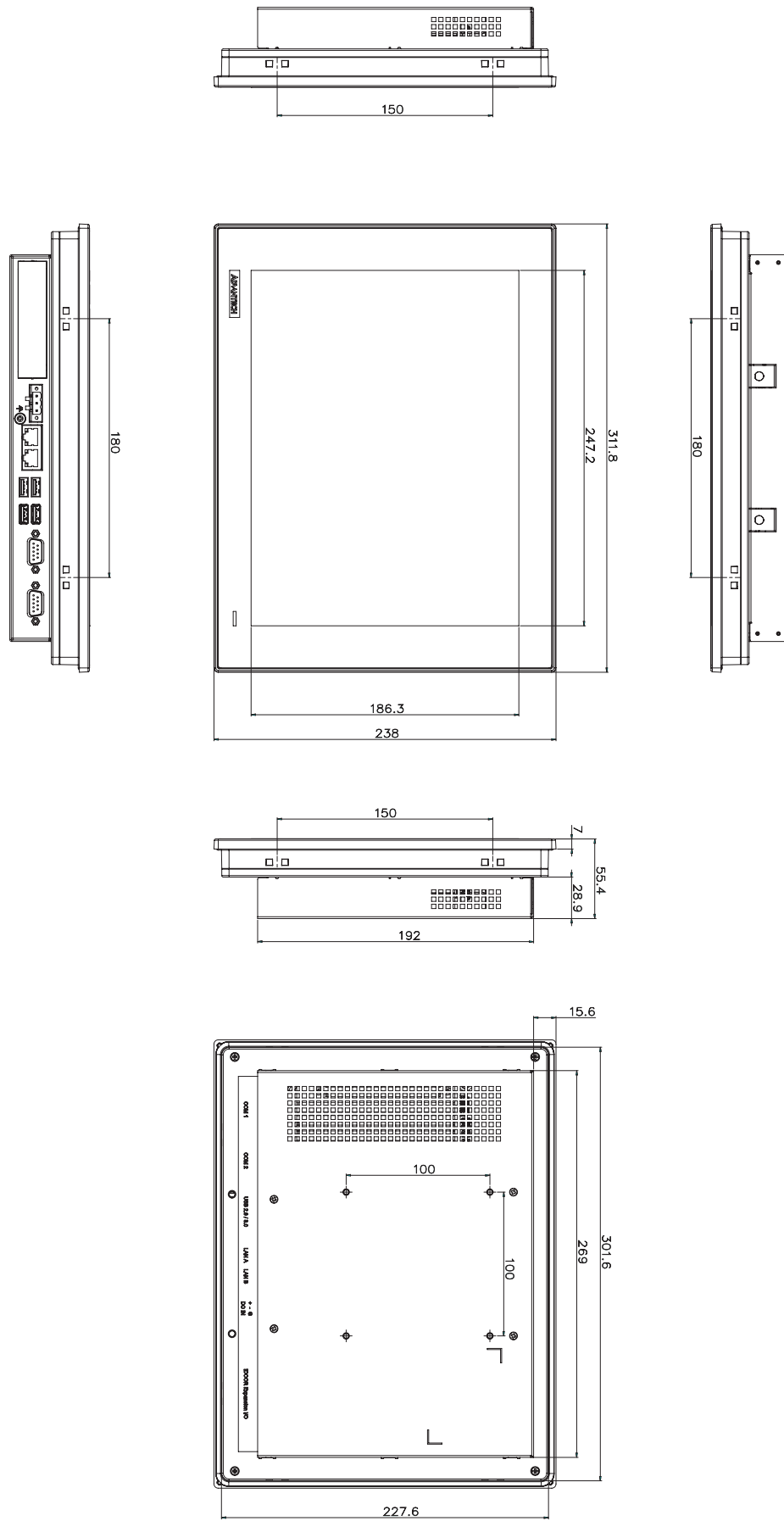

Figure 1.3 TPC-1251T Dimensions





# Chapter 2

System Setup

---

## 2.1 Transport and Unpacking

When accepting a delivery, please check the packaging for visible transport damage and check the delivery for completeness by comparing it with your order. If you notice any shipping damage or inconsistencies between the contents and your order, please inform the responsible delivery service immediately.

During transportation, the TPC should be protected from excessive mechanical stress. If the TPC is transported or stored without packaging, shocks, vibrations, pressure and moisture may impact the unprotected unit. A damaged packaging indicates that ambient conditions have already had a massive impact on the device. Therefore, please use the original packaging during transportation and storage.

If the TPC is transported in cold weather or is exposed to extreme variations in temperature, make sure that moisture (condensation) does not build up on or inside the HMI device. Moisture can result in short-circuits in electrical circuits and damage the device. To avoid that, please store the TPC in a dry place and bring the TPC to room temperature before starting it up. If condensation occurs, a delay time of approximately 12 hours must be allowed to make sure the TPC is completely dry before the TPC is switched on.

## 2.2 System Setup

You can easily get TPC started by following the steps below.

1. Unpack the TPC package. Check the packing list at the beginning of this manual to make sure all items have been included.



**Figure 2.1 Unpack the Package**

2. Connect the power connector to the 24 V<sub>DC</sub> power lines. The power lines can either be of some power adapter or in-house power source.

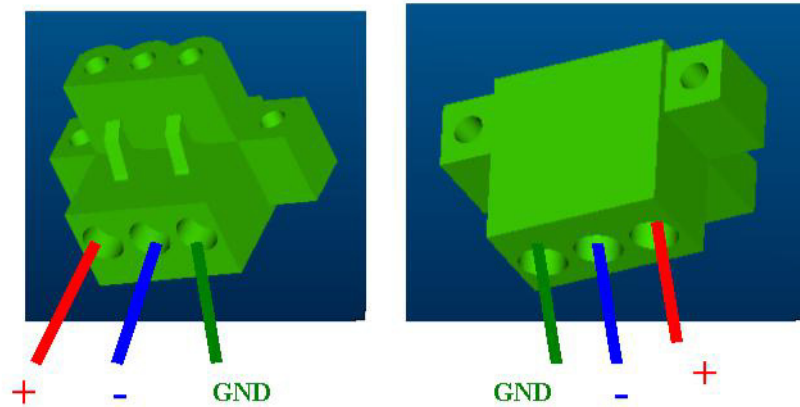

**Figure 2.2 Power Connector and Power Lines**



**Figure 2.3 Power Receptor & Button Pin Assignment**

3. Plug the power lines into the system power receptor.
4. Attach power to the system.
5. Calibrate the touchscreen.

**Note!** If you want to install the touchscreen driver & use the touchscreen utility, please refer the user manual "PenMount 6000 Installation-Guide" on the CD-ROM.



## 2.2.1 Installing the Drivers

Please go to Advantech's official website for downloading product information and drivers.

**Note!** *The drivers and utilities used for the panel PCs are subject to change without notice. If in doubt, check Advantech's website or contact our application engineers for the latest information regarding drivers and utilities.*



## 2.3 Panel Mounting

1. Position the TPC against the panel.

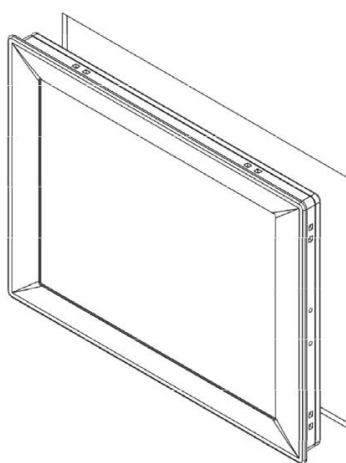

2. Insert the clamps into the side of the TPC.

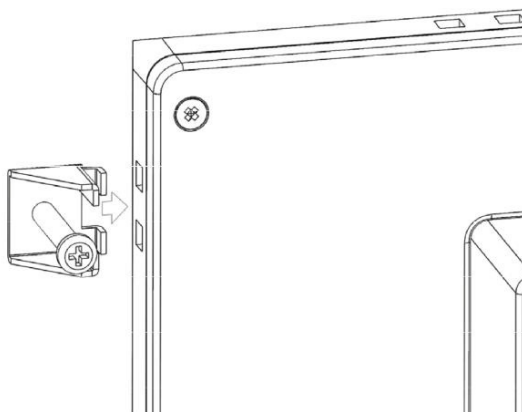

3. Secure the clamp to the panel using the included screws.

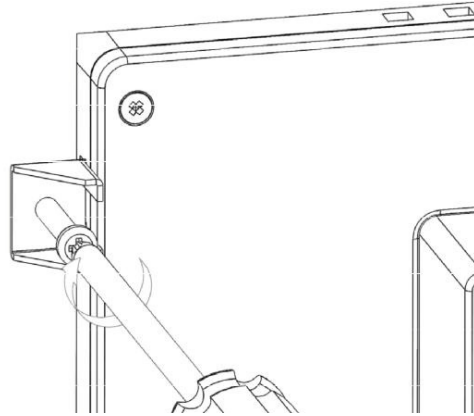

## 2.4 VESA Mounting

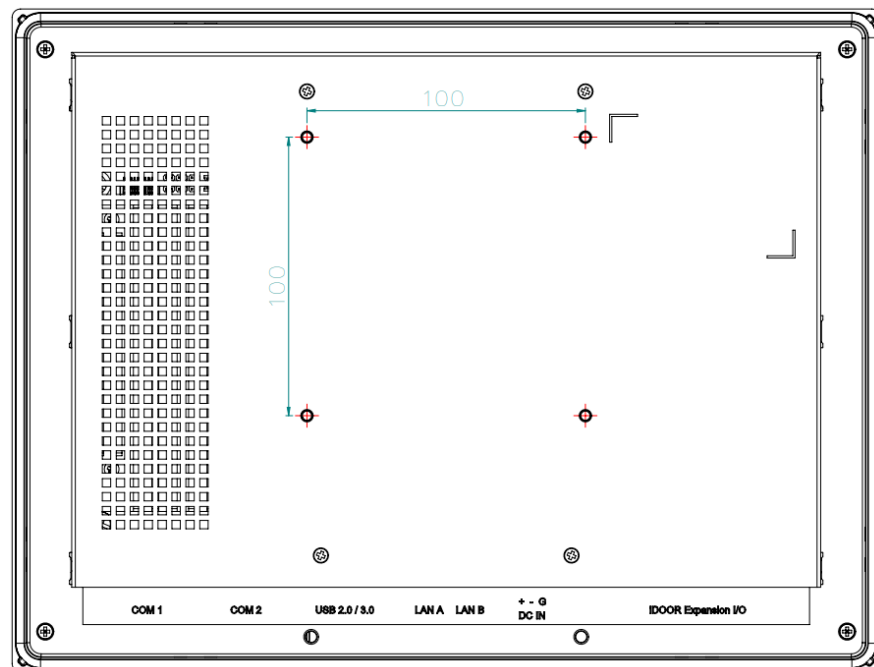

1. TPC-xx51T-x3BE supports VESA 100x100 standard
2. M4 x 10 screws are recommended for mounting TPC-xx51T-E3BE with VESA mounting equipment
3. Affix your VESA mounting equipment to the top of the rear side of TPC-xx51T-x3BE and fasten VESA equipment with TPC-xx51T-x3BE using 4pcs of M4 screws.

## 2.5 Cabinet Installation and Earth Grounding setup

Follow these steps to setup your TPC system, and pay attention to the ground pin which should be connected to the earth/ground. TPC system should give the best performance for EMI immunity, ESD immunity, Surge immunity and also system isolation. If the TPC system is embedded in the cabinet, the TPC system's ground, cabinet's ground and earth/ground should be connected together.

1. Install the TPC system into the cabinet.

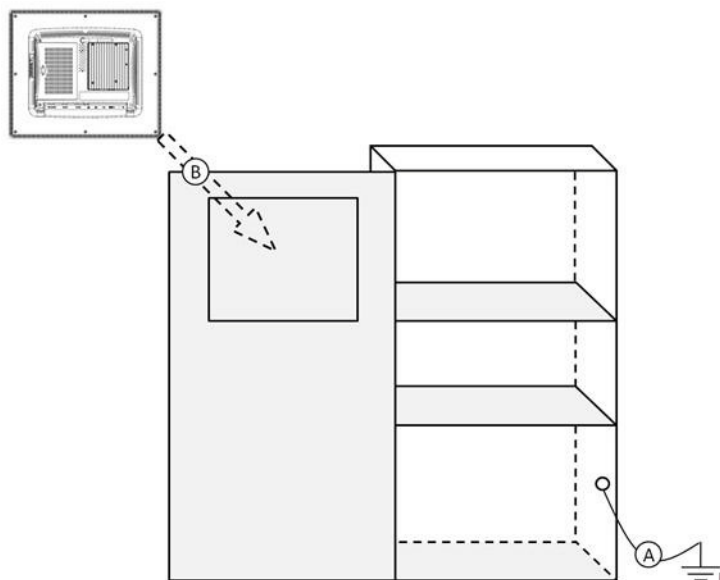

Step A: Connect the cabinet to the earth/ground.

Step B: Embed null TPC system into the cabinet without any I/O cable and power.

2. System wiring.

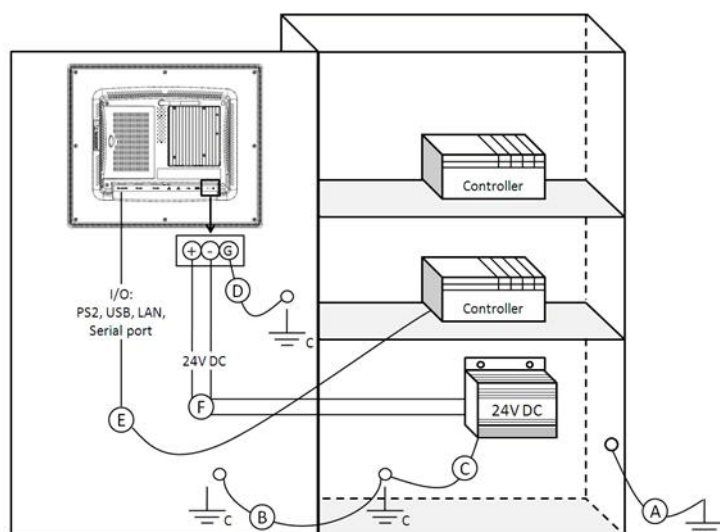

Step A: Connect the cabinet to the earth/ground.

Step B: Ensure that all cabinets have been grounded together.

Step C: Connect the ground of the power supply to the cabinet.

Step D: Connect the ground pin of TPC system to the cabinet.

Step E: Connect the I/O to the controller if needed.

Step F: Connect the V+ and V- of power supply to TPC system.

After completing steps A to F, you can supply power to the TPC system.

**Note!** Make sure all wires follow the installation guidelines or it may cause issues.



**Note!** If you install a USB device or Mini PCIe card on the TPC system, please double check the voltage between V- and earth/ground, if the voltage is not almost equal with each other, we suggest to short V- and earth/ground the wiring.



## 2.6 Power/Digital Ground and Earth/Ground

The purpose is to block all the external electrical interference on the chassis, and prevent any possibility of bad grounding design that could cause electric shocks. This is so called level 1 isolation which consumer PCs do not normally implement.

- TPC Chassis and Earth (Power pin3) are short,
- TPC Chassis and Power / Digital GND are OPEN

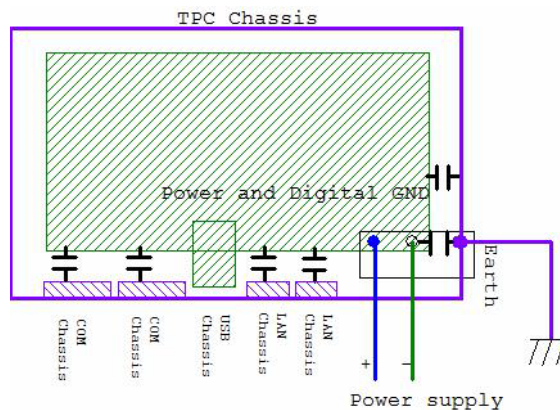

The TPC is an industrial grade product, designed to prevent external interference and the possibility of electric shock. To complete the isolation design, we need to consider the following:

- The Ethernet is isolated, a LAN connection will not impact the isolation design.
- For general USB devices, to solve EMI and ESD issues, they are designed as a chassis and digital short. But the TPC prevents damage to USB devices, ESD and EMI solutions are designed to use the Power GND as a vent path to ensure Power GND and Chassis GND will not have potential difference abnormalities.
- For COM ports, since there are different COM port designs, long distance connection causes voltage level differences between the two COM port chassis. So the shell ground of the cable must be isolated to the signal digital ground.

In real cases, many customers may break the level 1 isolation by 3rd party Device or cable design, in this situation, we need to consider making all the GND short (Power GND/Digital GND/Earth GND), and ensure customers have good earth/GND connection.



# Chapter 3

Features in Windows  
Embedded

## 3.1 Features in Windows Embedded

TPC product supports the embedded Windows platform. This section outlines the important features (EWF, FBWF and HORM), that are provided in WES7 and UWF provided in WE8S.

## 3.2 Enhanced Write Filter (EWF)

Enhanced Write Filter (EWF) and File-Based Write Filter (FBWF) redirect all writes targeted at protected volumes to a RAM or disk cache, called an overlay. The overlay stores changes made to the operating system, but is removed when the device is restarted, restoring the device to its original state. Note that there is no disk-based overlay support for Windows Embedded Standard 7.

EWF works at the sector level on protected disks and allows you to commit changes so that they persist when the device is restarted. EWF is useful for thin clients that do not need to store cached information or receive frequent updates. Changes made to a system protected by EWF are stored in one or more layers that represent snapshots in time. Applying changes to an image applies all changes made to the operating system during a specific period of time.

Advantech provides a utility to operate EWF. Refer to the steps below if you want to enable.

1. Click **Start Menu->All Programs->Advantech->AdvWF** and click **EWF Utility**



2. Click the **EFW tab**, and click **Enable** button
3. After the system has rebooted automatically, EWF will be enabled.

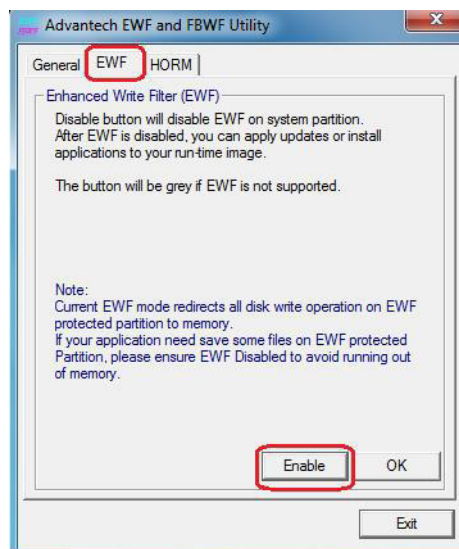

### 3.3 File-Based Write Filter (FBWF)

File-Based Write Filter (FBWF) works at the file level instead of the sector level on protected disks. By default, FBWF protects the whole disk, but selective write through exceptions can be granted to specific files and folders. Writes to folders with write-through exceptions will be persisted when the device restarts.

Advantech provides a utility to operate FBWF. Refer to the steps below if you want to enable it.

1. Click **Start Menu->All Programs->Advantech->AdvWF** and click **FBWFUtility**

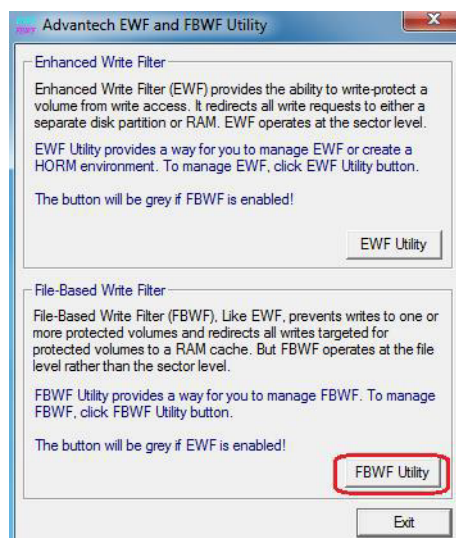

2. Move the volume you want to protect from "Available Volume" to "Protected Volume" and choose "Write-Through Files and Folders"

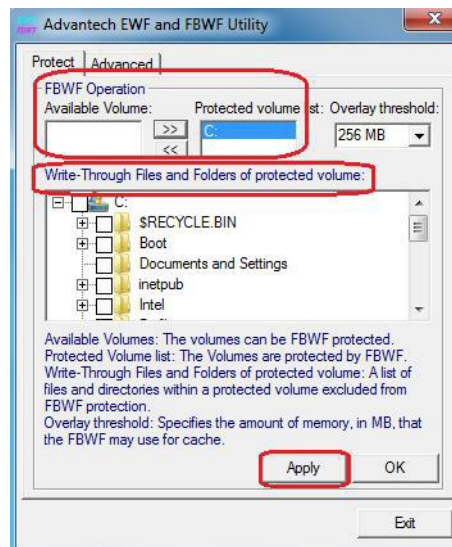

3. Click "**Apply**", and the system is rebooted automatically. Then FBWF will be enabled.

## 3.4 HORM

HORM stands for Hibernate Once Resume Many. In HORM environment, a single hibernation file is used to boot the system repeatedly. To set a HORM environment, please follow the steps below.

1. Make sure EWF is disabled. You can run OSUnLock to disable EWF.
2. Enable hibernation support: Open the command prompt and type "powercfg -h on"
3. Run "power options" in control panel, and then select "Enable Hibernation" in hibernation pane.

### Enable EWF:

1. Run OSLock, and then system reboot automatically.
2. Open those software that customers want to directly use after system resumes from hibernation.
3. Hibernates via Advantech HORM utility:
  1. Click **Start Menu->All Programs->Advantech->AdvWF**
  2. Select "Enable Hibernation" in "Power Options".
  3. Open AdvWF and enable EWF
  4. After the system is rebooted automatically, open AdvWF and click EWF Utility.
  5. Click HORM tab, and click "HORM" button.

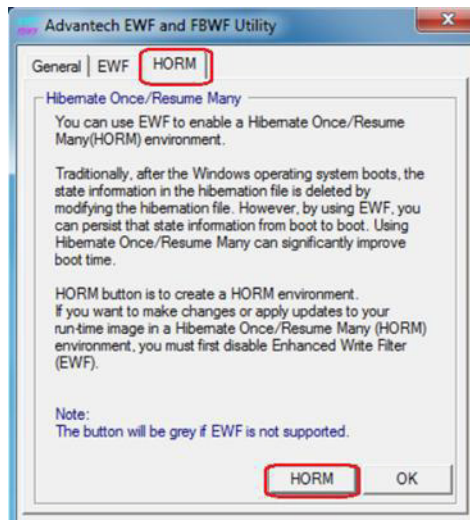



# Appendix **A**

## Serial Port Settings

# A.1 Jumper, Dip switch and Connector location

## A.1.1 Board Placement

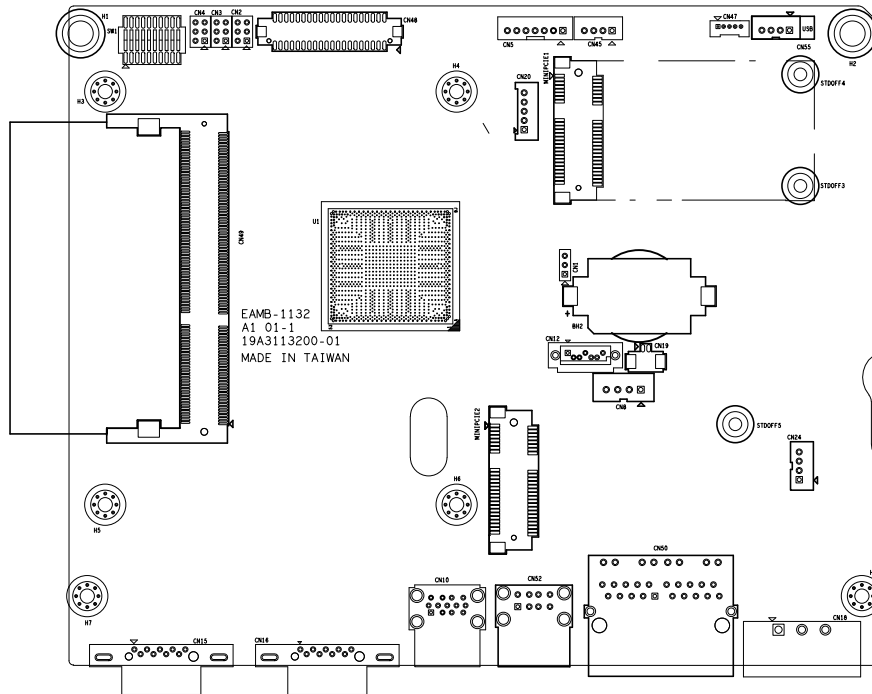

# A.2 Jumper setting and Description

## A.2.1 CMOS Clear Function (CN1)

**Table A.1: CMOS Clear Function (CN1)**

CMOS Clear Function	
<b>Description</b>	This jumper is used to select CMOS Clear Enable/Disable
<b>Default</b>	(1-2)
<b>(2-3)</b>	Enable (Clear CMOS)
<b>(1-2)</b>	Disable

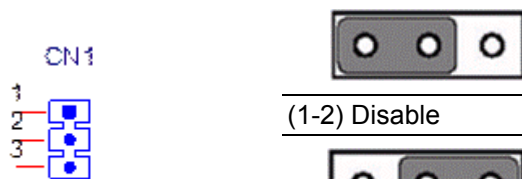

(1-2) Disable



(2-3) Enable (Clear CMOS)



## A.3 Connector Pin Definition

### A.3.1 SATA connector (CN12)

**Table A.2: 1654004659 Serial ATA 7P 1.27mm 180D(M) DIP WATM-07DBN4A3B83.12**

Pin	Signal	Description
1	GND	GND
2	A+	Signal Pair A : TX+/-
3	A-	(Transmit)
4	GND	GND
5	B-	Signal Pair B : RX+/-
6	B+	(Receive)
7	GND	GND

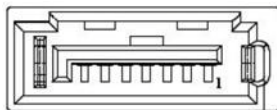

### A.3.2 SATA Power connector (CN8)

**Table A.3: WAFER BOX 4P 2.50mm 180D(M) DIP 24W1170-04S10-01**

Pin	Signal	Description
1	+V5SATA	SATA power output 5V/1A
2	GND	GND
3	GND	GND
4	+V3.3SATA	SATA power output 3.3V/1A



### A.3.3 Mini PCIE slot (MINIPCIE)

**Table A.4: 1654002538 MINI PCI E 52P 6.8mm 90D SMD AS0B226-S68N7H Supports PCI1.1, PCI1.2 Power Definition**

Pin	Signal	Description	Pin	Signal	Description
52	+3.3Vaux / +3.3V	PCI1.1 was +3.3V, PCI1.2 was +3.3Vaux	51	Reserved	NC
50	GND		49	Reserved	NC
48	+1.5V		47	Reserved	NC
46	NC	NC	45	Reserved	NC
44	NC	NC	43	PIN43_MPCIE_ PWRSEL	The pin to select the Pin 2, 52 power output for +3.3Vaux or +3.3V (PCI1.1 was Reserved and PIC1.2 was GND
42	NC	NC	41	+3.3Vaux	
40	GND		39	+3.3Vaux	
38	USB_D+	USB serial data inter- face compliant to	37	GND	
36	USB_D-	the USB 2.0 specifi- cation	35	GND	
34	GND		33	PETp0	PCI Express differential trans- mit pair
32	SMB_DATA	SMBus data signal compliant to the	31	PETn0	
30	SMB_CLK	SMBus 2.0 specifica- tion	29	GND	
28	+1.5V		27	GND	
26	GND		25	PERp0	PCI Express dif- ferential receive pair
24	+3.3Vaux		23	PERn0	
22	PERST#	Functional reset to the card	21	GND	
20	W_DISABLE #	Active low signal. This signal is used by the system to disable radio operation on add-in cards that implement radio fre- quency applications. When implemented, this signal requires a pull-up resistor on the card.	19	Reserved	NC
18	GND		17	Reserved	NC
	Key	Key		Key	Key
16	NC	NC	15	GND	
14	NC	NC	13	REFCLK+	

**Table A.4: 1654002538 MINI PCI E 52P 6.8mm 90D SMD AS0B226-S68N7H Supports PCI1.1, PCI1.2 Power Definition**

12	NC	NC	11	REFCLK-	
10	NC	NC	9	GND	
8	NC	NC	7	CLKREQ#	Reference clock request signal
6	1.5V		5	NC	NC
4	GND		3	NC	NC
2	+3.3Vaux / +3.3V	PCI1.1 was +3.3V, PCI1.2 was +3.3Vaux	1	WAKE#	Open Drain active Low signal. This signal is used to request that the system return from a sleep/suspended state to service a function initiated wake event.

\*+3.3Vaux was suspend Power, power out to device +3.3V/1.1A

\*+3.3V was core power

\*+1.5V was core power, power out to device +1.5V/0.5A

### A.3.4 Power in connector (CN18)

**Table A.5: 1652003104 PLUG-IN BLOCK 3P 5.08mm 90D(M) DIP ME050-50803**

Pin	Signal	Description
1	Power IN V+	24V <sub>DC</sub> +-20% Power in
2	Power IN V- (GND)	
3	GND_EARTH	The GND_EARTH to connect a Screw hole for short with the chassis GND

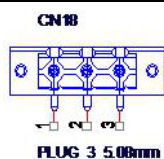

### A.3.5 LAN RJ45 connector (CN7,CN8)

**Table A.6: 1652002996 PHONE JACK RJ45 14P 90D(M) DIP RTA-195AAK1A**

RJ45 Pin	Signal	Description
1	MDI0+	<ul style="list-style-type: none"> <li>In BASE-T: Media Dependent Interface[0]:</li> <li>1000BASE-T: In MDI configuration, MDI[0]+/- corresponds to BI_DA+/- and in MDI-X configuration MDI[0]+/- corresponds to BI_DB+/-.</li> </ul>
2	MDI0-	<ul style="list-style-type: none"> <li>10BASE-T and 100BASE-TX: In MDI configuration, MDI[0]+/- is used for the transmit pair and in MDIX configuration MDI[0]+/- is used for the receive pair.</li> </ul>
3	MDI1+	<ul style="list-style-type: none"> <li>In BASE-T: Media Dependent Interface[1]:</li> <li>1000BASE-T: In MDI configuration, MDI[1]+/- corresponds to BI_DB+ and in MDI-X configuration MDI[1]+/- corresponds to BI_DA+/-.</li> </ul>
6	MDI1-	<ul style="list-style-type: none"> <li>10BASE-T and 100BASE-TX: In MDI configuration, MDI[1]+/- is used for the receive pair and in MDI-X configuration MDI[1]+/- is used for the transmit pair.</li> </ul>
4	MDI2+	In BASE-T: Media Dependent Interface[3:2]:
5	MDI2-	1000BASE-T: In MDI and in MDI-X configuration, MDI[2]+/- corresponds to BI_DC+/- and MDI[3]+/- corresponds to BI_DD+/-.
7	MDI3+	
8	MDI3-	<ul style="list-style-type: none"> <li>100BASE-TX: Unused.</li> <li>10BASE-T: Unused.</li> </ul>

**Table A.7: LED**

Left LED		Right LED	
10Link	100Link	1000 Link	Active
Off	Orange	Green	Green

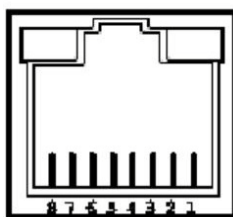

### A.3.6 USB connector (CN10)

**Table A.8: 1654010199 USB Conn. 2.0+3.0 13P 90D(F) DIP UEA1112C-UHS6-4**

Pin	Signal	Description
1, 10	USB VBUS	USB Power output, USB2.0 5V/0.5A and USB3.0 5V/0.9A
2, 11	USB_P-	USB2.0 data -
3, 12	USB_P+	USB2.0 data +
4,13	GND	Ground for Power return

**Table A.8: 1654010199 USB Conn. 2.0+3.0 13P 90D(F) DIP UEA1112C-UHS6-4**

5	SSRX-	USB3.0 RX -
6	SSRX+	USB3.0 RX +
7	GND_DRAIN	Ground for signal return
8	SSTX-	USB3.0 TX -
9	SSTX+	USB3.0 TX +

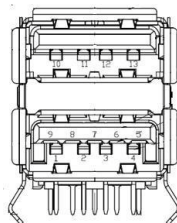

### A.3.7 COM1 RS232 connector (CN15)

**Table A.9: 1654000056 D-SUB Conn. 9P 90D(M) DIP 070241MR009S200ZU**

Pin	RS232
1	DCD
2	RX
3	TX
4	DTR
5	GND
6	DSR
7	RTS
8	CTS
9	RI

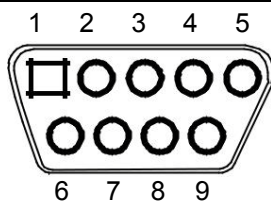

### A.3.8 COM2 RS232/422/485 connector (CN16)

**Table A.10: 1654000056 D-SUB Conn. 9P 90D(M) DIP 070241MR009S200ZU**

Pin	RS232	RS422	RS485
1	DCD	TX-	D-
2	RX	TX+	D+
3	TX	RX+	
4	DTR	RX-	
5	GND	GND	GND
6	DSR		

**Table A.10: 1654000056 D-SUB Conn. 9P 90D(M) DIP  
070241MR009S200ZU**

7	RTS
8	CTS
9	RI

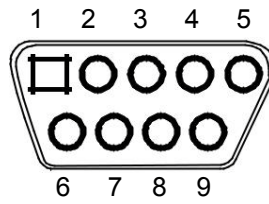

# Appendix **B**

## Driver Installation and Configuration

## B.1 Intel Chipset Software Installation Utility Installation

Follow the steps below to install the Intel Chipset Software Installation Utility:

1. Launch <Driver Root Path>\Intel Chipset Software Installation Utility\SetupChipset\_XX.X.XX\_PV
2. Install SetupChipset.exe

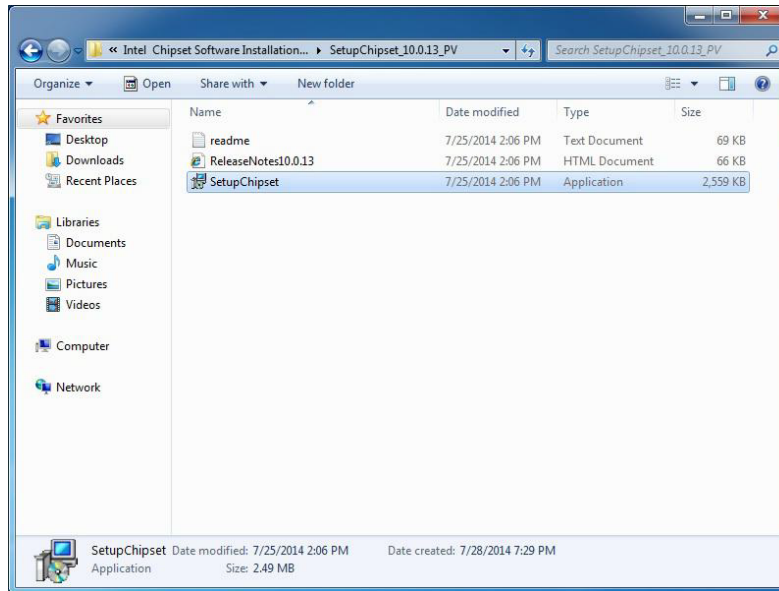

3. Click **Next**





4. Click **Accept**



5. Click **Install**

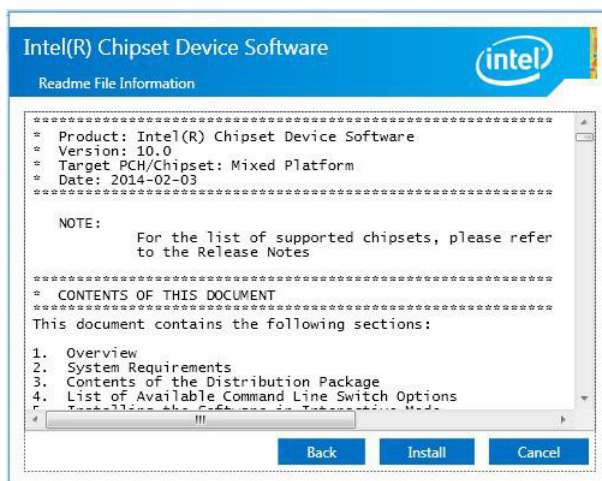

6. Click **Finish**



## B.2 Intel Graphics Driver Installation

Follow the steps below to install the Intel Graphics driver:

1. Launch folder <Driver Root Path>\Graphics Driver\Intel EMGD win7 XX bit\
2. Install Setp.exe

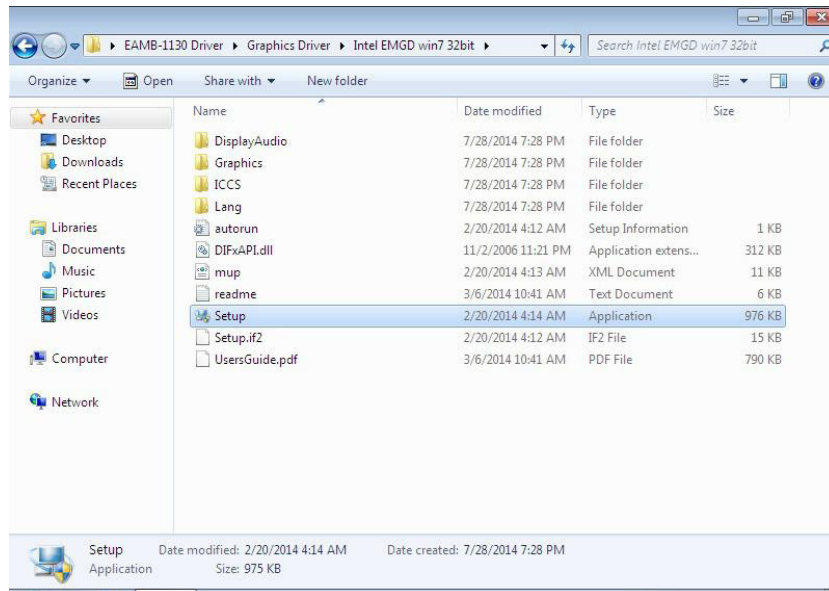

3. Click **Next**

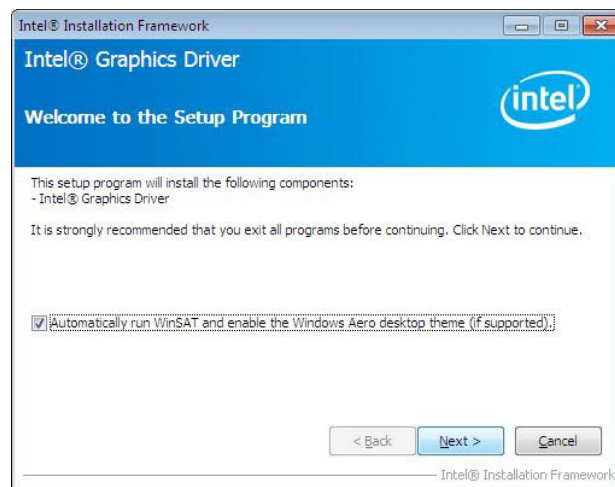

4. Click **Yes**

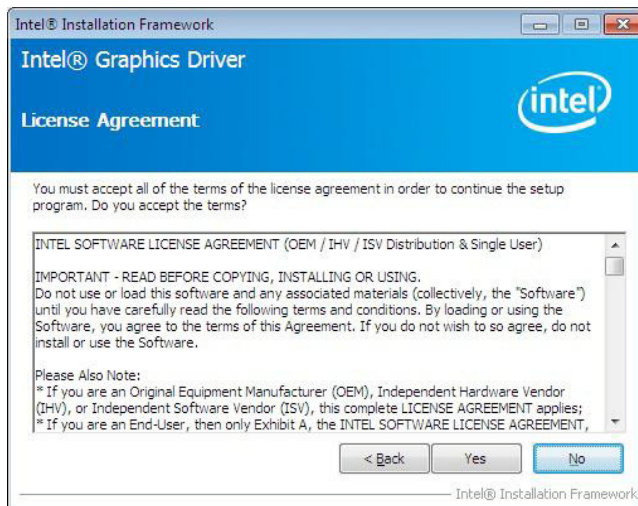

5. Click **Next**

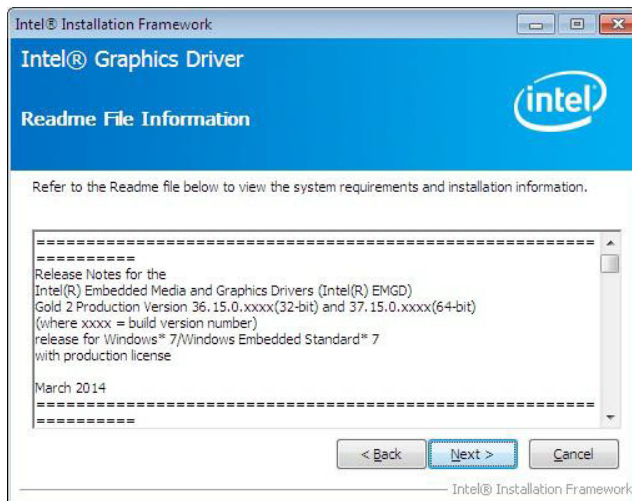

6. Click **Install**



7. Click Next

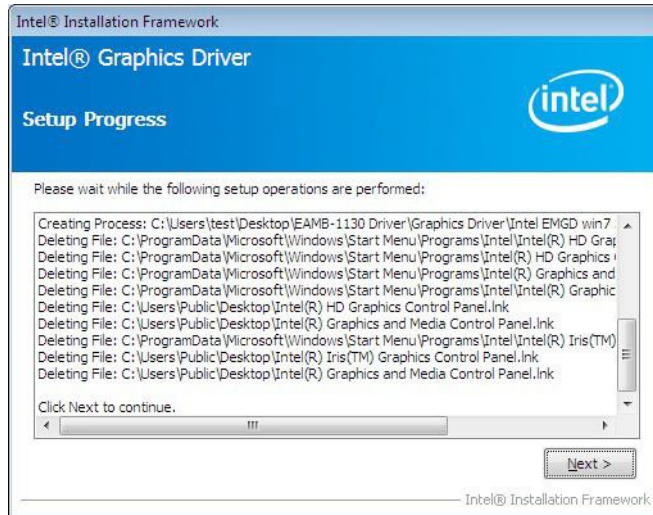

8. Choose **Yes**, then click **Finish** to restart

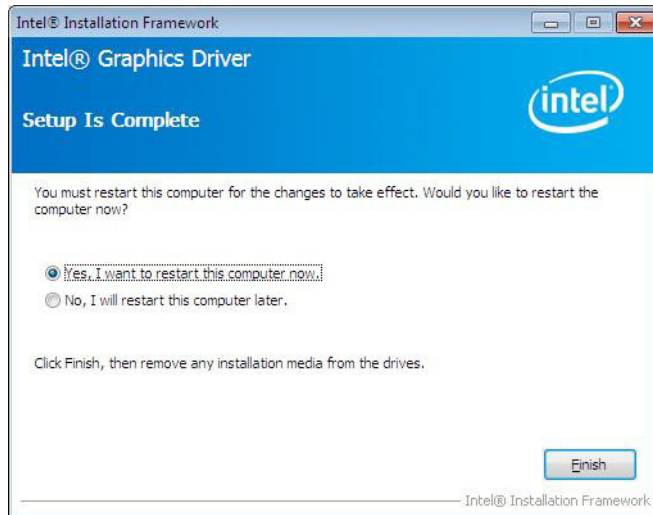

## B.3 LAN Driver Installation

Follow the steps below to install the LAN driver:

1. Launch folder <Driver Root Path>\LAN\Win7  
    \Install\_Win7\_7077\_XXX\_XXXXXXXX
2. Install setup.exe

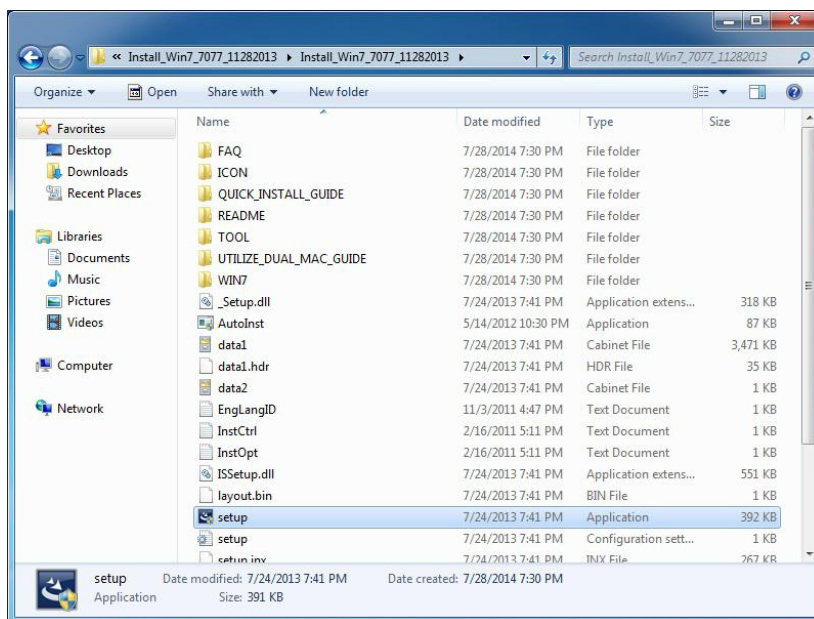

3. Click Next

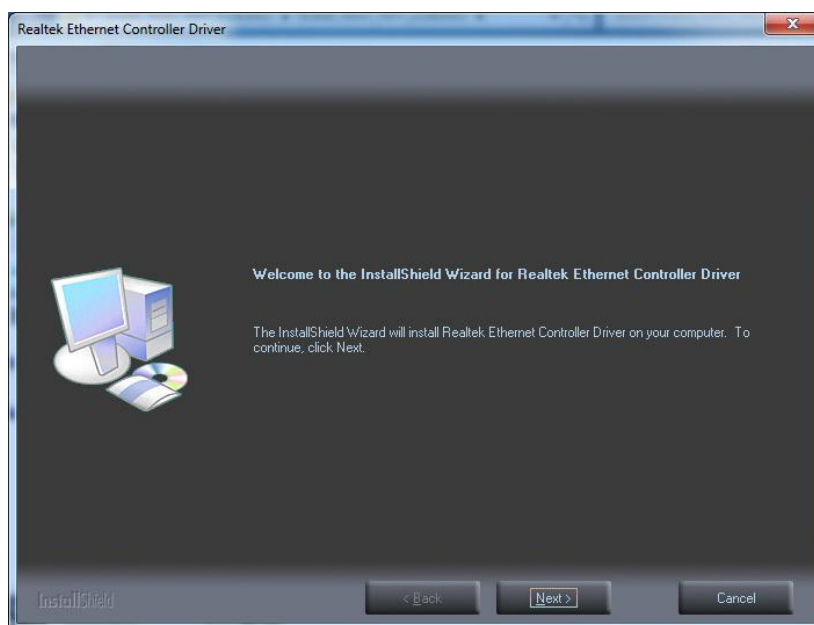

4. Click **Install**

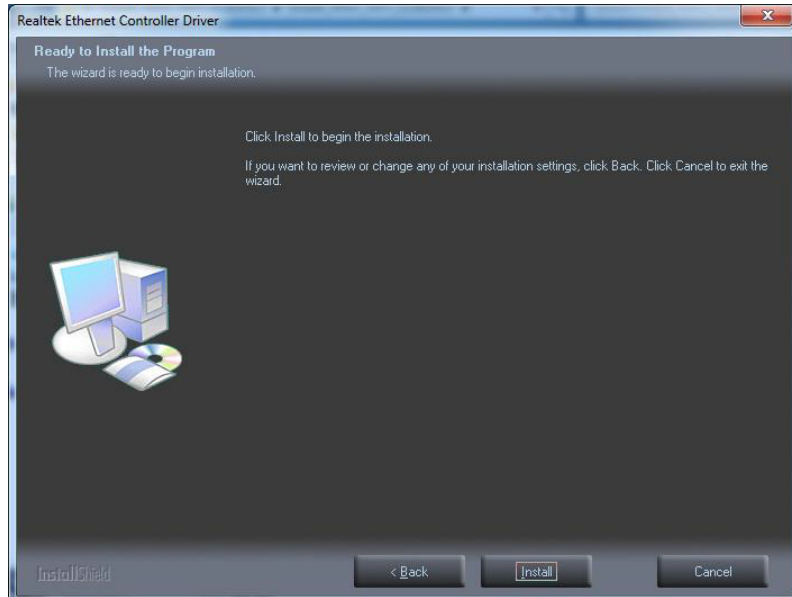

5. Click **Finish**

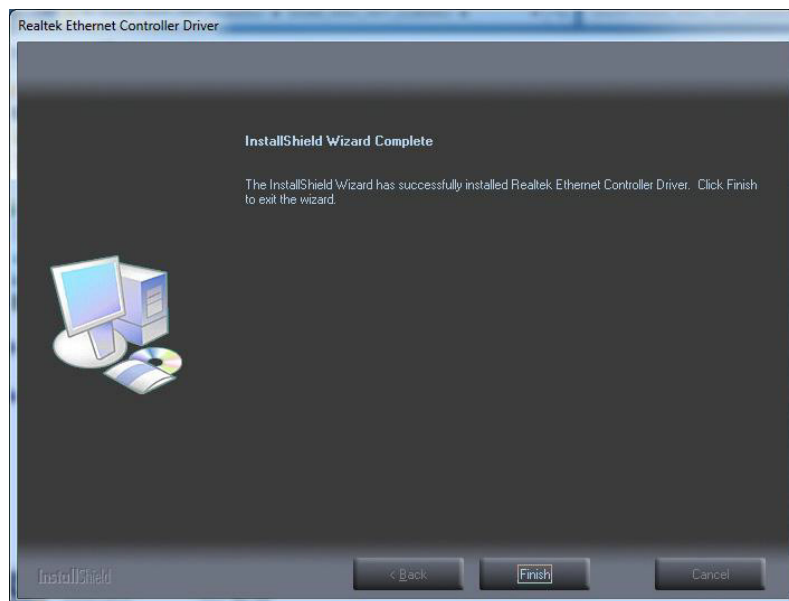

## B.4 Intel® Trusted Execution Engine Driver Installation

Follow the steps below to install the Intel Trusted Execution Engine driver:

1. Launch folder <Driver Root Path>\TXE\Intel TXE Firmware\Win7
2. Install kmdf-1.11-Win-6.1-x86.msu

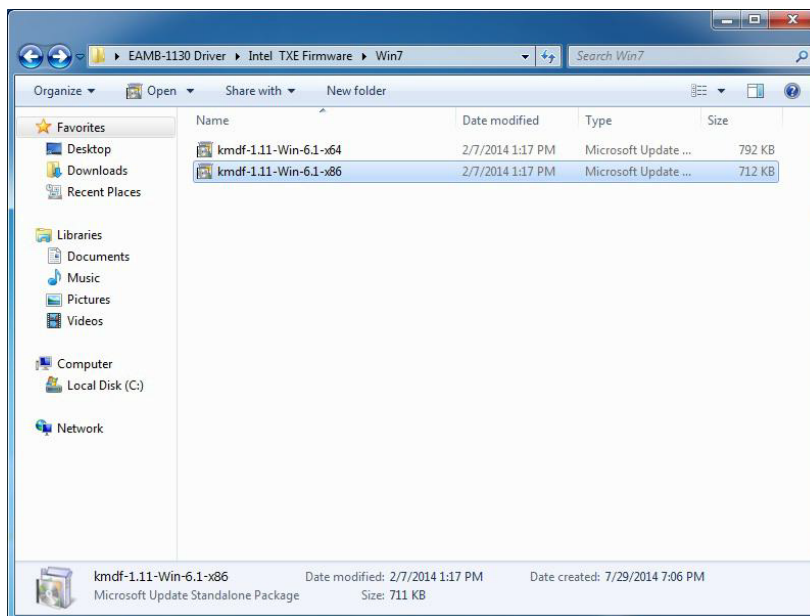

3. Click **Yes**

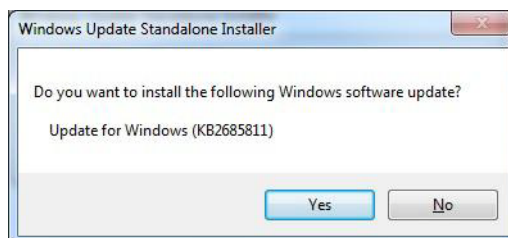

4. Click **Next**

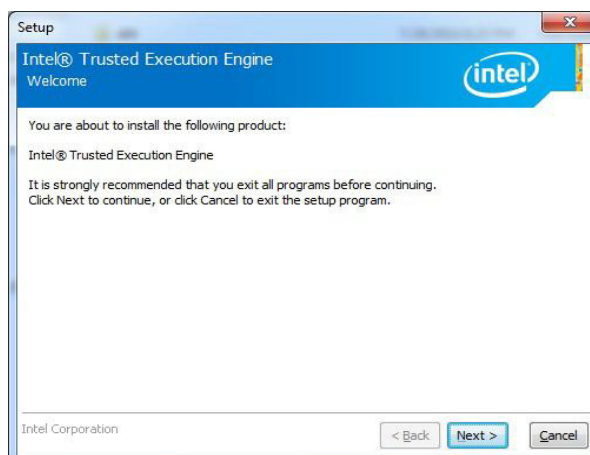

5. Click **Next**

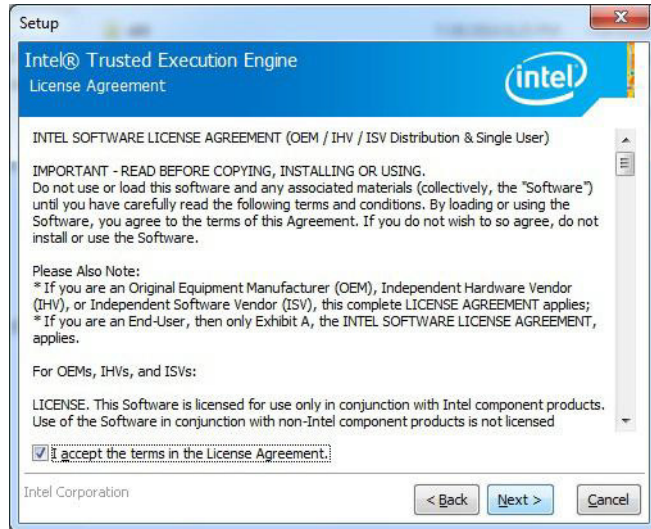

6. Click **Next**

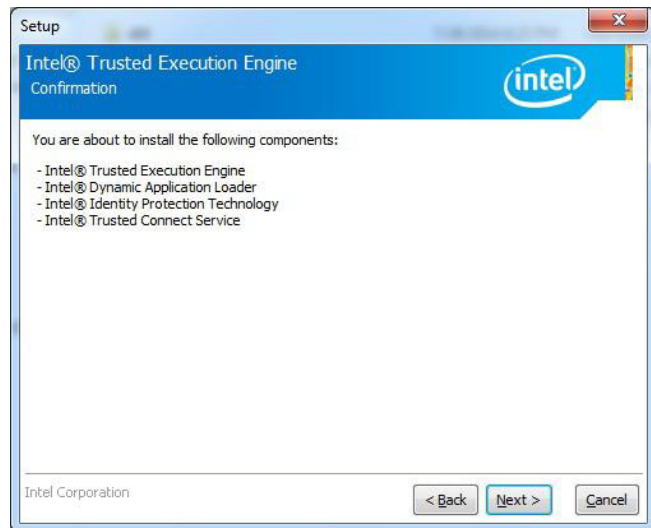

7. Choose **Yes**, then click **Finish** to restart.

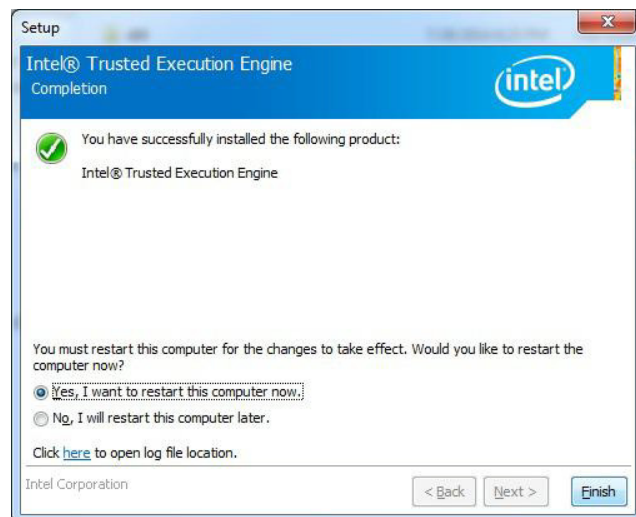



## B.5 Windows 7 USB 3.0 Driver Installation

Follow the steps below to install the Windows 7 USB 3.0 driver:

1. Launch folder <Driver Root Path>\USB3\Win7\SetupUSB3\_X.X.X.XX
2. Install Setup.exe

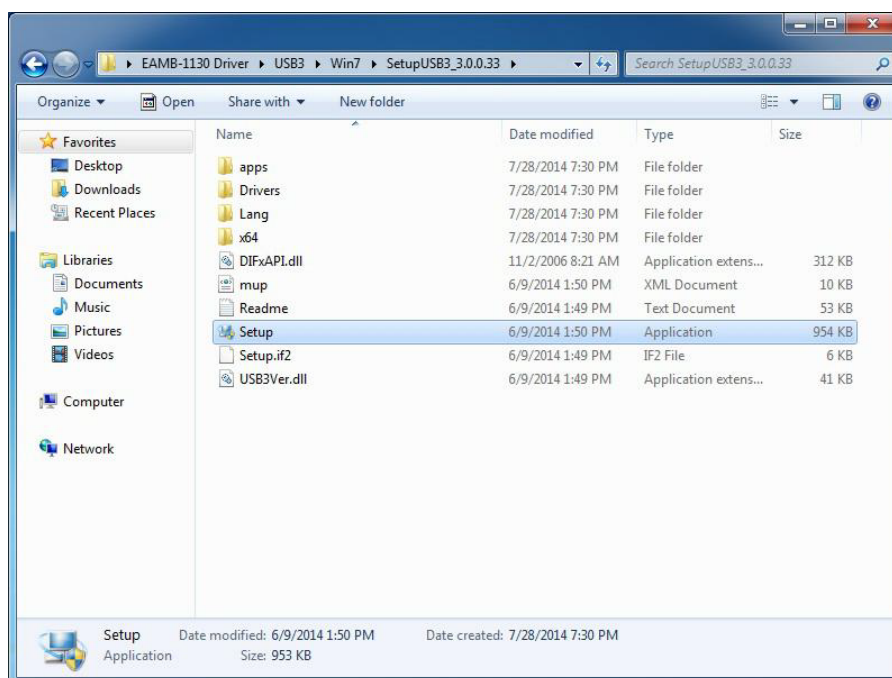

3. Click **Next**

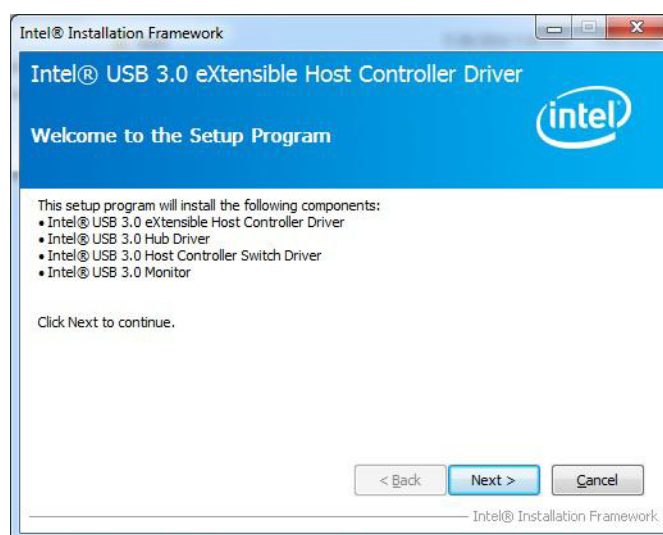

4. Click **Yes**



5. Click **Next**



6. Click **Next**

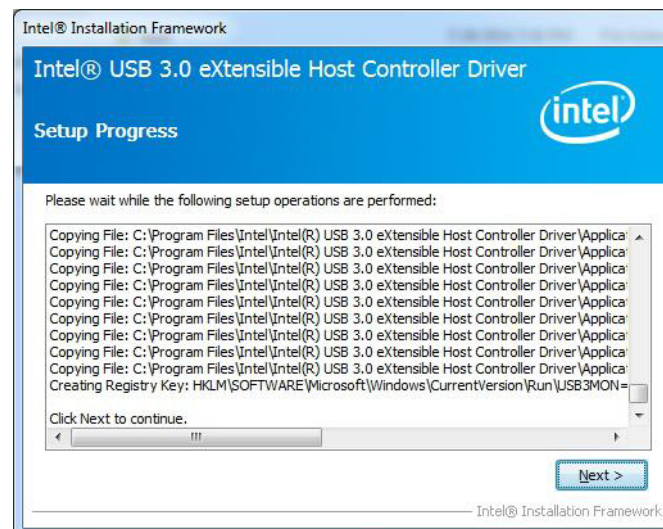

7. Choose **Yes**, then click **Finish** to restart



## B.6 Advantech EC Driver Installation

Follow the steps below to install the EC drivers:

1. Launch folder <Driver Root Path>\EC\Vx.xx.xxxx
2. Install AdvEC\_Vx.xx.xxxx.exe

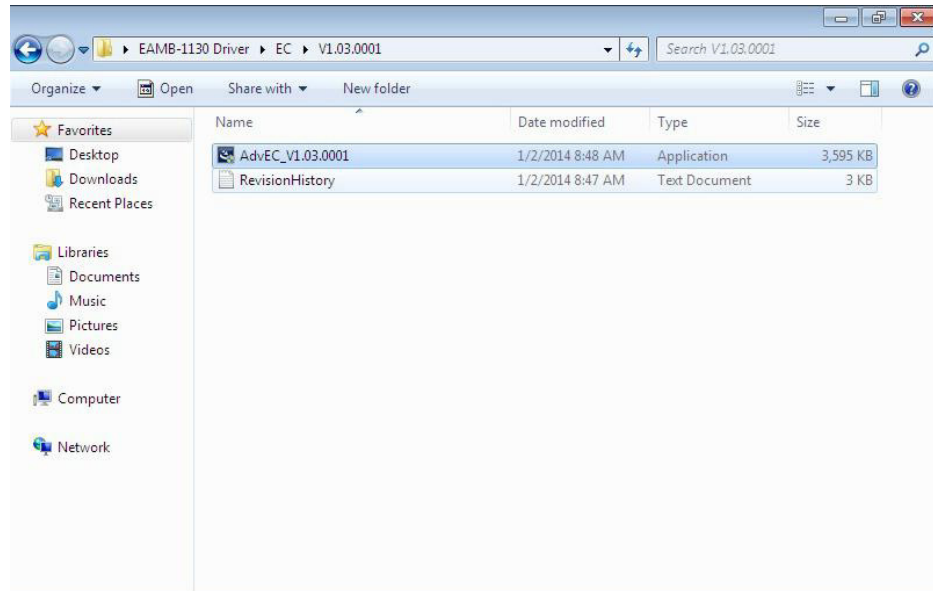

3. Click **Next**

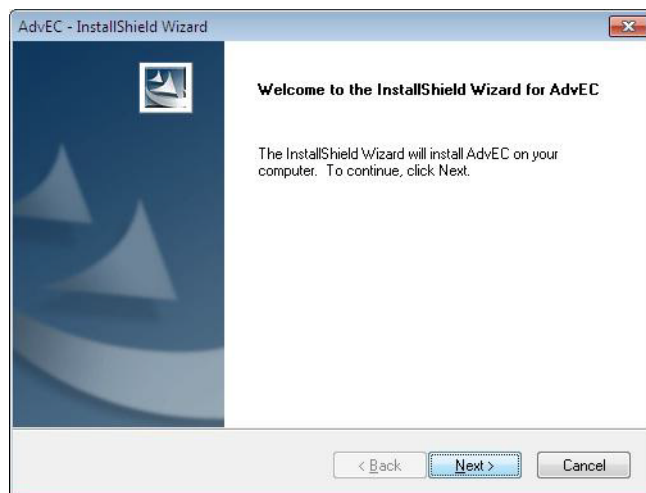

4. Click **Install**

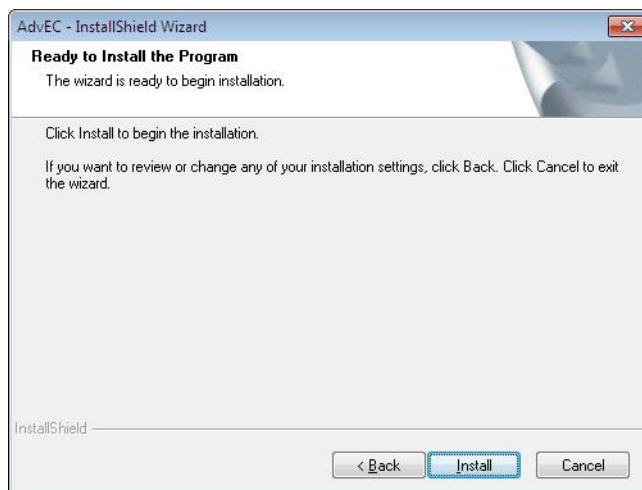

5. Click **Finish**

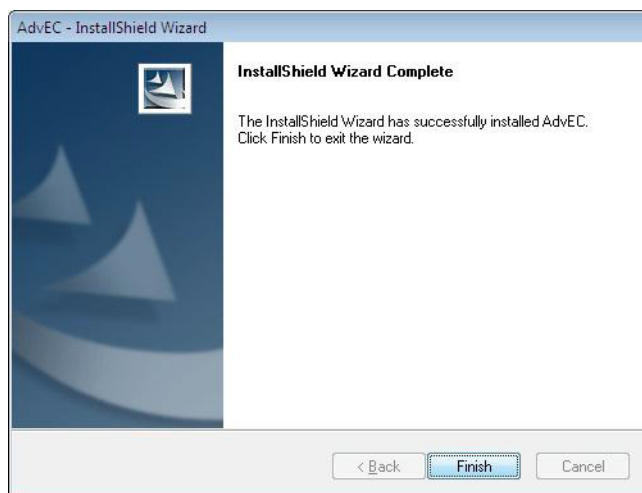

6. Choose **Yes**, then click **OK** to restart



## B.7 Advantech EC Brightness Control Tool Installation

**Note!** The Advantech EC driver must be installed first



Follow the steps below to install the EC brightness control tool:

1. Launch folder <Driver Root Path>\EC Brightness\Vx.xx.xxxx
2. Install AdvECBrightness\_Vx.xx.xxxx.exe

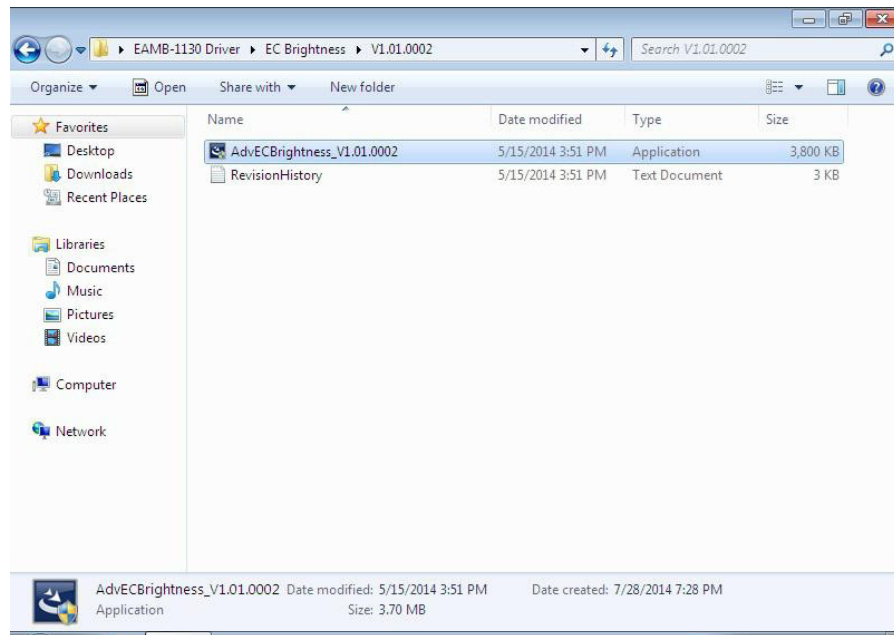

3. Click **Next**

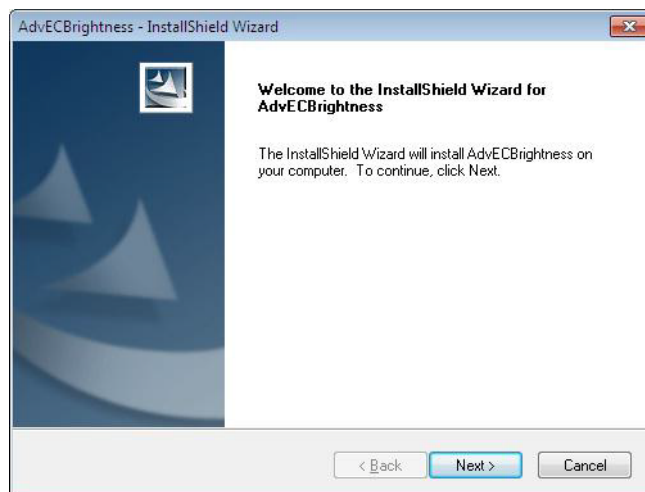

4. Click **Install**

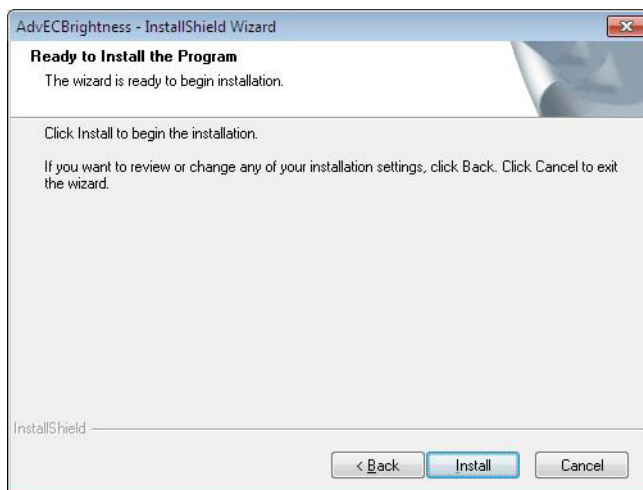

5. Click **Finish**

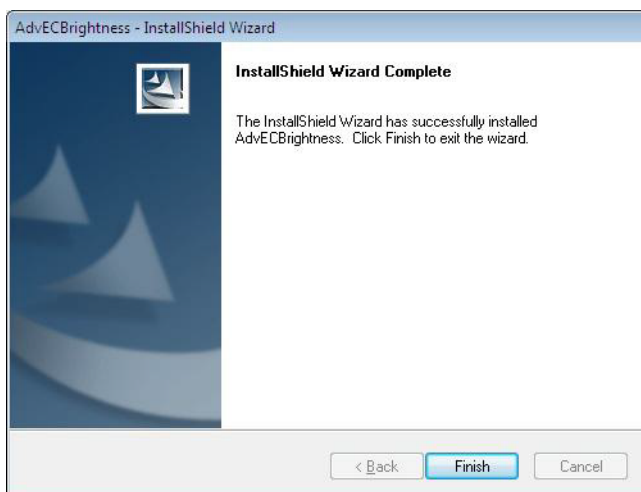

6. Choose **Yes**, then click **OK** to restart



## B.8 Advantech EC Watchdog Timer Driver Installation

**Note!** The EC driver must be installed first



Follow the steps below to install the EC Watchdog Timer driver:

1. Launch folder <Driver Root Path>\WDT\Vx.xx.xxxx
2. Install AdvWDT\_Vx.xx.xxxx.exe

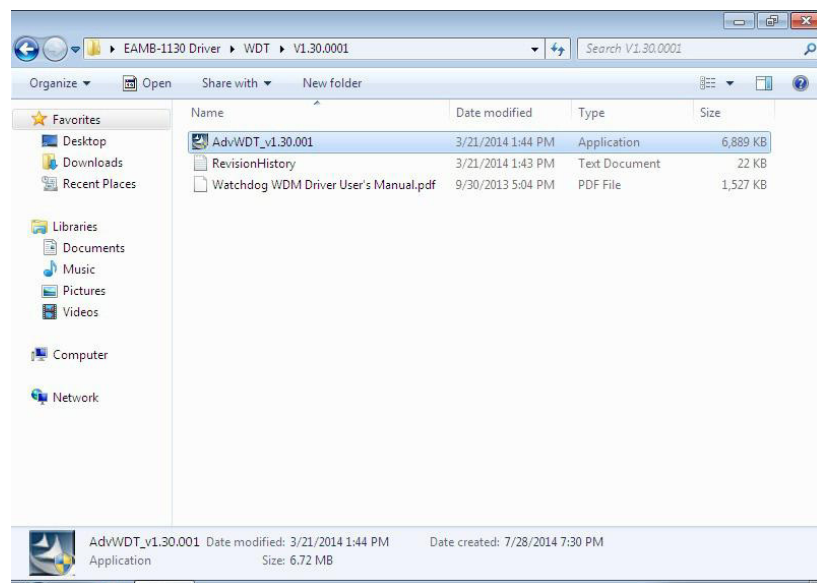

3. Click **Next**

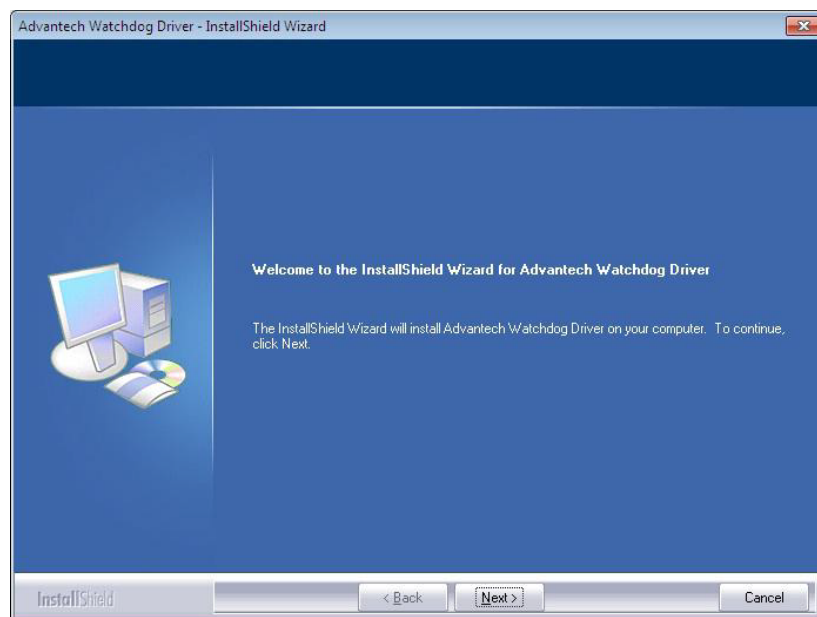



4. Choose **Advantech [EC]WDT**, then click **Next**

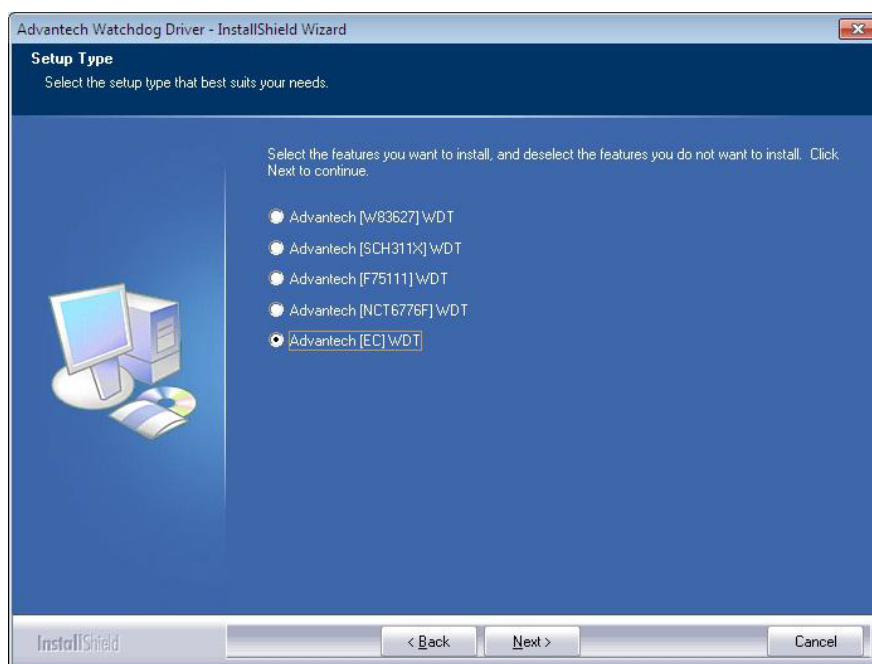

5. Click **Install**

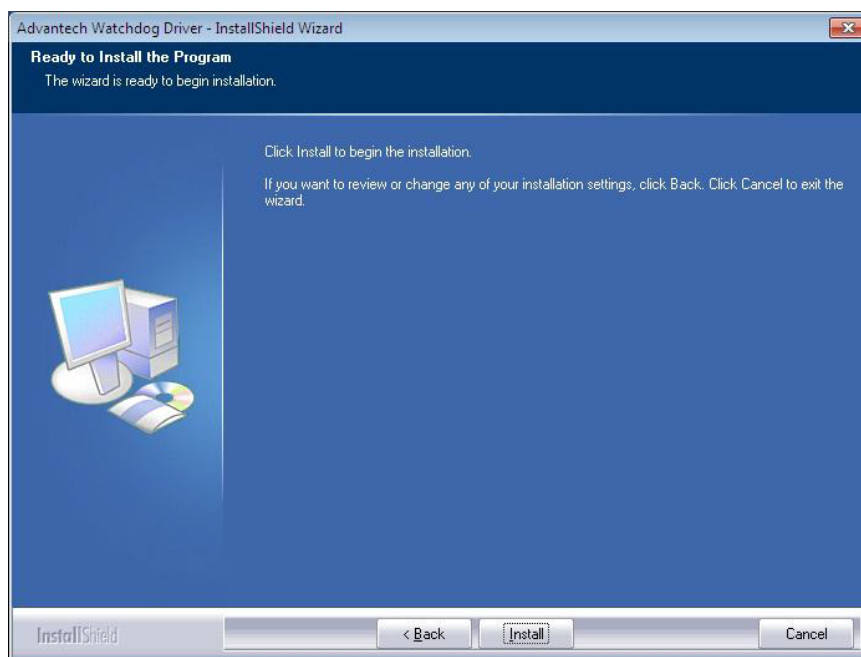

6. Click **Finish**

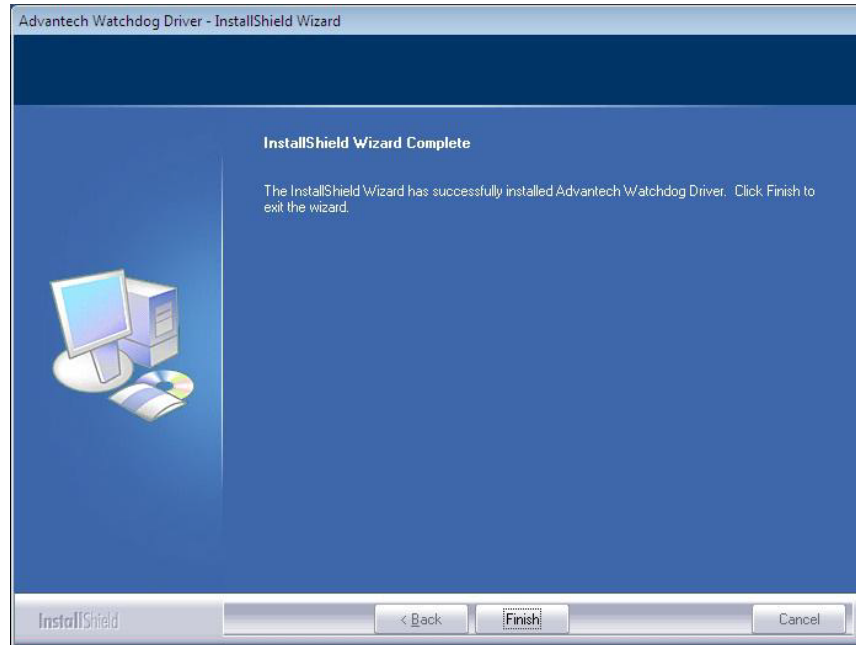

7. Choose **Yes**, then click **OK** to restart



## B.9 Advantech LMsensor Driver Installation

Follow the steps below to install the LMsensor driver:

1. Launch folder <Driver Root Path>\Lmsensor\Vx.xx.xxxx
2. Install AdvLmsensor\_EC\_Vx.xx.xxxx.exe

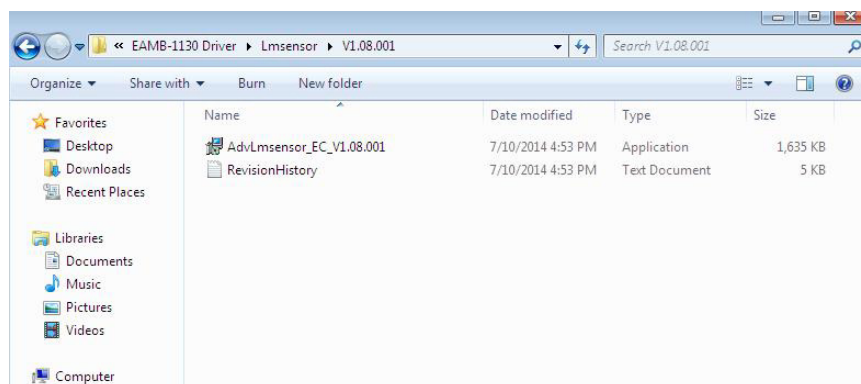

3. Next



4. Restart



---

**Note!** *Go to Advantech's product support page for the detailed driver user manual.*



**Note!** *The drivers and utilities used for the panel PCs are subject to change without notice. If in doubt, check Advantech's website or contact our application engineers for the latest information regarding drivers and utilities.*



# Appendix **C**

BIOS Setup

With the AMI BIOS Setup program, users can modify BIOS settings and control various system features. This chapter describes the basic navigation of the BIOS Setup Utility

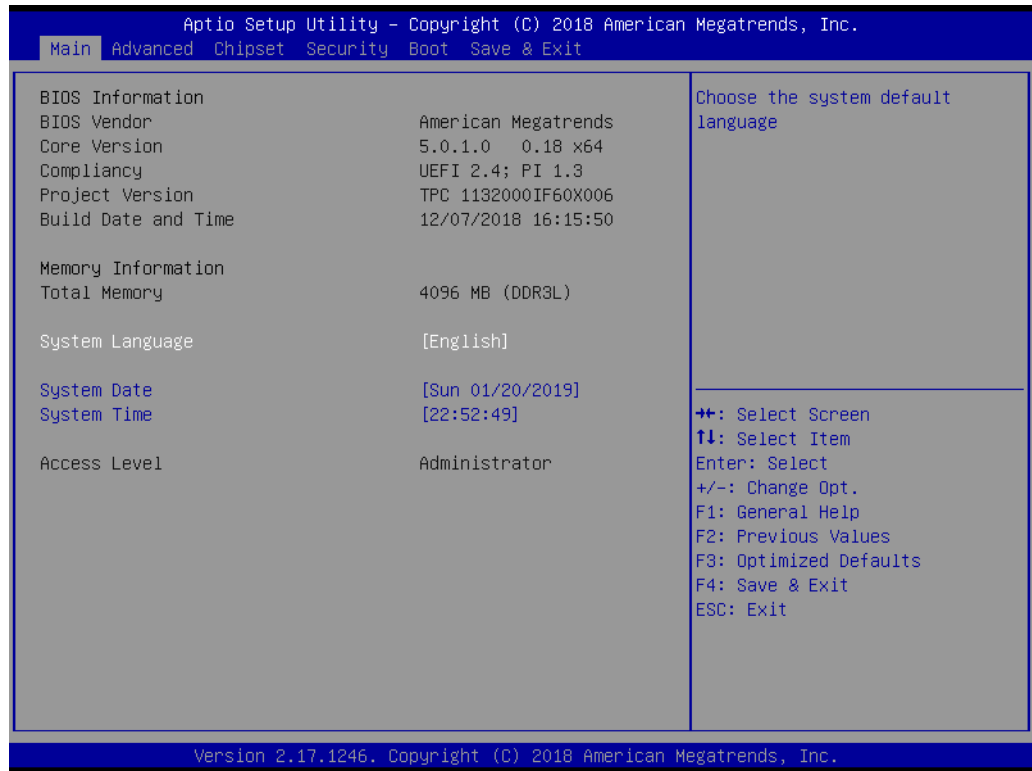

AMI's BIOS ROM has a built-in Setup program that allows users to modify the basic system configuration. This information is stored in flash ROM so it retains the Setup information when the power is turned off.

## C.1 Entering Setup

Turn on the computer and check for the patch code. If there is a number assigned to the patch code, it means that the BIOS supports your CPU. If there is no number assigned to the patch code, please contact an Advantech application engineer to obtain an up-to-date patch code file. This will ensure that your CPU's system status is valid. After ensuring that you have a number assigned to the patch code, press <DEL> and you will immediately be allowed to enter Setup.

### C.1.1 Main Setup

When you first enter the BIOS Setup Utility, users will enter the Main setup screen. Users can always return to the Main setup screen by selecting the Main tab. There are two Main Setup options. They are described in this section. The Main BIOS Setup screen is shown below.



The Main BIOS setup screen has two main frames. The left frame displays all the options that can be configured. Grayed-out options cannot be configured; options in blue can. The right frame displays the key legend.

Above the key legend is an area reserved for a text message. When an option is selected in the left frame, it is highlighted in white. Often a text message will accompany it.

#### ■ System time / System date

Use this option to change the system time and date. Highlight System Time or System Date using the <Arrow> keys. Enter new values through the keyboard. Press the <Tab> key or the <Arrow> keys to move between fields. The date must be entered in MM/DD/YY format. The time must be entered in HH:MM:SS format.

**Note!** *Before installing WinCE image, IDE configuration must set SATA Mode to IDE Mode in BIOS to boot successfully.*



## C.1.2 Advanced BIOS Features Setup

Select the Advanced tab from the setup screen to enter the Advanced BIOS Setup screen. Users can select any item in the left frame of the screen, such as CPU Configuration, to go to the sub menu for that item. Users can display an Advanced BIOS Setup option by highlighting it using the <Arrow> keys. All Advanced BIOS Setup options are described in this section. The Advanced BIOS Setup screens are shown below. The sub menus are described on the following pages.

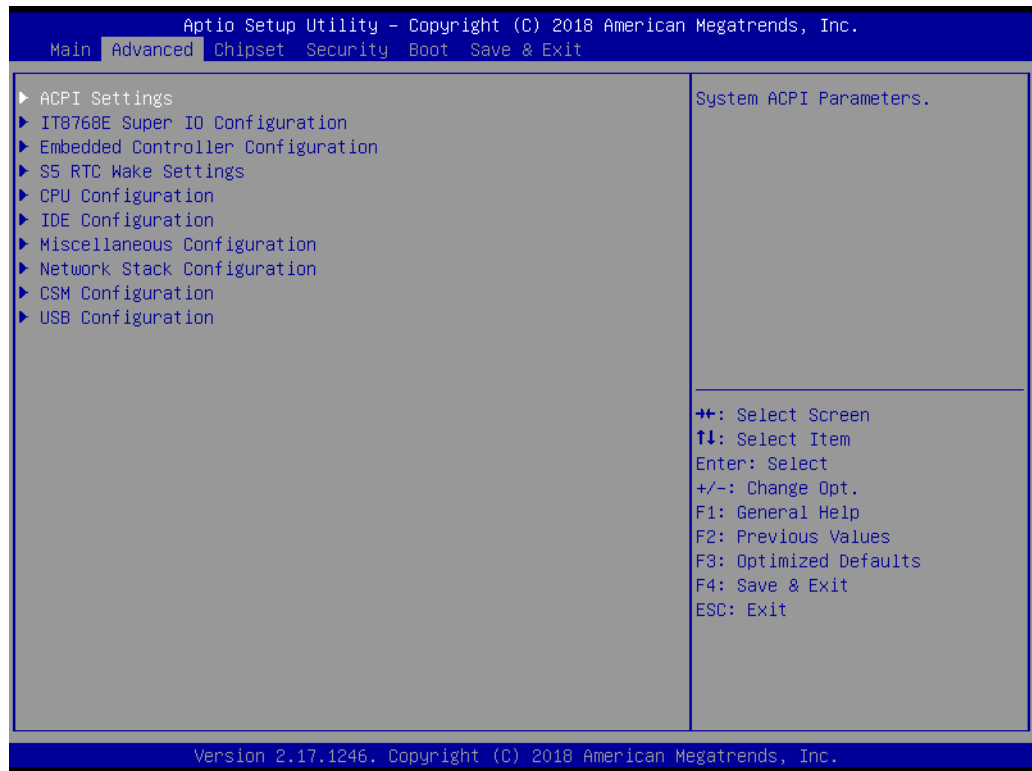



### C.1.2.1 ACPI Settings Configuration

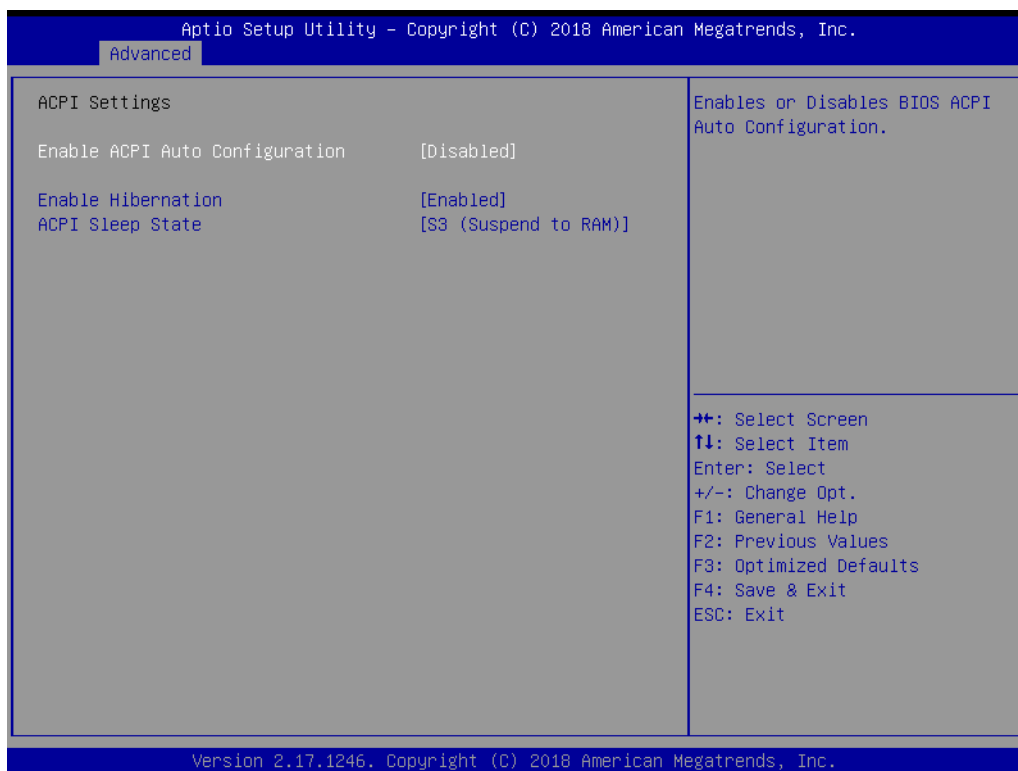

- **Enable ACPI Auto Configuration**  
This item allows users to enable or disable BIOS ACPI auto configuration.
- **Enable Hibernation**  
This item allows users to enable or disable System ability to hibernate (OS/S4 sleep State). This option may be not effective with some OS.
- **ACPI Sleep State**  
This item allows users to select the ACPI sleep state. The system will enter when the SUSPEND button is pressed.
- **Lock Legacy Resources**  
Enables or Disables Lock of Legacy Resources

### C.1.2.2 Super I/O Configuration



- **Serial Port 1 Configuration**  
Set Parameters of Serial Port 1 (COMA)
- **Serial Port 2 Configuration**  
Set Parameters of Serial Port 2 (COMB)

### C.1.2.3 Embedded Controller Configuration

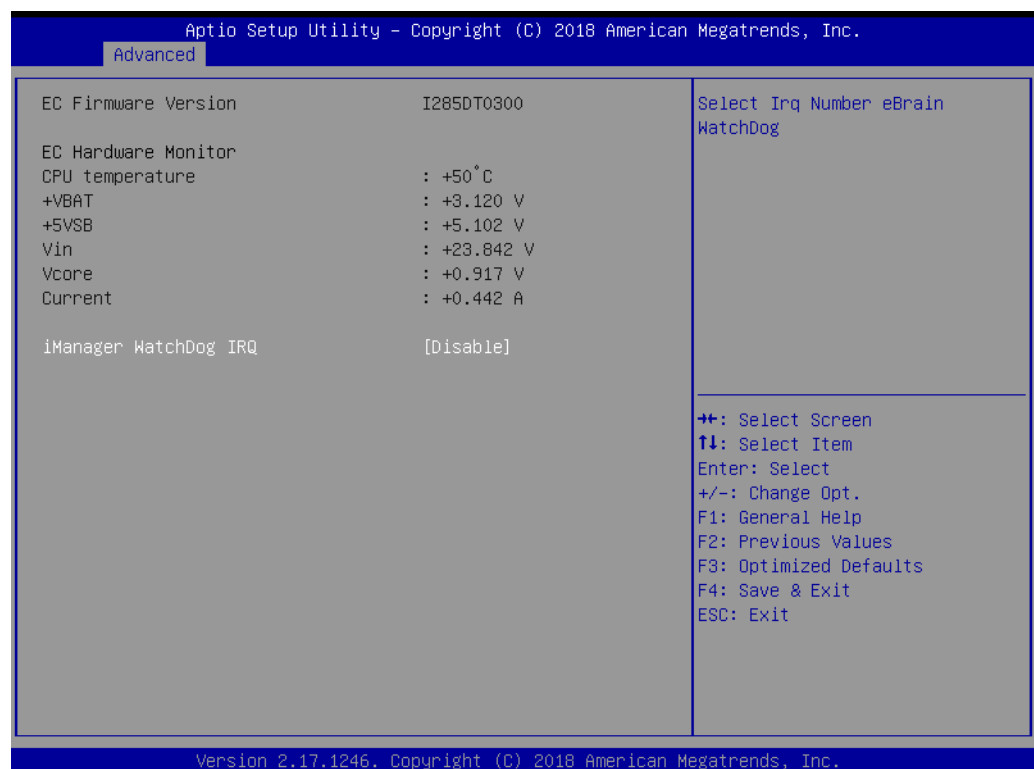

- **EC Hardware Monitor**  
This page display all information about system Temperature/Voltage/Current.
- **iManager WatchDog IRQ**  
This item allows users to set the IRQ number of EC watchdog.
- **EC Watch Dog Function**  
This item allows users to select EC watchdog timer.

#### C.1.2.4 S5 RTC Wake Settings

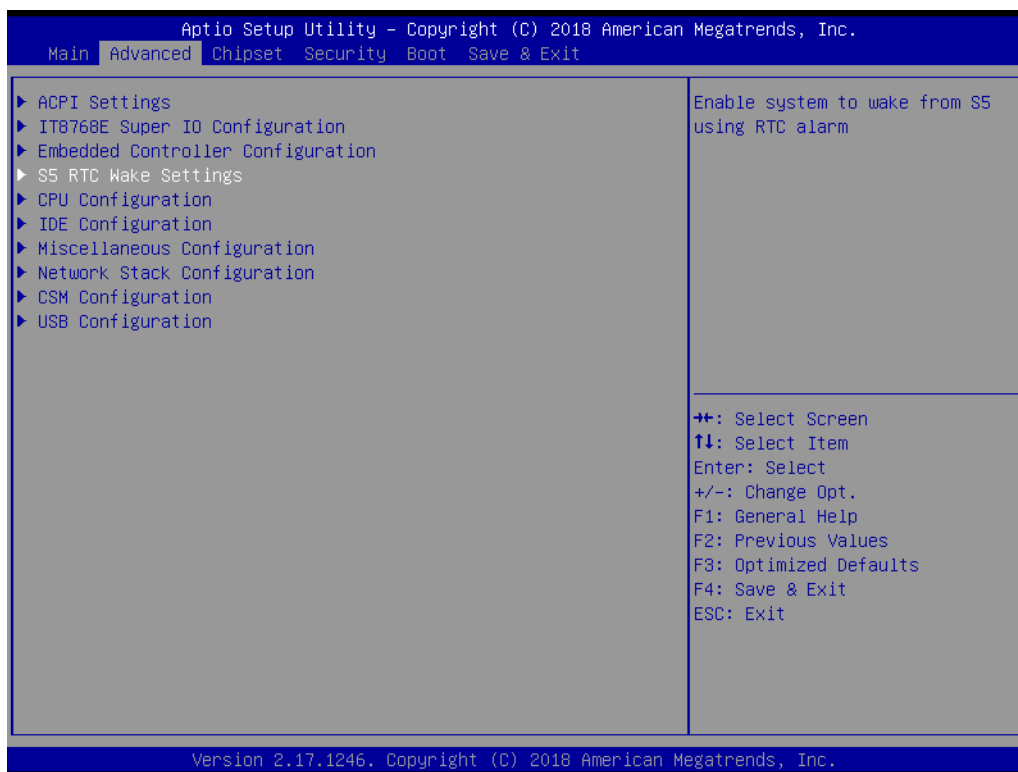

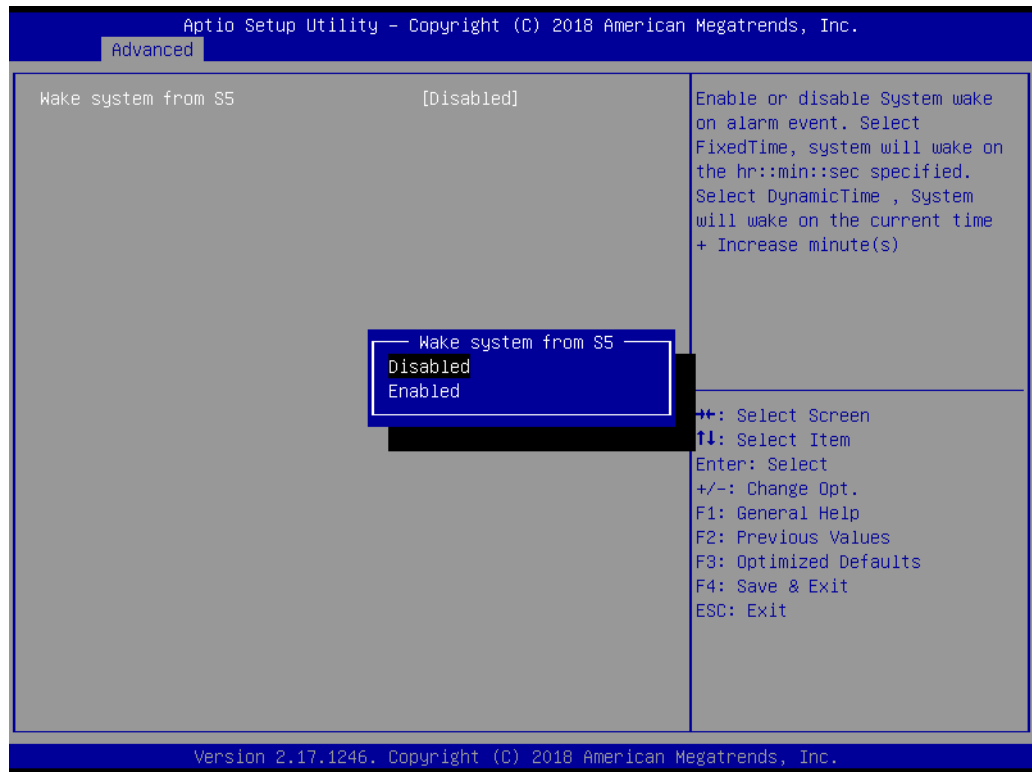

- **Wake system with Fixed Time**  
 Enable or disable System wake on alarm event. Select FixedTime, system will wake on the hr:min:sec specified.

### C.1.2.5 CPU Configuration

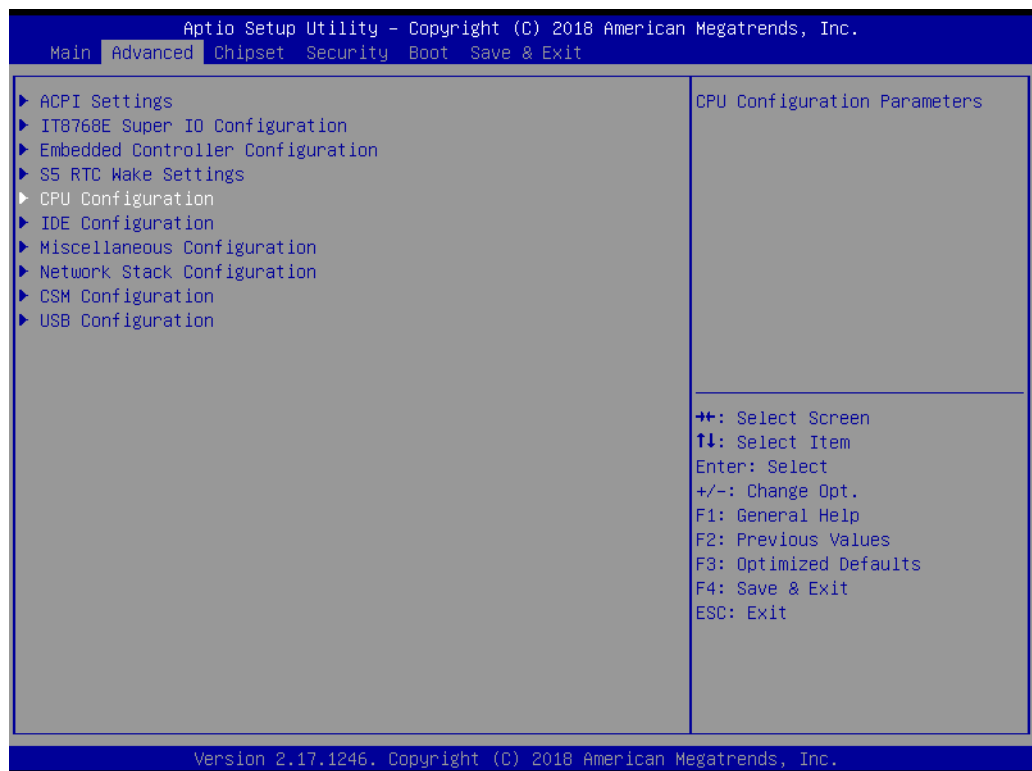

- **Execute Disable Bit**  
 This item allows users to enable or disable Execute Disable Bit.XD can prevent certain classes of malicious buffer overflow attacks when combined with a sup-

porting OS (Windows server 2003 SP1, Windows XP SP2, RedHat Enterprise 3 update 3.)

- **Intel Virtualization Technology**

This item allows users to enable or disable Intel Virtualization Technology. When enabled, a VMM can utilize the additional hardware capabilities provided by Vanderpool Technology.

### C.1.2.6 IDE (SATA) Configuration

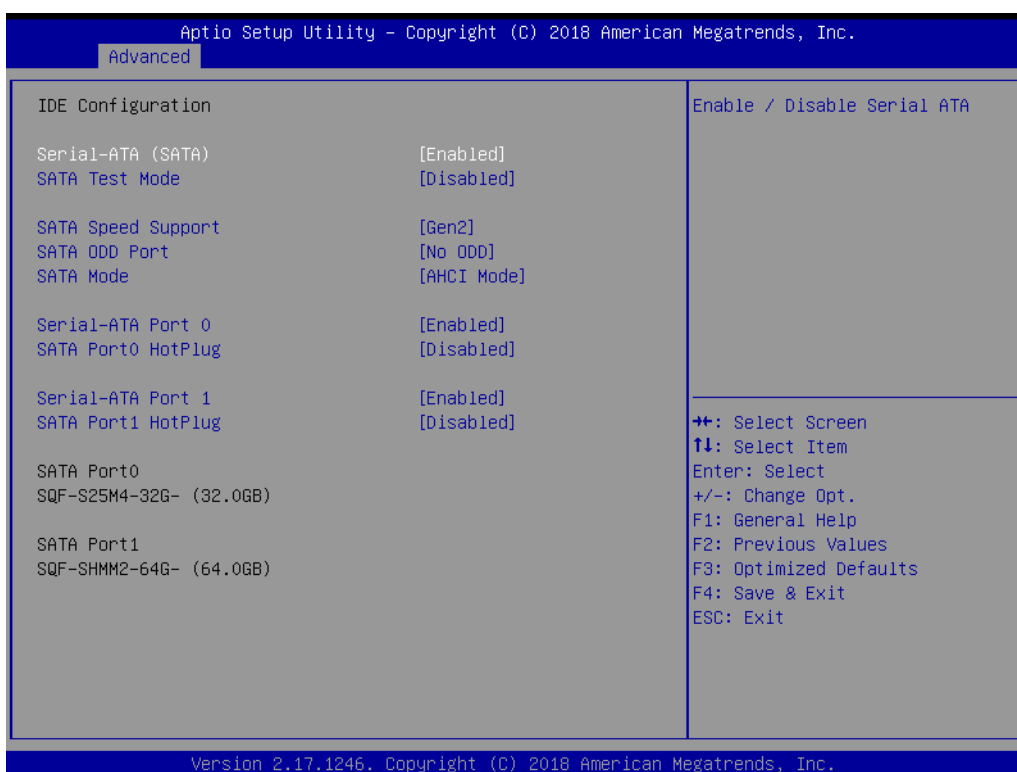
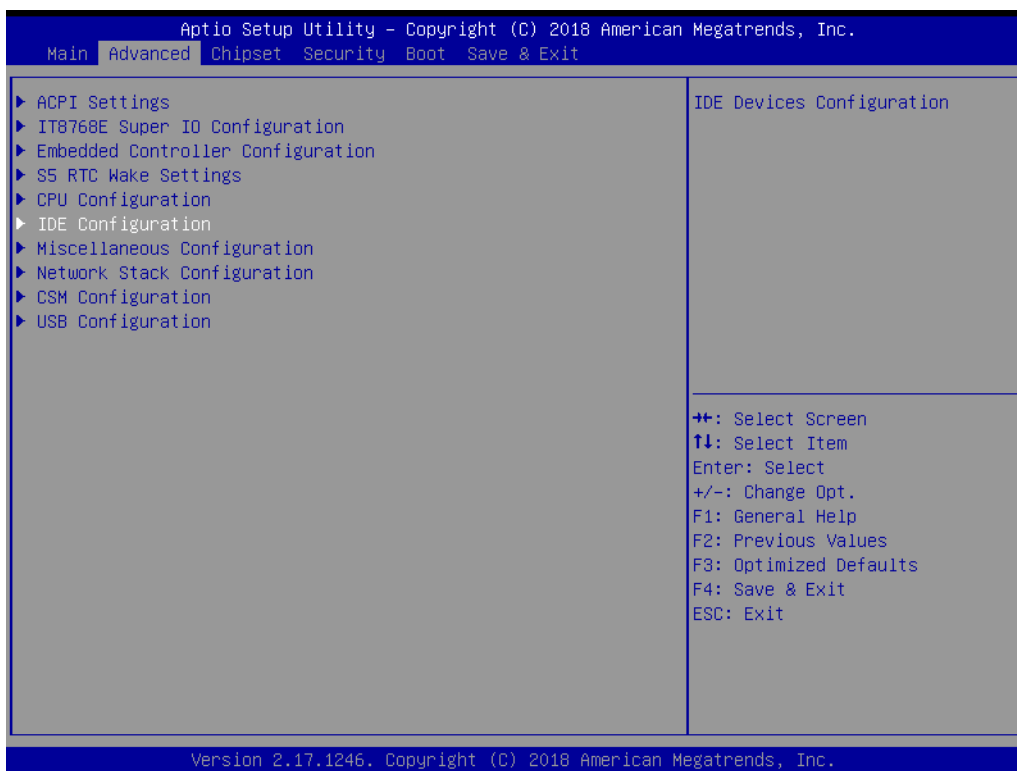

- **Serial-ATA (SATA)**  
This item allows users to enable or disable SATA devices.
- **SATA Test Mode**  
Test Mode enable / disable.
- **SATA Speed Support**  
Indicates the maximum speed the SATA controller can support.
- **SATA ODD Port**  
SATA ODD is Port0 or Port1.
- **SATA Mode**  
This item allows users to select SATA mode selection. (Determines how SATA con-troller(s) operate)
- **Serial-ATA Port 0 / Port1**  
Enable / Disable Serial ATA Port0 / Port1.
- **SATA Port 0 / Port1 HotPlug**  
Enable / Disable SATA Port0 / Port1 hotplug function.

**Note!** Before installing WinCE image, IDE configuration must set SATA Mode to IDE Mode in BIOS to boot successfully.



### C.1.2.7 Miscellaneous Configuration

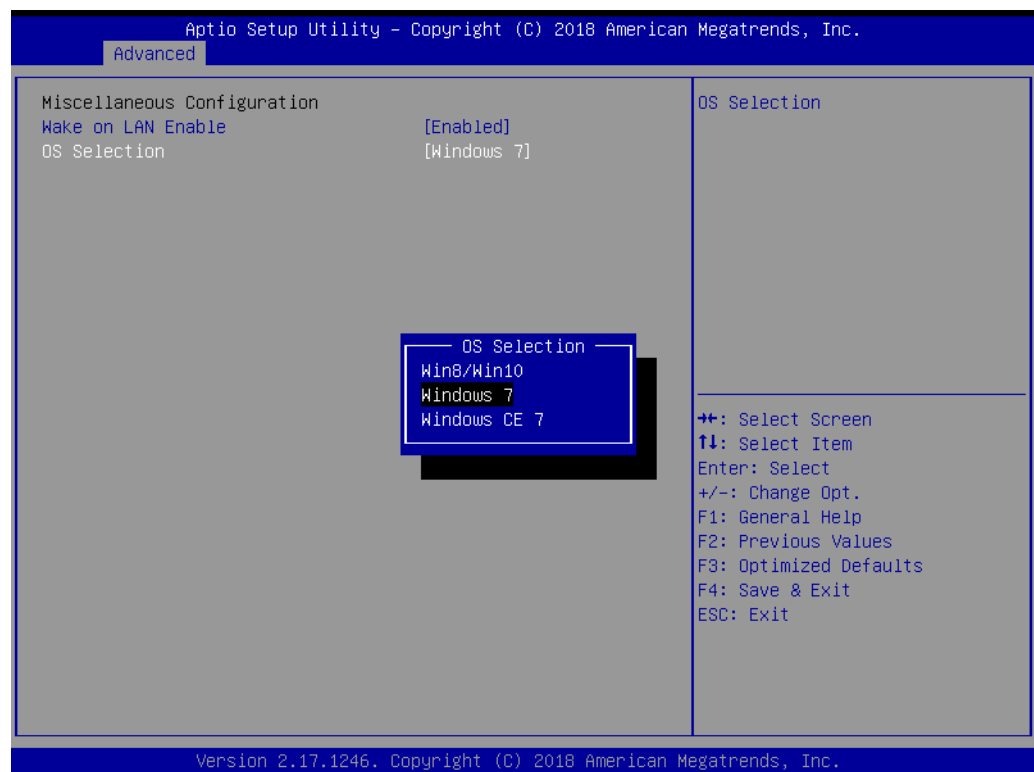

- **OS Selection**  
OS Selection to choose =Windows 7 / Windows 10/ Windows CE 7

### C.1.2.8 LAN Controller

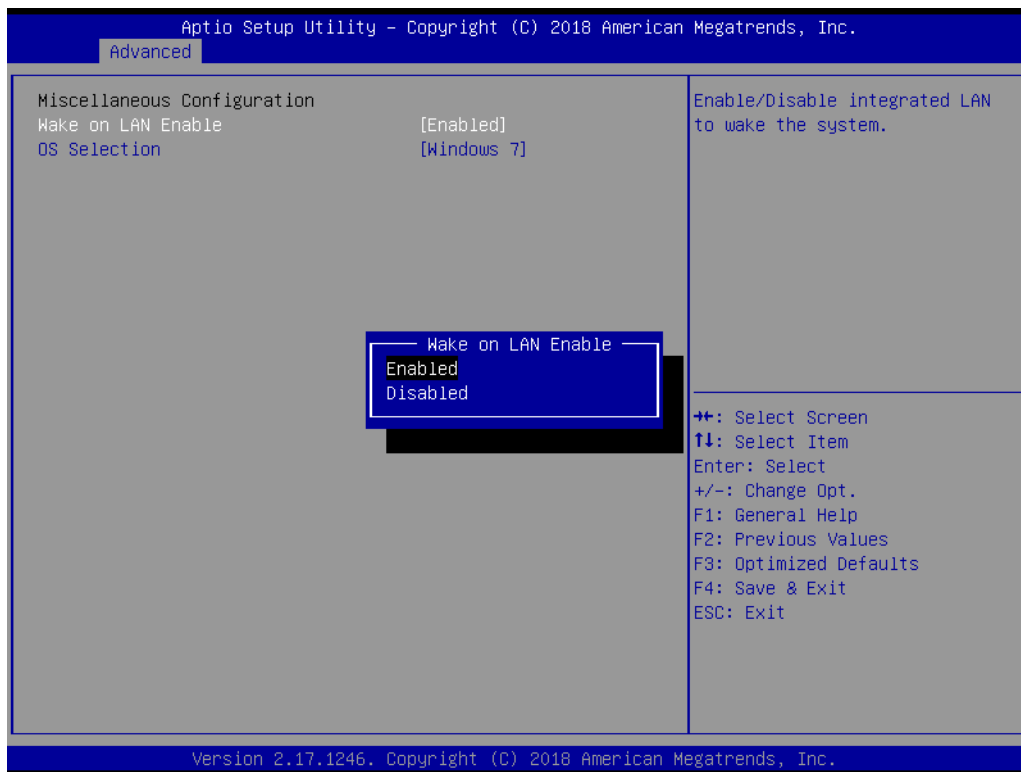

- **LAN A Controller**  
Enable or disable onboard NIC.
- **LAN B Controller**  
Enable or disable onboard NIC.
- **Wake on LAN Enable**  
Enable/Disable integrated LAN to wake the system

### C.1.2.9 CSM Configuration

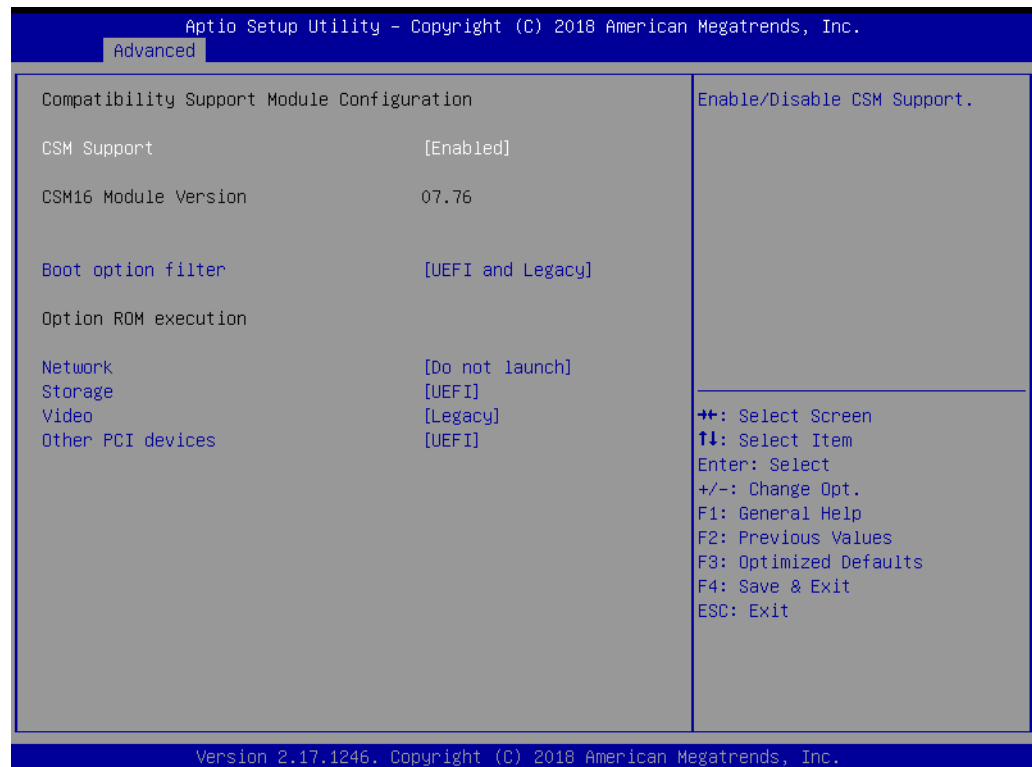
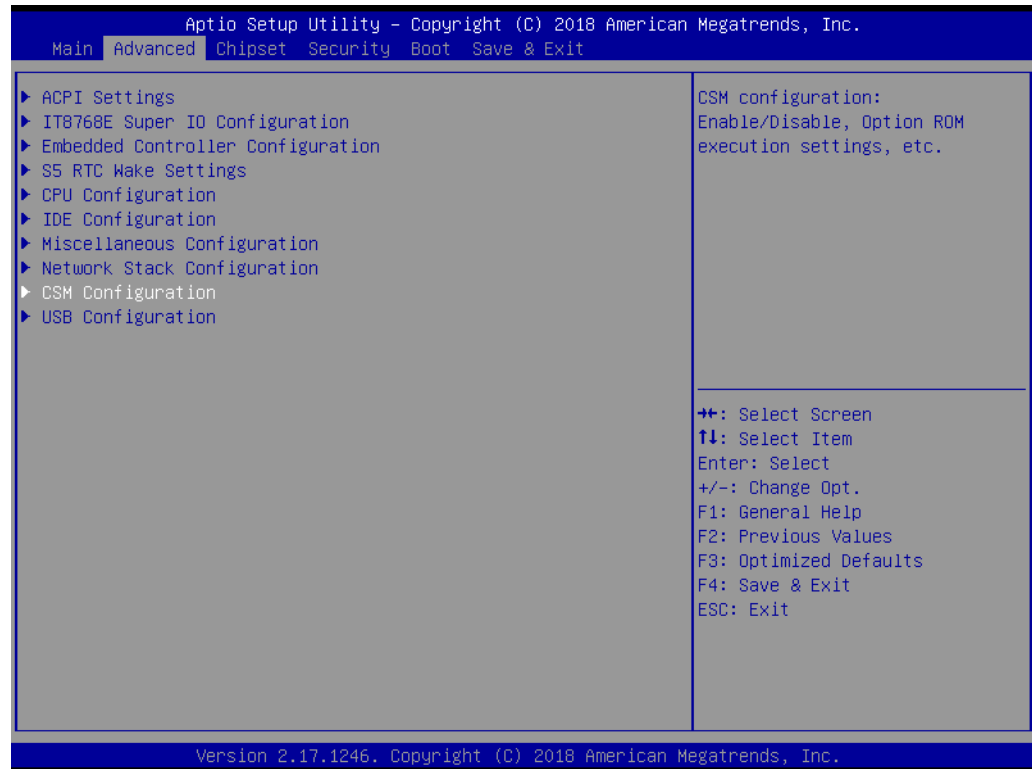

- **CSM Support**  
Enable/Disable CSM Support.
- **GateA20 Active**  
This item is useful when RT code is executed above 1MB. When this is set as "UPON RQUEST", GA20 can be disabled using BIOS services. When it's set as "Always", it does not allow disabling GA20.



- **Option ROM Messages**  
Set display mode for Option ROM
- **Boot option filter**  
This option controls Legacy/UEFI ROMs priority
- **Network**  
Controls the execution of UEFI and Legacy PXE OpROM
- **Storage**  
Controls the execution of UEFI and Legacy Storage OpROM
- **Video**  
Controls the execution of UEFI and Legacy Video OpROM
- **Other PCI devices**  
Determines OpROM execution policy for devices other than Network, Storage, or Video

### C.1.2.10 USB Configuration

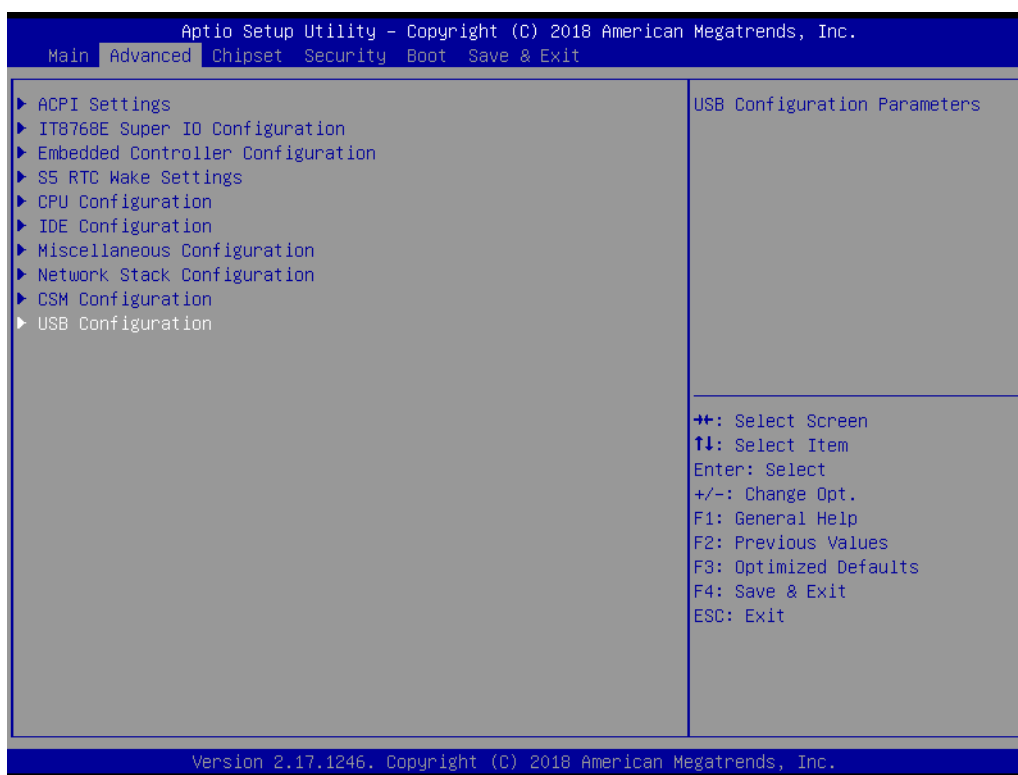

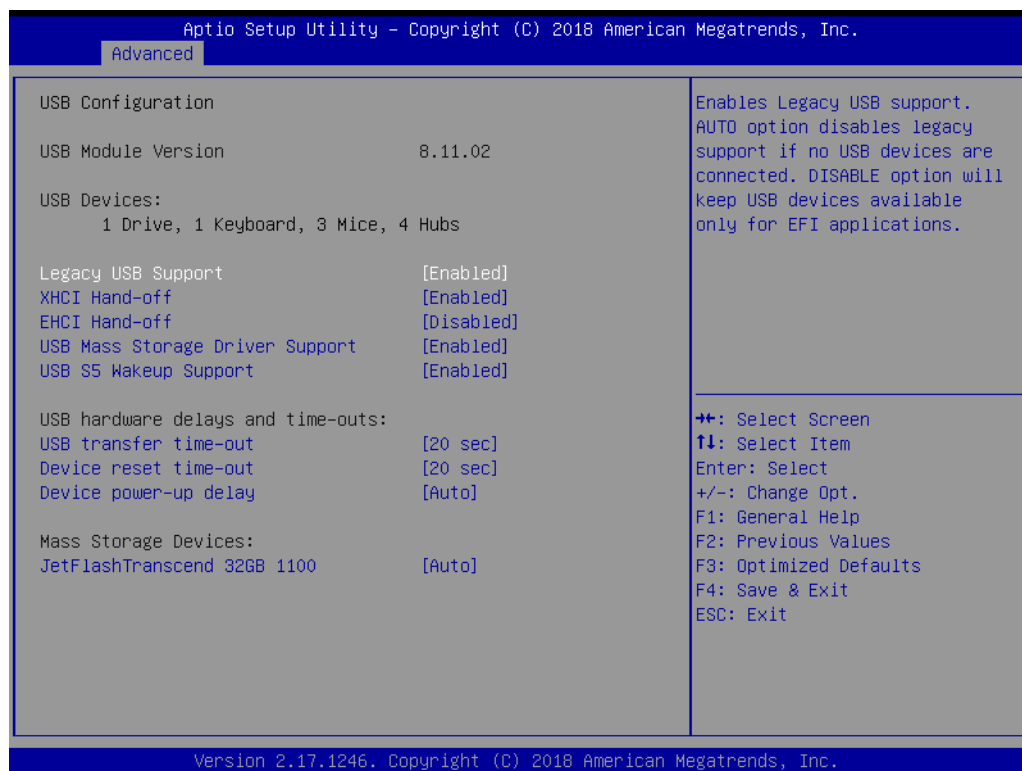

- **Legacy USB Support**  
Enables support for legacy USB. Auto option disables legacy support if no USB devices are connected. DISABLE option will keep USB devices available only
- **XHCI Hand-Off**  
This is a workaround for OS without XHCI hand-off support. The XHCI ownership change should claim by XHCI driver.
- **EHCI Hand-Off**  
This is a workaround for OS without EHCI hand-off support. The EHCI ownership change should claim by EHCI driver.
- **USB Mass Storage Driver Support**  
This item allows you to enable or disable the USB mass storage device support.
- **Device reset time-out**  
USB mass storage device start unit command time-out.
- **Device power-up delay**  
Maximum time the device will take before it properly report itself to the host controller. "Auto" uses default value: for a Root port it is 100 ms, for a Hub port the delay is taken from Hub descriptor.

### C.1.2.11 COM Configuration

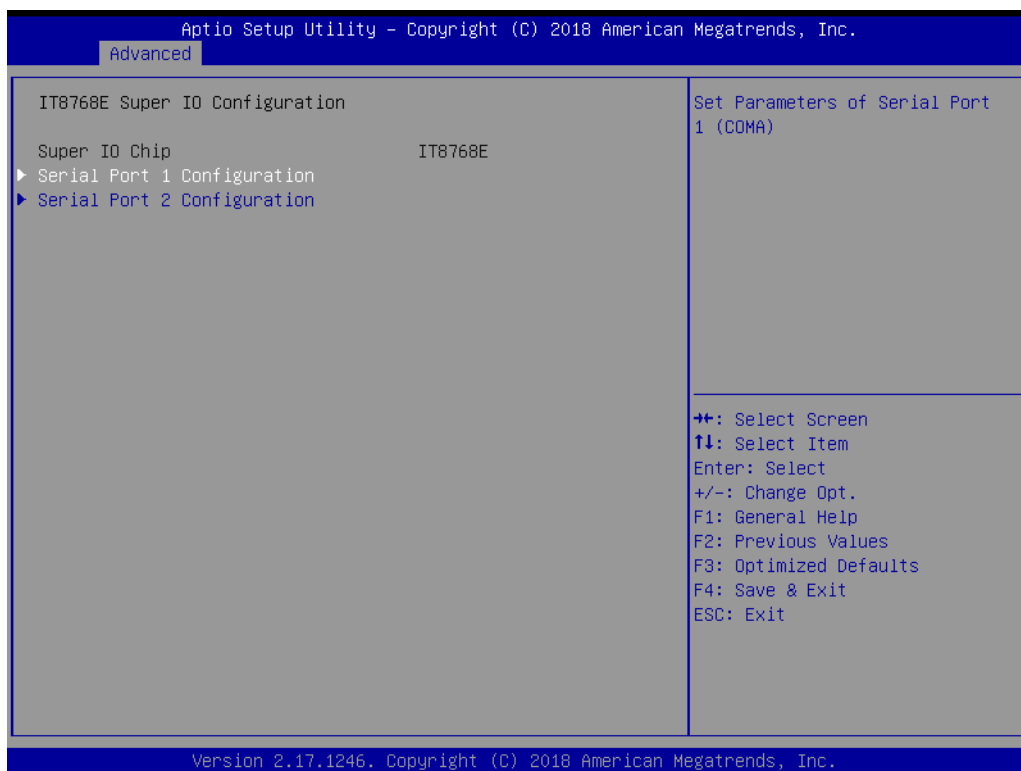

- **COM Configuration**  
 Configure Serial Ports to RS-232/ RS-485/ RS422

## C.1.3 Chipset Configuration

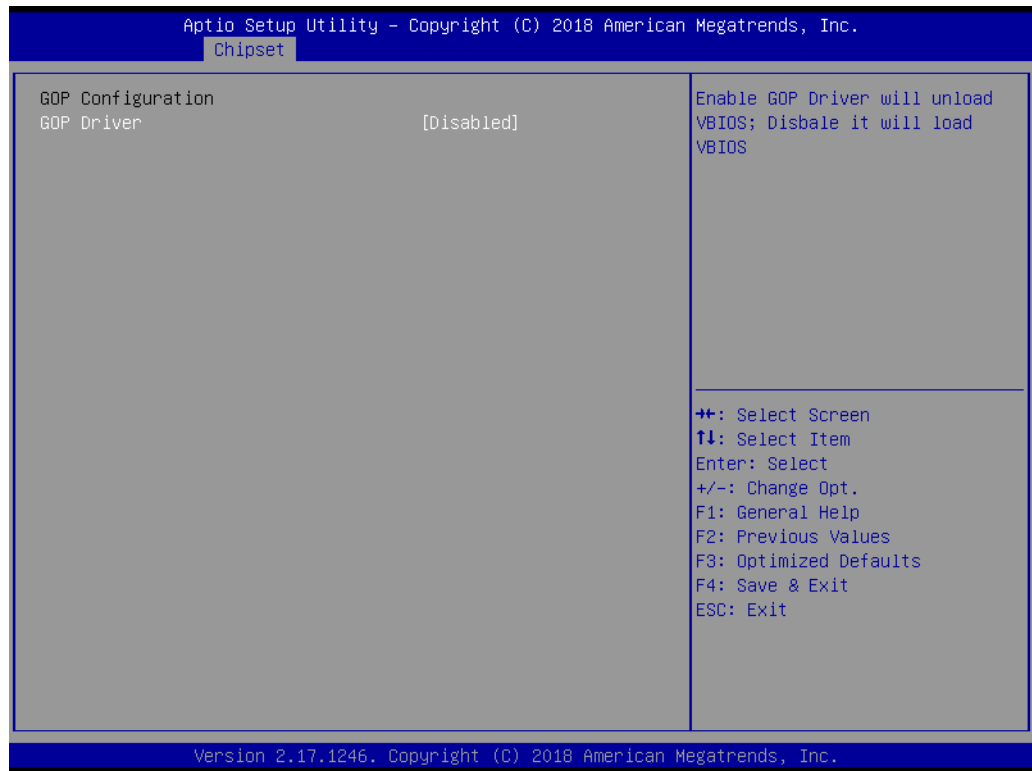

- **GOP Driver**  
Enable GOP Driver will unload VBIOS; Disable it will load VBIOS.

### C.1.3.1 Intel IGD Configuration

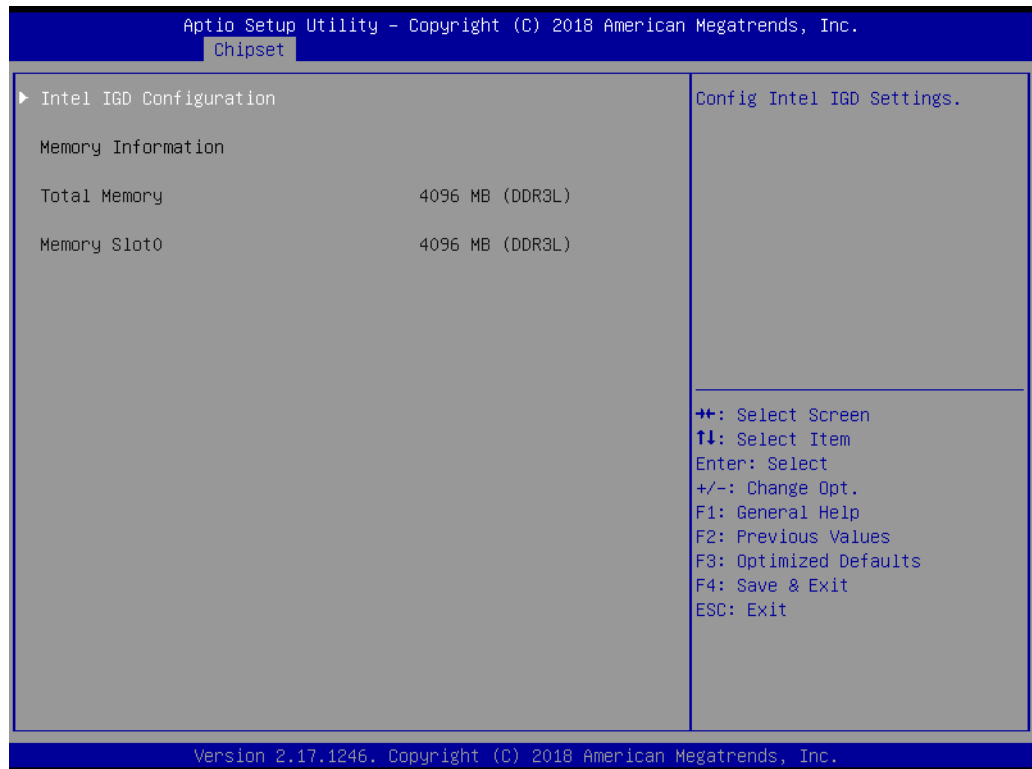

- **Intel IGD Configuration**  
Configure Intel IGD Settings

## C.1.4 Security

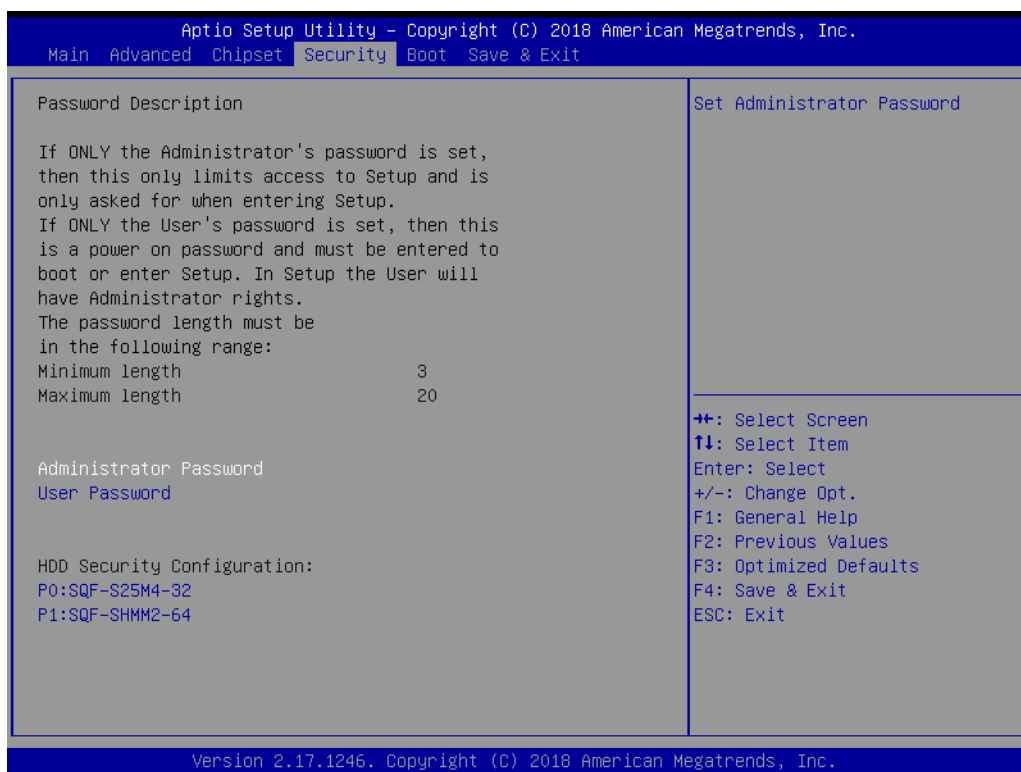

Select Security Setup from the Setup main BIOS setup menu. All Security Setup options, such as password protection and virus protection are described in this section. To access the sub menu for the following items, select the item and press <Enter>:

- **Administrator Password**  
Set Administrator Password.
- **User Password**  
Set User Password.

## C.1.5 Boot

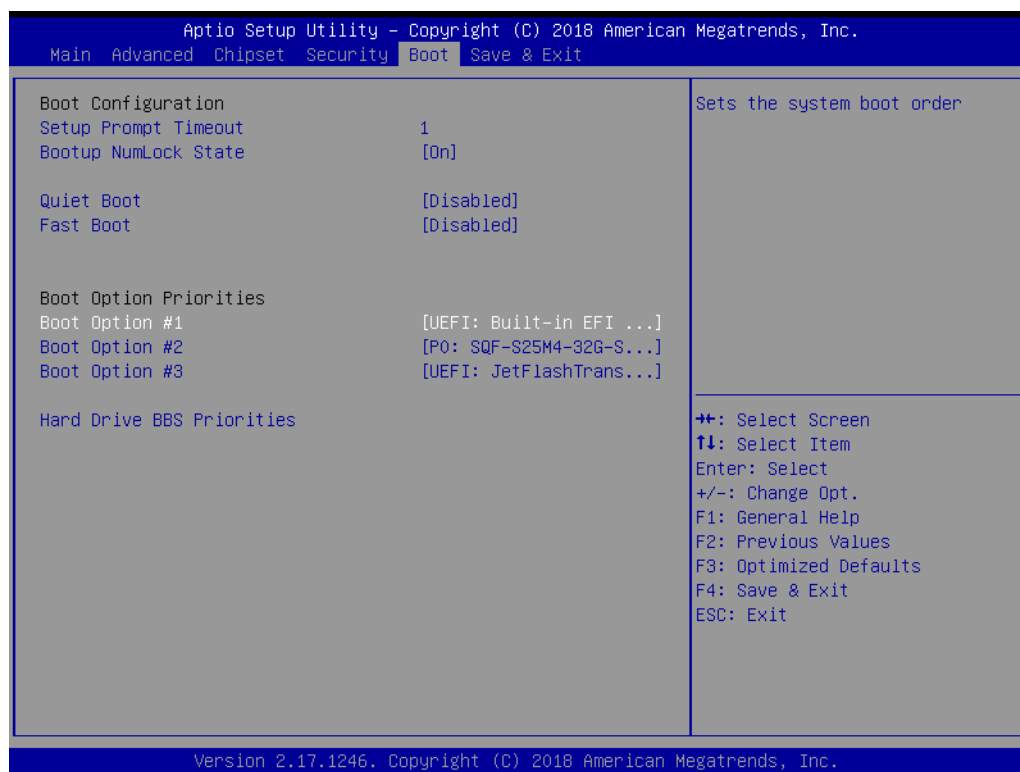

- **Setup Prompt Timeout**  
Number of seconds that the firmware will wait before initiating the original default boot selection. A value of 0 indicates that the default boot selection is to be initiated immediately on boot. A value of 65535(0xFFFF) indicates that firmware will wait for user input before booting. This means the default boot selection is not automatically started by the firmware.
- **Bootup NumLock State**  
Select the keyboard NumLock state
- **Quiet Boot**  
Enables or disables Quiet Boot option
- **Fast Boot**  
Enables or disables boot with initialization of a minimal set of devices required to launch active boot option. Has no effect for BBS boot options.
- **Boot Option #1**  
Sets the system boot order
- **Boot Option #2**  
Sets the system boot order

## C.1.6 Save & Exit



- **Save Changes and Exit**  
This item allows you to exit system setup after saving the changes.
- **Discard Changes and Exit**  
This item allows you to exit system setup without saving any changes.
- **Save Changes and Reset**  
This item allows you to reset the system after saving the changes.
- **Discard Changes and Reset**  
This item allows you to rest system setup without saving any changes.
- **Save Changes**  
This item allows you to save changes done so far to any of the options.
- **Discard Changes**  
This item allows you to discard changes done so far to any of the options.
- **Restore Defaults**  
This item allows you to restore/load default values for all the options.
- **Save as User Defaults**  
This item allows you to save the changes done so far as user defaults.
- **Restore User Defaults**  
This item allows you to restore the user defaults to all the options.
- **Boot Override**  
Boot device select can override your boot priority.
- **Launch EFI Shell from files system device**  
Attempts to Launch EFI Shell application (Shell.efi) from one of the available file system devices.

## [www.advantech.com](http://www.advantech.com)

Please verify specifications before quoting. This guide is intended for reference purpOS only.

All product specifications are subject to change without notice.

No part of this publication may be reproduced in any form or by any means, electronic, photocopying, recording or otherwise, without prior written permission of the publisher.

All brand and product names are trademarks or registered trademarks of their respective companies.

© Advantech Co., Ltd. 2019