



User Manual

UBC-DS31

Smart Digital Signage Player

ADVANTECH

Enabling an Intelligent Planet

Copyright

The documentation and the software included with this product are copyrighted 2014 by Advantech Co., Ltd. All rights are reserved. Advantech Co., Ltd. reserves the right to make improvements in the products described in this manual at any time without notice. No part of this manual may be reproduced, copied, translated or transmitted in any form or by any means without the prior written permission of Advantech Co., Ltd. Information provided in this manual is intended to be accurate and reliable. However, Advantech Co., Ltd. assumes no responsibility for its use, nor for any infringements of the rights of third parties, which may result from its use.

Acknowledgements

ARM is trademark of ARM Corporation.

Freescale is trademark of Freescale Corporation.

All other product names or trademarks are properties of their respective owners.

For more information about this and other Advantech products, please visit our website at:

<http://www.advantech.com/>

<http://www.advantech.com/ePlatform/>

For technical support and service, please visit our support website at:

<http://support.advantech.com.tw/support/>

Product Warranty (2 years)

Advantech warrants to you, the original purchaser, that each of its products will be free from defects in materials and workmanship for two years from the date of purchase.

This warranty does not apply to any products which have been repaired or altered by persons other than repair personnel authorized by Advantech, or which have been subject to misuse, abuse, accident or improper installation. Advantech assumes no liability under the terms of this warranty as a consequence of such events.

Because of Advantech's high quality-control standards and rigorous testing, most of our customers never need to use our repair service. If an Advantech product is defective, it will be repaired or replaced at no charge during the warranty period. For out-of-warranty repairs, you will be billed according to the cost of replacement materials, service time and freight. Please consult your dealer for more details.

If you think you have a defective product, follow these steps:

1. Collect all the information about the problem encountered. (For example, CPU speed, Advantech products used, other hardware and software used, etc.) Note anything abnormal and list any onscreen messages you get when the problem occurs.
2. Call your dealer and describe the problem. Please have your manual, product, and any helpful information readily available.
3. If your product is diagnosed as defective, obtain an RMA (return merchandise authorization) number from your dealer. This allows us to process your return more quickly.
4. Carefully pack the defective product, a fully-completed Repair and Replacement Order Card and a photocopy proof of purchase date (such as your sales receipt) in a shippable container. A product returned without proof of the purchase date is not eligible for warranty service.
5. Write the RMA number visibly on the outside of the package and ship it prepaid to your dealer.

Declaration of Conformity

FCC Class B

Note: This equipment has been tested and found to comply with the limits for a Class B digital device, pursuant to part 15 of the FCC Rules. These limits are designed to provide reasonable protection against harmful interference in a residential installation. This equipment generates, uses and can radiate radio frequency energy and, if not installed and used in accordance with the instructions, may cause harmful interference to radio communications. However, there is no guarantee that interference will not occur in a particular installation. If this equipment does cause harmful interference to radio or television reception, which can be determined by turning the equipment off and on, the user is encouraged to try to correct the interference by one or more of the following measures:

- Reorient or relocate the receiving antenna.
- Increase the separation between the equipment and receiver.
- Connect the equipment into an outlet on a circuit different from that to which the receiver is connected.
- Consult the dealer or an experienced radio/TV technician for help.

Technical Support and Assistance

1. Visit the Advantech website at <http://support.advantech.com> where you can find the latest information about the product.
2. Contact your distributor, sales representative, or Advantech's customer service center for technical support if you need additional assistance. Please have the following information ready before you call:
 - Product name and serial number
 - Description of your peripheral attachments
 - Description of your software (operating system, version, application software, etc.)
 - A complete description of the problem
 - The exact wording of any error messages

Warnings, Cautions and Notes

Warning! Warnings indicate conditions, which if not observed, can cause personal injury!



Caution! Cautions are included to help you avoid damaging hardware or losing data. e.g.



There is a danger of a new battery exploding if it is incorrectly installed. Do not attempt to recharge, force open, or heat the battery. Replace the battery only with the same or equivalent type recommended by the manufacturer. Discard used batteries according to the manufacturer's instructions.

Note! Notes provide optional additional information.



Packing List

Before setting up the system, check that the items listed below are included and in good condition. If any item does not accord with the table, please contact your dealer immediately.

- 1x UBC-DS31 unit
- 1x VESA bracket
- 1x SD cover
- 1x Screws package
- 1x 2 years warranty card
- 1x Quick start guide

Ordering Information

Model Number	Description
UBC-DS31CD-MDA1E	Freescall i.mx6 1.0GHz Dual w/ VGA+HDMI+COM+USB+GBE+Audio+miniPCIe+SIM slot

Optional Accessories

Model Number	Description
1757003553	Adaptor 100-240V 36W 12V 3A W/O PFC 9NA0361603
1700001524	3-pin USA standard power cord
170203183C	3-pin Europe standard cord
170203180A	3-pin UK standard power cord.
1990022422S000	Fixed rail 71.3Lx6.2W mm YJC-64C for UBC-DS31
1990022423S000	Fixed ring DIA:7.5-8.5 FWM-8K for UBC-DS31
1700021565-01	Debug cable

Safety Instructions

1. Read these safety instructions carefully.
2. Keep this User Manual for later reference.
3. Disconnect this equipment from any AC outlet before cleaning. Use a damp cloth. Do not use liquid or spray detergents for cleaning.
4. For plug-in equipment, the power outlet socket must be located near the equipment and must be easily accessible.
5. Keep this equipment away from humidity.
6. Put this equipment on a reliable surface during installation. Dropping it or letting it fall may cause damage.
7. The openings on the enclosure are for air convection. Protect the equipment from overheating. **DO NOT COVER THE OPENINGS.**
8. Make sure the voltage of the power source is correct before connecting the equipment to the power outlet.
9. Position the power cord so that people cannot step on it. Do not place anything over the power cord.
10. All cautions and warnings on the equipment should be noted.
11. If the equipment is not used for a long time, disconnect it from the power source to avoid damage by transient overvoltage.
12. Never pour any liquid into an opening. This may cause fire or electrical shock.
13. Never open the equipment. For safety reasons, the equipment should be opened only by qualified service personnel.
14. If one of the following situations arises, get the equipment checked by service personnel:
 - The power cord or plug is damaged.
 - Liquid has penetrated into the equipment.
 - The equipment has been exposed to moisture.
 - The equipment does not work well, or you cannot get it to work according to the user's manual.
 - The equipment has been dropped and damaged.
 - The equipment has obvious signs of breakage.
15. **DO NOT LEAVE THIS EQUIPMENT IN AN ENVIRONMENT WHERE THE STORAGE TEMPERATURE MAY GO BELOW -20° C (-4° F) OR ABOVE 60° C (140° F). THIS COULD DAMAGE THE EQUIPMENT. THE EQUIPMENT SHOULD BE IN A CONTROLLED ENVIRONMENT.**
16. **CAUTION: DANGER OF EXPLOSION IF BATTERY IS INCORRECTLY REPLACED. REPLACE ONLY WITH THE SAME OR EQUIVALENT TYPE RECOMMENDED BY THE MANUFACTURER, DISCARD USED BATTERIES ACCORDING TO THE MANUFACTURER'S INSTRUCTIONS.**

The sound pressure level at the operator's position according to IEC 704-1:1982 is no more than 70 dB (A).

DISCLAIMER: This set of instructions is given according to IEC 704-1. Advantech disclaims all responsibility for the accuracy of any statements contained herein.

Safety Precaution - Static Electricity

Follow these simple precautions to protect yourself from harm and the products from damage.

- To avoid electrical shock, always disconnect the power from your PC chassis before you work on it. Don't touch any components on the CPU card or other cards while the PC is on.
- Disconnect power before making any configuration changes. The sudden rush of power as you connect a jumper or install a card may damage sensitive electronic components.

Contents

Chapter 1 General Introduction1

1.1	Introduction	2
1.2	Product Features.....	2
	1.2.1 Key Features.....	2
	1.2.2 General	2
	1.2.3 Graphic	2
	1.2.4 Ethernet	2
	1.2.5 Power Consumption.....	3
1.3	Mechanical Specification.....	3
	1.3.1 Dimensions	3
	1.3.2 Weight.....	3
1.4	Power Requirements.....	3
	1.4.1 System Power.....	3
	1.4.2 RTC Battery	3
1.5	Environment Specifications	4
	1.5.1 Operating Temperature.....	4
	1.5.2 Relative Humidity	4
	1.5.3 Storage Temperature.....	4
	1.5.4 Vibration Loading during Operation	4
	1.5.5 EMC	4

Chapter 2 Hardware Functionality5

2.1	Introduction	6
2.2	UBC-DS31 I/O Indication	6
	Figure 2.1 UBC-DS31 front view	6
	Figure 2.2 UBC-DS31 LED indication.....	6
	Figure 2.3 UBC-DS31 left side view	6
2.3	UBC-DS31 I/O Connectors	7
	2.3.1 Power Input Connector	7
	Figure 2.4 Power input connector.....	7
	2.3.2 Reset Button	7
	Figure 2.5 reset button.....	7
	2.3.3 VGA Connector.....	7
	Figure 2.6 VGA connector	7
	Table 2.1: VGA Connector Pin Assignment	7
	2.3.4 COM Connector	8
	Figure 2.7 COM connector	8
	Table 2.2: COM Connector Pin Assignment.....	8
	2.3.5 Ethernet Connector (LAN)	8
	Figure 2.8 Ethernet connector	8
	2.3.6 USB Connector	9
	Figure 2.9 USB connector	9
	Table 2.3: USB Connector Pin Assignment.....	9
	2.3.7 HDMI Connector	9
	Figure 2.10HDMI connector.....	9
	Table 2.4: HDMI Connector Pin Assignment.....	9
	2.3.8 Audio Connector	10
	Figure 2.11audio connector	10
	2.3.9 SD Connector	10
	Figure 2.12SD connector.....	10
	Table 2.5: SD Connector Pin Assignment.....	11
2.4	UBC-DS31 Hardware Installation.....	11
	2.4.1 SD Card Installation	11

	Figure 2.13SD card installation	11
	Figure 2.14Un-docking the system and VESA plate	11
	Figure 2.15Unscrew the two screws.....	12
	Figure 2.16Open the top cover	12
	Figure 2.17Changing the SD cover	13
	Figure 2.18SD cover exchange installation	13
2.4.2	Mounting Assembly method	13
	Figure 2.19VESA and flexible mounting.....	13
2.4.3	Fastener Installation	14
	Figure 2.20Fastening cables	14

Chapter 3 Software Functionality 15

3.1	Software Structure	16
3.2	Installation.....	17
3.2.1	SUSIAccess for Signage Requirement.....	17
3.2.2	Starting Installation	17
	Figure 3.1 Welcome page	18
	Figure 3.2 License term page.....	18
	Figure 3.3 Choose a file location page	19
	Figure 3.4 Confirm page.....	19
	Figure 3.5 Installation page	20
	Figure 3.6 Install success page	20
3.3	Using SUSIAccess for Signage	21
3.3.1	SUSIAccess for Signage Console	21
	Figure 3.7 Main page.....	21
	Figure 3.8 Configuration page	21
	Figure 3.9 General Setting Page	22
	Figure 3.10Wallpaper setting page.....	22
	Figure 3.11Content management page.....	24
	Figure 3.12Modify page	25
	Figure 3.13Export Window	25
	Figure 3.14Confirm to delete window	26
	Figure 3.15Layout page.....	26
	Figure 3.16Layout page.....	27
	Figure 3.17Modify page.....	28
	Figure 3.18Video playlist window	28
	Figure 3.19Picture Playlist Window	29
	Figure 3.20Marquee Editor Window	30
	Figure 3.21Background editor window	31
	Figure 3.22Preview page.....	32
	Figure 3.23Devices List Page.....	33
	Figure 3.24Dispatch window	34
	Figure 3.25Derailed Info device window.....	34
	Figure 3.26Firmware update window	35
	Figure 3.27Device Configuration Window	36
	Figure 3.28Remote device window	37
3.3.2	SUSIAccess for Signage Player	37
	Figure 3.29Network page	37
	Figure 3.30System Page	38
	Figure 3.31Remote Page	39
	Figure 3.32Help Page.....	40

Chapter 1

General Introduction

This chapter gives background information on UBC-DS31 series.

1.1 Introduction

The UBC-DS31 is a smart digital signage player powered by a Freescale ARM® Cortex™-A9 i.MX6 Dual (1 GHz) high performance processor that delivers multimedia on a low power platform. It features a flexible mounting design, full HD high video quality, and the specific management software for Digital signage application.

1.2 Product Features

1.2.1 Key Features

- Freescale ARM® Cortex™-A9 i.MX6 Dual 1GHz high performance processor
- Onboard DDR3 1GB memory and 4GB flash capability
- Supports full HD 1080p Hardware video codec engine
- Networking capability of Gigabit Ethernet
- Supports wallmount, VESA mount for flexible mounting methods
- Low power and fanless design
- SUSIAccess API suite built in

1.2.2 General

- **CPU:** Freescale i.MX6 ARM Cortex™-A9 1GHz with 1GB DDR3 & 4 GB flash onboard.
- **Kernel:** V3.0.35
- **System Memory:** Onboard 1GB DDR3 memory
- **Flash:** Onboard 4 GB e.MMC flash
- **COM Port:** 1 x UART (CTS,RTS,Tx,Rx)
- **USB:** 1 x USB 2.0 Host
- **Audio:** Supports MP3,WAV,AAC format.
- 2 Green LED for the system power and RF status.
- **SD slot:** 1 x SD Slot
- **Power input:** 12 V DC
- **Power reset:** 1 x reset button for system reboot.

1.2.3 Graphic

- **2D/3D Accelerators:** OpenVG 1.1 for 2D, OpenGL ES 2.0 for 3D
- **Video Acceleration:** H.264 HP, MPEG4 ASP, MPEG2 MP
- **Image:** GIF, JPG, BMP, PNG
- **VGA resolution:** 1920 x 1080 @ 60 Hz (1080p)
- **HDMI resolution:** 1920 x1080 @ 60 Hz (1080p)
- **Dual display:** UBC-DS31 supports dual display with the same content.
P.S: The panel resolution must be the same when setting up dual displays.

1.2.4 Ethernet

- 1 x Gigabit Ethernet
- **Speed:** 10/100/1000 Mbps
- **Interface:** 1 x RJ-45 jack with LED

1.2.5 Power Consumption

- **Typical:** 2.3 Watts.
- **Max:** 2.8 Watts.

1.3 Mechanical Specification

1.3.1 Dimensions

- 191 x 1129 x 30 mm (L x W x H) with the metal plate
- 166 x 117 x 30 mm without metal plate

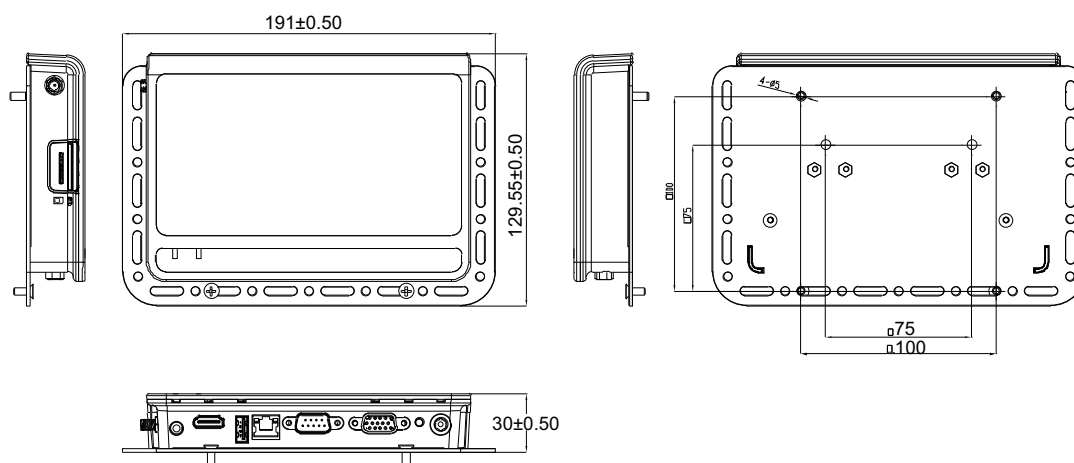

1.3.2 Weight

- 265 g (Net weight)

1.4 Power Requirements

1.4.1 System Power

- **Power input:** DC 12 V

1.4.2 RTC Battery

- 3 V/240 mAh

1.5 Environment Specifications

1.5.1 Operating Temperature

- 0 ~ 40° C (32 ~ 104° F)

1.5.2 Relative Humidity

- 95% @ 40° C (non-condensing)

1.5.3 Storage Temperature

- -20 ~ 60° C (-4 ~ 104° F)

1.5.4 Vibration Loading during Operation

- 1 Gms, IEC 60068-2-64, random, 5 ~ 500 Hz, 1 Oct/min, 1 hr/axis.

1.5.5 EMC

- CE, FCC Class B

Chapter 2

Hardware Functionality

This chapter introduces external I/O and explains the setup procedures of the UBC-DS31 hardware.

2.1 Introduction

The following sections show the external connectors and pin assignments for applications.

2.2 UBC-DS31 I/O Indication

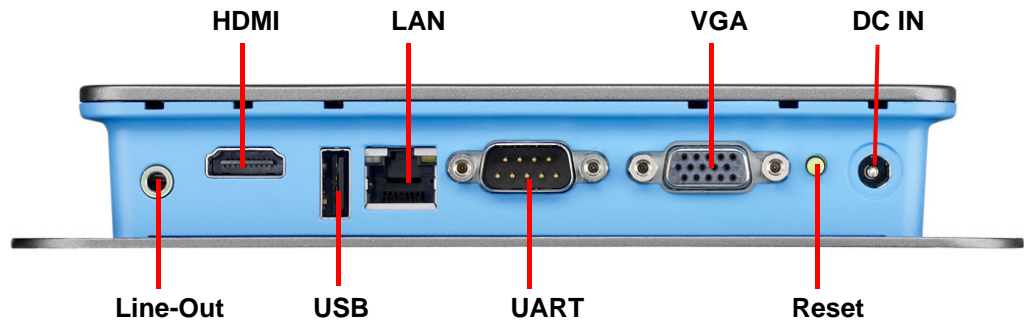

Figure 2.1 UBC-DS31 front view



Figure 2.2 UBC-DS31 LED indication

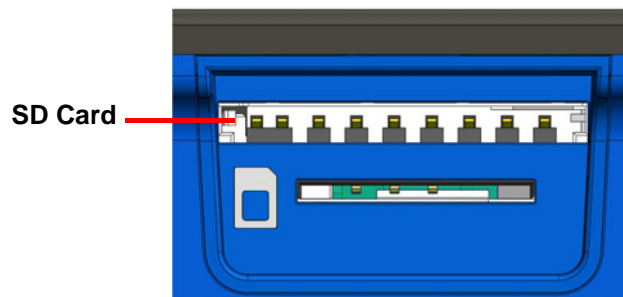

Figure 2.3 UBC-DS31 left side view

2.3 UBC-DS31 I/O Connectors

2.3.1 Power Input Connector

The UBC-DS31 comes with a DC-Jack header that carries 12V DC external power input. The power connector can be fixed by a fastener which is an optional accessory. The fastener avoids power cables falling off.



Figure 2.4 Power input connector

2.3.2 Reset Button

The UBC-DS31 has a reset button on the front side. Press this button to activate the hardware reset function.



Figure 2.5 reset button

2.3.3 VGA Connector

The UBC-DS31 provides a high resolution VGA interface connected by a D-sub 15-pin connector to support VGA monitor. It supports display resolution 1920 x 1080 @ 60 Hz.



Figure 2.6 VGA connector

Table 2.1: VGA Connector Pin Assignment

Pin	Description	Pin	Description
1	VGA_R	2	VGA_G
3	VGA_B	4	N/C
5	GND	6	GND
7	GND	8	GND
9	+5V	10	GND
11	N/C	12	CRT_DDC_DA
13	HSYNC	14	VSYNC
15	CRT_DDC_CK		

2.3.4 COM Connector

The UBC-DS31 provides one D-Sub 9-pin connector serial communication interface port. The port can support RS-232 mode communication.

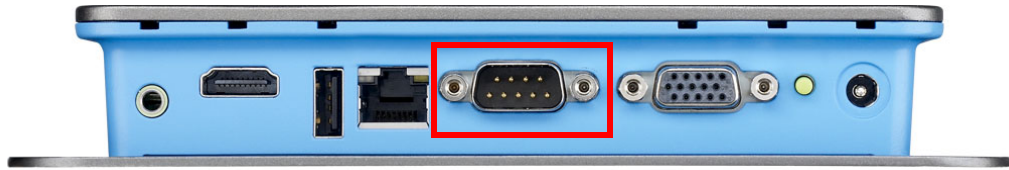

Figure 2.7 COM connector

Table 2.2: COM Connector Pin Assignment

Pin	Description	Pin	Description
1	N/C	2	COM2_RXD
3	COM2_TXD	4	N/C
5	GND	6	N/C
7	COM2_RTS	8	COM2_CTS
9	N/C		

2.3.5 Ethernet Connector (LAN)

The UBC-DS31 provides one RJ45 LAN interface connector, it is fully compliant with IEEE 802.3u 10/100/1000 Base-T CSMA/CD standards. The Ethernet port provides standard RJ-45 connector with LED indicators on the front side to show Active/Link status.



Figure 2.8 Ethernet connector

Pin	Description
R1	GND
R2	MDI0+
R3	MDI0-
R4	MDI1+
R5	MDI1-
R6	MDI2+
R7	MDI2-
R8	MDI3+
R9	MDI3-
R10	GND
L1	+V3.3
L2	LAN_LINK
L3	+V3.3
L4	LAN_ACT

2.3.6 USB Connector

The UBC-DS31 provides one USB interface connector. The USB interface is compliant with USB UHCI, Rev 2.0. The USB interface supports Plug and Play, which allows you to connect or disconnect a device whenever you want, without turning off the computer.



Figure 2.9 USB connector

Table 2.3: USB Connector Pin Assignment

Pin	Description
1	+5V
2	USB Data-
3	USB Data+
4	GND

2.3.7 HDMI Connector

The UBC-DS31 provides one HDMI interface connector which lets all digital audio/video interfaces to transmit uncompressed audio/video signals. It is HDCP and CEC compliant connect the HDMI audio/video device to this port. HDMI technology can support a maximum resolution 1920 x 1080.



Figure 2.10 HDMI connector

Table 2.4: HDMI Connector Pin Assignment

Pin	Description
1	HDMI_TD2+
2	GND
3	HDMI_TD2-
4	HDMI_TD1+
5	GND
6	HDMI_TD1-
7	HDMI_TD0+
8	GND
9	HDMI_TD0-
10	HDMI_CLK+
11	GND
12	HDMI_CLK-
13	HDMI_CEC_A

Table 2.4: HDMI Connector Pin Assignment

14	N/C
15	DDC_CLK_HDMI_A
16	DDC_DATA_HDMI_A
17	GND
18	+5 V_HPDP
19	HDMI_HP

2.3.8 Audio Connector

The UBC-DS31 offers Line-out stereo speakers, and an earphone can be connected to the line out jack.



Figure 2.11 audio connector

2.3.9 SD Connector

The UBC-DS31 provides an SD slot. Users can insert an SD card easily and UBC-DS31 also provides a changeable SD cover to protect the SD card from being stolen. Please refer to section 2.4.x for the installation.

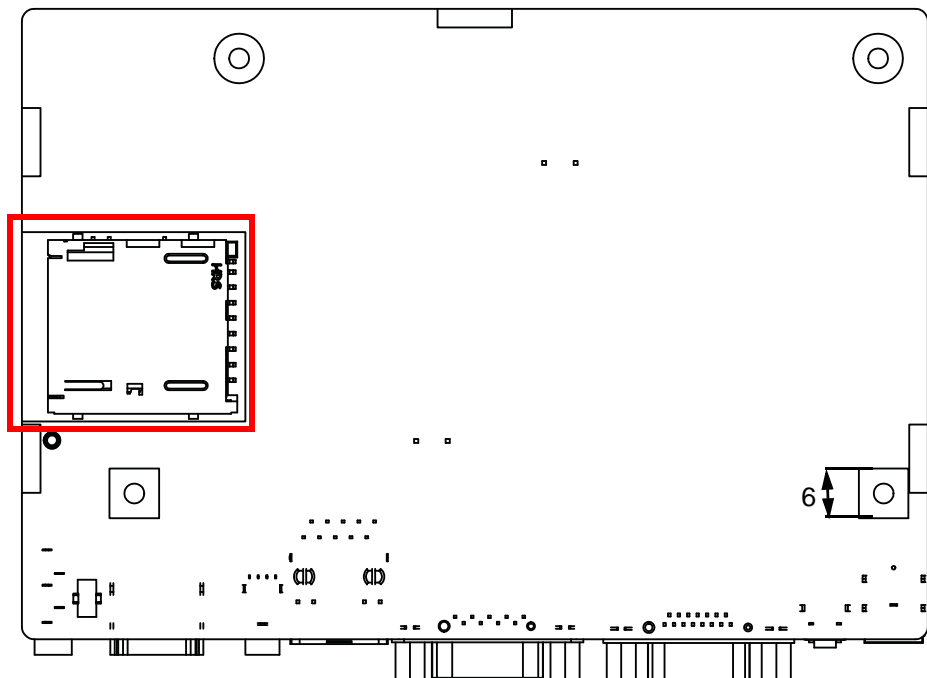

Figure 2.12 SD connector

Table 2.5: SD Connector Pin Assignment

Pin	Description	Pin	Description
1	SD2_DATA3	2	SD2_CMD
3	GND	4	+V3.3
5	SD2_CLK	6	GND
7	SD2_DATA0	8	SD2_DATA1
9	SD2_DATA2	10	SD2_CD#
11	GND	12	SD2_WP

NOTE: It is recommended to use only "Transcend and Sandisk" SD Cards which Advantech has verified.

2.4 UBC-DS31 Hardware Installation

2.4.1 SD Card Installation

1. Remove the power cord.
2. Insert SD Card directly into the UBC-DS31 left side SD slot.



Figure 2.13 SD card installation

3. If you want to protect your SD card from being stolen, you can change the SD cover which doesn't have holes.
 - i. Un-docking the system and VESA plate.

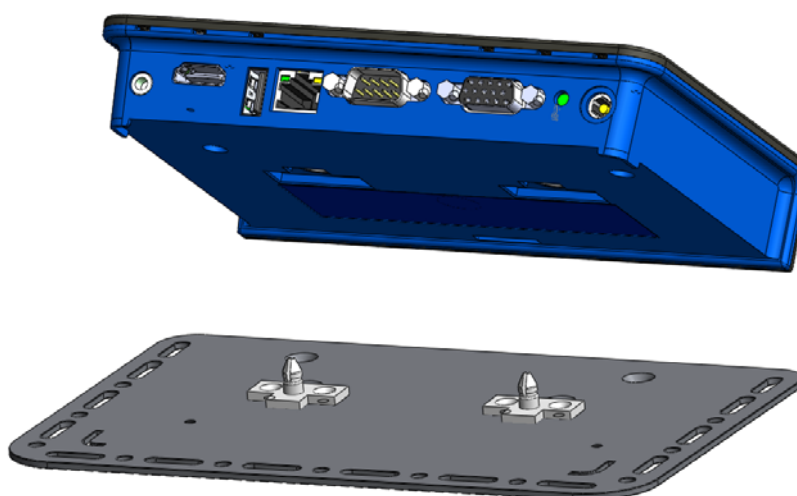

Figure 2.14 Un-docking the system and VESA plate

ii. Unscrew the two screws of UBC-DS31 bottom cover.

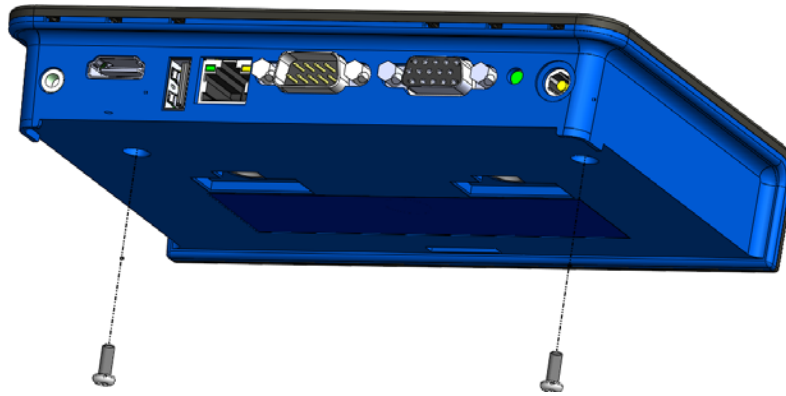

Figure 2.15 Unscrew the two screws

iii. Open the top cover. (the one with UBC-DS31 sticker)



Figure 2.16 Open the top cover

iv. Change the SD cover. (the one without holes)

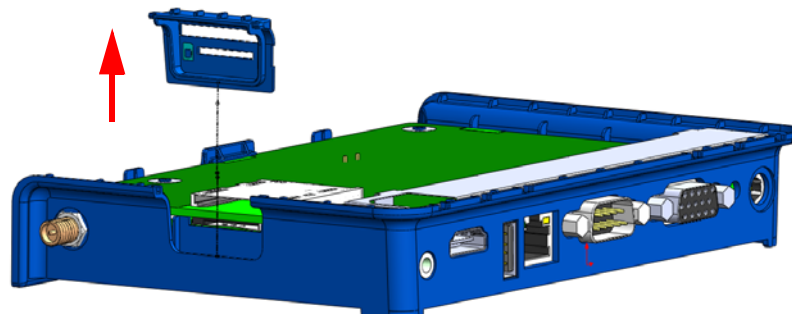

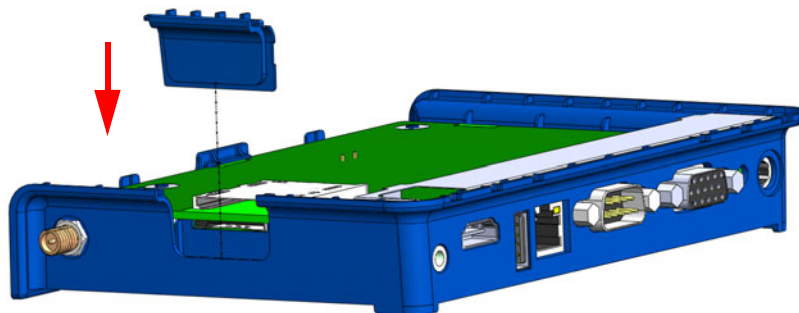

Figure 2.17 Changing the SD cover

- v. Close the top cover and screw back the two screws of the bottom cover.

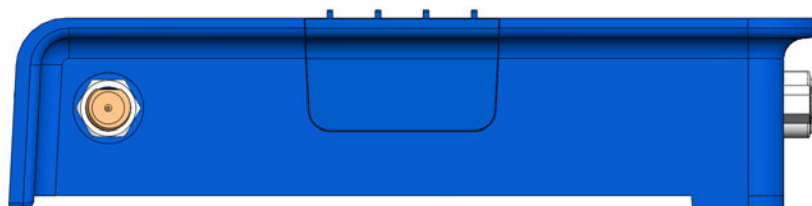

Figure 2.18 SD cover exchange installation

2.4.2 Mounting Assembly method

You can fix UBC-DS31 to a wall by using standard VESA 100x100mm or 75x75mm mounting holes or flexible wall mounting holes.

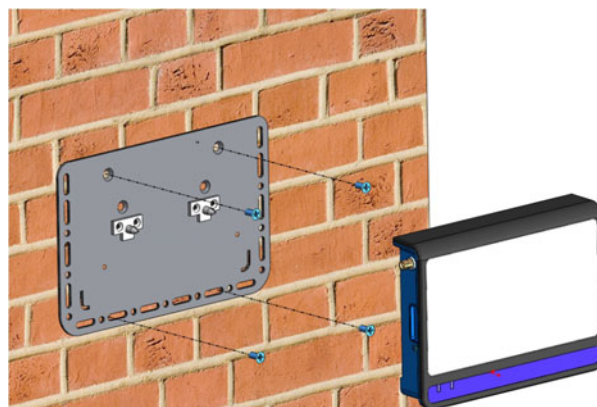
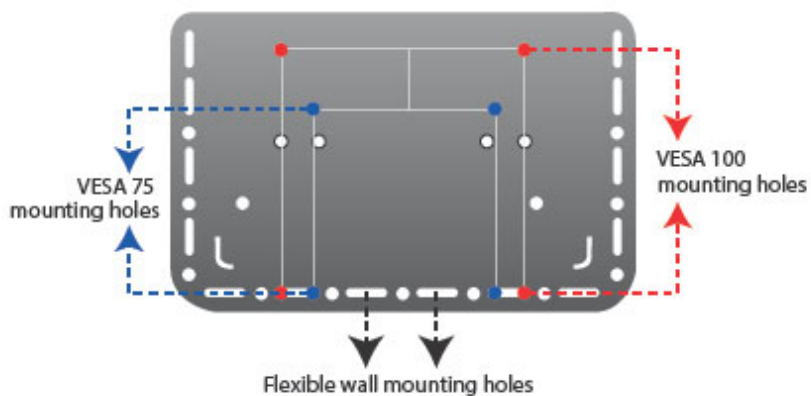

Figure 2.19 VESA and flexible mounting

2.4.3 Fastener Installation

UBC-DS31 provides six connected holes for fastening cables.



Please contact Advantech to purchase the fastener.

The fixed rail: 1990022422S000

The fixed ring: 1990022423S000

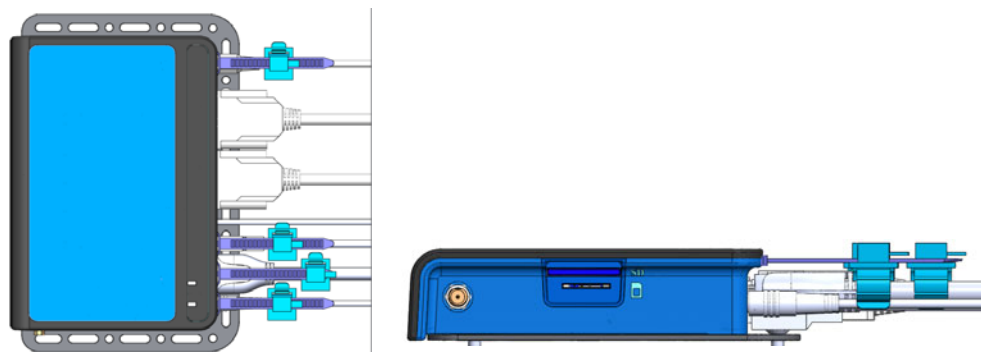

Figure 2.20 Fastening cables

Chapter 3

Software Functionality

This chapter details the SUSI-Access for Signage software operating on UBC-DS31.

3.1 Software Structure

SUSIAccess for signage includes two parts: SUSIAccess for signage console and SUSIAccess for signage player. Below is the software structure.

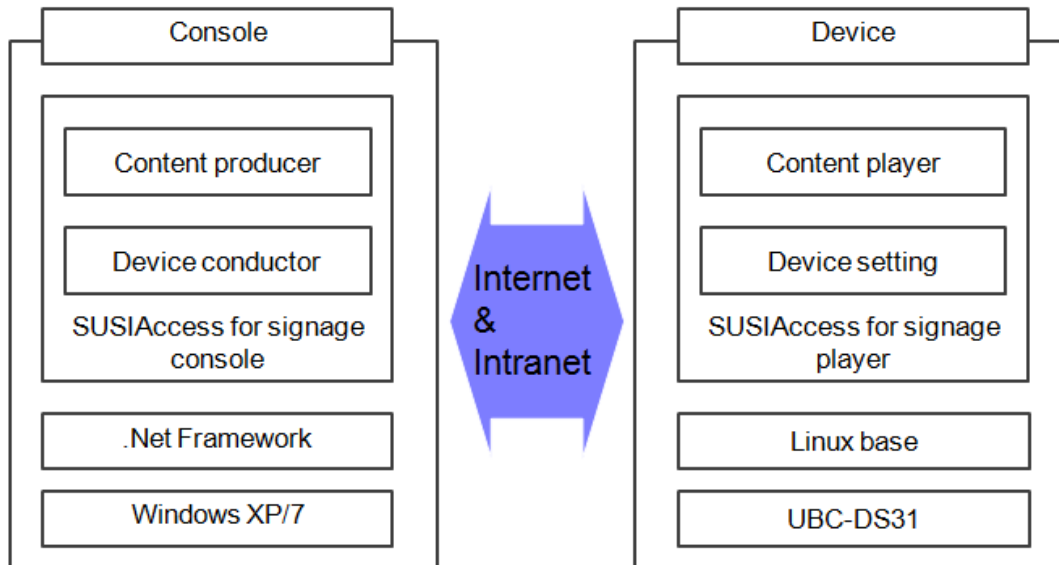

- **SUSIAccess for signage console**
The main program to manage all UBC-DS31 connections contains two application programs: "Content producer" and "Device conductor".
- **SUSIAccess for signage player**
The control program of UBC-DS31 receives commands for SUSIAccess for signage console, playing content and other actions

NOTE: For internet use, users should make sure that the router settings do not block the SUSIAccess for Signage connection port 40832

3.2 Installation

3.2.1 SUSIAccess for Signage Requirement

SUSIAccess for signage console

Operating system: Windows XP 32-bit, Windows 7 32-bit/64 bit

Software: Microsoft .NET Framework 2.0 or higher.

SUSIAccess for signage uses DirectX decoder for videos and pictures. If users want to deco the format that DirectX cannot support, following link provide for reference.

http://www.nvidia.com.tw/object/dvd_decoder_tw.html

http://codecguide.com/download_kl.htm

<http://sourceforge.net/projects/ffdshow-tryout/files/>

<http://www.corecodec.com/products/coreavc>

NOTE: The decoder software in this list is not included in SUSIAccess for signage, as Advantech will not guarantee it. Users should realize and be responsible for downloading and installing it themselves.

SUSIAccess for Signage player

Comes reloaded in UBC-DS31.

3.2.2 Starting Installation

SUSIAccess for signage console

Users can download SUSIAccess for Signage installer from:

http://www.advantech.com/products/UBC-DS31-SERIES/mod_72959823-6081-413C-8995-C0A2B1961D90.aspx

1. Double click to start to install and enter the "Welcome" page.

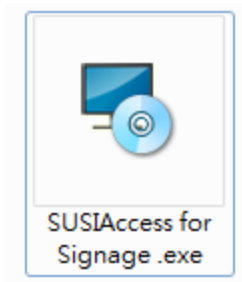

2. Clicking the “Next” button will enter the “License Terms” page.

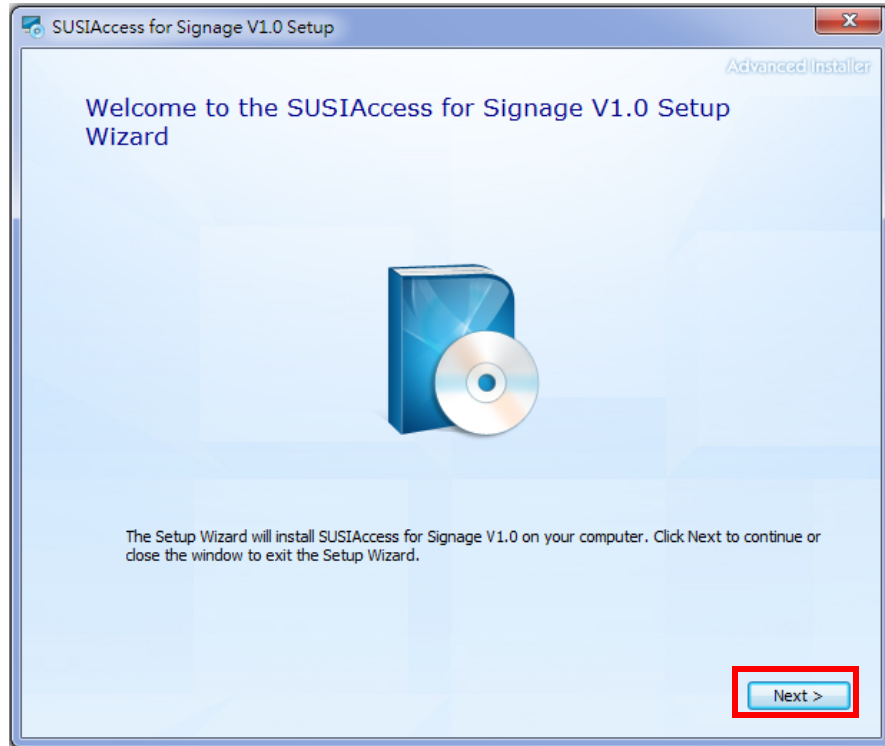



Figure 3.1 Welcome page

3. Click “” button will print the content of “License Terms”. Users need to check the agreement and “accept the terms of this agreement”. After confirming the “License Terms”, clicking “Back” will go back to the “Welcome” page, and clicking “Next” will go to the “Choose a file location” page.

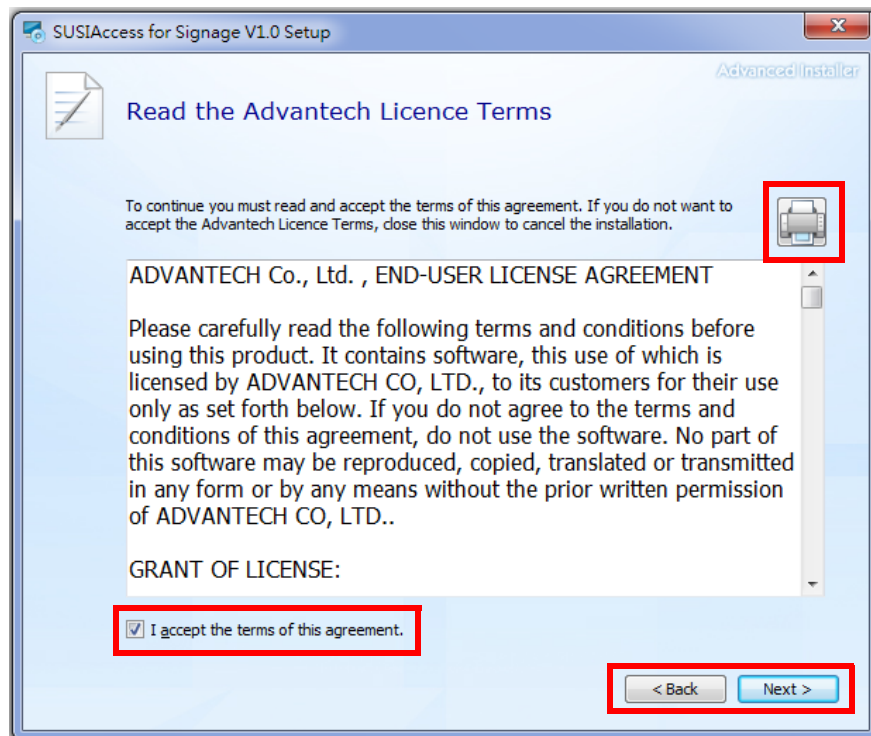

Figure 3.2 License term page

4. User can change the install path by clicking the “Browse...” button, detailed information is shown below. Clicking “Back” will go back to the “Licence Term” page, and clicking “Next” will enter the “Confirm” page.

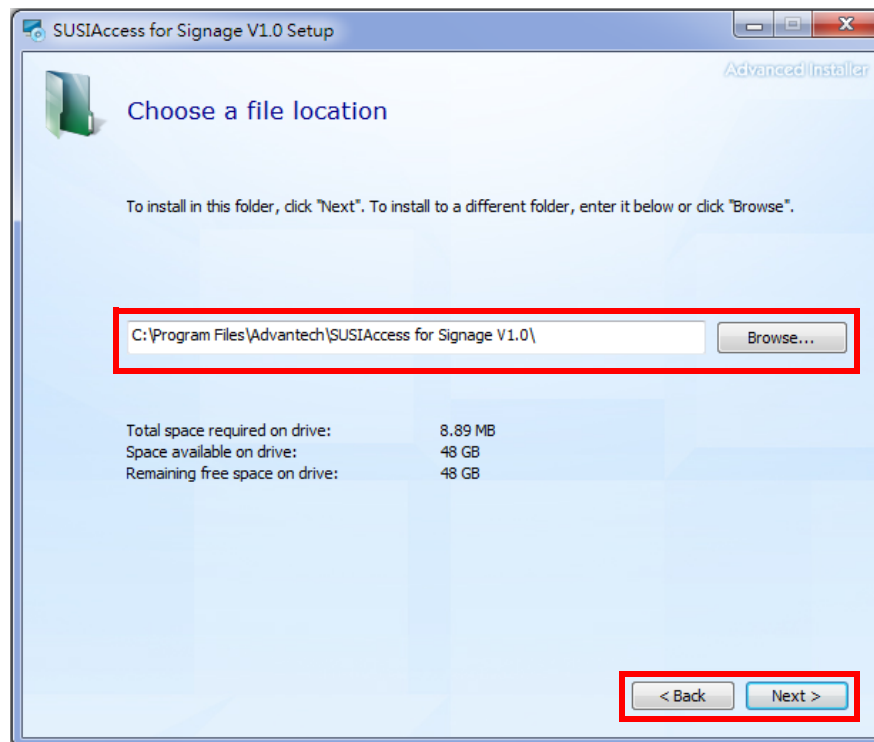

Figure 3.3 Choose a file location page

5. Clicking “Back” will go back to the “Choose a file location” page, and clicking “Install” will start the installation.

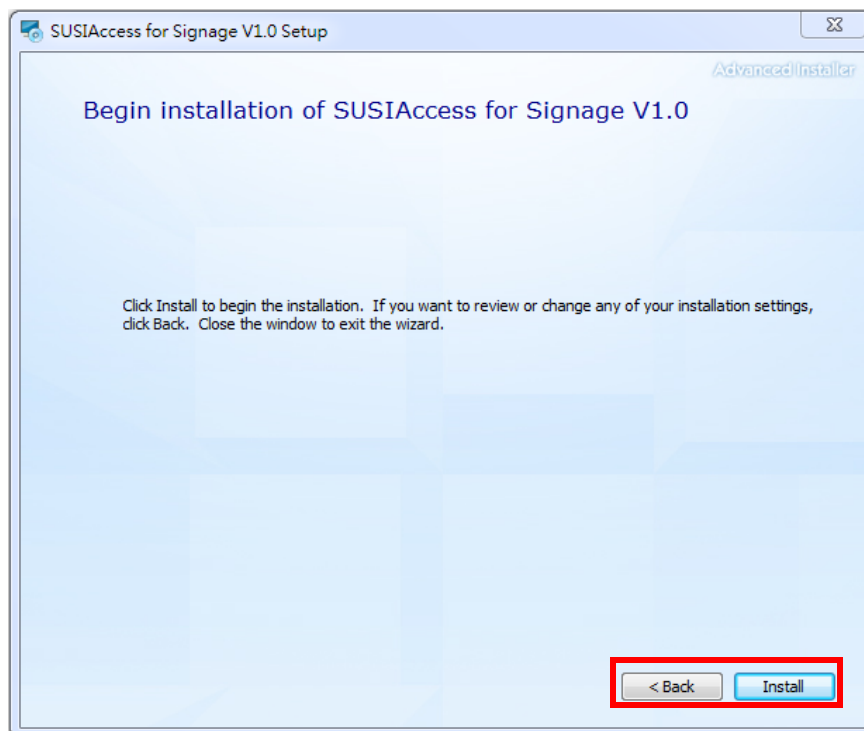

Figure 3.4 Confirm page

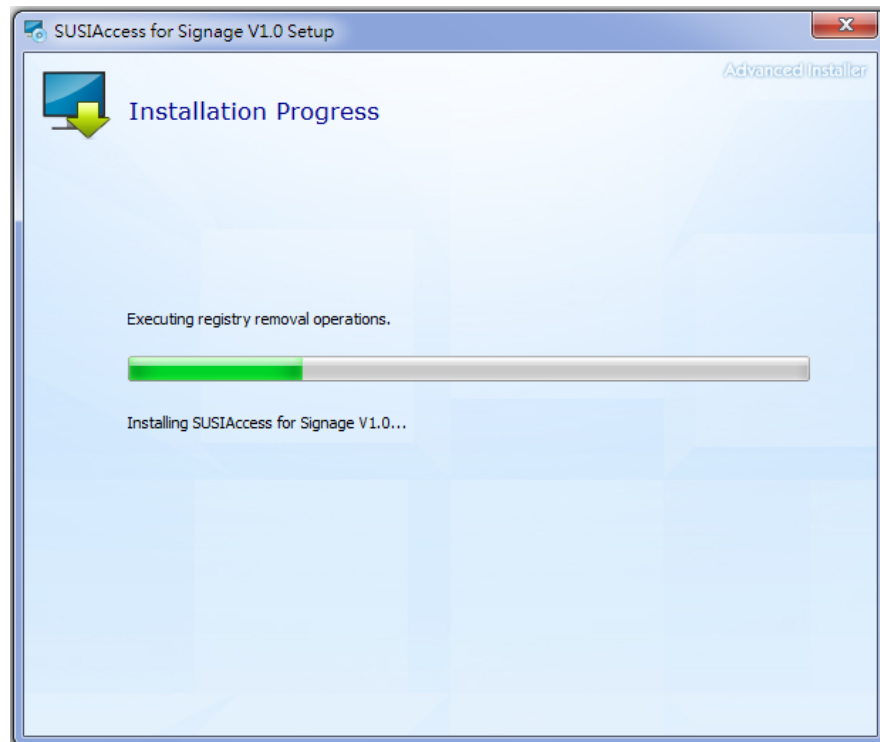

Figure 3.5 Installation page

6. Install success.

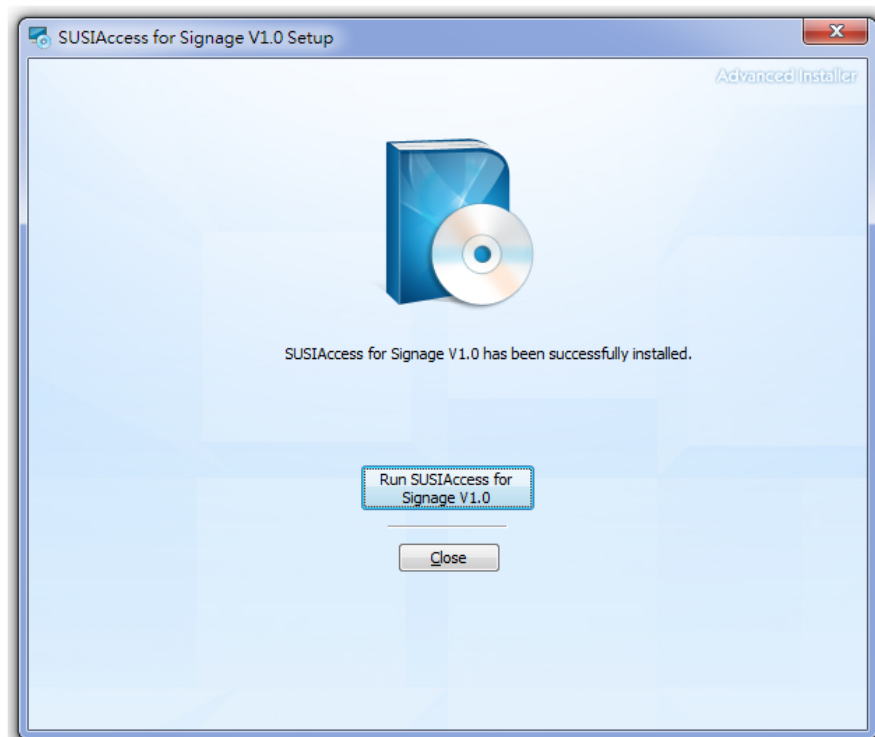

Figure 3.6 Install success page

SUSIAccess for signage player

Comes preloaded in UBC-DS31, no need to install.

3.3 Using SUSIAccess for Signage

3.3.1 SUSIAccess for Signage Console

3.3.1.1 Main page

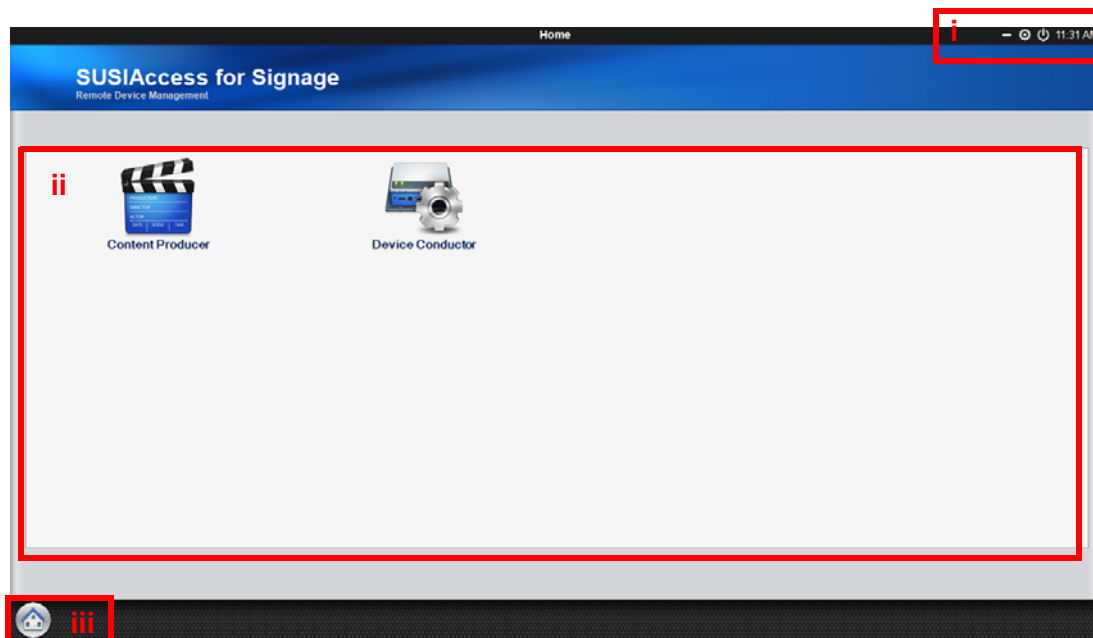
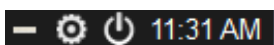

Figure 3.7 Main page



1. Tray Mode
2. Configuration

Clicking  icon enters the configuration page. You can set the configuration including: General, Change Wallpaper, and SUSIAccess Framework Update



Figure 3.8 Configuration page

- General
Clicking "Edit" will enter the "General setting" window.

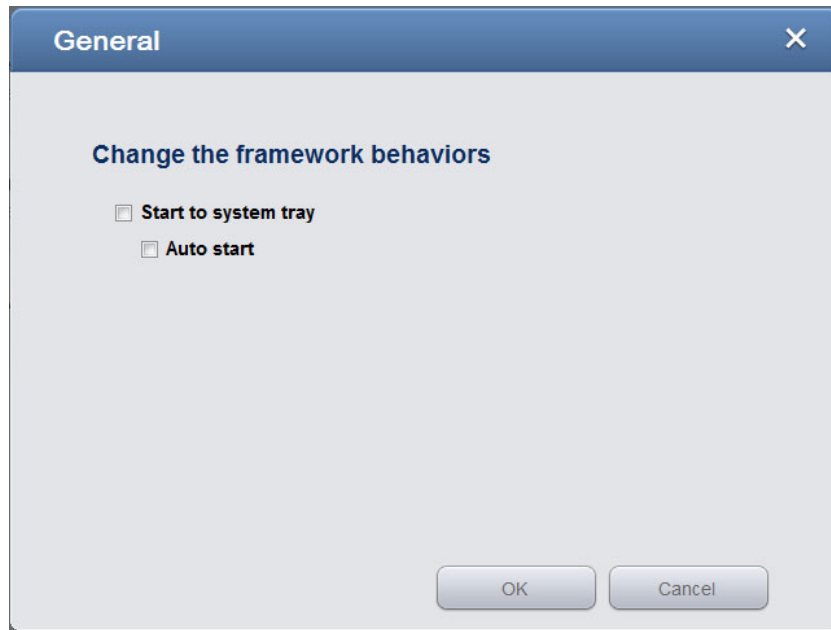

Figure 3.9 General Setting Page

User can set "Start to system tray" (When SUSIAccess for Signage starts) and "Auto start" (When OS ready) here. Clicking "OK" will save the setting, and clicking "Cancel" will go back to "Configuration" page

- Change Wallpaper
Clicking "Edit" will enter the "Wallpaper setting" window.

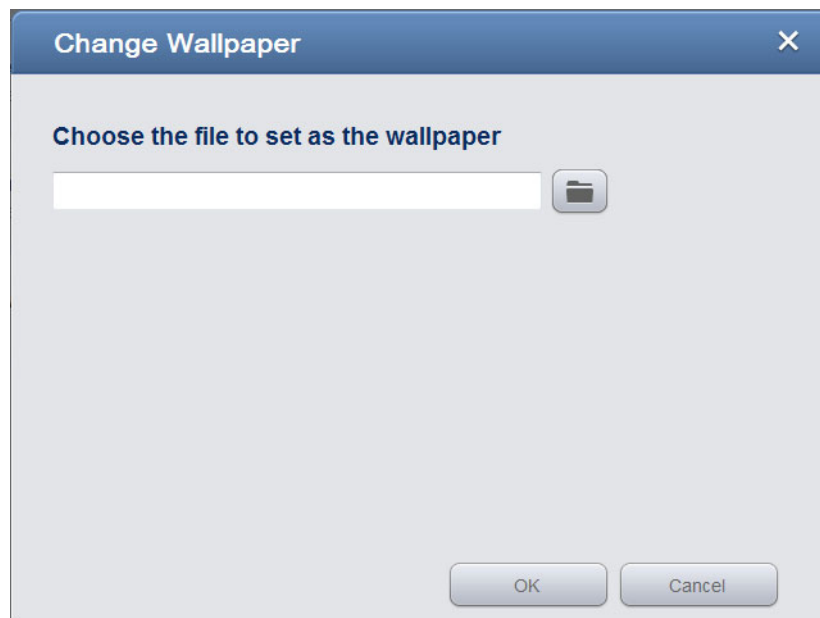

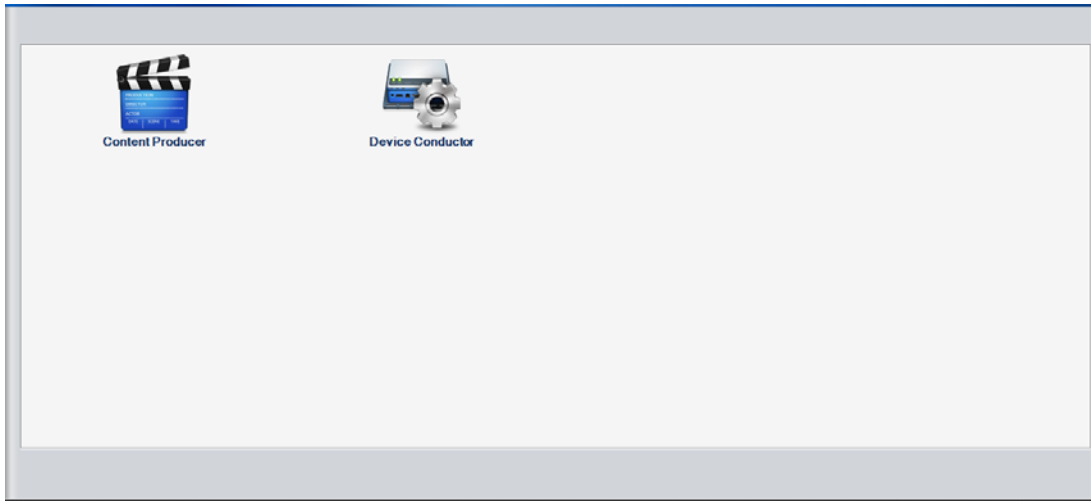

Figure 3.10 Wallpaper setting page

Users can change the wallpaper of SUSIAccess for Signage from this page.

Clicking  can select the picture file.

- SUSIAccess Framework Update
Users can update SUSIAccess for Signage framework from here.
- 3. Close SUSIAccess for Signage
- 4. Time



- Applications platform
All SUSIAccess for signage applications can be used



- Home
Back to main page

3.3.1.2 Content producer



Clicking **Content Producer** enters content producer.

i. “Content Management” page

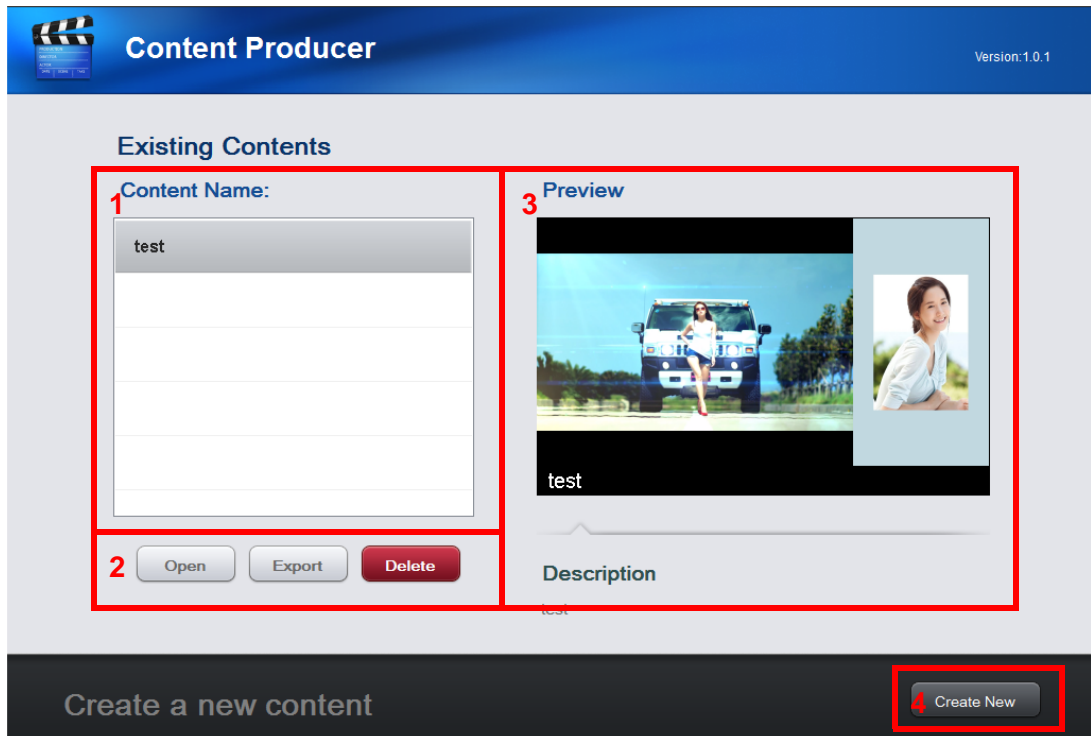

Figure 3.11 Content management page

1. Content name
Show all saved content
2. Control button
 - Open
Open a saved content to edit
Clicking this button will enter the editing page “Modify” as follows

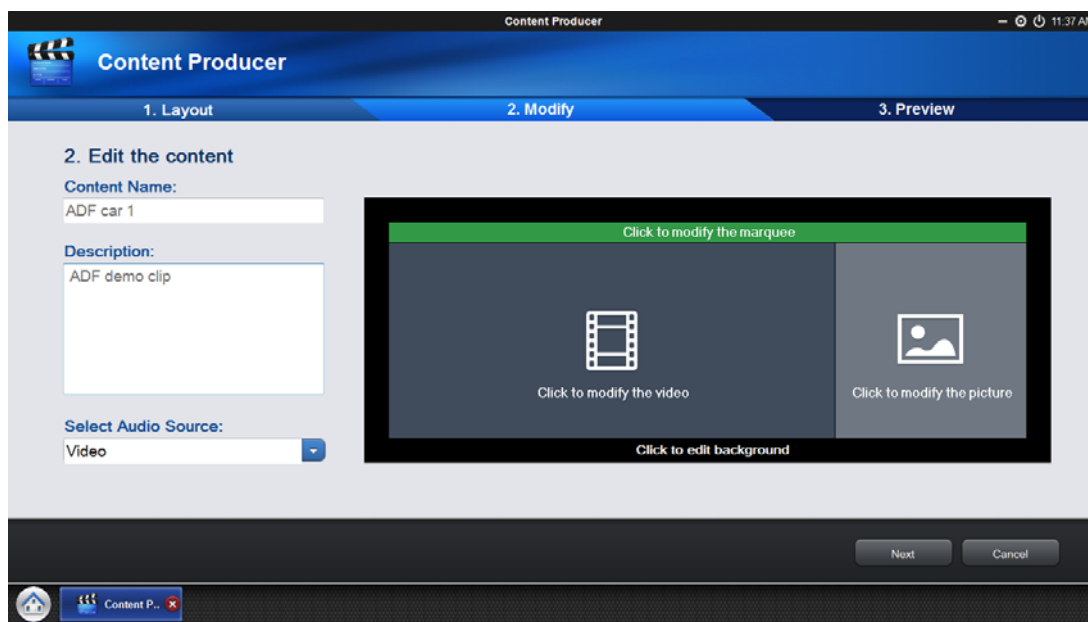

Figure 3.12 Modify page

- Export
Export saved content to the USB disk in the default folder

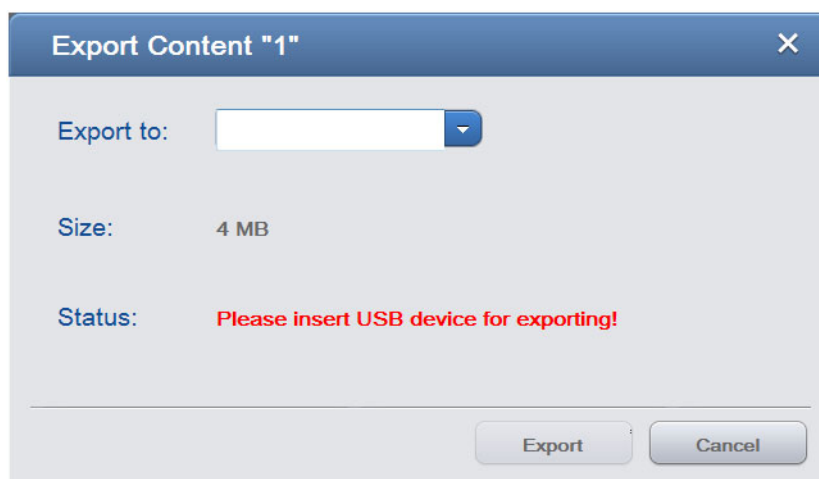

Figure 3.13 Export Window

When users connects the USB disk to USB port of UBC-DS31, UBC-DS31 will play the export content without any operation.

SUSIAccess for Signage can export to a USB disk only; it cannot to export to a local or system hard disk. The exported content will dispatch to UBC-DS31 automatically after the USB disk with exported content plug-in.

- Delete
Delete saved content
Clicking this button will pop-up a confirmation window as follows

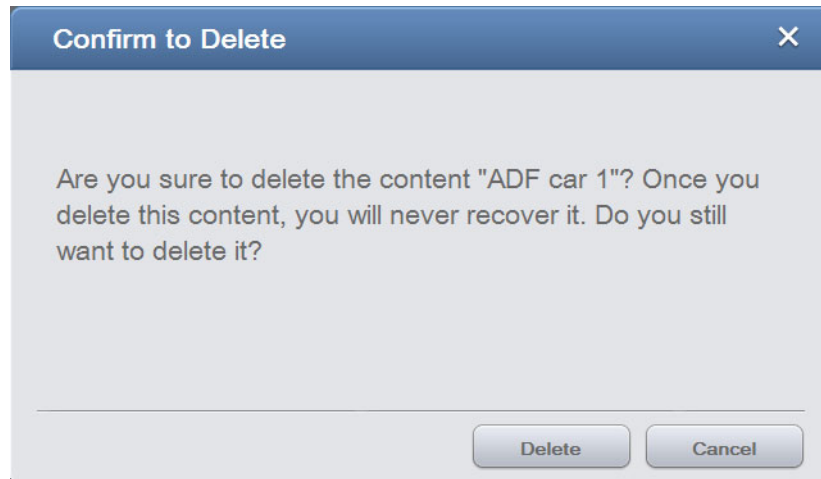

Figure 3.14 Confirm to delete window

3. Preview window
Show the screenshot and description of the selected content
4. Create New
Create a new content. Clicking this button will enter the edit page as follows

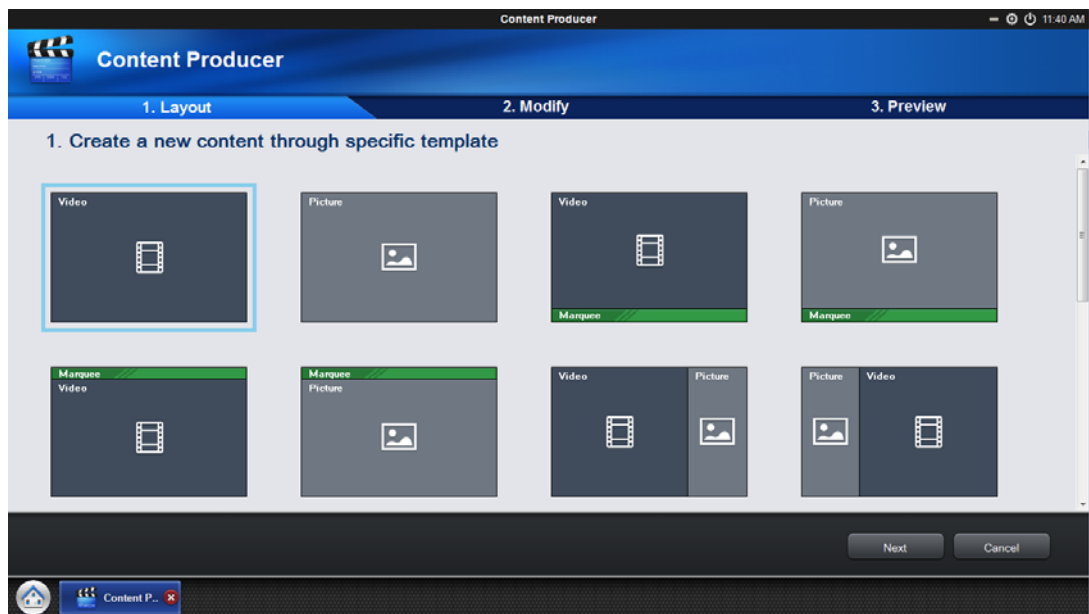

Figure 3.15 Layout page

ii. Editing page – Layout

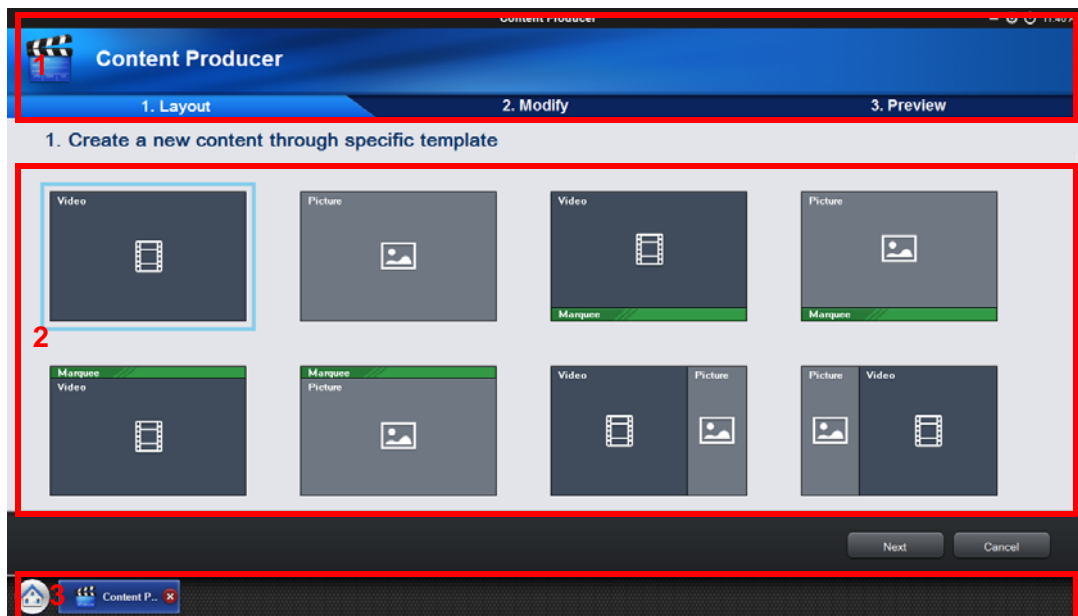

Figure 3.16 Layout page

1. Step bar
 - Show the editing step
2. Layout template
 - Provide default layout template
3. Control button
 - Home
 - Back to start page
 - Next
 - Enter next step
 - Cancel
 - Back to start page

iii. Editing page – Modify

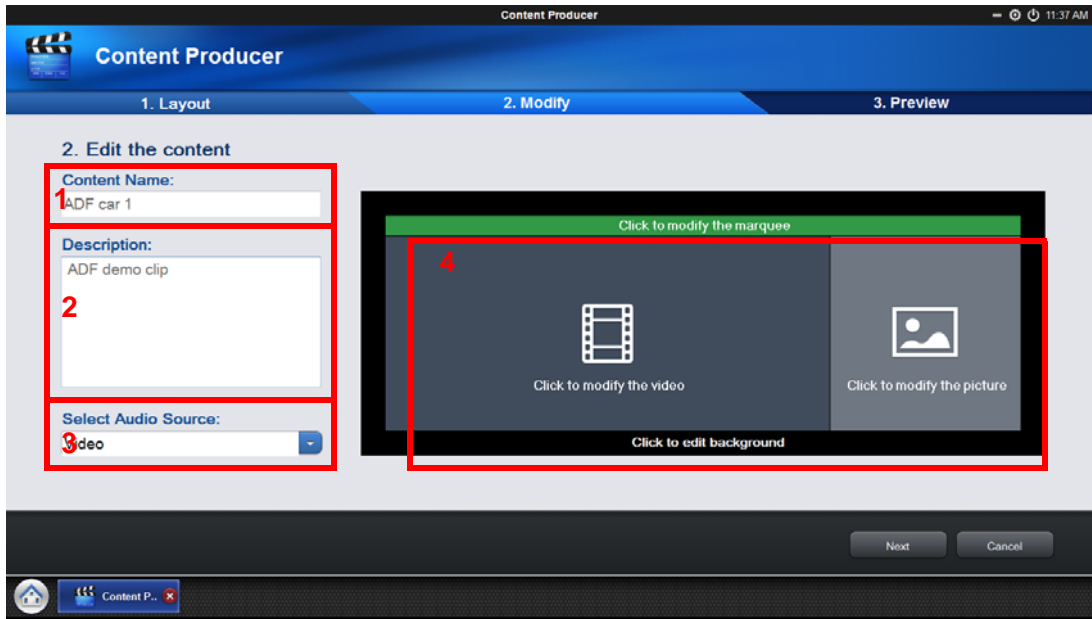

Figure 3.17 Modify page

1. Content Name
Modify content name
2. Description
Modify description
3. Select audio source
4. Editing zone
– Video

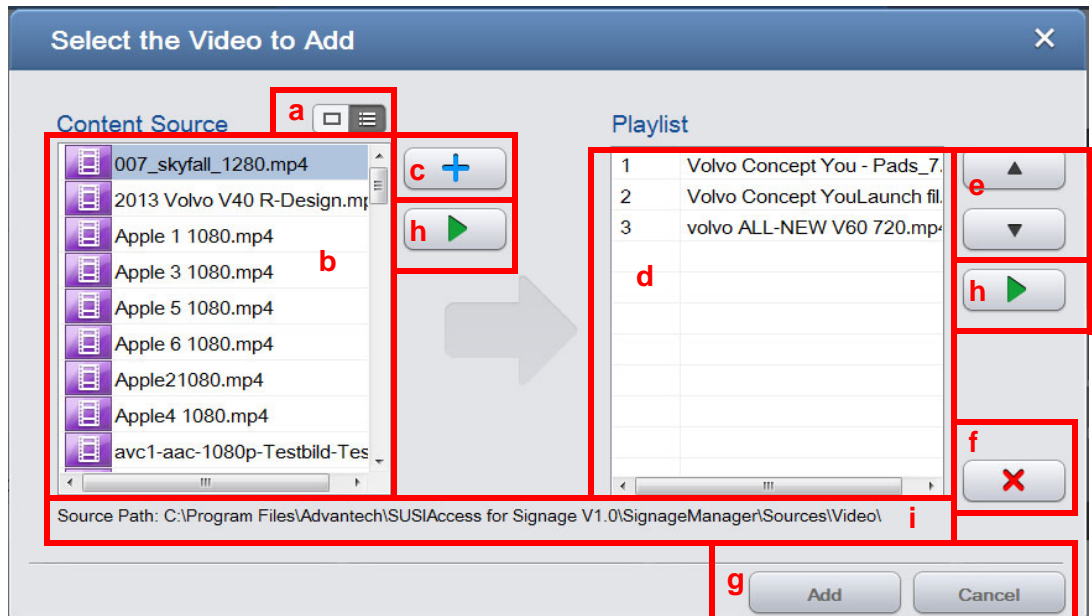

Figure 3.18 Video playlist window

a. Screenshot mode/ list mode



Switch screenshot mode/list mode of content source

b. Content source

This window list files in default path (Default path: SUSIAccess for signage V1.0\signage manager\source, it will also show in i)

c. Add to playlist

Click this button will add the selected file to playlist

d. Playlist

Show all selected files

e. Change order

Click “Up” and “down” will move the file you select up and down at playlist

f. Remove

Click this button will remove the selected file form playlist

g. Add/Cancel

Add: Add this time change of content

Cancel: Cancel this time change of content

h. Preview

Click will pop up a window to play the file you selected

i. Sources files path

– Picture

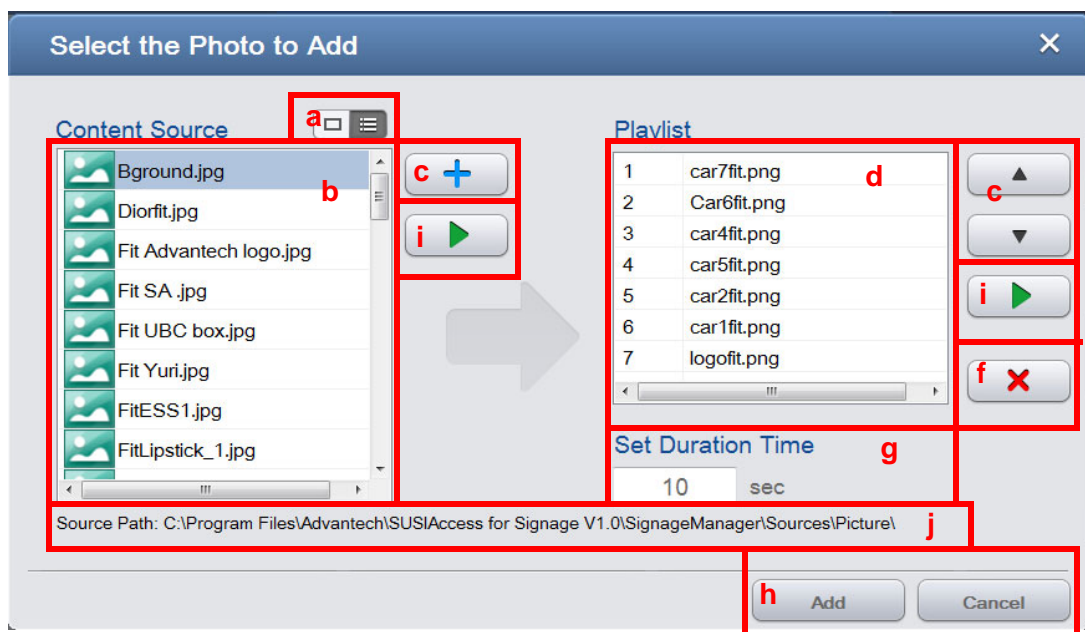

Figure 3.19 Picture Playlist Window

a. Screenshot mode/ list mode

Switch screenshot mode/list mode of content source

- b. Content source
This window list files in default path (SUSIAccess for signage V1.0\signage manager\source)
- c. Add to playlist
Click this button will add the selected file to playlist
- d. Playlist
Show all selected files
- e. Change order
Click “Up” and “down” will move the file you select up and down at playlist
- f. Remove
Click this button will remove the selected file form playlist
- g. Set Duration time
- h. Add/Cancel
Add: Add this time change of content
Cancel: Cancel this time change of content
- i. Preview
Click will pop up a window to play the file you selected
- j. Sources files path

– Marquee

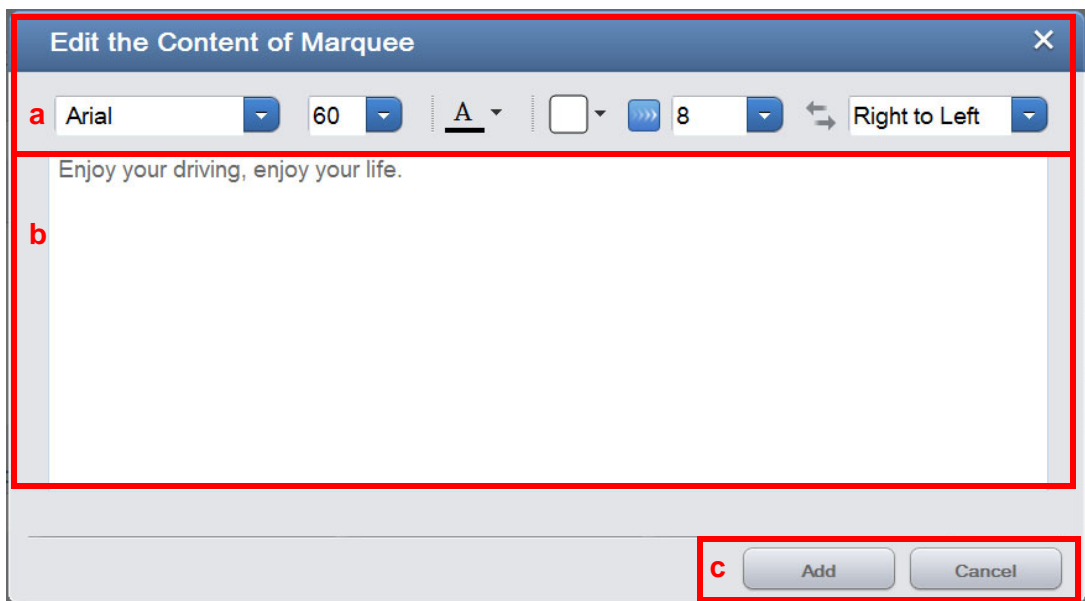

Figure 3.20 Marquee Editor Window

- a. Function bar
Font/ Size/ Color/ Back-color/ Speed/ Direction
- b. Editing zone
- c. Add/Cancel
Add: Add this time change of content
Cancel: Cancel this time change of content

– Background

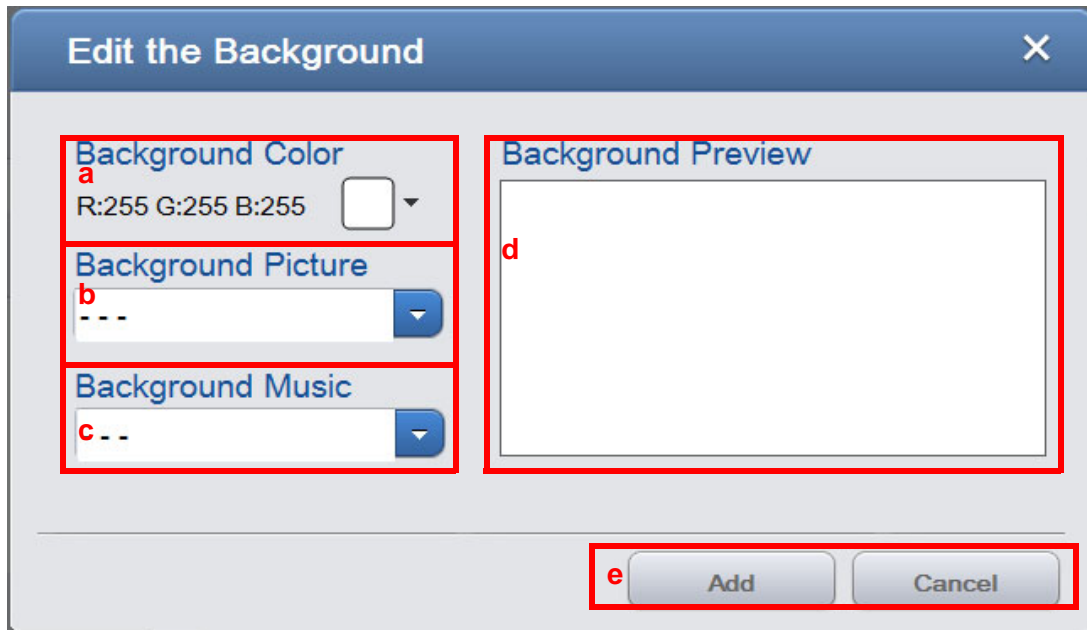

Figure 3.21 Background editor window

- a. Background Color
 - b. Background Picture
 - Using the same resource path with Picture
 - c. Background Music
 - Click will list files in default path (SUSIAccess for signage\signage manager\source)
 - d. Background Preview
 - e. Add/Cancel
 - Add: Add this time change of content
 - Cancel: Cancel this time change of content
5. Next/Cancel
- Enter next step/ Back to start page

iv. Editing page – Preview

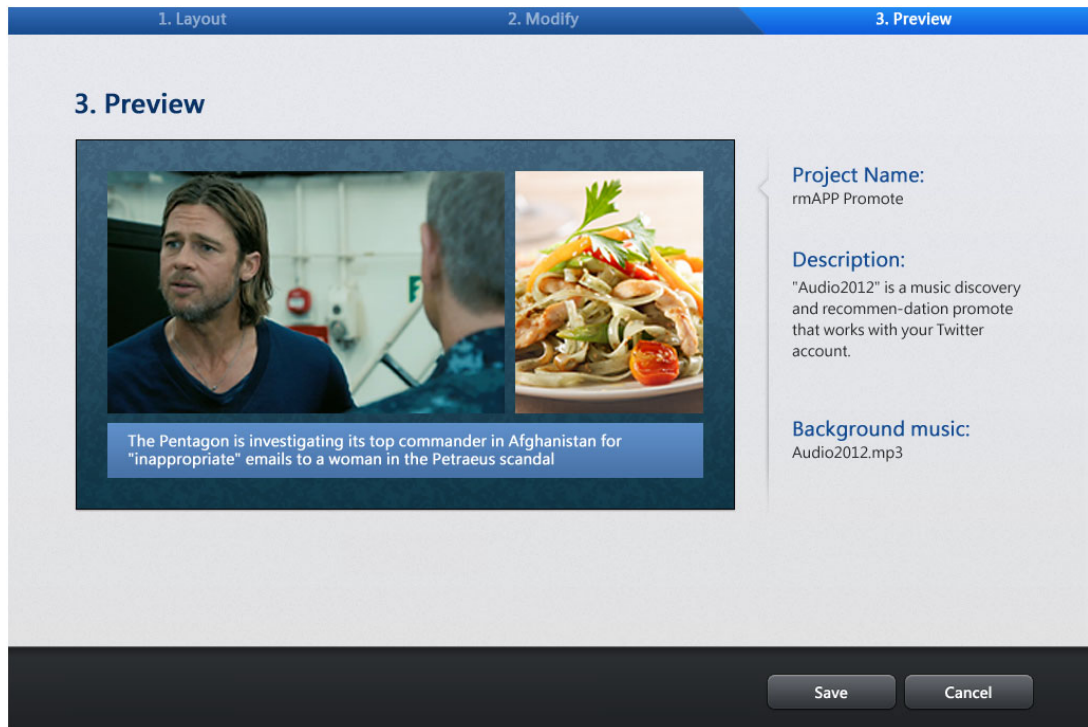

Figure 3.22 Preview page

3.3.1.3 Device conductor



Click [Device Conductor](#) can enter content producer

i. Devices list page

The screenshot shows a web interface for managing devices. On the left, a sidebar contains a counter zone with '97' in green and '3' in gray, and a 'Dispatch All' button. The main area features a table of devices with columns for Device Name, Current Status, and Actions. A search bar is at the top right, and a status bar at the bottom shows 'ALL 100' and 'Error 1'.

Device Name	Current Status	Actions
SUSI2.0_S1	"Advantech-Promote a0123564ddddd4"	Dispatch
SUSI2.0_S267289280	"AJA-MV"	Dispatch
SUN_DVR-3	"AJA-MV"	Dispatching 63%
SUN_DVR-4	Off-Line	Dispatch
SUN_DVR-5	Advantech-Promote	Dispatch
Test_DVR-1	"AJA Tour2012"	Dispatch
Test_DVR-2	Ready to dispatch	Dispatch
Test_DVR-3	"Advantech-Promote"	Dispatching 88%
Test_DVR-4	Off-Line	Dispatch
Test_DVR-5	Playing "AJA Tour2012"	Dispatch

Figure 3.23 Devices List Page

1. Counter Zone
 - Green: Connect and normal
 - Gray: Not connect
 - Red: Dispatch error, will use the same count zone with green
2. All page/ Error page
3. Search
4. Single devices info.
 - Devices name
 - Playing content
 - i. Playing content
 - ii. Off-line
 - Action
 - i. Dispatch
 - Click will popup content selecting window

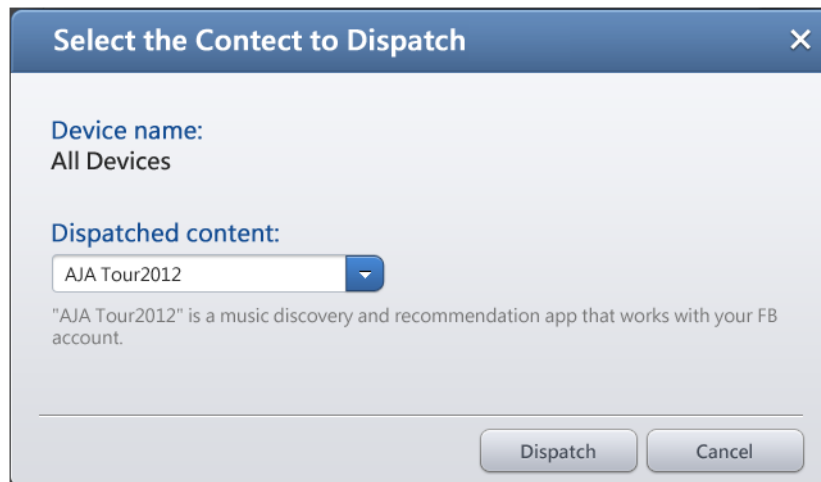

Figure 3.24 Dispatch window

Users can select content to dispatch

ii. Dispatch process bar

– Clicking this row will enter “Detailed info of device” window



Figure 3.25 Derailed Info device window

i. Device Information

1. Device name

2. Device IP

ii. Dispatch Status

1. Dispatch Content

2. Dispatch Status
 - a. Ready to dispatch
 - b. Dispatching
 - c. Error
- iii. Storage Status
 1. Total Size
 2. Available Size
- iv. System Status
 1. Firmware Version
 2. Firmware Date
 3. Upgrade

Click will enter “Firmware Upgrade” window

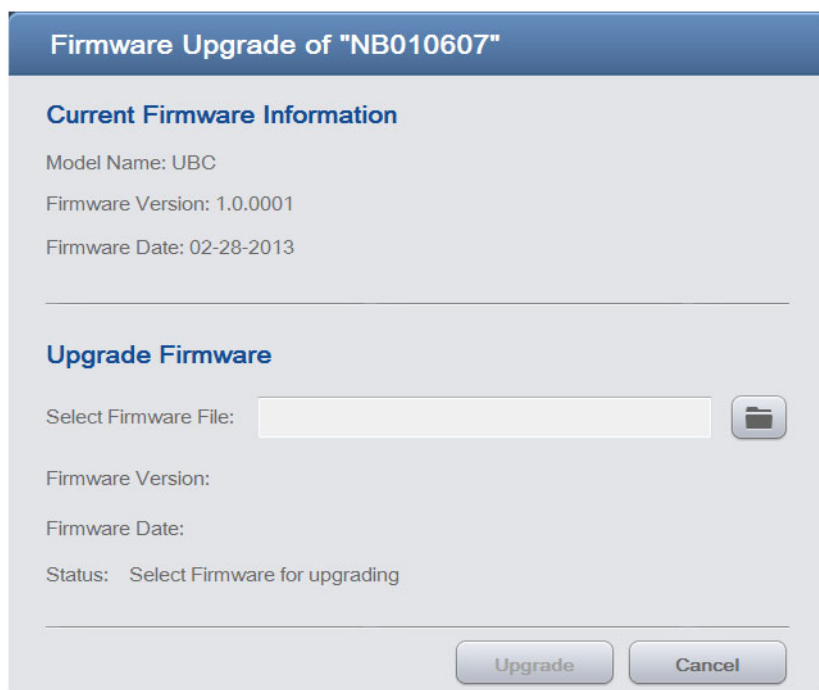

Figure 3.26 Firmware update window

- Current Firmware Information
 - Model Name
 - Firmware Version
 - Firmware Date
- Upgrade Firmware
 - Select Firmware File
 - Firmware Version
 - Firmware Date
 - users can click “Upgrade” to upgrade firmware version after selecting new firmware file, or click “Cancel” to exit this page.

- v. System Configurations

1. Brightness
2. Volume
3. Configurations
Click will enter "Device Configuration" window

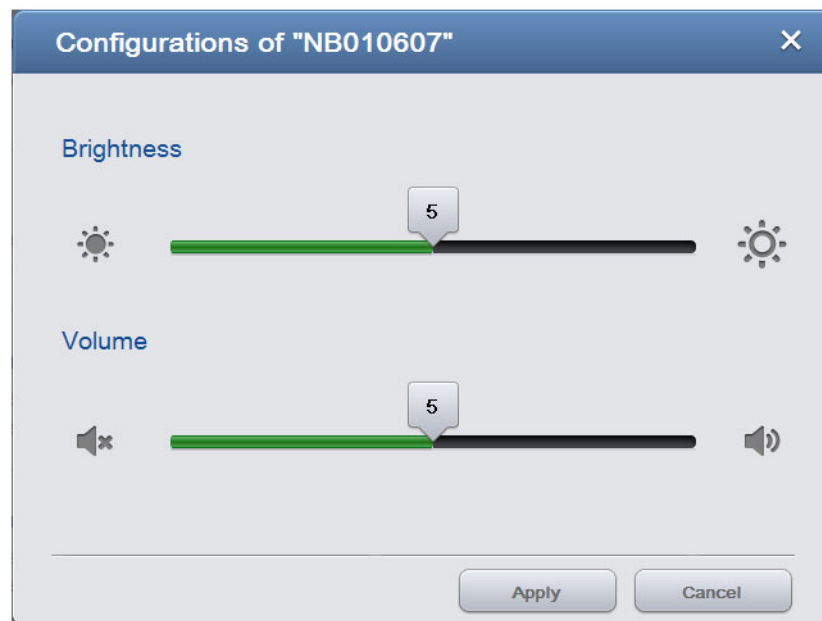

Figure 3.27 Device Configuration Window

- Brightness control
 - Volume control
 - Apply/ Cancel
Apply/ Cancel this time setting
- vi. Cancel
Back to Devices list page
5. Remote Device
Clicking will pop up the "Remote Device" window



Figure 3.28 Remote device window

Users can select devices to remote from SUSIAccess for signage

3.3.2 SUSIAccess for Signage Player

Users can use “Alt+o” to open the config menu, “Alt +p” to save current page and exit the menu, and “Alt +x” to not save any config and exit the menu. Users can use the “Tab” button to switch focus.

A. Network

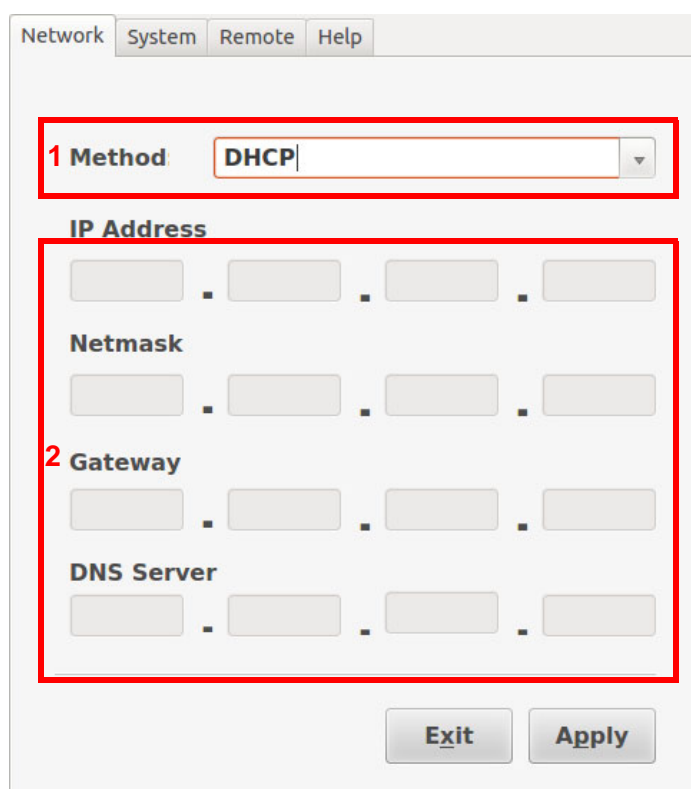

Figure 3.29 Network page

1. Users can set network IP getting type
 - DHCP
 - Manual
 Users can switch the network IP getting type by “Up” and “Down”.
2. Users can set IP Address, Netmask, Gateway and DNS Server on manual type. In DHCP type, system will show IP Address, Netmask, Gateway and DNS Server information if system can get it from DHCP Server.

B. System

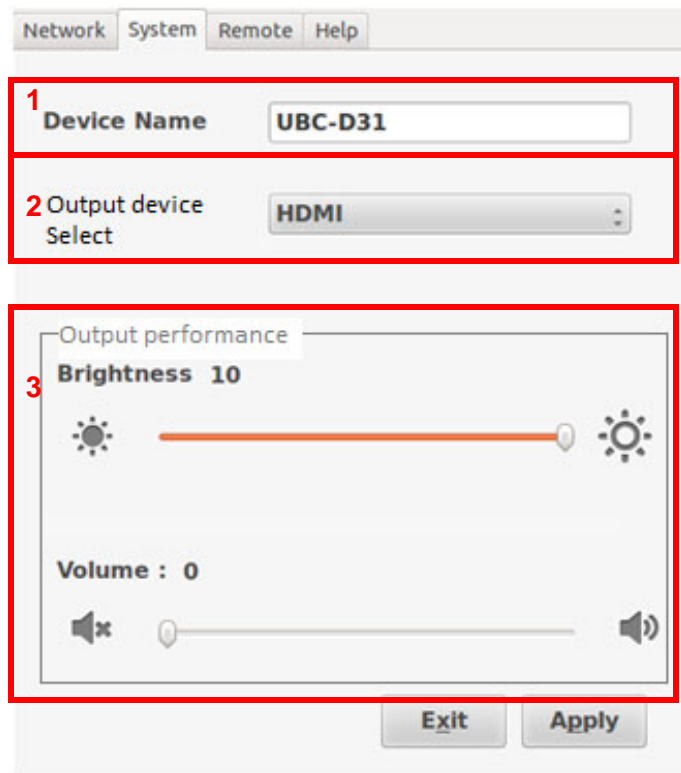

Figure 3.30 System Page

1. Users can set the name of this UBS-DS31 box.
2. Users can select the setting output type, output setting need to restart the UBC-DS31.
 HDMI: HDMI image and voice output.
 VGA/Line out: VGA image output and line out voice output
 P.S:HDMI and VGA image will always output,voice will output in the setting channel.
3. Users can set output performance of brightness and volume. Users can use “Right” and “Left” buttons to control the cursor for changing the value of the setting and it will show corresponding save value after selecting the output type.

C. Remote

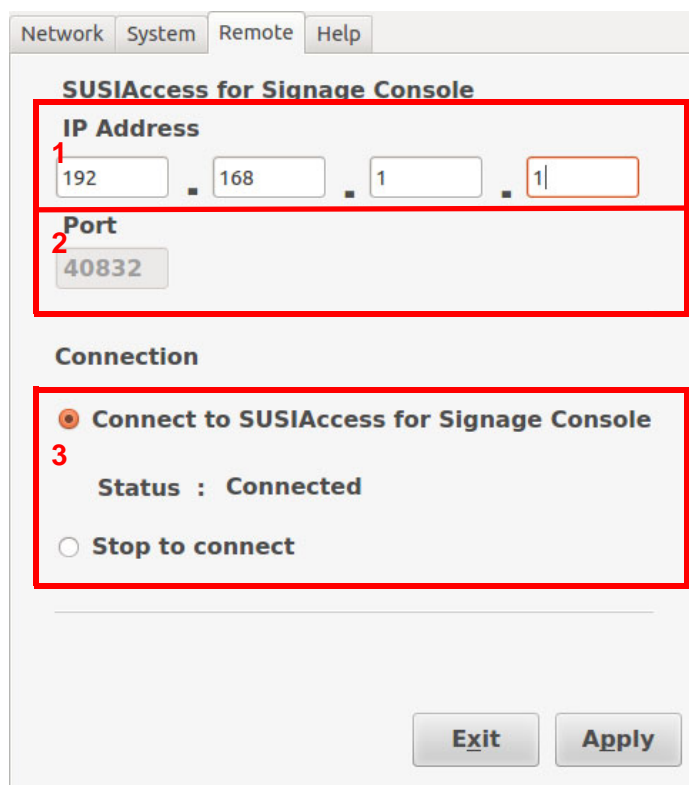

Figure 3.31 Remote Page

1. Users should enter the IP address of SUSIAccess for signage console.
2. 40832 is the connection port of SUSIAccess for signage, users should make sure that this port not blocks by router setting.
3. Connection
 - Connect to SUSIAccess for Signage Console:
Connect to console when UBC-DS31 starts.
Here will show connection states
 - Stop to connect:
Stop to connect to console

D. Help

Show help information

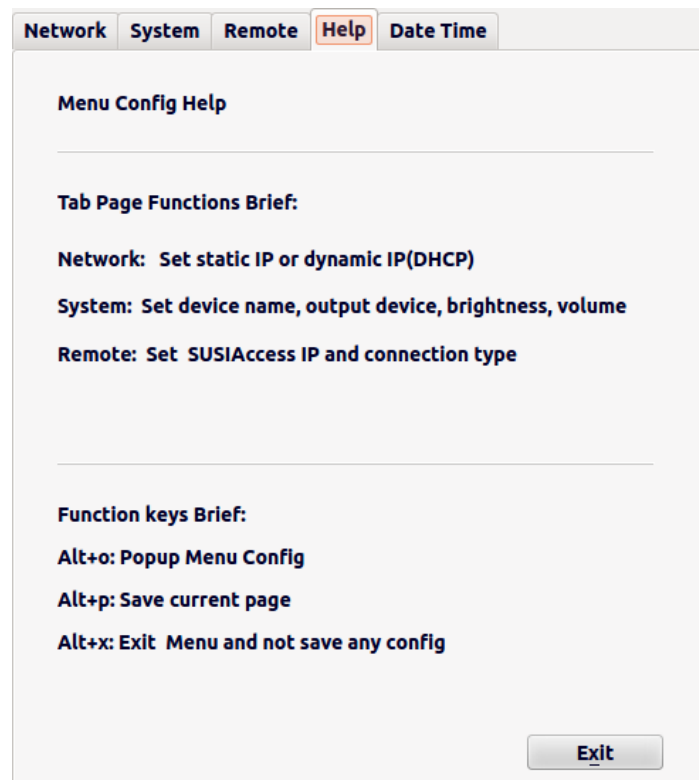

Figure 3.32 Help Page

1. Audio/ Video/ Picture formats support list
 - Audio decoder: MP3, AAC, WAV
Audio type: .MP3, .AAC, .WAV
 - Video decoder: MPEG-4 ASP, H.264 HP, MPEG-2 MP
Video type: .MP4, .AVI, .MPG, .MPEG
 - Image codec: JPEG, JPG, BMP, GIF, PNG
Image type: .JPG, .JPEG, .BMP, .GIF, .PNG

ADVANTECH

Enabling an Intelligent Planet

www.advantech.com

Please verify specifications before quoting. This guide is intended for reference purposes only.

All product specifications are subject to change without notice.

No part of this publication may be reproduced in any form or by any means, electronic, photocopying, recording or otherwise, without prior written permission of the publisher.

All brand and product names are trademarks or registered trademarks of their respective companies.

© Advantech Co., Ltd. 2014