



AXIOMTEK

CAPA310/313

**Intel® Atom® x5-E3940 and Pentium®
Processor N4200 and Celeron®
Processor N3350
3.5" Board**

User's Manual



Disclaimers

This manual has been carefully checked and believed to contain accurate information. Axiomtek Co., Ltd. assumes no responsibility for any infringements of patents or any third party's rights, and any liability arising from such use.

Axiomtek does not warrant or assume any legal liability or responsibility for the accuracy, completeness or usefulness of any information in this document. Axiomtek does not make any commitment to update the information in this manual.

Axiomtek reserves the right to change or revise this document and/or product at any time without notice.

No part of this document may be reproduced, stored in a retrieval system, or transmitted, in any form or by any means, electronic, mechanical, photocopying, recording, or otherwise, without the prior written permission of Axiomtek Co., Ltd.

CAUTION

If you replace wrong batteries, it causes the danger of explosion. It is recommended by the manufacturer that you follow the manufacturer's instructions to only replace the same or equivalent type of battery, and dispose of used ones.

©Copyright 2019 Axiomtek Co., Ltd.

All Rights Reserved

June 2019, Version A2

Printed in Taiwan

ESD Precautions

Computer boards have integrated circuits sensitive to static electricity. To prevent chipsets from electrostatic discharge damage, please take care of the following jobs with precautions:

- Do not remove boards or integrated circuits from their anti-static packaging until you are ready to install them.
- Before holding the board or integrated circuit, touch an unpainted portion of the system unit chassis for a few seconds. It discharges static electricity from your body.
- Wear a wrist-grounding strap, available from most electronic component stores, when handling boards and components.

Trademarks Acknowledgments

Axiomtek is a trademark of Axiomtek Co., Ltd.

Intel[®] and Celeron[®] are trademarks of Intel Corporation.

Windows[®] is a trademark of Microsoft Corporation.

AMI is a trademark of American Megatrend Inc.

IBM, PC/AT, PS/2, VGA are trademarks of International Business Machines Corporation.

Other brand names and trademarks are the properties and registered brands of their respective owners.

Table of Contents

Disclaimers.....	ii
ESD Precautions.....	iii
Chapter 1 Introduction.....	1
1.1 Features.....	2
1.2 Specifications.....	2
1.3 Utilities Supported.....	3
Chapter 2 Board and Pin Assignments.....	5
2.1 Board Dimensions and Fixing Holes.....	5
2.2 Board Layout.....	7
2.3 Jumper and Switch Settings.....	9
2.3.1 LVDS +3.3V/+5V/+12V Voltage Selection (JP1).....	10
2.3.2 Restore BIOS Optimal Defaults (JP1).....	10
2.3.3 Auto Power On (SSW1).....	10
2.4 Connectors.....	11
2.4.1 SMBus Connector (CN1).....	12
2.4.2 Audio Connector (CN2).....	12
2.4.3 Digital I/O Connector (CN4).....	12
2.4.4 I ² C Connector (CN5).....	12
2.4.5 COM Wafer Connectors (CN6 and CN7).....	13
2.4.6 Fan Connector (CN8).....	13
2.4.7 SATA Power Connector (CN9).....	14
2.4.8 USB 2.0 Wafer Connector (CN10).....	14
2.4.9 SATA Connector (CN11).....	14
2.4.10 Front Panel Connector (CN12).....	15
2.4.11 LVDS Connector (CN13).....	16
2.4.12 Inverter Connector (CN14).....	18
2.4.13 Ethernet Port (CN16).....	18
2.4.14 USB 3.0 Ports (CN17 and CN18).....	19
2.4.15 COM1 D-Sub Connector (CN20).....	19
2.4.16 HDMI Connector (CN21).....	20
2.4.17 VGA Connector (CN22) (Optional).....	20
2.4.18 ATX Power Connector (ATX1).....	20
2.4.19 Full-size PCI-Express Mini Card Connector (SCN1 and SCN3).....	21
2.4.20 ZIO Expansion Connector (SCN2).....	23
Chapter 3 Hardware Description.....	25

3.1	Microprocessors	25
3.2	BIOS	25
3.3	System Memory.....	25
3.4	I/O Port Address Map.....	26
3.5	Interrupt Controller (IRQ) Map	28
3.6	Memory Map	34
Chapter 4 AMI BIOS Setup Utility		37
4.1	Starting.....	37
4.2	Navigation Keys	37
4.3	Main Menu.....	39
4.4	Advanced Menu.....	40
4.5	Chipset Menu.....	52
4.6	Security Menu.....	56
4.7	Boot Menu.....	57
4.8	Save & Exit Menu	60
Appendix A Watchdog Timer.....		63
A.1	About Watchdog Timer	63
A.2	How to Use Watchdog Timer.....	63
Appendix B Digital I/O		65
B.1	About Digital I/O	65
B.2	Digital I/O Programming	65
Appendix C BIOS Flash Utility		67

This page is intentionally left blank.

Chapter 1

Introduction

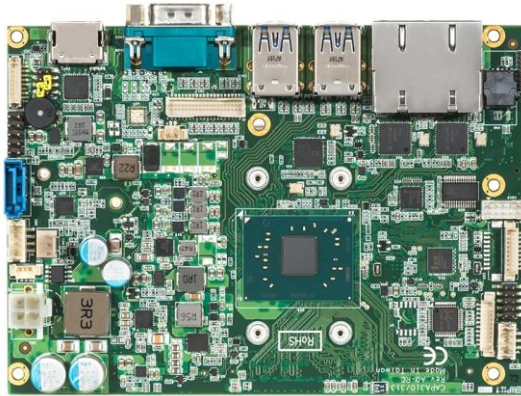

CAPA313

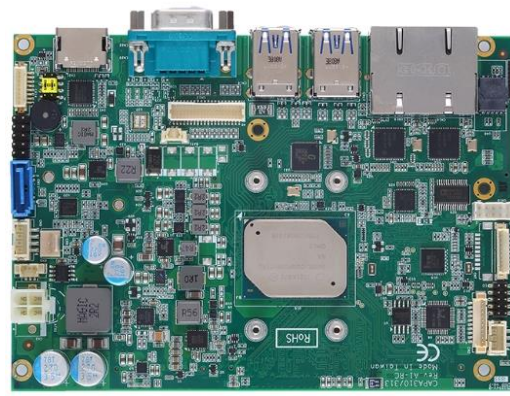

CAPA310

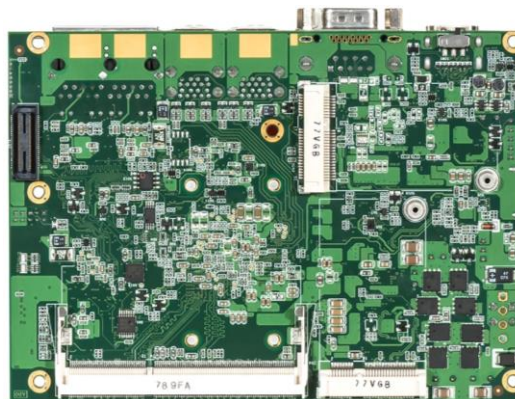

the CAPA310 is a 3.5" embedded board with Intel® Atom® x5-E3940 and the CAPA313 is with Intel® Pentium® N4200/ Celeron® N3350 processor that deliver outstanding system performance through high-bandwidth interfaces, multiple I/O functions for interactive applications and various embedded computing solutions.

Both of them have one 204-pin unbuffered SO-DIMM socket for single channel DDR3L 1867MHz memory with maximum memory capacity up to 8GB. There are two Gigabit/Fast Ethernet ports, one SATA port with transfer rate up to 6Gb/s, four USB 3.0 ports, two USB 2.0 ports and built-in HD audio codec that can achieve the best stability and reliability for industrial applications. Additionally, it provides you with unique embedded features, such as two serial ports (one RS-232/422/485 and one RS-232) and 3.5" form factor that applies an extensive array of PC peripherals.

1.1 Features

- CAPA310 - Intel® Atom® quad core x5-E3940 processor (1.6GHz)
- CAPA313 - Intel® Pentium® quad core N4200 processor (1.1GHz) and Celeron® dual core N3350 processor (1.1GHz)
- 1 DDR3L SO-DIMM supports up to 8GB memory capacity
- 4 USB 3.0 ports and 2 USB 2.0 ports
- PCI-Express Mini Cards
- +12V~+24V DC-in supported

1.2 Specifications

- **CPU**
 - CAPA310
 - Intel® ATOM® quad core x5-E3940 1.6GHz.
 - CAPA313
 - Intel® Pentium® quad core N4200 1.1GHz.
 - Intel® Celeron® dual core N3350 1.1GHz.
- **Thermal Solution**
 - Passive.
- **Operating Temperature**
 - CAPA310: -40°C~+80°C
 - CAPA313: -20°C~+70°C.
- **BIOS**
 - American Megatrends Inc. UEFI (Unified Extensible Firmware Interface) BIOS.
 - 64Mbit SPI Flash, DMI, Plug and Play.
 - PXE Ethernet Boot ROM.
- **System Memory**
 - One 204-pin unbuffered DDR3L SO-DIMM socket.
 - Maximum up to 8GB DDR3L 1867MHz memory capacity.

Note: When the ambient temperature is around 80°C, it is suggested to add proper thermal solution on DDR3L-1867 module.

- **Onboard Multi I/O**
 - Serial Ports: One RS-232/422/485 and one RS-232.
- **Serial ATA**
 - One SATA-600 connector.
 - mSATA supported.
- **USB Interface**
 - Four USB 3.0 ports on the rear I/O.
 - Two USB 2.0 ports in 2x5-pin internal wafer connector.
- **Display**
 - One 2x20-pin connector for 18/24-bit single/dual channel LVDS and one 8-pin inverter connector. LVDS resolution is up to 1920x1200 in 24-bit dual channels.
 - One HDMI supports HDMI1.4b. The resolution is up to 3840x2160.
 - One 15-pin D-Sub as VGA connector. The resolution is up to 1920x1200 (Optional).

- **Trusted Platform Module (TPM)**
 - Controller: ST ST33HTPH2E32AHA6 via SPI bus interface.
 - Complies with TPM2.0 main and PC client specification.
- **Watchdog Timer**
 - Timeout value range is 1~65535 seconds.
- **Ethernet**
 - Two RJ-45 LAN ports: Intel® i211AT supports 1000/100/10Mbps Gigabit/Fast Ethernet with Wake-on-LAN and PXE Boot ROM.
- **Audio**
 - HD audio compliant with Realtek ALC662.
 - Line-out and line-in/MIC-in via internal box header.
- **Expansion Interface**
 - One full-size PCI-Express Mini Card socket complies with PCI-Express Mini Card Spec. V1.2.
 - One full-size PCI-Express Mini Card socket with only support USB 2.0.
- **ZIO Connector**
 - 60-pin high speed connector; containing one PCI Express x1, one USB2.0, one LPC and one SMBus.
- **Power Input**
 - One 2x2-pin connector.
 - +12V~+24V DC-in.
 - Auto power on function supported.
- **Power Management**
 - ACPI (Advanced Configuration and Power Interface).
- **Form Factor**
 - 3.5" form factor.



All specifications and images are subject to change without notice.

Note

1.3 Utilities Supported

- Chipset and graphics driver
- Ethernet driver
- Audio driver
- Trusted Execution Engine

This page is intentionally left blank.

Chapter 2

Board and Pin Assignments

2.1 Board Dimensions and Fixing Holes

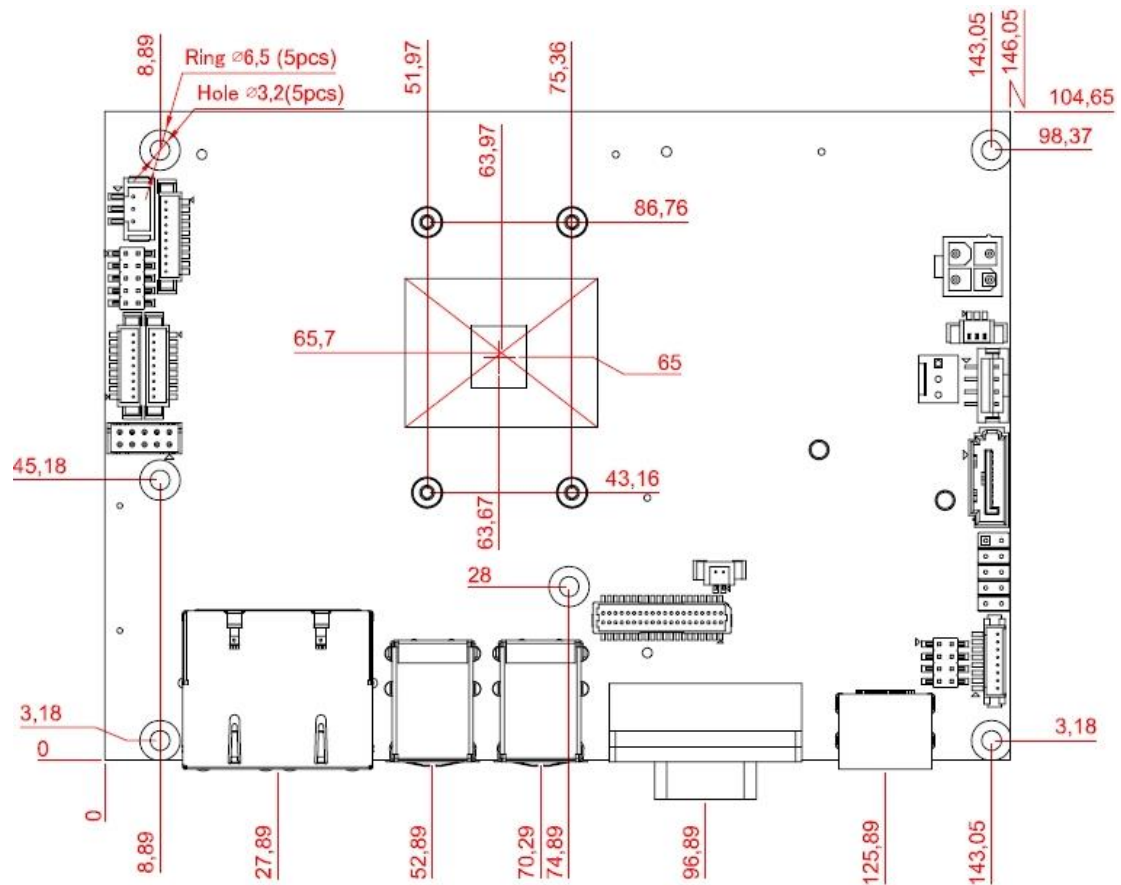

Top View

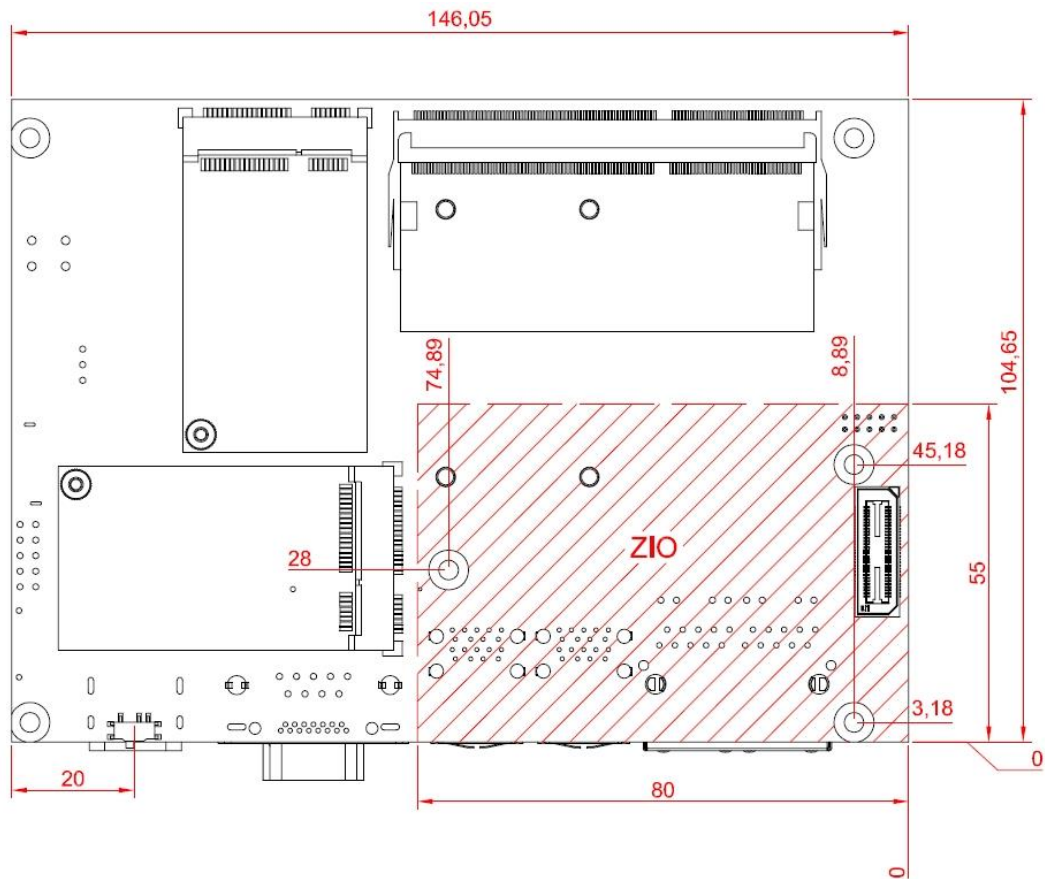

Bottom View

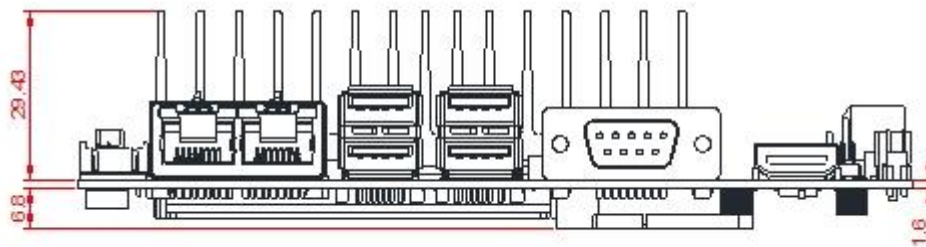

CAPA310

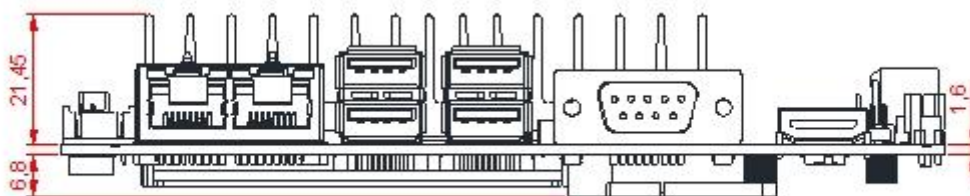

CAPA313

Side View

2.2 Board Layout

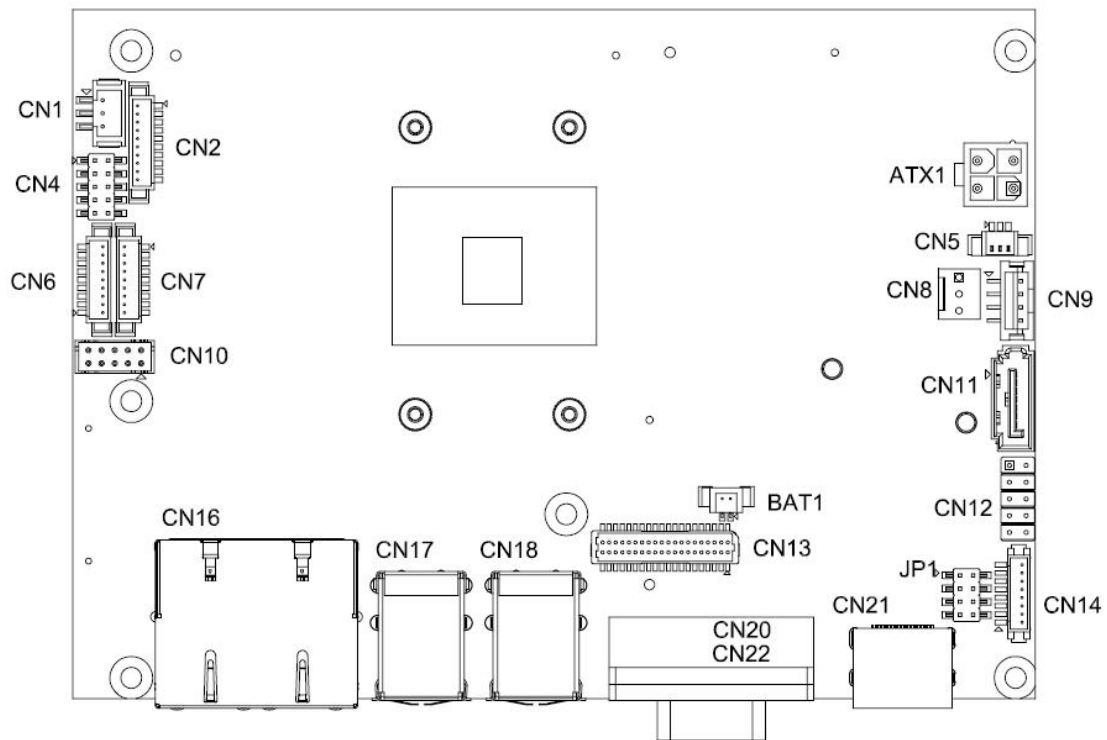

Top View

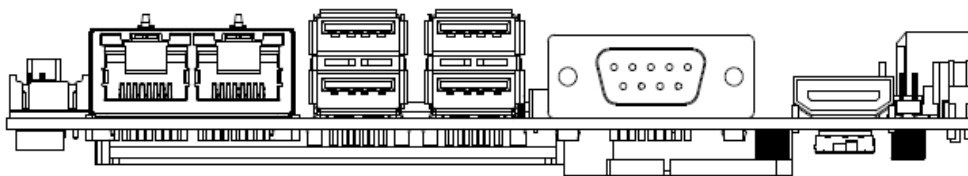

Side View

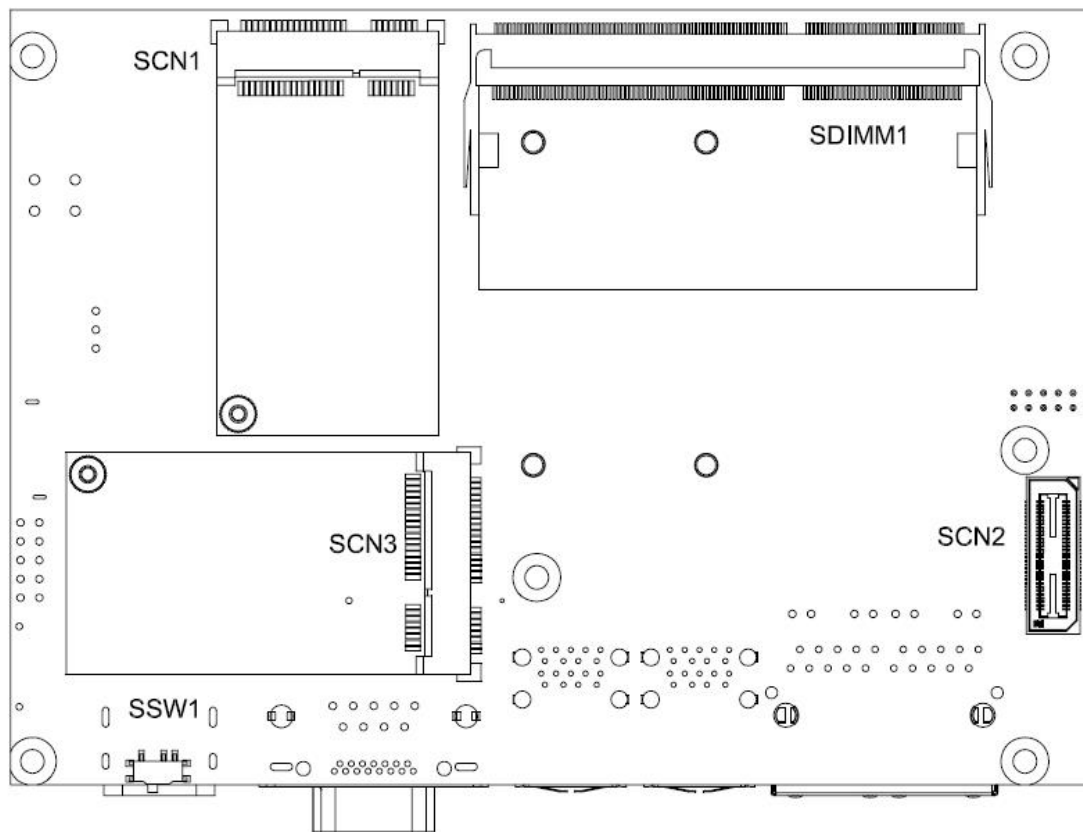

Bottom View

2.3 Jumper and Switch Settings

Jumper is a small component consisting of jumper clip and jumper pins. Install jumper clip on 2 jumper pins to close. And remove jumper clip from 2 jumper pins to open. Below illustration shows how to set up jumper.

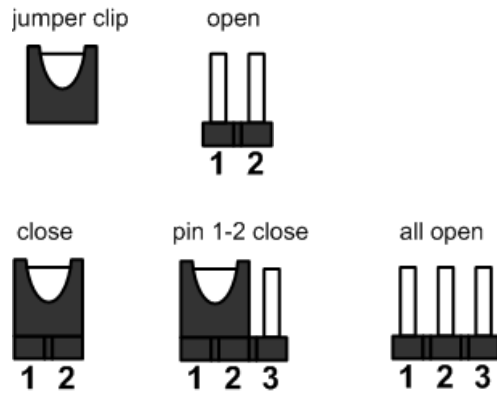

Properly configure jumper and switch settings on the CAPA310/313 to meet your application purpose. Below you can find a summary table of jumpers, switch and onboard default settings.



Note

Once the default jumper or switch setting needs to be changed, please do it under power-off condition.

Jumper and Switch	Description	Setting
JP1	LVDS +3.3V/+5V/+12V Voltage Selection Default: +3.3V Level	2-4 Close
	Restore BIOS Optimal Defaults Default: Normal Operation	3-5 Close
SSW1	Auto Power On Default: Disable	1-2 Close

2.3.1 LVDS +3.3V/+5V/+12V Voltage Selection (JP1)

This is a 2x4-pin (pitch=2.0mm) jumper. The board supports voltage selection for flat panel displays. Use JP1 to set CN13 pin 1~6 to +3.3V, +5V or +12V. To prevent hardware damage, before connecting please make sure that the input voltage of flat panel is correct.

Function	Setting
+3.3V level (Default)	2-4 close
+5V level	4-6 close
+12V level	7-8 close

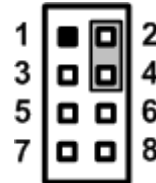

2.3.2 Restore BIOS Optimal Defaults (JP1)

Put jumper clip to pin 1-3 for a few seconds then move it back to pin 3-5. Doing this procedure can restore BIOS optimal defaults.

Function	Setting
Normal (Default)	3-5 close
Restore BIOS optimal defaults	1-3 close



2.3.3 Auto Power On (SSW1)

If SSW1 is enabled for power input, the system will be automatically power on without pressing soft power button. If SSW1 is disabled for power input, it is necessary to manually press soft power button to power on the system.

Function	Setting
Disable auto power on (Default)	1-2 close
Enable auto power on	2-3 close

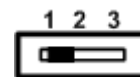

2.4 Connectors

Signals go to other parts of the system through connectors. Loose or improper connection might cause problems, please make sure all connectors are properly and firmly connected. Here is a summary table of connectors on the hardware.

Connector	Description
CN1	SMBus Connector
CN2	Audio Connector
CN4	Digital I/O Connector
CN5	I ² C Connector
CN6	COM2 Wafer Connector
CN7 (Optional)	COM1 Wafer Connector
CN8	Fan Connector
CN9	SATA Power Connector
CN10	USB 2.0 Wafer Port 5 and 6
CN11	SATA Connector
CN12	Front Panel Connector
CN13	LVDS Connector
CN14	Inverter Connector
CN16	Ethernet Port 1 and 2
CN17~CN18	USB 3.0 Port 0~3
CN20	COM1 D-Sub Connector
CN21	HDMI Connector
CN22 (Optional)	VGA Connector
ATX1	ATX Power Connector
SCN1, SCN3	Full-size PCI-Express Mini Card Connectors
SCN2	ZIO Expansion Connector
SDIMM1	DDR3L SO-DIMM Connector

2.4.1 SMBus Connector (CN1)

This is a 3-pin (pitch=2.0mm) wafer connector which is compliant with JST B4B-PH-SM3-TB. The SMBus (System Management Bus) is a simple bus for the purpose of lightweight communication.

Pin	Signal
1	SMBus clock
2	SMBus data
3	GND

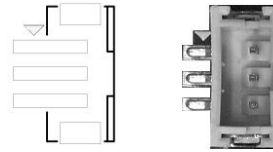

2.4.2 Audio Connector (CN2)

This is a 10-pin (pitch=1.25mm) wafer connector, which is compliant with Molex 53047-1010, for audio interface.

Pin	Signal	Pin	Signal
1	MIC_IN	2	GND
3	LINE_IN_L	4	GND
5	LINE_IN_R	6	GND
7	AUDIO_OUT_L	8	GND
9	AUDIO_OUT_R	10	GND

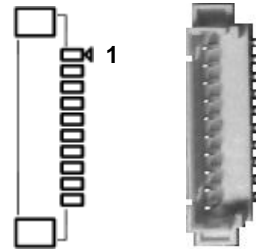

2.4.3 Digital I/O Connector (CN4)

This is a 2x5-pin (pitch=2.0mm) connector. The board is equipped with an 8-bit (4 inputs and 4 outputs) digital I/O that meets requirements for a system customary automation control. The digital I/O can be configured to control cash drawers and sense warning signals from an Uninterrupted Power System (UPS), or perform store security control. You may use software programming to control these digital signals, please refer to Appendix B.

Pin	Signal	Pin	Signal
1	Digital Input 1	2	Digital Output 8
3	Digital Input 2	4	Digital Output 7
5	Digital Input 3	6	Digital Output 6
7	Digital Input 4	8	Digital Output 5
9	+5V	10	GND

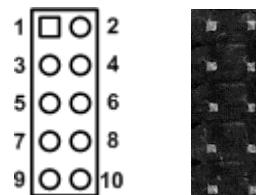

2.4.4 I²C Connector (CN5)

This is a 3-pin (pitch=1.25mm) connector, which is compliant with Molex 530470310, for I²C interface.

Pin	Signal
1	I ² C_CLK_SBY
2	I ² C_DAT_SBY
3	GND



2.4.5 COM Wafer Connectors (CN6 and CN7)

The CN6 and CN7 (optional) are 9-pin (pitch=1.25mm) connectors for COM2 and COM1 interface, respectively. Both connectors are compliant with Molex 53047-0910. If you need COM1 to support RS-422 or RS-485 communication mode, please refer to BIOS setting in section 4.4.

COM1 (optional):

Pin	RS-232	RS-422	RS-485
1	DCD	TX-	Data-
2	DSR	No use	No use
3	RXD	TX+	Data+
4	RTS	No use	No use
5	TXD	RX+	No use
6	CTS	No use	No use
7	DTR	RX-	No use
8	RI	No use	No use
9	GND	No use	No use

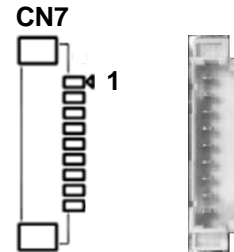

COM2:

Pin	RS-232
1	DCD
2	DSR
3	RXD
4	RTS
5	TXD
6	CTS
7	DTR
8	RI
9	GND

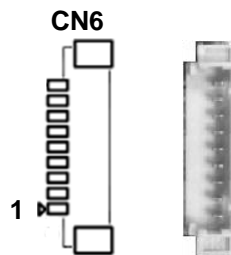

2.4.6 Fan Connector (CN8)

A fan interface is available through this connector. You can find fan speed within BIOS Setup Utility if fan is installed. For further information, see BIOS Setup Utility: Advanced\Hardware Monitor\PC Health Status (see section 4.4).

Pin	Signal
1	GND
2	+12V level
3	Fan speed feedback



2.4.7 SATA Power Connector (CN9)

This is a 4-pin (pitch=2mm) wafer connector, which is compliant with JST B4B-PH-K-S, for SATA power interface.

Pin	Signal
1	+12V
2	GND
3	GND
4	+5V

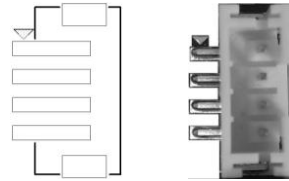

2.4.8 USB 2.0 Wafer Connector (CN10)

This is a 2x5-pin (pitch=2mm) wafer connector, which is compliant with Hirose DF11-xdp-2dsa, for installing versatile USB 2.0 compliant interface peripherals.

Pin	Signal	Pin	Signal
1	USB VCC (+5V_SBY)	2	USB VCC (+5V_SBY)
3	USB #5_D-	4	USB #6_D-
5	USB #5_D+	6	USB #6_D+
7	GND	8	GND
9	GND	10	GND

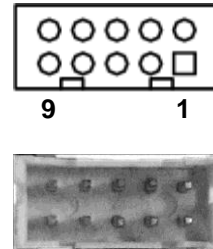

2.4.9 SATA Connector (CN11)

The CN11 is a high-speed Serial Advanced Technology Attachment (Serial ATA or SATA) interface for connecting to devices such as hard disk drive.

Pin	Signal
1	GND
2	SATA_TXP0
3	SATA_TXN0
4	GND
5	SATA_RXN0
6	SATA_RXP0
7	GND

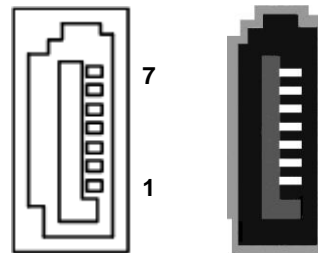

2.4.10 Front Panel Connector (CN12)

This is a 2x5-pin header (pitch=2.54mm) for front panel interface.

Pin	Signal	Pin	Signal
1	PWR-	2	PWR+
3	PWRLED-	4	PWRLED+
5	PWRSW-	6	PWRSW+
7	HW RST-	8	HW RST+
9	HDDLED-	10	HDDLED+

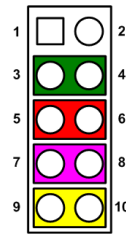

Power Status

Pin 1 and pin 2 are for power status button; letting user know the power status of this board.

Power LED

Pin 4 connects anode (+) of LED and pin 3 connects cathode(-) of LED. The power LED lights up when the system is powered on.

Power On/Off Button

Pin 5 and 6 connect the power button on front panel to CPU board, which allows users to turn on or off power supply.

System Reset Switch

Pin 7 and 8 connect the case-mounted reset switch that reboots your computer without turning off the power switch. It is a better way to reboot your system for a longer life of system power supply.

HDD Activity LED

This connection is linked to hard drive activity LED on the control panel. LED flashes when HDD is being accessed. Pin 9 and 10 connect the hard disk drive to the front panel HDD LED, pin 9 is assigned as cathode(-) and pin 10 is assigned as anode(+).

2.4.11 LVDS Connector (CN13)

This board has one 2x20-pin (pitch=1mm) connector for LVDS LCD interface. It is strongly recommended to use the matching JST SHDR-40VS-B connector for LVDS interface. Pin 1~6 VCCM can be set to +3.3V, +5V or +12V by setting JP1 (see section 2.3.1).

18-bit single channel

Pin	Signal	Pin	Signal
1	VCCM	2	VCCM
3	VCCM	4	VCCM
5	VCCM	6	VCCM
7	N.C	8	N.C
9	GND	10	GND
11	N.C	12	N.C
13	N.C	14	N.C
15	GND	16	GND
17	N.C	18	N.C
19	N.C	20	N.C
21	GND	22	GND
23	Channel A D0-	24	N.C
25	Channel A D0+	26	N.C
27	GND	28	GND
29	Channel A D1-	30	N.C
31	Channel A D1+	32	N.C
33	GND	34	GND
35	Channel A D2-	36	Channel A CLK-
37	Channel A D2+	38	Channel A CLK+
39	GND	40	GND

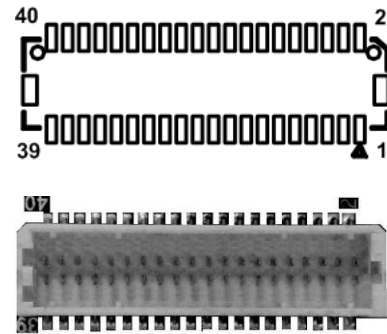

24-bit single channel

Pin	Signal	Pin	Signal
1	VCCM	2	VCCM
3	VCCM	4	VCCM
5	VCCM	6	VCCM
7	N.C	8	N.C
9	GND	10	GND
11	N.C	12	N.C
13	N.C	14	N.C
15	GND	16	GND
17	N.C	18	N.C
19	N.C	20	N.C
21	GND	22	GND
23	Channel A D0-	24	N.C
25	Channel A D0+	26	N.C
27	GND	28	GND
29	Channel A D1-	30	Channel A D3-
31	Channel A D1+	32	Channel A D3+
33	GND	34	GND
35	Channel A D2-	36	Channel A CLK-
37	Channel A D2+	38	Channel A CLK+
39	GND	40	GND

18-bit dual channel

Pin	Signal	Pin	Signal
1	VCCM	2	VCCM
3	VCCM	4	VCCM
5	VCCM	6	VCCM
7	N.C	8	N.C
9	GND	10	GND
11	N.C	12	Channel B D0-
13	N.C	14	Channel B D0+
15	GND	16	GND
17	Channel B CLK-	18	Channel B D1-
19	Channel B CLK+	20	Channel B D1+
21	GND	22	GND
23	Channel A D0-	24	Channel B D2-
25	Channel A D0+	26	Channel B D2+
27	GND	28	GND
29	Channel A D1-	30	N.C
31	Channel A D1+	32	N.C
33	GND	34	GND
35	Channel A D2-	36	Channel A CLK-
37	Channel A D2+	38	Channel A CLK+
39	GND	40	GND

24-bit dual channel

Pin	Signal	Pin	Signal
1	VCCM	2	VCCM
3	VCCM	4	VCCM
5	VCCM	6	VCCM
7	N.C	8	N.C
9	GND	10	GND
11	Channel B D3-	12	Channel B D0-
13	Channel B D3+	14	Channel B D0+
15	GND	16	GND
17	Channel B CLK-	18	Channel B D1-
19	Channel B CLK+	20	Channel B D1+
21	GND	22	GND
23	Channel A D0-	24	Channel B D2-
25	Channel A D0+	26	Channel B D2+
27	GND	28	GND
29	Channel A D1-	30	Channel A D3-
31	Channel A D1+	32	Channel A D3+
33	GND	34	GND
35	Channel A D2-	36	Channel A CLK-
37	Channel A D2+	38	Channel A CLK+
39	GND	40	GND

2.4.12 Inverter Connector (CN14)

This is an 8-pin (pitch=1.25mm) connector which is compliant with Hirose DF13-8P-1.25V for inverter. We strongly recommend you to use the matching connector, DF13-8S-1.25C, to avoid malfunction.

Pin	Signal
1	VBL1 (+12V level)
2	VBL1 (+12V level)
3	VBL2 (+5V level)
4	VBL_ENABLE
5	GND
6	GND
7	GND
8	VBL Brightness Control

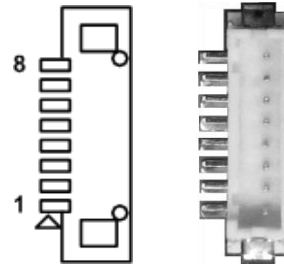

2.4.13 Ethernet Port (CN16)

The board has dual RJ-45 Ethernet connector. Connection can be established by plugging one end of the Ethernet cable into this RJ-45 connector and the other end (phone jack) to a 1000/100/10-Base-T hub.

Pin	1000 Base-T	100/10 Base-T	Description
L1	BI_DA+	TX+	Bidirectional or Transmit Data+
L2	BI_DA-	TX-	Bidirectional or Transmit Data-
L3	BI_DB+	RX+	Bidirectional or Receive Data+
L4	BI_DC+	N.C.	Bidirectional or Not Connected
L5	BI_DC-	N.C.	Bidirectional or Not Connected
L6	BI_DB-	RX-	Bidirectional or Receive Data-
L7	BI_DD+	N.C.	Bidirectional or Not Connected
L8	BI_DD-	N.C.	Bidirectional or Not Connected
A	Speed LED 1000: Orange 100/10: Green/OFF		
B	Active Link LED (Yellow) Off: No link Blinking: Data activity detected		

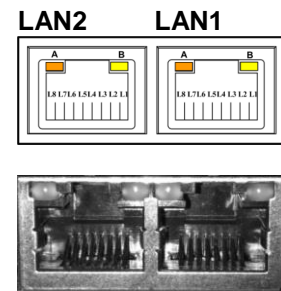

2.4.14 USB 3.0 Ports (CN17 and CN18)

The Universal Serial Bus (compliant with USB 3.0 (5Gb/s)) connector on the rear I/O is for installing USB peripherals such as keyboard, mouse, scanner, etc.

Pin	Signal	Pin	Signal
1	USB_VCC (+5V)	10	USB_VCC (+5V)
2	USB #0_D-	11	USB #1_D-
3	USB #0_D+	12	USB #1_D+
4	GND	13	GND
5	SSRX0-	14	SSRX1-
6	SSRX0+	15	SSRX1+
7	GND	16	GND
8	SSTX0-	17	SSTX1-
9	SSTX0+	18	SSTX1+

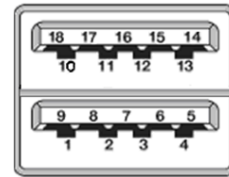

2.4.15 COM1 D-Sub Connector (CN20)

This is a standard 9-pin D-Sub connector for COM1 interface. The pin assignments of RS-232/422/485 are listed in table below. If you need COM1 to support RS-422 or RS-485 communication mode, please refer to BIOS setting in section 4.4.

Pin	RS-232	RS-422	RS-485
1	DCD	TX-	Data-
2	RXD	TX+	Data+
3	TXD	RX+	No use
4	DTR	RX-	No use
5	GND	No use	No use
6	DSR	No use	No use
7	RTS	No use	No use
8	CTS	No use	No use
9	RI	No use	No use

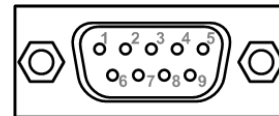

2.4.16 HDMI Connector (CN21)

The HDMI (High-Definition Multimedia Interface) is a compact digital interface which is capable of transmitting high-definition video and high-resolution audio over a single cable. Its interface is available through connector CN21.

Pin	Signal	Pin	Signal
1	HDMI OUT_DATA2+	2	GND
3	HDMI OUT_DATA2-	4	HDMI OUT_DATA1+
5	GND	6	HDMI OUT_DATA1-
7	HDMI OUT_DATA0+	8	GND
9	HDMI OUT_DATA0-	10	HDMI OUT_Clock+
11	GND	12	HDMI OUT_Clock-
13	N.C.	14	N.C.
15	HDMI OUT_SCL	16	HDMI OUT_SDA
17	GND	18	+5V
19	HDMI_HTPLG		

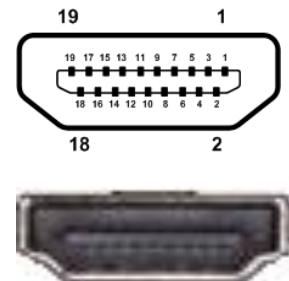

2.4.17 VGA Connector (CN22) (Optional)

This is a standard 15-pin D-Sub connector. It is commonly used for VGA display. This VGA interface configuration can be configured via software utility. It is co-layout with COM1 D-sub Connector (CN20).

Pin	Signal	Pin	Signal
1	RED	2	GREEN
3	BLUE	4	N.C
5	GND	6	GND
7	GND	8	GND
9	CRT_VCC	10	GND
11	N.C	12	DDC_DATA
13	Hsync	14	Vsync
15	DDC_CLK		

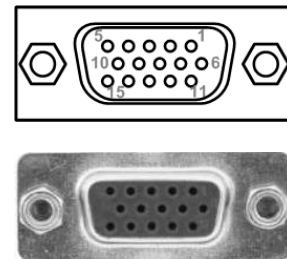

2.4.18 ATX Power Connector (ATX1)

Steady and sufficient power can be supplied to all components on the board by connecting the power connector. Please make sure all components and devices are properly installed before connecting the power connector.

The ATX1 is a 4-pin power supply interface. External power supply plug fits into ATX1 in only one orientation. Properly press down power supply plug until it completely and firmly fits into this connector. Loose connection may cause system instability.

Pin	Signal
1	GND
2	GND
3	+12V~+24V
4	+12V~+24V



2.4.19 Full-size PCI-Express Mini Card Connector (SCN1 and SCN3)

These are two full-size PCI-Express Mini Card connectors on the bottom side.

SCN1 (support mSATA only):

Pin	Signal	Pin	Signal
1	N.C	2	+3.3V_SBY
3	N.C	4	GND
5	N.C	6	+1.5V
7	N.C	8	N.C
9	GND	10	N.C
11	N.C	12	N.C
13	N.C	14	N.C
15	GND	16	N.C
17	N.C	18	GND
19	N.C	20	N.C
21	GND	22	PERST#
23	SATA_RXP1	24	+3.3V_SBY
25	SATA_RXN1	26	GND
27	GND	28	+1.5V
29	GND	30	SMB_PCIE_CLK
31	SATA_TXN1	32	SMB_PCIE_DATA
33	SATA_TXP1	34	GND
35	GND	36	N.C
37	GND	38	N.C
39	+3.3V_SBY	40	GND
41	+3.3V_SBY	42	N.C
43	GND	44	N.C
45	N.C	46	N.C
47	N.C	48	+1.5V
49	N.C	50	GND
51	N.C	52	+3.3V_SBY

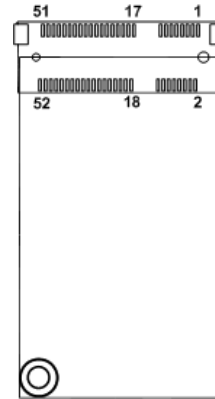

SCN3 (support PCI-Express and USB 2.0):

Pin	Signal	Pin	Signal
1	WAKE#	2	+3.3V_SBY
3	N.C	4	GND
5	N.C	6	+1.5V
7	CLKREQ#	8	N.C
9	GND	10	N.C
11	REFCLK-	12	N.C
13	REFCLK+	14	N.C
15	GND	16	N.C
17	N.C	18	GND
19	N.C	20	W_DISABLE#
21	GND	22	PERST#
23	PE_RXN2	24	+3.3V_SBY
25	PE_RXP2	26	GND
27	GND	28	+1.5V
29	GND	30	SMB_CLK
31	PE_TXN2	32	SMB_DATA
33	PE_TXP2	34	GND
35	GND	36	USB_D0-
37	GND	38	USB_D0+
39	+3.3V_SBY	40	GND
41	+3.3V_SBY	42	N.C
43	GND	44	N.C
45	N.C	46	N.C
47	N.C	48	+1.5V
49	N.C	50	GND
51	N.C	52	+3.3V_SBY

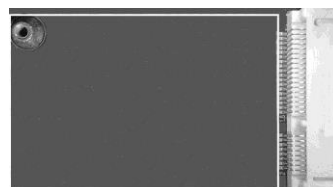
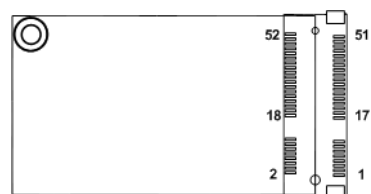

2.4.20 ZIO Expansion Connector (SCN2)

The board is equipped with SCN2 on the bottom side for connecting CPU board to a ZIO module.

Pin	Signal	Pin	Signal
A1	+12V	B1	GND
A2	+5VSB	B2	GND
A3	+5VSB	B3	GND
A4	+3.3VSB	B4	GND
A5	+3.3VSB	B5	RSVD
A6	RSVD	B6	RSVD
A7	PWROK	B7	RSVD
A8	SMB_CLK	B8	RSVD
A9	SMB_DATA	B9	GND
A10	GND	B10	PE_TXP3
A11	PE_RXP3	B11	PE_TXN3
A12	PE_RXN3	B12	WAKE_N
A13	USBOC_N	B13	PCI-E CLKP
A14	USB #7_D+	B14	PCI-E CLKN
A15	USB #7_D-	B15	GND
A16	No Use	B16	CLK_25M
A17	No Use	B17	SERIRQ
A18	GND	B18	LAD0
A19	No Use	B19	LAD1
A20	No Use	B20	LAD2
A21	PLTRST_N	B21	LAD3
A22	No Use	B22	L_FRAME
A23	No Use	B23	GND
A24	GND	B24	No Use
A25	No Use	B25	No Use
A26	No Use	B26	No Use
A27	No Use	B27	No Use
A28	No Use	B28	GND
A29	GND	B29	No Use
A30	No Use	B30	No Use

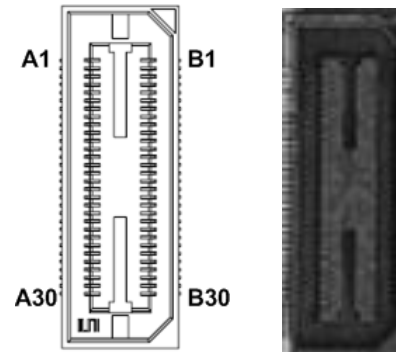

This page is intentionally left blank.

Chapter 3

Hardware Description

3.1 Microprocessors

The CAPA310 supports Intel® Atom® x5-E3940 and CAPA313 supports Intel® Pentium® N4200 and Celeron® N3350 processors which enable your system to operate under Windows® 10 environments. The system performance depends on the microprocessor. Make sure all correct settings are arranged for the installed microprocessor to prevent the CPU from damages.

3.2 BIOS



































The CAPA310 /313 use AMI Plug and Play BIOS with a single 64Mbit SPI Flash.

3.3 System Memory

The CAPA310/313 support one 204-pin DDR3L SO-DIMM socket for maximum memory capacity up to 8GB DDR3L SDRAMs. The memory module comes in sizes of 2GB, 4GB and 8GB.





















































3.4 I/O Port Address Map

















▼	Input/output (IO)
📁	[0000000000000000 - 000000000000006F] PCI Express Root Complex
📁	[0000000000000020 - 0000000000000021] Programmable interrupt controller
📁	[0000000000000020 - 0000000000000021] Programmable interrupt controller
📁	[0000000000000024 - 0000000000000025] Programmable interrupt controller
📁	[0000000000000024 - 0000000000000025] Programmable interrupt controller
📁	[0000000000000028 - 0000000000000029] Programmable interrupt controller
📁	[0000000000000028 - 0000000000000029] Programmable interrupt controller
📁	[000000000000002C - 000000000000002D] Programmable interrupt controller
📁	[000000000000002C - 000000000000002D] Programmable interrupt controller
📁	[000000000000002E - 000000000000002F] Motherboard resources
📁	[0000000000000030 - 0000000000000031] Programmable interrupt controller
📁	[0000000000000030 - 0000000000000031] Programmable interrupt controller
📁	[0000000000000034 - 0000000000000035] Programmable interrupt controller
📁	[0000000000000034 - 0000000000000035] Programmable interrupt controller
📁	[0000000000000038 - 0000000000000039] Programmable interrupt controller
📁	[0000000000000038 - 0000000000000039] Programmable interrupt controller
📁	[000000000000003C - 000000000000003D] Programmable interrupt controller
📁	[000000000000003C - 000000000000003D] Programmable interrupt controller
📁	[0000000000000040 - 0000000000000043] System timer
📁	[0000000000000040 - 0000000000000043] System timer
📁	[000000000000004E - 000000000000004F] Motherboard resources
📁	[0000000000000050 - 0000000000000053] System timer
📁	[0000000000000050 - 0000000000000053] System timer
📁	[0000000000000060 - 0000000000000060] Standard PS/2 Keyboard
📁	[0000000000000061 - 0000000000000061] Motherboard resources
📁	[0000000000000062 - 0000000000000062] Microsoft ACPI-Compliant Embedded Controller
📁	[0000000000000063 - 0000000000000063] Motherboard resources
📁	[0000000000000064 - 0000000000000064] Standard PS/2 Keyboard
📁	[0000000000000065 - 0000000000000065] Motherboard resources
📁	[0000000000000066 - 0000000000000066] Microsoft ACPI-Compliant Embedded Controller
📁	[0000000000000067 - 0000000000000067] Motherboard resources
📁	[0000000000000070 - 0000000000000070] Motherboard resources
📁	[0000000000000070 - 0000000000000077] System CMOS/real time clock
📁	[0000000000000078 - 00000000000000CF7] PCI Express Root Complex
📁	[0000000000000080 - 000000000000008F] Motherboard resources
📁	[0000000000000092 - 0000000000000092] Motherboard resources
📁	[00000000000000A0 - 00000000000000A1] Programmable interrupt controller
📁	[00000000000000A0 - 00000000000000A1] Programmable interrupt controller
📁	[00000000000000A4 - 00000000000000A5] Programmable interrupt controller
📁	[00000000000000A4 - 00000000000000A5] Programmable interrupt controller
📁	[00000000000000A8 - 00000000000000A9] Programmable interrupt controller
📁	[00000000000000A8 - 00000000000000A9] Programmable interrupt controller
📁	[00000000000000AC - 00000000000000AD] Programmable interrupt controller
📁	[00000000000000AC - 00000000000000AD] Programmable interrupt controller
📁	[00000000000000B0 - 00000000000000B1] Programmable interrupt controller
📁	[00000000000000B0 - 00000000000000B1] Programmable interrupt controller
📁	[00000000000000B2 - 00000000000000B3] Motherboard resources
📁	[00000000000000B4 - 00000000000000B5] Programmable interrupt controller
📁	[00000000000000B4 - 00000000000000B5] Programmable interrupt controller
📁	[00000000000000B8 - 00000000000000B9] Programmable interrupt controller

	[00000000000000BC - 00000000000000BD]	Programmable interrupt controller
	[00000000000000BC - 00000000000000BD]	Programmable interrupt controller
	[0000000000000240 - 0000000000000247]	Communications Port (COM3)
	[0000000000000248 - 000000000000024F]	Communications Port (COM4)
	[0000000000000250 - 0000000000000257]	Communications Port (COM5)
	[0000000000000258 - 000000000000025F]	Communications Port (COM6)
	[00000000000002F8 - 00000000000002FF]	Communications Port (COM2)
	[00000000000003F8 - 00000000000003FF]	Communications Port (COM1)
	[0000000000000400 - 000000000000047F]	Motherboard resources
	[00000000000004D0 - 00000000000004D1]	Programmable interrupt controller
	[00000000000004D0 - 00000000000004D1]	Programmable interrupt controller
	[0000000000000500 - 00000000000005FE]	Motherboard resources
	[0000000000000600 - 000000000000061F]	Motherboard resources
	[0000000000000680 - 000000000000069F]	Motherboard resources
	[0000000000000D00 - 000000000000FFFF]	PCI Express Root Complex
	[0000000000001000 - 000000000000101F]	Intel(R) I210 Gigabit Network Connection
	[0000000000001000 - 0000000000001FFF]	Intel(R) Celeron(R)/Pentium(R) Processor PCI Express Root Port - 5ADA
	[000000000000164E - 000000000000164F]	Motherboard resources
	[0000000000002000 - 000000000000203F]	Intel(R) HD Graphics
	[0000000000002040 - 000000000000205F]	Intel(R) Celeron(R)/Pentium(R) Processor SMBUS - 5AD4
	[0000000000002060 - 000000000000207F]	Standard SATA AHCI Controller
	[0000000000002080 - 0000000000002087]	Standard SATA AHCI Controller
	[0000000000002088 - 000000000000208B]	Standard SATA AHCI Controller
	[000000000000B000 - 000000000000BFFF]	PCI Express Downstream Switch Port
	[000000000000B000 - 000000000000CFFF]	PCI Express Upstream Switch Port
	[000000000000C000 - 000000000000CFFF]	PCI Express Downstream Switch Port
	[000000000000D000 - 000000000000DFFF]	Intel(R) Celeron(R)/Pentium(R) Processor PCI Express Root Port - 5AD9
	[000000000000E000 - 000000000000EFFF]	Intel(R) Celeron(R)/Pentium(R) Processor PCI Express Root Port - 5AD8
	[000000000000F000 - 000000000000F03F]	Intel(R) HD Graphics
	[000000000000F000 - 000000000000F03F]	Intel(R) HD Graphics
	[000000000000F040 - 000000000000F05F]	Intel(R) Celeron(R)/Pentium(R) Processor SMBUS - 5AD4
	[000000000000F060 - 000000000000F07F]	Standard SATA AHCI Controller
	[000000000000F080 - 000000000000F083]	Standard SATA AHCI Controller
	[000000000000F090 - 000000000000F097]	Standard SATA AHCI Controller

3.5 Interrupt Controller (IRQ) Map

The interrupt controller (IRQ) mapping list is shown as follows:















































▼		Interrupt request (IRQ)	
		(ISA) 0x00000000 (00)	System timer
		(ISA) 0x00000000 (00)	System timer
		(ISA) 0x00000001 (01)	Standard PS/2 Keyboard
		(ISA) 0x00000003 (03)	Communications Port (COM2)
		(ISA) 0x00000003 (03)	Intel SD Host Controller
		(ISA) 0x00000004 (04)	Communications Port (COM1)
		(ISA) 0x00000004 (04)	PCI Data Acquisition and Signal Processing Controller
		(ISA) 0x00000005 (05)	PCI Data Acquisition and Signal Processing Controller
		(ISA) 0x00000006 (06)	Communications Port (COM4)
		(ISA) 0x00000006 (06)	PCI Data Acquisition and Signal Processing Controller
		(ISA) 0x00000007 (07)	Communications Port (COM3)
		(ISA) 0x00000007 (07)	PCI Data Acquisition and Signal Processing Controller
		(ISA) 0x00000008 (08)	High precision event timer
		(ISA) 0x0000000A (10)	Communications Port (COM5)
		(ISA) 0x0000000B (11)	Communications Port (COM6)
		(ISA) 0x0000000E (14)	Intel(R) Serial IO GPIO Host Controller - INT3452
		(ISA) 0x0000000E (14)	Intel(R) Serial IO GPIO Host Controller - INT3452
		(ISA) 0x0000000E (14)	Intel(R) Serial IO GPIO Host Controller - INT3452
		(ISA) 0x0000000E (14)	Intel(R) Serial IO GPIO Host Controller - INT3452
		(ISA) 0x00000011 (17)	Intel(R) USB 3.0 eXtensible Host Controller - 1.0 (Microsoft)
		(ISA) 0x00000015 (21)	Multimedia Controller
		(ISA) 0x00000019 (25)	Multimedia Audio Controller
		(ISA) 0x0000001A (26)	PCI Device
		(ISA) 0x0000001B (27)	Intel(R) Serial IO I2C Host Controller - 5AAC
		(ISA) 0x0000001C (28)	Intel(R) Serial IO I2C Host Controller - 5AAE
		(ISA) 0x0000001D (29)	Intel(R) Serial IO I2C Host Controller - 5AB0
		(ISA) 0x0000001E (30)	Intel(R) Serial IO I2C Host Controller - 5AB2
		(ISA) 0x0000001F (31)	Intel(R) Serial IO I2C Host Controller - 5AB4
		(ISA) 0x00000020 (32)	Intel(R) Serial IO I2C Host Controller - 5AB6
		(ISA) 0x00000021 (33)	Intel(R) Serial IO I2C Host Controller - 5AB8
		(ISA) 0x00000022 (34)	Intel(R) Serial IO I2C Host Controller - 5ABA
		(ISA) 0x00000023 (35)	PCI Data Acquisition and Signal Processing Controller
		(ISA) 0x00000024 (36)	PCI Data Acquisition and Signal Processing Controller
		(ISA) 0x00000025 (37)	PCI Data Acquisition and Signal Processing Controller
		(ISA) 0x00000027 (39)	Intel SD Host Controller
		(ISA) 0x0000002A (42)	Intel SD Host Controller
		(ISA) 0x00000032 (50)	I2C HID Device
		(ISA) 0x00000036 (54)	Microsoft ACPI-Compliant System
		(ISA) 0x00000037 (55)	Microsoft ACPI-Compliant System
		(ISA) 0x00000038 (56)	Microsoft ACPI-Compliant System
		(ISA) 0x00000039 (57)	Microsoft ACPI-Compliant System
		(ISA) 0x0000003A (58)	Microsoft ACPI-Compliant System
		(ISA) 0x0000003B (59)	Microsoft ACPI-Compliant System
		(ISA) 0x0000003C (60)	Microsoft ACPI-Compliant System
		(ISA) 0x0000003D (61)	Microsoft ACPI-Compliant System
		(ISA) 0x0000003E (62)	Microsoft ACPI-Compliant System
		(ISA) 0x0000003F (63)	Microsoft ACPI-Compliant System
		(ISA) 0x00000040 (64)	Microsoft ACPI-Compliant System
		(ISA) 0x00000041 (65)	Microsoft ACPI-Compliant System
		(ISA) 0x00000042 (66)	Microsoft ACPI-Compliant System
		(ISA) 0x00000043 (67)	Microsoft ACPI-Compliant System

	(PCI) 0xFFFFFFFFF (-17)	Intel(R) I211 Gigabit Network Connection #5
	(PCI) 0xFFFFFFFF0 (-16)	Intel(R) I211 Gigabit Network Connection #5
	(PCI) 0xFFFFFFFF1 (-15)	Intel(R) I211 Gigabit Network Connection #5
	(PCI) 0xFFFFFFFF2 (-14)	Intel(R) I211 Gigabit Network Connection #5
	(PCI) 0xFFFFFFFF3 (-13)	Intel(R) I211 Gigabit Network Connection #6
	(PCI) 0xFFFFFFFF4 (-12)	Intel(R) I211 Gigabit Network Connection #6
	(PCI) 0xFFFFFFFF5 (-11)	Intel(R) I211 Gigabit Network Connection #6
	(PCI) 0xFFFFFFFF6 (-10)	Intel(R) I211 Gigabit Network Connection #6
	(PCI) 0xFFFFFFFF7 (-9)	Intel(R) USB 3.0 eXtensible Host Controller - 1.0 (Microsoft)
	(PCI) 0xFFFFFFFF8 (-8)	Intel(R) Trusted Execution Engine Interface
	(PCI) 0xFFFFFFFF9 (-7)	Intel(R) HD Graphics
	(PCI) 0xFFFFFFFFFA (-6)	Standard SATA AHCI Controller
	(PCI) 0xFFFFFFFFFB (-5)	Intel(R) Celeron(R)/Pentium(R) Processor PCI Express Root Port - 5ADB
	(PCI) 0xFFFFFFFFFC (-4)	Intel(R) Celeron(R)/Pentium(R) Processor PCI Express Root Port - 5ADA
	(PCI) 0xFFFFFFFFFD (-3)	Intel(R) Celeron(R)/Pentium(R) Processor PCI Express Root Port - 5AD9
	(PCI) 0xFFFFFFFFFE (-2)	Intel(R) Celeron(R)/Pentium(R) Processor PCI Express Root Port - 5AD8

3.6 Memory Map

The memory mapping list is shown as follows:

▼	Memory	
		[000000007B800001 - 000000007BFFFFFF] PCI Express Root Complex
		[000000007C000001 - 000000007CFFFFFF] PCI Express Root Complex
		[0000000080000000 - 0000000080FFFFFF] Intel(R) HD Graphics
		[0000000080000000 - 00000000CFFFFFFF] PCI Express Root Complex
		[0000000090000000 - 0000000090FFFFFF] Intel(R) HD Graphics
		[0000000091000000 - 0000000091FFFFFF] Multimedia Controller
		[0000000092000000 - 00000000920FFFFF] Multimedia Audio Controller
		[0000000092100000 - 000000009211FFFF] Intel(R) I210 Gigabit Network Connection
		[0000000092100000 - 00000000921Fffff] Intel(R) Celeron(R)/Pentium(R) Processor PCI Express Root Port - 5ADA
		[0000000092120000 - 0000000092123FFF] Intel(R) I210 Gigabit Network Connection
		[0000000092200000 - 000000009220FFFF] Intel(R) USB 3.0 eXtensible Host Controller - 1.0 (Microsoft)
		[0000000092210000 - 0000000092213FFF] Multimedia Audio Controller
		[0000000092214000 - 0000000092215FFF] PCI Device
		[0000000092216000 - 0000000092217FFF] Standard SATA AHCI Controller
		[0000000092218000 - 0000000092218FFF] Intel(R) Trusted Execution Engine Interface
		[000000009221B000 - 000000009221BFFF] PCI Device
		[000000009221C000 - 000000009221CFFF] Intel(R) Serial IO I2C Host Controller - 5AAC
		[000000009221D000 - 000000009221DFFF] Intel(R) Serial IO I2C Host Controller - 5AAC
		[000000009221E000 - 000000009221EFFF] Intel(R) Serial IO I2C Host Controller - 5AAE
		[000000009221F000 - 000000009221FFFF] Intel(R) Serial IO I2C Host Controller - 5AAE
		[0000000092220000 - 0000000092220FFF] Intel(R) Serial IO I2C Host Controller - 5AB0
		[0000000092221000 - 0000000092221FFF] Intel(R) Serial IO I2C Host Controller - 5AB0
		[0000000092222000 - 0000000092222FFF] Intel(R) Serial IO I2C Host Controller - 5AB2
		[0000000092223000 - 0000000092223FFF] Intel(R) Serial IO I2C Host Controller - 5AB2
		[0000000092224000 - 0000000092224FFF] Intel(R) Serial IO I2C Host Controller - 5AB4
		[0000000092225000 - 0000000092225FFF] Intel(R) Serial IO I2C Host Controller - 5AB4
		[0000000092226000 - 0000000092226FFF] Intel(R) Serial IO I2C Host Controller - 5AB6
		[0000000092227000 - 0000000092227FFF] Intel(R) Serial IO I2C Host Controller - 5AB6
		[0000000092228000 - 0000000092228FFF] Intel(R) Serial IO I2C Host Controller - 5AB8
		[0000000092229000 - 0000000092229FFF] Intel(R) Serial IO I2C Host Controller - 5AB8
		[000000009222A000 - 000000009222AFFF] Intel(R) Serial IO I2C Host Controller - 5ABA
		[000000009222B000 - 000000009222BFFF] Intel(R) Serial IO I2C Host Controller - 5ABA
		[000000009222C000 - 000000009222CFFF] PCI Data Acquisition and Signal Processing Controller
		[000000009222D000 - 000000009222DFFF] PCI Data Acquisition and Signal Processing Controller
		[000000009222E000 - 000000009222EFFF] PCI Data Acquisition and Signal Processing Controller
		[000000009222F000 - 000000009222FFFF] PCI Data Acquisition and Signal Processing Controller
		[0000000092230000 - 0000000092230FFF] PCI Data Acquisition and Signal Processing Controller
		[0000000092231000 - 0000000092231FFF] PCI Data Acquisition and Signal Processing Controller
		[0000000092232000 - 0000000092232FFF] PCI Data Acquisition and Signal Processing Controller
		[0000000092233000 - 0000000092233FFF] PCI Data Acquisition and Signal Processing Controller
		[0000000092234000 - 0000000092234FFF] PCI Data Acquisition and Signal Processing Controller
		[0000000092235000 - 0000000092235FFF] PCI Data Acquisition and Signal Processing Controller
		[0000000092236000 - 0000000092236FFF] PCI Data Acquisition and Signal Processing Controller
		[0000000092237000 - 0000000092237FFF] PCI Data Acquisition and Signal Processing Controller
		[0000000092238000 - 0000000092238FFF] PCI Data Acquisition and Signal Processing Controller
		[0000000092239000 - 0000000092239FFF] PCI Data Acquisition and Signal Processing Controller
		[000000009223A000 - 000000009223AFFF] Intel SD Host Controller

	[000000009223B000 - 000000009223BFFF] Intel SD Host Controller
	[000000009223C000 - 000000009223CFFF] Intel SD Host Controller
	[000000009223D000 - 000000009223DFFF] Intel SD Host Controller
	[000000009223E000 - 000000009223EFFF] Intel SD Host Controller
	[000000009223F000 - 000000009223FFFF] Intel SD Host Controller
	[0000000092240000 - 00000000922407FF] Standard SATA AHCI Controller
	[0000000092241000 - 00000000922410FF] Intel(R) Celeron(R)/Pentium(R) Processor SMBUS - 5AD4
	[0000000092242000 - 00000000922420FF] Standard SATA AHCI Controller
	[00000000B0000000 - 00000000BFFFFFFF] Intel(R) HD Graphics
	[00000000B0000000 - 00000000BFFFFFFF] Intel(R) HD Graphics
	[00000000C0000000 - 00000000C0FFFFFF] Intel(R) HD Graphics
	[00000000C0000000 - 00000000C0FFFFFF] Intel(R) HD Graphics
	[00000000C1000000 - 00000000C1001FFF] Renesas USB 3.0 eXtensible Host Controller - 1.0 (Microsoft)
	[00000000C1000000 - 00000000C100FFFF] Intel(R) Celeron(R)/Pentium(R) Processor PCI Express Root Port - 5AD9
	[00000000C1000000 - 00000000C100FFFF] PCI Express Downstream Switch Port
	[00000000C1000000 - 00000000C110FFFF] PCI Express Upstream Switch Port
	[00000000C10DC000 - 00000000C10DFFFF] Intel(R) I211 Gigabit Network Connection #6
	[00000000C10E0000 - 00000000C10FFFFFFF] Intel(R) I211 Gigabit Network Connection #6
	[00000000C1100000 - 00000000C110FFFF] Intel(R) Celeron(R)/Pentium(R) Processor PCI Express Root Port - 5AD8
	[00000000C1100000 - 00000000C110FFFF] PCI Express Downstream Switch Port
	[00000000C11DC000 - 00000000C11DFFFF] Intel(R) I211 Gigabit Network Connection #5
	[00000000C11E0000 - 00000000C11FFFFFFF] Intel(R) I211 Gigabit Network Connection #5
	[00000000C1200000 - 00000000C120FFFF] Intel(R) USB 3.0 eXtensible Host Controller - 1.0 (Microsoft)
	[00000000C1210000 - 00000000C1211FFF] Standard SATA AHCI Controller
	[00000000C1212000 - 00000000C12127FF] Standard SATA AHCI Controller
	[00000000C1213000 - 00000000C12130FF] Standard SATA AHCI Controller
	[00000000C1216000 - 00000000C1216FFF] Intel(R) Trusted Execution Engine Interface
	[00000000D0C00000 - 00000000D0C00653] Intel(R) Serial IO GPIO Host Controller - INT3452
	[00000000D0C40000 - 00000000D0C40763] Intel(R) Serial IO GPIO Host Controller - INT3452
	[00000000D0C50000 - 00000000D0C5076B] Intel(R) Serial IO GPIO Host Controller - INT3452
	[00000000D0C70000 - 00000000D0C70673] Intel(R) Serial IO GPIO Host Controller - INT3452
	[00000000E0000000 - 00000000EFFFFFFF] Motherboard resources
	[00000000E0000000 - 00000000EFFFFFFF] PCI Express Root Complex
	[00000000FEA00000 - 00000000FEAFFFFF] Motherboard resources
	[00000000FED00000 - 00000000FED003FF] High precision event timer
	[00000000FED01000 - 00000000FED01FFF] Motherboard resources
	[00000000FED03000 - 00000000FED03FFF] Motherboard resources
	[00000000FED06000 - 00000000FED06FFF] Motherboard resources
	[00000000FED08000 - 00000000FED09FFF] Motherboard resources
	[00000000FED1C000 - 00000000FED1CFFF] Motherboard resources
	[00000000FED40000 - 00000000FED44FFF] Trusted Platform Module 2.0
	[00000000FED80000 - 00000000FEDBFFFF] Motherboard resources
	[00000000FEE00000 - 00000000FEEFFFFFFF] Motherboard resources
	[00000077FFE00000 - 00000077FFEFFFFFFF] High Definition Audio Controller
	[00000077FFF00000 - 00000077FFF03FFF] High Definition Audio Controller
	[00000077FFF04000 - 00000077FFF040FF] Intel(R) Celeron(R)/Pentium(R) Processor SMBUS - 5AD4

This page is intentionally left blank.

Chapter 4

AMI BIOS Setup Utility

The AMI UEFI BIOS provides users with a built-in setup program to modify basic system configuration. All configured parameters are stored in a flash chip to save the setup information whenever the power is turned off. This chapter provides users with detailed description about how to set up basic system configuration through the AMI BIOS setup utility.

4.1 Starting

To enter the setup screens, follow the steps below:

1. Turn on the computer and press the key immediately.
2. After you press the key, the main BIOS setup menu displays. You can access the other setup screens from the main BIOS setup menu, such as the Advanced and Chipset menus.



Note

If your computer cannot boot after making and saving system changes with BIOS setup, you can restore BIOS optimal defaults by setting JP1 (see section 2.3.2).

It is strongly recommended that you should avoid changing the chipset's defaults. Both AMI and your system manufacturer have carefully set up these defaults that provide the best performance and reliability.

4.2 Navigation Keys

The BIOS setup/utility uses a key-based navigation system called hot keys. Most of the BIOS setup utility hot keys can be used at any time during the setup navigation process. These keys include <F1>, <F2>, <Enter>, <ESC>, <Arrow> keys, and so on.



Note

Some of the navigation keys differ from one screen to another.

Hot Keys	Description
→← Left/Right	The Left and Right <Arrow> keys allow you to select a setup screen.
↑↓ Up/Down	The Up and Down <Arrow> keys allow you to select a setup screen or sub-screen.
+– Plus/Minus	The Plus and Minus <Arrow> keys allow you to change the field value of a particular setup item.
Tab	The <Tab> key allows you to select setup fields.
F1	The <F1> key allows you to display the General Help screen.
F2	The <F2> key allows you to Load Previous Values.
F3	The <F3> key allows you to Load Optimized Defaults.
F4	The <F4> key allows you to save any changes you have made and exit Setup. Press the <F4> key to save your changes.
Esc	The <Esc> key allows you to discard any changes you have made and exit the Setup. Press the <Esc> key to exit the setup without saving your changes.
Enter	The <Enter> key allows you to display or change the setup option listed for a particular setup item. The <Enter> key can also allow you to display the setup sub- screens.

4.3 Main Menu

When you first enter the setup utility, you will enter the Main setup screen. You can always return to the Main setup screen by selecting the Main tab. System Time/Date can be set up as described below. The Main BIOS setup screen is shown below.

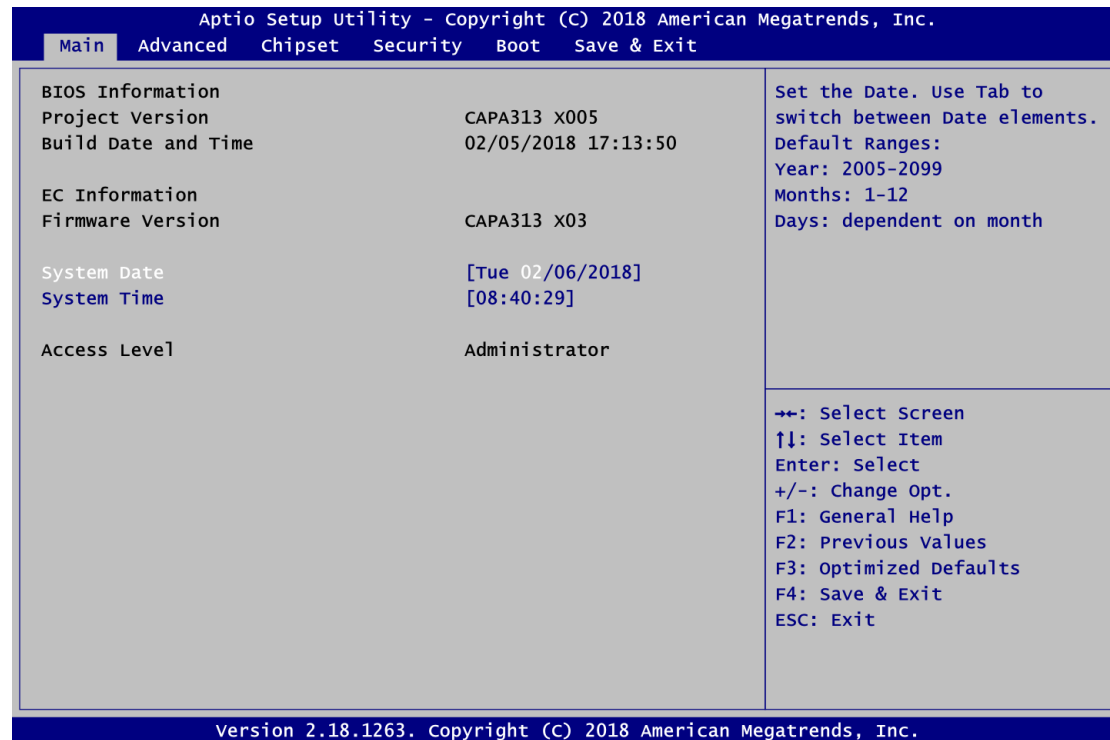

- **BIOS and EC Information**
Display BIOS and EC firmware information.
- **System Date/Time**
Use this option to change the system time and date. Highlight System Time or System Date using the <Arrow> keys. Enter new values through the keyboard. Press the <Tab> key or the <Arrow> keys to move between fields. The date must be entered in MM/DD/YY format. The time is entered in HH:MM:SS format.
- **Access Level**
Display the access level of current user.

4.4 Advanced Menu

The Advanced menu also allows users to set configuration of the CPU and other system devices. You can select any of the items in the left frame of the screen to go to the sub menus:

- ▶ Serial Port Configuration
- ▶ Hardware Monitor
- ▶ EC DIO Configuration
- ▶ ACPI Settings
- ▶ Trusted Computing (Optional)
- ▶ CPU Configuration
- ▶ SATA Configuration
- ▶ USB Configuration
- ▶ Utility Configuration

For items marked with “▶”, please press <Enter> for more options.

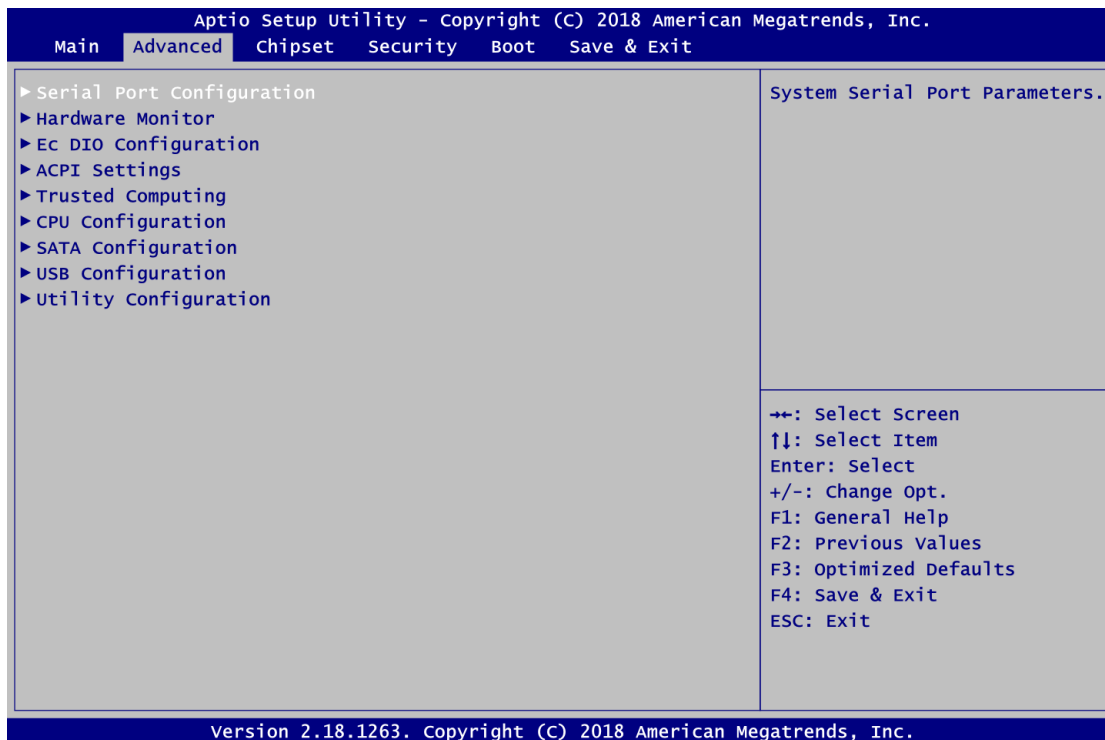

- **Serial Port Configuration**

You can use this screen to select options for Serial Port Configuration, and change the value of the selected option. A description of the selected item appears on the right side of the screen. For items marked with "▶", please press <Enter> for more options.

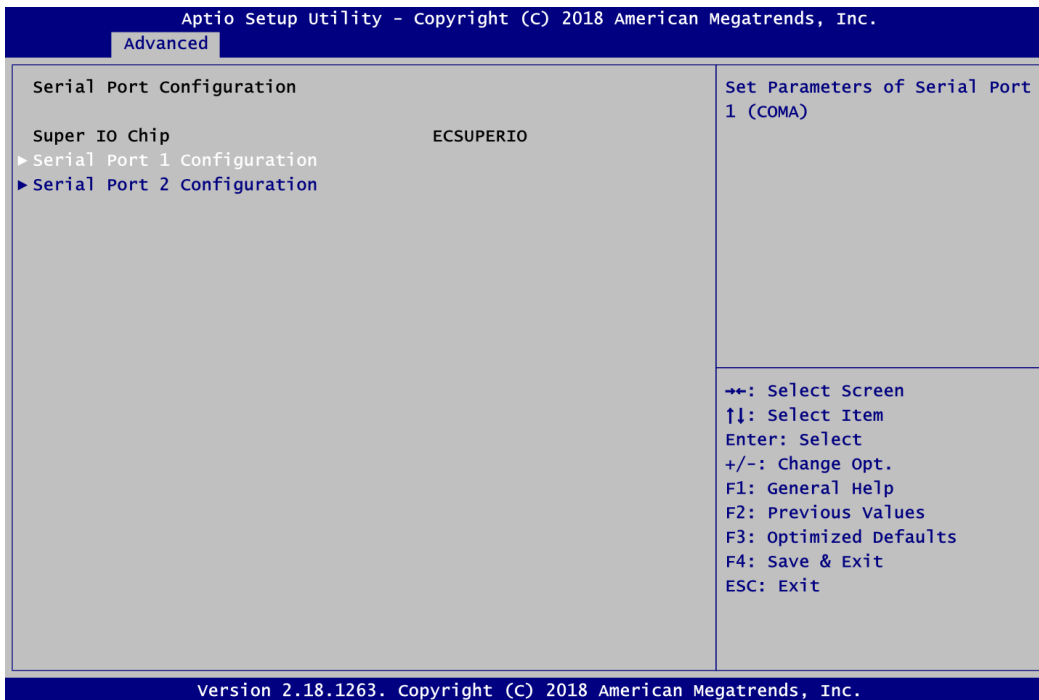

Serial Port 1~2 Configuration

Use these items to set parameters related to serial port 1~2.

- Serial Port 1 Configuration

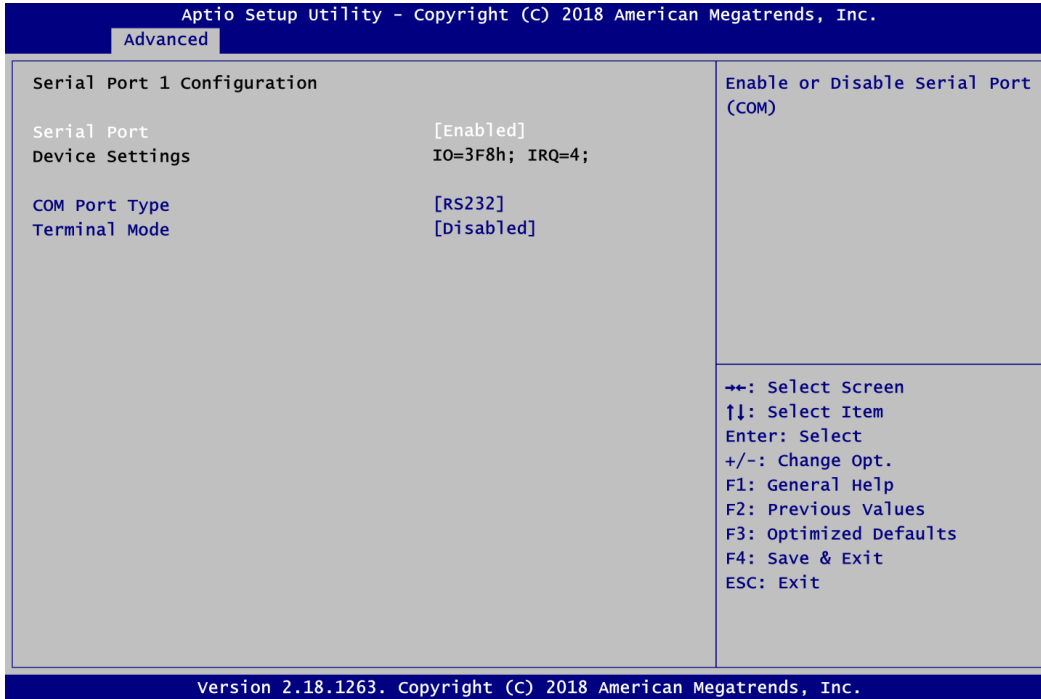

Serial Port

Enable or disable serial port 1. The optimal setting for base I/O address is 3F8h and for interrupt request address is IRQ4.

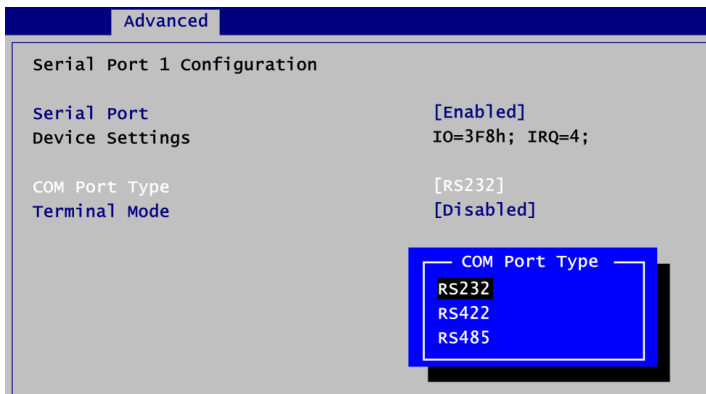

COM Port Type

Use this item to set RS-232/422/485 communication mode.

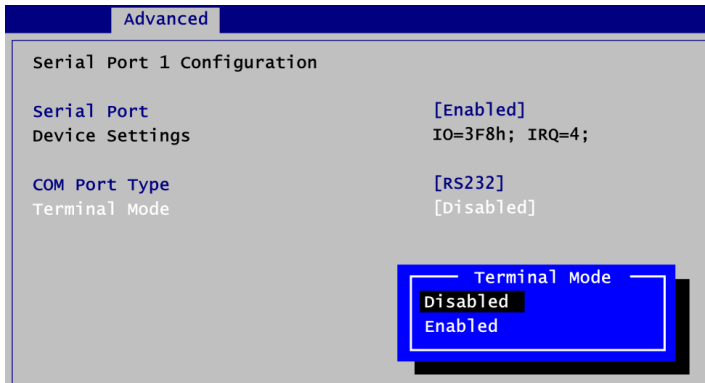

Terminal Mode

Enable terminal mode to enable the RS-422/485 termination resistor to enhance the signal.

- **Serial Port 2 Configuration**

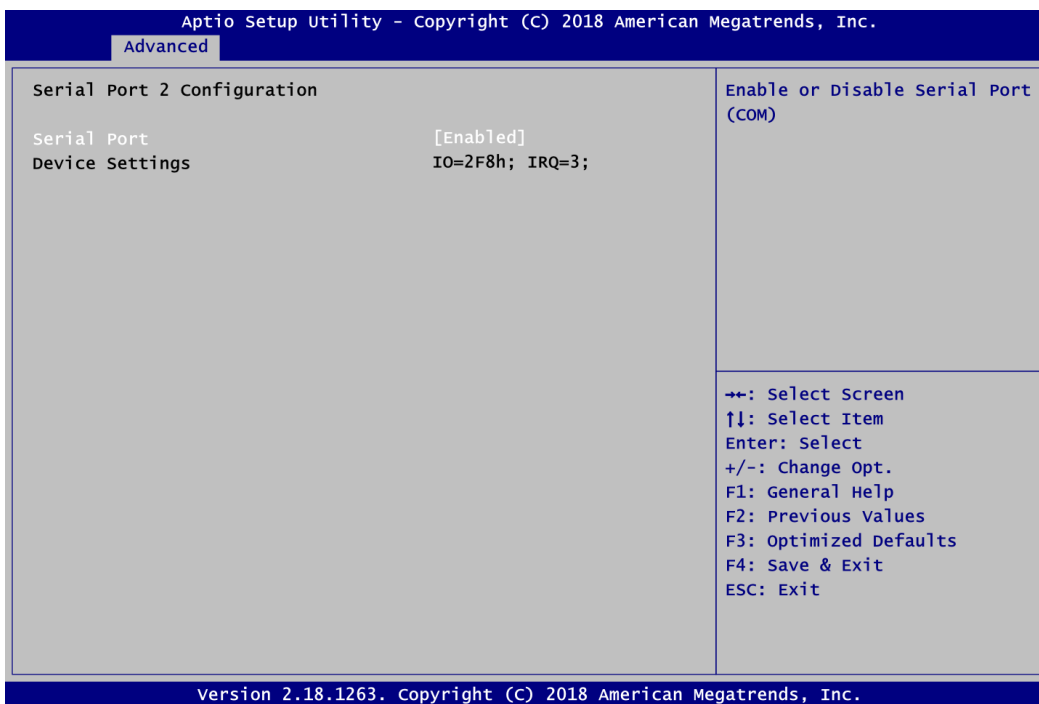

Serial Port

Enable or disable serial port 2. The optimal setting for base I/O address is 2F8h and for interrupt request address is IRQ3.

- **Hardware Monitor**

This screen monitors hardware health status.

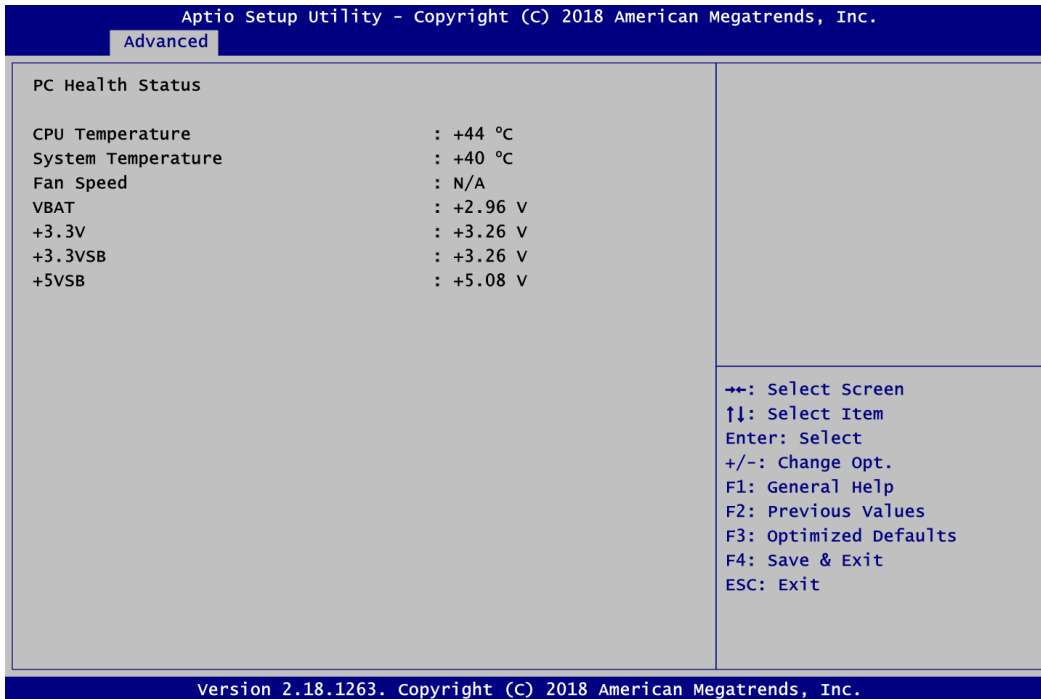

This screen displays the temperature of system and CPU, fan speed in RPM and system voltages (VBAT, +3.3V, +3.3VSB and +5VSB).

- **Ec DIO Configuration**

You can use this screen to select options for the 8-bit Digital I/O Configuration. A description of the selected item appears on the right side of the screen. For items marked with “▶”, please press <Enter> for more options.

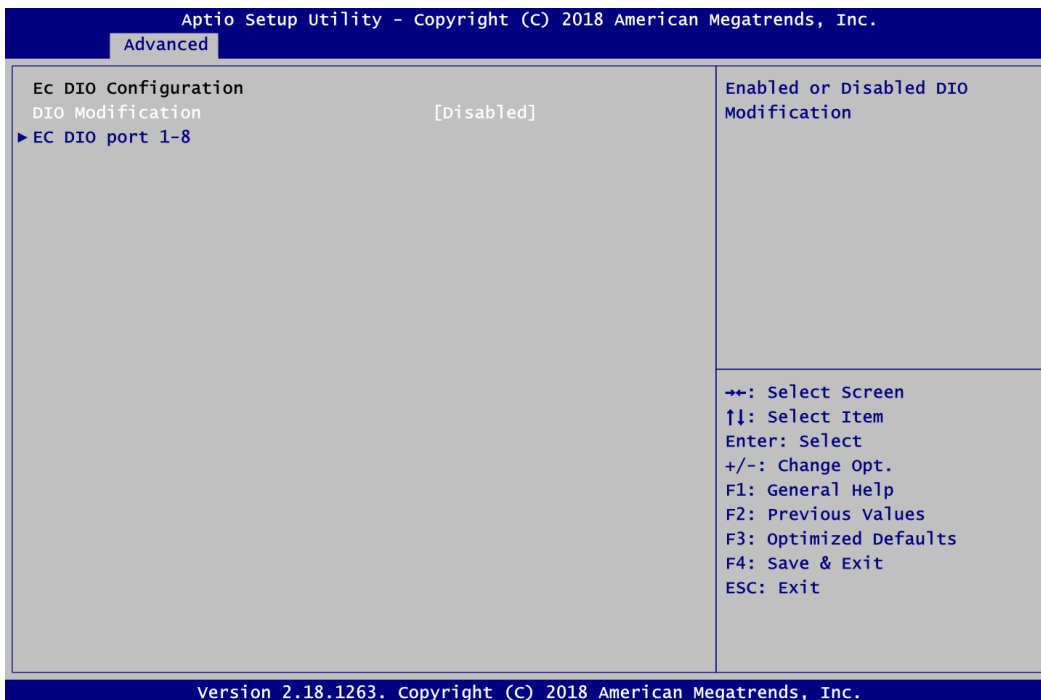

DIO Modification

Enable or disable digital I/O modification. If modification is disabled, the DIO status sub screen is as follows:

Advanced	
DIO status	
1. Input/Output Status	In & High
2. Input/Output Status	In & High
3. Input/Output Status	In & High
4. Input/Output Status	In & High
5. Input/Output Status	Out & Low
6. Input/Output Status	Out & Low
7. Input/Output Status	Out & Low
8. Input/Output Status	Out & Low

Once it is enabled, you can load manufacture default and access to the DIO status sub screen to set output or input, see image below.

Advanced	
DIO Status	
1. Input/Output Status	In & High
Input/Output Setting	[Input]
2. Input/Output Status	In & High
Input/Output Setting	[Input]
3. Input/Output Status	In & High
Input/Output Setting	[Input]
4. Input/Output Status	In & High
Input/Output Setting	[Input]
5. Input/Output Status	Out & Low
Input/Output Setting	[Output]
High/Low Setting	[Low]
6. Input/Output Status	Out & Low
Input/Output Setting	[Output]
High/Low Setting	[Low]
7. Input/Output Status	Out & Low
Input/Output Setting	[Output]
High/Low Setting	[Low]
8. Input/Output Status	Out & Low
Input/Output Setting	[Output]
High/Low Setting	[Low]

- **ACPI Settings**

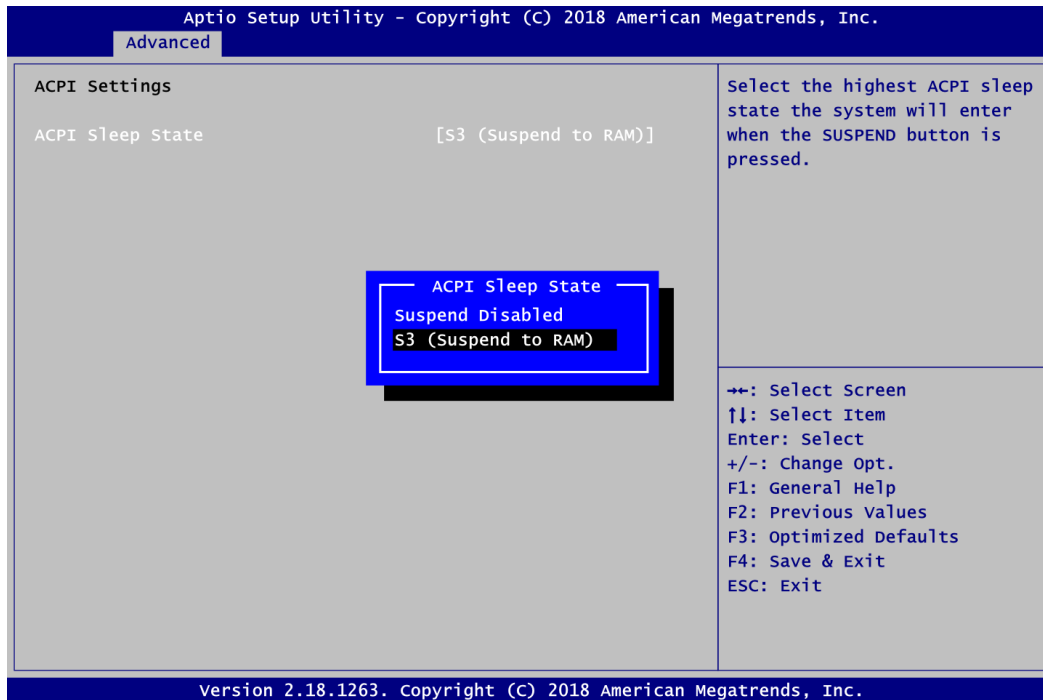

ACPI Sleep State

Select the ACPI (Advanced Configuration and Power Interface) sleep state. Configuration options are Suspend Disabled and S3 (Suspend to RAM). The S3 (Suspend to RAM) option selects ACPI sleep state the system will enter when suspend button is pressed.

- **Trusted Computing (Optional)**

This screen provides function for specifying the TPM settings.

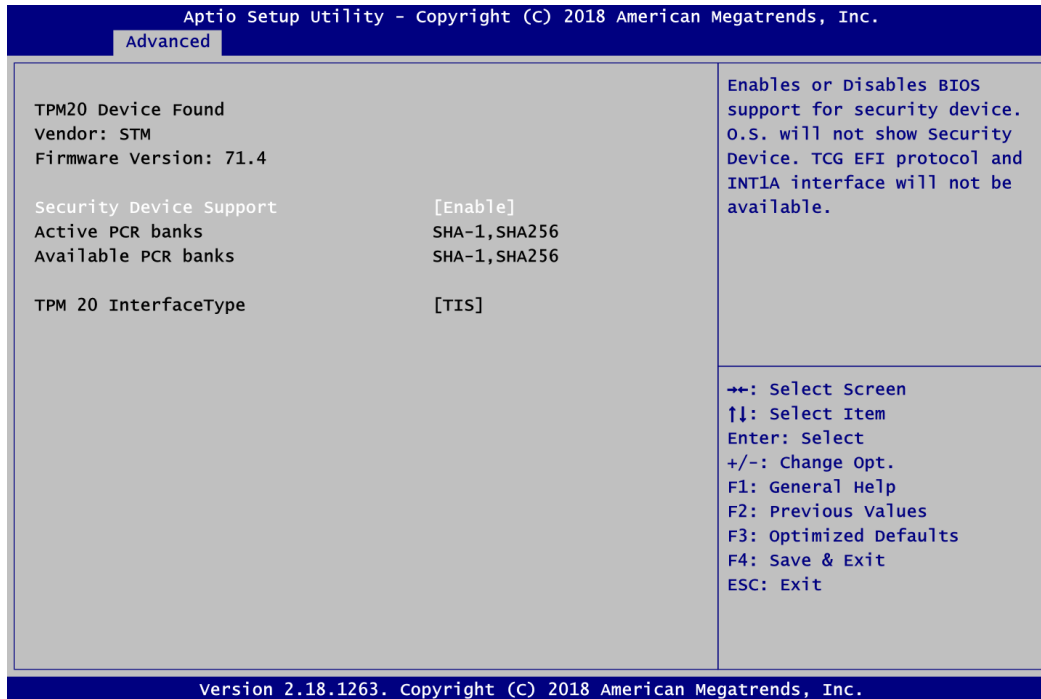

Security Device Support

Enable or disable BIOS support for security device.

- **CPU Configuration**

This screen shows the CPU Configuration.

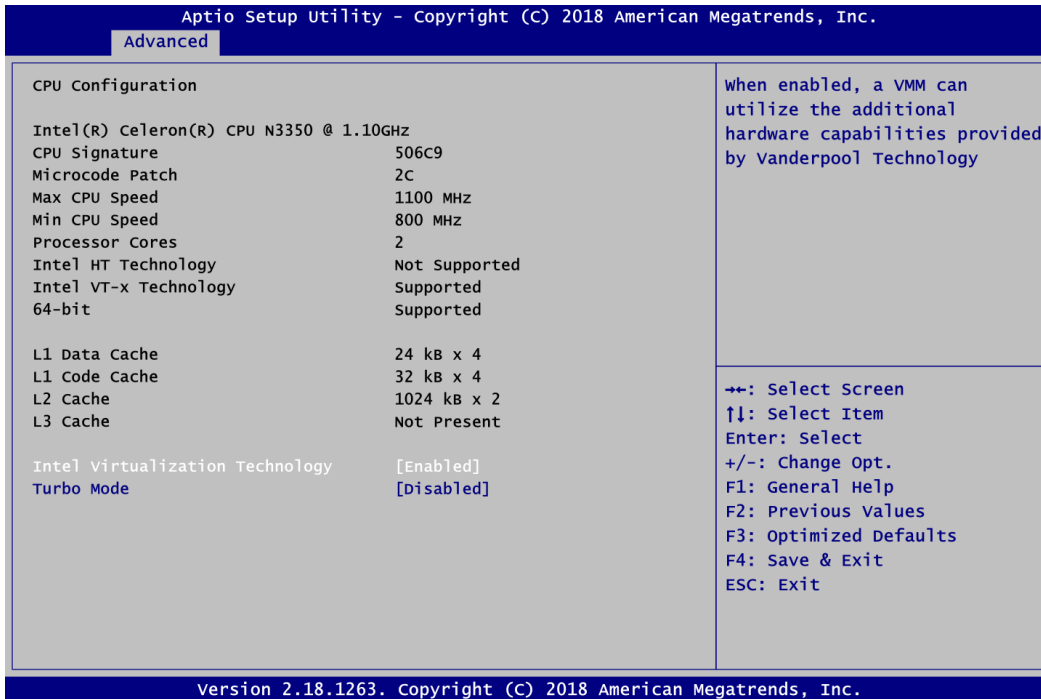

Intel Virtualization Technology

Enable or disable Intel Virtualization Technology. When enabled, a VMM (Virtual Machine Mode) can utilize the additional hardware capabilities. It allows a platform to run multiple operating systems and applications independently, hence enabling a computer system to work as several virtual systems.

Turbo Mode

Enable or disable turbo mode.

- **SATA Configuration**

In the SATA Configuration menu, you can see the currently installed hardware in the SATA ports. During system boot up, the BIOS automatically detects the presence of SATA devices.

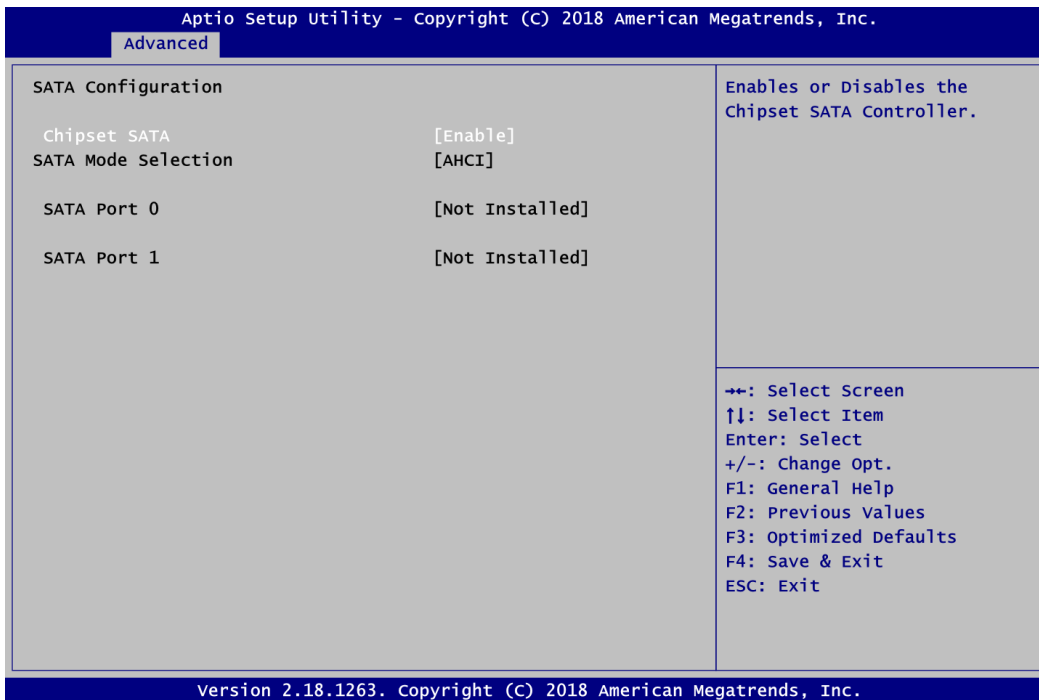
**Chipset SATA**

Enable or disable Chipset SATA Controller. The default is Enable.

- **USB Configuration**

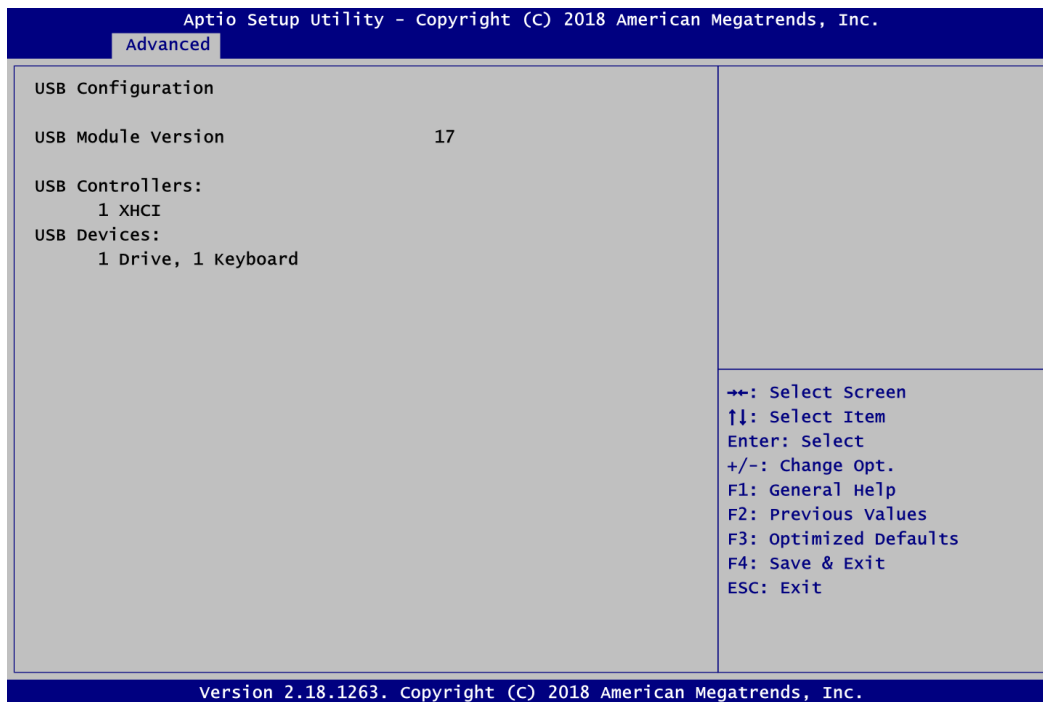

USB Devices

Display all detected USB devices.

- **Utility Configuration**

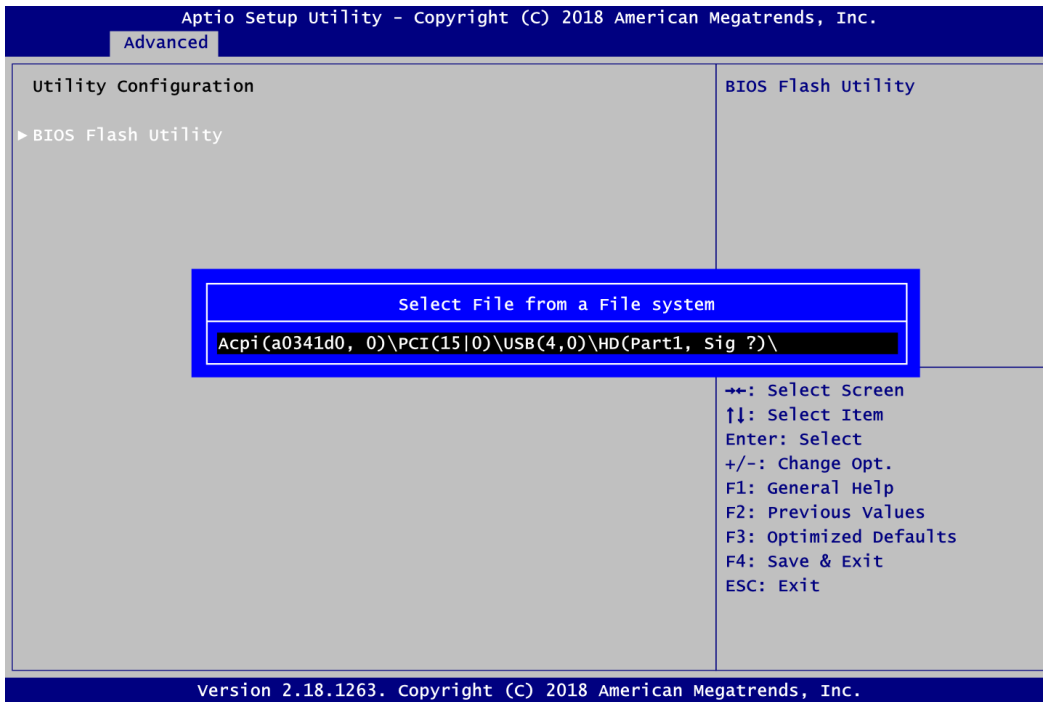
**BIOS Flash Utility**

BIOS flash utility configuration. For more detailed information, please refer to Appendix C.

4.5 Chipset Menu

The Chipset menu allows users to change the advanced chipset settings. You can select any of the items in the left frame of the screen to go to the sub menus:

- ▶ North Bridge
- ▶ South Bridge

For items marked with “▶”, please press <Enter> for more options.

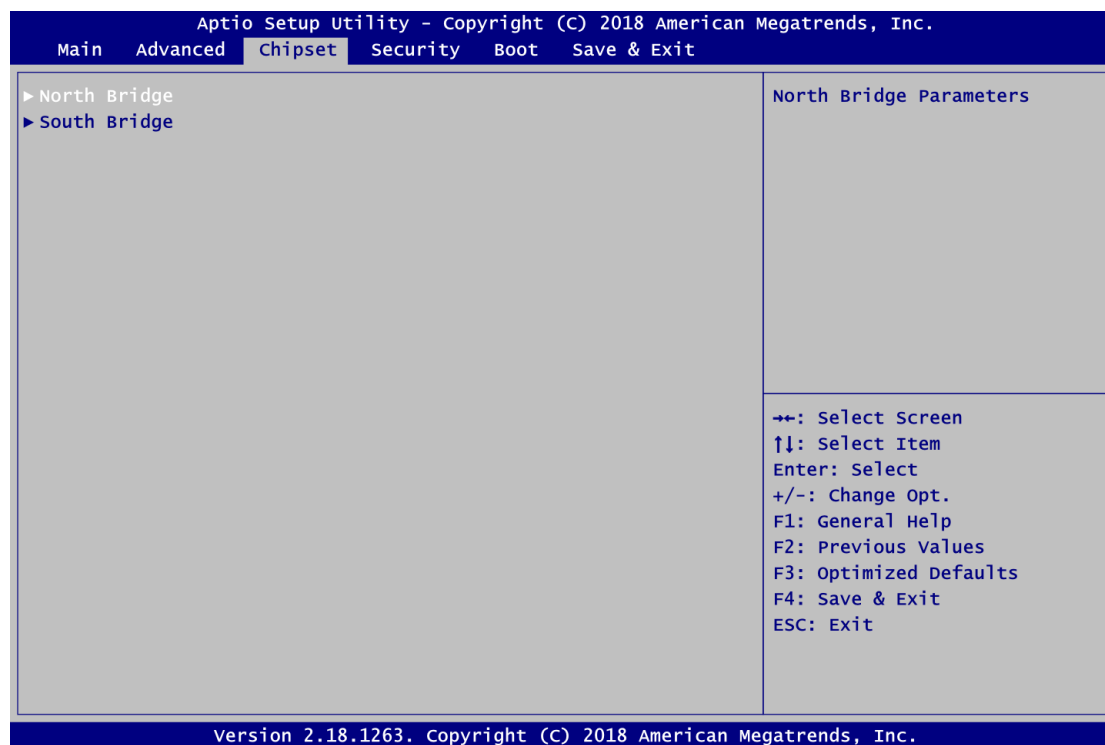

- **North Bridge**

This screen allows users to configure parameters of North Bridge chipset.

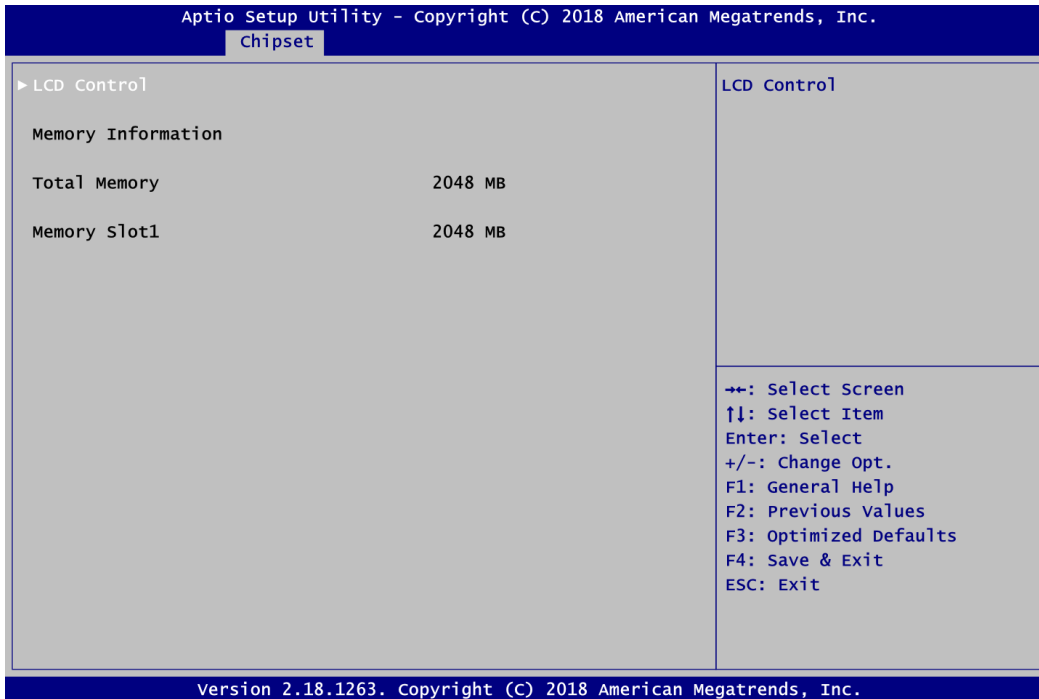
**LCD Control**

This item allows you to select LCD panel control options. Please press <Enter> to go to the sub menus.

Memory Information

Display system memory information.

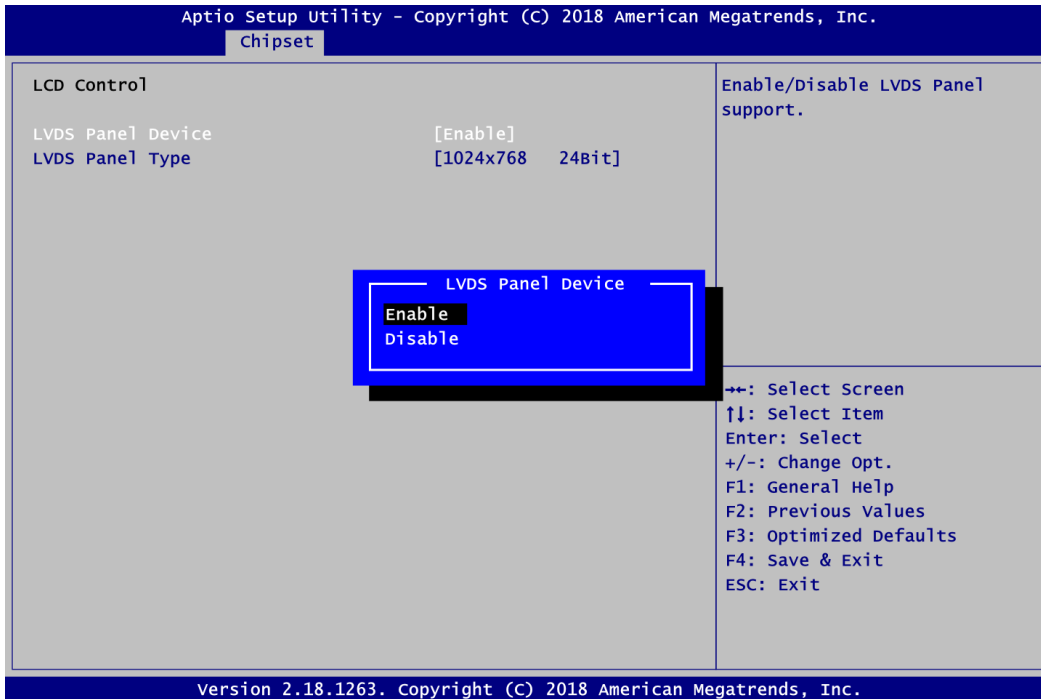

LVDS Panel Device

Enable or disable LVDS panel device support.

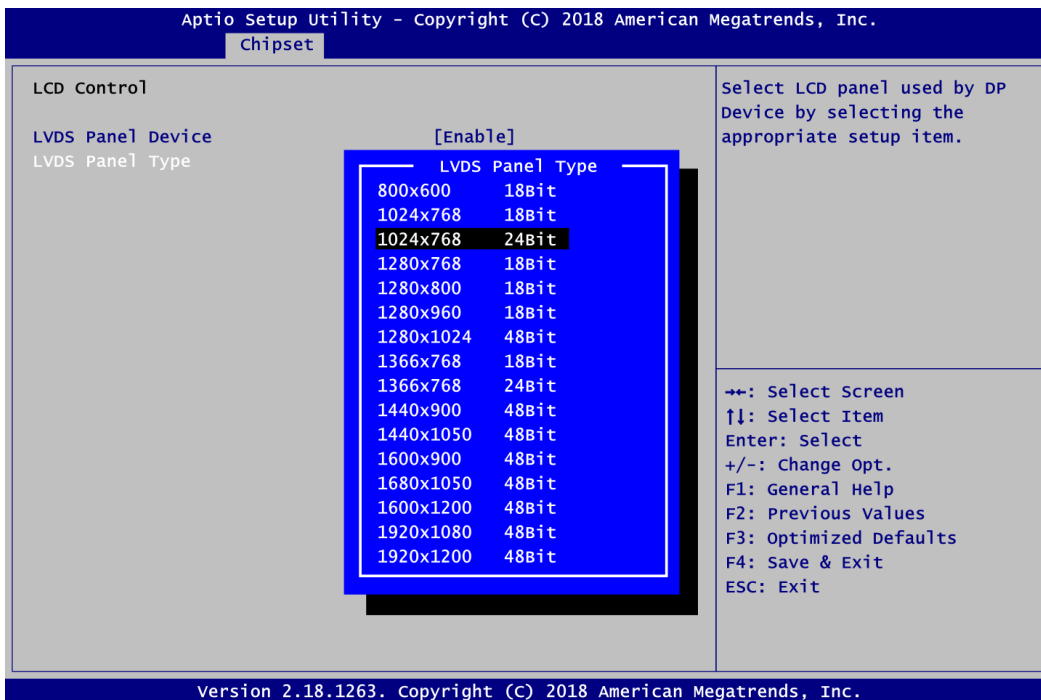

LVDS Panel Type

Select the appropriate LVDS panel resolution.

- **South Bridge**

This screen shows the information of South Bridge chipset.

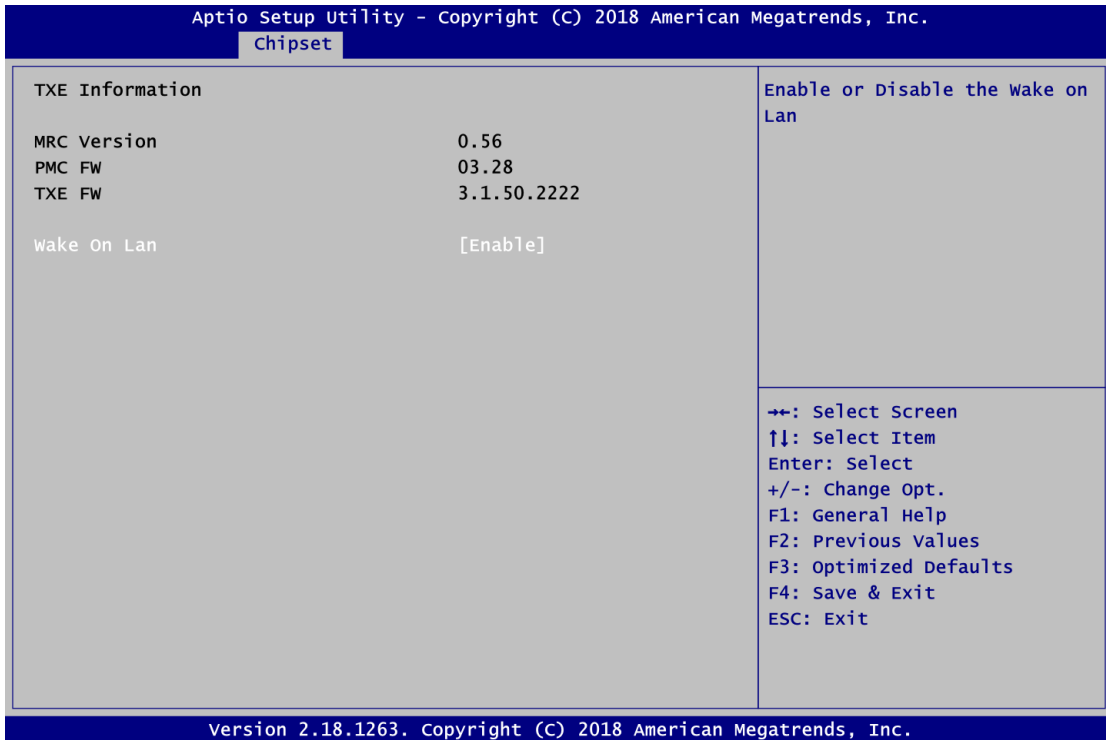

Wake On Lan

Enable or disable integrated LAN to wake the system.

4.6 Security Menu

The Security menu allows users to change the security settings for the system.



- **Setup Administrator Password.**
Set setup administrator password.
- **User Password**
Set user password.

4.7 Boot Menu

The Boot menu allows users to change boot options of the system.

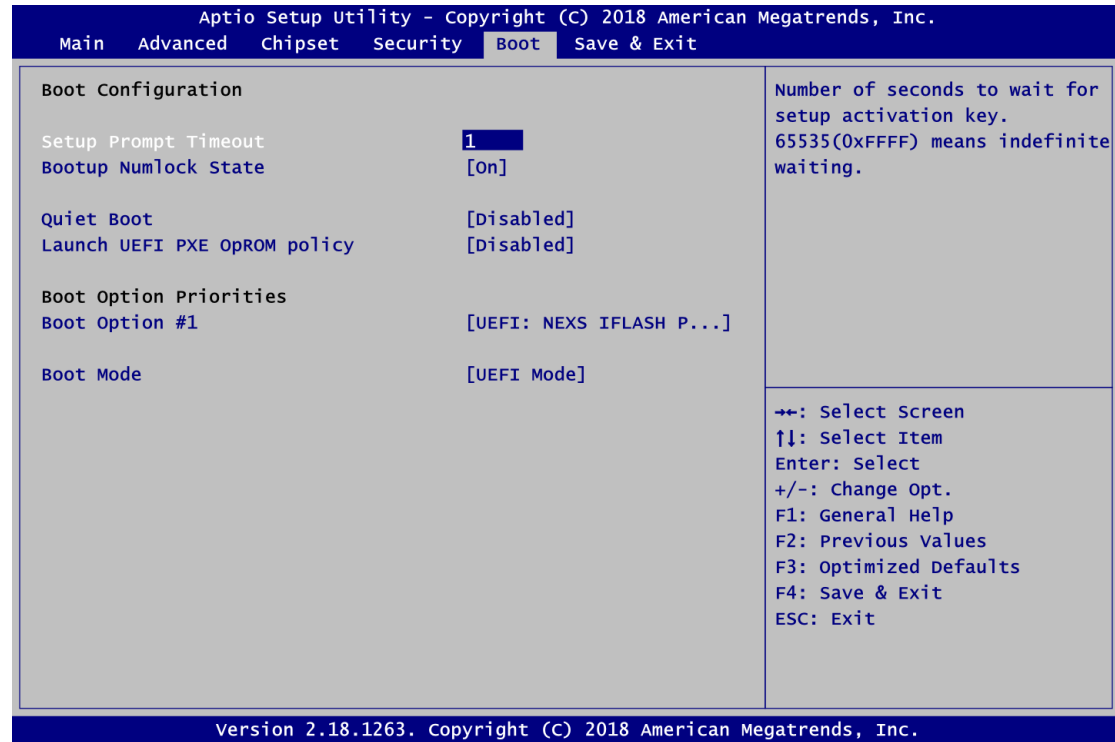

- Setup Prompt Timeout**
 Number of seconds to wait for setup activation key. 65535(0xFFFF) means indefinite waiting.
- Bootup NumLock State**
 Use this item to select the power-on state for the keyboard NumLock.
- Quiet Boot**
 Select to display either POST output messages or a splash screen during boot-up.
- Launch UEFI PXE OpROM policy**
 Control the execution of UEFI PXE OpROM.
- Boot Option Priorities**
 These are settings for boot priority. Specify the boot device priority sequence from the available devices.

- **Boot Mode**

Use this option for boot mode settings.

- UEFI Boot: Select support to boot any UEFI-capable OS.
- Legacy Boot: Select support to boot non UEFI-capable OS that expects a legacy BIOS interface.

Main	Advanced	Chipset	Security	Boot	Save & Exit
Boot Configuration					
Setup Prompt Timeout				1	
Bootup Numlock State				[On]	
Quiet Boot				[Disabled]	
Launch UEFI PXE OpROM policy				[Disabled]	
Boot Option Priorities					
Boot Option #1				[UEFI: NEXS IFLASH P...]	
Boot Mode				[UEFI Mode]	

Main	Advanced	Chipset	Security	Boot	Save & Exit
Boot Configuration					
Setup Prompt Timeout				1	
Bootup Numlock State				[On]	
Quiet Boot				[Disabled]	
Launch PXE OpROM policy				[Disabled]	
Boot Option Priorities					
Boot Option #1				[UEFI: NEXS IFLASH P...]	
Boot Mode				[Legacy Mode]	

Note that the Primary IGFX Boot Display option appears only if Legacy Mode is selected, see images below.

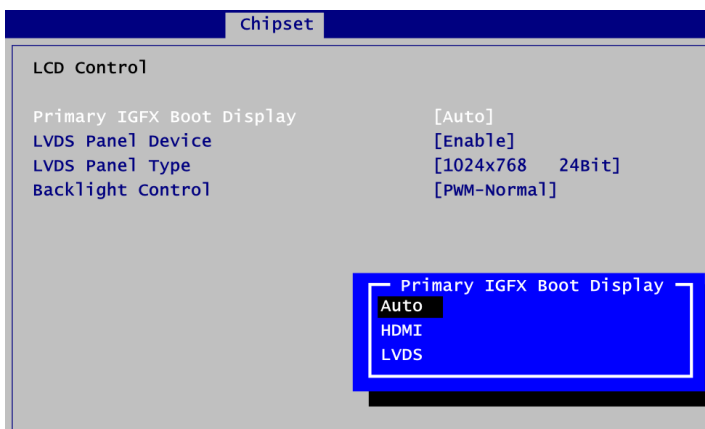
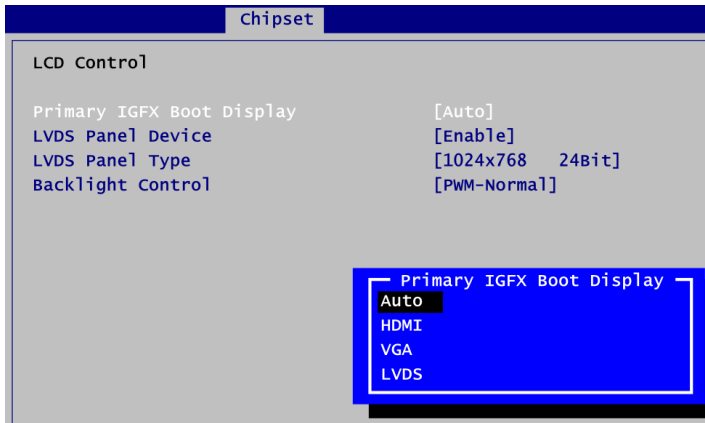

Primary IGFX Boot Display

Select the video device which will be activated during POST (Power-On Self Test).

LVDS Panel Device

Enable or disable LVDS panel device support.

LVDS Panel Type

Select the appropriate LVDS panel resolution.

Backlight Control

Use this item for backlight control setting.

4.8 Save & Exit Menu

The Save & Exit menu allows users to load your system configuration with optimal or fail-safe default values.

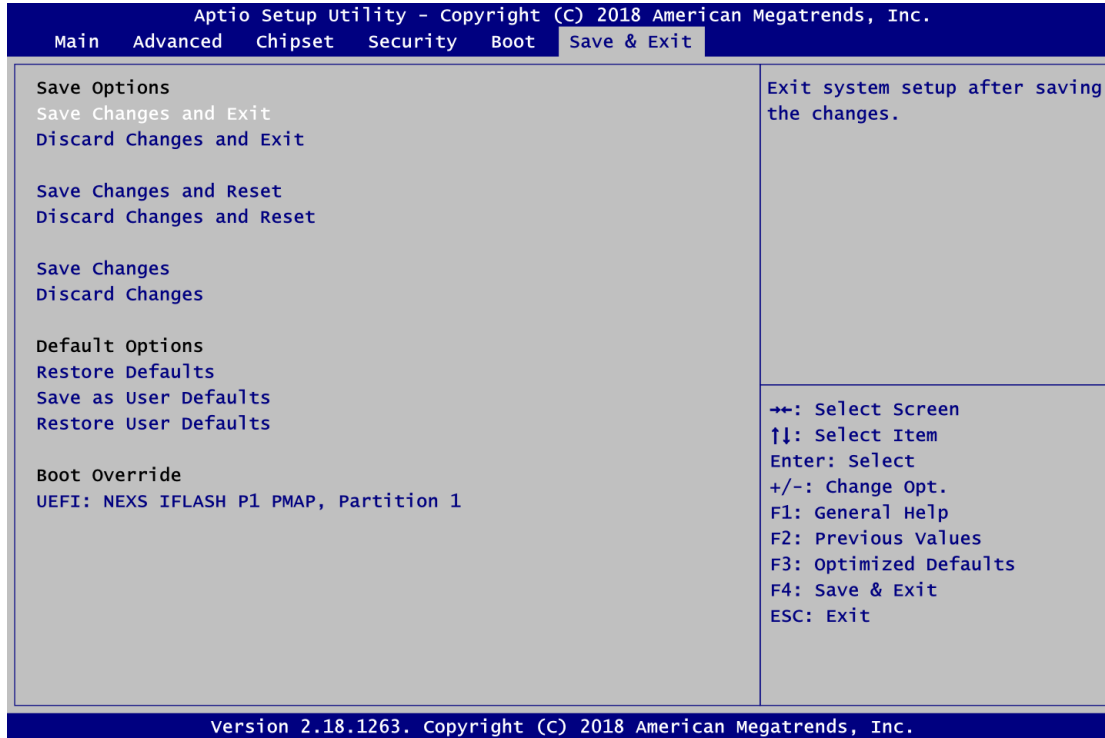

- Save Changes and Exit**
 When you have completed the system configuration changes, select this option to leave Setup and return to Main Menu. Select Save Changes and Exit from the Save & Exit menu and press <Enter>. Select Yes to save changes and exit.
- Discard Changes and Exit**
 Select this option to quit Setup without making any permanent changes to the system configuration and return to Main Menu. Select Discard Changes and Exit from the Save & Exit menu and press <Enter>. Select Yes to discard changes and exit.
- Save Changes and Reset**
 When you have completed the system configuration changes, select this option to leave Setup and reboot the computer so the new system configuration parameters can take effect. Select Save Changes and Reset from the Save & Exit menu and press <Enter>. Select Yes to save changes and reset.
- Discard Changes and Reset**
 Select this option to quit Setup without making any permanent changes to the system configuration and reboot the computer. Select Discard Changes and Reset from the Save & Exit menu and press <Enter>. Select Yes to discard changes and reset.
- Save Changes**
 When you have completed the system configuration changes, select this option to save changes. Select Save Changes from the Save & Exit menu and press <Enter>. Select Yes to save changes.

- **Discard Changes**
Select this option to quit Setup without making any permanent changes to the system configuration. Select Discard Changes from the Save & Exit menu and press <Enter>. Select Yes to discard changes.
- **Restore Defaults**
It automatically sets all Setup options to a complete set of default settings when you select this option. Select Restore Defaults from the Save & Exit menu and press <Enter>.
- **Save as User Defaults**
Select this option to save system configuration changes done so far as User Defaults. Select Save as User Defaults from the Save & Exit menu and press <Enter>.
- **Restore User Defaults**
It automatically sets all Setup options to a complete set of User Defaults when you select this option. Select Restore User Defaults from the Save & Exit menu and press <Enter>.
- **Boot Override**
Select a drive to immediately boot that device regardless of the current boot order.

This page is intentionally left blank.

Appendix A

Watchdog Timer

A.1 About Watchdog Timer

After the system stops working for a while, it can be auto-reset by the watchdog timer. The integrated watchdog timer can be set up in the system reset mode by program.

A.2 How to Use Watchdog Timer

Assembly sample code :

```
mov    dx,fa10      ; 5 seconds (Maximum is 65535 seconds; fill in
                   ; 0xFA10 and 0xFA11 register, ex: 0xFA11=0x01,
                   ; 0xFA10=0x68 means 360 seconds)

mov    al,05
out    dx,al

mov    dx,fa12      ; Enable WDT
mov    al,01
out    dx,al
```

This page is intentionally left blank.

Appendix B

Digital I/O

B.1 About Digital I/O

The onboard GPIO or digital I/O has 8 bits (DIO1~8). Each bit can be set to function as input or output by software programming. In default, all pins are pulled high with +5V level (according to main power). The BIOS default settings are 4 inputs and 4 outputs.

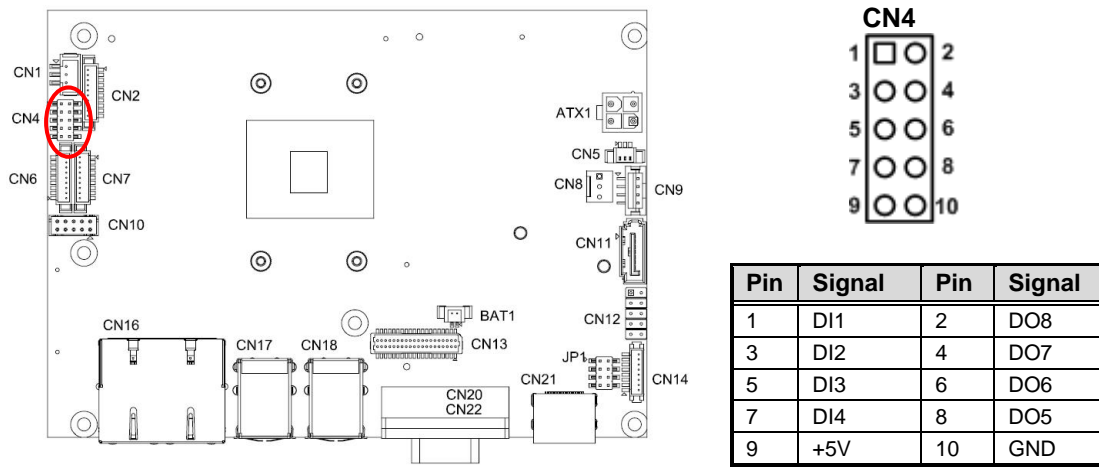

B.2 Digital I/O Programming

Assembly sample code :

```

mov    dx,fa31          ; Set DIO 0-7 to Output
mov    al,00
out    dx,al

mov    dx,fa32          ; Set DIO 4-7 to High
mov    al,f0
out    dx,al

mov    dx,fa31          ; Set DIO 0-7 to Input
mov    al,ff
out    dx,al

mov    dx,fa32          ; Get DIO 0-7 status
in     al,dx

mov    dx,fa31          ; Set DIO 0-4 to Input, 5-7 to Output
mov    al,1f            ; al = 1F => 00011111
out    dx,al

mov    dx,fa32          ; Set DIO 6 to High
mov    al,40            ; al = 40 => 01000000
out    dx,al

in     al,dx            ; Get DIO 0-7 status

```

This page is intentionally left blank.

Appendix C

BIOS Flash Utility

The BIOS Flash utility is a new helpful function in BIOS setup program. With this function you can easily update system BIOS without having to enter operating system. In this appendix you may learn how to do it in just a few steps. Please read and follow the instructions below carefully.

1. In your USB flash drive, create a new folder and name it "Axiomtek", see figure below.

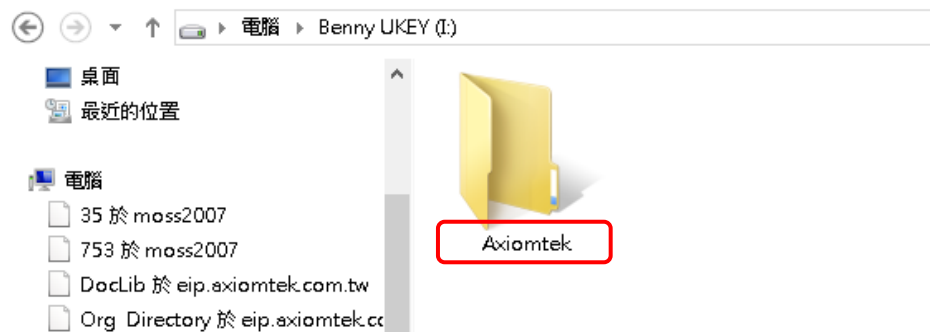

2. Copy BIOS ROM file (e.g. CAPA313.005) to "Axiomtek" folder.



3. Insert the USB flash drive to your system.
4. Enter BIOS setup menu and go to Advanced\Utility Configuration. Select BIOS Flash Utility and press <Enter>.

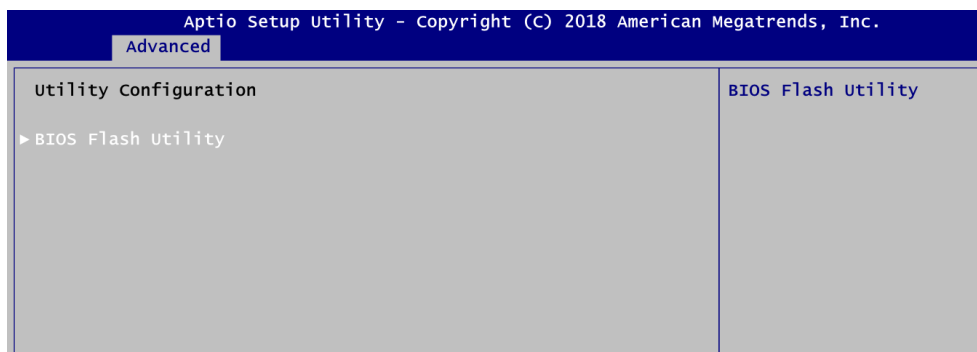

- BIOS automatically detect all USB drive(s) attached to the system. In this example only one USB drive is attached to the system. That's why, you can see only one device is displayed in figure below.

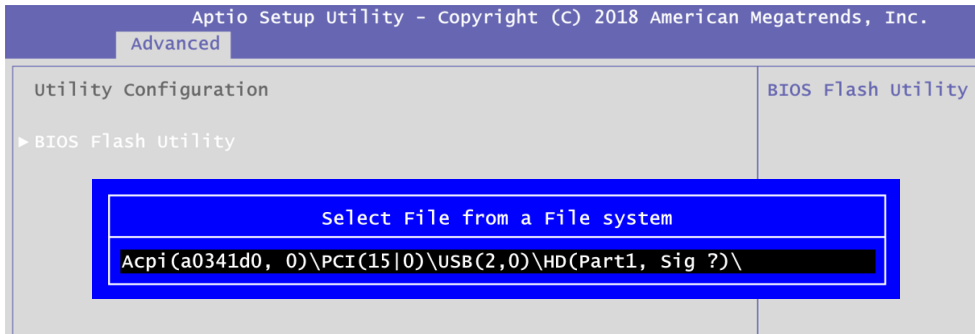

- Select the USB drive containing BIOS ROM file you want to update using the <↑> or <↓> key. Then press <Enter> to get into "Axiomtek" folder.

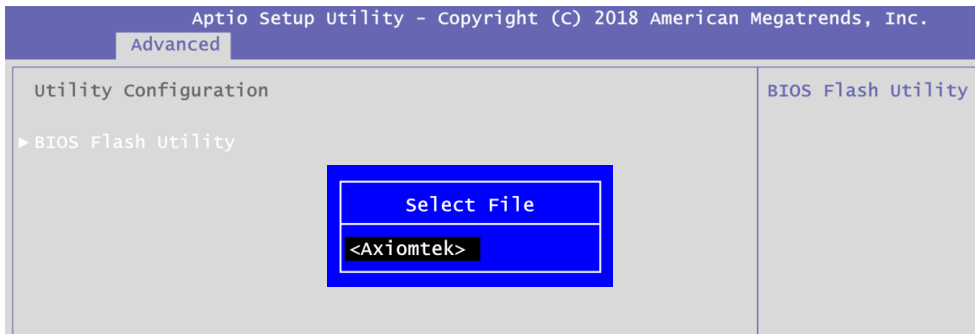

- Now you can see the BIOS ROM file on the screen, press <Enter> to select.

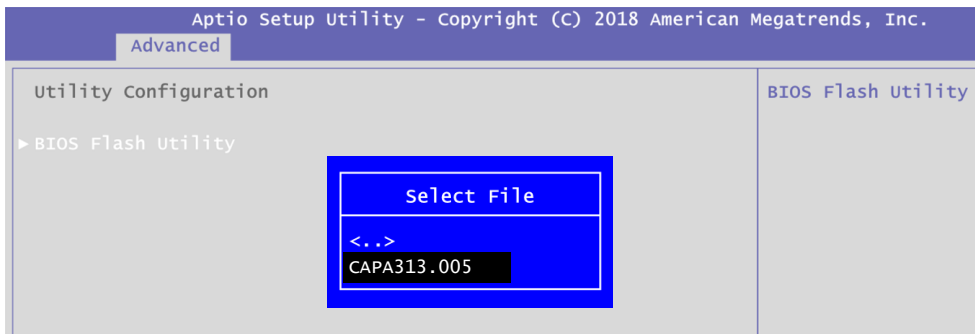

- Select Start to flash system BIOS option to begin updating procedure.

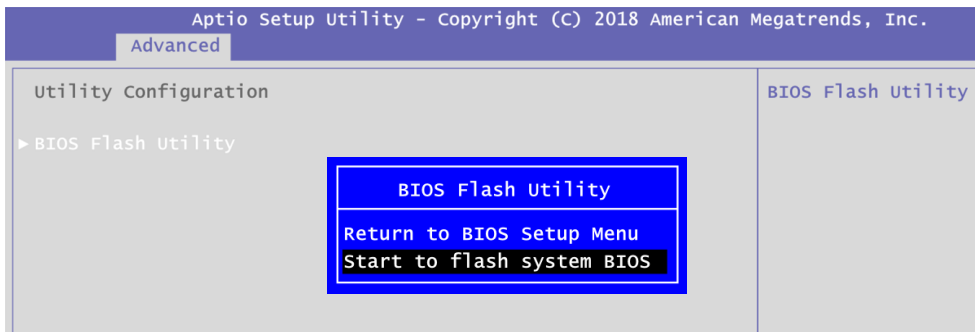

9. Please wait while BIOS completes the entire flash update process: erase data, write new data and verify data.

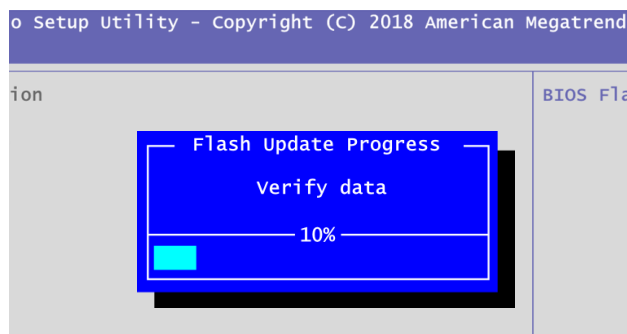
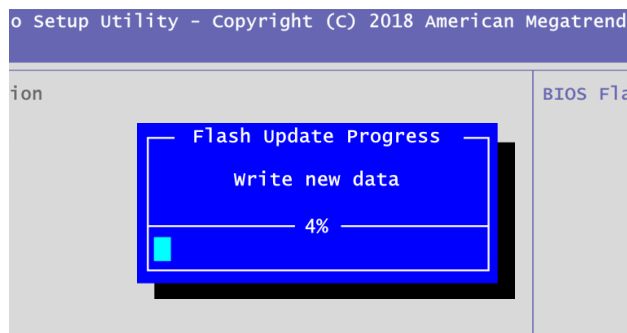
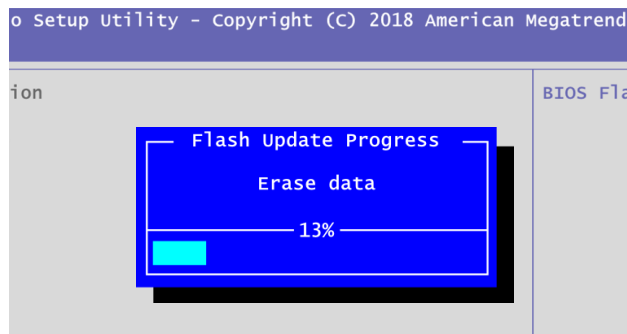

10. When you see the following figure, press <Enter> to finish the update process. After that the system will shut down and restart immediately.

