

USER'S MANUAL

eBOX626-311-FL

Embedded System

User's Manual



www.axiomtek.com

Disclaimers

This manual has been carefully checked and believed to contain accurate information. Axiomtek Co., Ltd. assumes no responsibility for any infringements of patents or any third party's rights, or any liability arising from such uses.

Axiomtek does not warrant or assume any legal liability or responsibility for the accuracy, completeness or usefulness of any information in this document. Axiomtek does not make any commitment to update any information in this manual.

Axiomtek reserves the right to change or revise this document and/or product at any time without notice.

No part of this document may be reproduced, stored in a retrieval system, or transmitted in any forms or by any means, electronic, mechanical, photocopying, recording, among others, without prior written permissions of Axiomtek Co., Ltd.

©Copyright 2020 Axiomtek Co., Ltd.

All Rights Reserved

June 2020, Version A1

Printed in Taiwan

Safety Precautions

Before getting started, please read the following important safety precautions.

1. The eBOX626-311-FL does not come equipped with an operating system. An operating system must be loaded first before installing any software into the computer.
2. Be sure to ground yourself to prevent static charge when installing the internal components. Use a grounding wrist strap and place all electronic components in any static-shielded devices. Most electronic components are sensitive to static electrical charge.
3. Disconnect the power cord from the eBOX626-311-FL before making any installation. Be sure both the system and the external devices are turned OFF. Sudden surge of power could ruin sensitive components. Make sure the eBOX626-311-FL is properly grounded.
4. Make sure the voltage of the power source is correct before connecting the equipment to the power outlet.
5. Turn OFF the system power before cleaning. Clean the system using a cloth only. Do not spray any liquid cleaner directly onto the screen.
6. Do not leave this equipment in an uncontrolled environment where the storage temperature is below -40°C or above 80°C . It may damage the equipment.
7. Do not open the system's back cover. If opening the cover for maintenance is a must, only a trained technician is allowed to do so. Integrated circuits on computer boards are sensitive to static electricity. To avoid damaging chips from electrostatic discharge, observe the following precautions:
 - Before handling a board or integrated circuit, touch an unpainted portion of the system unit chassis for a few seconds. This will help to discharge any static electricity on your body.
 - When handling boards and components, wear a wrist-grounding strap, available from most electronic component stores.
8. Note!! Caution with touch! eBOX626-311-FL will be hot when it's on.

Classification

1. Degree of protection against electric shock : not classified
2. Degree of protection against the ingress of water : IP40
3. Equipment not suitable for use in the presence of a flammable anesthetic mixture with air or with oxygen or nitrous oxide.
4. Mode of operation : Continuous



Note: *All of I/O connectors should be connected with corresponding cables when the system is operating with IP40 rated definition. If some of I/O ports are not be used or connected during operation, users must to connect optional I/O covers to meet IP40 standard.*

General Cleaning Tips

You may need the following precautions before you begin to clean the computer. When you clean any single part or component for the computer, please read and understand the details below fully.

When you need to clean the device, please rub it with a piece of dry cloth.

1. Be cautious of the tiny removable components when you use a vacuum cleaner to absorb the dirt on the floor.
2. Turn the system off before you start to clean up the component or computer.
3. Never drop the components inside the computer or get circuit board damp or wet.
4. Be cautious of all kinds of cleaning solvents or chemicals when you use it for the sake of cleaning. Some individuals may be allergic to the ingredients.
5. Try not to put any food, drink or cigarette around the computer.

Cleaning Tools:

Although many companies have created products to help improve the process of cleaning your computer and peripherals users can also use household items to clean their computers and peripherals. Below is a listing of items you may need or want to use while cleaning your computer or computer peripherals.

Keep in mind that some components in your computer may only be able to be cleaned using a product designed for cleaning that component, if this is the case it will be mentioned in the cleaning.

- Cloth: A piece of cloth is the best tool to use when rubbing up a component. Although paper towels or tissues can be used on most hardware as well, we still recommend you to rub it with a piece of cloth.
- Water or rubbing alcohol: You may moisten a piece of cloth a bit with some water or rubbing alcohol and rub it on the computer. Unknown solvents may be harmful to the plastics parts.
- Vacuum cleaner: Absorb the dust, dirt, hair, cigarette particles, and other particles out of a computer can be one of the best methods of cleaning a computer. Over time these items can restrict the airflow in a computer and cause circuitry to corrode.
- Cotton swabs: Cotton swabs moistened with rubbing alcohol or water are excellent tools for wiping hard to reach areas in your keyboard, mouse, and other locations.
- Foam swabs: Whenever possible it is better to use lint free swabs such as foam swabs.



Note: *We strongly recommended that you should shut down the system before you start to clean any single components.*

Please follow the steps below:

1. Close all application programs
2. Close operating software
3. Turn off power switch
4. Remove all device
5. Pull out power cable

Scrap Computer Recycling

If the computer equipment's needs the maintenance or are beyond repair, we strongly recommended that you should inform your Axiomtek distributor as soon as possible for the suitable solution. For the computers that are no longer useful or no longer working well, please contact your Axiomtek distributor for recycling and we will make the proper arrangement.

Trademarks Acknowledgments

Axiomtek is a trademark of Axiomtek Co., Ltd.

IBM, PC/AT, VGA, HDMI are trademarks of International Business Machines Corporation.

Intel[®], Pentium[®] and Celeron[®] are registered trademarks of Intel Corporation.

MS-DOS, Microsoft C and QuickBasic are trademarks of Microsoft Corporation.

Windows 10, Windows 8.1, Windows XPE, Windows WinCE embedded, Linux, MS-DOS, Microsoft C and

Other brand names and trademarks are the properties and registered brands of their respective owners.

Table of Contents

Disclaimers.....	ii
Safety Precautions.....	iii
Classification.....	iv
General Cleaning Tips	v
Scrap Computer Recycling.....	vi
SECTION 1 INTRODUCTION.....	1
1.1 General Description	1
1.2 System Specification	2
1.2.1 CPU.....	2
1.2.2 I/O System	2
1.2.3 System specifications.....	4
1.3 Dimensions	5
1.3.1 System Dimension.....	5
1.3.2 Wall mount Bracket Dimension (Screw: M3x6L 4pcs).....	6
1.3.3 Din-rail mount Bracket Dimension.....	7
1.3.4 VESA mount Bracket Dimension (Screw: M3x6L 4pcs)	8
1.4 I/O Outlets.....	9
1.5 Packing List.....	11
1.6 Model List.....	11
SECTION 2 HARDWARE INSTALLATION	13
2.1 Installing of the Memory module	13
2.2 Installing of the PCI Express Mini Card.....	16
2.3 Installing of the 2.5" SATA Device	18
SECTION 3 JUMPER SETTING & CONNECTOR	23
3.1 CAPA311 layout	23
3.2 Jumper Setting Summary.....	25
3.2.1 Restore BIOS Optimal Defaults (JP3)	26
3.2.2 COM3 Data/Power Selection (JP4).....	26
3.2.3 AT/ATX Quick Switch (SSW1).....	26
3.3 Connectors	27
3.3.1 VGA Connector (CN23)	28
3.3.2 COM Serial Port Connector (CN17, CN18, CN4)	28
3.3.3 USB 2.0 Port (CN7)	29
3.3.4 SATA Connector (CN15)	29
3.3.5 HDMI Connector (CN19).....	30
3.3.6 USB 3.0 Ports (CN20 and CN21).....	31
3.3.7 Ethernet Ports (LAN1 and LAN2)	32
3.3.8 Full-size PCI-Express Mini Card Connector (SCN1).....	33
3.3.9 SIM Card Socket (SCN2)	34
3.3.10 Full-size PCI-Express Mini Card or mSATA Connector (SCN3).....	35
3.3.11 Power and HDD LED Indicator	36
3.3.12 System Power Switch	36
3.3.13 DC-in Phoenix Power Connector	36
SECTION 4 BIOS SETUP UTILITY	37
4.1 Starting.....	37
4.2 Navigation Keys	37
4.3 Main Menu	38
4.4 Advanced Menu	39

4.5	Chipset Menu	51
4.6	Security Menu	54
4.7	Boot Menu	55
4.8	Save & Exit Menu	56
APPENDIX A WATCHDOG TIMER		59
A.1	About Watchdog Timer.....	59
A.2	How to Use Watchdog Timer.....	59

SECTION 1 INTRODUCTION



This chapter contains general information and detailed specifications of the eBOX626-311-FL. The Chapter 1 includes the following sections:

- General Description
- System Specification
- Dimensions
- I/O Outlets
- Packing List
- Model List

1.1 General Description

The eBOX626-311-FL is an embedded system equipped with Intel® Atom® x5-E3940 SoC onboard which features fan-less design with full feature I/O supported for more connectivity. The system also supports 204-pin DDR3L-1866 SO-DIMM slot for up to 8GB of memory. In addition, for enhanced security, the eBOX626-311-FL supports TPM 1.2. It also supports Axiomtek's exclusive AXView Industrial IoT software for smart device monitoring and management. It is well-suited for multimedia applications, security surveillance and smart factory automation.

Features

- Intel® Atom® x5-E3940 SoC onboard
- Maximum to 8GB DDR3L-1866 memory
- VGA/HDMI for dual display
- Supports 4 USB 3.0 & 2 USB 2.0 ports
- Supports 2 RS-232/422/485 and 1 RS-232
- Supports dual 10/100/1000Mbps Ethernet ports
- One 2.5" SATA HDD/SSD drive bay (Max. up 9.5 mm height)
- Two Full-Size Mini PCI Express Mini Card. Support 1 w/mSATA.
- One SIM slot
- AXView 3.0 and TPM 1.2 supported
- Wide temperature: -40°C~60°C supported (with W.T. SSD & Memory)
- 9 ~ 36VDC phoenix type power input.

- **Reliable and Stable Design**
The eBOX626-311-FL adopts the advanced cooling system and supporting wide operating temperature with fan-less design, which makes it especially suitable in harsh environments, best for industrial automation, digital signage and gaming application.
- **Flexible Connectivity**
It comes with rich I/O interfaces including one RS-232 ports, two RS-232/422/485 ports, four USB 3.0 ports, two USB 2.0 ports, two GbE LAN ports.
- **Embedded O.S. Supported**
The eBOX626-311-FL supports Windows® 10 IoT, Linux and AXView 3.0.
- **Various Storage**
Supported In terms of storage, the eBOX626-311-FL supports one 2.5" SATA storage drive bay and one mSATA device.

1.2 System Specification

1.2.1 CPU

- **CPU**
 - Intel® Atom® processor x5-E3940 Quad Core, up to 1.8 GHz with turbo boost.
- **Chipset**
 - SoC integrated
- **System Memory**
 - One 204-pin DDR3L-1866 SO-DIMM socket, up to 8 GB at the maximum.
- **BIOS**
 - American Megatrends Inc. UEFI (Unified Extensible Firmware Interface) BIOS
- **TPM**
 - TPM 1.2

1.2.2 I/O System

- **Display**
 - 1 x Lockable HDMI (HDMI 1.4b up to 3840 x 2160@30Hz)
 - 1 x VGA (1920 x 1200)
- **Ethernet**
 - 2 x 10/100/1000 Ethernet ports (i211-AT)
- **USB Ports**
 - 2 x USB 2.0
 - 4 x USB 3.0

- **Serial Ports**
 - 1 x RS-232 (9-pin D-Sub male connector)
 - 2 x RS-232-422-485 (9-pin D-Sub male connector)
- **Audio**
 - 1 x Mic-in/Line out
- **Expansion slots**
 - 1 x full-size PCI Express Mini Card Slots (USB + PCI Express + mSATA signal)
 - 1 x full-size PCI Express Mini Card Slots (USB + PCI Express signal)
 - 1 x SIM slot
- **Storage**
 - 1 x 2.5" SATA HDD/SSD drive bay
 - 1 x mSATA (enabled in BIOS setting)
- **Indicator**
 - 1 x Green LED as indicator for PWR status
 - 1 x Yellow LED as indicator for HDD active
- **Switch**
 - 1 x ATX PWR switch
 - 1 x ATX/AT Quick switch
- **Antenna**
 - 4 x SMA type connector openings for antenna

1.2.3 System specifications

- **Watchdog Timer**
 - 65536 levels, 1 to 65535 sec.
- **Power Supply**
 - 9~36VDC Wide range power input
- **Operation Temperature**
 - Turbo Mode **(Default)**:
-40°C ~ +60°C (-40°F ~ +140°F) (with W.T. SSD/DRAM)
- **Storage Temperature**
 - -40°C ~ 80°C (-40 °F ~ 176°F)
- **Humidity**
 - 10% ~ 95% (non-condensation)
- **Vibration Endurance**
 - IEC 60068-2-27 (with SSD: 3Grms STD, random, 5 to 500 Hz, 1 hr/axis)
- **Shock Endurance**
 - IEC 60068-2-64 (with SSD: 50G, half sine, 11 ms duration)
- **Weight**
 - 1.2 kg (2.65 lb)/1.6 kg (3.53 lb)
- **Dimensions**
 - 200mm (7.87") (W) x 120mm (4.72") (D) x 46mm(1.81") (H)



NOTE: All specifications and images are subject to change without notice.

1.3 Dimensions

The following diagrams show you dimensions and outlines of the eBOX626-311-FL.

1.3.1 System Dimension

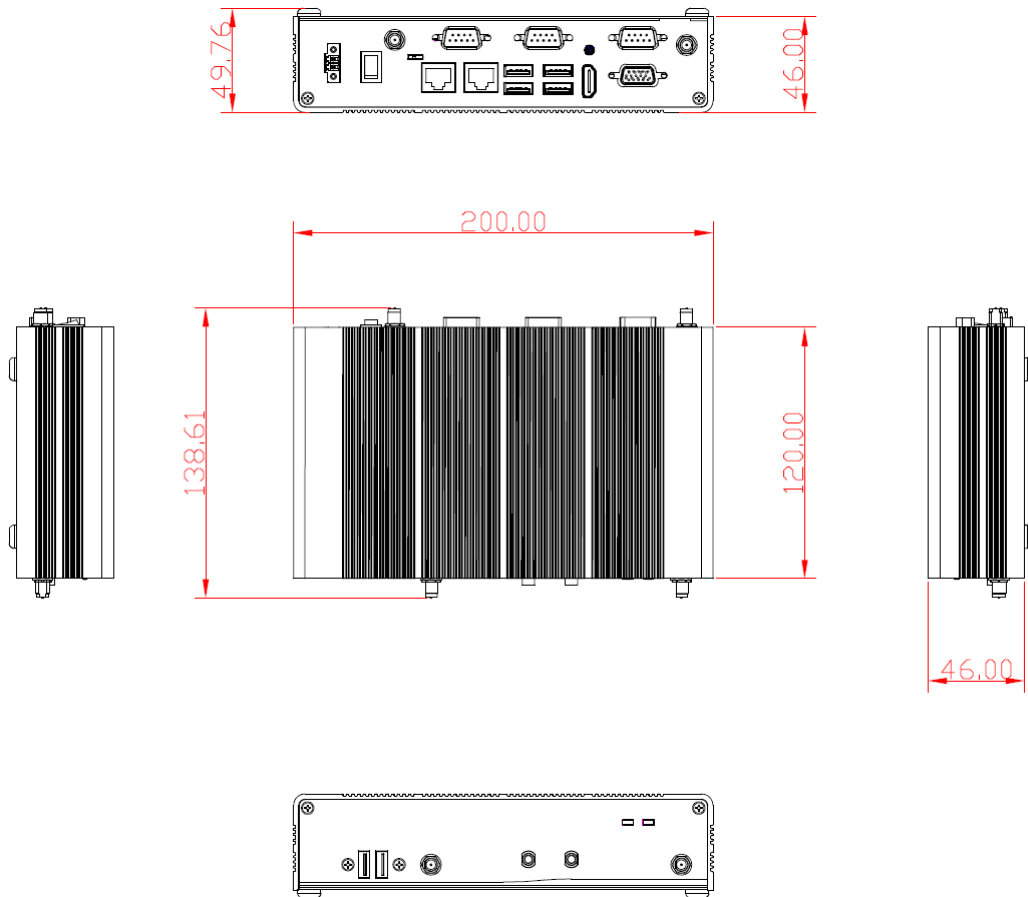

1.3.2 Wall mount Bracket Dimension (Screw: M3x6L 4pcs)

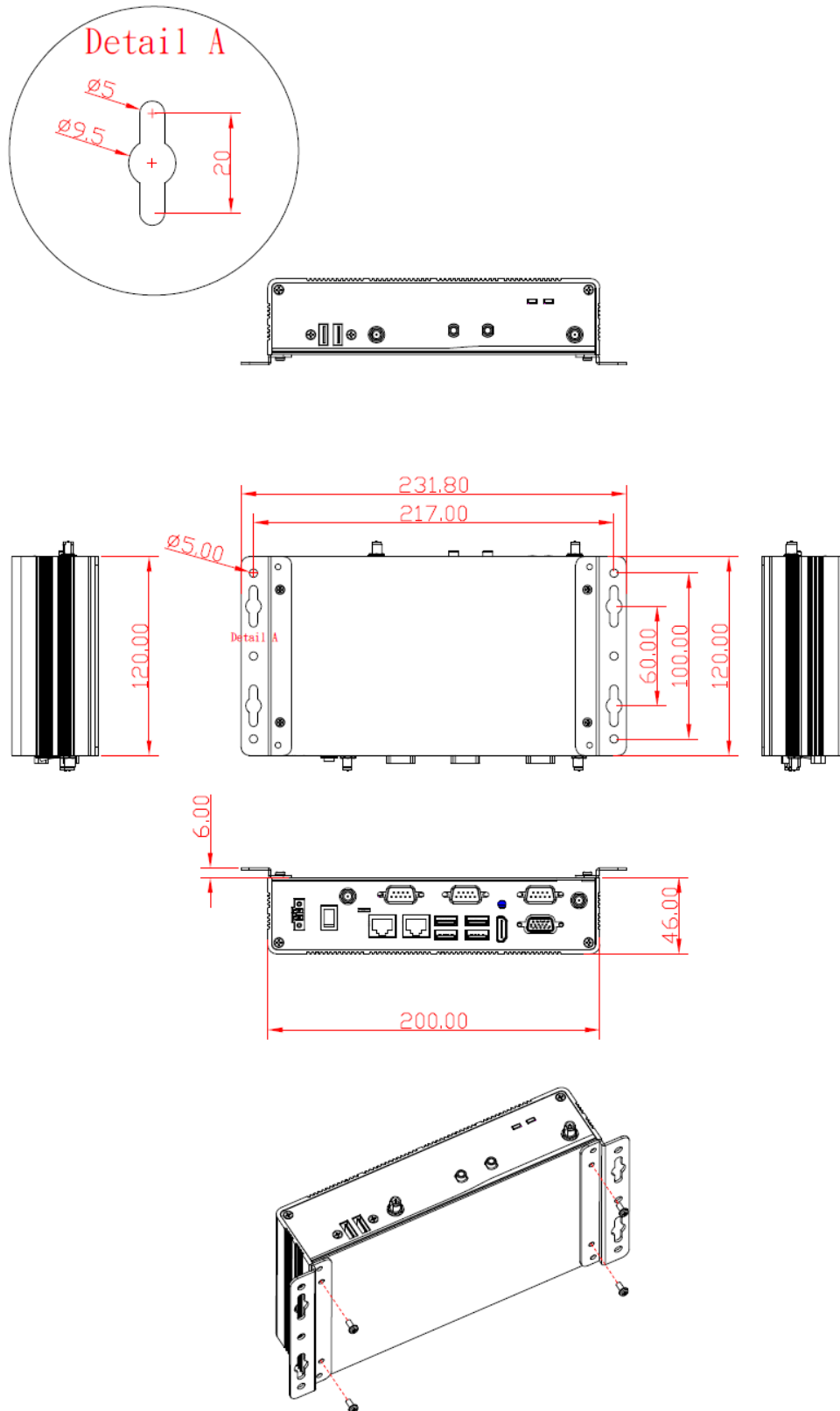

1.3.3 Din-rail mount Bracket Dimension (Screw: M3x6L 4pcs & M3x4L 2pcs)

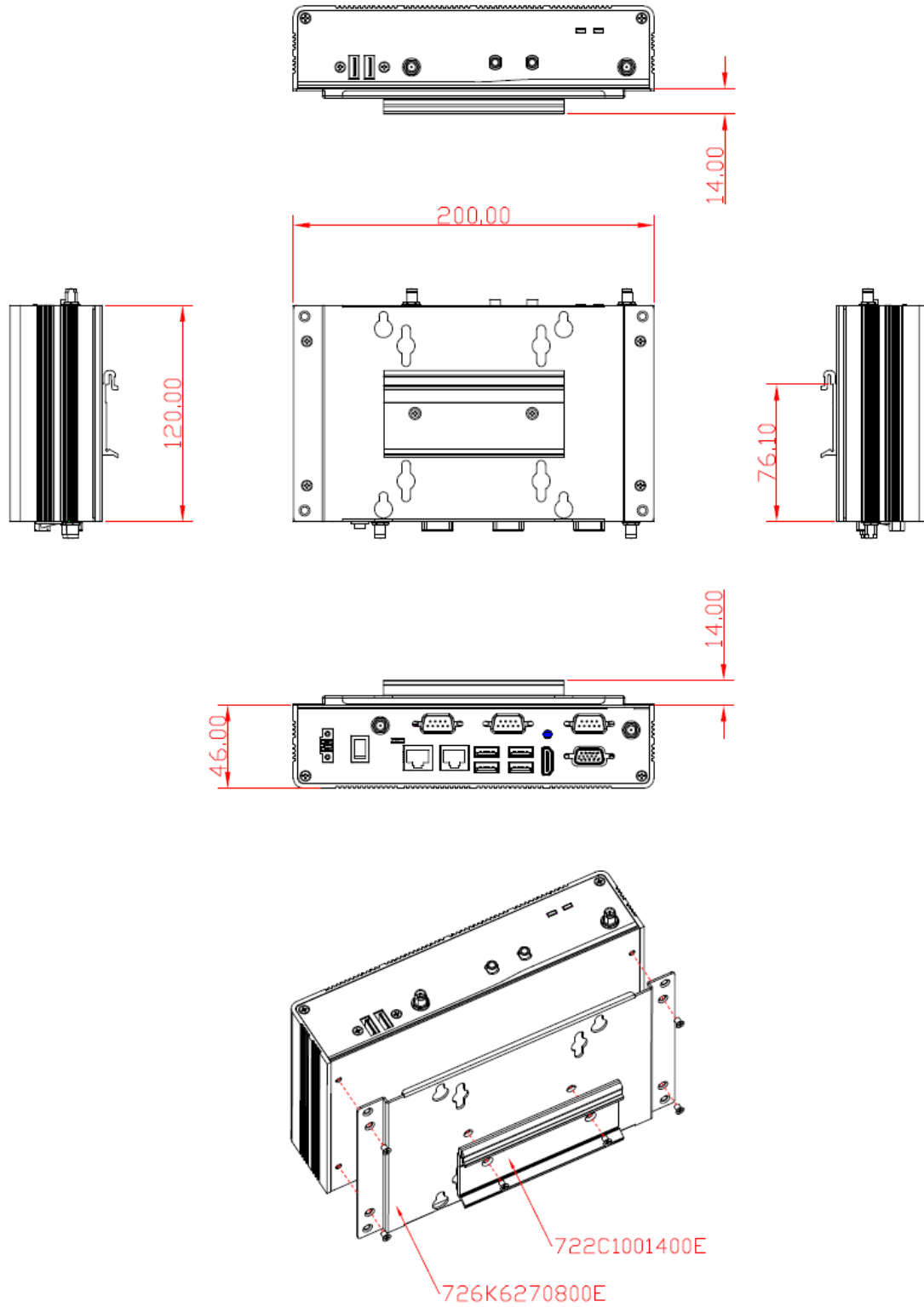

1.3.4 VESA mount Bracket Dimension (Screw: M3x6L 4pcs)

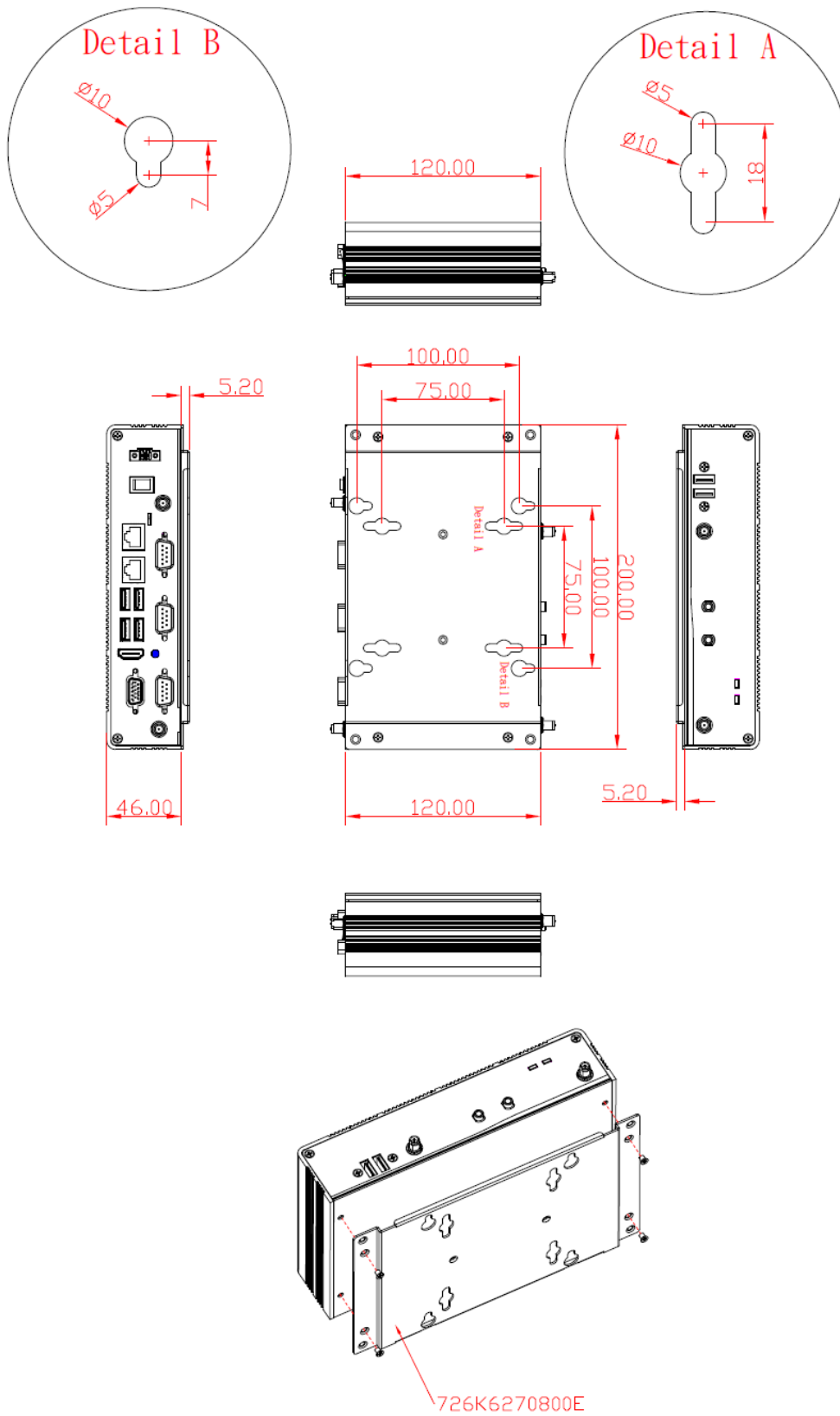

1.4 I/O Outlets

The following figures show you I/O outlets on front view of the eBOX626-311-FL.

- **Front View**



- **Front View drawing**

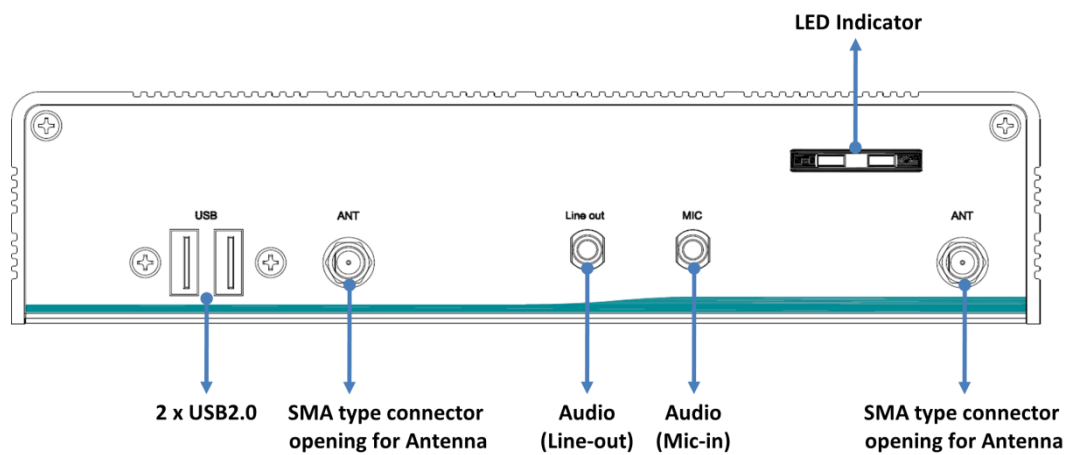

- **Rear View**



- **Rear View drawing**

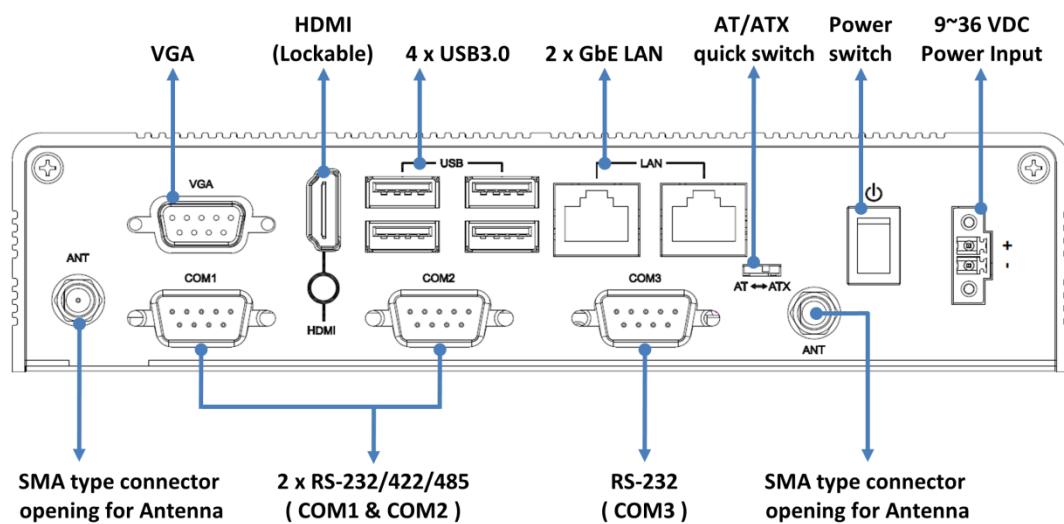

1.5 Packing List

The package bundled with your eBOX626-311-FL should contain the following items:

- eBOX626-311-FL System Unit x 1
- 2-pin Terminal Block Connector x 1
- Screws Pack x 1
- Pre-installed Foot pad x 4
- DRAM Thermal Pad x 1
- HDMI Cable Locking Clip (optional)
- power adapter (optional)
- Power cord (optional)

If you cannot find this package or any items are missing, please contact Axiomtek distributors immediately.

1.6 Model List

eBOX626-311-FL	Fanless Embedded System with Intel® Atom® x5-E3940 1.8 GHz, HDMI, VGA, 2 GbE LANs, 6 USB, 3 COM and 9~36 VDC (without power adapter and power cord)
----------------	---

This page is intentionally left blank.

SECTION 2 HARDWARE INSTALLATION

The eBOX626-311-FL is convenient for your various hardware configurations, such as Memory Module, HDD (Hard Disk Drive), SSD (Solid State Drive) and mini card slot. The chapter 2 will show you how to install the hardware.

2.1 Installing of the Memory module

- Step 1** Turn off the system, and unplug the power cord.
- Step 2** Turn the system upside down to locate screws at the side of the system, and then loosen one screw and four foot pads.

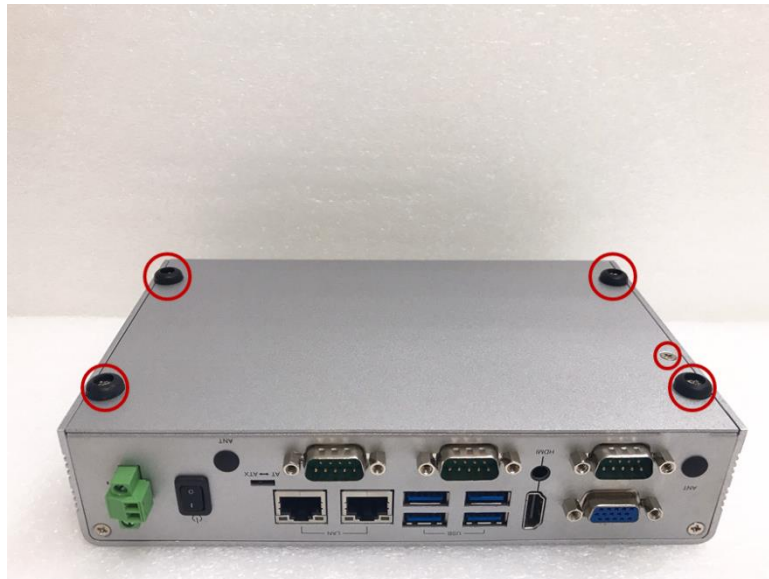

- Step 3** Remove the bottom cover.

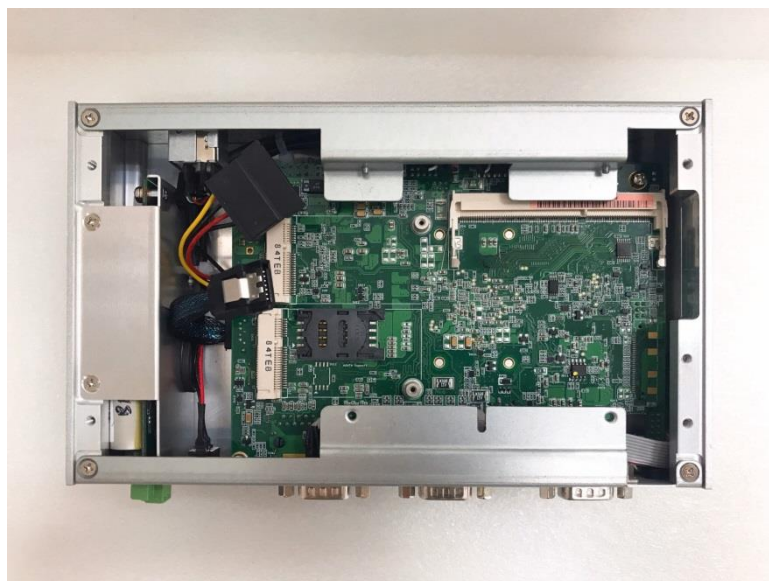

Step 4 Locate the DDR3L SO-DIMM slot, and apply the thermal pad on the DDR3L SO-DIMM slot.

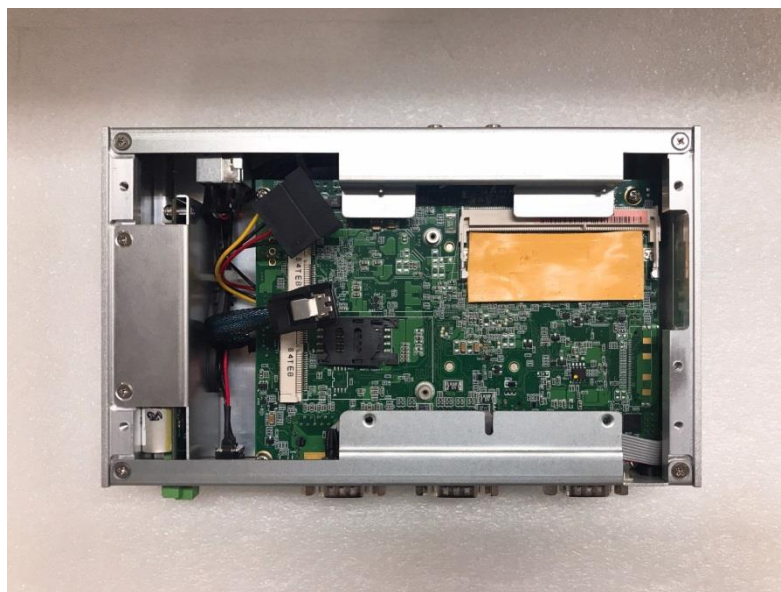
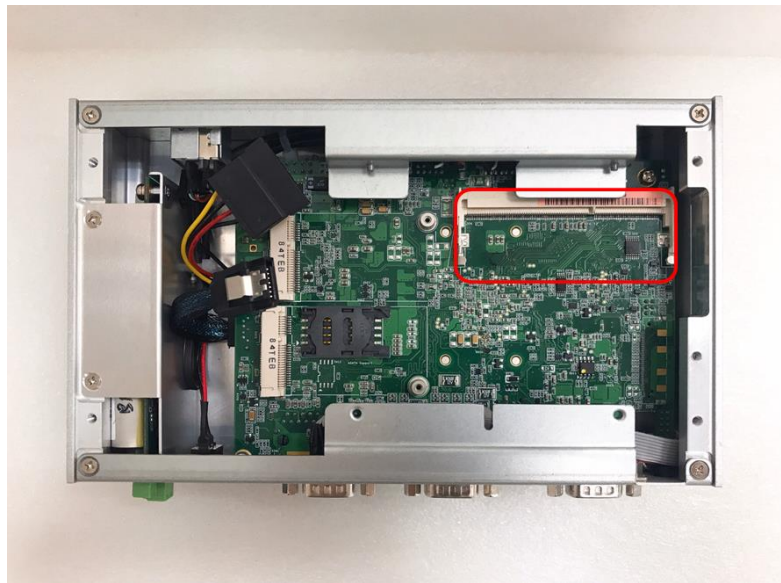

Step 5 Holding the DDR3L SO-DIMM at a 30 degree angle up from horizontal; slowly insert the golden fingers into the DDR3L SO-DIMM slot until it is fully inserted in.

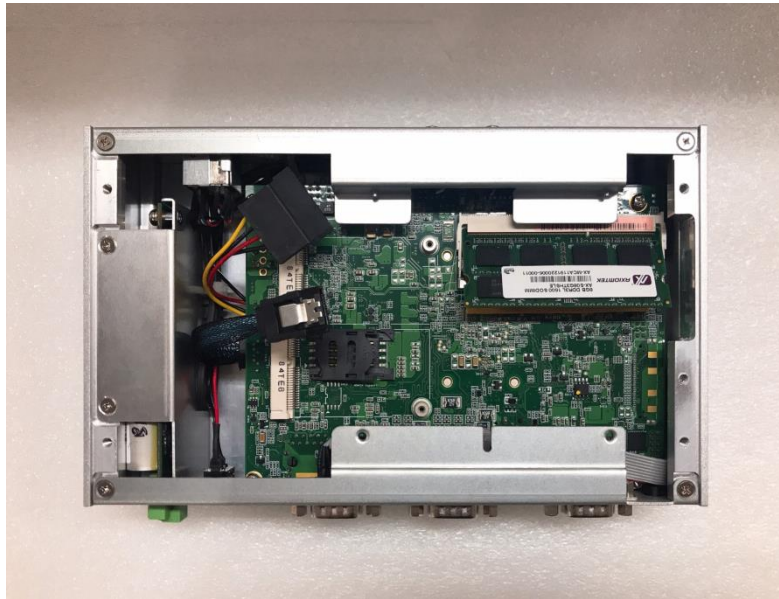

Step 6 Press it down gently, until it is firmly seated by locking two latches on the sides.

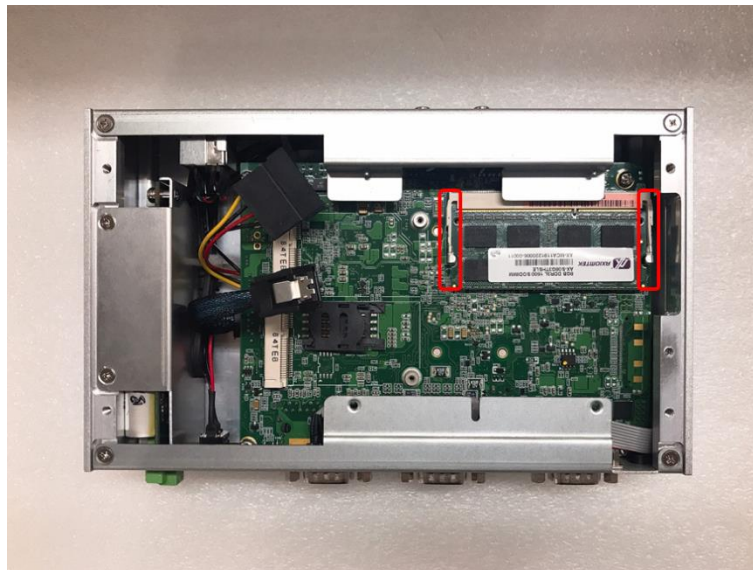

Step 7 Put the bottom cover back and fasten all screws.

2.2 Installing of the PCI Express Mini Card

- Step 1** Turn off the system, and unplug the power cord.
- Step 2** Turn the system upside down to locate screws at the side of the system, and then loosen one screw and four foot pads.

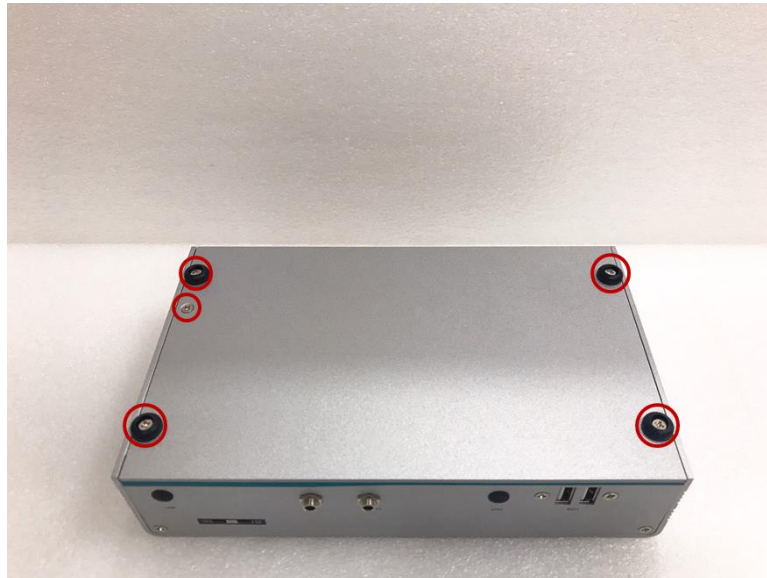

- Step 3** Remove the bottom cover.

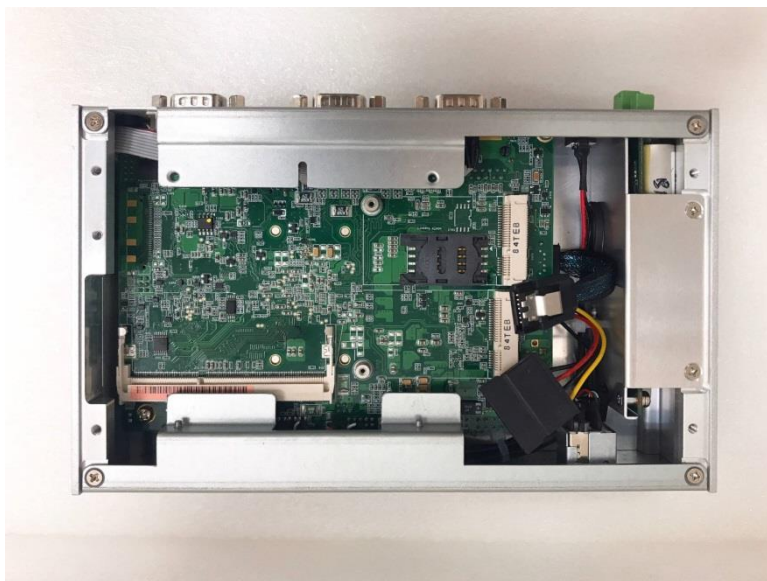

Step 4 Locate PCI Express mini card slot on the board.

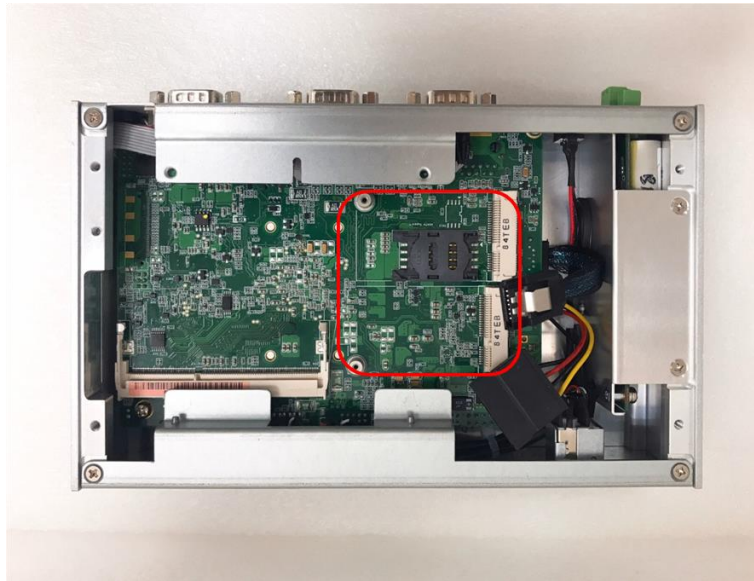

Step 5 Holding the PCI Express mini card at a 45 degree angle up from horizontal; slowly insert the golden fingers into the PCI Express slot until it is fully inserted in and fasten screws and connect the cable to antenna.



Step 6 Put the bottom cover back and fasten all screws.

Step 4 Assemble the HDD/SSD with the bracket by two M3*4L screws.

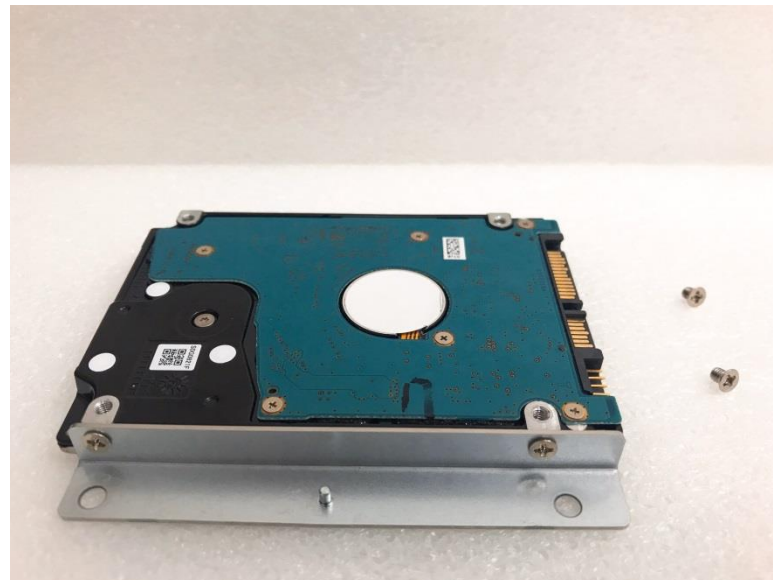
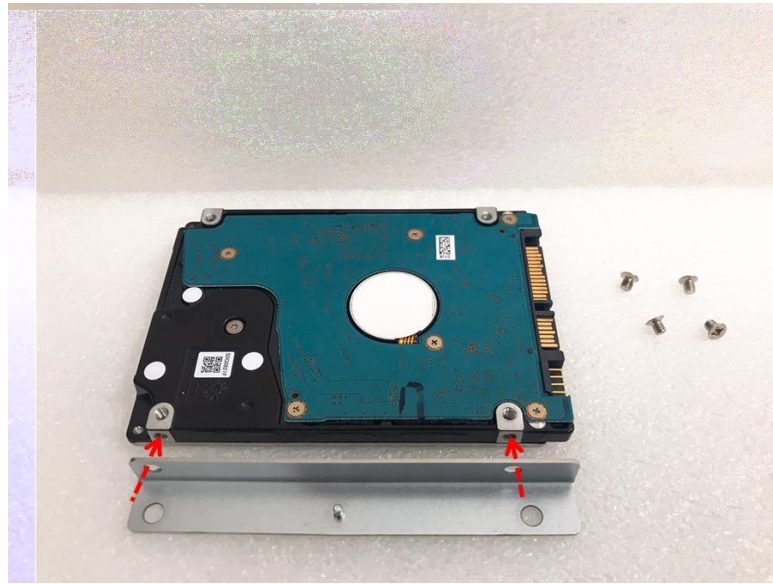

Step 5 Locate the HDD/SSD tray location, and follow the three locating pins to assemble the HDD/SSD.

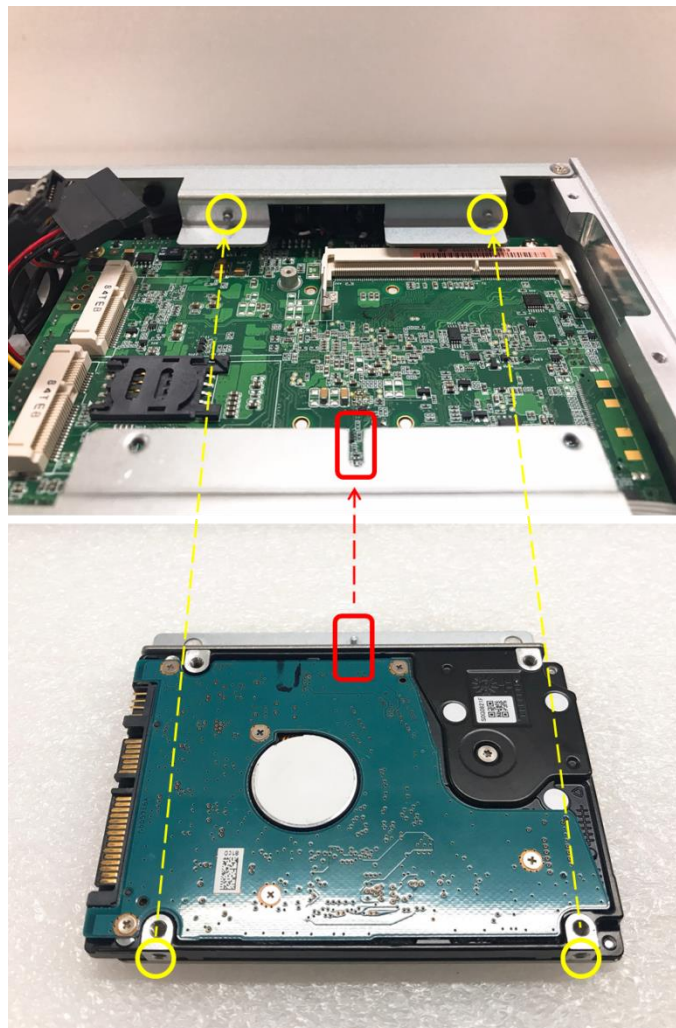
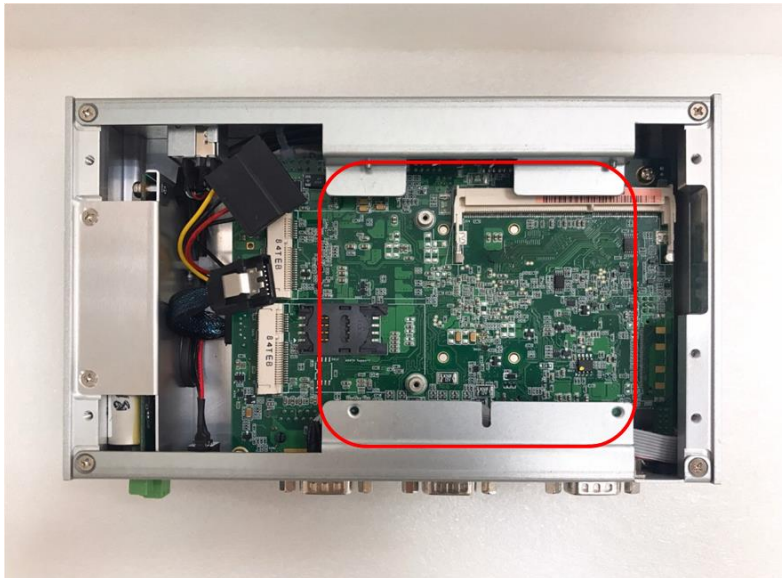

Step 6 Connect the power cable and SATA cable with HDD/SSD, and affix it with two M3*4L screws.

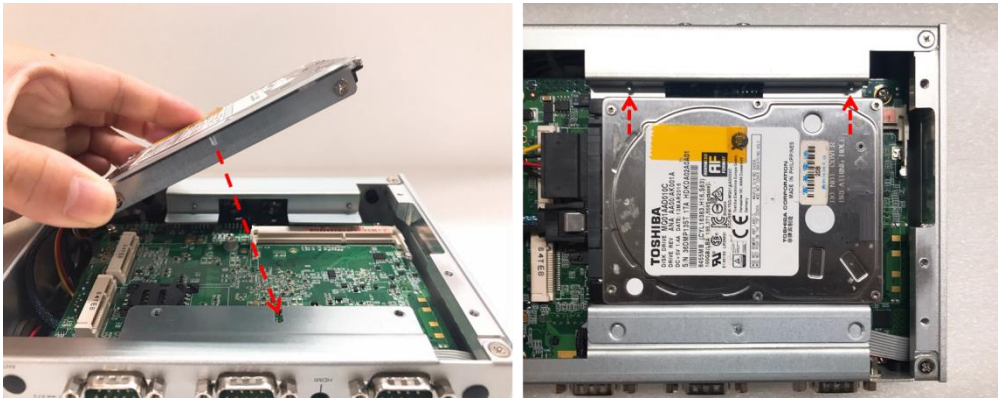

Note: Please notice the direction of connector and locating pins for HDD/SSD.

Step 7 Put the bottom cover back and fasten all screws.

This page is intentionally left blank.

SECTION 3 JUMPER SETTING & CONNECTOR

Proper jumper settings configure the **eBOX626-311-FL** to meet your application purpose. We are herewith listing a summary table of all jumpers and default settings for onboard devices, respectively.

3.1 CAPA311 layout

Top View

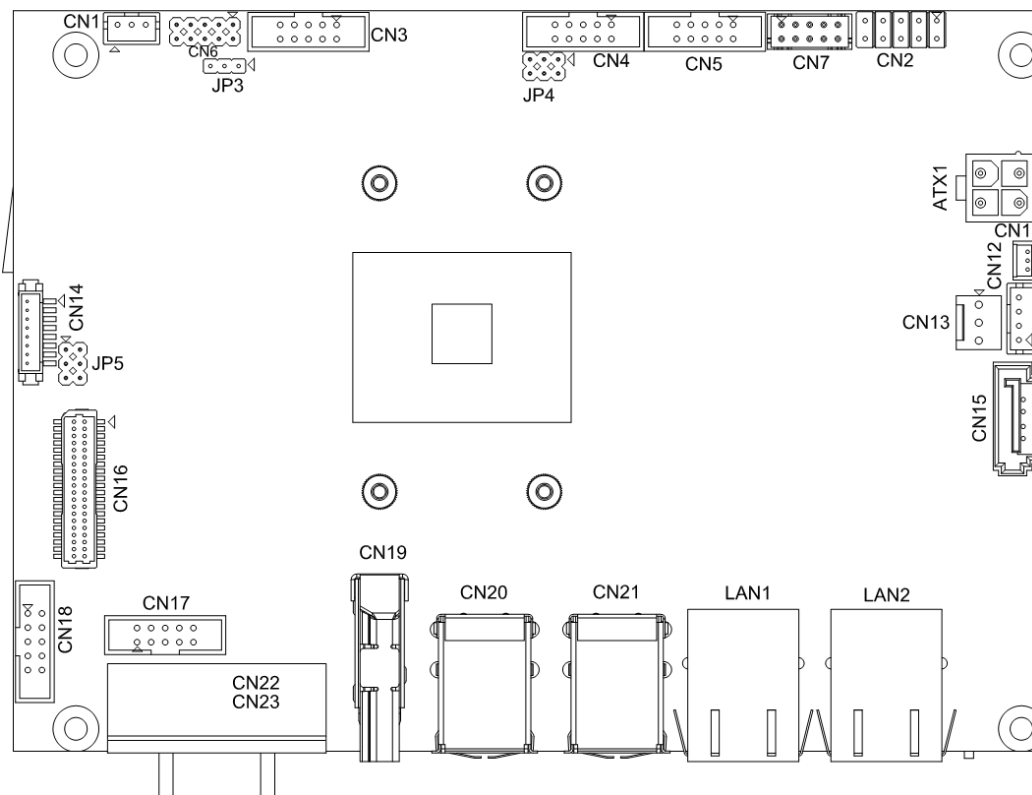

Side View



Note: We strongly recommended that you should not modify any unmentioned jumper setting without Axiomtek FAE's instruction. Any modification without instruction might cause system to become damage.

Bottom View

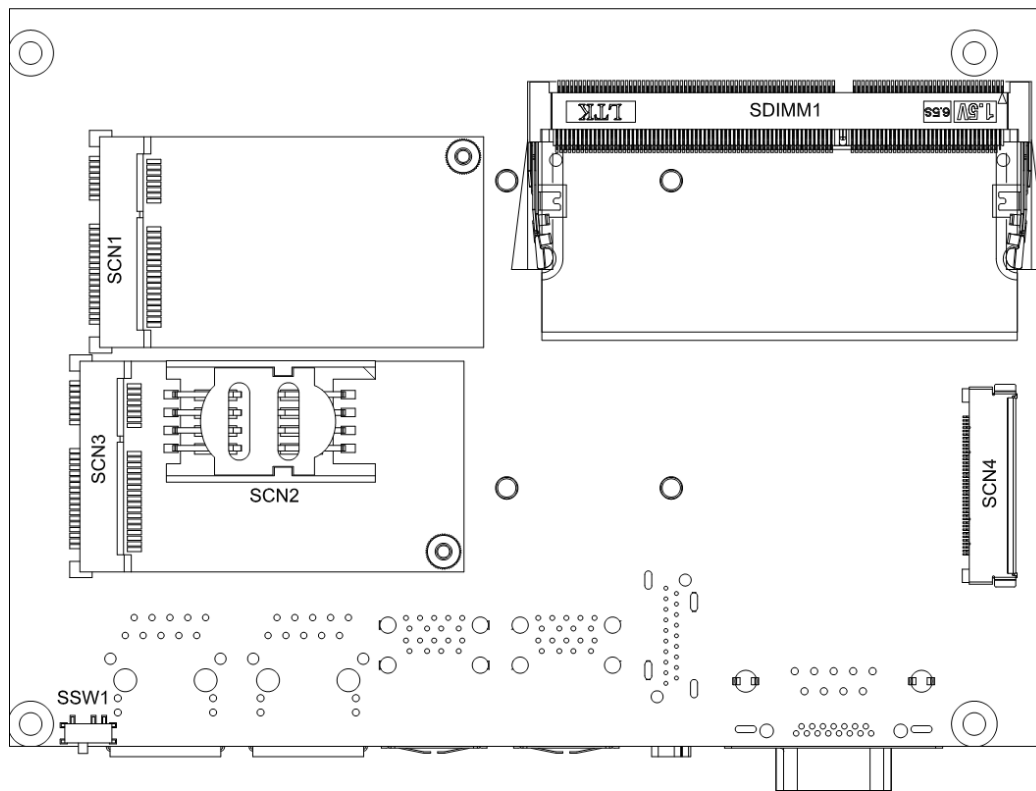

3.2 Jumper Setting Summary

Proper jumper settings configure the eBOX626-311-FL to meet your application purpose. We are herewith listing a summary table of all jumpers and default settings for onboard devices, respectively.

Jumper and Switch	Description	Setting
JP3	Restore BIOS Optimal Defaults Default: Normal Operation	1-2 Close
JP4	COM3 Data/Power Selection Default: RS-232 Data	CN4 Pin 1: DCD 3-5 Close
		CN4 Pin 8: RI 4-6 Close
SSW1	Auto Power On Default: Disable	ATX



Note: How to setup Jumpers

The illustration shows how to set up jumpers. When the jumper cap is placed on pins, the jumper is "close", if not, that means the jumper is "open".



[Open]



[Closed]



[Pin1-2 Closed]

3.2.1 Restore BIOS Optimal Defaults (JP3)

This is a 1x3-pin (pitch=2.0mm) jumper. Put jumper clip to pin 2-3 for a few seconds then move it back to pin 1-2. Doing this procedure can restore BIOS optimal defaults.

Function	Setting
Normal (Default)	1-2 close
Restore BIOS optimal defaults	2-3 close



3.2.2 COM3 Data/Power Selection (JP4)

This is a 2x3-pin (pitch=2.0mm) jumper. The COM3 port has +5V level power capability on DCD and +12V level on RI by setting jumper JP4.

Function	Setting
Power: Set CN4 pin 1 to +5V level	1-3 close
Data: Set CN4 pin 1 to DCD (Default)	3-5 close
Power: Set CN4 pin 8 to +12V level	2-4 close
Data: Set CN4 pin 8 to RI (Default)	4-6 close

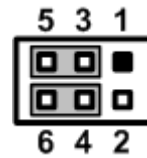

3.2.3 AT/ATX Quick Switch (SSW1)

If SSW1 is enabled for power input, the system will be automatically power on without pressing soft power button. If SSW1 is disabled for power input, it is necessary to manually press soft power button to power on the system.

Function	Setting
Disable auto power on (Default)	ATX
Enable auto power on	AT



3.3 Connectors

Connectors connect the board with other parts of the system. Loose or improper connection might cause problems. Make sure all connectors are properly and firmly connected. Here is a summary table shows you all connectors and button on the **eBOX626-311-FL** Series.

Connectors / Buttons	Location	Section
VGA Connector	CN23	3.3.1
COM Serial Port Connector (COM1~3)	CN17, CN18, CN4	3.3.2
USB 2.0 Wafer Port	CN7	3.3.3
SATA Connector	CN15	3.3.4
HDMI Connector	CN19	3.3.5
USB 3.0 Port	CN20 and CN21	3.3.6
Ethernet Port 1 and 2	LAN1and LAN2	3.3.7
Full-size PCI-Express Mini Card Connector	SCN1	3.3.8
SIM Card Socket	SCN2	3.3.9
Full-size PCI-Express Mini Card or mSATA Connector	SCN3	3.3.10
Power and HDD LED Indicator		3.3.11
System Power Switch		3.3.12
DC-in Phoenix Power Connector		3.3.13

3.3.1 VGA Connector (CN23)

This is a standard 15-pin D-Sub connector. It is commonly used for VGA display. This VGA interface configuration can be configured via software utility.

Pin	Signal	Pin	Signal
1	RED	2	GREEN
3	BLUE	4	N.C
5	GND	6	GND
7	GND	8	GND
9	CRT_VCC	10	GND
11	N.C	12	DDC_DATA
13	Hsync	14	Vsync
15	DDC_CLK		

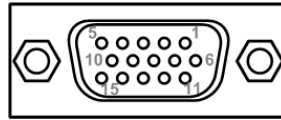

3.3.2 COM Serial Port Connector (CN17, CN18, CN4)

The system has four serial ports. COM1 and COM2 are RS-232/422/485 ports; COM3 is RS-232 ports. Please refer to Chapter 4 for the detail of BIOS setting.

COM1 and COM2 (CN17 and CN18):

Pin	RS-232	RS-422	RS-485
1	DCD, Data Carrier Detect	TX-	Data-
2	RXD, Receive Data	TX+	Data+
3	TXD, Transmit Data	RX+	No use
4	DTR, Data Terminal Ready	RX-	No use
5	GND, Ground	No use	No use
6	DSR, Data Set Ready	No use	No use
7	RTS, Request To Send	No use	No use
8	CTS, Clear To Send	No use	No use
9	RI, Ring Indicator	No use	No use

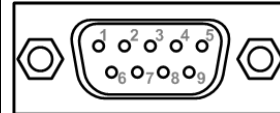

COM3 (CN4):

COM2	Signal
1	Data Carrier Detect (DCD)
2	Receive Data (RXD)
3	Transmit Data (TXD)
4	Data Terminal Ready (DTR)
5	Ground (GND)
6	Data Set Ready (DSR)
7	Request to Send (RTS)
8	Clear to Send (CTS)
9	Ring Indicator (RI)

3.3.3 USB 2.0 Port (CN7)

The CN7 is a Universal Serial Bus (compliant with USB 2.0 (480Mbps)) connector on the rear I/O. It is commonly used for installing USB peripherals such as keyboard, mouse, scanner, etc.

Pin	Signal	Pin	Signal
1	USB VCC (+5V_SBY)	5	USB VCC (+5V_SBY)
2	USB #4_D-	6	USB #5_D-
3	USB #4_D+	7	USB #5_D+
4	GND	8	GND

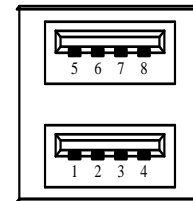

3.3.4 SATA Connector (CN15)

This Serial Advanced Technology Attachment (Serial ATA or SATA) connector is for high-speed SATA interface. It is a computer bus interface for connecting to devices such as hard disk drive.

Pin	Signal
1	GND
2	SATA_TXP0
3	SATA_TXN0
4	GND
5	SATA_RXN0
6	SATA_RXP0
7	GND

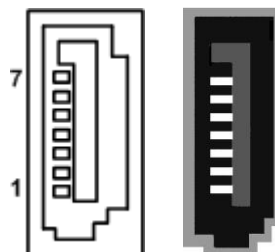

3.3.5 HDMI Connector (CN19)

The HDMI (High-Definition Multimedia Interface) is a compact digital interface which is capable of transmitting high-definition video and high-resolution audio over a single cable. Its interface is available through connector CN19.

Pin	Signal	Pin	Signal
1	HDMI OUT_DATA2+	2	GND
3	HDMI OUT_DATA2-	4	HDMI OUT_DATA1+
5	GND	6	HDMI OUT_DATA1-
7	HDMI OUT_DATA0+	8	GND
9	HDMI OUT_DATA0-	10	HDMI OUT_Clock+
11	GND	12	HDMI OUT_Clock-
13	N.C.	14	N.C.
15	HDMI OUT_SCL	16	HDMI OUT_SDA
17	GND	18	+5V
19	HDMI_HTPLG		

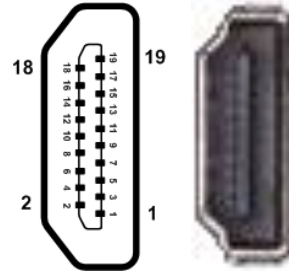

3.3.6 USB 3.0 Ports (CN20 and CN21)

The Universal Serial Bus (compliant with USB 3.0 (5Gb/s) connector on the rear I/O is for installing USB peripherals such as keyboard, mouse, scanner, etc.

USB 3.0 port 0 and 1 (CN20):

Pin	Signal	Pin	Signal
1	USB_VCC (+5V)	10	USB_VCC (+5V)
2	USB #0_D-	11	USB #1_D-
3	USB #0_D+	12	USB #1_D+
4	GND	13	GND
5	SSRX0-	14	SSRX1-
6	SSRX0+	15	SSRX1+
7	GND	16	GND
8	SSTX0-	17	SSTX1-
9	SSTX0+	18	SSTX1+

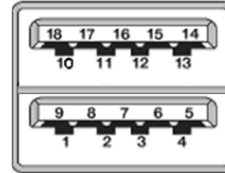

USB 3.0 port 2 and 3 (CN21):

Pin	Signal	Pin	Signal
1	USB_VCC (+5V)	10	USB_VCC (+5V)
2	USB #2_D-	11	USB #3_D-
3	USB #2_D+	12	USB #3_D+
4	GND	13	GND
5	SSRX2-	14	SSRX3-
6	SSRX2+	15	SSRX3+
7	GND	16	GND
8	SSTX2-	17	SSTX3-
9	SSTX2+	18	SSTX3+

3.3.7 Ethernet Ports (LAN1 and LAN2)

The system supports two RJ-45 connectors: LAN1 and LAN2. Ethernet connection can be established by plugging one end of the Ethernet cable into this RJ-45 connector and the other end (phone jack) to a 1000/100/10-Base-T hub.

Pins	1000 Base-T	100/10 Base-T	Descriptions
L1	BI_DA+	TX+	Bidirectional or Transmit Data+
L2	BI_DA-	TX-	Bidirectional or Transmit Data-
L3	BI_DB+	RX+	Bidirectional or Receive Data+
L4	BI_DC+	N.C.	Bidirectional or Not Connected
L5	BI_DC-	N.C.	Bidirectional or Not Connected
L6	BI_DB-	RX-	Bidirectional or Receive Data-
L7	BI_DD+	N.C.	Bidirectional or Not Connected
L8	BI_DD-	N.C.	Bidirectional or Not Connected
A	Active Link LED (Yellow) Off: No link Blinking: Data activity detected		
B	Speed LED 1000: Orange 100: Green 10: OFF		

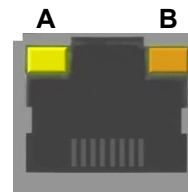
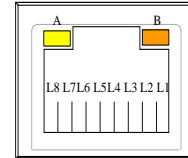

3.3.8 Full-size PCI-Express Mini Card Connector (SCN1)

This is a full-size PCI-Express Mini Card connector on the bottom side supporting PCI-Express x1 or USB 2.0. It also complies with PCI-Express Mini Card Spec. V1.2.

Pin	Signal	Pin	Signal
1	WAKE#	2	+3.3VSB
3	No use	4	GND
5	No use	6	+1.5V
7	CLKREQ#	8	SIM_PWR
9	GND	10	SIM_DATA
11	REFCLK-	12	SIM_CLK
13	REFCLK+	14	SIM_REST
15	GND	16	SIM_VPP
17	No use	18	GND
19	No use	20	W_DISABLE#
21	GND	22	PERST#
23	PE_RXN3	24	+3.3VSB
25	PE_RXP3	26	GND
27	GND	28	+1.5V
29	GND	30	SMB_CLK
31	PE_TXN3	32	SMB_DATA
33	PE_TXP3	34	GND
35	GND	36	USB_D6-
37	GND	38	USB_D6+
39	+3.3VSB	40	GND
41	+3.3VSB	42	No use
43	GND	44	No use
45	No use	46	No use
47	No use	48	+1.5V
49	No use	50	GND
51	No use	52	+3.3VSB

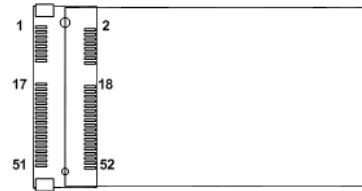

3.3.9 SIM Card Socket (SCN2)

The system has SCN2 socket on the bottom side for inserting SIM Card. In order to work properly, the SIM Card must be used together with 3G/LTE module which is inserted to SCN1 or SCN3. It is mainly used in 3G/LTE wireless network application.

Pin	Signal
1	PWR
2	RST
3	CLK
4	NC
5	GND
6	VPP
7	I/O
8	NC

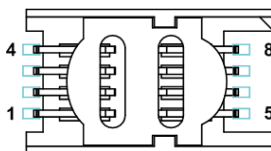

3.3.10 Full-size PCI-Express Mini Card or mSATA Connector (SCN3)

This is a full-size PCI-Express Mini Card connector on the bottom side complying with PCI-Express Mini Card Spec. V1.2. It supports either PCI-Express, USB 2.0 or SATA (mSATA). Since the default setting is PCI-Express, if mSATA is needed to insert, please refer to section 4.4 to change the setting.

Pin	Signal	Pin	Signal
1	WAKE#	2	+3.3VSB
3	No use	4	GND
5	No use	6	+1.5V
7	CLKREQ#	8	SIM_PWR
9	GND	10	SIM_DATA
11	REFCLK-	12	SIM_CLK
13	REFCLK+	14	SIM_REST
15	GND	16	SIM_VPP
17	No use	18	GND
19	No use	20	W_DISABLE#
21	GND	22	PERST#
23	PE_RXN2/SATA_RXP	24	+3.3VSB
25	PE_RXP2/SATA_RXN	26	GND
27	GND	28	+1.5V
29	GND	30	SMB_CLK
31	PE_TXN2/SATA_TXN	32	SMB_DATA
33	PE_TXP2/SATA_TXP	34	GND
35	GND	36	USB_D5-
37	GND	38	USB_D5+
39	+3.3VSB	40	GND
41	+3.3VSB	42	No use
43	GND	44	No use
45	No use	46	No use
47	No use	48	+1.5V
49	No use	50	GND
51	No use	52	+3.3VSB

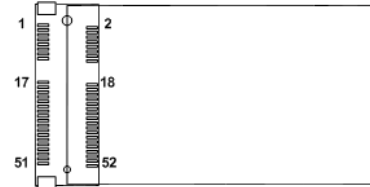

3.3.11 Power and HDD LED Indicator

The Yellow LED is linked to Hard Disk Drive (HDD) activity signal. LED flashes every time HDD is accessed. The power LED (Green) lights up and will remain steady while the system is powered on.

LED Color	Description
Green	Power on/off
Yellow	Hard disk drive activity



3.3.12 System Power Switch

This button is for turning on/off the system power.

Functions	Descriptions
On	Turn on/off system
Off	Keep system status



3.3.13 DC-in Phoenix Power Connector

The system supports 9~36V Phoenix DC-in connector for system power input.

Pin	Signal
1	DC
2	GND

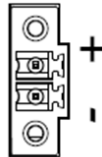

SECTION 4 BIOS SETUP UTILITY

This chapter provides users with detailed description how to set up basic system configuration through the BIOS setup utility.

4.1 Starting

To enter the setup screens, follow the steps below:

1. Turn on the computer and press the key immediately.
2. After you press the key, the main BIOS setup menu displays. You can access the other setup screens from the main BIOS setup menu, such as the Advanced and Chipset menus.

It is strongly recommended that you should avoid changing the chipset's defaults. Both AMI and your system manufacturer have carefully set up these defaults that provide the best performance and reliability.

4.2 Navigation Keys

The BIOS setup/utility uses a key-based navigation system called hot keys. Most of the BIOS setup utility hot keys can be used at any time during the setup navigation process. These keys include <F1>, <F2>, <Enter>, <ESC>, <Arrow> keys, and so on.



NOTE: Some of the navigation keys differ from one screen to another.

Hot Keys	Description
→← Left/Right	The Left and Right <Arrow> keys allow you to select a setup screen.
↑↓ Up/Down	The Up and Down <Arrow> keys allow you to select a setup screen or sub-screen.
+– Plus/Minus	The Plus and Minus <Arrow> keys allow you to change the field value of a particular setup item.
Tab	The <Tab> key allows you to select setup fields.
F1	The <F1> key allows you to display the General Help screen.
F2	The <F2> key allows you to Load Previous Values.
F3	The <F3> key allows you to Load Optimized Defaults.
F4	The <F4> key allows you to save any changes you have made and exit Setup. Press the <F4> key to save your changes.
Esc	The <Esc> key allows you to discard any changes you have made and exit the Setup. Press the <Esc> key to exit the setup without saving your changes.
Enter	The <Enter> key allows you to display or change the setup option listed for a particular setup item. The <Enter> key can also allow you to display the setup sub- screens.

4.3 Main Menu

When you first enter the setup utility, you will enter the Main setup screen. You can always return to the Main setup screen by selecting the Main tab. System Time/Date can be set up as described below. The Main BIOS setup screen is shown below.



Project Version Information

Display the auto-detected BIOS information.

System Date/Time

Use this option to change the system time and date. Highlight System Time or System Date using the <Arrow> keys. Enter new values through the keyboard. Press the <Tab> key or the <Arrow> keys to move between fields. The date must be entered in MM/DD/YY format. The time is entered in HH:MM:SS format.

4.4 Advanced Menu

The Advanced menu also allows users to set configuration of the CPU and other system devices. You can select any of the items in the left frame of the screen to go to the sub menus:

- ▶ Hardware Monitor
- ▶ ACPI Settings
- ▶ Trusted Computing
- ▶ Super IO Configuration
- ▶ CPU Configuration
- ▶ SATA Configuration
- ▶ USB Configuration

For items marked with “▶”, please press <Enter> for more options.

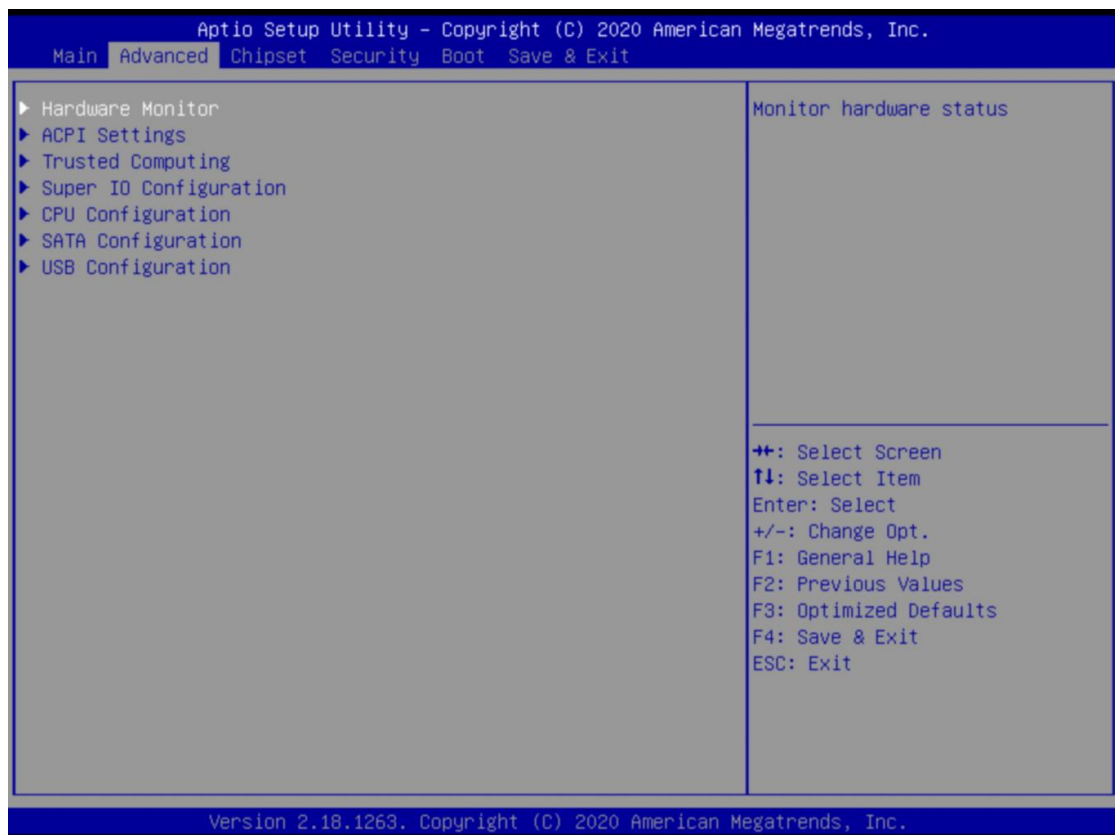

- **Hardware Monitor**

This screen monitors hardware health status.

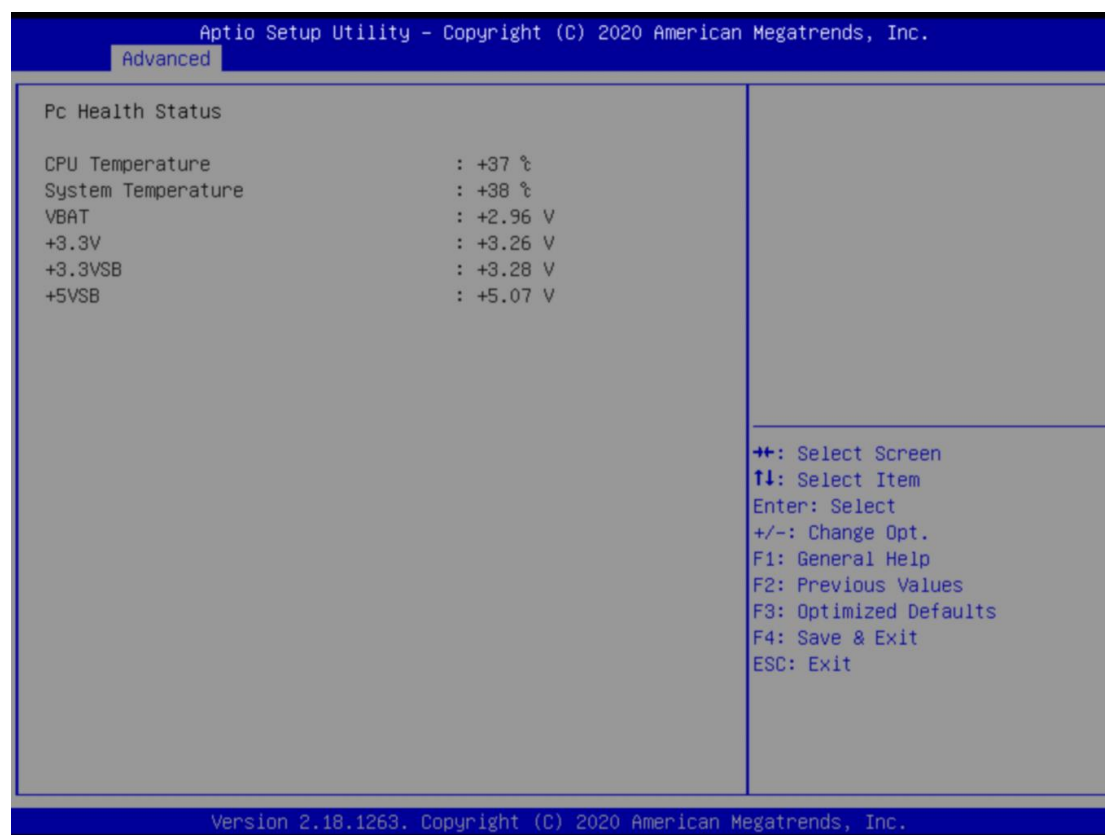

This screen displays the temperature of system and CPU and system voltages (VBAT, +3.3V, +3.3VSB and +5VSB).

- **ACPI Settings**

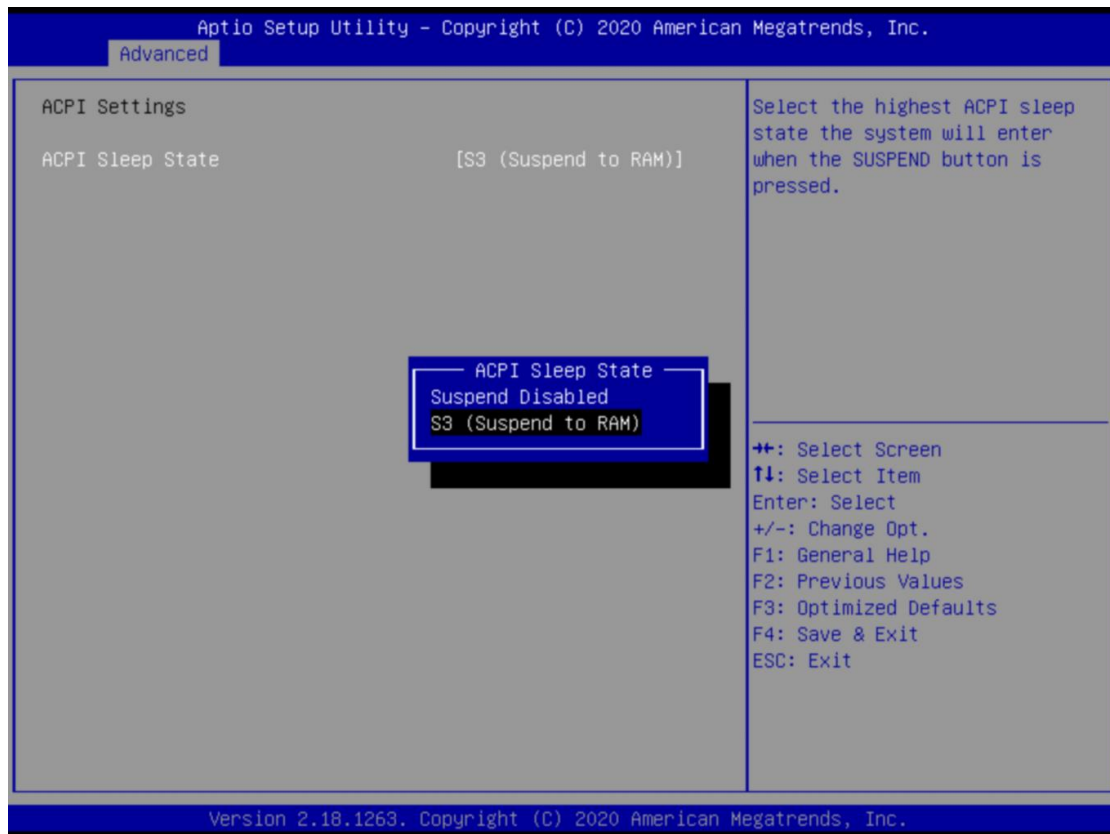

ACPI Sleep State

Select the ACPI (Advanced Configuration and Power Interface) sleep state. Configuration options are Suspend Disabled and S3 (Suspend to RAM). The S3 (Suspend to RAM) option selects ACPI sleep state the system will enter when suspend button is pressed.

- **Trusted Computing**

This screen provides function for specifying the TPM settings.



Security Device Support

Enable or disable BIOS support for security device. The default setting is Enable.

TPM Device

Enable or disable TPM device.

Pending Operation

Schedule a TPM operation which will take effect at the next boot up process.

Current Status Information

Display current TPM status information.

- **Super IO Configuration**

You can use this screen to select options for the Super IO Configuration, and change the value of the selected option. A description of the selected item appears on the right side of the screen. For items marked with "▶", please press <Enter> for more options.

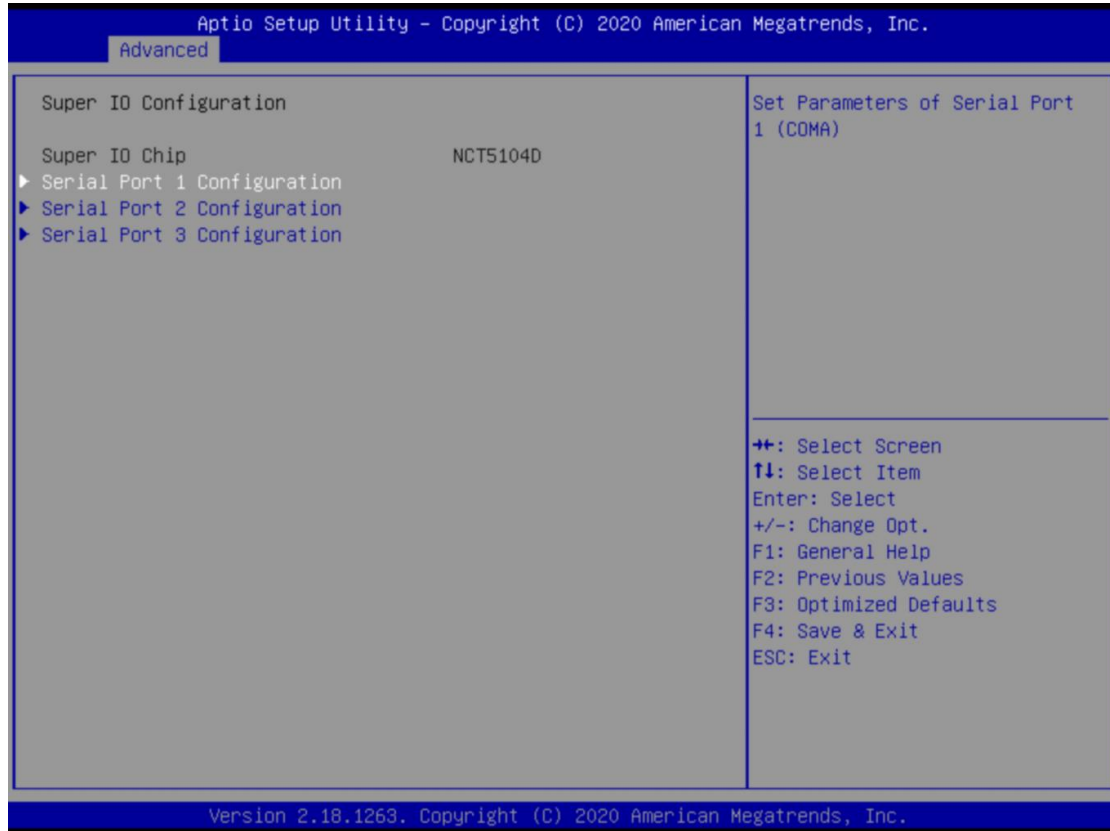

Serial Port 1~3 (COM1~3) Configuration

Use these items to set parameters related to serial port 1~3.

- **Serial Port 1 (COM1) Configuration**

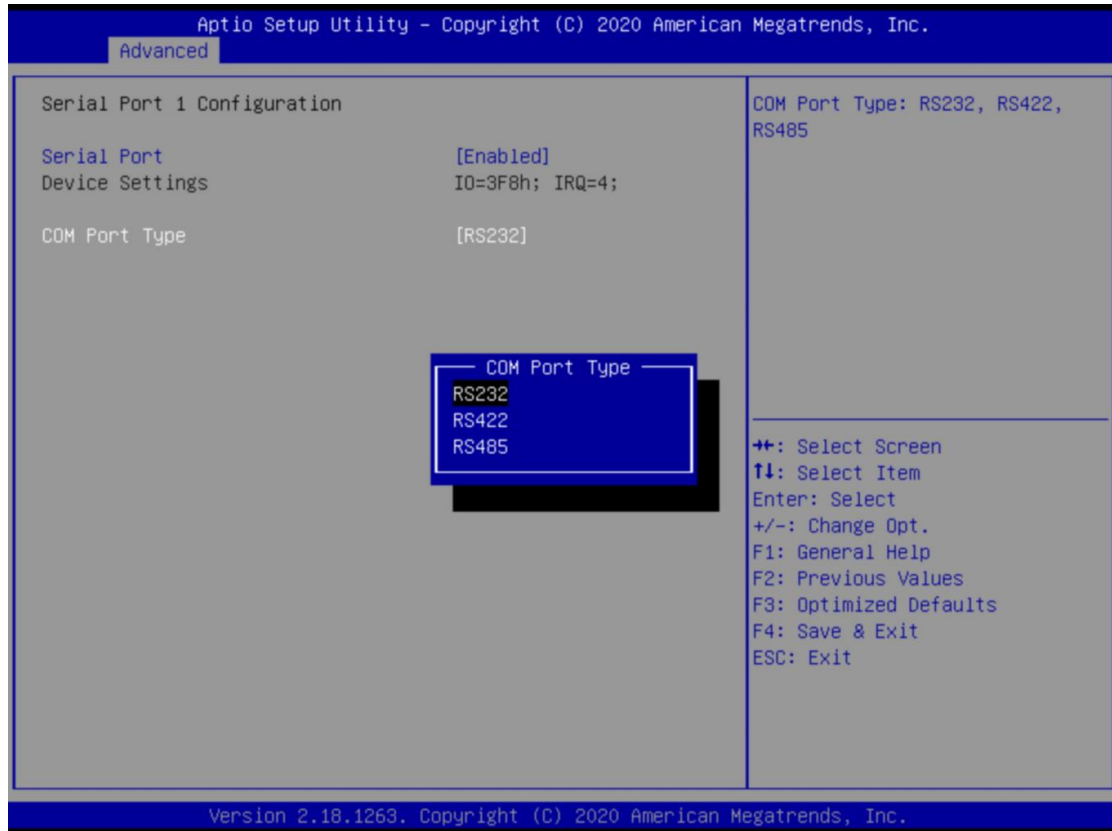

Serial Port

Enable or disable serial port 1. The optimal setting for base I/O address is 3F8h and for interrupt request address is IRQ4.

COM Port Type

Use this option to set RS-232/RS-422/RS-485 mode.

- **Serial Port 2 (COM2) Configuration**

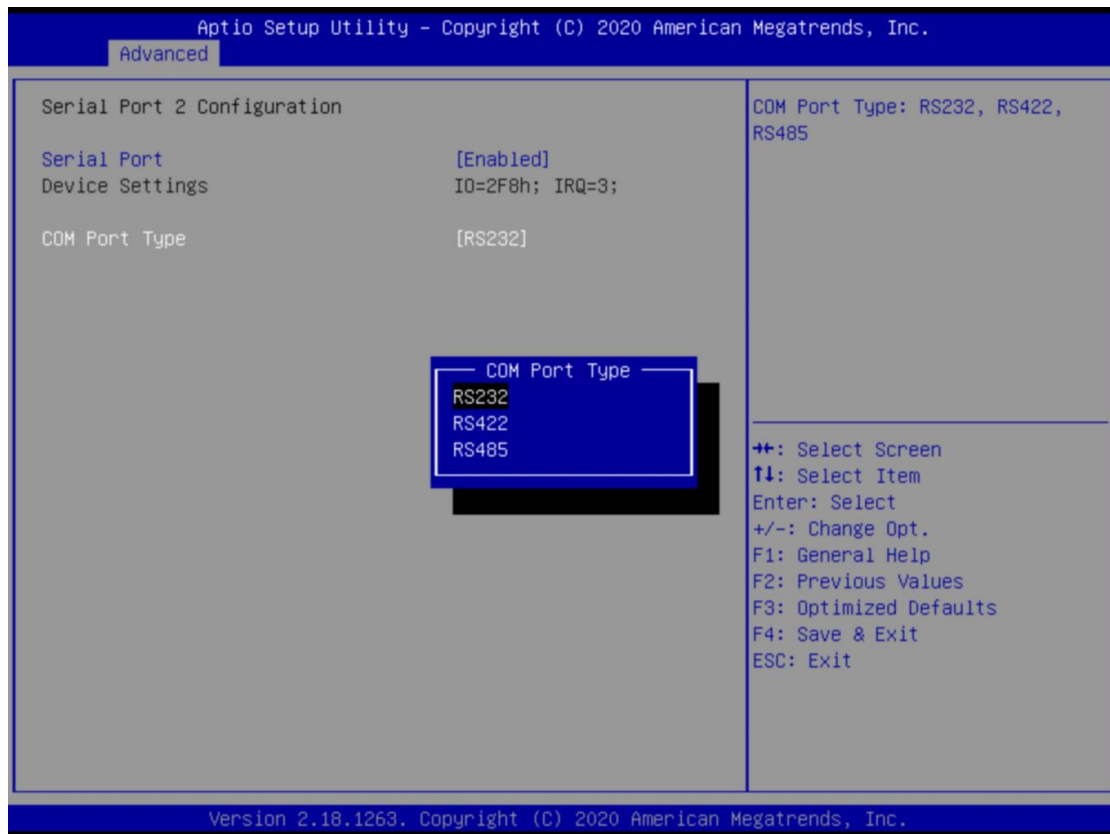

Serial Port

Enable or disable serial port 2. The optimal setting for base I/O address is 2F8h and for interrupt request address is IRQ3.

COM Port Type

Use this option to set RS-232/RS-422/RS-485 mode.

- **Serial Port 3 (COM3) Configuration**



Serial Port

Enable or disable serial port 3. The optimal setting for base I/O address is 3E8h and for interrupt request address is IRQ11.

COM Port Type

Use this option to set only RS-232 mode.

- **CPU Configuration**

This screen shows the CPU Configuration.



Intel Virtualization Technology

Allow a hardware platform to run multiple operating systems separately and simultaneously, enabling one system to virtually function as several systems.

- **Turbo Mode**

This item is for enabling or disabling turbo mode. When enabled, it allows processor cores to run faster than marked frequency under certain conditions. The default is Turbo Mode enable.



● SATA Configuration

In the SATA Configuration menu, you can see the currently installed hardware in the SATA ports. During system boot up, the BIOS automatically detects the presence of SATA devices.

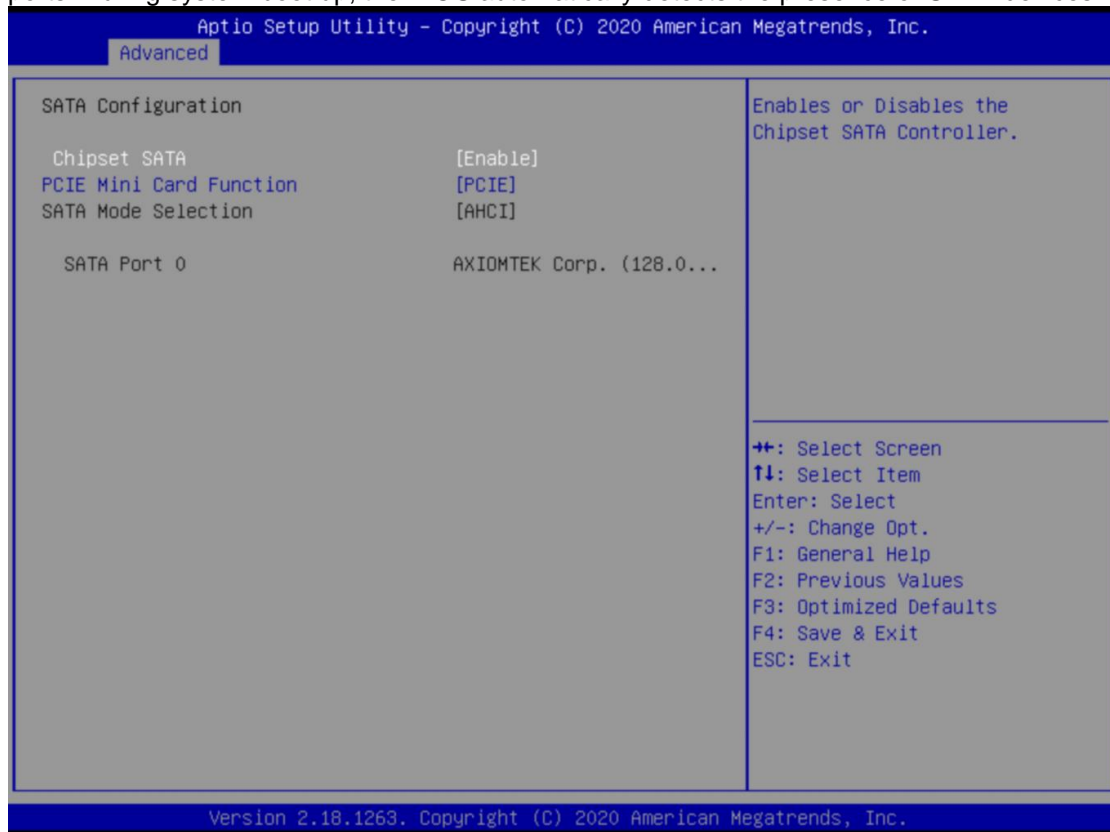

Chipset SATA

Enable or disable Chipset Controller feature. The default is Enabled.

PCIE Mini Card Function

Select PCI-Express Mini Card or mSATA support for SCN3. The default is PCIE. If mSATA is needed to insert to SCN3 (see section 3.3.10), please change setting to mSATA.

SATA Mode Selection

Determine how SATA controller(s) operate. The default is AHCI (Advanced Host Controller Interface) Mode.

- **USB Configuration**

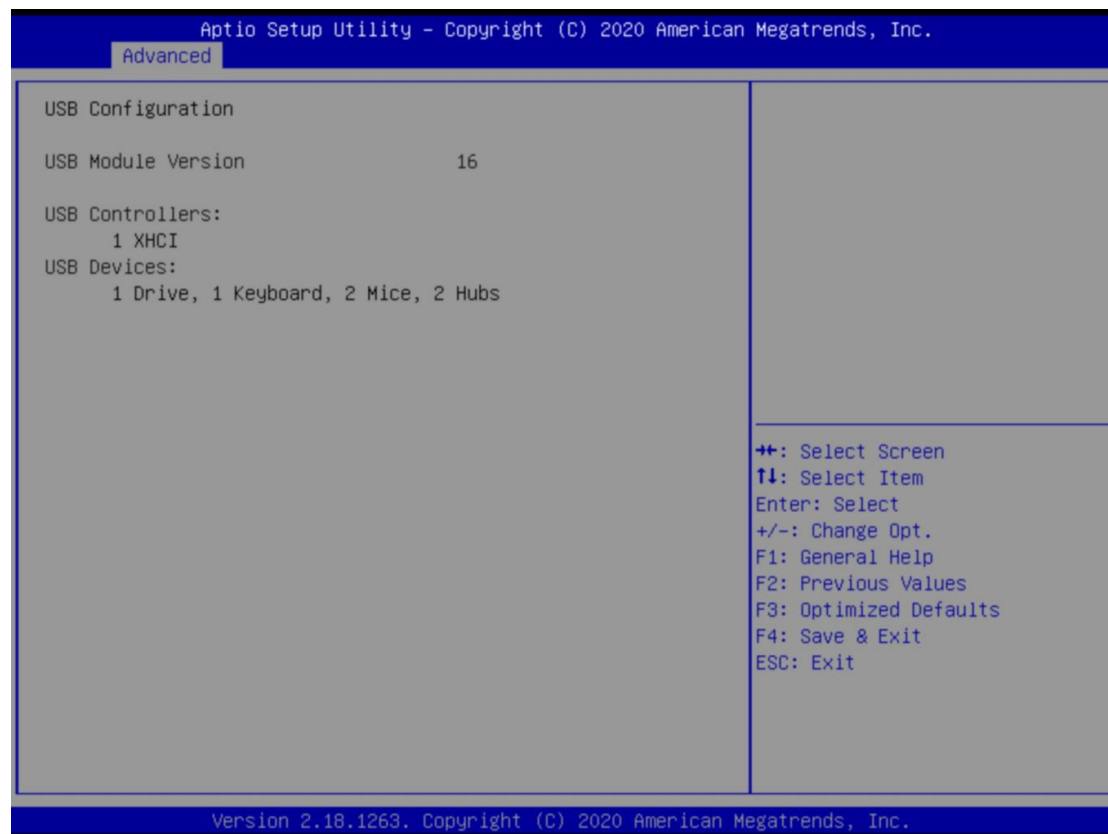

USB Devices

Display all detected USB devices.

4.5 Chipset Menu

The Chipset menu allows users to change the advanced chipset settings. You can select any of the items in the left frame of the screen to go to the sub menus:

- ▶ North Bridge
- ▶ South Bridge

For items marked with “▶”, please press <Enter> for more options.

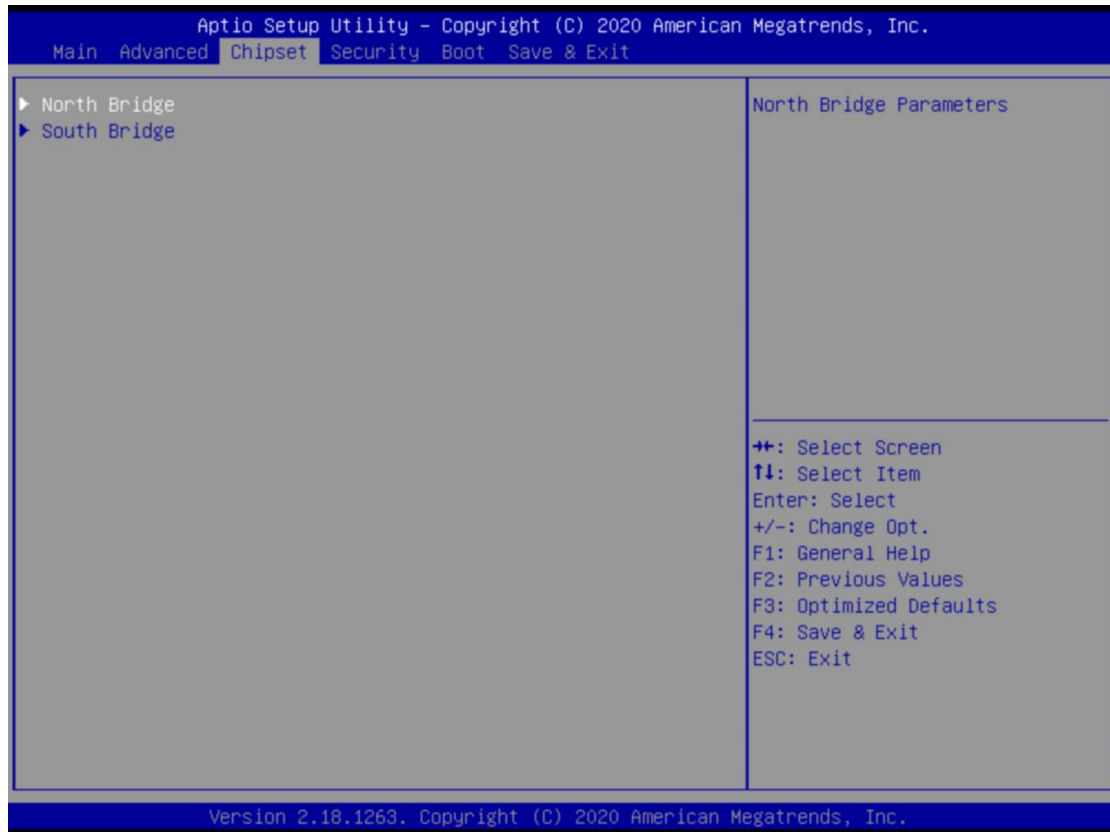

- **North Bridge**



Memory Information

Display system memory information.

- **South Bridge**

This screen allows users to configure parameters of South Bridge chipset.

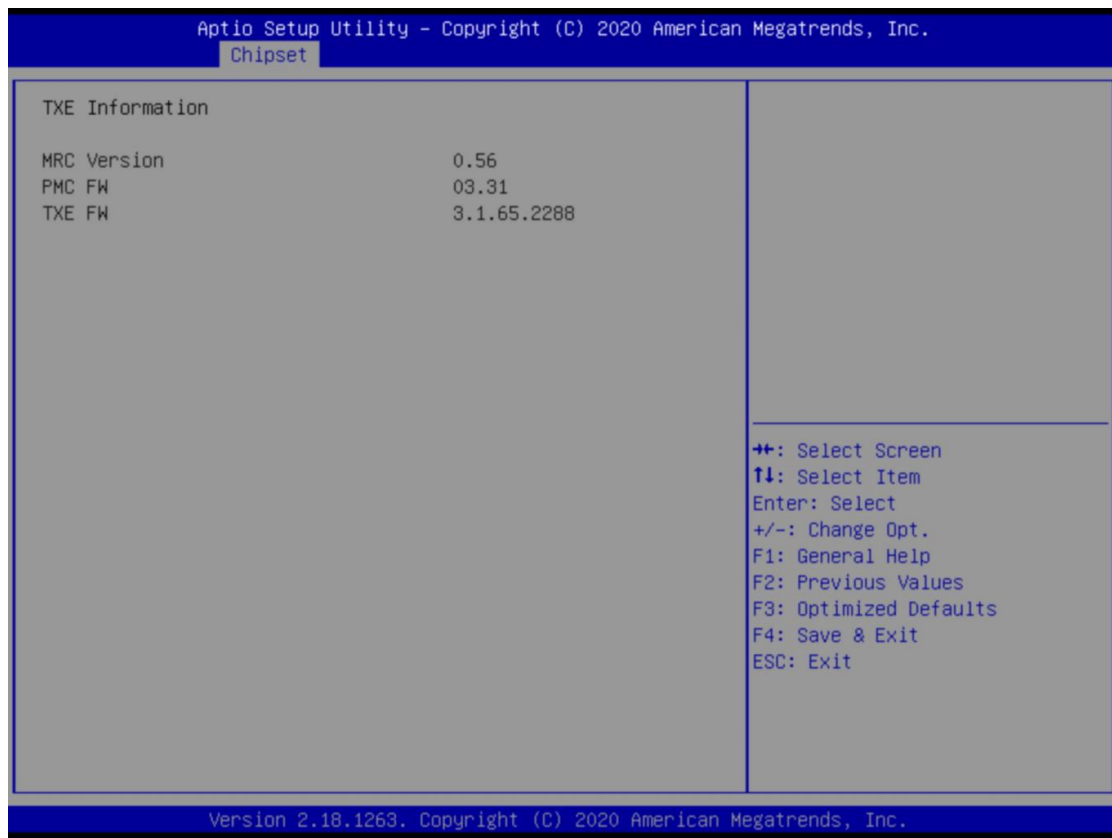

4.6 Security Menu

The Security menu allows users to change the security settings for the system.

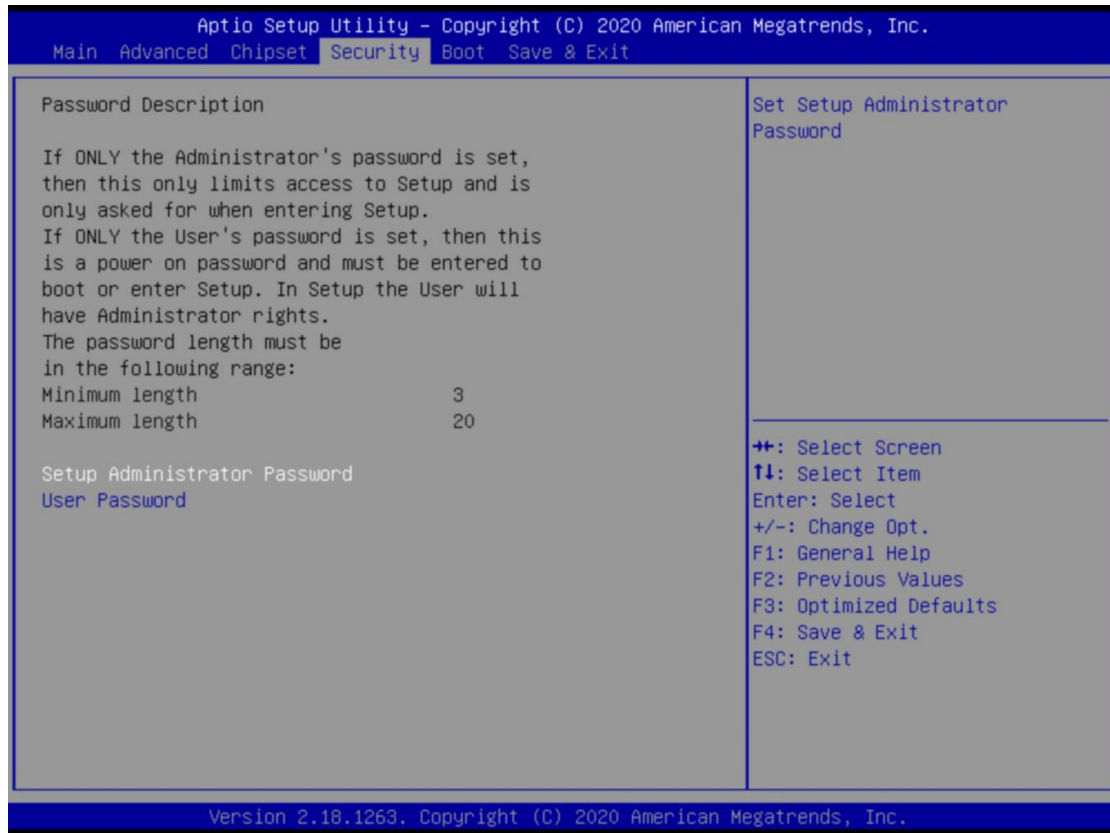

Setup Administrator Password

This item indicates whether an administrator password has been set (installed or uninstalled).

User Password

This item indicates whether an user password has been set (installed or uninstalled).

4.7 Boot Menu

The Boot menu allows users to change boot options of the system.



Setup Prompt Timeout

Number of seconds to wait for setup activation key. 65535 (0xFFFF) means indefinite waiting.

Bootup NumLock State

Use this item to select the power-on state for the keyboard NumLock.

Quiet Boot

Select to display either POST output messages or a splash screen during boot-up.

Launch UEFI PXE OpROM policy

Use this item to enable or disable the boot ROM function of the onboard LAN chip when the system boots up.

Boot Option Priorities

These are settings for boot priority. Specify the boot device priority sequence from the available devices.

Boot Mode

Select either UEFI Mode or Legacy Mode to boot-up. The default is UEFI Mode.

4.8 Save & Exit Menu

The Save & Exit menu allows users to load your system configuration with optimal or fail-safe default values.

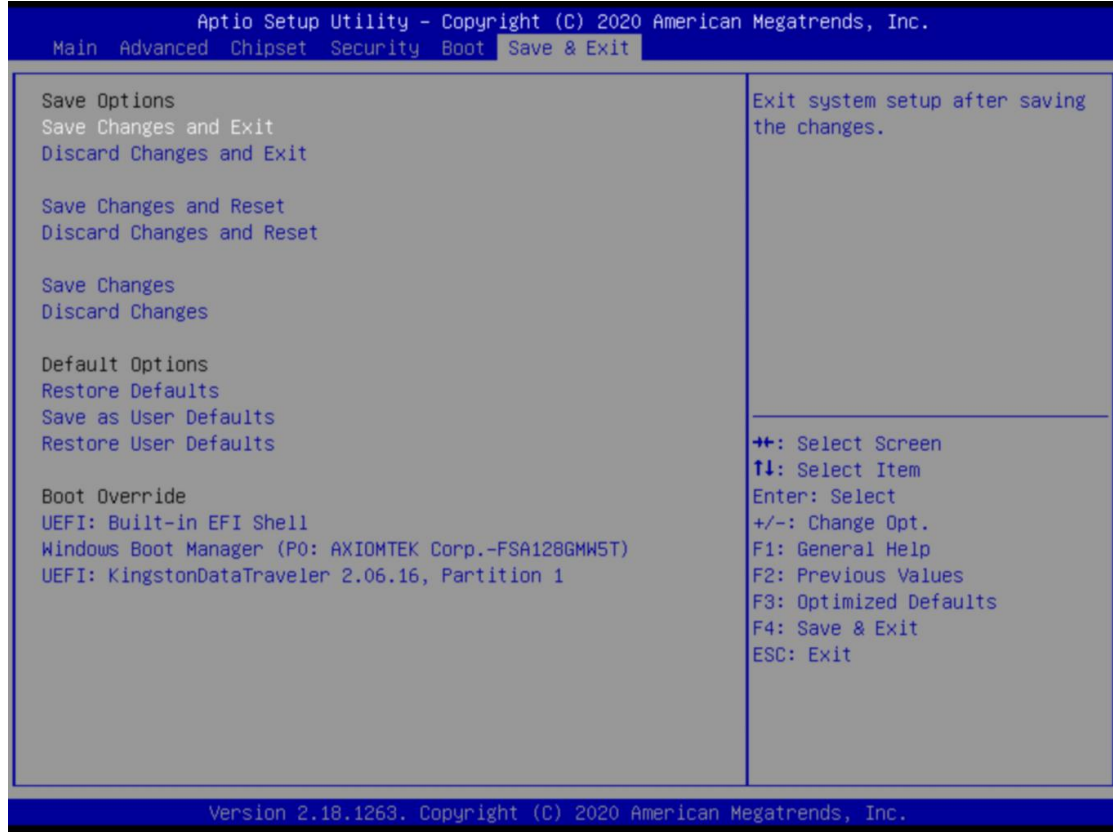

Save Changes and Exit

When you have completed the system configuration changes, select this option to leave Setup and return to Main Menu. Select Save Changes and Exit from the Save & Exit menu and press <Enter>. Select Yes to save changes and exit.

Discard Changes and Exit

Select this option to quit Setup without making any permanent changes to the system configuration and return to Main Menu. Select Discard Changes and Exit from the Save & Exit menu and press <Enter>. Select Yes to discard changes and exit.

Save Changes and Reset

When you have completed the system configuration changes, select this option to leave Setup and reboot the computer so the new system configuration parameters can take effect. Select Save Changes and Reset from the Save & Exit menu and press <Enter>. Select Yes to save changes and reset.

Discard Changes and Reset

Select this option to quit Setup without making any permanent changes to the system configuration and reboot the computer. Select Discard Changes and Reset from the Save & Exit menu and press <Enter>. Select Yes to discard changes and reset.

Save Changes

When you have completed the system configuration changes, select this option to save changes. Select Save Changes from the Save & Exit menu and press <Enter>. Select Yes to save changes.

Discard Changes

Select this option to quit Setup without making any permanent changes to the system configuration. Select Discard Changes from the Save & Exit menu and press <Enter>. Select Yes to discard changes.

Restore Defaults

It automatically sets all Setup options to a complete set of default settings when you select this option. Select Restore Defaults from the Save & Exit menu and press <Enter>.

Save as User Defaults

Select this option to save system configuration changes done so far as User Defaults. Select Save as User Defaults from the Save & Exit menu and press <Enter>.

Restore User Defaults

It automatically sets all Setup options to a complete set of User Defaults when you select this option. Select Restore User Defaults from the Save & Exit menu and press <Enter>.

Boot Override

Select a drive to immediately boot that device regardless of the current boot order.

This page is intentionally left blank.

APPENDIX A WATCHDOG TIMER

A.1 About Watchdog Timer

After the system stops working for a while, it can be auto-reset by the watchdog timer. The integrated watchdog timer can be set up in the system reset mode by program.

A.2 How to Use Watchdog Timer

Assembly sample code:

```
mov    dx,fa10      ; 5 seconds (Maximum is 65535 seconds; fill in
                   ; 0xFA10 and 0xFA11 register, ex: 0xFA11=0x01,
                   ; 0xFA10=0x68 means 360 seconds)

mov    al,05
out    dx,al

mov    dx,fa12      ; Enable WDT
mov    al,01
out    dx,al
```

This page is intentionally left blank.