



***AXIOMTEK***

## **GOT5103W-845**

All-in-One  
10.1" WXGA TFT Fanless Touch Panel  
Computer with Intel® Celeron® Processor  
N3060 onboard

**User's Manual**



## **Disclaimers**

This manual has been carefully checked and believed to contain accurate information. Axiomtek Co., Ltd. assumes no responsibility for any infringements of patents or any third party's rights, and any liability arising from such use.

Axiomtek does not warrant or assume any legal liability or responsibility for the accuracy, completeness or usefulness of any information in this document. Axiomtek does not make any commitment to update the information in this manual.

Axiomtek reserves the right to change or revise this document and/or product at any time without notice.

No part of this document may be reproduced, stored in a retrieval system, or transmitted, in any form or by any means, electronic, mechanical, photocopying, recording, or otherwise, without the prior written permission of Axiomtek Co., Ltd.

## **CAUTION**

If you replace wrong batteries, it causes the danger of explosion. It is recommended by the manufacturer that you follow the manufacturer's instructions to only replace the same or equivalent type of battery, and dispose of used ones.

**©Copyright 2016 Axiomtek Co., Ltd.**

**All Rights Reserved**

**August 2016, Version A3**

**Printed in Taiwan**

## Safety Precautions

Before getting started, read the following important cautions.

1. Be sure to ground yourself to prevent static charge when installing the internal components. Use a grounding wrist strap and place all electronic components in any static-shielded devices. Most electronic components are sensitive to static electrical charge.
2. Disconnect the power cords from the GOT5103W-845 Series before making any installation. Be sure both the system and the external devices are turned OFF. Sudden surge of power could ruin sensitive components. Make sure the GOT5103W-845 Series is properly grounded.
3. Do not open the system's top cover. If opening the cover for maintenance is a must, only a trained technician is allowed to do so. Integrated circuits on computer boards are sensitive to static electricity. To avoid damaging chips from electrostatic discharge, observe the following precautions:
  - Before handling a board or integrated circuit, touch an unpainted portion of the system unit chassis for a few seconds. This will help to discharge any static electricity on your body.
  - When handling boards and components, wear a wrist-grounding strap, available from most electronic component stores.

## Trademarks Acknowledgments

Axiomtek is a trademark of Axiomtek Co., Ltd.

Windows<sup>®</sup> is a trademark of Microsoft Corporation.

IBM, PC/AT, PS/2, VGA are trademarks of International Business Machines Corporation.

Intel<sup>®</sup> and Pentium<sup>®</sup> are trademarks of Intel Corporation.

AMI is trademark of American Megatrend Inc.

Other brand names and trademarks are the properties and registered brands of their respective owners.

# Table of Contents

---

Disclaimers.....	ii
Safety Precautions.....	iii
<b>Chapter 1 Introduction.....</b>	<b>1</b>
1.1 General Description .....	2
1.2 Specifications.....	3
1.3 Dimensions.....	5
1.4 I/O Outlets .....	6
1.5 Packing List .....	8
<b>Chapter 2 Hardware and Installation .....</b>	<b>9</b>
2.1 SBC87845 Jumpers and Connectors.....	10
2.1.1 Jumper Settings .....	12
2.1.2 Connectors .....	13
2.2 Ethernet.....	18
2.3 Mountings –Panel/Wall/Desktop/VESA .....	19
2.3.1 Panel-Mounting .....	19
2.3.2 VESA-ARM/Wall-Mount .....	20
2.4 Half-slim SSD Installation .....	21
2.5 DRAM Installation.....	23
2.6 Mini Card Installation .....	25
2.6.1 Wireless LAN Card Installation .....	25
2.6.2 mSATA Card Installation.....	27
2.7 Power Input (Phoenix type) .....	28
<b>Chapter 3 AMI BIOS Setup Utility .....</b>	<b>29</b>
3.1 Navigation Keys .....	29
3.2 Main Menu.....	30
3.3 Advanced Menu.....	31
3.4 Chipset Menu.....	38
3.5 Security .....	40
3.6 Boot Menu.....	41
3.7 Save & Exit.....	42
<b>Chapter 4 Drivers Installation .....</b>	<b>43</b>

<b>4.1</b>	<b>System .....</b>	<b>43</b>
4.1.1	Windows 7, 8.X, 10 .....	43
<b>4.2</b>	<b>Touch Screen.....</b>	<b>44</b>
4.2.1	Specification .....	44
4.2.2	Driver Installation- Windows 7/8.X/10 .....	44
<b>4.3</b>	<b>Embedded O.S.....</b>	<b>45</b>
4.3.1	WES 7 & WE8S.....	45
 <b>Appendix A Watchdog Timer &amp;DIO Programming ....</b>		<b>47</b>
About Watchdog Timer.....		47
How to Use Watchdog Timer.....		47
WDT Sample Program .....		48
How to Use DIO Software Programming.....		49
 <b>Appendix B Volume Control .....</b>		<b>51</b>
About Volume Control .....		51
How to Use Volume Control .....		51
Removed Volume Control Tool .....		58

**This page is intentionally left blank.**

# Chapter 1

## Introduction



This chapter contains general information and detailed specifications of the GOT5103W-845. Chapter 1 includes the following sections:

- General Description
- Specifications
- Dimensions
- I/O Outlets
- Package List

## 1.1 General Description

The GOT5103W-845 is a fan-less and compact-size touch panel computer, equipped with a 10.1" TFT LCD display, project capacitive multi-touch and low power consumption Intel® Celeron® Processor N3060 (2M Cache, up to 2.48 GHz). The GOT5103W-845 supports Windows 7, Windows 8.x, Windows 10 and Windows embedded OS. The panel computer is able to install a mSATA and an optional half-slim SSD, provides two Mini card slots for wireless module. Its excellent ID and friendly user interface make it a professional yet easy-to-use panel computer. The GOT5103W-845 is an ideal for space-limited applications in factory automation, machine maker operating systems, building automation, and more.

### **GOT5103W-845: 10.1" TFT WXGA Fanless Touch Panel Computer**

- **Reliable and Stable Design**  
The GOT5103W-845 adopts a fanless cooling system and a mSATA, which makes it suitable for vibration environments.
- **Embedded O.S. Supported**  
The GOT5103W-845 not only supports Windows 7, Windows 8.x and Windows 10, but also supports embedded OS,. For storage device, the GOT5103W-845 supports an optional half –slim SSD device and a mSATA.
- **Industrial-grade Product Design**  
The GOT5103W-845 has an incredible design to be used in different industrial environments.

**The front bezel meets the IP65 standard.**

**For connecting other devices, the GOT5103W-845 also features several interfaces: USB, Ethernet, and RS-232/422/485.**



## 1.2 Specifications

### Main CPU Board

- **CPU**
  - Intel® Celeron® Processor N3060 (2M Cache, up to 2.48 GHz) onboard.
- **System Memory**
  - One 204-pin DDR3L SO-DIMM socket
  - Maximum memory up to 8BG
- **BIOS**
  - America Megatrends BIOS

### I/O System

- **Standard I/O**
  - one RSS-232/422/485
  - one RS-232
  - Two USB 2.0
  - Two USB 3.0
  - One HDMI
- **Ethernet**
  - 2x RJ45 Giga Ethernet (Intel i211AT)
- **Audio**
  - One Line out
  - Two Internal 2W speaker
- **Expansion**
  - 1 x Mini-card slot (w/SIM slot)
  - 1 x Mini-card slot (supports mSATA, optional)
- **Storage**
  - One mSATA
  - One half-slim SSD
- **Power connector**
  - GOT5103W-845-PCT-J: 12VDC w/external 60W AC Adapter with screw type connector or
  - GOT5103W-845-PCT-24VDC : 24VDC with phoenix power connector or

## System Specification

- **10.1" WXGA(1289x800) LCD with LED backlight**
- **Project capacitive multi-touch**
- **Fanless Heat Dispensing Design**
- **Disk drive housing:**
  - One half-slim SSD(optional)
  - One mSATA
- **Net Weight**
  - 1.08 Kgs (2.38 lb)
- **Dimension (Main Body Size)**
  - 260.8 mm (10.27") (W) x 38 mm (1.50" (D) x 194.1 mm (7.65") (H)
- **Operation Temperature**
  - 0°C to 50°C
- **Relative Humidity**
  - 10% to 90% @ 40°C, Non-Condensing
- **Vibration**
  - 2.0G, 5 to 500 Hz, 2.0 G random for SSD
- **Power input**
  - 24VDC with phoenix power connector or
  - External 60W AC Adapter
    - Power Input: 100VAC to 240VAC
    - Power Output: 12VDC, Max. 5A



**NOTE** *All specifications and images are subject to change without notice.*



**NOTE** *If the operation temperature is higher than 35°C, the wide temperature HDD is recommended to be used on the device.*

### 1.3 Dimensions

This diagram shows you dimensions and outlines of the GOT5103W-845.

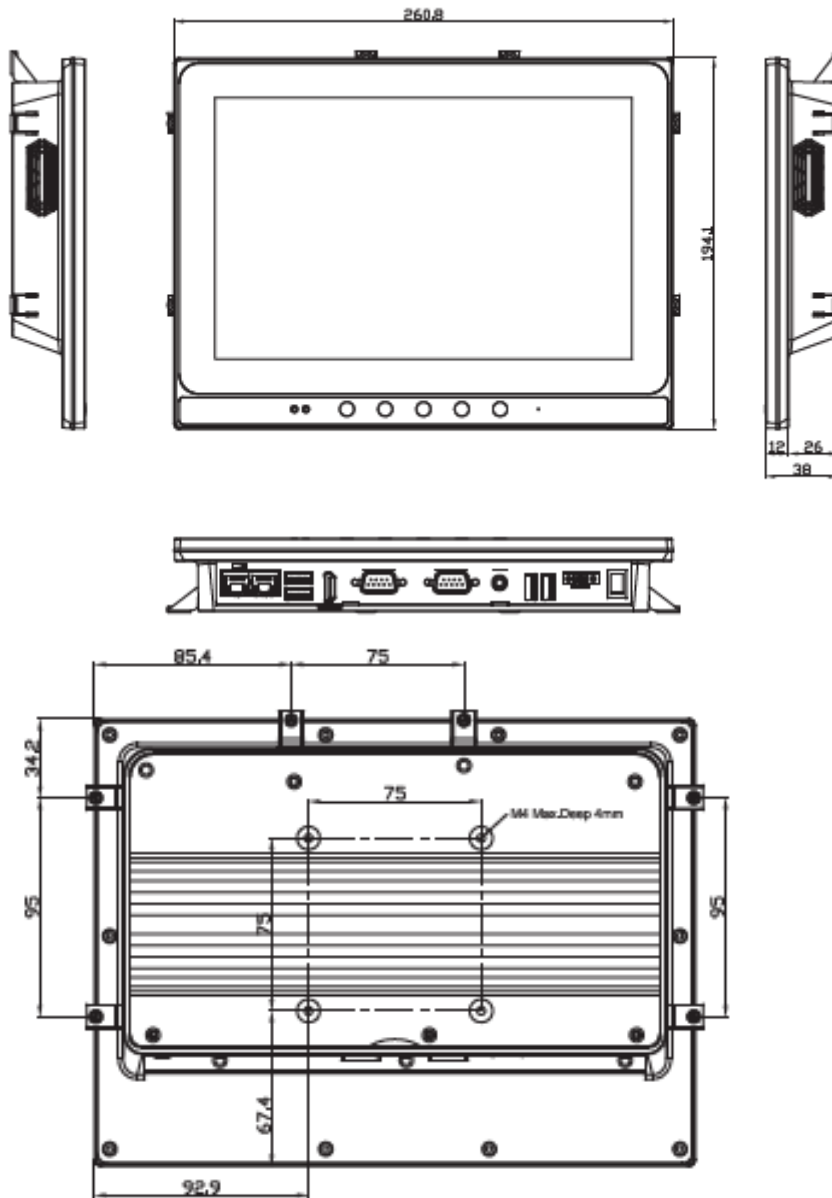

## 1.4 I/O Outlets

Please refer to the following illustration for I/O locations of the GOT5103W-845.

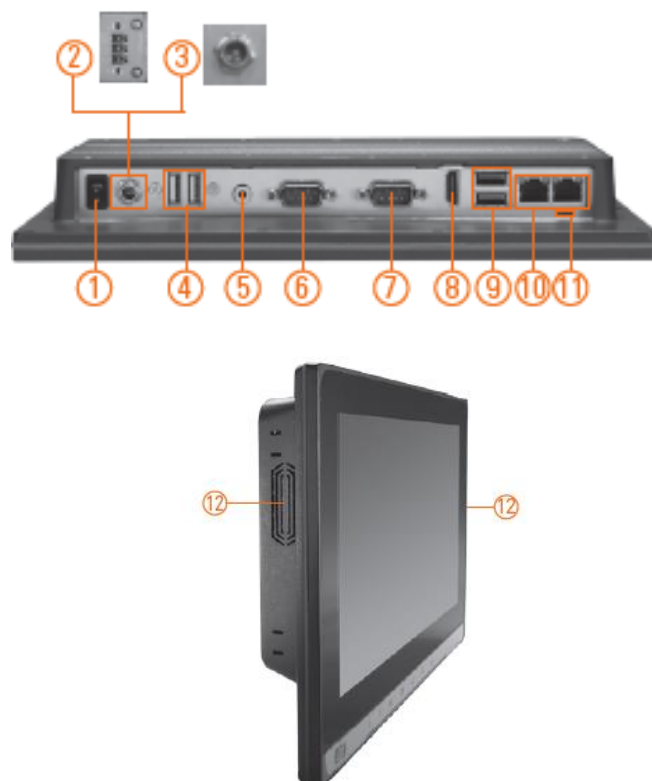

No	Function	No	Function
1	POWER SWITCH (ATX)	7	COM 2(RS-232)
2	Power Input connector (Phoenix)	8	HDMI
3	Power Input connector (Screw)	9	USB 3.0 x 2
4	USB 2.0 x 2	10	Ethernet x 2
5	Audio (Line-out)	11	AT(right) / ATX(left) switch
6	COM 1(RS-232/422/485)	12	Speaker

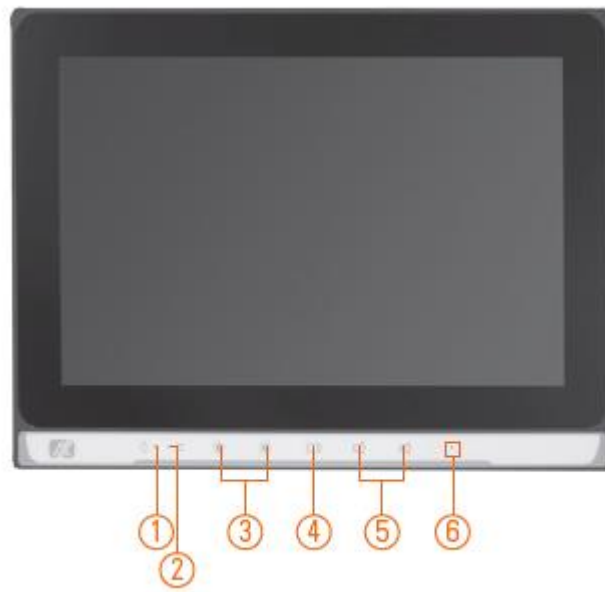

No	Function	No	Function
1	Power LED orange: display off green : display on	4	Display on/off
2	HDD LED	5	Volume +/-
3	Brightness +/-	6	Mic in



**NOTE** The volume control function only can be performed under the windows operation system with AXIOMTEK volumeSYNC program.

## **1.5 Packing List**

When you receive the GOT5103W-845, the bundled package should contain the following items:

- GOT5103W-845 x 1
- Driver CD x 1
- Phoenix connector x1 (for GOT5103W-845-DC and GOT5103W-845-24VDC)
- Power Adapter & power cord (for GOT5103W-845-J)

If you can not find the package or any items are missing, please contact Axiomtek distributors immediately.

# Chapter 2

## Hardware and Installation

The GOT5103W-845 provides rich I/O ports and flexible expansions for you to meet different demand. The chapter will show you how to install the hardware. It includes:

- SBC87845 Jumpers and Connectors
- Ethernet
- Mounting Way
- Hard disk
- DRAM
- Wireless LAN Card
- Power Input

## 2.1 SBC87845 Jumpers and Connectors

### Component Side

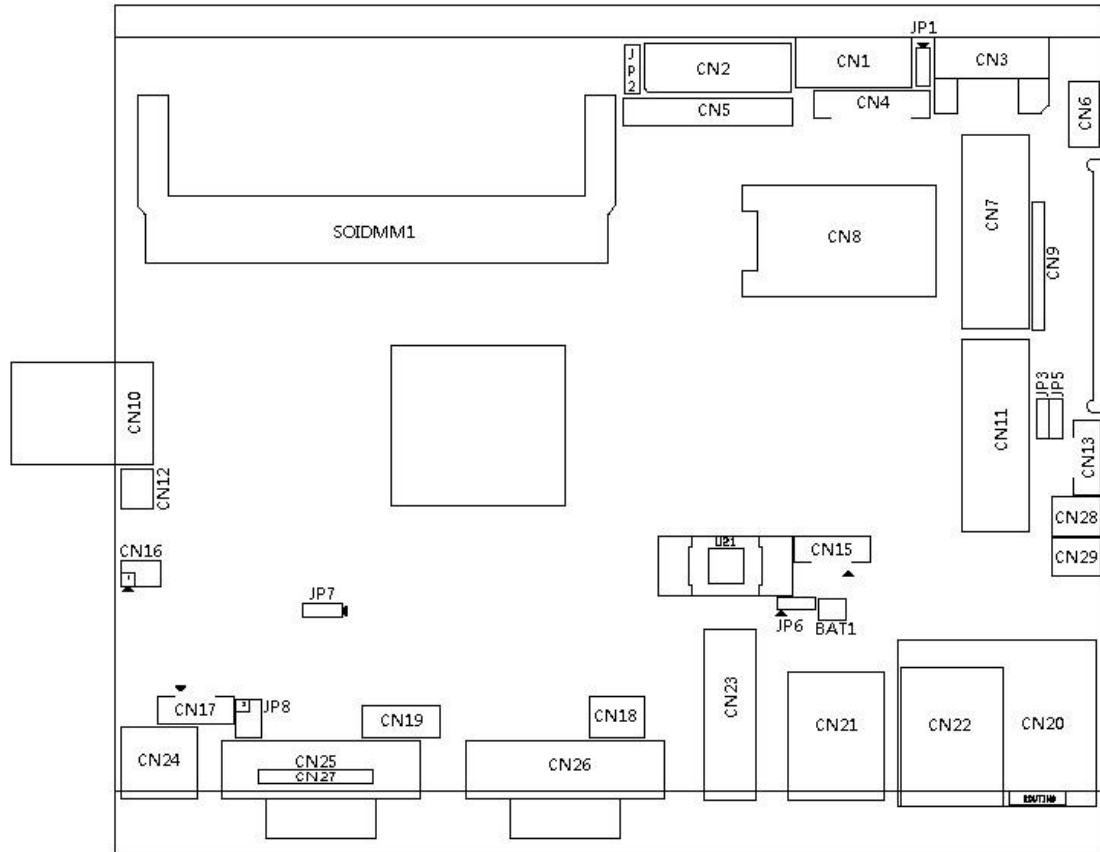



## Solder Side

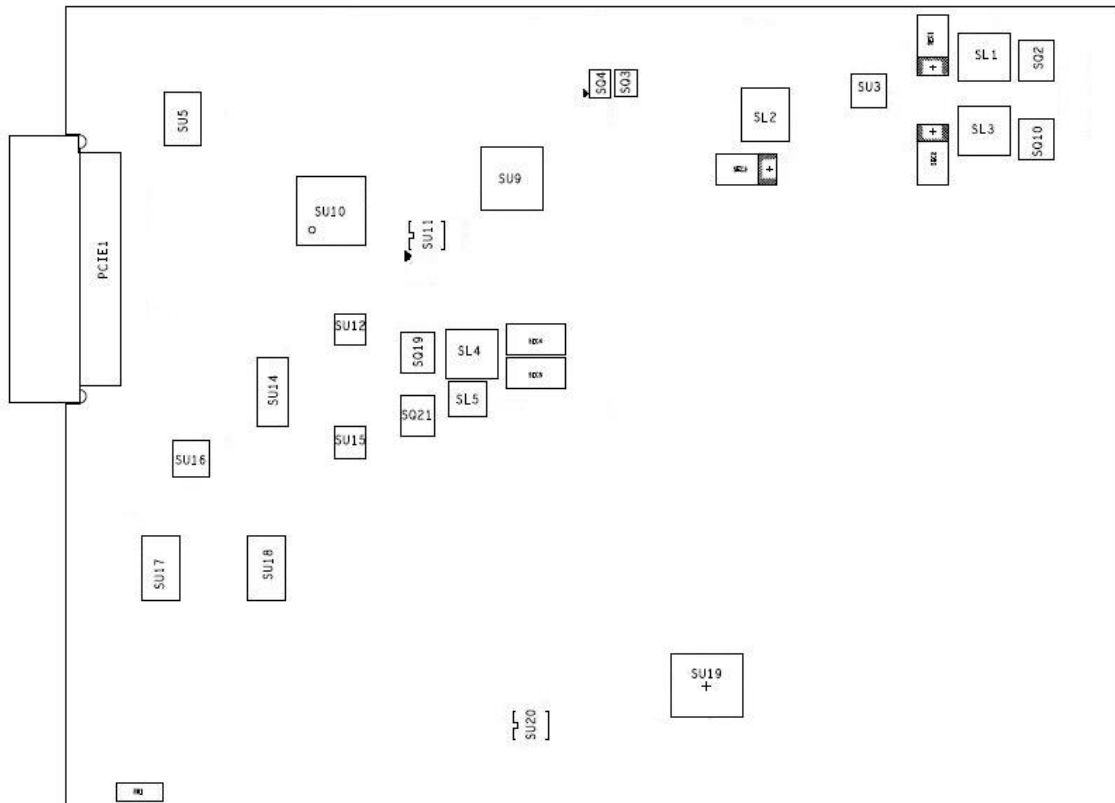

## 2.1.1 Jumper Settings

Making the proper jumper settings configure the **SBC87845** to match the needs of your application.

The following table shows the default jumper settings for the onboard devices.

Jumper	★ Default Setting	Jumper Setting
JP1	★ OSD function: LCD ON/OFF OSD function: Touch ON/OFF	Short 1-2 Short 2-3
JP2	★ LVDS Panel Power : 3.3V LVDS Panel Power : 5V	Short 1-2 Short 2-3
JP3	★ ATX mode AT mode	Short 1-2 Short 2-3
JP5	Touch Controller 4,8 WIRE ★ Touch Controller 5 WIRE	Short 1-2 Short 2-3
JP6	★ Normal Clear CMOS	Short 1-2 Short 2-3
JP7	★ Internal Buzzer enable Internal Buzzer disable	Short 1-2 Short 2-3
JP8	★ COM1 normal mode COM1 pin1 with power :+5V COM1 pin9 with power :+12V	Short 3-5,4-6 Short 1-3,4-6 Short 3-5,2-4

## 2.1.2 Connectors

The connectors allow the CPU Board to connect with other parts of the system. Ensure that all connectors are in place and firmly attached. The following table lists the function of each connector on the **SBC87845**

Connectors	Label
LVDS inverter connector	CN1
LVDS connector	CN2
SATA connector	CN3
OSD connector	CN4
HDD power connector	CN6
Full size min-PCIe connector	CN7,CN11
SIM card connector	CN8
DIO connector	CN9
Power connector	CN10
Power Button connector	CN12
Touch connector	CN13
LIN/MIC In connector	CN16
Speaker Out connector	CN17
System Fan connector	CN18
USB2.0 connector	CN19
RJ45 connector	CN20,CN22
USB3.0 connector	CN21
HDMI connector	CN23
Audio out connector	CN24
RS232/422/485 Port connector	CN25,CN27
RS232 Port connector	CN26
+5V Standby Power connector	CN28,CN29

### LVDS inverter connector: CN1

Pin	Description	Pin	Description
1	GND	5	Inverter ON-OFF
2	GND	6	+12V
3	GND	7	+12V
4	Backlight control	8	+12V

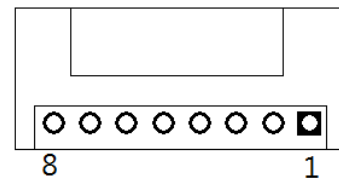

**LVDS connector: CN2**

**Pin Assignment**

Pin	Description	Pin	Description
1	VCC	21	GND
2	VCC	22	GND
3	VCC	23	LVDSA_DATAN0
4	VCC	24	LVDSB_DATAN2
5	VCC	25	LVDSA_DATAP0
6	VCC	26	LVDSB_DATAP2
7	Resolution selection[0]	27	GND
8	Resolution selection[1]	28	GND
9	GND	29	LVDSA_DATAN1
10	GND	30	LVDSA_DATAN3
11	LVDSB_DATAN3	31	LVDSA_DATAP1
12	LVDSB_DATAN0	32	LVDSA_DATAP3
13	LVDSB_DATAP3	33	GND
14	LVDSB_DATAP0	34	GND
15	GND	35	LVDSA_DATAN2
16	GND	36	LVDSA_CLKN
17	LVDSB_CLKN	37	LVDSA_DATAP2
18	LVDSB_DATAN1	38	LVDSA_CLKP
19	LVDSB_CLKP	39	Resolution selection[2]
20	LVDSB_DATAP1	40	Resolution selection[3]

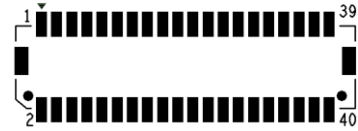

**OSD connector: CN4**

Pin	Description
1	Brightness+
2	Brightness-
3	volume+
4	Volume-
5	Touch or LCD ON/OFF
6	POWER LED
7	SATA LED
8	Touch LED
9	BackLight LED
10	GND

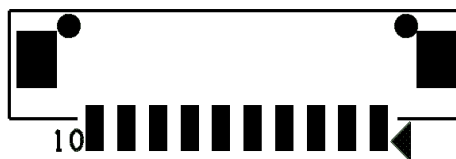

**HDD power connector: CN6**

Pin	Description
1	+12V
2	GND
3	GND
4	+5V

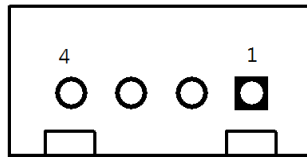

**SIM card connector: CN8**

Pin	Description	Pin	Description
1	UIM PWR	5	GND
2	UIM RST	6	UIM VPP
3	UIM CLK	7	UIM DATA
4	NC	8	NC

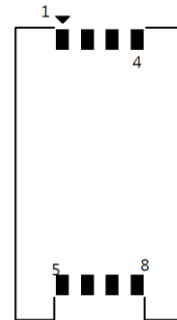

**DIO connector: CN9**

Pin	Description
1	GPIO0
2	GPIO1
3	GPIO2
4	GPIO3
5	GPIO4
6	GND
7	GPIO5
8	GPIO6
9	+3.3V
10	GPIO7



**Power connector: CN10**

Pin	Description
1	DCIN (+12V)
2	DCIN (+12V)
3	GND
4	GND

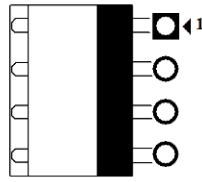

**Power button connector: CN12**

Pin	Description	Pin	Description
1	GND	2	PWBTN

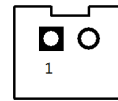

**TOUCH connector: CN13**

Pin	Description
1	Sense
2	X+
3	X-
4	Y+
5	Y-

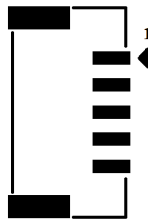

**Lin/Mic In connector: CN16**

Pin	Description	Pin	Description
1	LIN IN R	2	GND
3	LIN IN L	4	GND
5	MIC IN	6	GND

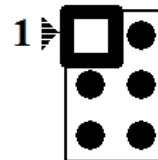

**Speaker connector: CN17**

Pin	Description
1	SPKOUT_L-
2	SPKOUT_L+
3	SPKOUT_R-
4	SPKOUT_R+
5	GND



**System Fan connector: CN18**

Pin	Description
1	GND
2	+12V / Speed control output
3	Fan speed detect

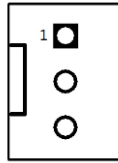

**USB2.0 connector: CN19**

Pin	Description	Pin	Description
1	+5V	2	+5V
3	USB-	4	USB-
5	USB+	6	USB+
7	GND	8	GND
9	GND	10	GND

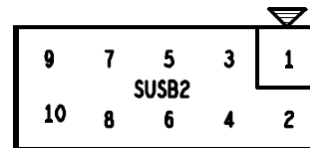

**+5V Standby Power connector: CN28, CN29**

Pin	Description	Pin	Description
1	GND	2	+5V_SBY

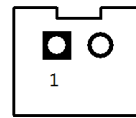

● **COM port Connector**

The pin assignment of RS-232/RS-422/RS-485 is listed on the following table.

Pin	RS-232	RS-422	RS-485
1	DCD	TX-	Data-
2	RXD	TX+	Data+
3	TXD	RX+	No use
4	DTR	RX-	No use
5	GND	GND	GND
6	DSR	No use	No use
7	RTS	No use	No use
8	CTS	No use	No use
9	RI	No use	No use

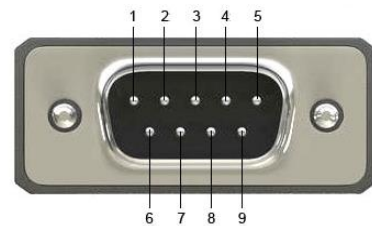

## 2.2 Ethernet

The **GOT5103W-845** is equipped with two high performance Plug and Play Ethernet interfaces, full compliant with IEEE 802.3 standard, and can be connected with a RJ-45 LAN connector.

Please refer to detailed pin assignment list below:

Pin	Signal
1	TX+ (Data transmission positive)
2	TX- (Data transmission negative)
3	Rx+(Data reception positive)
4	RJ45 termination
5	RJ45 termination
6	Rx- (Data reception negative)
7	RJ45 termination
8	RJ45 termination

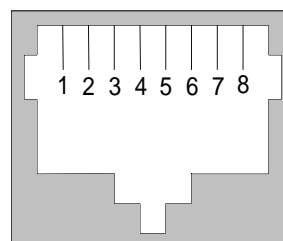

RJ45



## 2.3 Mountings –Panel/Wall/Desktop/VESA

There are several mounting ways for the GOT5103W-845, Wall, Desktop , VESA and panel mountings.

### 2.3.1 Panel-Mounting

The GOT5103W-845 is designed for panel mount application. A set of standard mounting kit are bundled with the system package that you can use it to mount the GOT5103W-845.

**Step1 Sticks 4 sealing pads on the edges of chassis.**

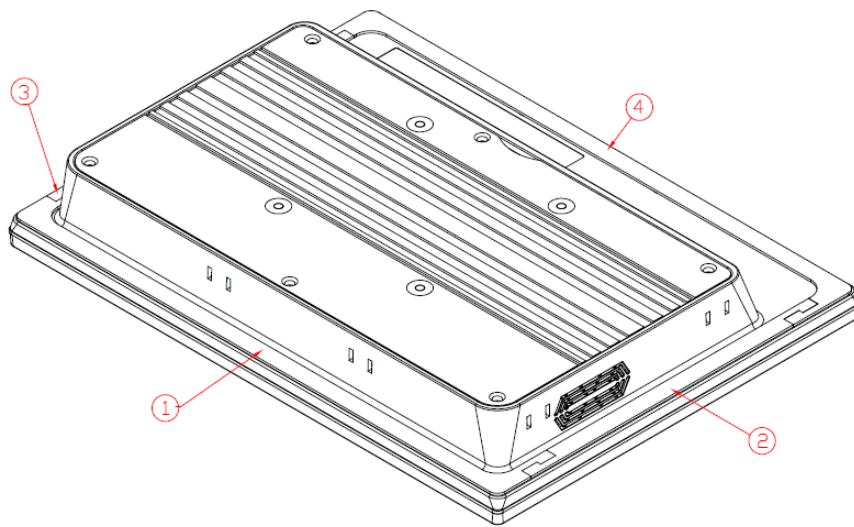

**Step2 Assemble the panel kit to the chassis, and fix the screws.**

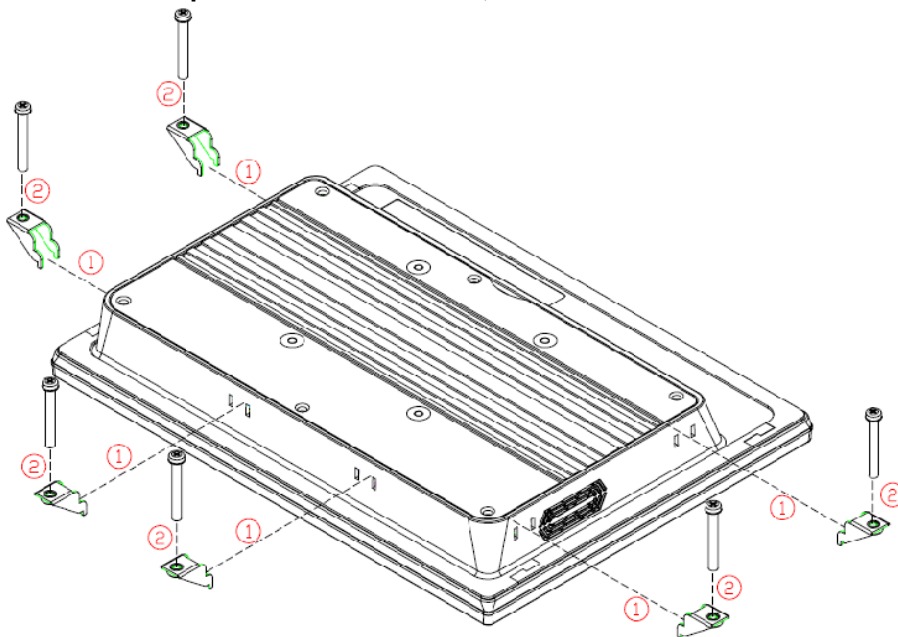

### 2.3.2 VESA-ARM/Wall-Mount

The GOT5103W-845 provides VESA mount: 75x75 mm. Screw four screws to fix the kit in the back chassis.

**Step1** Find out the screws as marked on the back side of chassis.

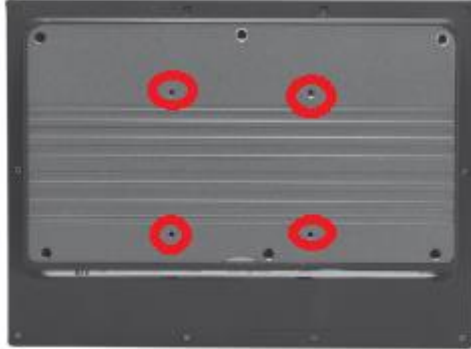

**Step2** Assemble the VESA brace to the back side of the chassis, and fix the screws.



**Step 3** VESA mounting Installation completed.

## 2.4 Half-slim SSD Installation

The GOT5103W-845 provides an optional half-slim SSD for users to install. Please refer to the following instructions for installation:

**Step 1** Turn off the system, and unplug the power cord.

**Step 2** Remove the back cover.

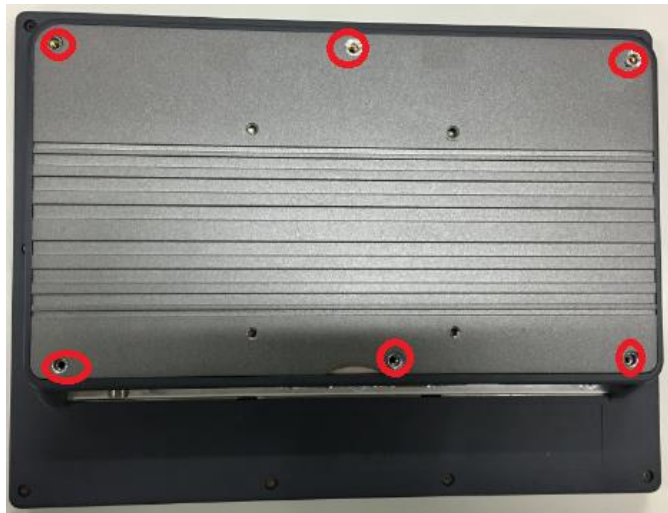

**Step 3** Screw half-slim SSD bracket into the system.



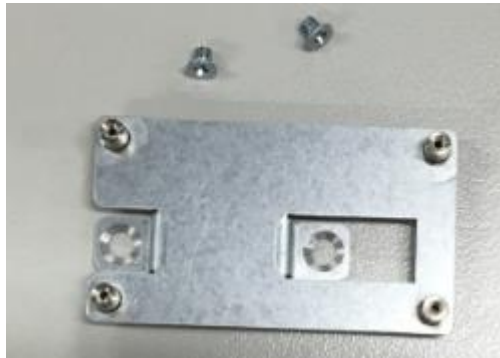

**Step 4** Plug the data and power cable to half-slim SSD. Screws the half-slim SSD into the system, and Installation complete.





## 2.5 DRAM Installation

The GOT5103W-845 provides one 204-pin DDR3L SODIMM socket that support system memory up to 8GB. Please follow steps below to install the memory modules:

**Step 1** Open the back cover and find out the DIMM socket on main board(SBC87845).



**Step 2** Insert the DRAM to the DIMM socket, and then push it down firmly until it is clipped by the socket.

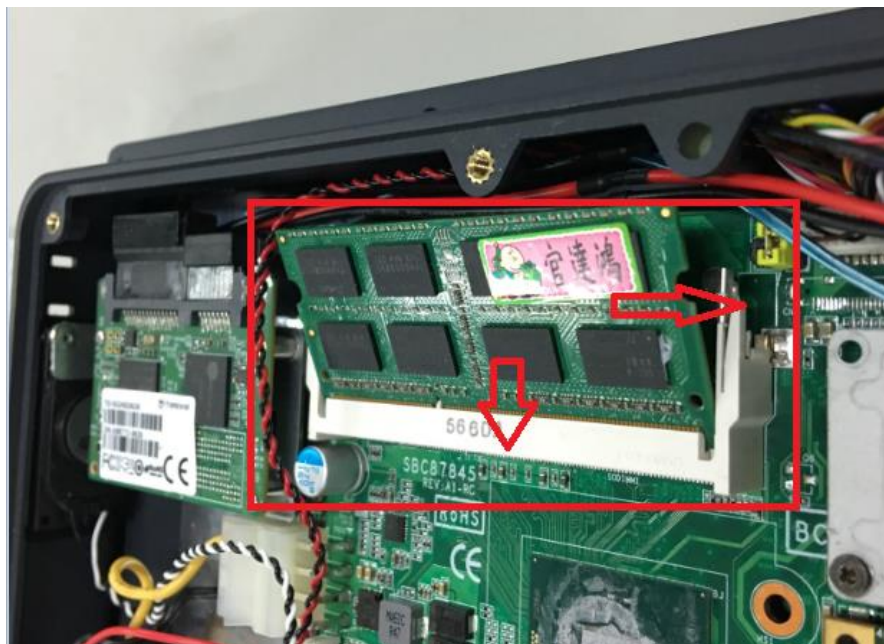

- Step 3** Install the memory module into the socket and push it firmly down until it is fully seated. The socket latches are levered upwards and clipped on to the edges of the DIMM.



## 2.6 Mini Card Installation

### 2.6.1 Wireless LAN Card Installation

The GOT5103W-845 provides two Mini card slots for user to install wireless LAN cards. You can choose either slot 1 or slot 2 to install the wireless LAN card and refer to the following instructions and illustration:

**Step 1** Open the back cover and find out the mini-card slot on main board.



**Step 2** Insert the wireless LAN card to the slot. Screw it firmly on the slot.

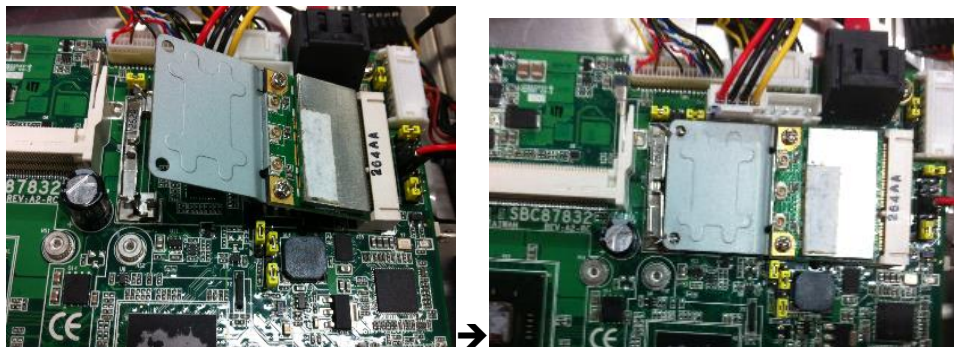



**Step 3** Sticks antenna cables on the chassis as below.

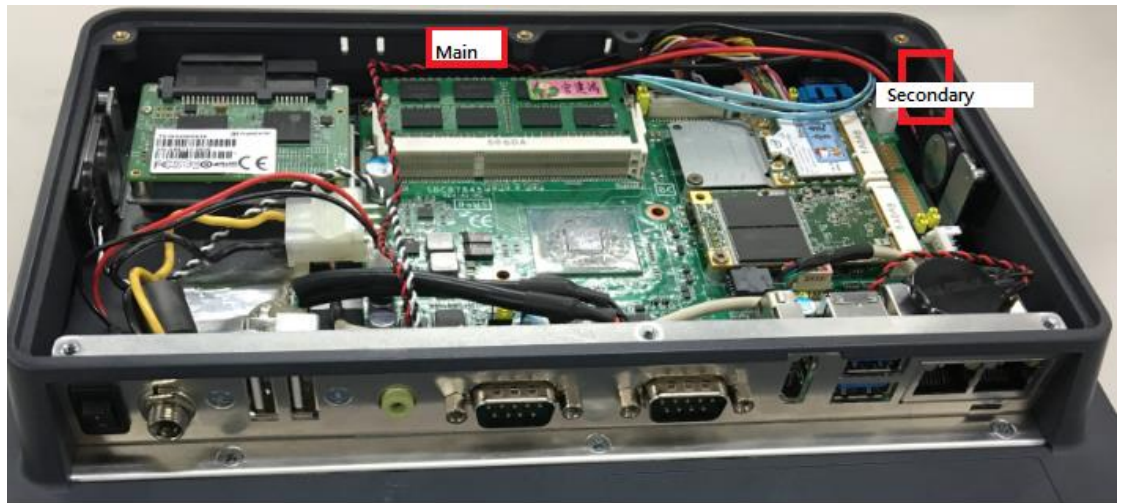

**Step 4** There are two connectors on wireless LAN card. One is MAIN, and the other is Secondary. Connect antenna cable to MAIN connector on wireless LAN card.

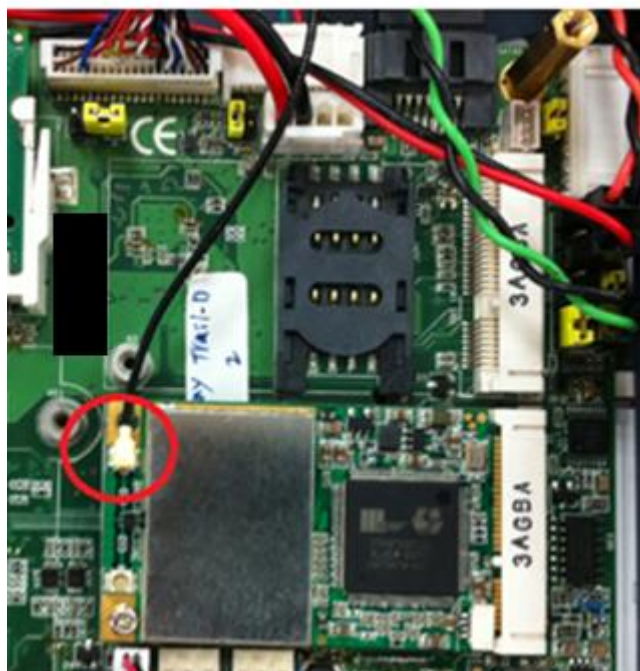



## 2.6.2 mSATA Card Installation

The GOT5103W-845 provides one Mini card slot for user to install mSATA. Please choose the slot 2 when installing the mSATA card and refer to the following instructions and illustration:

**Step 1** Open the back cover and find out the mini-card slot on main board.



**Step 2** Insert the mSATA card to the slot 2. Screw it firmly on the slot.



## 2.7 Power Input (Phoenix type)

GOT5103W-845 equips with a phoenix type power connector. It adopts 24VDC. Please follow the signs on power connector to connect DC power source.

+: Power positive      -: Power negative



**NOTE** The safety ground must be connected to ensure the unit working appropriately.

# Chapter 3

## AMI BIOS Setup Utility

This chapter provides users with detailed description how to set up basic system configuration through the AMIBIOS8 BIOS setup utility.

### 3.1 Navigation Keys

The BIOS setup/utility uses a key-based navigation system called hot keys. Most of the BIOS setup utility hot keys can be used at any time during the setup navigation process. These keys include <F1>, <F2>, <F3>, <F4>, <Enter>, <ESC>, <Arrow> keys, and so on.



**NOTE** Some of navigation keys differ from one screen to another.

<b>← Left/Right</b>	The Left and Right <Arrow> keys allow you to select a setup screen.
<b>↑↓ Up/Down</b>	The Up and Down <Arrow> keys allow you to select a setup screen or sub-screen.
<b>+– Plus/Minus</b>	The Plus and Minus <Arrow> keys allow you to change the field value of a particular setup item.
<b>Tab</b>	The <Tab> key allows you to select setup fields.
<b>F1</b>	The <F1> key allows you to display the General Help screen.
<b>F2</b>	The <F2> key allows you to load previous value
<b>F3</b>	The <F3> key allows you to Load Optimized Defaults.
<b>F4</b>	The <F4> key allows you to save any changes you have made and exit Setup. Press the <F4> key to save your changes.
<b>Esc</b>	The <Esc> key allows you to discard any changes you have made and exit the Setup. Press the <Esc> key to exit the setup without saving your changes.
<b>Enter</b>	The <Enter> key allows you to display or change the setup option listed for a particular setup item. The <Enter> key can also allow you to display the setup sub-screens.

## 3.2 Main Menu

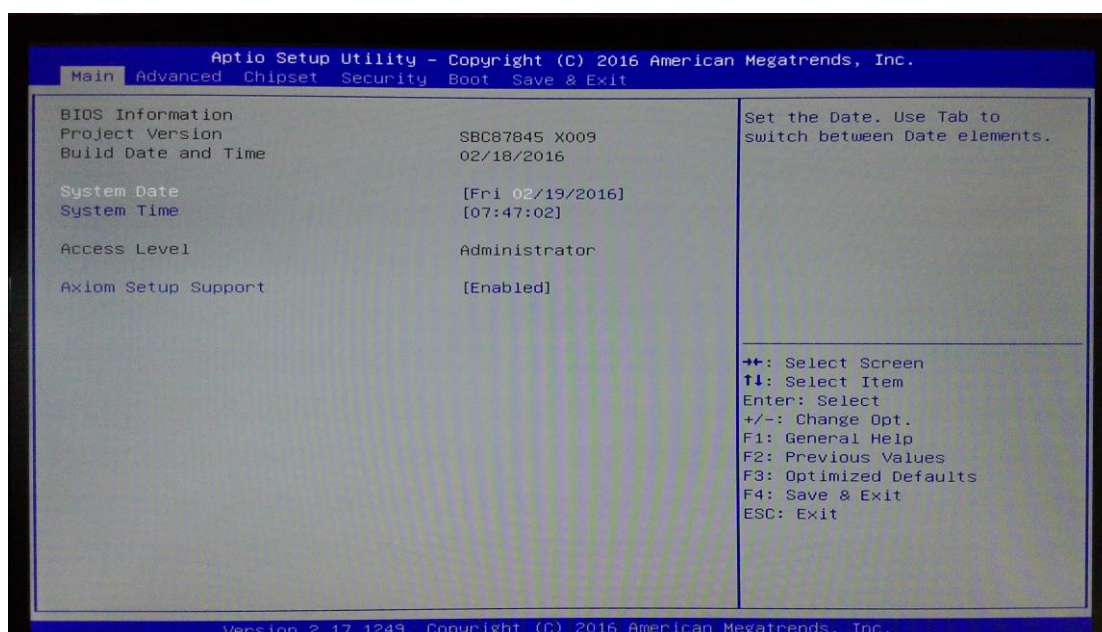

- **System Time/Date**

Use this option to change the system time and date. Highlight *System Time* or *System Date* using the <Arrow> keys. Enter new values through the keyboard. Press the <Tab> key or the <Arrow> keys to move between fields. The date must be entered in MM/DD/YY format. The time is entered in HH:MM:SS format.

### 3.3 Advanced Menu

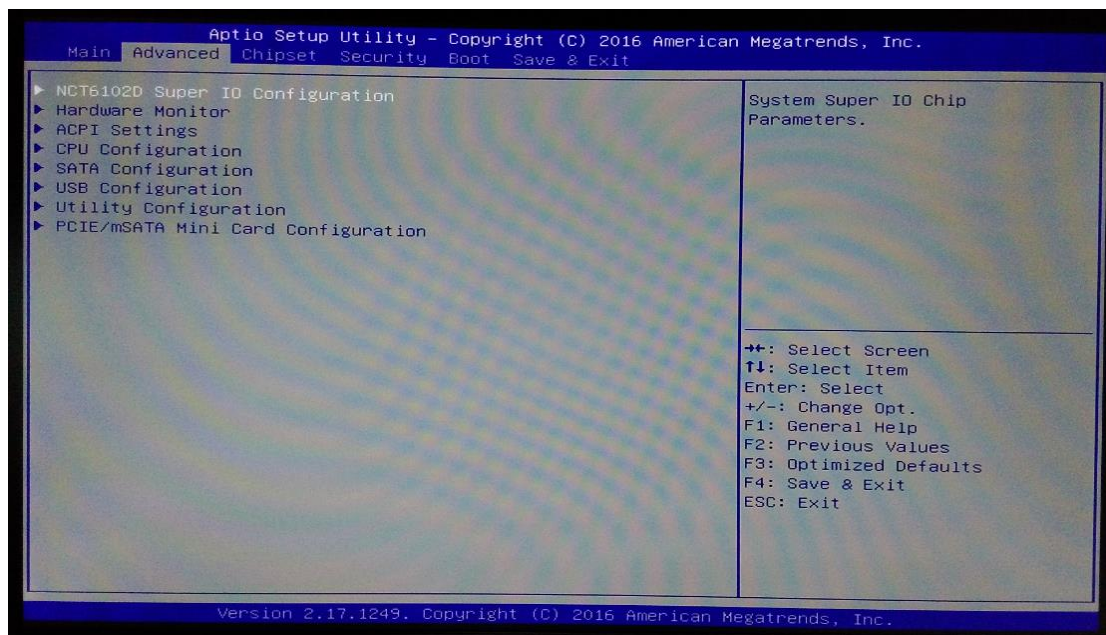

The Advanced menu allows users to set configuration of the CPU and other system devices. You can select any of the items in the left frame of the screen to go to the sub menus:

- NCT6106D Super IO Configuration
- Hardware Monitor
- ACPI Settings
- CPU Configuration
- SATA Configuration
- USB Configuration
- Utility Configuration
- PCIE/mSATA Mini Card Configuration

For items marked with “▶”, please press <Enter> for more options.



- **NCT6106D Super IO Configuration**

Use this screen to select options for the Super IO Configuration, and change the value of the selected option

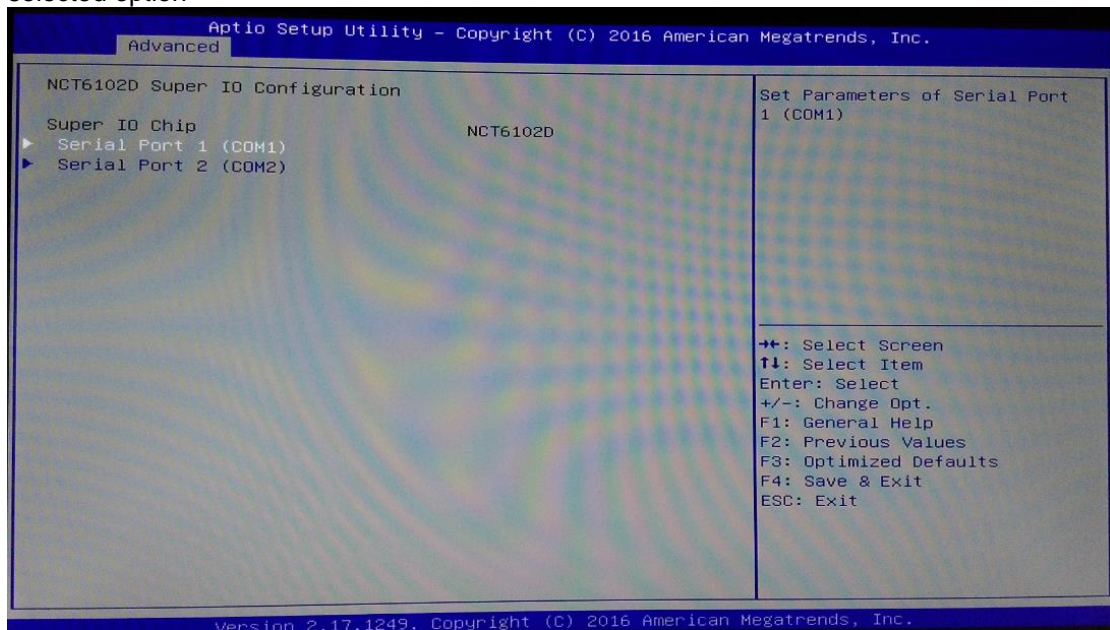

- **Serial Port 1-2 configuration**

**1. Serial port:**

This option used to enable or disable the serial port.

**2. Device Setting:**

This item specifies the base I/O port address and Interrupt Request address of serial port.

The port 1 Optimal setting is *3F8/IRQ4*.

The port 2 Optimal setting is *2E8/IRQ3*.

**3. Serial type:**

This option used to select RS232/422/485 function.

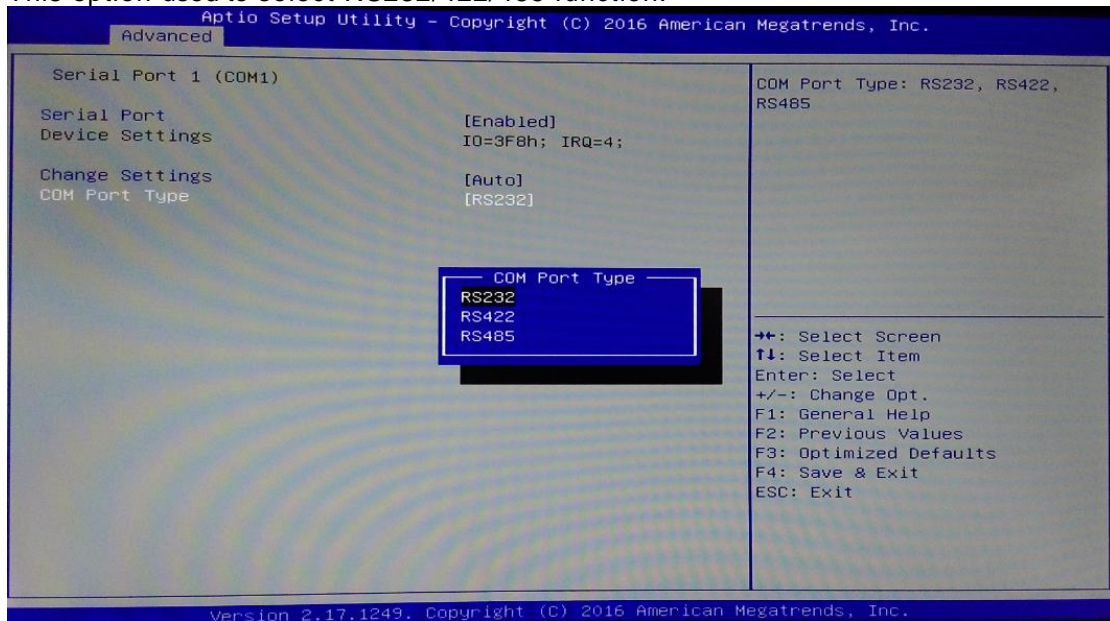

● **Hardware Monitor**

This screen shows the Hardware Health Status in real time.

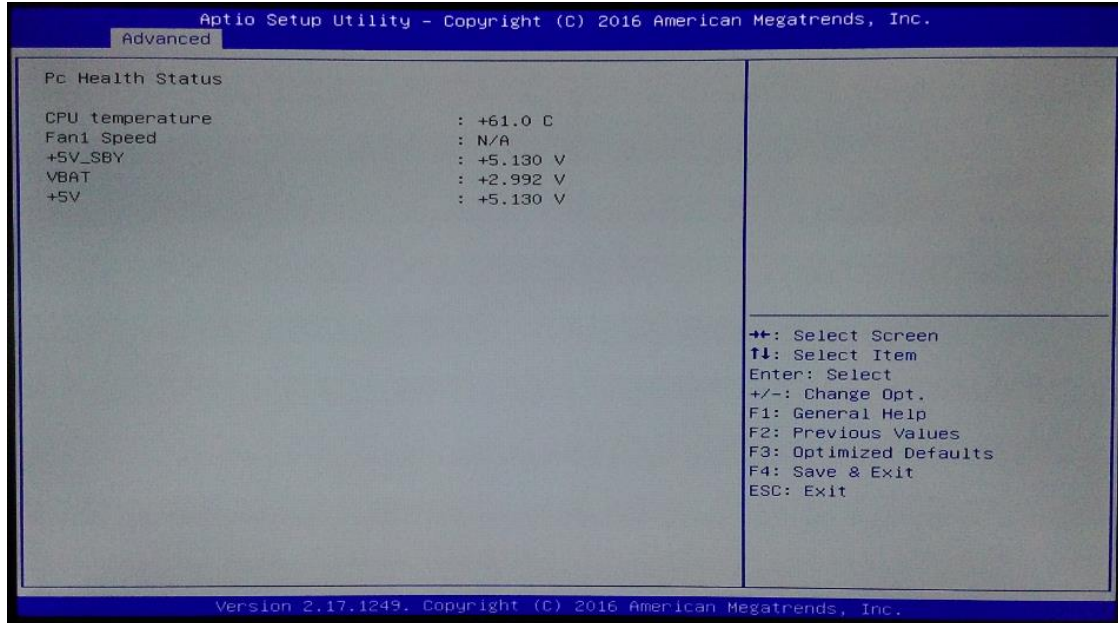

● **ACPI Settings**

You can use this screen to select options for the ACPI Configuration, and change the value of the selected option. A description of the selected item appears on the right side of the screen.

**ACPI Sleep State**

Allow you to select the Advanced Configuration and Power Interface (ACPI) state to be used for system suspend. Here are the options for your selection, Suspend disable and S3 (Suspend to RAM).

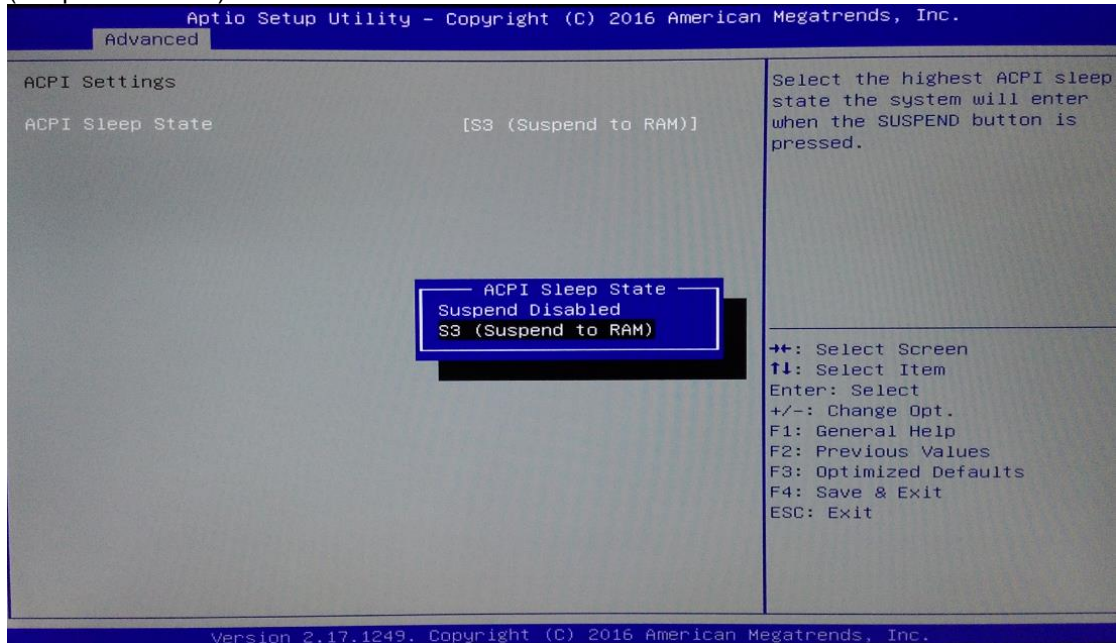



- **CPU Configuration**

This screen shows the CPU Configuration and intel virtualization technology enable/disable selected.

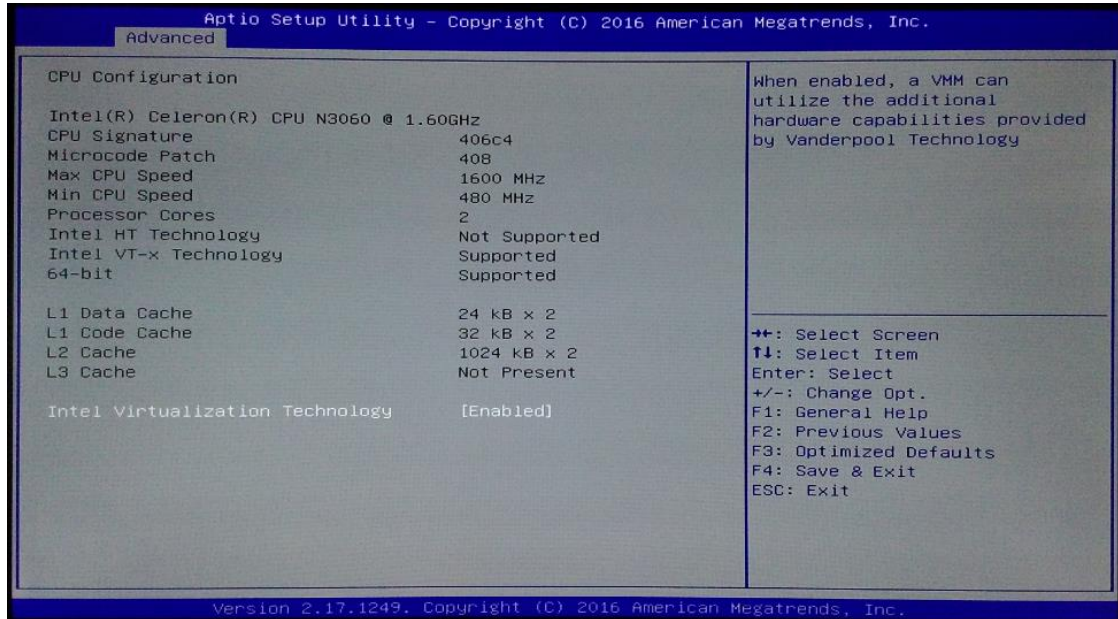

- **SATA Configuration**

You can use this screen to select options for the SATA Configuration, and change the value of the selected option.

- **SATA Controller**

Use this item to choose the SATA Controller. Here are the options for your selection, Enable, Disable.

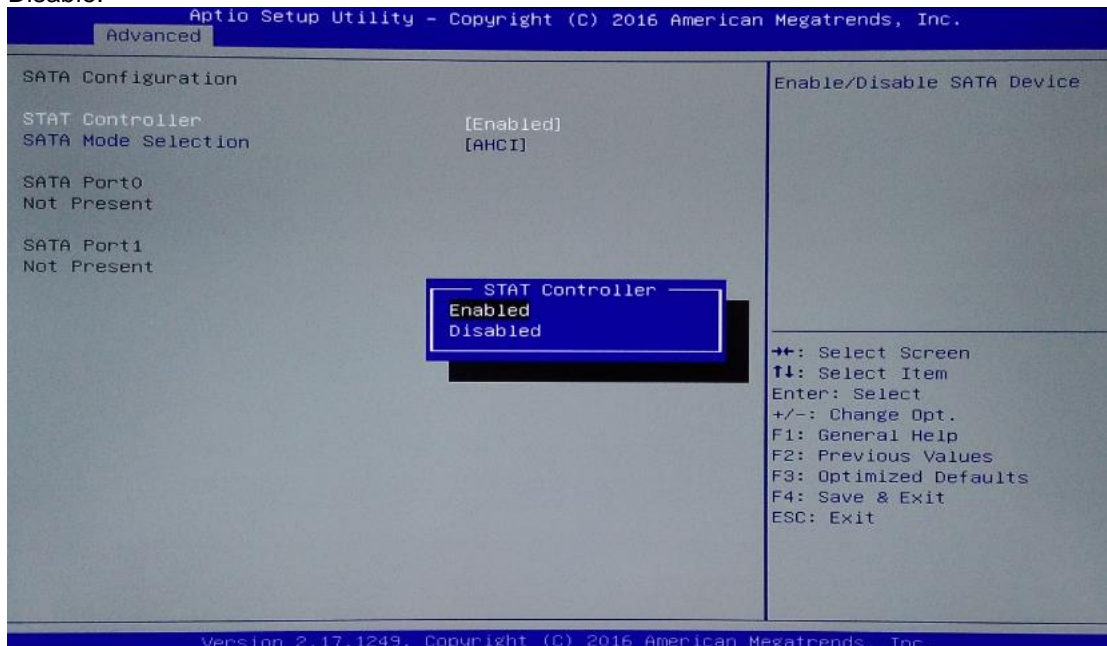

- **USB Configuration**

This screen shows the USB Configuration.

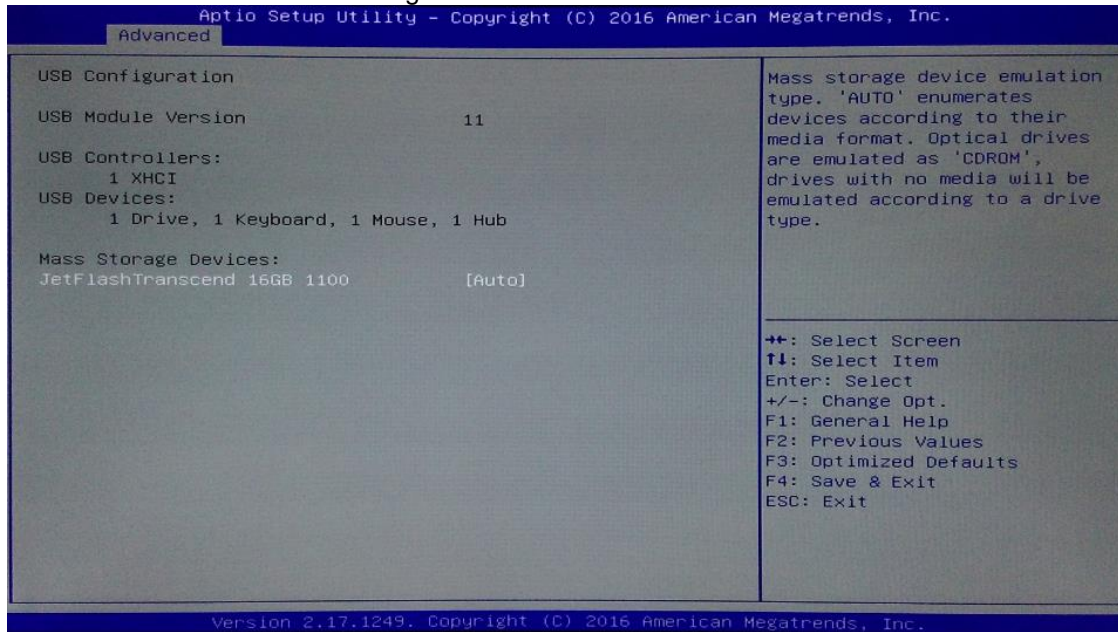

- **Utility Configuration**

This screen shows the Utility Configuration.

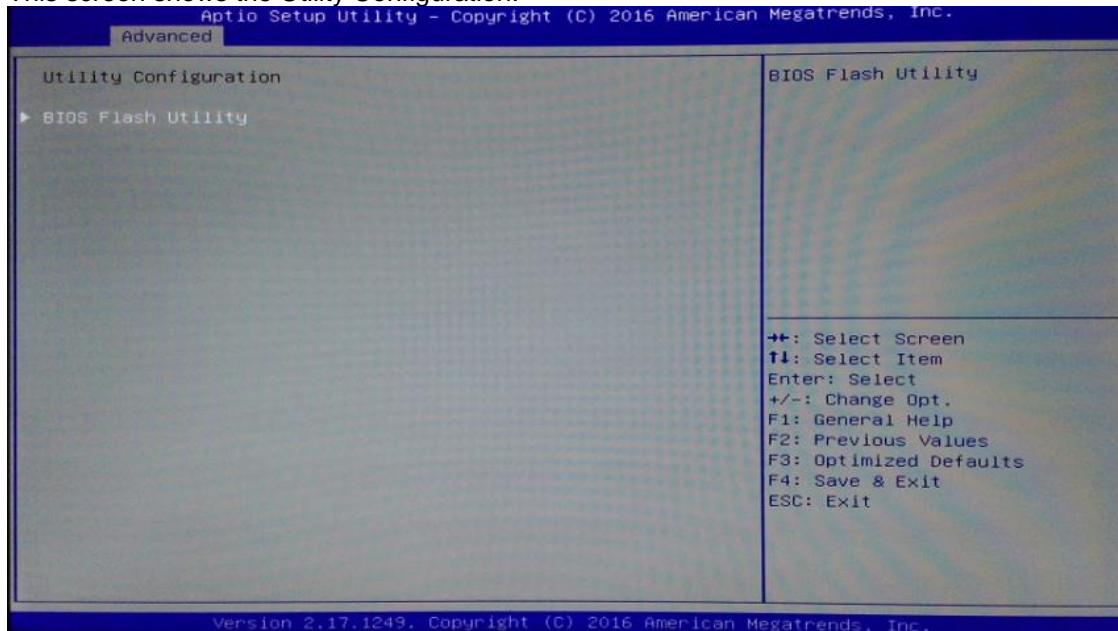

- **PCIE/mSATA Mini Card Configuration**

This screen shows the PCIE/mSATA Mini Card Configuration. Here are the options for your selection, PCIE, mSATA.

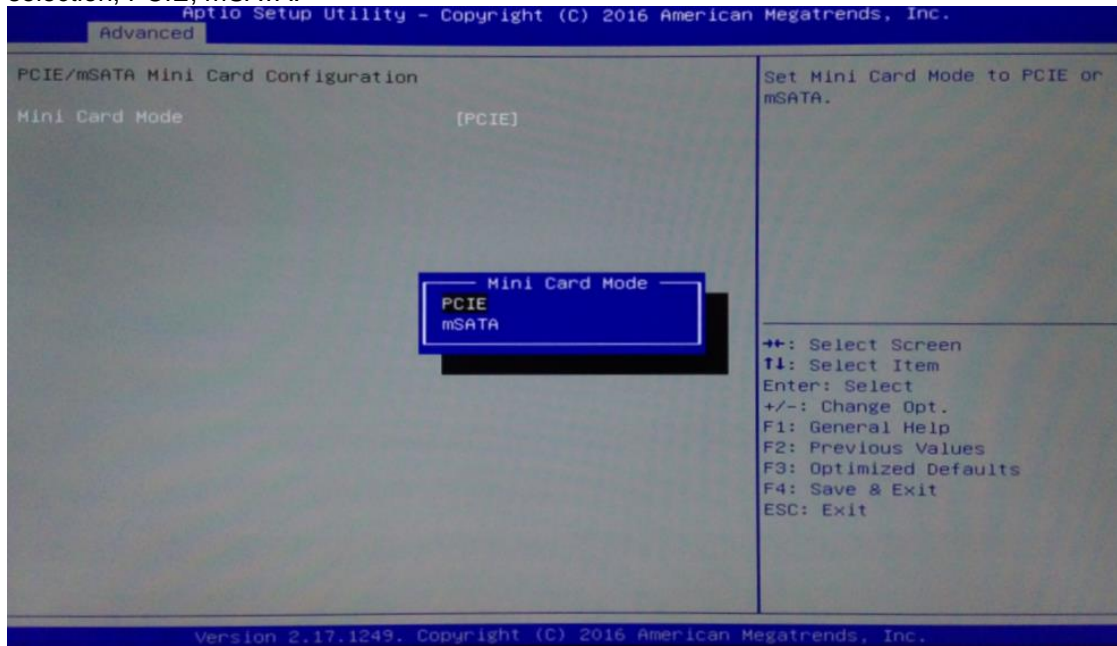



### 3.4 Chipset Menu

The Chipset menu gives the North Bridge memory information and South Bridge TXE information.

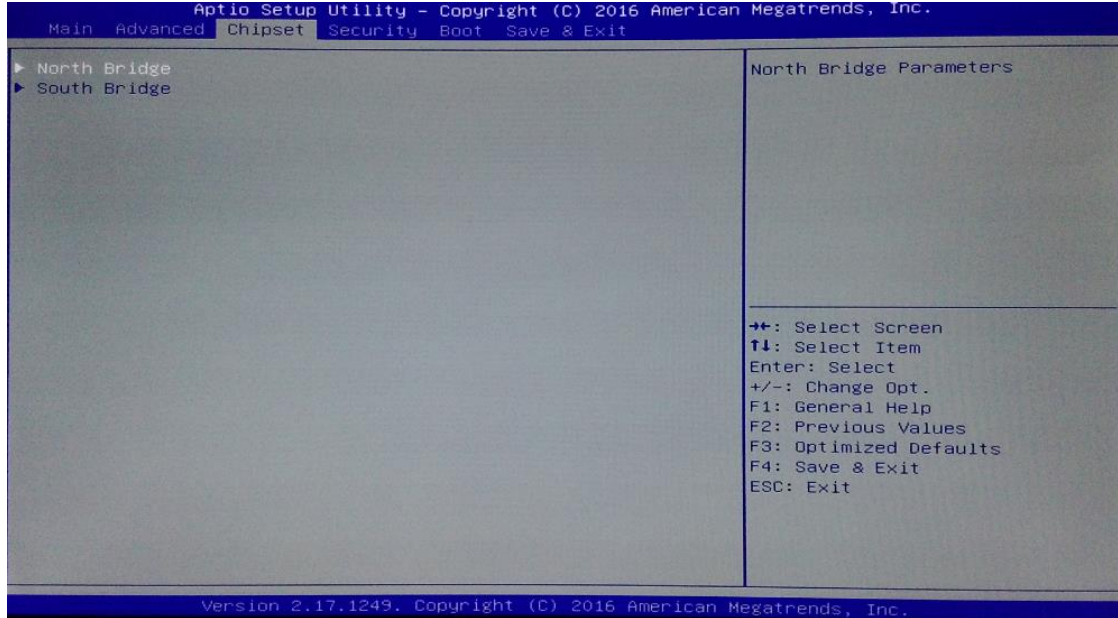

- **North Bridge**

This screen shows the North Bridge memory information.

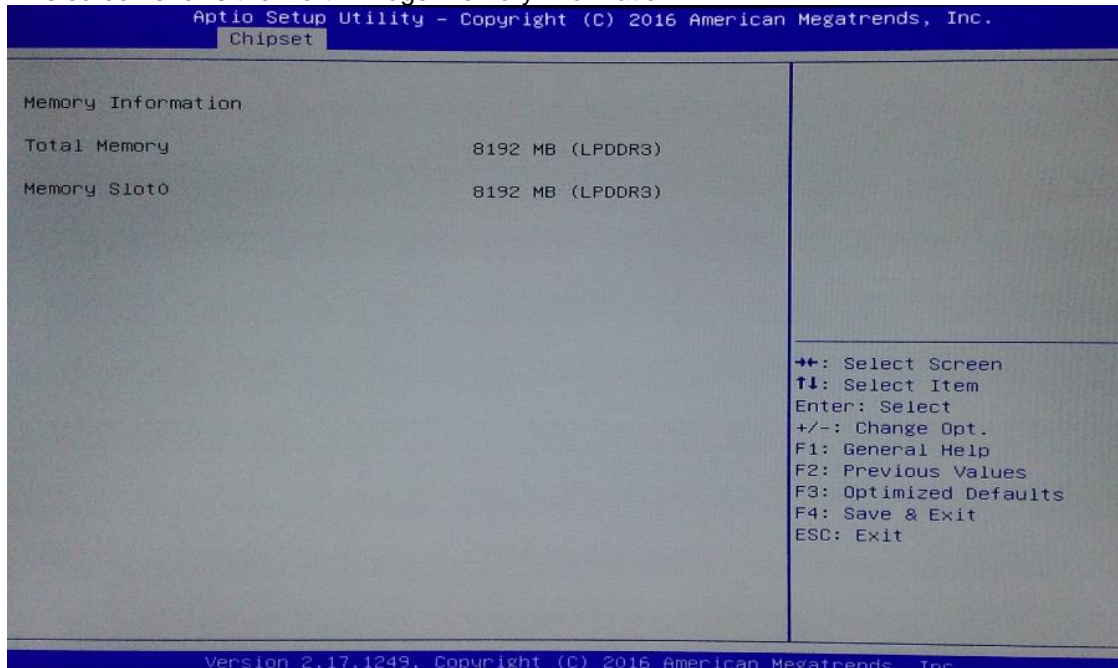

- **South Bridge**

This screen shows the South Bridge TXE information.

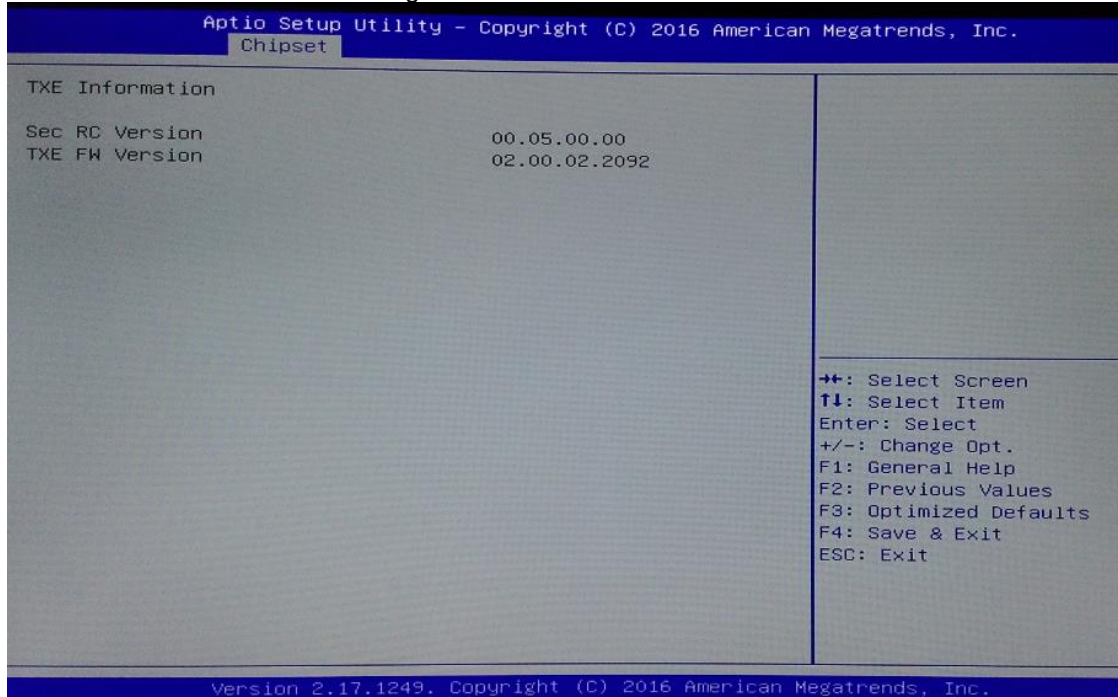

### 3.5 Security

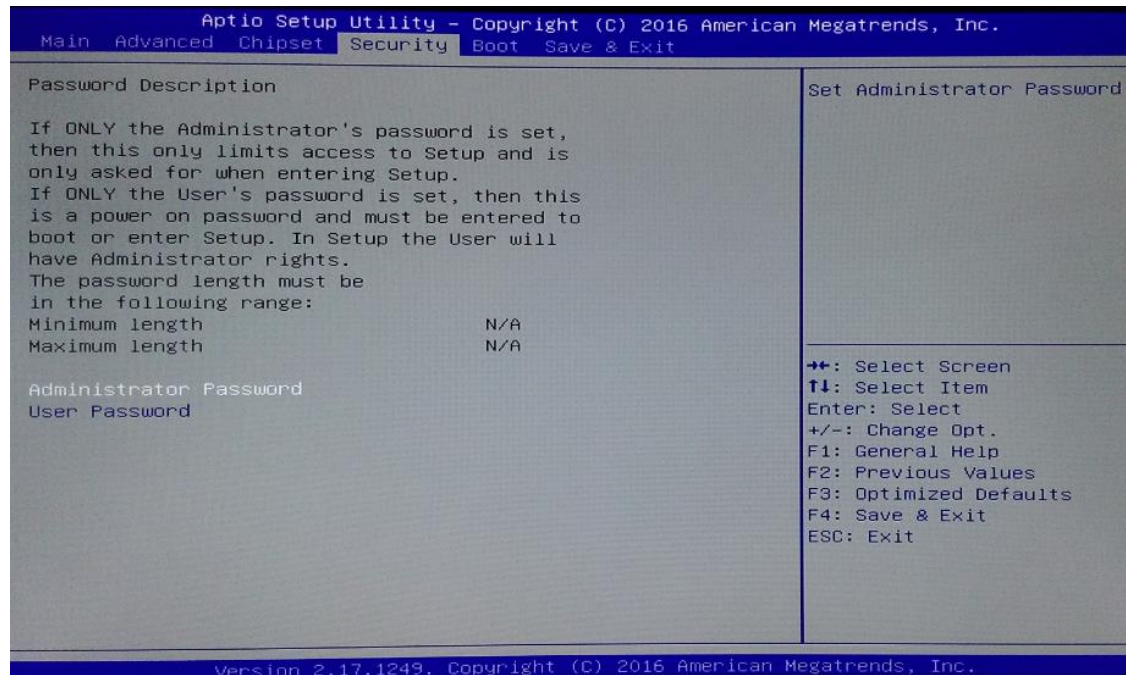

## 3.6 Boot Menu

The Boot menu allows users to change boot options of the system. You can select any of the items in the left frame of the screen to go to the sub menus:

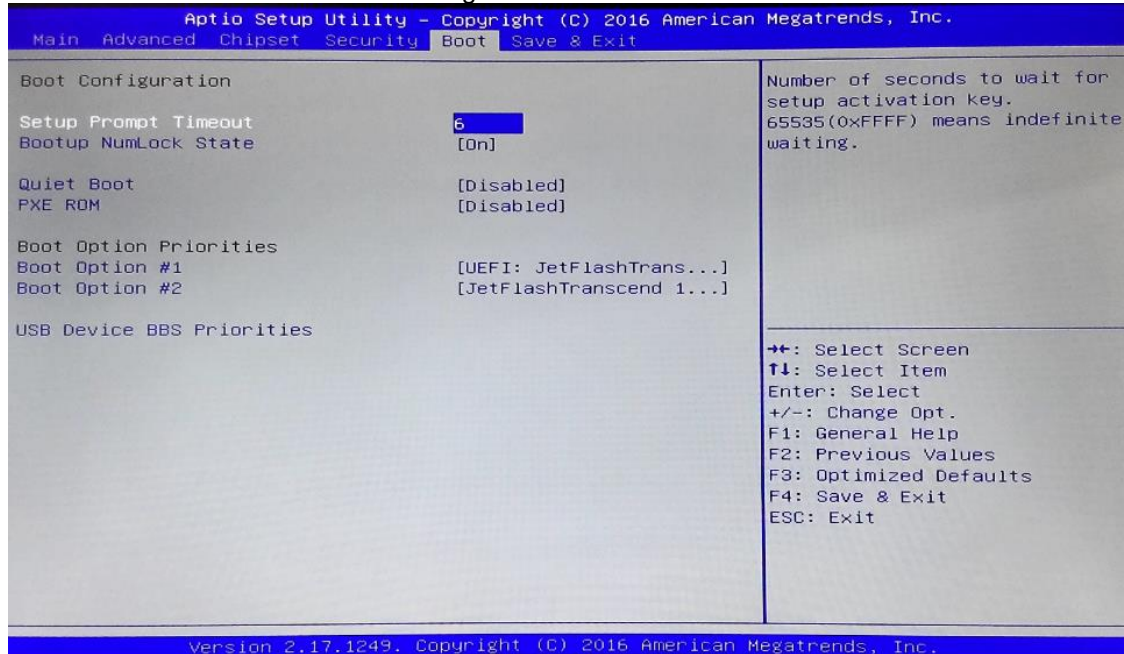

### Setup Prompt Timeout

Set the Timeout for wait press key to enter Setup Menu

### Bootup NumLock State

Use this item to select the power-on state for the NumLock. The default setting is on.

### Quiet Boot

Use this item to enable or disable the Quite Boot state. The default setting is disable.

### PXE ROM

Use this item to enable or disable the Preboot Execution Environment. The default setting is disable.

### Boot Option Priorities

Specifies the overall boot order from the available devices.

### 3.7 Save & Exit

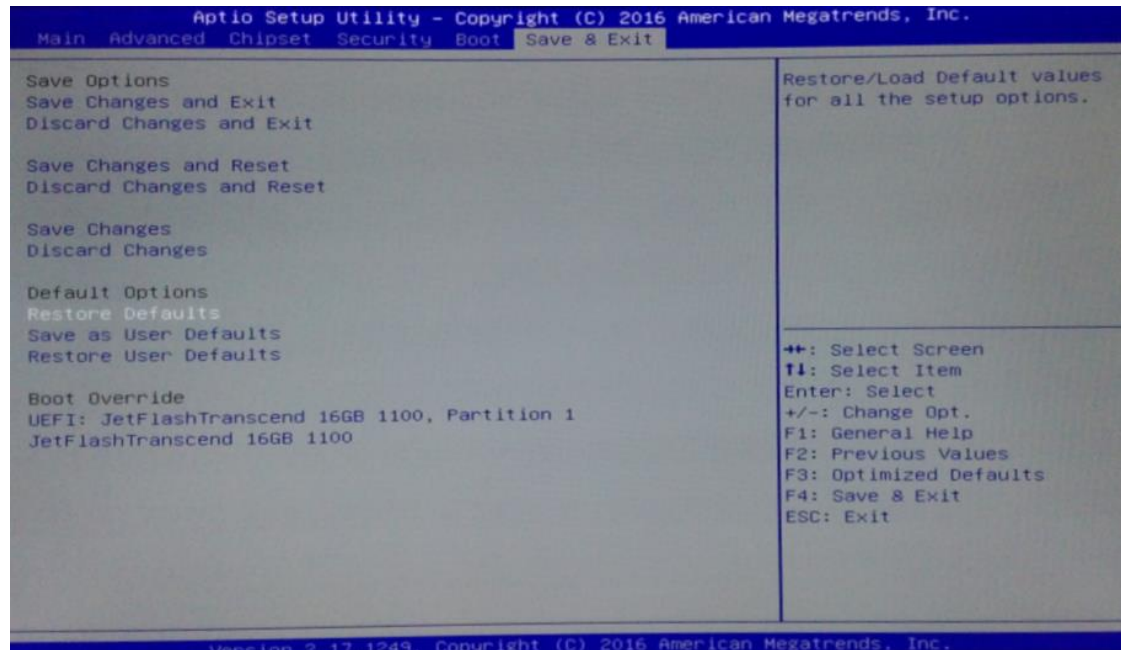



# Chapter 4

## Drivers Installation

### 4.1 System

GOT5103W-845 supports Windows 7, Windows 8.1, Windows 10 ,WES 7 and WE8S. To facilitate the installation of system driver, please carefully read the instructions in this chapter before start installing.

#### 4.1.1 Windows 7, 8.X, 10

1. Insert Driver CD and select the “\Drivers”.
2. Select all files and follow the installing procedure.

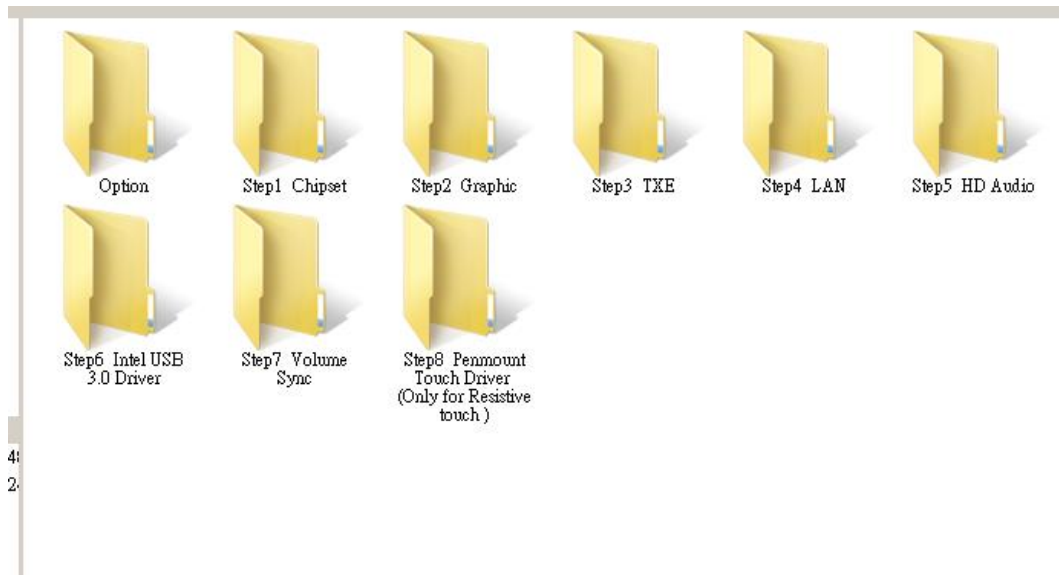

## 4.2 Touch Screen

The GOT5103W-845 uses projected capacitive multi-touch. There are the specification and driver installation which are listed below.

It also can drive the touch panel to get ten fingers touch function that based on the Windows 7 support.

### 4.2.1 Specification

<b>Touch Screen</b>	Projected capacitive multi-touch
<b>Touch Control Board</b>	COF
<b>Communications</b>	USB interface
<b>Power Supply</b>	5V
<b>Power Consumption</b>	40mA
<b>Input Method</b>	Finger or Cap.Stylus
<b>Resolution</b>	25ppi(Min.)_ Note: Base on WIN7 definition, ppi(Pixel per inch)
<b>Win7 USB Driver</b>	Non-Driver
<b>Calibration</b>	Non-Calibration



**NOTE** The projected capacitive multi-touch can drive the touch panel to get ten fingers touch function that based on the Windows 7 & Windows 8.x support.

### 4.2.2 Driver Installation- Windows 7/8.X/10

The GOT5103W-845 (resistive touch model) provides a touch screen driver that users can install it under the operating system Windows 7/8.x/10. To facilitate installation of the touch screen driver, you should read the instructions in this chapter carefully before you attempt installation.

1. Insert Driver CD and follow the path to select the “\Drivers\Step 8 – Penmount Touch driver

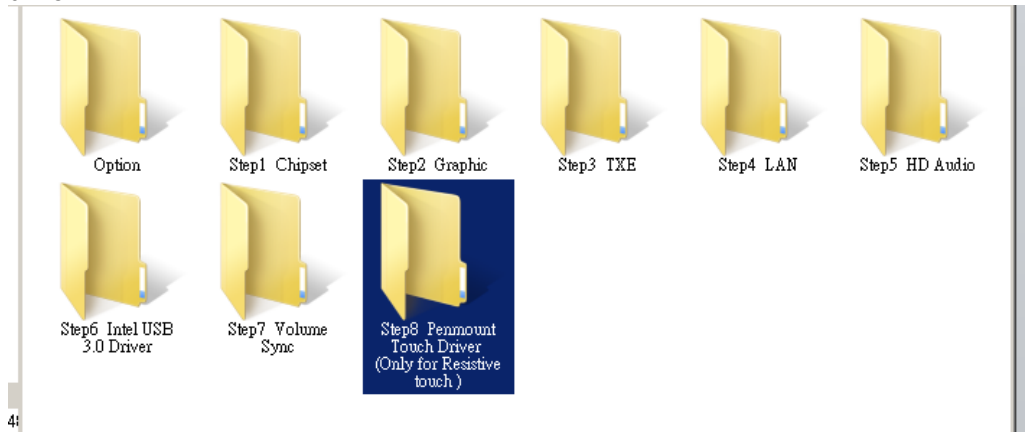

2. Follow the installing procedure and press OK.

## **4.3 Embedded O.S.**

The GOT5103W-845 provides the WES 7 and WE8S Embedded. The O.S. is supported devices which are listed below.

### **4.3.1 WES 7 & WE8S**

Here are supported onboard devices:

- Onboard Multi I/O
- Half-Sim SATA HDD
- USB
- CRT/LCD display
- 10/100/1000 base-T Ethernet
- mSATA
- Onboard Audio
- Touch Screen

**This page is intentionally left blank.**

# Appendix A

## Watchdog Timer & DIO Programming

### About Watchdog Timer

Software stability is major issue in most application. Some embedded systems are not watched by human for 24 hours. It is usually too slow to wait for someone to reboot when computer hangs. The systems need to be able to reset automatically when things go wrong. The watchdog timer gives us solution.

The watchdog timer is a counter that triggers a system reset when it counts down to zero from a preset value. The software starts counter with an initial value and must reset it periodically. If the counter ever reaches zero which means the software has crashed, the system will reboot.

### How to Use Watchdog Timer

The I/O port base addresses of watchdog timer are 2E (hex) and 2F (hex). The 2E (hex) and 2F (hex) are address and data port respectively.

Assume that program A is put in a loop that must execute at least once every 10ms. Initialize watchdog timer with a value bigger than 10ms. If the software has no problems; watchdog timer will never expire because software will always restart the counter before it reaches zero.

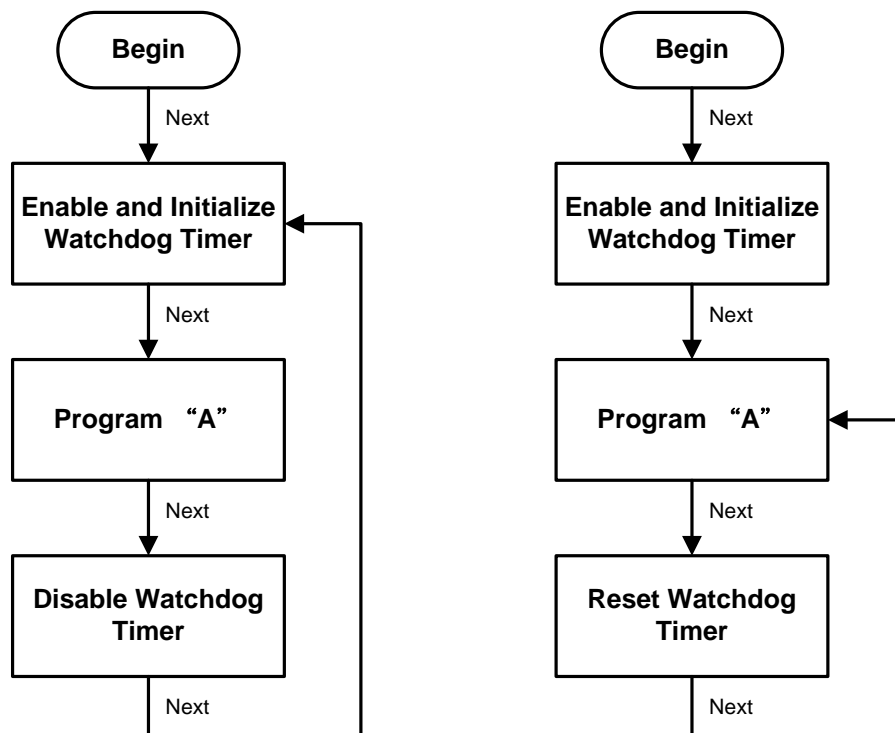

**WDT Sample Program**

**Enable WDT**

**1.Enable configuration**

- O 2E 87
- O 2E 87

**2. Select Logic device:**

- O 2E 07
- O 2F 08

**3. WDT Device Enable**

- O 2E 30
- O 2F 01

**4. Set timer unit**

- O 2E F0
- O 2F 00 → (00: Sec; 08: Minute)

**5. Set base timer:**

- O 2E F1
- O 2F 0A → Set Reset Time (Ex.0A:10 Sec)

**Disable WDT**

**1.Enable configuration**

- O 2E 87
- O 2E 87

**2. Select Logic device:**

- O 2E 07
- O 2F 08

**3. WDT Device Disable**

- O 2E 30
- O 2F 00

## How to Use DIO Software Programming

### Digital I/O Software Programming

- I2C to GPIO PCA9554
- I2C address: 0b01000000.

#### Register 0 - Input Port register

This register is a read-only port. It reflects the incoming logic levels of the pins, regardless of whether the pin is defined as an input or an output by Register 3. Writes to this register have no effect.

The default 'X' is determined by the externally applied logic level, normally '1' when no external signal externally applied because of the internal pull-up resistors.

**Table 4. Register 0 - Input Port register bit description**

Bit	Symbol	Access	Value	Description
7	I7	read only	X	determined by externally applied logic level
6	I6	read only	X	
5	I5	read only	X	
4	I4	read only	X	
3	I3	read only	X	
2	I2	read only	X	
1	I1	read only	X	
0	I0	read only	X	

#### Register 1 - Output Port register

This register reflects the outgoing logic levels of the pins defined as outputs by Register 3. Bit values in this register have no effect on pins defined as inputs. Reads from this register return the value that is in the flip-flop controlling the output selection, **not** the actual pin value.

**Table 5. Register 1 - Output Port register bit description**

*Legend: \* default value.*

Bit	Symbol	Access	Value	Description
7	O7	R	1*	reflects outgoing logic levels of pins defined as outputs by Register 3
6	O6	R	1*	
5	O5	R	1*	
4	O4	R	1*	
3	O3	R	1*	
2	O2	R	1*	
1	O1	R	1*	
0	O0	R	1*	

## Register 2 - Polarity Inversion register

This register allows the user to invert the polarity of the Input Port register data. If a bit in this register is set (written with '1'), the corresponding Input Port data is inverted. If a bit in this register is cleared (written with a '0'), the Input Port data polarity is retained.

**Table 6. Register 2 - Polarity Inversion register bit description**

Legend: \* default value.

Bit	Symbol	Access	Value	Description
7	N7	R/W	0*	inverts polarity of Input Port register data
6	N6	R/W	0*	0 = Input Port register data retained (default value)
5	N5	R/W	0*	1 = Input Port register data inverted
4	N4	R/W	0*	
3	N3	R/W	0*	
2	N2	R/W	0*	
1	N1	R/W	0*	
0	N0	R/W	0*	

## Register 3 - Configuration register

This register configures the directions of the I/O pins. If a bit in this register is set, the corresponding port pin is enabled as an input with high-impedance output driver. If a bit in this register is cleared, the corresponding port pin is enabled as an output. At reset, the I/Os are configured as inputs with a weak pull-up to  $V_{DD}$ .

**Table 7. Register 3 - Configuration register bit description**

Legend: \* default value.

Bit	Symbol	Access	Value	Description
7	C7	R/W	1*	configures the directions of the I/O pins
6	C6	R/W	1*	0 = corresponding port pin enabled as an output
5	C5	R/W	1*	1 = corresponding port pin configured as input (default value)
4	C4	R/W	1*	
3	C3	R/W	1*	
2	C2	R/W	1*	
1	C1	R/W	1*	
0	C0	R/W	1*	



# Appendix B

## Volume Control

### About Volume Control

Axiomtek offers the volume control tool under Windows 7 Windows 8 and Windows 10, people can adjust the system volume depending on your personal taste and the amount of ambient volume in the room after installing the volume control tool.

### How to Use Volume Control

**Step 1** According to the OS version, please insert the driver CD and follow the path to select the proper driver, Driver\Step 7 – VolumeSync”

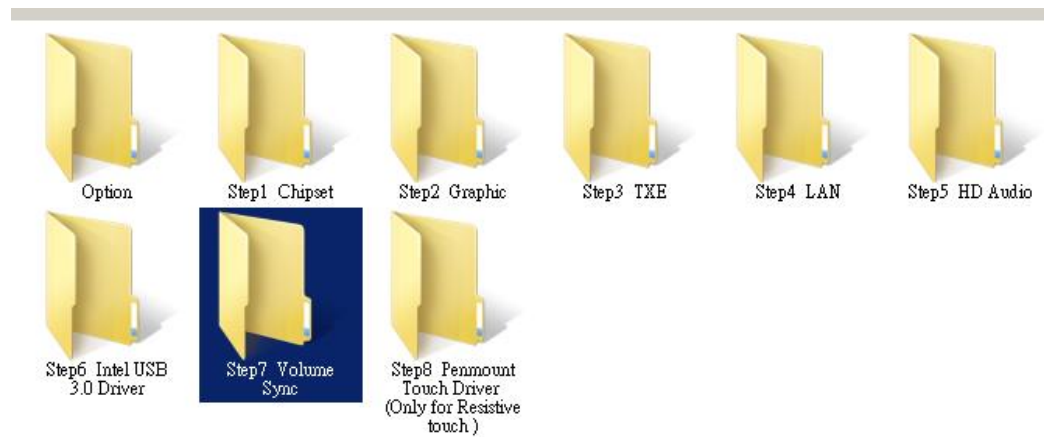

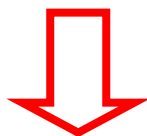
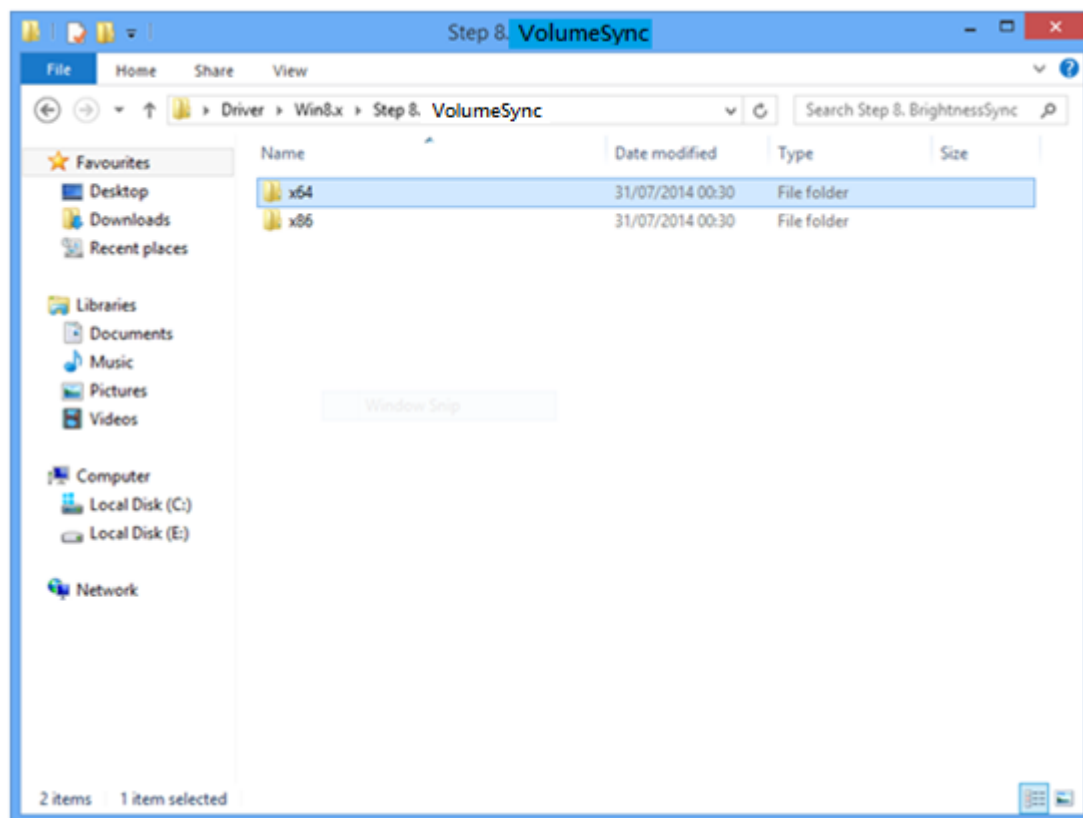

名稱	修改日期	類型	大小
VC	2015/10/30 下午...	檔案資料夾	
ReadMe.txt	2015/9/23 下午 0...	文字文件	1 KB
Setup.bat	2015/9/23 下午 0...	Windows 批次檔案	2 KB

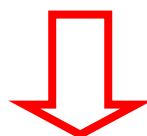

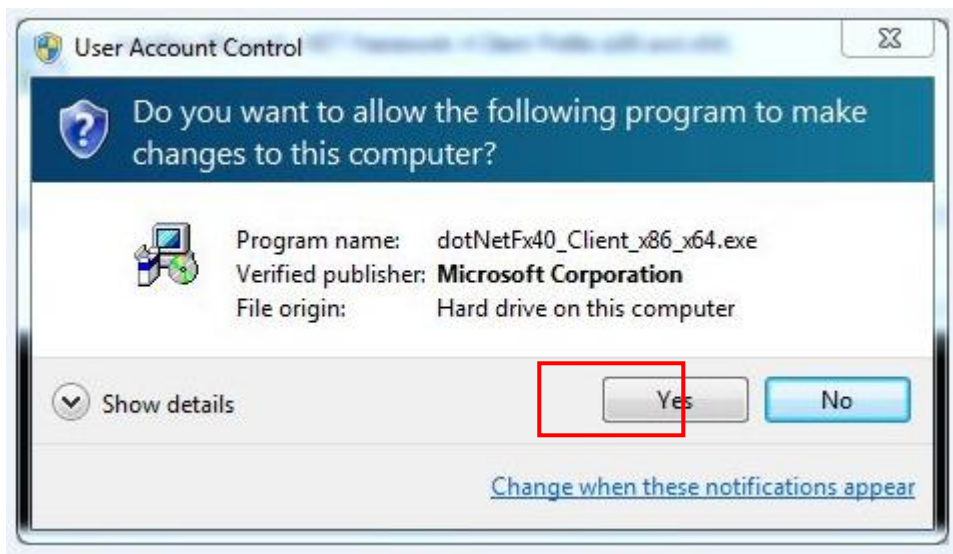
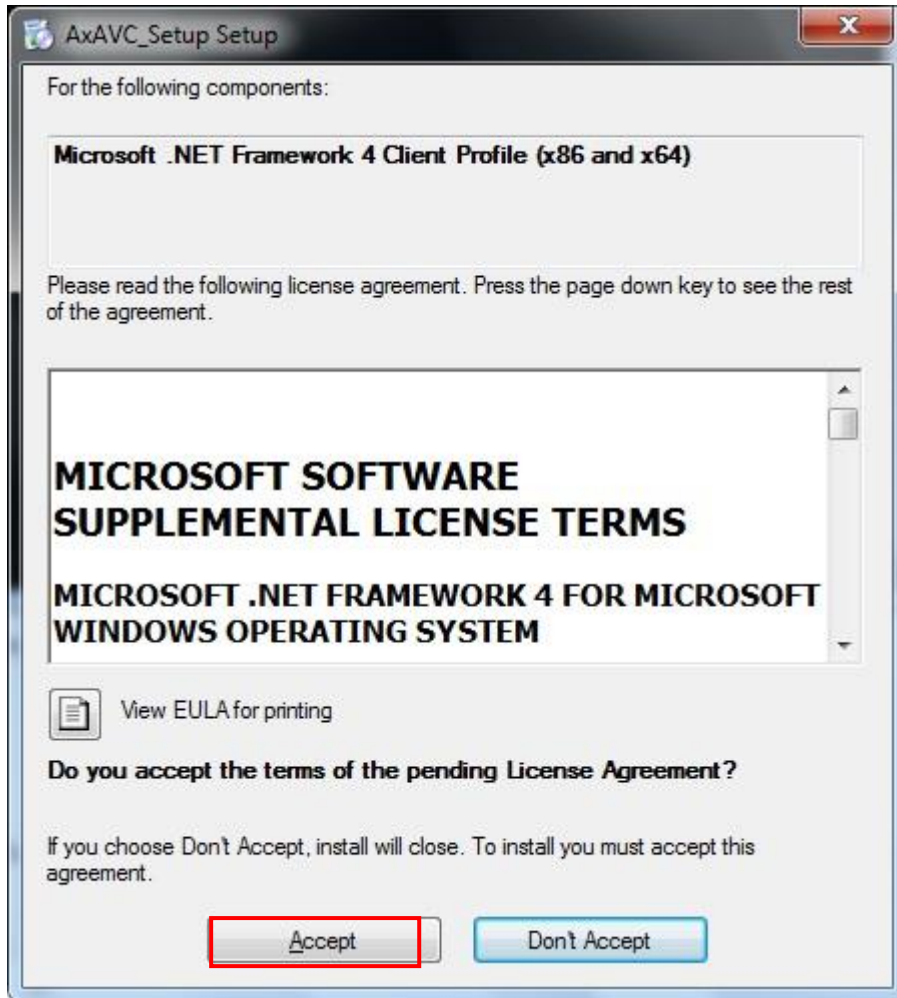

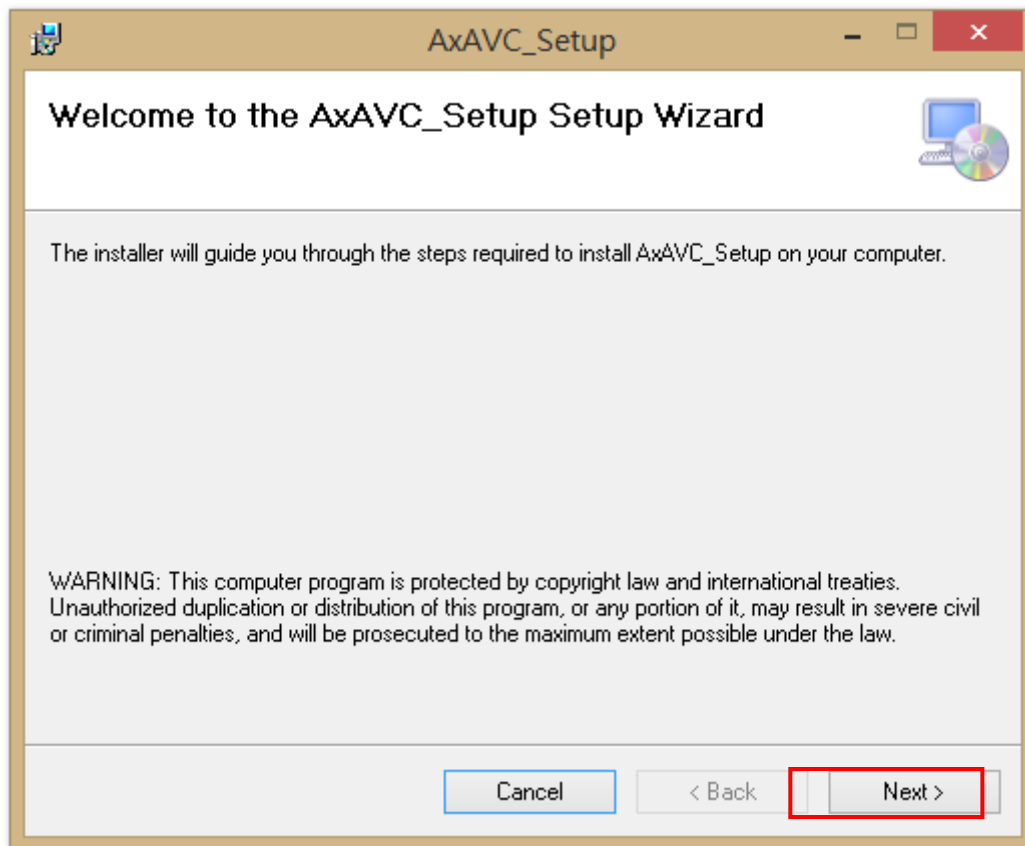
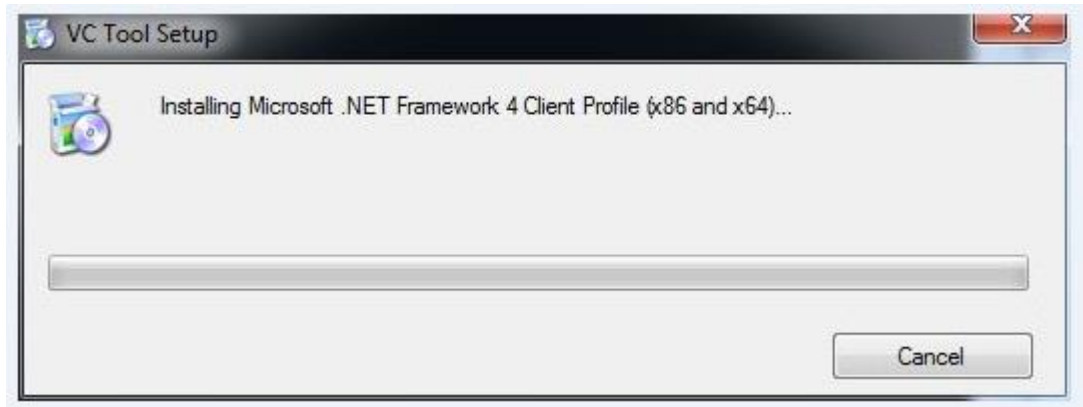

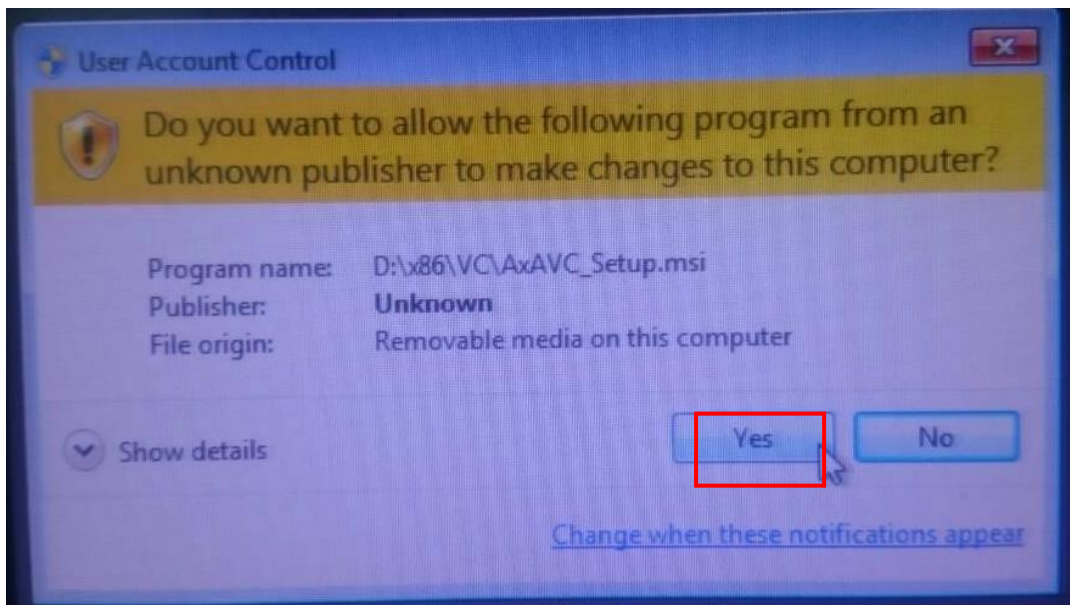
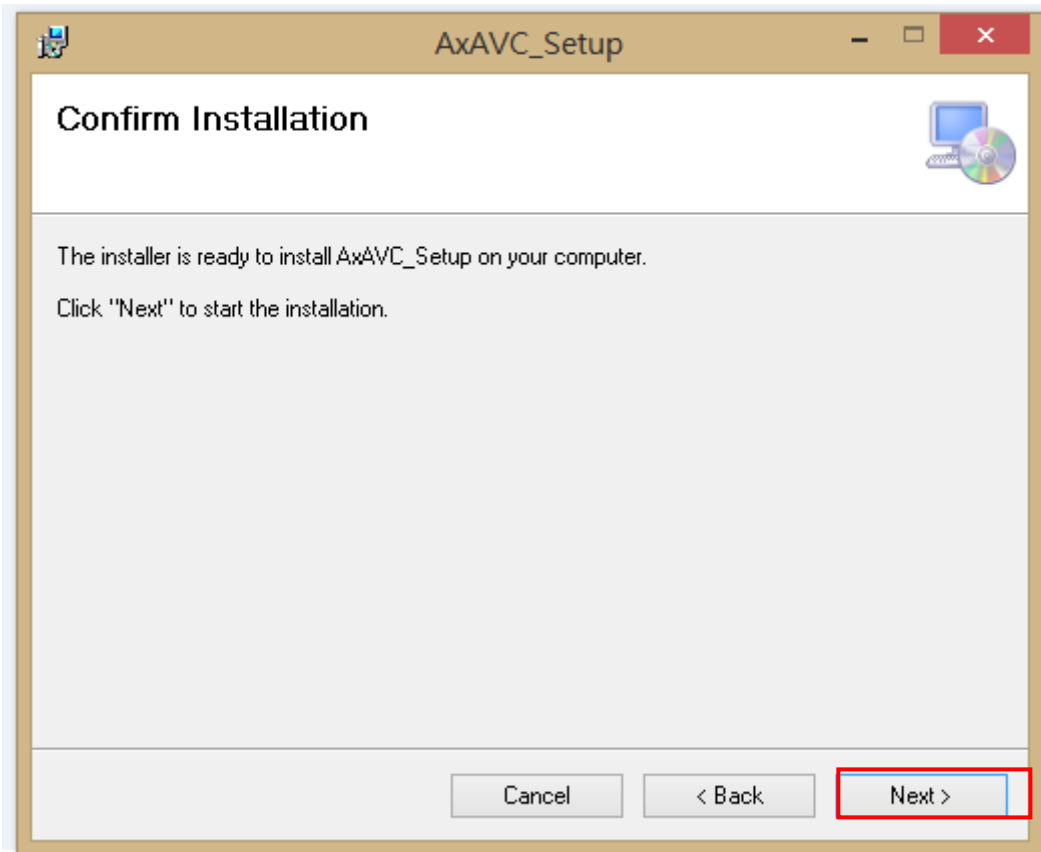

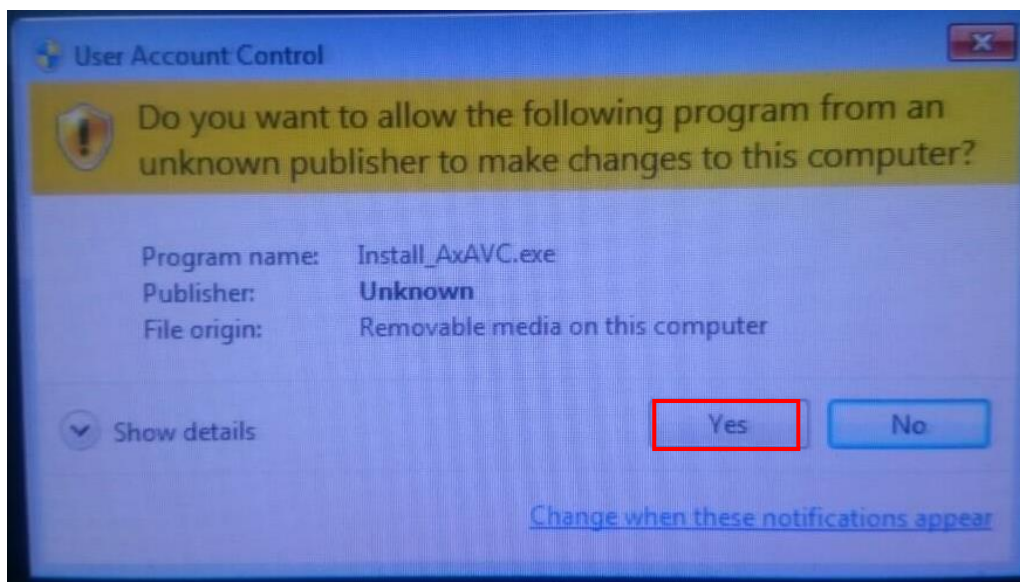
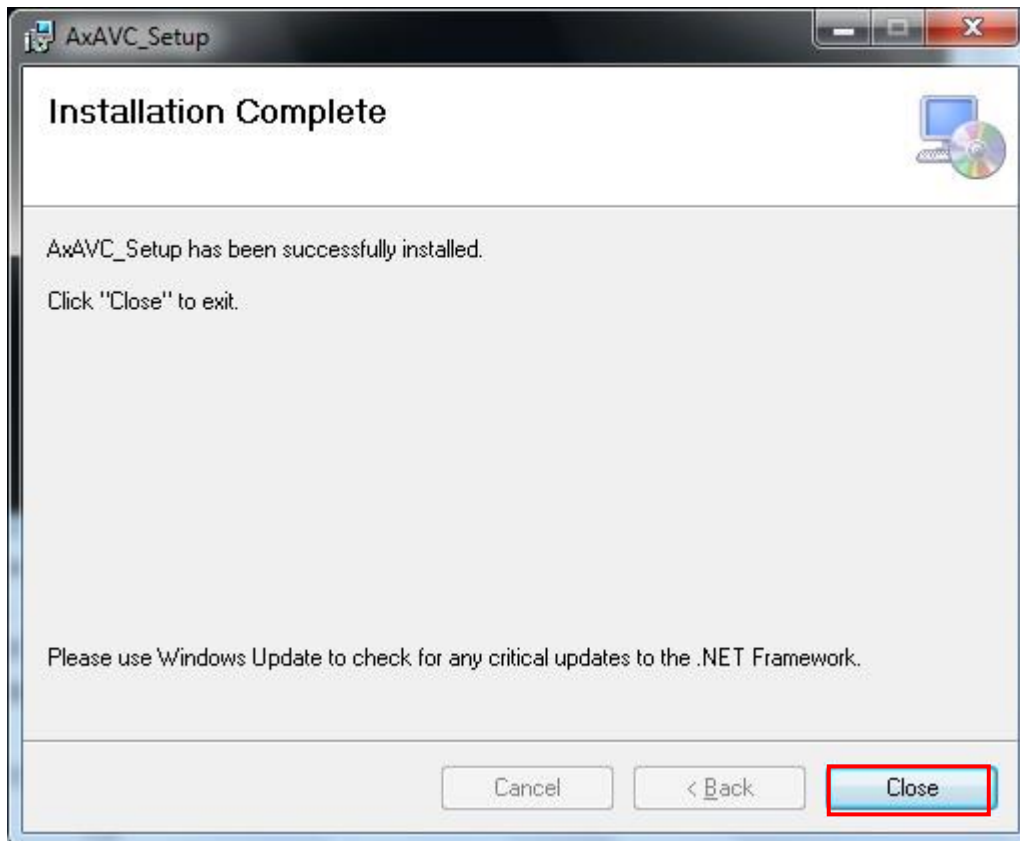

**Step 2** System auto reboot, installation completed.

**Step 3** Select “△” icon then finding out the “Axiomtek” to ensure the volume driver is installed appropriately.



**Step 4** How to use the Volume Control

Select volume +/- to adjust the system volume.



## Removed Volume Control Tool

**Step 1** Go to Control Panel -> Programs -> Programs and Features. Select Uninstall on AxAVC\_Setup.

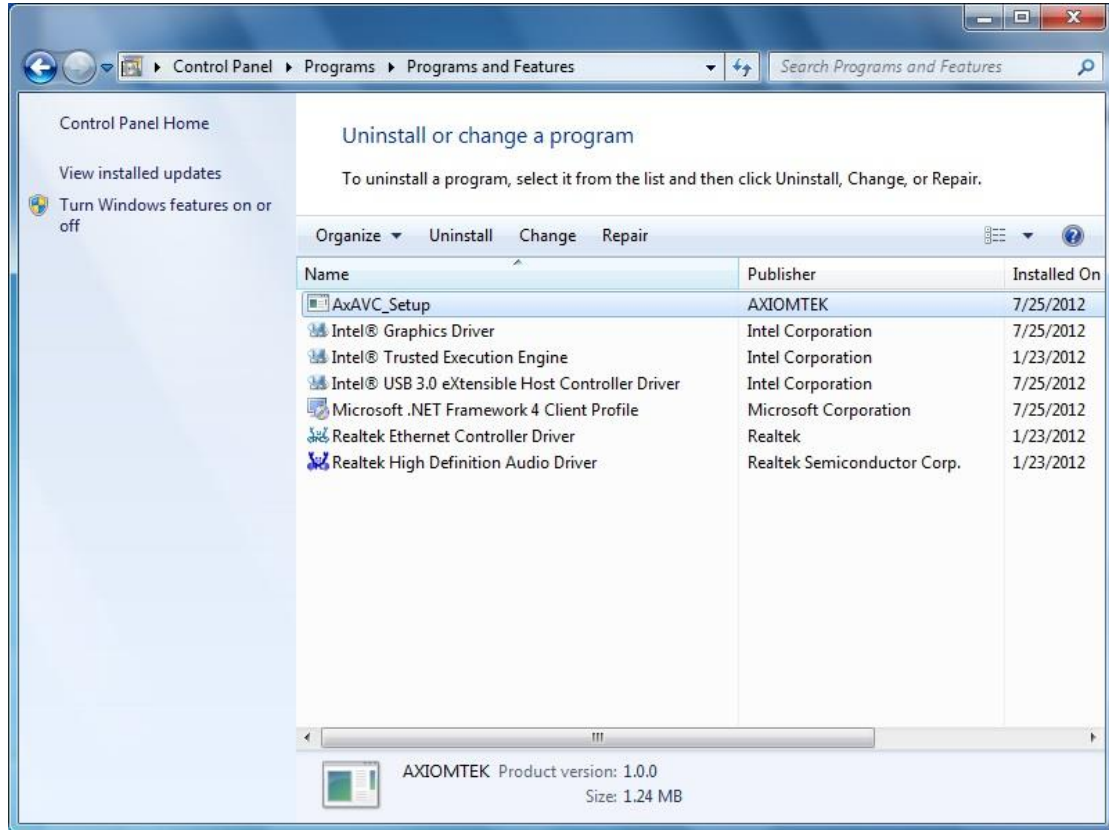



Step 2 Follow the procedures and press "Close".

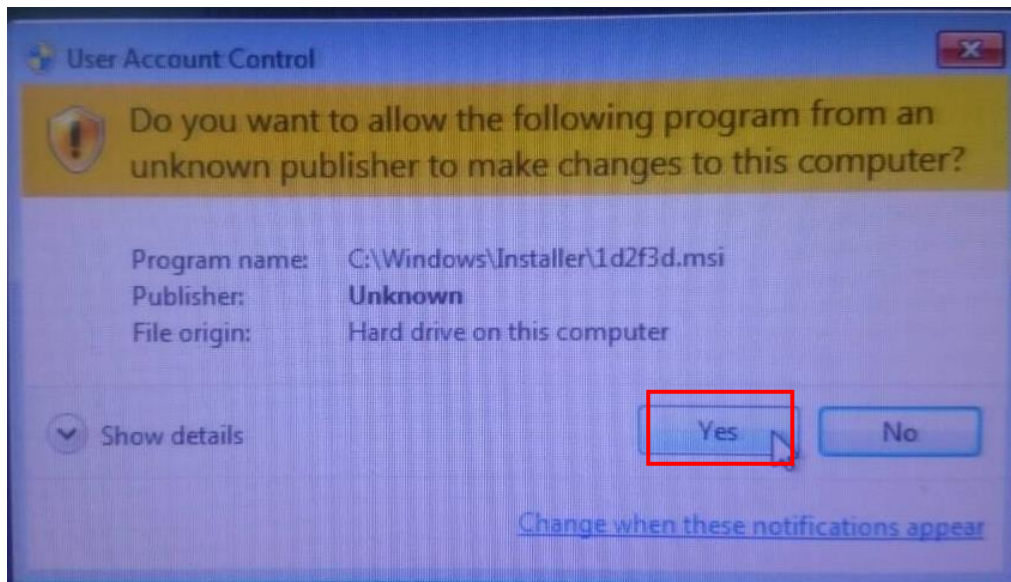
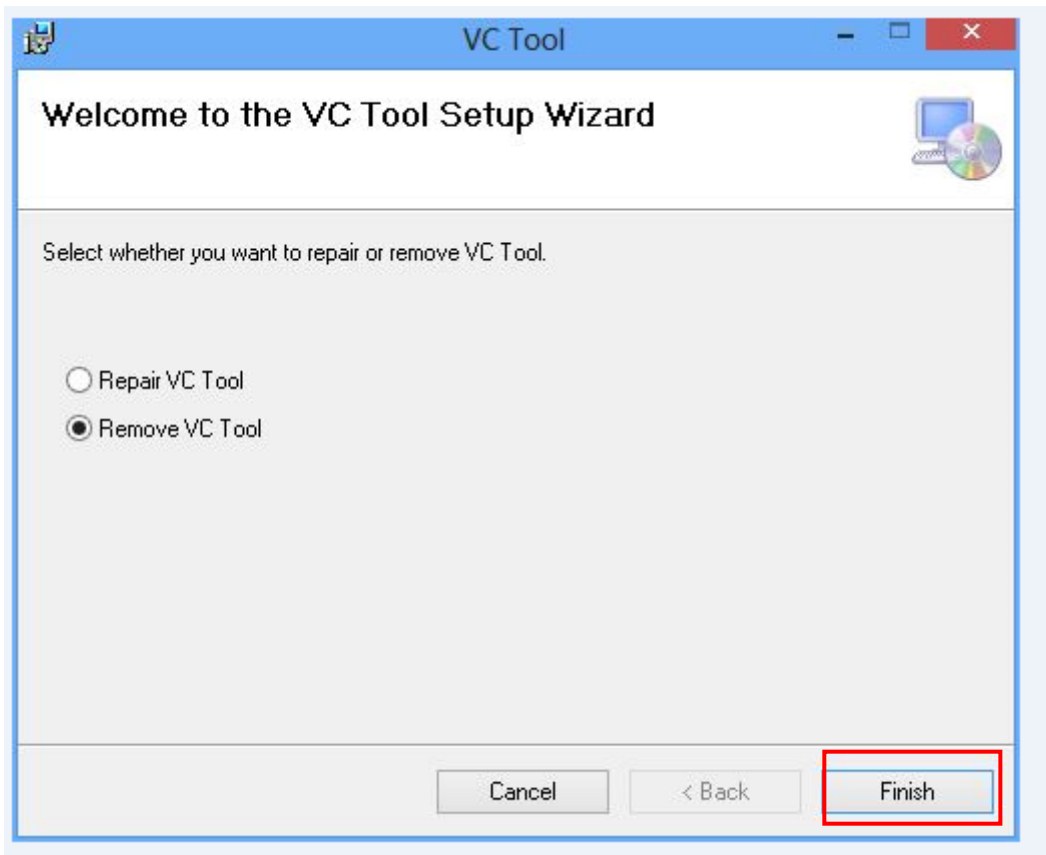

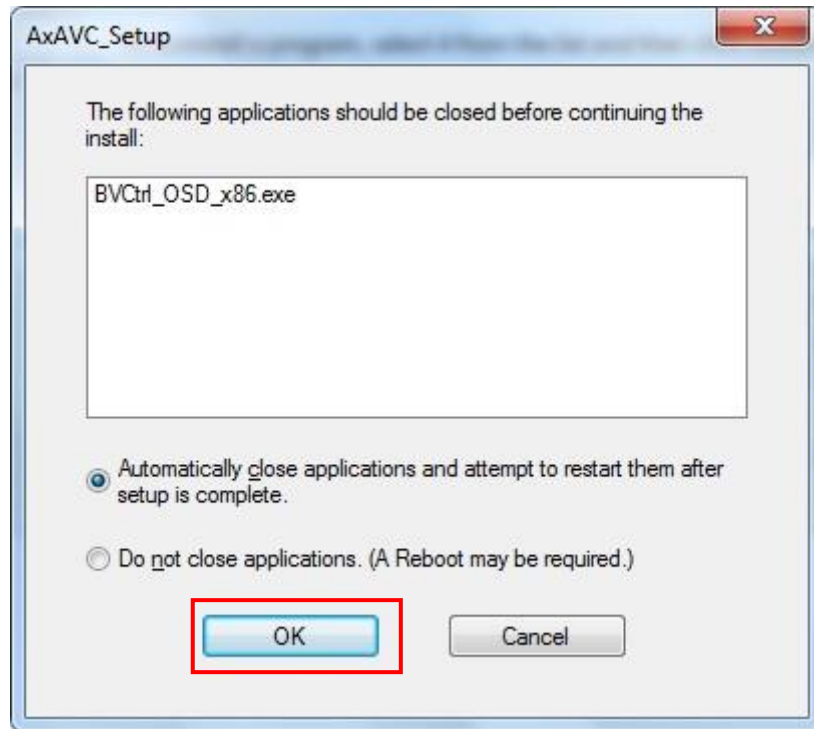
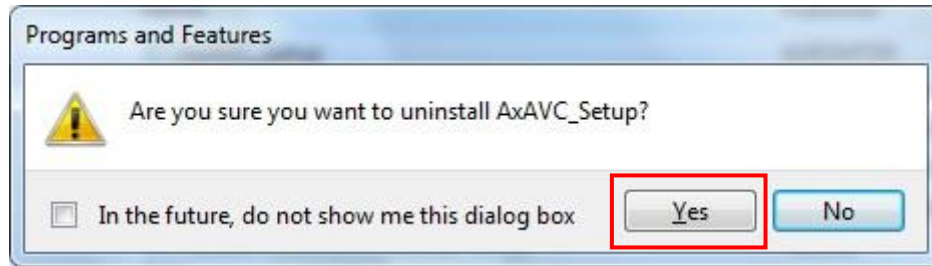

**Step 3** System auto reboot, uninstallation completed.