



®

AXIOMTEK

GOT5152T-834

All-in-One
15" XGA TFT Fanless Touch Panel
Computer with Intel® Celeron® Processor
J1900 onboard

User's Manual



Disclaimers

This manual has been carefully checked and believed to contain accurate information. Axiomtek Co., Ltd. assumes no responsibility for any infringements of patents or any third party's rights, and any liability arising from such use.

Axiomtek does not warrant or assume any legal liability or responsibility for the accuracy, completeness or usefulness of any information in this document. Axiomtek does not make any commitment to update the information in this manual.

Axiomtek reserves the right to change or revise this document and/or product at any time without notice.

No part of this document may be reproduced, stored in a retrieval system, or transmitted, in any form or by any means, electronic, mechanical, photocopying, recording, or otherwise, without the prior written permission of Axiomtek Co., Ltd.

CAUTION

If you replace wrong batteries, it causes the danger of explosion. It is recommended by the manufacturer that you follow the manufacturer's instructions to only replace the same or equivalent type of battery, and dispose of used ones.

©Copyright 2014 Axiomtek Co., Ltd.

All Rights Reserved

July 2016, Version A2

Printed in Taiwan

Safety Precautions

Before getting started, read the following important cautions.

1. Be sure to ground yourself to prevent static charge when installing the internal components. Use a grounding wrist strap and place all electronic components in any static-shielded devices. Most electronic components are sensitive to static electrical charge.
2. Disconnect the power cords from the GOT5152T-834 Series before making any installation. Be sure both the system and the external devices are turned OFF. Sudden surge of power could ruin sensitive components. Make sure the GOT5152T-834 Series is properly grounded.
3. Do not open the system's top cover. If opening the cover for maintenance is a must, only a trained technician is allowed to do so. Integrated circuits on computer boards are sensitive to static electricity. To avoid damaging chips from electrostatic discharge, observe the following precautions:
 - Before handling a board or integrated circuit, touch an unpainted portion of the system unit chassis for a few seconds. This will help to discharge any static electricity on your body.
 - When handling boards and components, wear a wrist-grounding strap, available from most electronic component stores.

Trademarks Acknowledgments

Axiomtek is a trademark of Axiomtek Co., Ltd.

Windows[®] is a trademark of Microsoft Corporation.

IBM, PC/AT, PS/2, VGA are trademarks of International Business Machines Corporation.

Intel[®] and Pentium[®] are trademarks of Intel Corporation.

AMI is trademark of American Megatrend Inc.

Other brand names and trademarks are the properties and registered brands of their respective owners.

Table of Contents

Disclaimers.....	ii
Safety Precautions.....	iii
Chapter 1 Introduction.....	1
1.1 General Description	1
1.2 Specifications.....	2
1.3 Dimensions.....	4
1.4 I/O Outlets	6
1.5 Packing List	7
Chapter 2 Hardware and Installation	9
2.1 CFast™ card Installation	10
2.2 SBC87834 Jumpers and Connectors.....	11
2.2.1 Jumper Settings	13
2.2.2 Connectors.....	14
2.3 Ethernet.....	24
2.4 Mountings – Panel/Wall/Desktop/VESA	25
2.4.1 Panel Mounting	25
2.4.2 Wall-Mounting	26
2.4.3 Desktop-Mounting	26
2.4.4 VESA-ARM Mounting.....	28
2.5 HDD Installation.....	29
2.6 DRAM Installation.....	31
2.7 Mini cards Card Installation.....	33
2.7.1 Wireless LAN Card Installation	33
2.7.2 mSATA Card Installation.....	35
2.8 Power Input (Phoenix type)	36
Chapter 3 AMI BIOS Setup Utility	37
3.1 Navigation Keys	37
3.2 Main Menu.....	38
3.3 Advanced Menu.....	39
3.4 Chipset Menu.....	48
3.5 Security	51
3.6 Boot Menu.....	52

3.7	Save&Exit.....	53
Chapter 4 Drivers Installation		55
4.1	System	55
4.1.1	Win 7	55
4.1.2	Win 8/8.x	56
4.2	Touch Screen.....	56
4.2.1	Specification	56
4.2.2	Driver Installation- Windows 7/8.x.....	57
4.3	Embedded O.S.....	59
4.3.1	WES 7 & WE8S.....	59
Appendix A Watchdog Timer.....		61
	About Watchdog Timer.....	61
	How to Use Watchdog Timer.....	61
	WDT Sample Program	62
Appendix B Backlight Control.....		65
	About Backlight Control.....	65
	How to Use Backlight Control.....	65
	Removed Brightness Control Tool	74

This page is intentionally left blank.

Chapter 1

Introduction

This chapter contains general information and detailed specifications of the GOT5152T-834. Chapter 1 includes the following sections:

- General Description
- Specification
- Dimensions
- I/O Outlets
- Package List

1.1 General Description

The GOT5152T-834 is a fan-less and compact-size touch panel computer, equipped with a 15" TFT LCD display and low power consumption Intel® Celeron® Processor J1900. The GOT5152T-834 supports Windows 7, Windows 8.x and Windows embedded OS. The panel computer is able to install a CFast™ card or mSATA and provide two Mini card slots for wireless module. Its excellent ID and friendly user interface make it a professional yet easy-to-use panel computer. The GOT5152T-834 is an ideal for space-limited applications in factory automation, machine maker operating systems, building automation, and more.

GOT5152T-834: 15" TFT XGA Fanless Touch Panel Computer

- **Reliable and Stable Design**
The GOT5152T-834 adopts a fanless cooling system and a CFast™ card, which makes it suitable for vibration environments.
- **Embedded O.S. Supported**
The GOT5152T-834 not only supports Windows 7 and Windows 8.x, but also supports embedded OS,. For storage device, the GOT5152T-834 supports 2.5" SATA device and CFast™ card or mSATA.
- **Industrial-grade Product Design**
The GOT5152T-834 has an incredible design to be used in different industrial environments.

The front bezel meets the IP65/NEMA4 standard.

For connecting other devices, the GOT5152T-834 also features several interfaces: USB, Ethernet, and RS-232/422/485.

1.2 Specifications

Main CPU Board

- **CPU**
 - Intel® Celeron® Processor J1900 onboard.
- **System Memory**
 - One 204-pin DDR3L SO-DIMM socket
 - Maximum memory up to 8BG
- **BIOS**
 - America Megatrends BIOS

I/O System

- **Standard I/O**
 - Three RSS-232/422/485
 - Two USB 2.0
 - Two USB 3.0
 - One VGA
- **Ethernet**
 - 2x RJ45 Giga Ethernet (Intel i210IT)
- **Audio**
 - One Line out
- **Expansion**
 - 1 x Mini-card slot (w/SIM slot)
 - 1 x Mini-card slot (supports mSATA, optional)
- **Storage**
 - One CFast™ or mSATA
 - One 2.5" SATA HDD
- **Power connector**
 - GOT5152T-834-DC : 9VDC to 36VDC with phoenix power connector or
 - GOT5152T-834-J: External 60W AC Adapter with screw type connector

System Specification

- **15" XGA(1024x768) LCD with LED backlight**
- **5 wired Resistive Touch**
- **Fanless Heat Dispensing Design**
- **Disk drive housing:**
 - One 2.5" SATA drive
- **Net Weight**
 - 3.2 Kgs (7.05 lb)
- **Dimension (Main Body Size)**
 - 387.9 x 307.7 x 54.6mm
- **Operation Temperature**
 - 0°C to 50°C
- **Relative Humidity**
 - 10% to 90% @ 40°C, Non-Condensing
- **Vibration**
 - 2.0G, 5 to 500 Hz, 2.0 G random for CFast™ card
- **Power input**
 - 9~36VDC with phoenix power connector or
 - External 60W AC Adapter
 - Power Input: 90VAC to 264VAC
 - Power Output: 12VDC, Max. 5A



NOTE *All specifications and images are subject to change without notice.*



NOTE *If the operation temperature is higher than 35°C, the wide temperature HDD is recommended to be used on the device.*



NOTE *If the operation temperature is higher than 45°C, the wide temperature CFast™ are recommended to be used on the device.*

1.3 Dimensions

This diagram shows you dimensions and outlines of the GOT5152T-834.

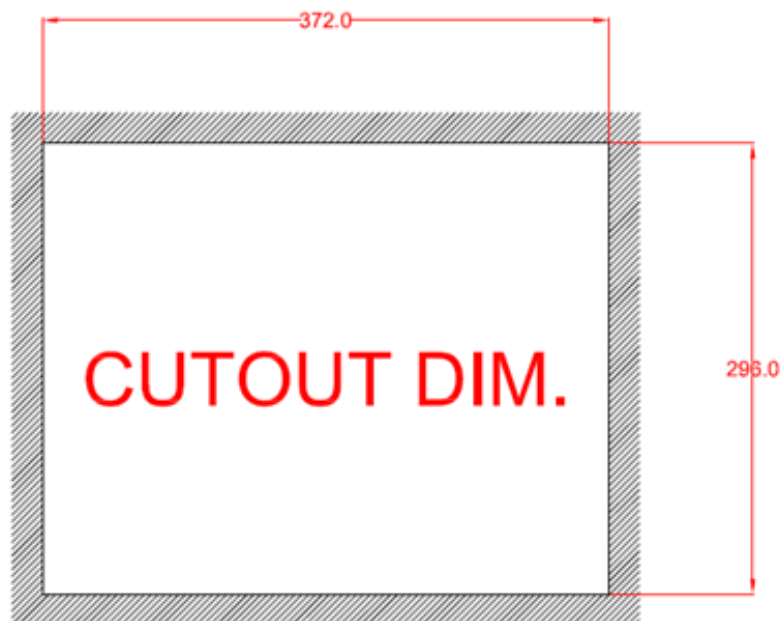
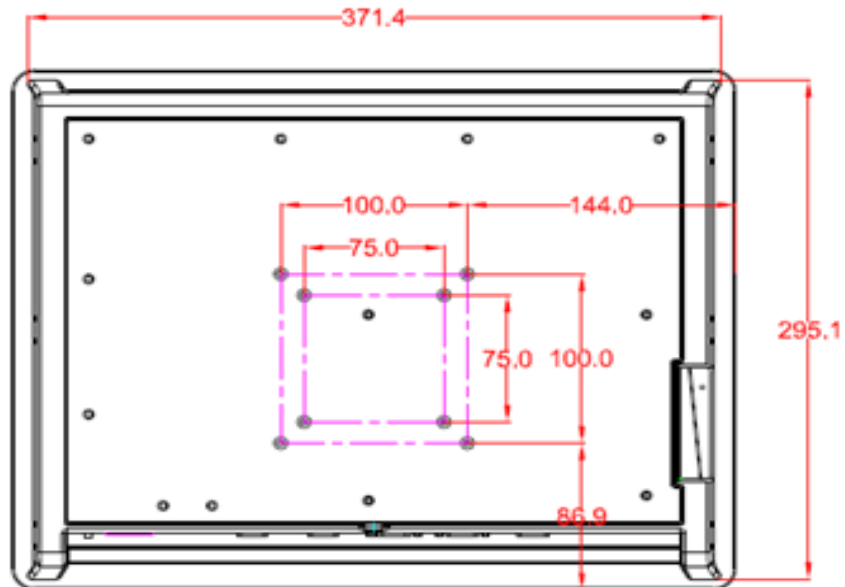

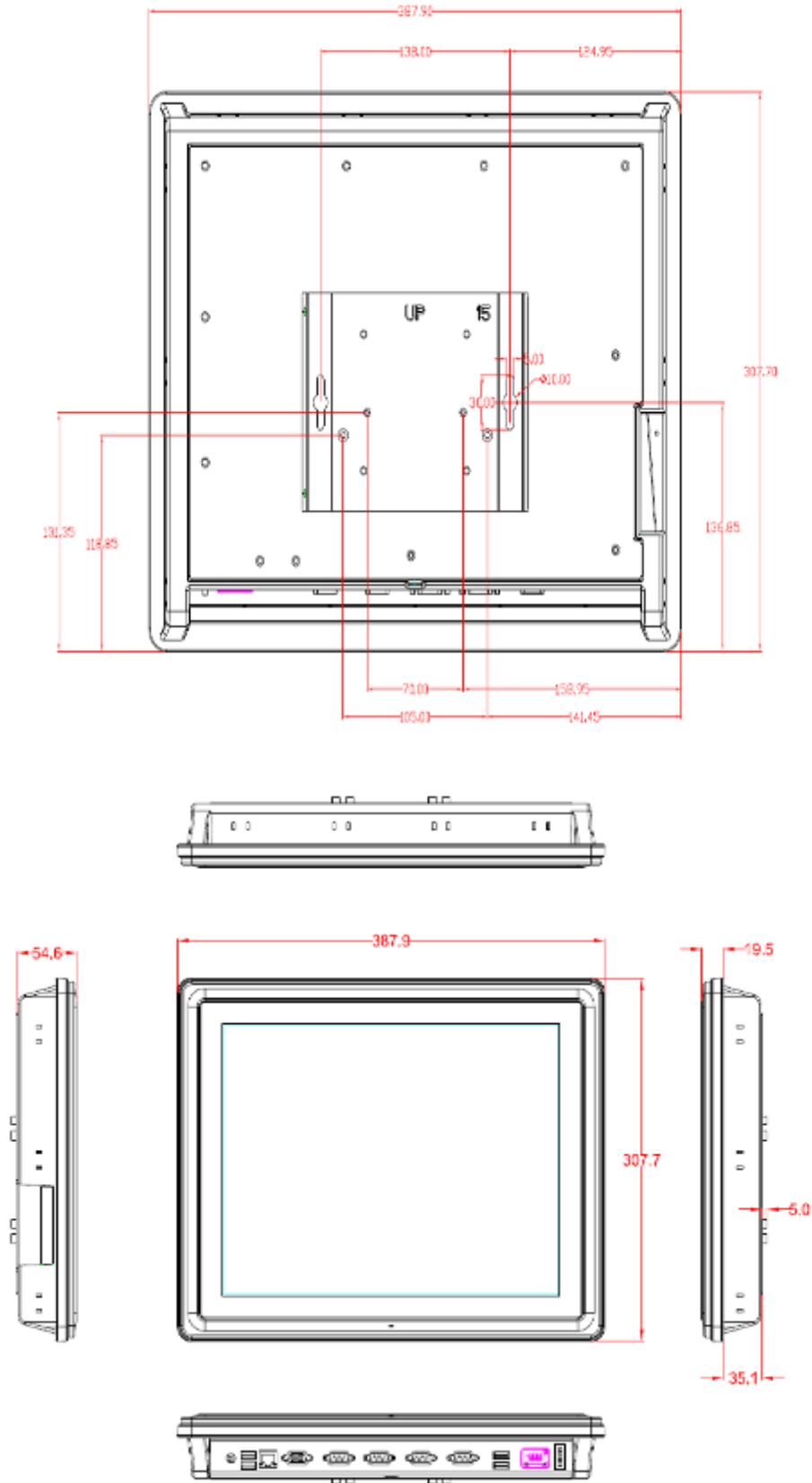

1.4 I/O Outlets

Please refer to the following illustration for I/O locations of the GOT5152T-834.



No	Function	No	Function
1	POWER SWITCH (ATX)	7	COM 1 (RS-232/422/485)
2	Power Input connector (Phoenix)	8	COM 2 (RS-232/422/485)
3	Power Input connector (Screw)	9	Ethernet (RJ-45)
4	Dual USB 2.0 ports	10	Dual USB 3.0 ports
5	COM 3(RS-232/422/485)	11	AUDIO (LINE-OUT)
6	VGA		

1.5 Packing List

When you receive the GOT5152T-834, the bundled package should contain the following items:

- **GOT5152T-834 x 1**
- **Panel Mount Kit x 10**
- **Driver CD x1**
- **Wall-Mount Kit x1**
- **Screws for HDD x4**
- **Phoenix connector x 1 (for GOT5152T-834-DC)**
- **Power Adapter & power cord (for GOT5152T-834-J)**

If you can not find the package or any items are missing, please contact Axiomtek distributors immediately.

This page is intentionally left blank.

Chapter 2

Hardware and Installation

The GOT5152T-834 provides rich I/O ports and flexible expansions for you to meet different demand, for example, CFast™ card. The chapter will show you how to install the hardware. It includes:

- **CFast™ Card**
- **SBC87834 Jumpers and Connectors**
- **Ethernet**
- **Mounting Way**
- **Hard disk**
- **DRAM**
- **Wireless LAN Card**
- **Power Input**

2.1 CFast™ card Installation

The GOT5152T-834 provides one CF slot for users to install CFast™ card. Please refer to the following instructions for installation:

Step 1 Turn off the system, and unplug the power cord.

Step 2 Remove the cover of CFast™ socket.



Step 3 Locate the CFast™ socket, and insert the card into the socket.

2.2 SBC87834 Jumpers and Connectors

Component Side

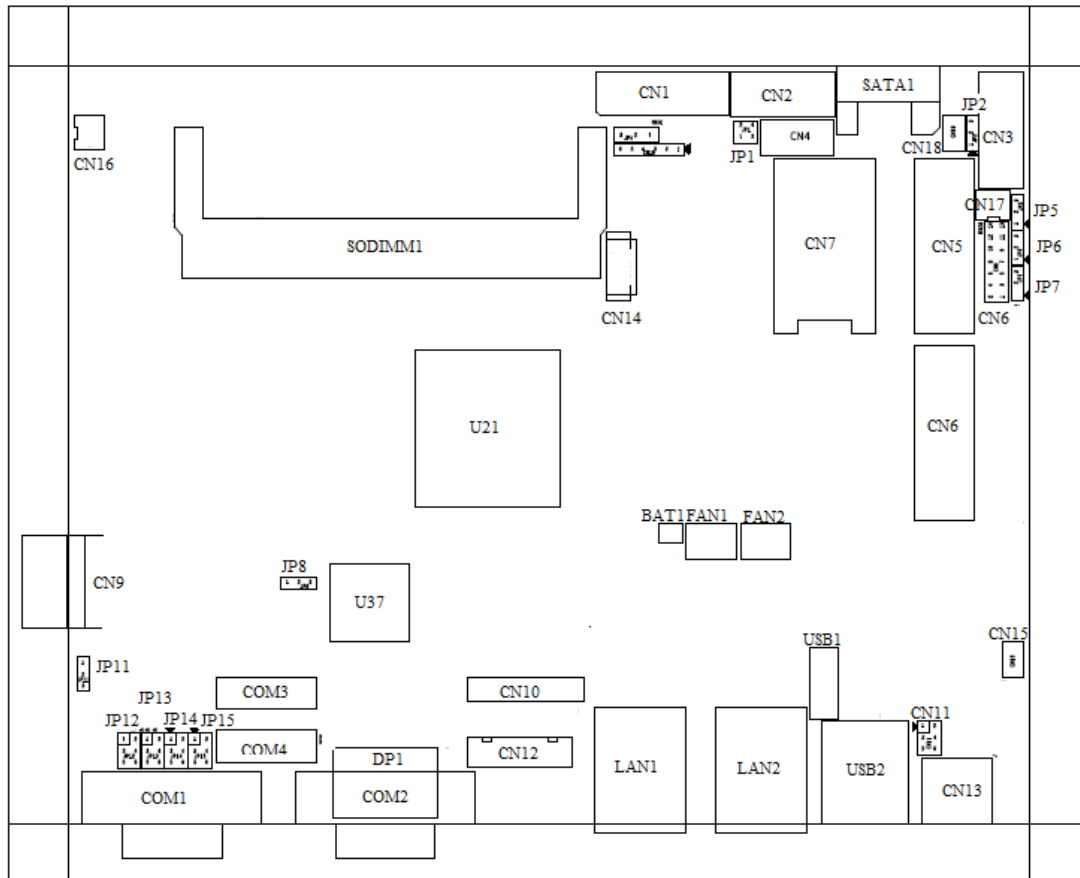

Solder Side

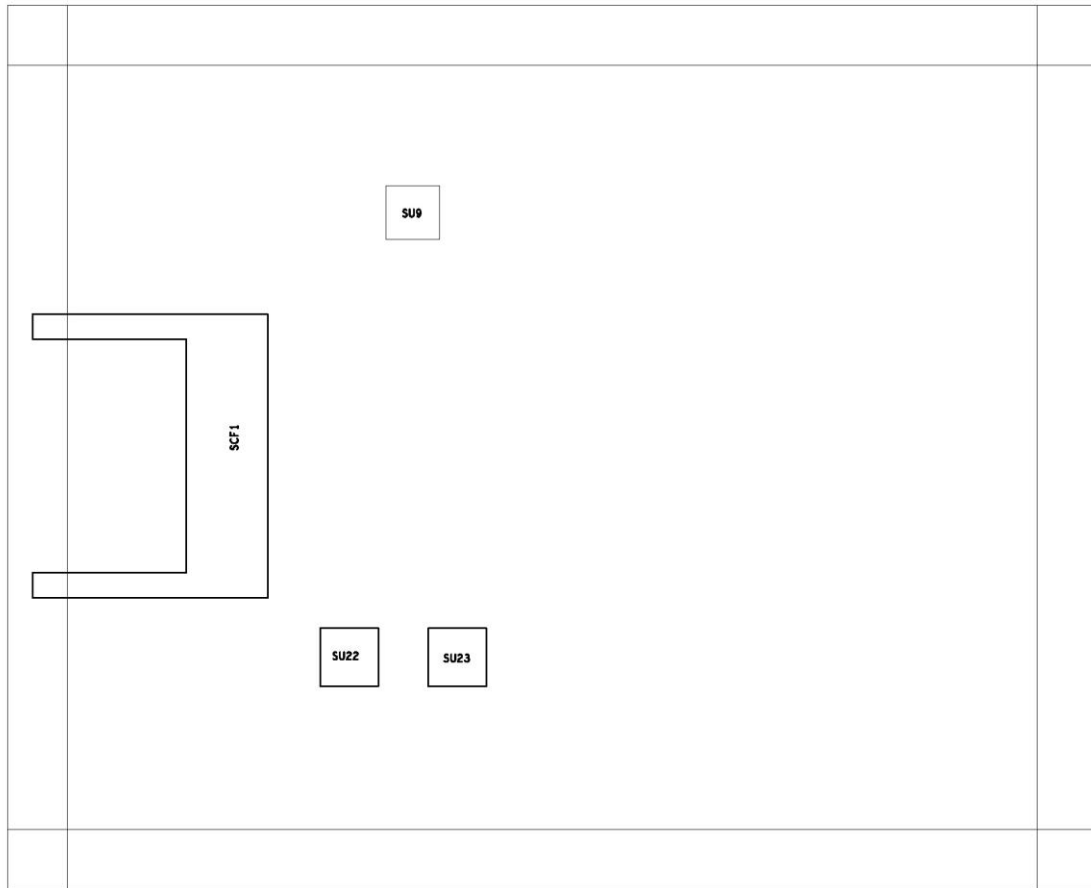

2.2.1 Jumper Settings

Making the proper jumper settings configure the **SBC87834** to match the needs of your application.

The following table shows the default jumper settings for the onboard devices.

Jumper	★ Default Setting	Jumper Setting
JP1	★ Panel backlight control PWM mode Panel backlight control DC mode	Short 1-2 Short 3-4
JP2	Touch Controller 4,8 WIRE ★ Touch Controller 5 WIRE	Short 1-2 Short 2-3
JP4	★ LVDS Panel Power : 3.3V LVDS Panel Power : 5V	Short 1-2 Short 2-3
JP5	Touch OFF ★ Touch ON	Short 1-2 Short 2-3
JP6	★ PCIe device mSATA device	Short 1-2 Short 2-3
JP7	AT mode ★ ATX mode	Short 1-2 Short 2-3
JP8	★ Normal Clear CMOS	Short 1-2 Short 2-3
JP11	COM3_5VSB ★ COM3_5V	Short 1-2 Short 2-3
JP12	★ COM1 normal mode COM1 pin1 with power :+5V COM1 pin9 with power :+12V	Short 3-5,4-6 Short 1-3,4-6 Shot 3-5,2-4
JP13	★ COM2 normal mode COM2 pin1 with power :+5V COM2 pin9 with power :+12V	Short 3-5,4-6 Short 1-3,4-6 Shot 3-5,2-4
JP14	★ COM3 normal mode COM3 pin1 with power :+5V COM3 pin9 with power :+12V	Short 3-5,4-6 Short 1-3,4-6 Shot 3-5,2-4
JP15	★ COM4 normal mode COM4 pin1 with power :+5V COM4 pin9 with power :+12V	Short 3-5,4-6 Short 1-3,4-6 Shot 3-5,2-4

2.2.2 Connectors

The connectors allow the CPU Board to connect with other parts of the system. Ensure that all connectors are in place and firmly attached. The following table lists the function of each connector on the **SBC87834**.

Connectors	Label
LVDS connector	CN1
LVDS inverter connector	CN2
TOUCH connector	CN3
HDD power connector	CN4
Full size min-PCIe connector	CN5
FRONT PANEL pin header	CN6
SIM card connector	CN7
Full size min-PCIe connector	CN8
DC IN connector	CN9
Digital I/O pin header	CN10
Speaker Out & MIC IN connector	CN11
VGA connector	CN12
Audio connector	CN13
USB CONNECTOR (reserved)	CN14/CN20
Audio Lin In connector	CN15
Power lamp connector	CN16
Power button connector	CN17
Touch function enable/disable & LED indicator connector	CN18
Panel control Keypad connector	CN19
CPU FAN	FAN1
System FAN	FAN2
USB2.0 box header	USB1
USB3.0 connector	USB2
Display Port connector	DP1
SATA connector	SATA1
RJ45 LAN connector	LAN1, LAN2
Serial Port connector	COM1,COM2
Serial Port box header	COM3,COM4
CFast connector	SCF1

LVDS connector: CN1

CN1 Pin Assignment



Pin	Description	Pin	Description
1	VCC	21	GND
2	VCC	22	GND
3	VCC	23	LVDSA_DATAN0
4	VCC	24	LVDSB_DATAN2
5	VCC	25	LVDSA_DATAP0
6	VCC	26	LVDSB_DATAP2
7	DDC DATA	27	GND
8	DDC CLOCK	28	GND
9	GND	29	LVDSA_DATAN1
10	GND	30	LVDSA_DATAN3
11	LVDSB_DATAN3	31	LVDSA_DATAP1
12	LVDSB_DATAN0	32	LVDSA_DATAP3
13	LVDSB_DATAP3	33	GND
14	LVDSB_DATAP0	34	GND
15	GND	35	LVDSA_DATAN2
16	GND	36	LVDSA_CLKN
17	LVDSB_CLKN	37	LVDSA_DATAP2
18	LVDSB_DATAN1	38	LVDSA_CLKP
19	LVDSB_CLKP	39	GND
20	LVDSB_DATAP1	40	GND

LVDS inverter connector: CN2

CN2 Pin Assignment

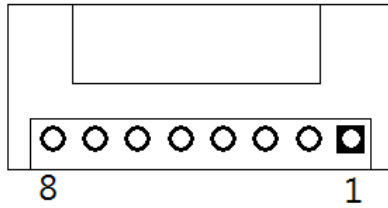

Pin	Description	Pin	Description
1	GND	5	Inverter ON-OFF
2	GND	6	+12V
3	GND	7	+12V
4	Backlight control	8	+12V

TOUCH connector: CN3

CN3 Pin Assignment

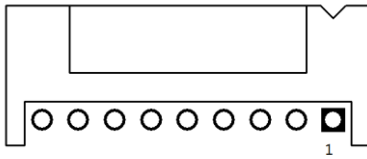

Pin	Description
1	X+
2	X-
3	Y+
4	Sense
5	X+
6	X-
7	Y+
8	Y-
9	GND

HDD power connector: CN4

CN9 Pin Assignment

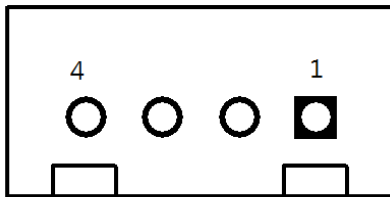

Pin	Description
1	+12V
2	GND
3	GND
4	+5V

FRONT PANEL pin header: CN6

CN6 Pin Assignment

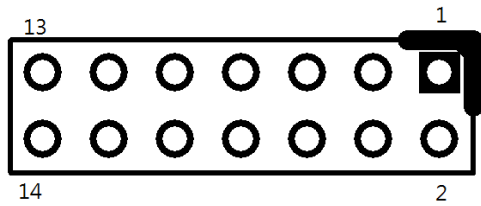

Pin	Description	Pin	Description
1	+ 5V	2	Beep
3	GND	4	BUZZER
5	GND	6	Beep
7	NC	8	+5V
9	GND	10	PWBTN
11	GND	12	RESET
13	SATA LED	14	+3.3V

SIM card connector: CN7

CN7 Pin Assignment

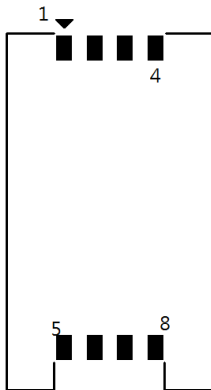

Pin	Description	Pin	Description
1	UIM PWR	5	GND
2	UIM RST	6	UIM VPP
3	UIM CLK	7	UIM DATA
4	NC	8	NC

Power connector: CN9

CN9 Pin Assignment

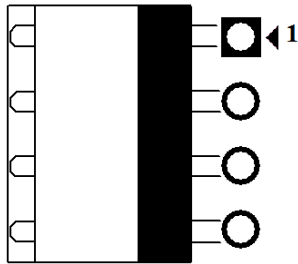

Pin	Description
1	DCIN (9V -36V)
2	DCIN (9V -36V)
3	GND
4	GND

Digital I/O pin header: CN10

CN10 Pin Assignment

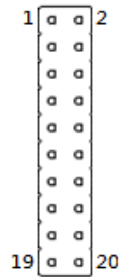

Pin	Description	Pin	Description
1	GND	6	GND
2	GPIO0	7	GPIO1
3	GPIO2	8	GPIO3
4	GPIO4	9	GPIO5
5	GPIO6	10	GPIO7
11	GPIO8	12	GPIO9
13	GPIO10	14	GPIO11
15	GPIO12	16	GPIO13
17	GPIO14	18	GPIO15
19	GND	20	GND

Speaker Out & MIC IN connector: CN11

CN11 Pin Assignment

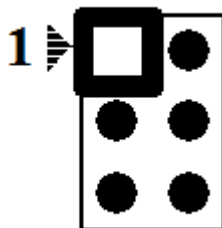

Pin	Description	Pin	Description
1	SPKOUT_L-	2	SPKOUT_L +
3	SPKOUT_R-	4	SPKOUT_R +
5	MIC IN	6	GND

VGA Cable Connector: CN12

CN12 Pin Assignment

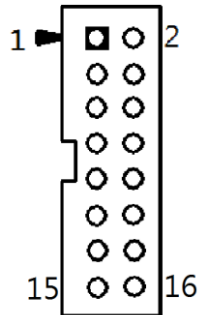

Pin	Signal	Pin	Signal
1	Red	2	GND
3	Green	4	N.C.
5	Blue	6	N.C.
7	VCC	8	DDC DATA
9	GND	10	N.C.
11	GND .	12	Horizontal Sync
13	GND	14	Vertical Sync
15	DCC CLK	16	N.C.

USB CONNECTOR (reserved): CN14/CN20

CN14/CN20 Pin Assignment

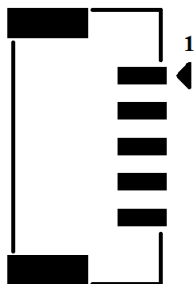

Pin	Description
1	VCC
2	D-
3	D+
4	GND
5	GND

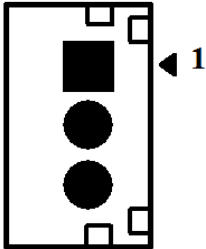
Audio Lin In connector: CN15**CN15 Pin Assignment**

Pin	Description
1	LINE IN L
2	GND
5	LIN IN R

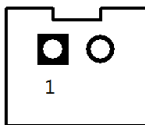
Power lamp connector: CN16**CN16 Pin Assignment**

Pin	Description	Pin	Description
1	Power (+5V)	2	GND

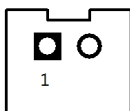
Power button connector: CN17**CN17 Pin Assignment**

Pin	Description	Pin	Description
1	Power Button	2	GND

Touch function enable/disable & LED indicator connector: CN18

CN18 Pin Assignment

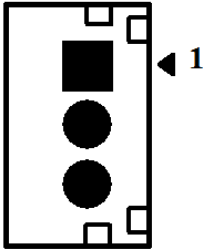

Pin	Description
1	ON/OFF button
2	GND
3	LED

Panel control Keypad connector: CN19

CN19 Pin Assignment



Pin	Description
1	GND
2	Panel ON/OFF
3	Abnormal indicate LED
4	Normal indicate LED
5	Backlight down
6	Backlight up

USB box header: USB1

USB1 Pin Assignment

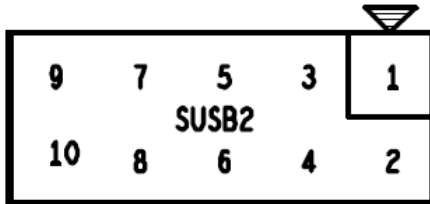

Pin	Description	Pin	Description
1	+5V	2	+5V
3	USB-	4	USB-
5	USB+	6	USB+
7	GND	8	GND
9	GND	10	GND

Serial Port box header: COM3, COM4

COM3, COM4 Pin Assignment

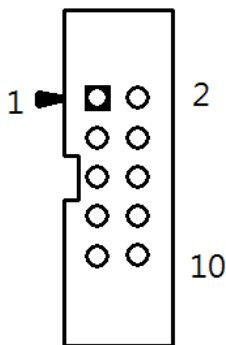

Pin	Description	Pin	Description
1	DCD	2	DSR
3	RX	4	RTS
5	TX	6	CTS
7	DTR	8	RI
9	GND	10	NC

2.3 Ethernet

The **GOT5152T-834** is equipped with two high performance Plug and Play Ethernet interfaces, full compliant with IEEE 802.3 standard, and can be connected with a RJ-45 LAN connector.

Please refer to detailed pin assignment list below:

Pin	Signal
1	TX+ (Data transmission positive)
2	TX- (Data transmission negative)
3	Rx+(Data reception positive)
4	RJ45 termination
5	RJ45 termination
6	Rx- (Data reception negative)
7	RJ45 termination
8	RJ45 termination

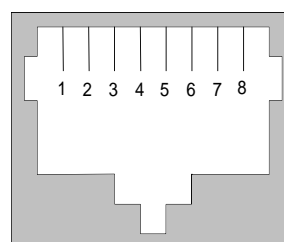

RJ-45

2.4 Mountings – Panel/Wall/Desktop/VESA

There are several mounting ways for the GOT5152T-834, Panel, Wall, Desktop and VESA mountings.

2.4.1 Panel Mounting

The GOT5152T-834 is designed for panel mount application. A set of standard mounting kit are bundled with the system package that you can use it to mount the GOT5152T-834.

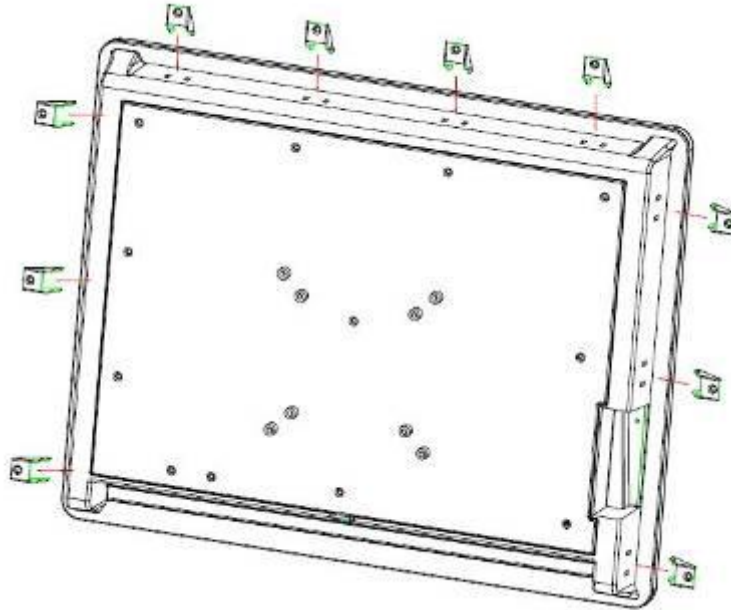

2.4.2 Wall-Mounting

The GOT5152T-834 is designed for Wall mounting application. Please refer to the following steps:

Fix wall mount bracket on the back of the unit.

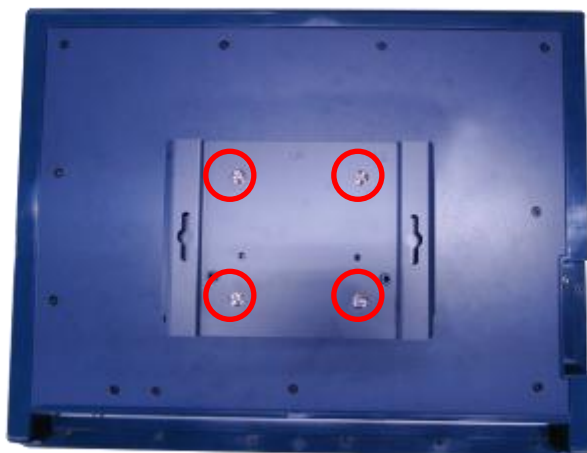

2.4.3 Desktop-Mounting

The GOT5152T-834 is designed for desktop mounting application. Please refer to the following steps:

Step 1 Find out the screws as marked on the back side of chassis.



Step 2 Assemble the desktop stand to the chassis, and fix the screws.



CAUTION : USE RECOMMENDED/SUITABLE MOUNTING APPARATUS TO AVOID RISK OF INJURY.

2.4.4 VESA-ARM Mounting

CAUTION : USE RECOMMENDED/SUITABLE MOUNTING APPARATUS TO AVOID RISK OF INJURY.

Step 1 Find out the screws as marked on the back side of chassis.

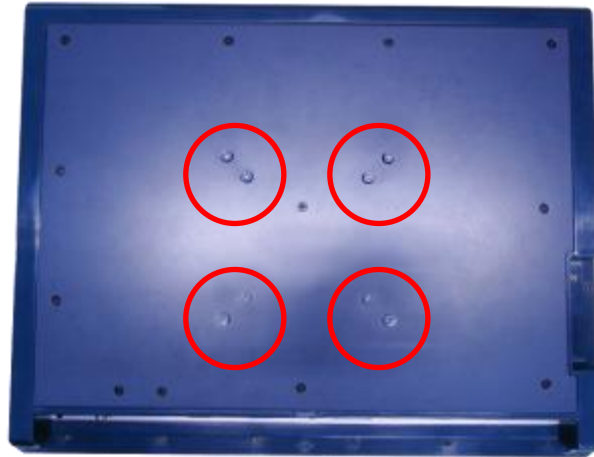

Step 2 Assemble the VESA-ARM to the back side of the chassis, and fix the screws.



Step 3 VESA mounting Installation completed.

2.5 HDD Installation

The GOT5152T-834 provides a convenient Hard Disk Drive (HDD) bracket for users to install 2.5" SATA HDD. Please follow the steps:

Step 1 Unscrew eight screws to remove the back cover.

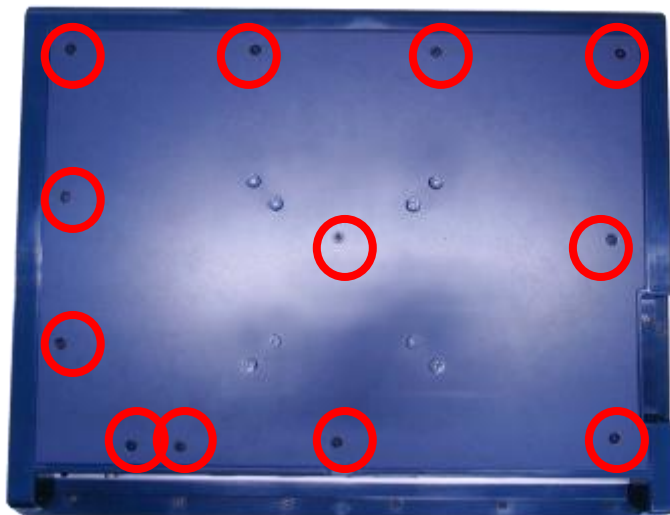

Step 2 Screw the 2.5" HDD to the HDD bracket.



Step 3 Fix the HDD bracket into the system, and plug the data and power cable to HDD. Installation complete.



2.6 DRAM Installation

The GOT5152T-834 provides one 204-pin DDR3L SODIMM socket that support system memory up to 8GB. Please follow steps below to install the memory modules:

Step 1 Open the back cover and find out the DIMM socket on main board(SBC87834).

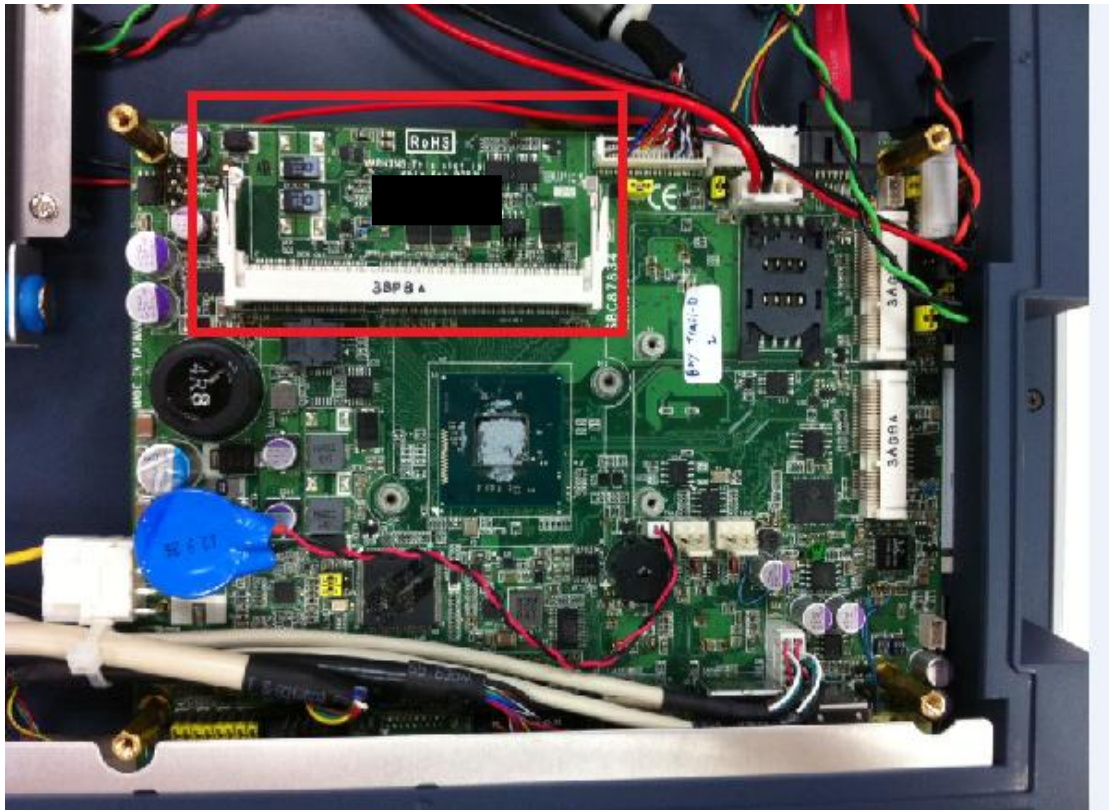

Step 2 Insert the DRAM to the DIMM socket, and then push it down firmly until it is clipped by the socket.



- Step 3** Install the memory module into the socket and push it firmly down until it is fully seated. The socket latches are levered upwards and clipped on to the edges of the DIMM.



2.7 Mini cards Card Installation

2.7.1 Wireless LAN Card Installation

The GOT5152T-834 provides two Mini card slots for user to install wireless LAN cards. You can choose either slot 1 or slot 2 to install the wireless LAN card and refer to the following instructions and illustration:

Step 1 Open the back cover and find out the mini-card slot on main board.

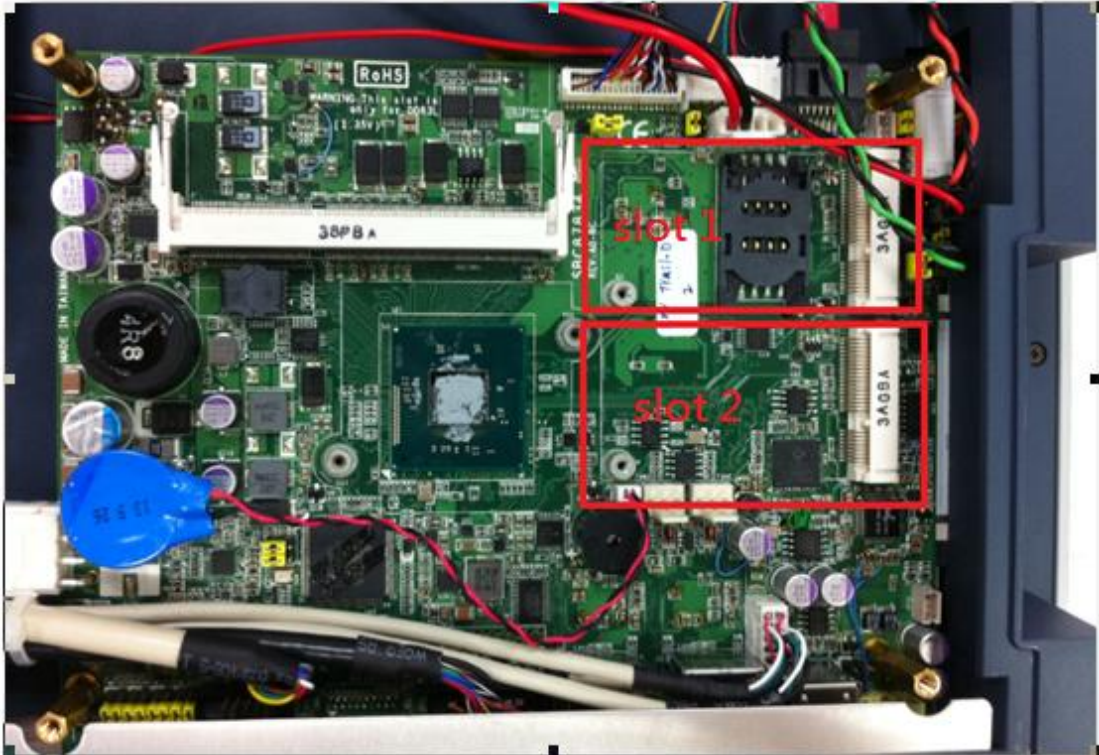

Step 2 Insert the wireless LAN card to the slot. Screw it firmly on the slot.

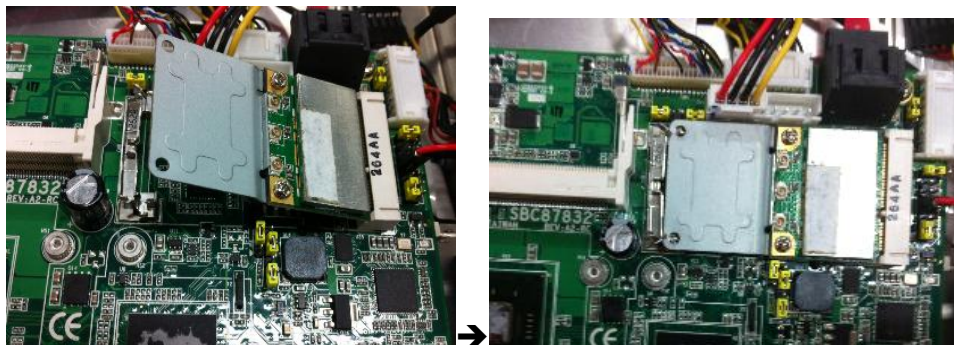

Step 3 Find the built-in Antenna cable.



Step 4 There are two connectors on wireless LAN card. One is MAIN, and the other is auxiliary. Connect antenna cable to MAIN connector on wireless LAN card.

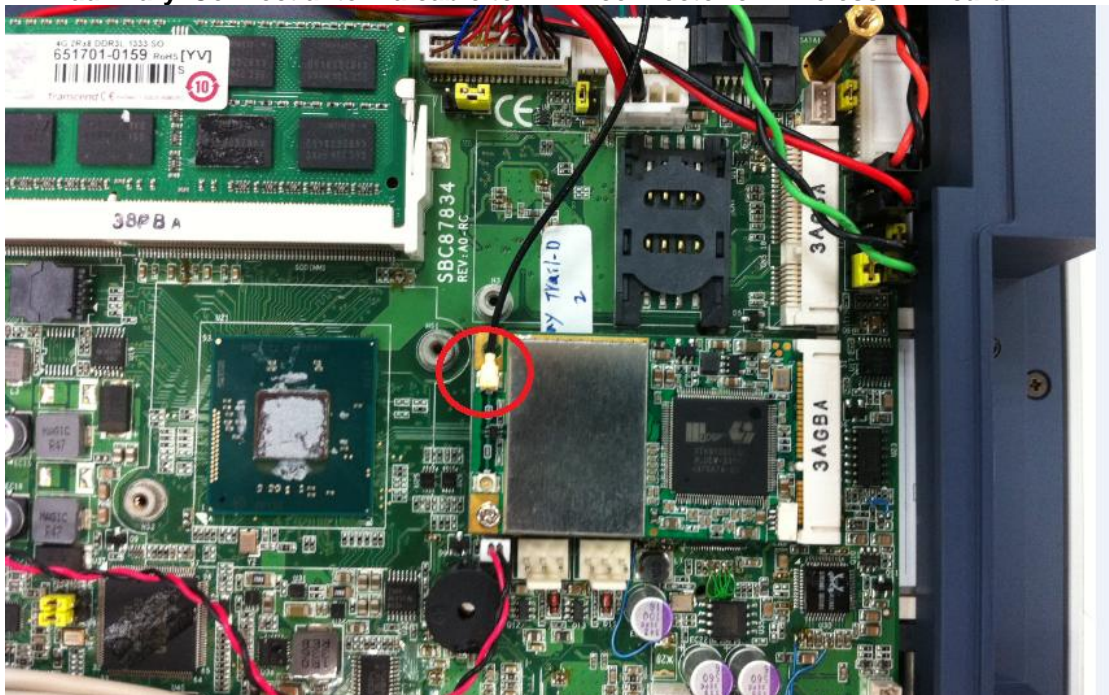

2.7.2 mSATA Card Installation

The GOT5152T-834 provides one Mini card slot for user to install mSATA. Please choose the slot 2 when installing the mSATA card and refer to the following instructions and illustration:

Step 1 Open the back cover and find out the mini-card slot on main board.

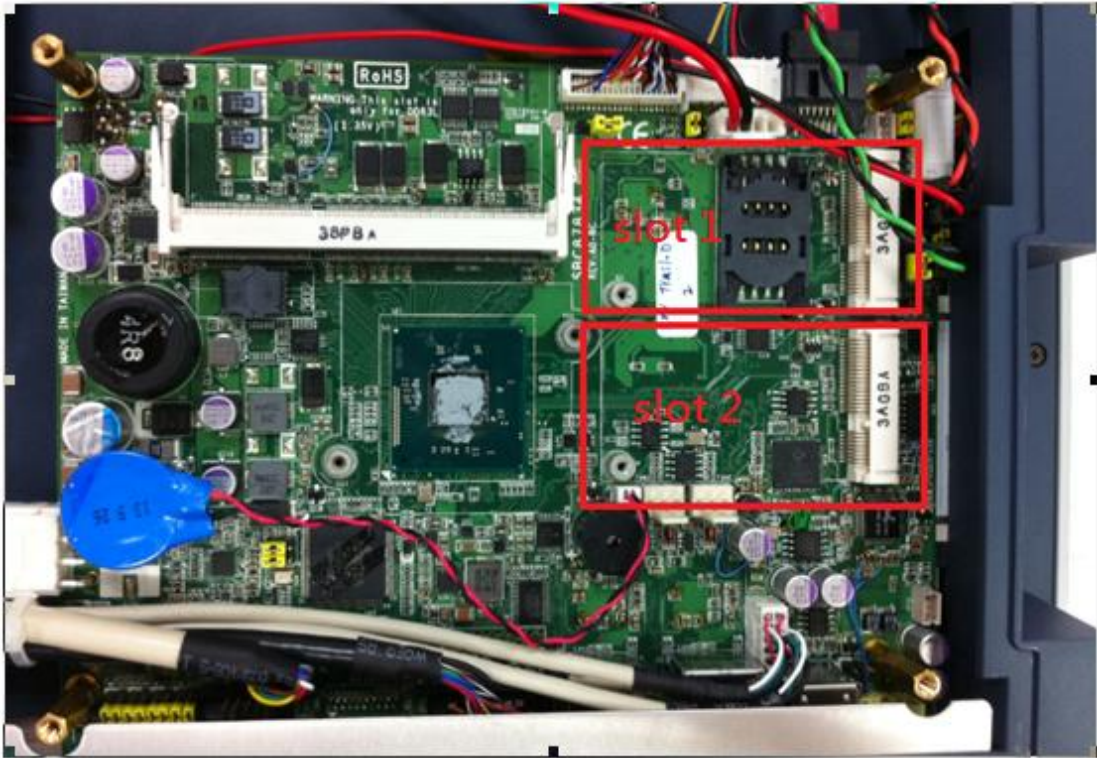

Step 2 Insert the mSATA card to the slot 2. Screw it firmly on the slot.



NOTE Please set the jumper JP6 in 2-3 when using the mSATA.



NOTE The screws of mini card slots are M12 type.

2.8 Power Input (Phoenix type)

GOT5152T-834 equips with a phoenix type power connector. It adopts 9VDC to 36VDC. Please follow the signs on power connector to connect DC power source.

+: Power positive

G: Safety ground

—: Power negative



NOTE The safety ground must be connected to ensure the unit working appropriately.

Chapter 3

AMI BIOS Setup Utility

This chapter provides users with detailed description how to set up basic system configuration through the AMIBIOS8 BIOS setup utility.

3.1 Navigation Keys

The BIOS setup/utility uses a key-based navigation system called hot keys. Most of the BIOS setup utility hot keys can be used at any time during the setup navigation process. These keys include <F1>, <F2>, <F3>, <F4>, <Enter>, <ESC>, <Arrow> keys, and so on.



NOTE Some of navigation keys differ from one screen to another.

< Left/Right	The Left and Right <Arrow> keys allow you to select a setup screen.
↑↓ Up/Down	The Up and Down <Arrow> keys allow you to select a setup screen or sub-screen.
+– Plus/Minus	The Plus and Minus <Arrow> keys allow you to change the field value of a particular setup item.
Tab	The <Tab> key allows you to select setup fields.
F1	The <F1> key allows you to display the General Help screen.
F2	The <F2> key allows you to load previous value
F3	The <F3> key allows you to Load Optimized Defaults.
F4	The <F4> key allows you to save any changes you have made and exit Setup. Press the <F4> key to save your changes.
Esc	The <Esc> key allows you to discard any changes you have made and exit the Setup. Press the <Esc> key to exit the setup without saving your changes.
Enter	The <Enter> key allows you to display or change the setup option listed for a particular setup item. The <Enter> key can also allow you to display the setup sub-screens.

3.2 Main Menu



- **System Time/Date**

Use this option to change the system time and date. Highlight *System Time* or *System Date* using the <Arrow> keys. Enter new values through the keyboard. Press the <Tab> key or the <Arrow> keys to move between fields. The date must be entered in MM/DD/YY format. The time is entered in HH:MM:SS format.

3.3 Advanced Menu

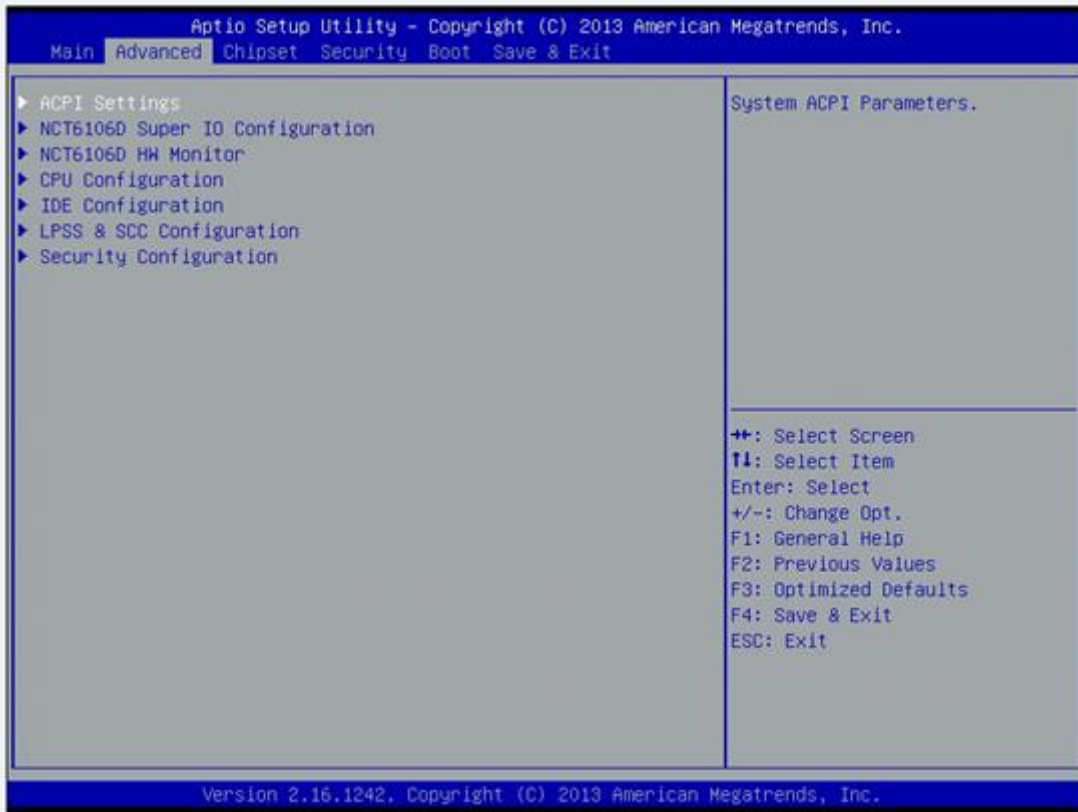

The Advanced menu allows users to set configuration of the CPU and other system devices. You can select any of the items in the left frame of the screen to go to the sub menus:

- ACPI Settings
- NCT6106D Super IO Configuration
- NCT6106D H/W Monitor
- CPU Configuration
- IDE Configuration
- Intel TXE Configuration
- LPSS & SCC Configuration

For items marked with “▶”, please press <Enter> for more options.’

- **ACPI Settings**

You can use this screen to select options for the ACPI Configuration, and change the value of the selected option. A description of the selected item appears on the right side of the screen.

- **ACPI Sleep State**

Allow you to select the Advanced Configuration and Power Interface (ACPI) state to be used for system suspend. Here are the options for your selection, Suspend disable and S3 (Suspend to RAM).



- **NCT6106D Super IO Configuration**

Use this screen to select options for the Super IO Configuration, and change the value of the selected option

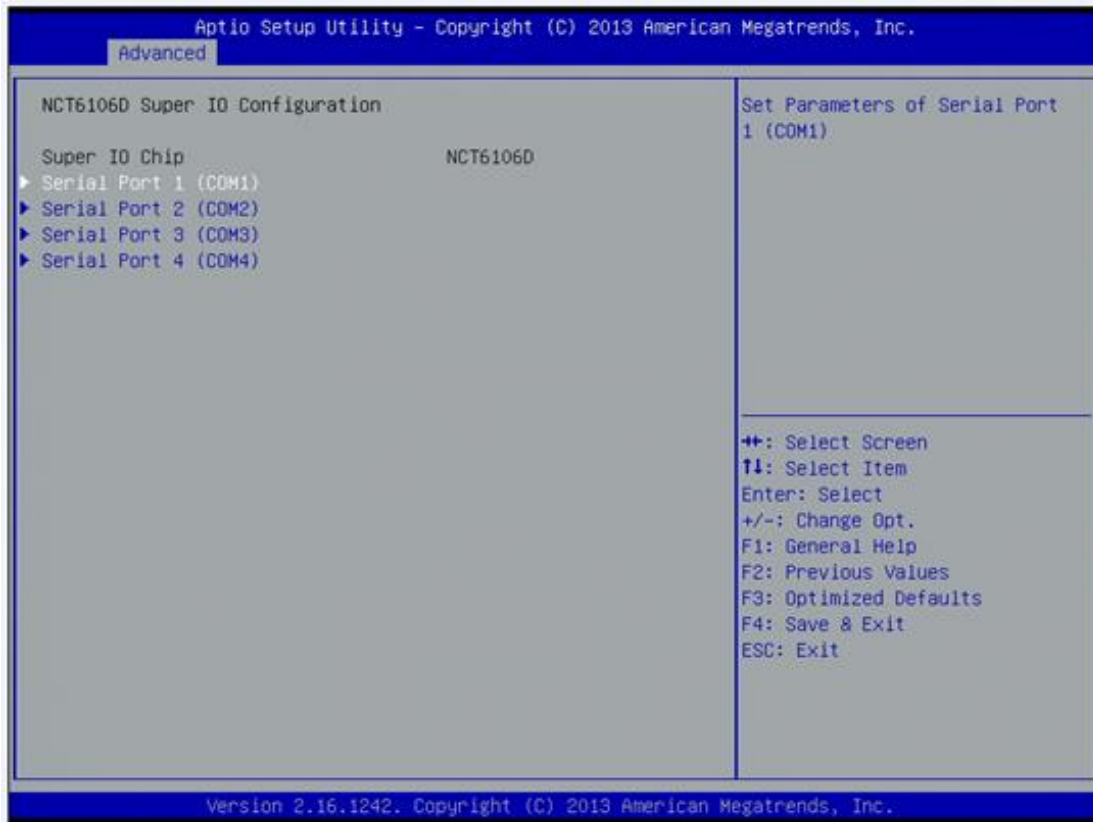

Serial Port 1-4 configuration

Serial port:

This option used to enable or disable the serial port.

Device Setting:

This item specifies the base I/O port address and Interrupt Request address of serial port.

The port 0 Optimal setting is *3F8/IRQ4*.

The port 1 Optimal setting is *2F8/IRQ3*.

The port 2 Optimal setting is *3E8/IRQ7*.

The port 3 Optimal setting is *2E8/IRQ5*.

- **Serial type**

This option used to select RS232/422/485 function.



- **NCT6106D H/W Monitor**

This screen shows the Hardware Health Configuration.

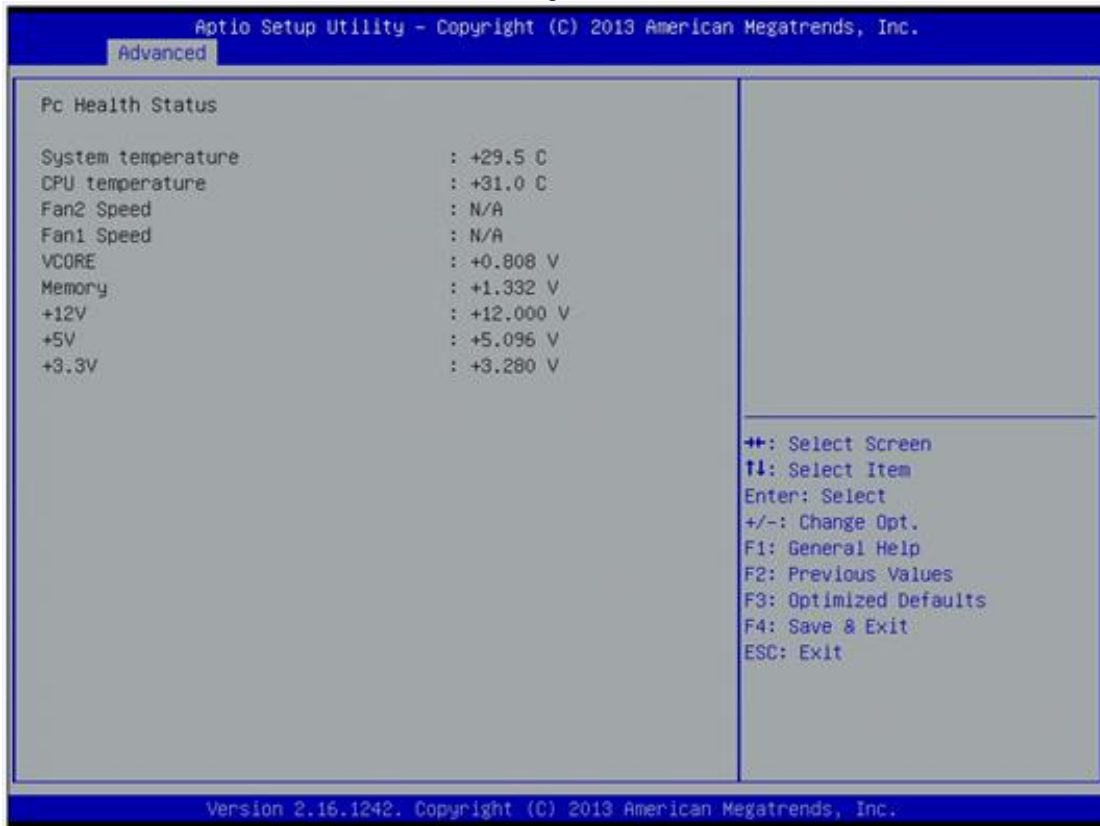

- **CPU Configuration**

This screen shows the CPU Configuration and Intel virtualization technology enable/disable selected



- **IDE Configuration**

You can use this screen to select options for the SATA Configuration, and change the value of the selected option.

- **SATA Mode**

Use this item to choose the SATA operation mode. Here are the options for your selection, IDE Mode, AHCI Mode.

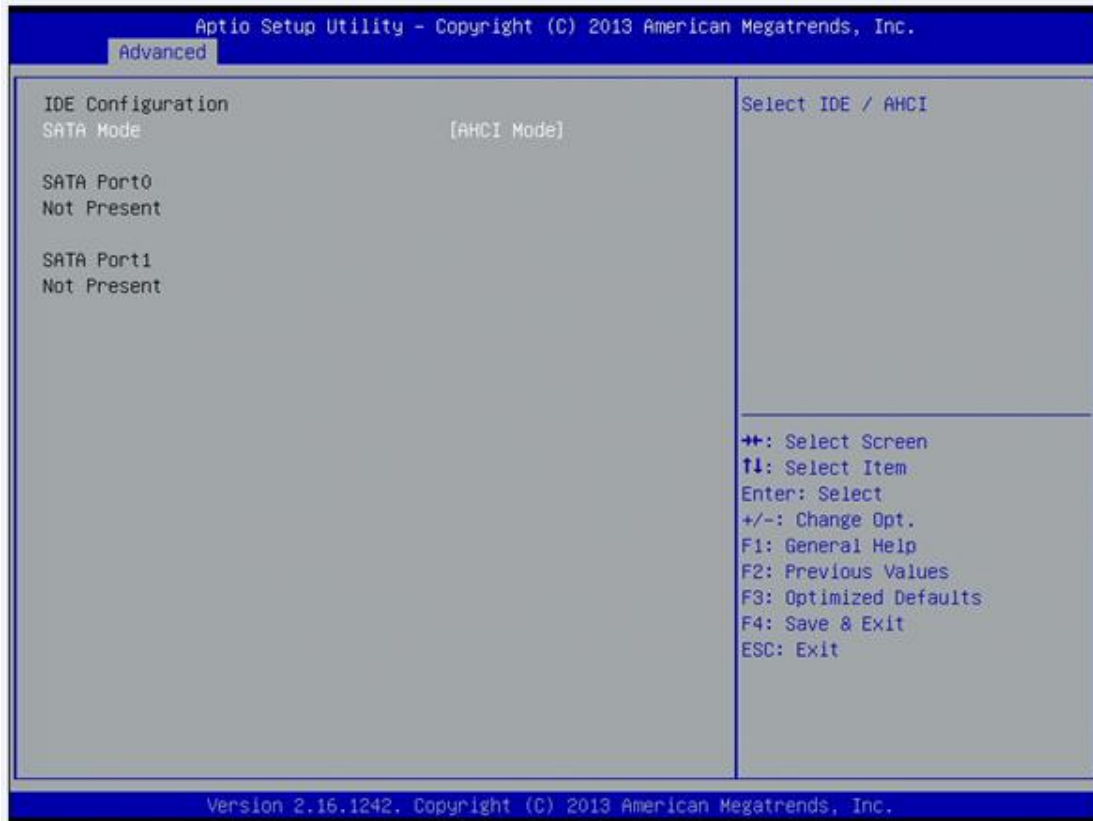

- **Intel TXE Configuration**

The Advanced menu allows users to update the TXE firmware.



- **LPSS & SCC Configuration**

You can select any of the items in the frame of the screen to change the OS, the default setting is Win 7.



Please be informed to select the Windows 8.x when installing Win 8 or Win 8.1.

- **If using the Android OS, please refer to <https://01.org/android-ia>.**

3.4 Chipset Menu

The Chipset menu allows users to change the advanced chipset settings.



- **North Bridge**

This screen shows the North Bridge memory information.

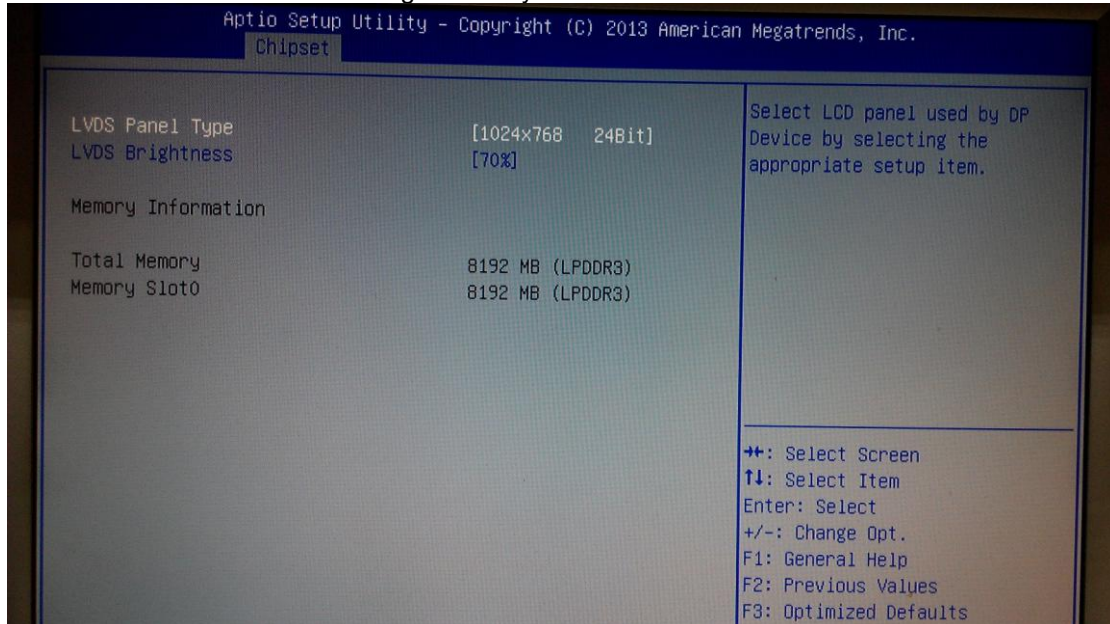

- **South Bridge**

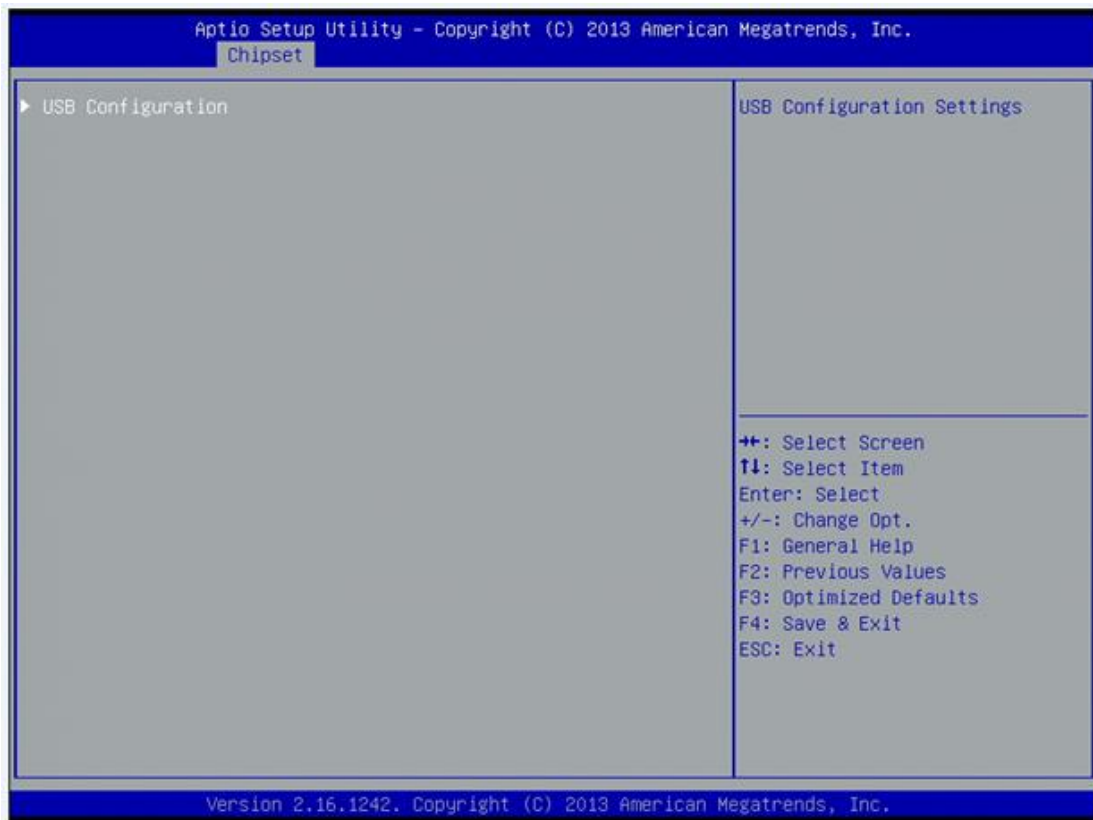

- **USB Configuration**

You can use this screen to select options for the USB Configuration, If USB3.0 function used, XHCI Mode must enable and EHCI must disable.

**XHCI default is Auto.

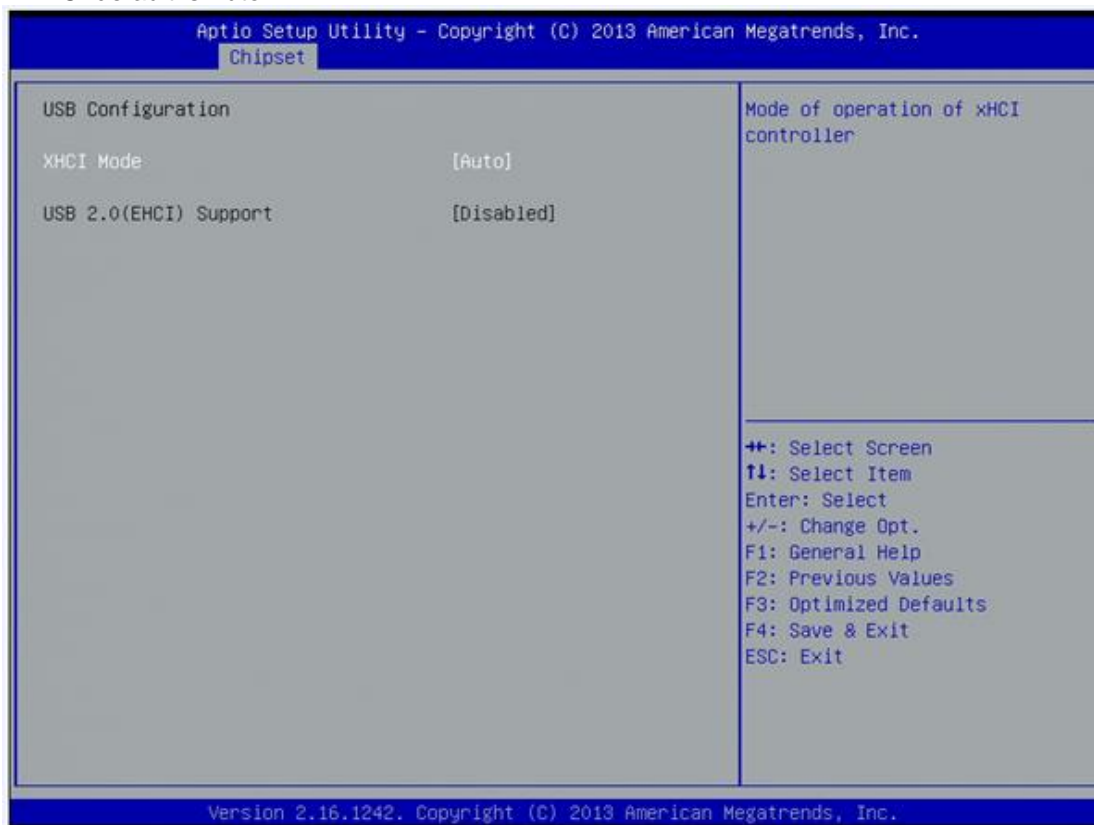

3.5 Security

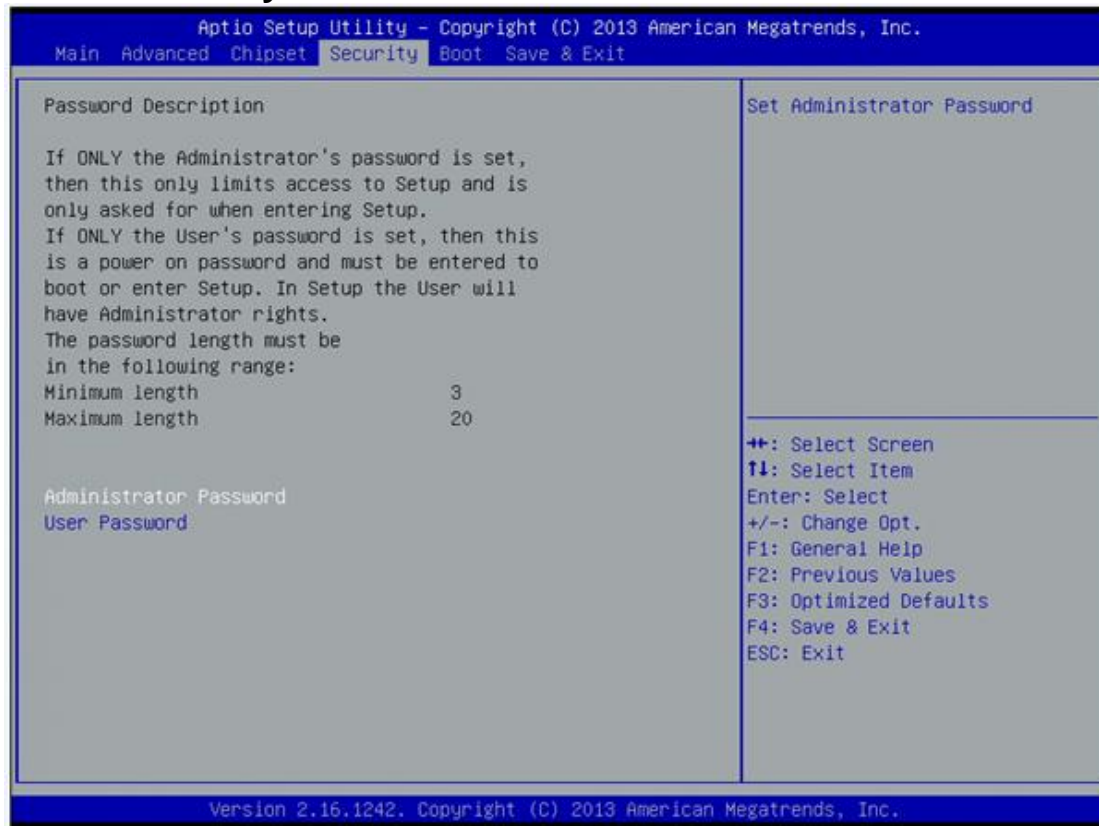

3.6 Boot Menu

The Boot menu allows users to change boot options of the system. You can select any of the items in the left frame of the screen to go to the sub menus:



Setup Prompt Timeout

Set the Timeout for wait press key to enter Setup Menu.

Bootup NumLock State

Use this item to select the power-on state for the NumLock. The default setting is on.

Quiet Boot

Use this item to enable or disable the Quiet Boot state. The default setting is disable.

Legacy Pxe OPRM

Use this item to enable or disable the reboot Execution Environment. The default setting is disable.

Boot Option Priorities

Specifies the overall boot order from the available devices.

3.7 Save&Exit

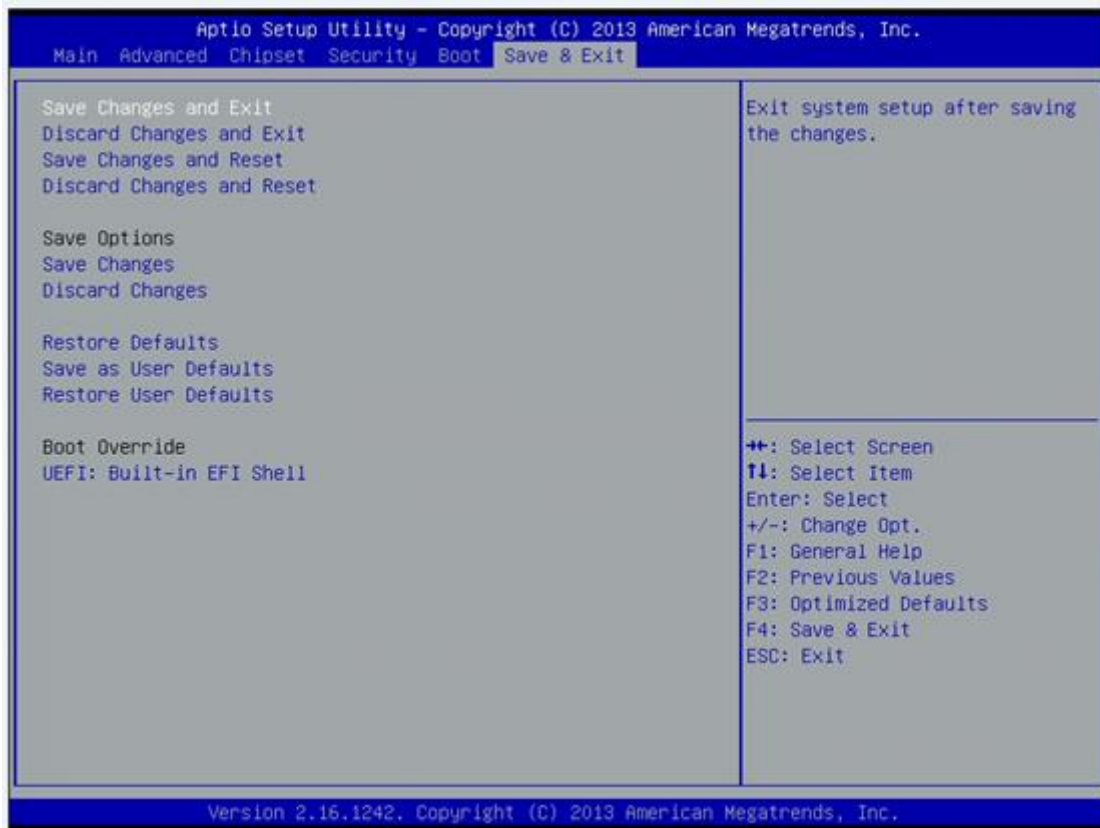

This page is intentionally left blank.

Chapter 4

Drivers Installation

4.1 System

GOT5152T-834 supports Windows 7, Windows 8/8.1, WES 7 and WE8S. To facilitate the installation of system driver, please carefully read the instructions in this chapter before start installing.

4.1.1 Win 7

1. Insert Driver CD and select the “\Drivers”.

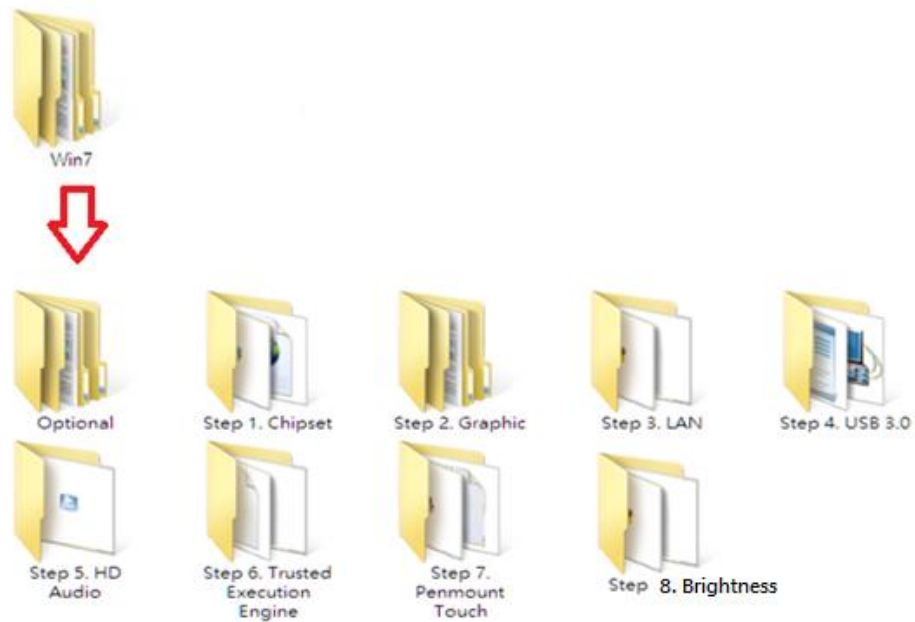

2. Select all files and follow the installing procedure.



NOTE Please install Microsoft KB2685811 before TXE installation under Windows 7, then installing the drivers.



NOTE If graphic driver isn't installed under Win7 or Win 8.x, only VGA function can be waked up when VGA and DP in hibernate mode. In order to solve this issue, user needs to re-start the computer or ensure the graphic driver is installed properly.

4.1.2 Win 8/8.x

1. Insert Driver CD and select the "\Drivers".

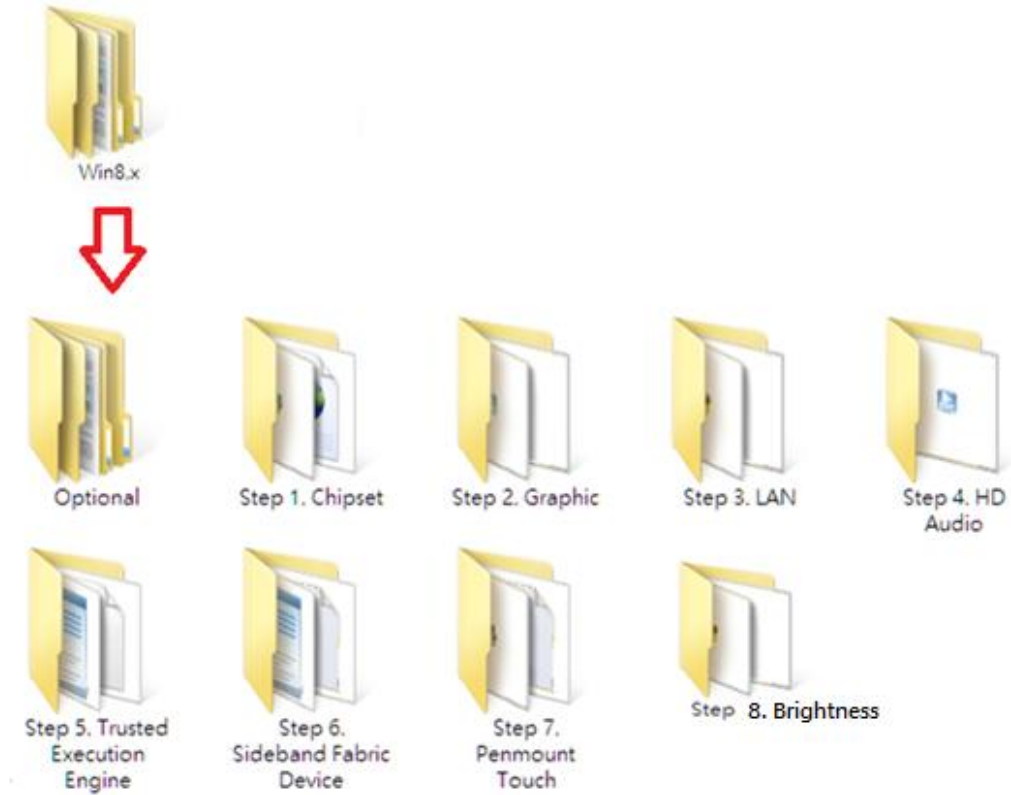

2. Select all files and follow the installing procedure.

4.2 Touch Screen

The GOT5152T-834 uses the 5-wire analog resistive. There are the specification and driver installation which are listed below.

4.2.1 Specification

Touch Screen	5-wire Analog Resistive type
Touch Screen Controller	PenMount 6000 USB Touch Screen Controller IC
Communications	USB interface
Resolution	1024 x 1024
Power Input	5V
Power Consumption	Active: 24.6mA / Idle Mode: 13.4mA

4.2.2 Driver Installation- Windows 7/8.x

The GOT5152T-834 provides a touch screen driver that users can install it under the operating system Windows 7/8.x. To facilitate installation of the touch screen driver, you should read the instructions in this chapter carefully before you attempt installation.

1. Insert Driver CD and follow the path to select the “\Drivers\Step 7 - Touch”.

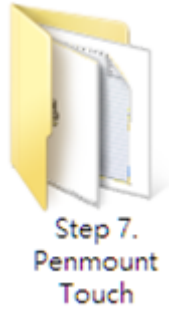

2. Follow the installing procedure and press OK.
3. Click Start menu and select “PenMount Utilities”; and then, a “PenMount Control Panel” pops out.

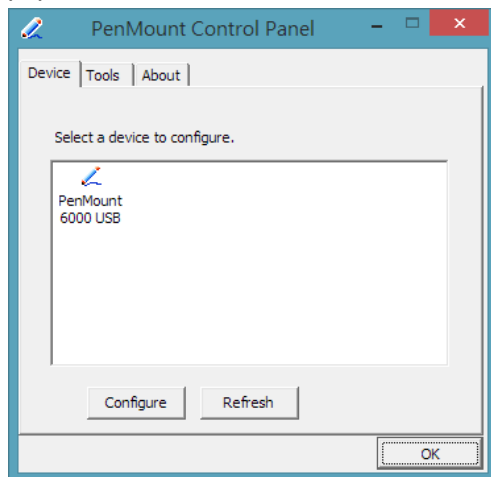

4. Select the "Standard Calibrate" tab.

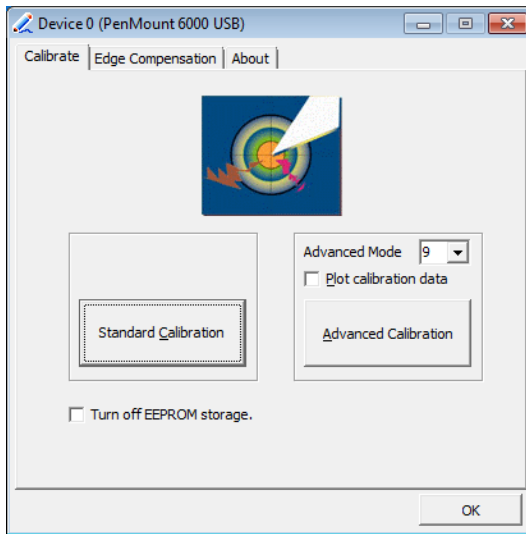

5. Calibration:

To adjust the display with touch panel, click "Calibration" and follow the calibrate point to do calibration; there are five points on screen for calibration.

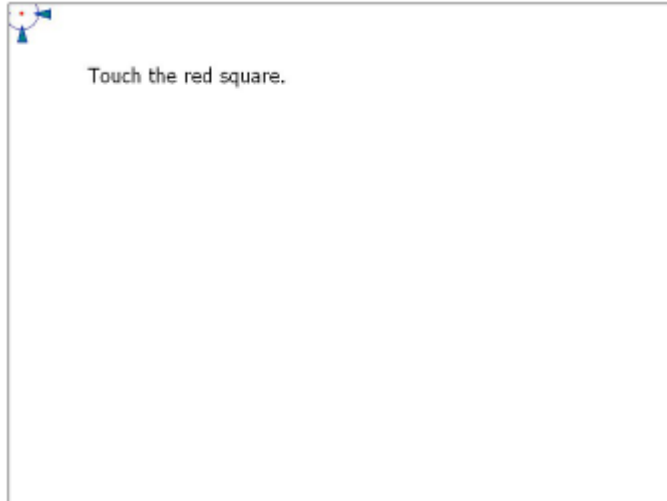

6. Press OK.

4.3 Embedded O.S.

The GOT5152T-834 provides the WES 7 and WE8S Embedded. The O.S. is supported devices which are listed below.

4.3.1 WES 7 & WE8S

Here are supported onboard devices:

- Onboard Multi I/O
- SATA HDD
- USB
- CRT/LCD display
- 10/100/1000 base-T Ethernet
- CFast™ or mSATA
- Onboard Audio
- Touch Screen

PenMount Touch screen

Before you can use and calibrate it, here is what you should do:

1. Set up Penmount touch device driver by executing C:\Penmount\ Windows 2000-XP V5.0\setup.exe. When the installation is finished, an icon "PM" appears on the Taskbar.
2. Calibrate Penmount touch by clicking on the "PM" icon, and the go on the calibration.
3. Restart the computer.

This page is intentionally left blank.

Appendix A

Watchdog Timer

About Watchdog Timer

Software stability is major issue in most application. Some embedded systems are not watched by human for 24 hours. It is usually too slow to wait for someone to reboot when computer hangs. The systems need to be able to reset automatically when things go wrong. The watchdog timer gives us solution.

The watchdog timer is a counter that triggers a system reset when it counts down to zero from a preset value. The software starts counter with an initial value and must reset it periodically. If the counter ever reaches zero which means the software has crashed, the system will reboot.

How to Use Watchdog Timer

The I/O port base addresses of watchdog timer are 2E (hex) and 2F (hex). The 2E (hex) and 2F (hex) are address and data port respectively.

Assume that program A is put in a loop that must execute at least once every 10ms. Initialize watchdog timer with a value bigger than 10ms. If the software has no problems; watchdog timer will never expire because software will always restart the counter before it reaches zero.

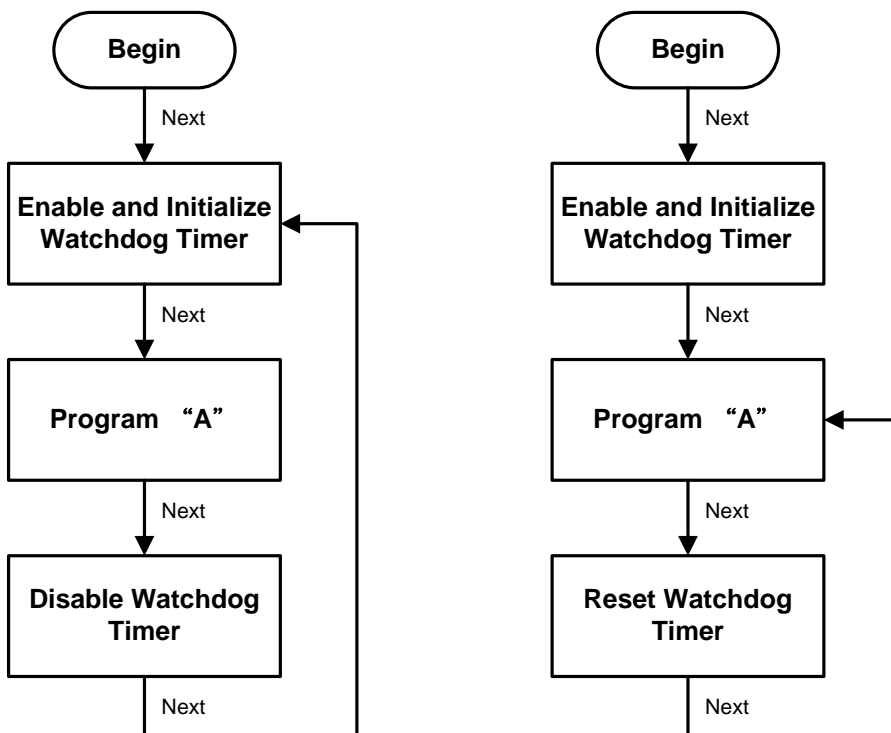

WDT Sample Program

Enable WDT

1. Enable configuration
 - O 2E 87
 - O 2E 87
2. Select Logic device:
 - O 2E 07
 - O 2F 08
3. WDT Device Enable
 - O 2E 30
 - O 2F 01
4. Set timer unit
 - O 2E F0
 - O 2F 00 → (00: Sec; 08: Minute)
5. Set base timer:
 - O 2E F1
 - O 2F 0A → Set Reset Time (Ex.0A:10 Sec)

Disable WDT

1. Enable configuration
 - O 2E 87
 - O 2E 87
2. Select Logic device:
 - O 2E 07
 - O 2F 08
3. WDT Device Disable
 - O 2E 30
 - O 2F 00

Digital I/O Software Programming

- I2C to GPIO PCA9535PW GPIO
- I2C address: 0b01000000.

Command byte

The command byte is the first byte to follow the address byte during a write transmission. It is used as a pointer to determine which of the following registers will be written or read.

Table 4. Command byte

Command	Register
0	Input port 0
1	Input port 1
2	Output port 0
3	Output port 1
4	Polarity Inversion port 0
5	Polarity Inversion port 1
6	Configuration port 0
7	Configuration port 1

Registers 0 and 1: Input port registers

This register is an input-only port. It reflects the incoming logic levels of the pins, regardless of whether the pin is defined as an input or an output by Register 3. Writes to this register have no effect.

The default value 'X' is determined by the externally applied logic level.

Table 5. Input port 0 Register

Bit	7	6	5	4	3	2	1	0
Symbol	I0.7	I0.6	I0.5	I0.4	I0.3	I0.2	I0.1	I0.0
Default	X	X	X	X	X	X	X	X

Table 6. Input port 1 register

Bit	7	6	5	4	3	2	1	0
Symbol	I1.7	I1.6	I1.5	I1.4	I1.3	I1.2	I1.1	I1.0
Default	X	X	X	X	X	X	X	X

Registers 2 and 3: Output port registers

This register is an output-only port. It reflects the outgoing logic levels of the pins defined as outputs by Registers 6 and 7. Bit values in this register have no effect on pins defined as inputs. In turn, reads from this register reflect the value that is in the flip-flop controlling the output selection, **not** the actual pin value.

Table 7. Output port 0 register

Bit	7	6	5	4	3	2	1	0
Symbol	O0.7	O0.6	O0.5	O0.4	O0.3	O0.2	O0.1	O0.0
Default	1	1	1	1	1	1	1	1

Table 8. Output port 1 register

Bit	7	6	5	4	3	2	1	0
Symbol	O1.7	O1.6	O1.5	O1.4	O1.3	O1.2	O1.1	O1.0
Default	1	1	1	1	1	1	1	1

Registers 4 and 5: Polarity Inversion registers

This register allows the user to invert the polarity of the Input port register data. If a bit in this register is set (written with '1'), the Input port data polarity is inverted. If a bit in this register is cleared (written with a '0'), the Input port data polarity is retained.

Table 9. Polarity Inversion port 0 register

Bit	7	6	5	4	3	2	1	0
Symbol	N0.7	N0.6	N0.5	N0.4	N0.3	N0.2	N0.1	N0.0
Default	0	0	0	0	0	0	0	0

Table 10. Polarity Inversion port 1 register

Bit	7	6	5	4	3	2	1	0
Symbol	N1.7	N1.6	N1.5	N1.4	N1.3	N1.2	N1.1	N1.0
Default	0	0	0	0	0	0	0	0

Registers 6 and 7: Configuration registers

This register configures the directions of the I/O pins. If a bit in this register is set (written with '1'), the corresponding port pin is enabled as an input with high-impedance output driver. If a bit in this register is cleared (written with '0'), the corresponding port pin is enabled as an output. At reset, the device's ports are inputs.

Table 11. Configuration port 0 register

Bit	7	6	5	4	3	2	1	0
Symbol	C0.7	C0.6	C0.5	C0.4	C0.3	C0.2	C0.1	C0.0
Default	1	1	1	1	1	1	1	1

Table 12. Configuration port 1 register

Bit	7	6	5	4	3	2	1	0
Symbol	C1.7	C1.6	C1.5	C1.4	C1.3	C1.2	C1.1	C1.0
Default	1	1	1	1	1	1	1	1

Appendix B

Backlight Control

About Backlight Control

Axiomtek offers the backlight control tool under Windows 7 and Windows 8, people can adjust the panel backlight depending on your personal taste and the amount of ambient light in the room after installing the backlight control tool.

How to Use Backlight Control

Step 1 According to the OS version, please insert the driver CD and follow the path to select the proper driver, “\Driver\Win8.x\Step 8 – BrightnessSync” or “\Driver\Win7\Step 8 - BrightnessSync”.

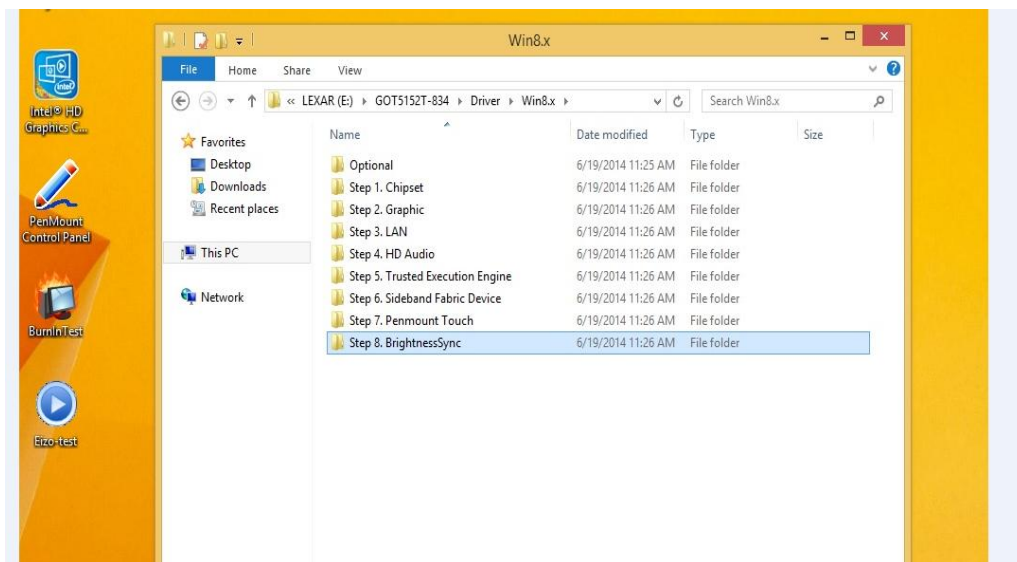

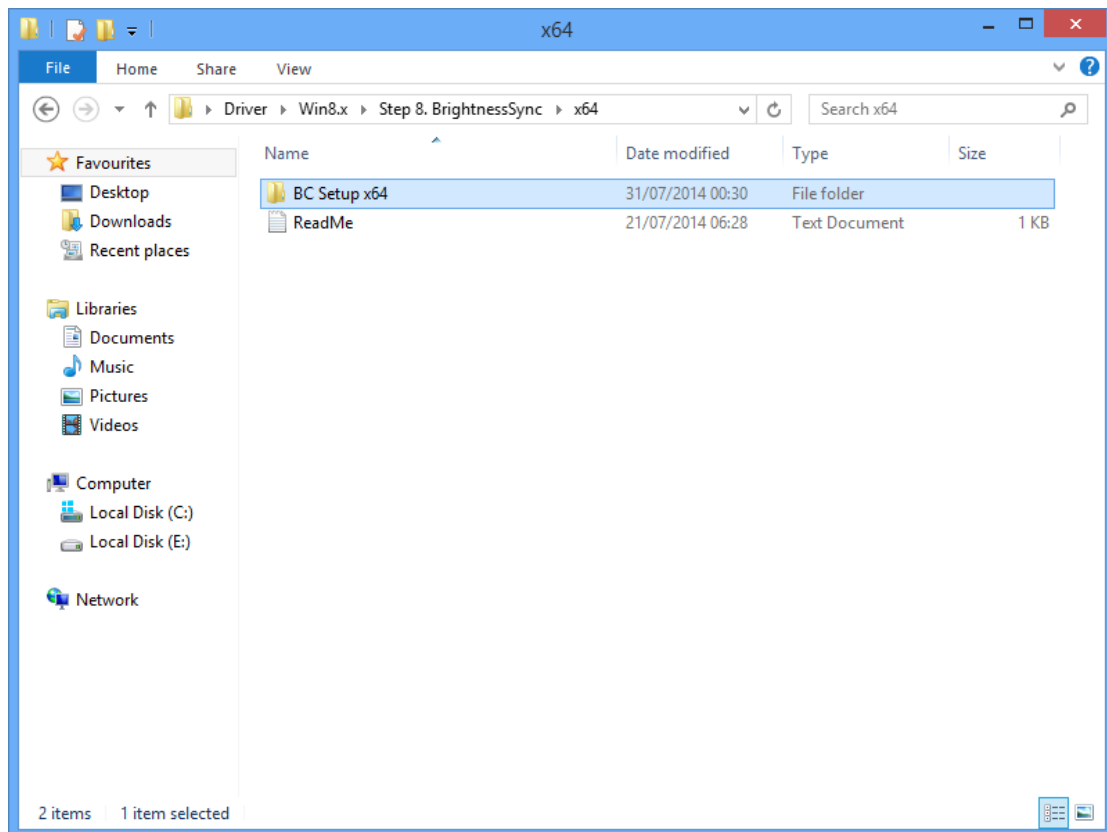
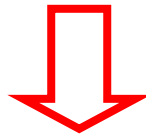
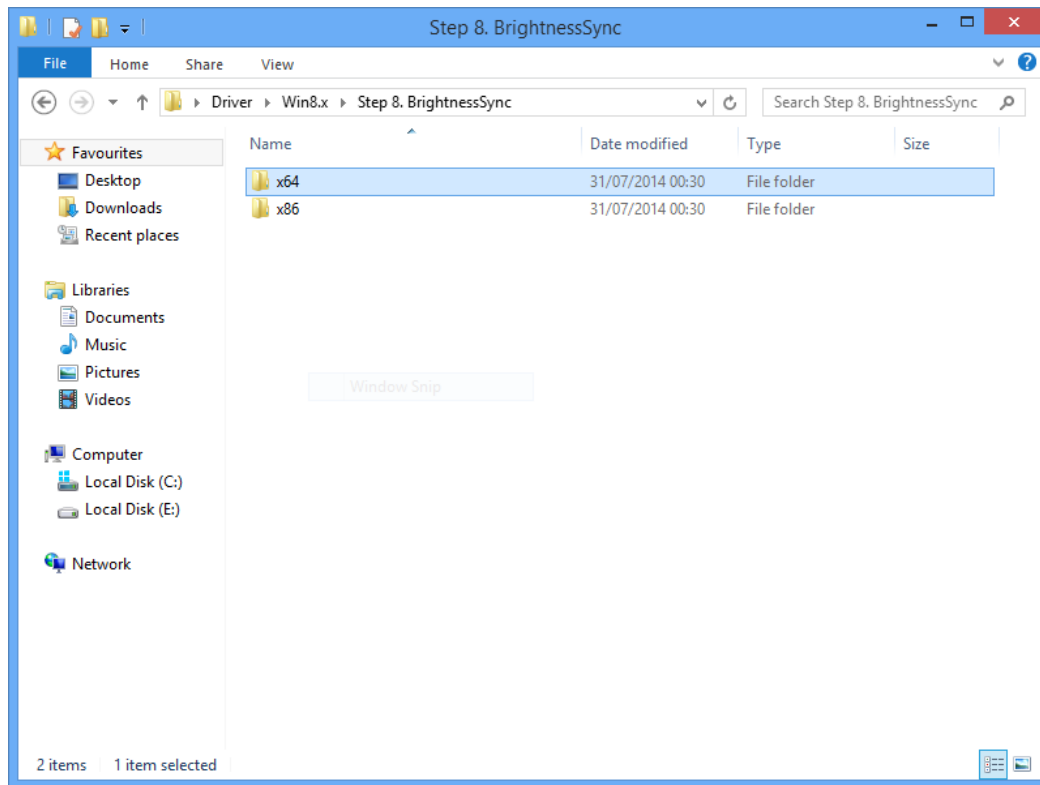

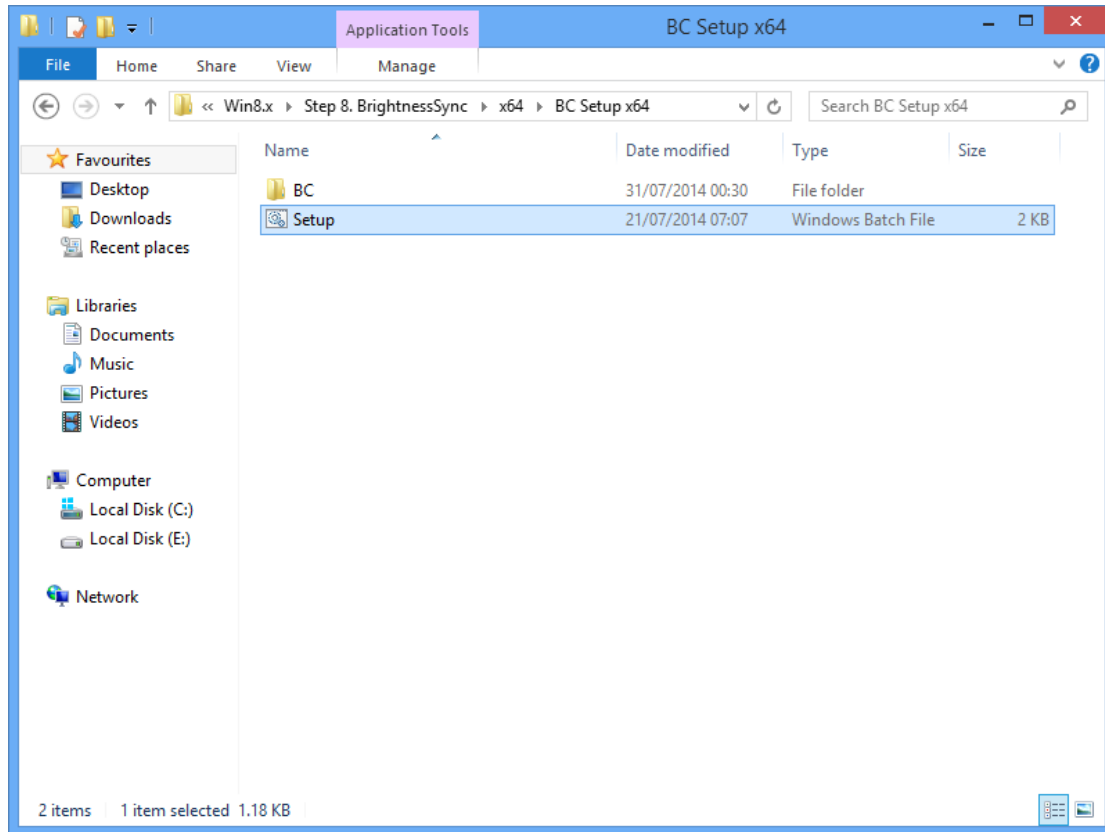
Step 2 Follow the installing procedures and press “Close”.

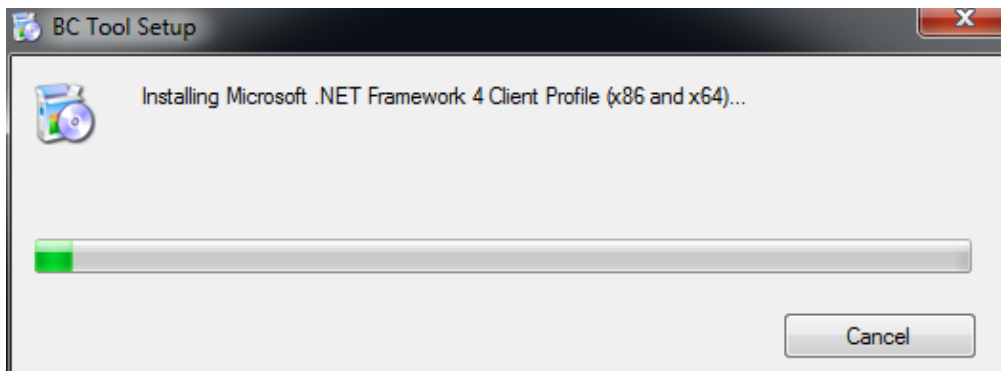
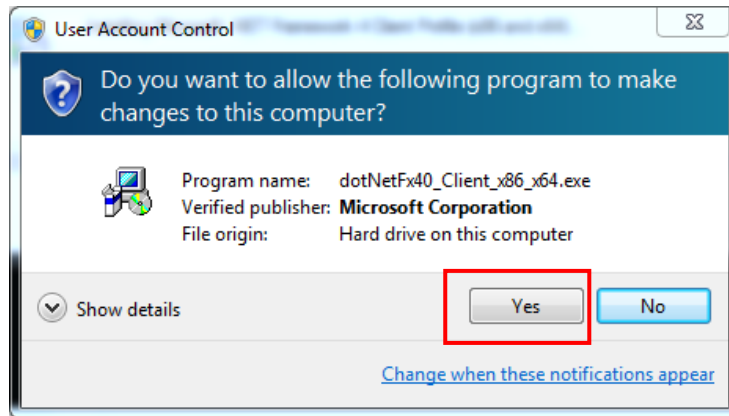
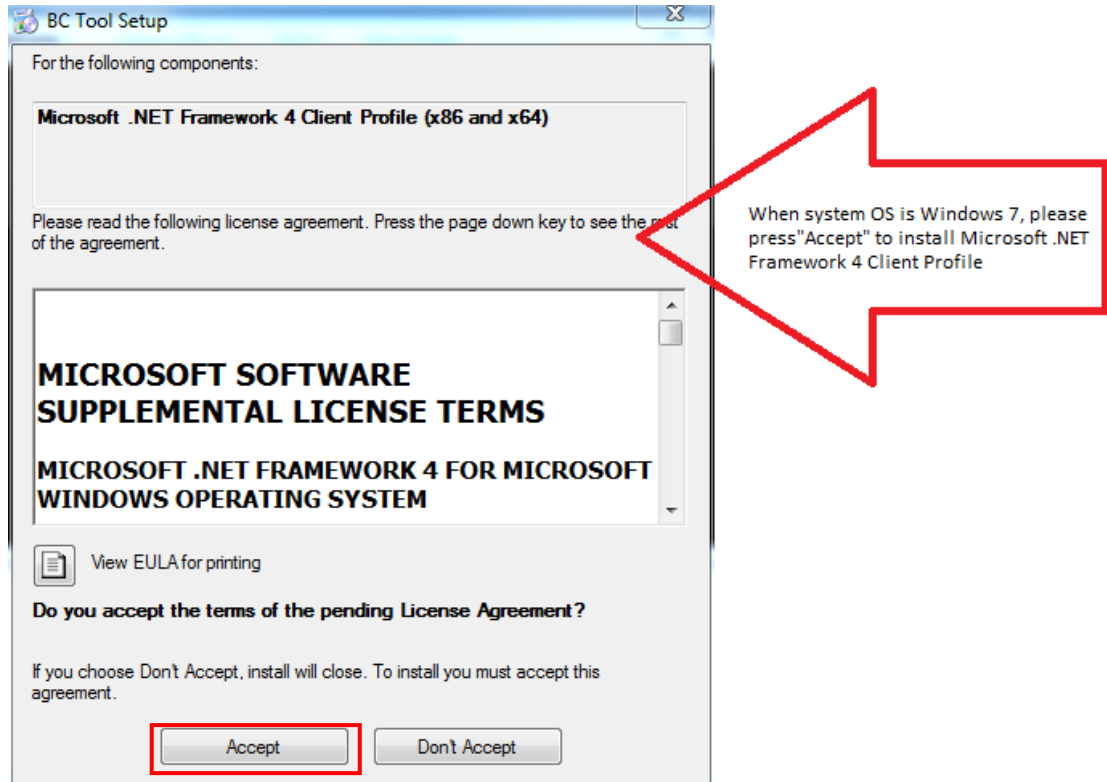

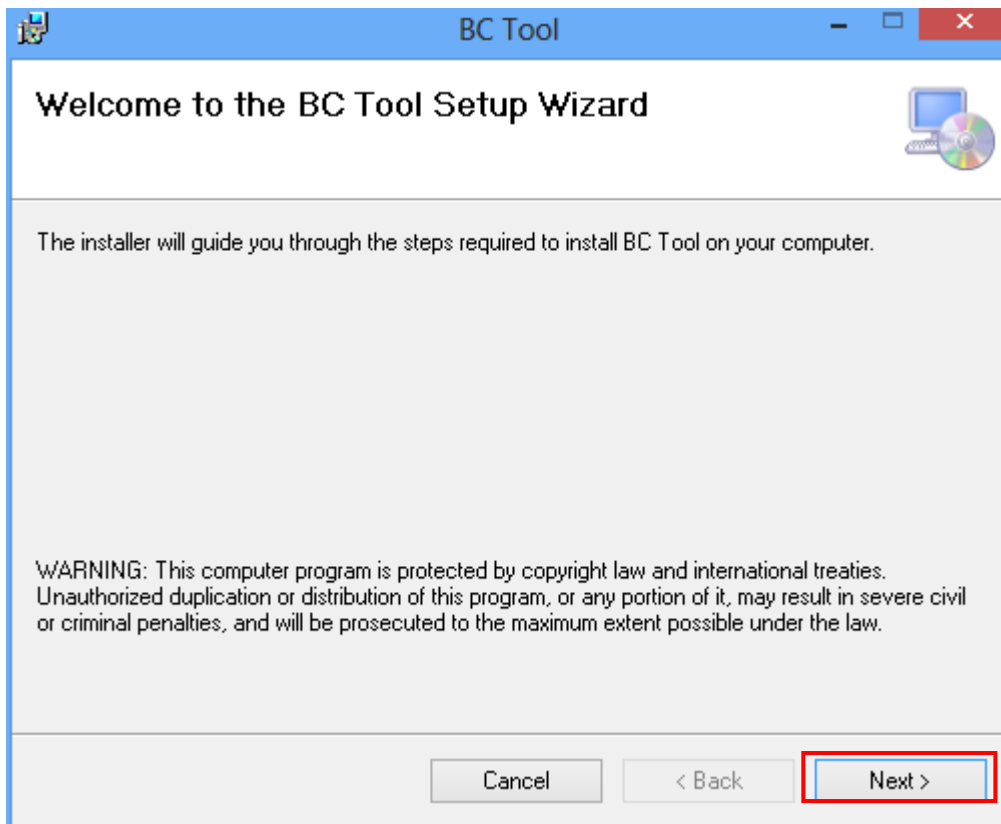

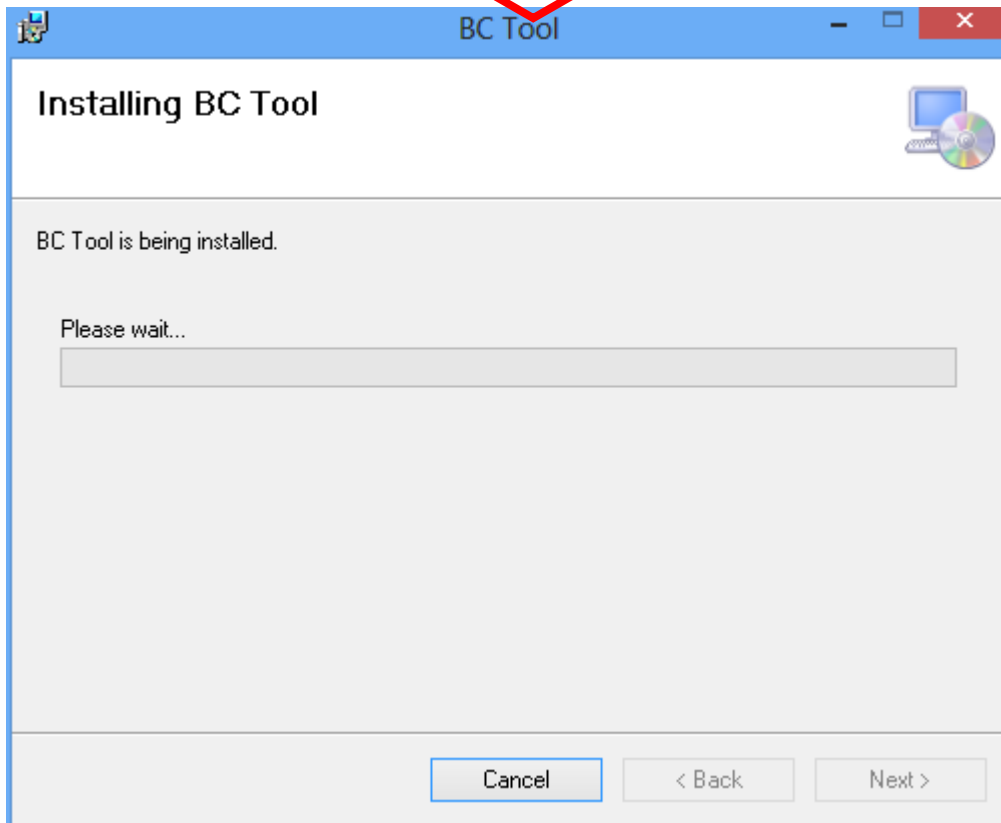
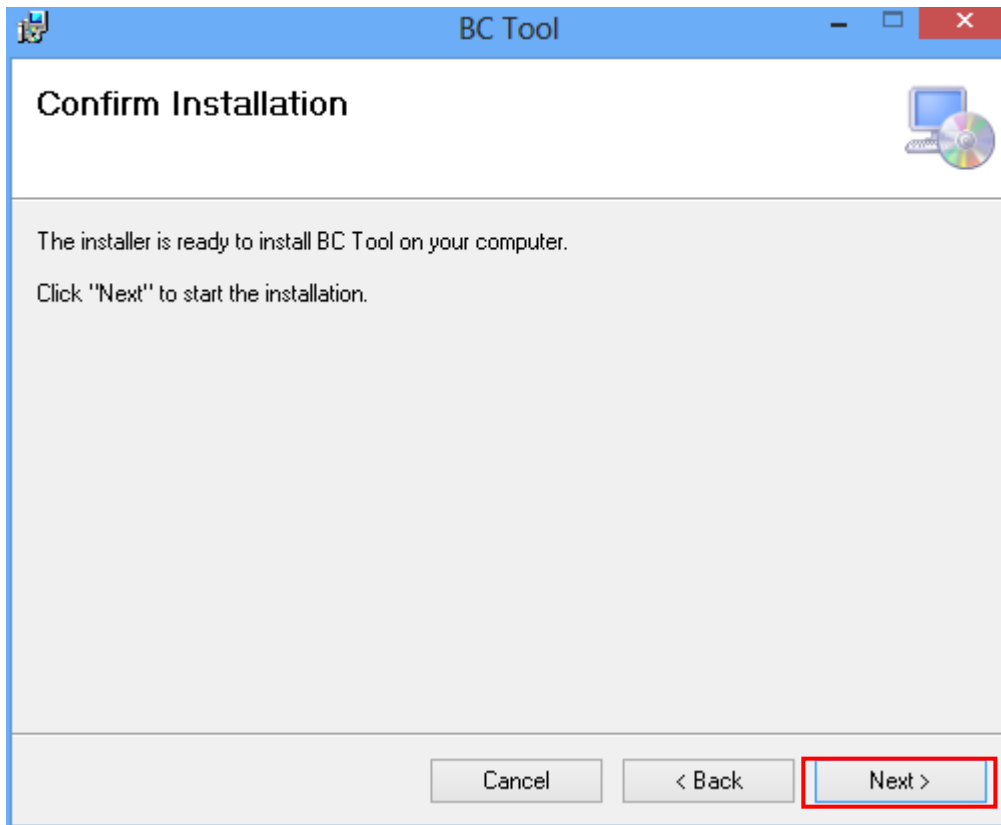

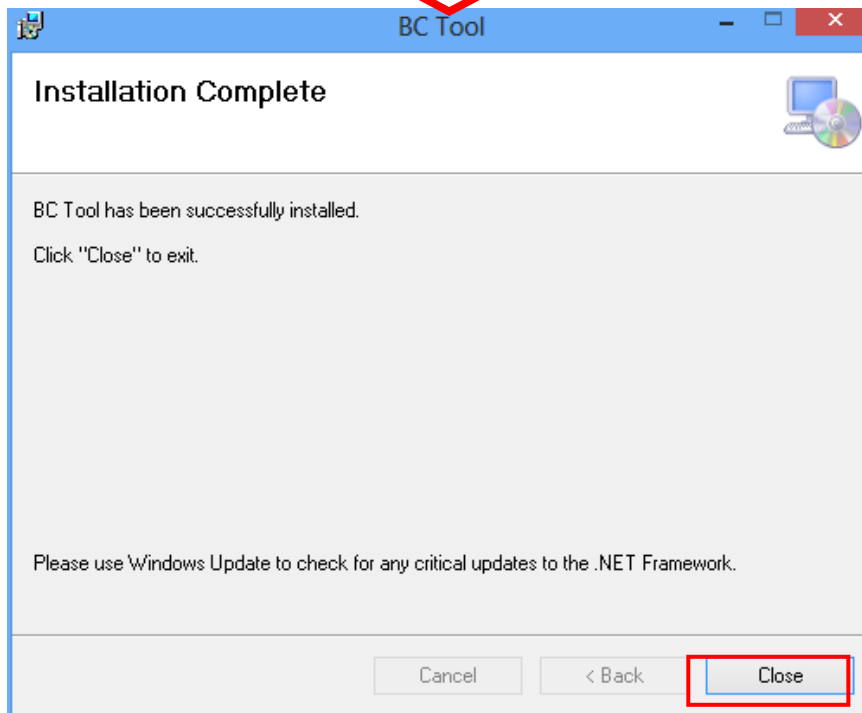
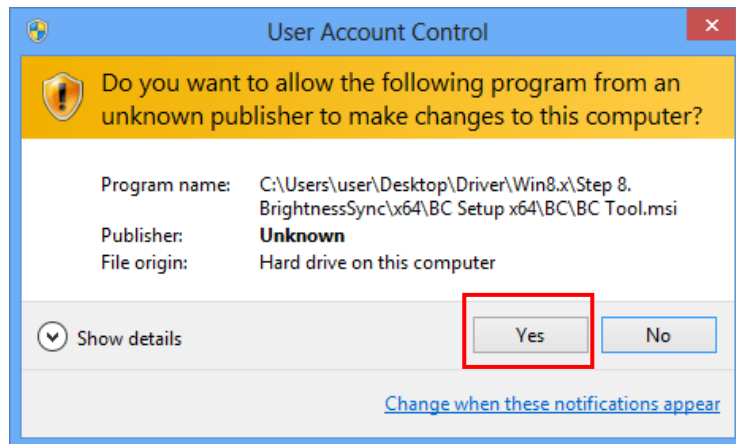

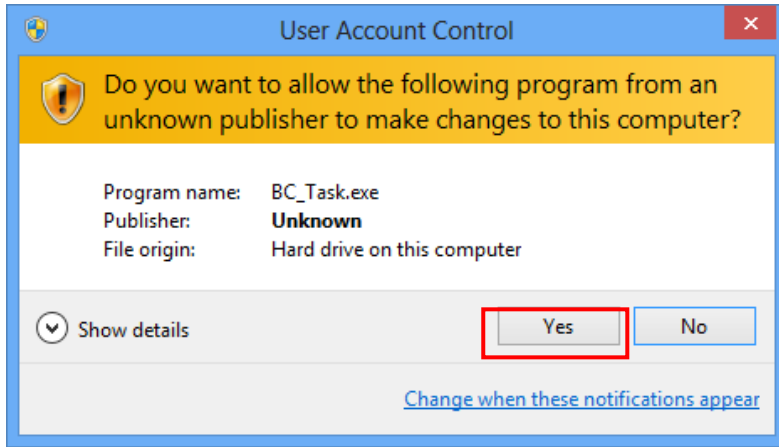

Step 3 System auto reboot, installation completed.

Step 4 Select “△” icon then find out the “Axiomtek” to ensure the brightness driver is installed appropriately.

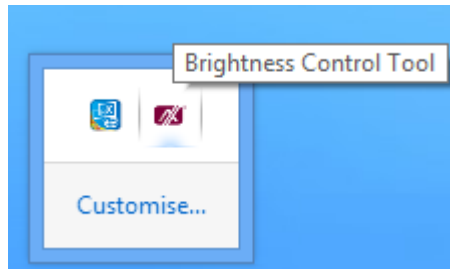

Step 5 How to use the brightness Control

There are two ways to adjust the display brightness.

Step 5.1 Click the “Brightness” to adjust the display brightness with the bar. *(For Windows 8.x only.)*

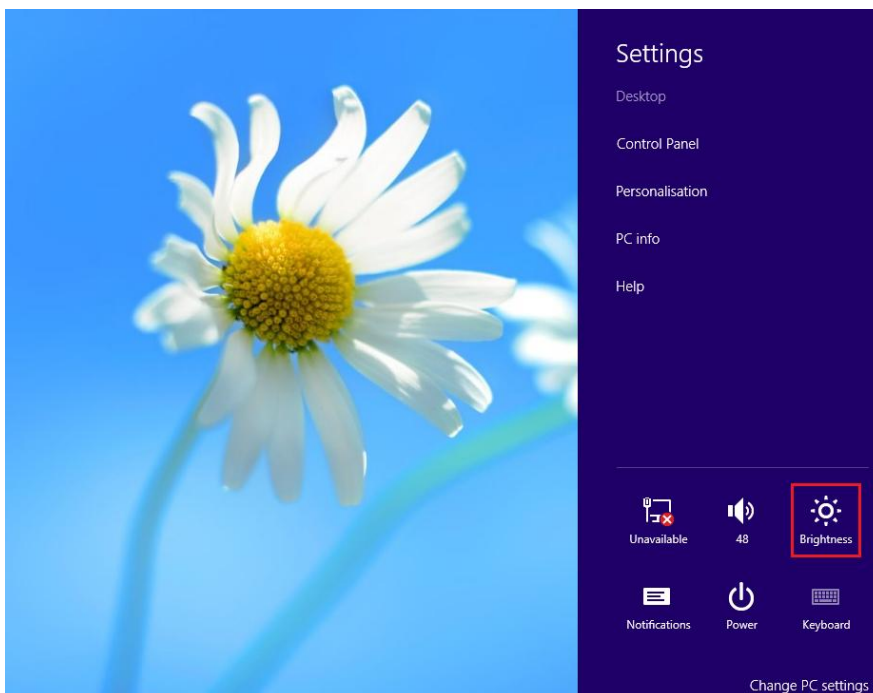

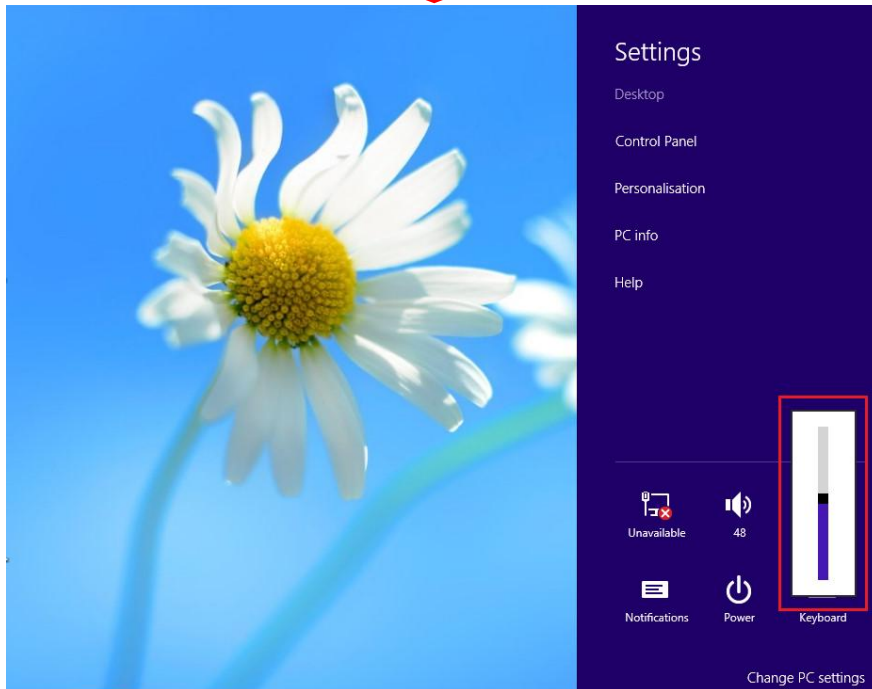

Step 5.2. Click the “Control Panel” then select “Power Options” to adjust the display brightness.

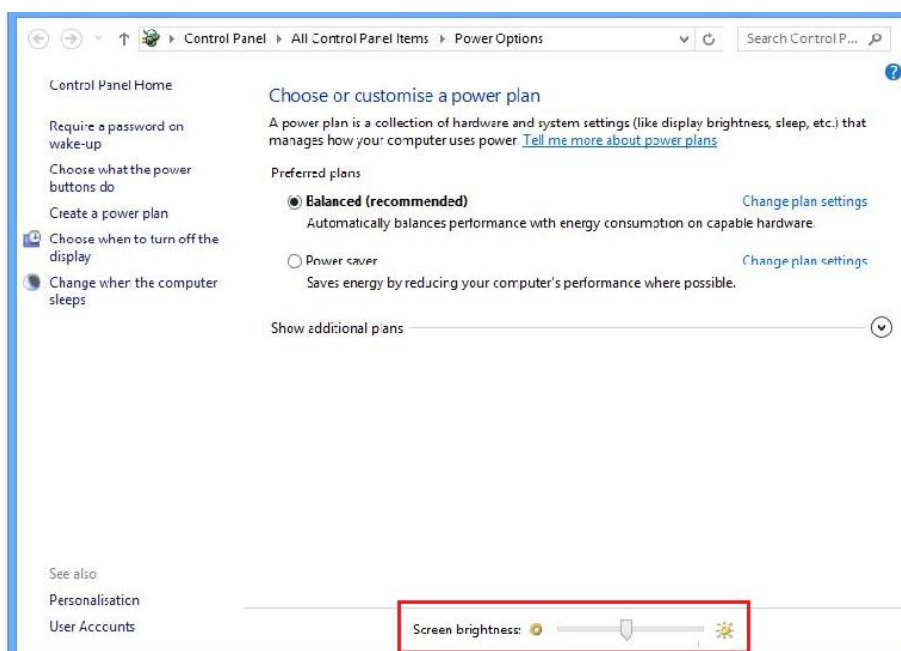

Removed Brightness Control Tool

Step 1 According to the OS version, please insert the driver CD and follow the path to select the proper driver, “\Driver\Win8.x\Step 8 – Setup” or “\Driver\Win7\Step 8 - Setup”.

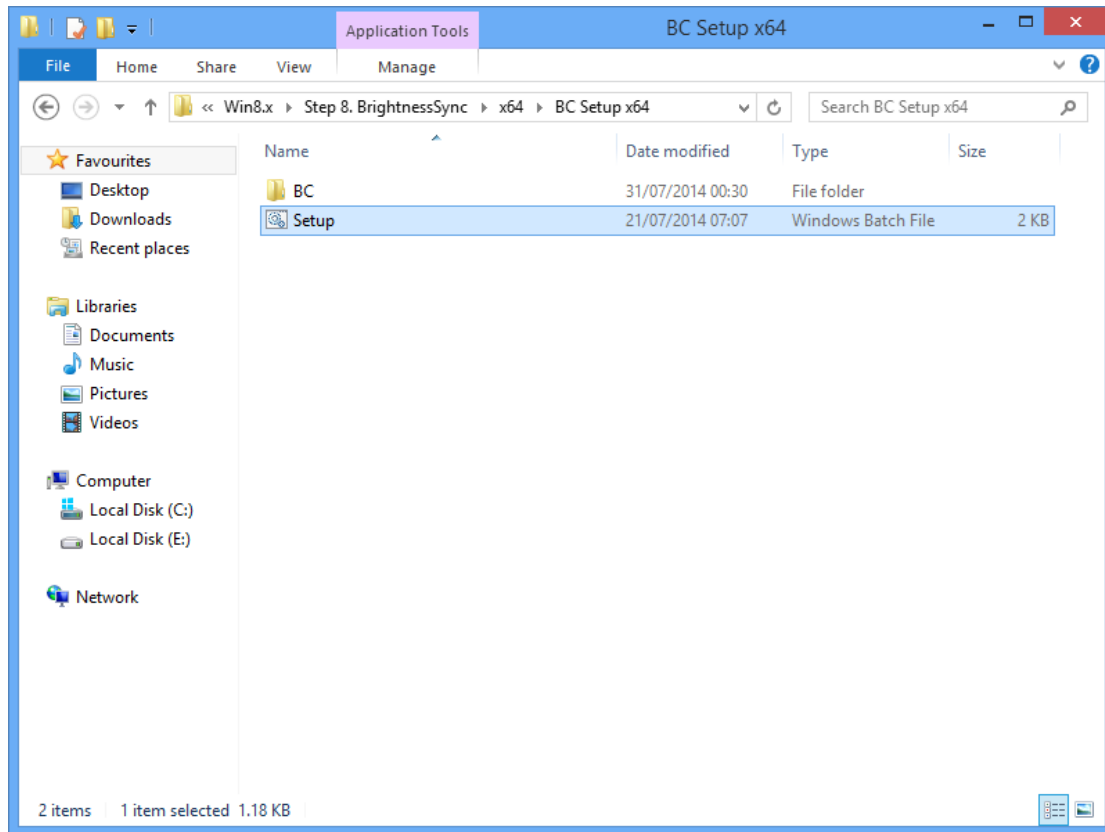

Step 2 Follow the procedures and press "Close".

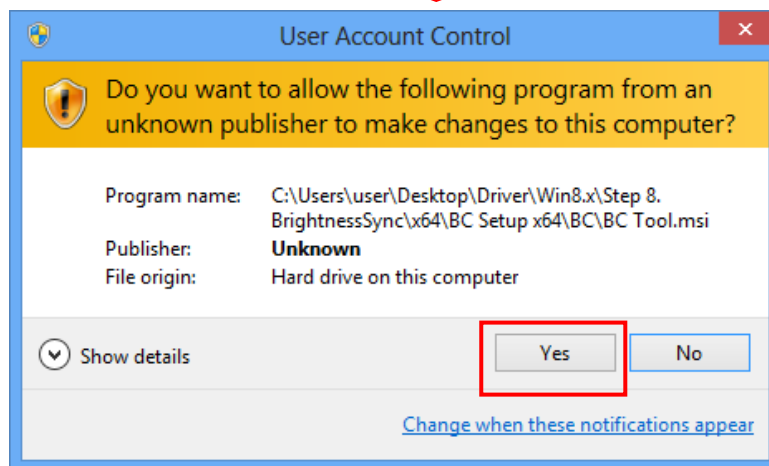
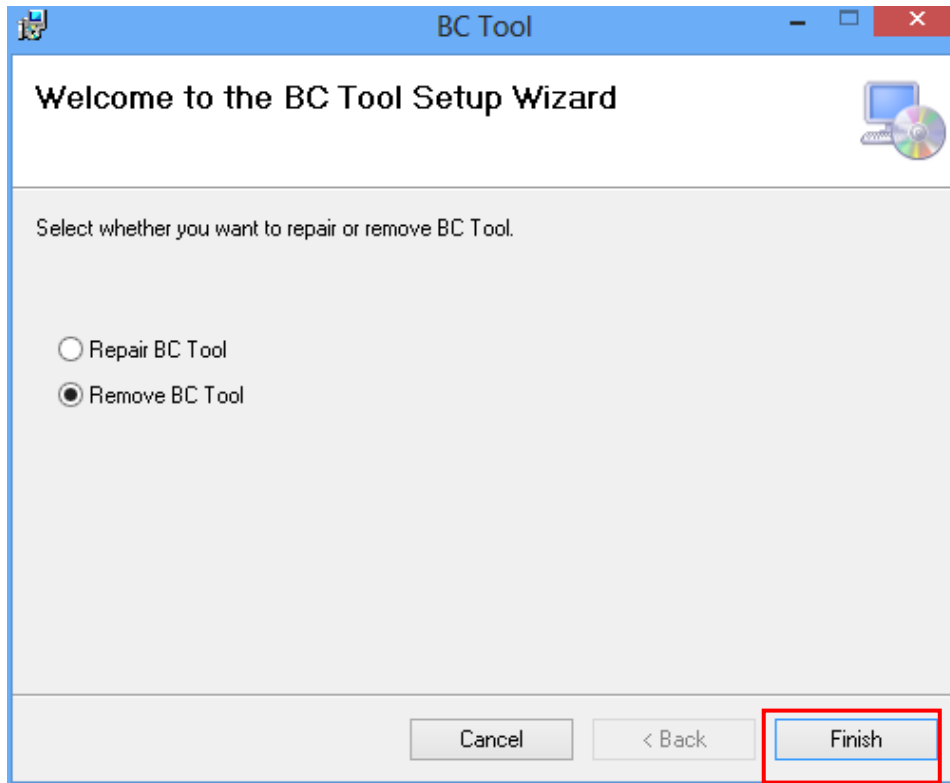

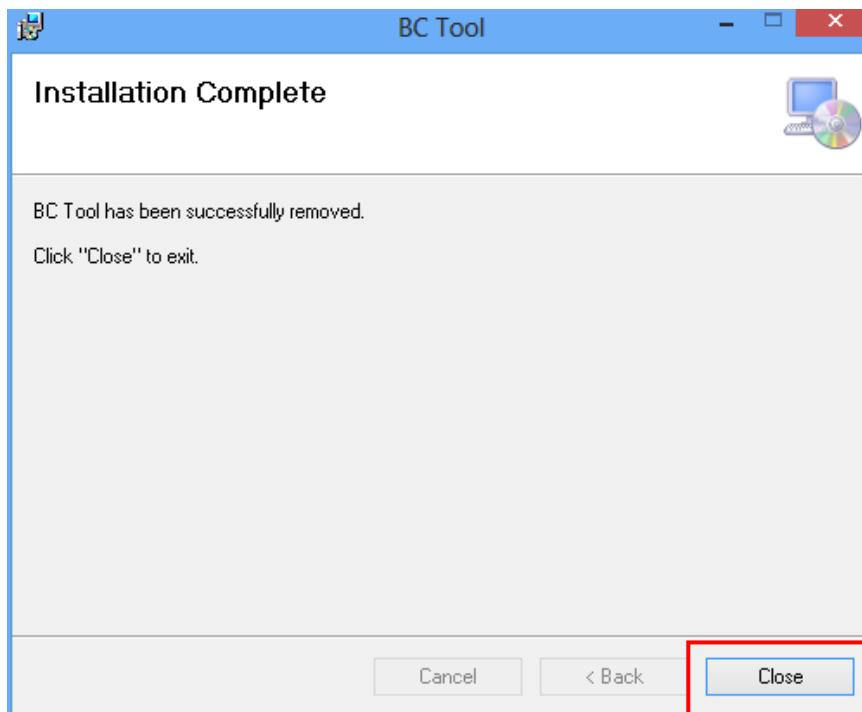
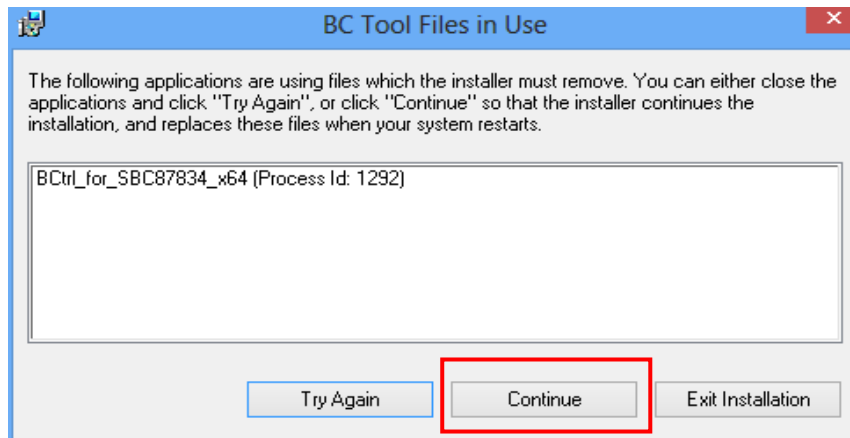

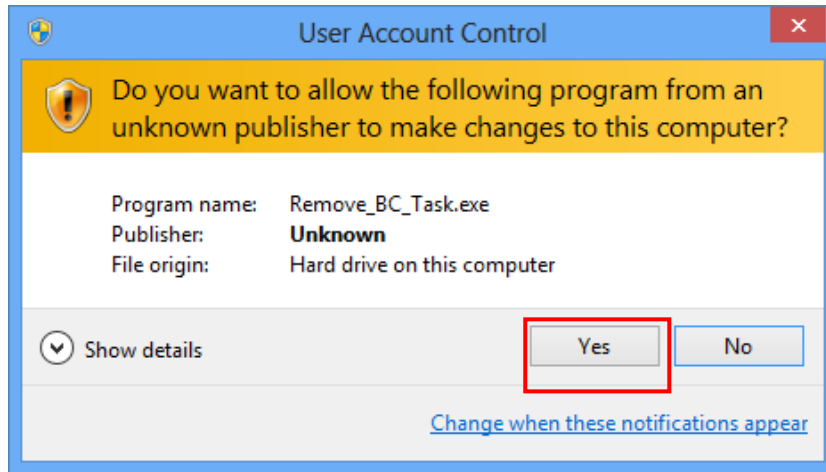

Step 3 System auto reboot, uninstallation completed.

This page is intentionally left blank.