



®

AXIOMTEK

IPC932-230-FL Series

Industrial and Fanless Computers

User's Manual



Disclaimers

This manual has been carefully checked and believed to contain accurate information. Axiomtek Co., Ltd. assumes no responsibility for any infringements of patents or any third party's rights, and any liability arising from such use.

Axiomtek does not warrant or assume any legal liability or responsibility for the accuracy, completeness or usefulness of any information in this document. Axiomtek does not make any commitment to update the information in this manual.

Axiomtek reserves the right to change or revise this document and/or product at any time without notice.

No part of this document may be reproduced, stored in a retrieval system, or transmitted, in any form or by any means, electronic, mechanical, photocopying, recording, or otherwise, without the prior written permission of Axiomtek Co., Ltd.

©Copyright 2019 Axiomtek Co., Ltd.

All Rights Reserved

June 2019, Version A2

Printed in Taiwan

Safety Precautions

Before getting started, please read the following important safety precautions.

1. The IPC932-230-FL Series does not come equipped with an operating system. An operating system must be loaded first before installing any software into the computer.
2. Be sure to ground yourself to prevent static charge when installing the internal components. Use a grounding wrist strap and place all electronic components in any static-shielded devices. Most electronic components are sensitive to static electrical charge.
3. Disconnect the power cord from the IPC932-230-FL Series before making any installation. Be sure both the system and the external devices are turned OFF. Sudden surge of power could ruin sensitive components. Make sure the IPC932-230-FL Series is properly grounded.
4. Make sure the voltage of the power source is correct before connecting the equipment to the power outlet.
5. Turn OFF the system power before cleaning. Clean the system using a cloth only. Do not spray any liquid cleaner directly onto the screen.
6. Do not leave this equipment in an uncontrolled environment where the storage temperature is below -20°C or above 80°C . It may damage the equipment.
7. Do not open the system's back cover. If opening the cover for maintenance is a must, only a trained technician is allowed to do so. Integrated circuits on computer boards are sensitive to static electricity. To avoid damaging chips from electrostatic discharge, observe the following precautions:
 - Before handling a board or integrated circuit, touch an unpainted portion of the system unit chassis for a few seconds. This will help to discharge any static electricity on your body.
 - When handling boards and components, wear a wrist-grounding strap, available from most electronic component stores.

Classification

1. Degree of protection against electric shock: not classified
2. Degree of protection against the ingress of water: IPX0
3. Equipment not suitable for use in the presence of a flammable anesthetic mixture with air or with oxygen or nitrous oxide.
4. Mode of operation: Continuous
5. Type of protection against electric shock: Class I equipment

General Cleaning Tips

You may need the following precautions before you begin to clean the computer. When you clean any single part or component for the computer, please read and understand the details below fully.

When you need to clean the device, please rub it with a piece of dry cloth.

1. Be cautious of the tiny removable components when you use a vacuum cleaner to absorb the dirt on the floor.
2. Turn the system off before you start to clean up the component or computer.
3. Never drop the components inside the computer or get circuit board damp or wet.
4. Be cautious of all kinds of cleaning solvents or chemicals when you use it for the sake of cleaning. Some individuals may be allergic to the ingredients.
5. Try not to put any food, drink or cigarette around the computer.

Cleaning Tools:

Although many companies have created products to help improve the process of cleaning your computer and peripherals users can also use household items to clean their computers and peripherals. Below is a listing of items you may need or want to use while cleaning your computer or computer peripherals.

Keep in mind that some components in your computer may only be able to be cleaned using a product designed for cleaning that component, if this is the case it will be mentioned in the cleaning.

- **Cloth:** A piece of cloth is the best tool to use when rubbing up a component. Although paper towels or tissues can be used on most hardware as well, we still recommend you to rub it with a piece of cloth.
- **Water or rubbing alcohol:** You may moisten a piece of cloth a bit with some water or rubbing alcohol and rub it on the computer. Unknown solvents may be harmful to the plastics parts.
- **Vacuum cleaner:** Absorb the dust, dirt, hair, cigarette particles, and other particles out of a computer can be one of the best methods of cleaning a computer. Over time these items can restrict the airflow in a computer and cause circuitry to corrode.
- **Cotton swabs:** Cotton swabs moistened with rubbing alcohol or water are excellent tools for wiping hard to reach areas in your keyboard, mouse, and other locations.
- **Foam swabs:** Whenever possible it is better to use lint free swabs such as foam swabs.



Note: *It is strongly recommended that you should shut down the system before you start to clean any single components.*

Please follow the steps below:

1. Close all application programs
2. Close operating software
3. Turn off power switch
4. Remove all device
5. Pull out power cable

Scrap Computer Recycling

If the computer equipments need the maintenance or are beyond repair, we strongly recommended that you should inform your Axiomtek distributor as soon as possible for the suitable solution. For the computers that are no longer useful or no longer working well, please contact your Axiomtek distributor for recycling and we will make the proper arrangement.

Trademarks Acknowledgments

Axiomtek is a trademark of Axiomtek Co., Ltd., PC/AT, PS/2, VGA are trademarks of International Business Machines Corporation.

AMI are trademarks of American Megatrend Inc.

Intel® Core™ i3 LGA1150 Desktop Processor,

Intel® Core™ i5 LGA1150 Desktop Processor,

Intel® Core™ i7 LGA1150 Desktop Processor,

are registered trademarks of Intel Corporation.

Other brand names and trademarks are the properties and registered brands of their respective owners.

Table of Contents

Safety Precautions	iii
Classification	iv
General Cleaning Tips	iv
Scrap Computer Recycling	vi
CHAPTER 1 INTRODUCTION	1
1.1 General Description	1
1.2 System Specifications	2
1.2.1 Main CPU Board	2
1.2.2 I/O System	2
1.2.3 System Specification	3
1.3 Dimensions	4
1.4 I/O Outlets	5
1.5 Packing List	6
1.6 Jumper Settings	7
1.6.1 Audio Amplifier Selection (JP3)	7
1.6.2 Restore BIOS Optimal Defaults (JP1)	7
1.7 Connectors	8
1.7.1 Digital I/O Connector (CN1)	9
1.7.2 Inverter Connectors (CN5)	9
1.7.3 Internal USB 2.0 Connectors (CN10, CN12)	9
1.7.4 Front Panel Connector (CN3)	10
1.7.5 External USB 3.0 Connectors (CN11 and CN9)	11
1.7.6 Internal Keyboard and Mouse Connectors (CN8)	11
1.7.7 FAN Connectors (FAN1, FAN2)	12
1.7.8 Ethernet Ports (LAN1 and LAN2)	12
1.7.9 Serial ATA Connectors (SATA1~SATA2)	13
1.7.10 CFast™ Socket (SCF1)	14
1.7.11 COM Connectors (COM1~COM4)	15
1.7.12 Intel® HD Audio Digital Header (AUDIO1)	15
CHAPTER 2 HARDWARE INSTALLATION	17
2.1 Installing the Processor	17
2.2 Installing the Memory Module	19
2.3 Installing the Hard Disk Drive	20
2.4 Installing the PCI or PCIe Card	21
2.5 Installing the optional Fan Module	22
CHAPTER 3 AMI BIOS UTILITY	23
3.1 Starting	23
3.2 Navigation Keys	24
3.3 Main Menu	25
3.4 Advanced Menu	26
3.5 Chipset Menu	38
3.6 Boot Menu	42

3.7 Security Menu 43
3.8 Save & Exit Menu 44

CHAPTER 1 INTRODUCTION



This chapter contains general information and a detailed specification of the IPC932-230-FL Series. Chapter 1 includes the following sections:

- General Description
- System Specifications
- Dimensions
- I/O Outlets
- Jumper Settings
- Connectors
- Package List

1.1 General Description

The IPC932-230-FL Series is a fanless system that can support LGA1150 socket for Intel® Core™ i7/i5/i3 processors. The IPC932-230-FL Series supports Windows® 7, and Windows® 8 and Windows® 7 embedded, and Fedora, suitable for the most endurable operation.

- The IPC932-230-FL Series support two hard-drive bays, which makes it easy to install for customer maintain the system.
- Embedded O.S. Supported

The IPC932-230-FL Series not only supports Windows® 7, but also supports embedded OS, such as Windows® 7 embedded. For storage device, the IPC932-230-FL Series supports two 2.5" HDD driver bay and one onboard CFast™ socket.

1.2 System Specifications

1.2.1 Main CPU Board

- CPU
 - Socket LGA1150 for 4th Generation Intel[®] Core[™] i7/i5/i3 processors, up to 45W
- System Chipset
 - Intel[®] Q87 chipset
- BIOS
 - AMI BIOS, with Smart View and Customer CMOS Backup.
- System Memory
 - Two 204-pin DDR3 1333/1600 MHz SODIMM sockets, with maximum up to 16 GB
- Features
 - Fanless Operation
 - Compact & Front IO design
 - Supports two expansion slots
 - DC to DC power supply support 10V to 30V
 - Rugged, up to -10°C ~ +50°C Fanless operation with W.T SSD or CFast[™] or HDD
 - Supports iAMT 9.0
 - Supports SATA 6GBs with RAID 0,1

1.2.2 I/O System

- Standard I/O Interface -- Font
 - One ATX power on/off switch
 - One ATX/AT Mode switch
 - One 2-pin connector output for remote power on/off switch
 - 10VDC to 30VDC with phoenix power plug or External 150W AC Adapter
 - Two USB 3.0 ports
 - Four USB 2.0 ports
 - HDD access/Power LEDs
 - Two RS-232/422/485 (COM 1/2)
 - Two RS232(COM 3/4)
 - Two G.E. LAN ports (i217LM & i210AT)



Note: The Intel[®] i217LM does not support S1 LAN Wake.

- 1 x DVI-I
- 1 x Digital I/O (Female DB9 Connector) (4 IN and 4 OUT)
- 1 x Audio (MIC-in/Line-out)
- 1 x PS/2 keyboard/mouse

- **Expansion Slot**
 - HAB100: PCIe x1 & 1 PCIe x4
 - HAB103: 1 PCIe x4 & 1 PCI



Note: *The maximum power rating for expansion slots at 50°C can not be exceeded the following values*

The maximum loading of +3.3V /1A, +5V /5A ,+12V /3A<60W

1.2.3 System Specification

- **Drive Capacity**
 - Supports two 2.5" HDD driver bay; one onboard CFast™ Socket



Note: *Due to Gen. 2 SSD with JMicron controller has compatibility issue with Intel Q87 PCH, we strongly recommend to use Gen. 3 SSD on IPC932 Series.*

- **Power Input**
 - 10VDC to 30VDC with phoenix power plug
 - External 150W AC Adapter
 - Power Input : 100VAC to 240VAC, 2A, 50~60HZ
 - Power Output : 19VDC
 - Operation temperature : 0°C ~ +50°C
- **Operation Temperature**
 - Ambient with air flow: -10°C ~ +50°C
- **Storage Temperature**
 - -20°C ~ 80°C
- **Humidity**
 - 10% ~ 90% (Non-condensing)
- **Dimensions**
 - 159.9 mm (6.36") (W) x 251.8mm (10.02") (D) x 185 mm (7.27") (H)



Note: *All specifications and images are subject to change without notice.*

1.3 Dimensions

The following diagrams show you dimensions and outlines of the IPC932-230-FL Series.

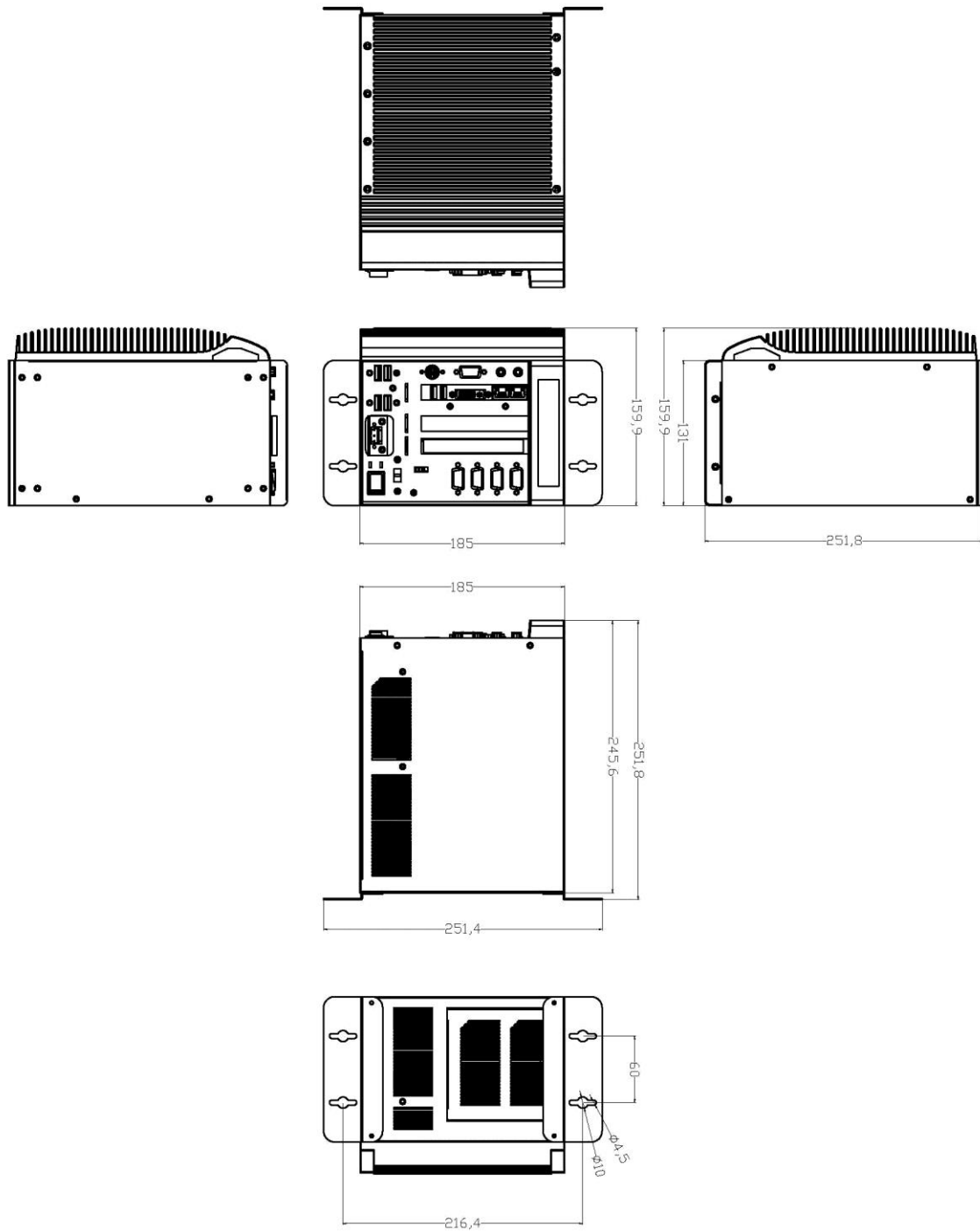

1.4 I/O Outlets

The following figures show you I/O outlets on front and rear panels of the IPC932-230-FL Series.

Front Panel

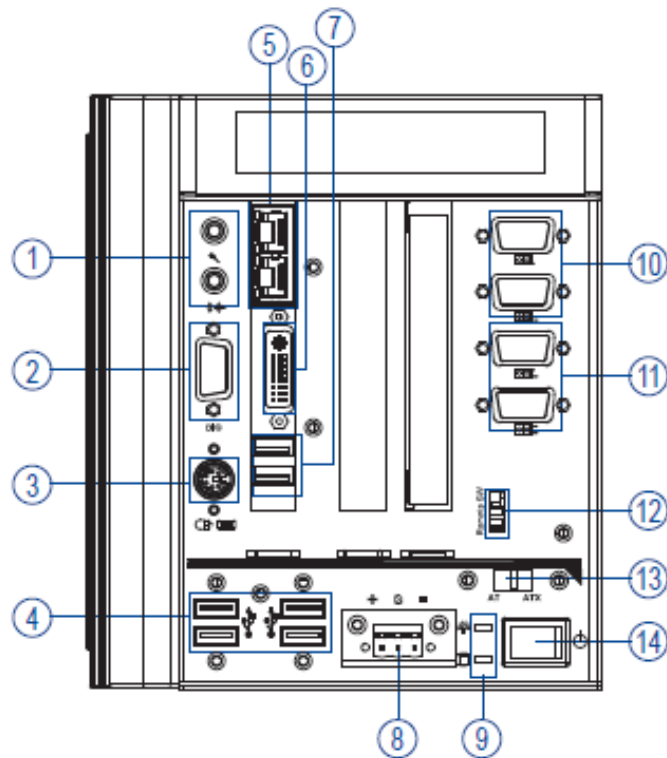

1. Audio(Mic-in/Line out)
2. Digital I/O
3. PS/2 Keyboard/Mouse
4. USB 2.0 x 4
5. Ethernet x 2
6. DVI-I
7. USB 3.0 x 2
8. Power connector (Din-Jack or Phoenix plug)
9. LED for Power and HDD
10. RS-232/422/485 (COM 1/2)
11. RS-232 (COM 3/4)
12. Remote power switch
13. ATX/AT Mode switch
14. ATX Power switch

1.5 Packing List

The package bundled with your IPC932-230-FL Series should contain the following items:

- **IPC932-230-FL Series Unit x 1**
- **19V 150W Adapter (for AC Version)**
- **Driver CD**
- **Quick Manual**
- **Wall Mount Bracket x 2**
- **Screw pack x 1**
- **Foot pad x 4**
- **CPU Thermal Pad x 1**
- **HDD Bracket x 2**
- **HDD Mylar x 2**
- **Terminal block x 1 (for DC version)**
- **Remote switch cable x 1**

If you can not find this package or any items are missing, please contact Axiomtek distributors immediately.

1.6 Jumper Settings

The IPC932-230-FL has a number of jumpers inside the chassis that allow you to configure your system to suit your application. The table below lists the functions of the various jumpers.

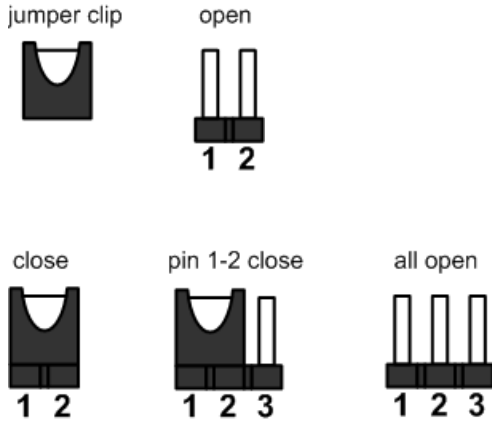

Jumper	Description	Jumper Setting
JP3	Audio Amplifier Selection : Disable	1-3 , 2-4 close
JP1	Clear RTC : Normal	1-2 close

1.6.1 Audio Amplifier Selection (JP3)

This jumper is for enabling or disabling audio amplifier.

Function	Setting
Disable (Default)	1-3, 2-4 close
Enable	3-5, 4-6 close

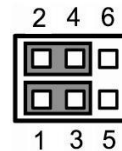

1.6.2 Restore BIOS Optimal Defaults (JP1)

Put jumper clip to pin 2-3 for a few seconds then move it back to pin 1-2. Doing this procedure can restore BIOS optimal defaults.

Function	Setting
Normal operation (Default)	1-2 close
Restore BIOS optimal defaults	2-3 close



1.7 Connectors

Signals go to other parts of the system through connectors. Loose or improper connection might cause problems, please make sure all connectors are properly and firmly connected. Here is a summary table which shows all connectors on the hardware.

Connector	Label
External Temperature Sensor Connector (Optional)	CN2
Digital I/O	CN1
DVI-I Connector	CN6
USB Port 3/4	CN10
USB Port 5/6	CN12
Axiomtek Front Panel	CN3
USB2.0/3.0 Port 1	CN11
PS2 Connector(Keyboard & Mouse)	CN8
USB2.0/3.0 Port 2	CN9
SYS FAN	FAN1
CPU FAN	FAN2
RJ45 (i217LM)	LAN1
RJ45 (i210AT)	LAN2
SATA 1 ~ 2 6Gb(SATA3)	SATA1~SATA2
CFast™ Connector	SCF1
COM1 ~ COM2 Connecters	COM1
Audio Connector	AUDIO1

1.7.1 Digital I/O Connector (CN1)

The board is equipped with an 8-channel digital I/O connector that meets requirements for a system customary automation control. The digital I/O can be configured to control cash drawers and sense warning signals from an Uninterrupted Power System (UPS), or perform store security control. You may use software programming to control these digital signals.

Pin	Signal	Pin	Signal
1	DIO 1	2	DIO 8
3	DIO2	4	DIO 7
5	DIO 3	6	DIO 6
7	DIO 4	8	DIO 5
9	NC	10	GND

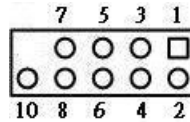

1.7.2 Inverter Connectors (CN5)

The CN5 is DF13-8P-1.25V 8-pin connector for inverter. We strongly recommend you to use the matching DF13-8S-1.25C connector to avoid malfunction.

Pin	Signal
1	VBL1 (+12V level)
2	VBL1 (+12V level)
3	VBL2 (+5V level)
4	VBL_ENABLE
5	GND
6	GND
7	GND
8	LVDS_BRICTL

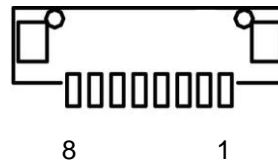

1.7.3 Internal USB 2.0 Connectors (CN10, CN12)

These are internal connectors for USB 2.0 interfaces.

Pin	Signal	Pin	Signal
1	USB_PWR	2	USB_PWR
3	USB -	4	USB -
5	USB +	6	USB +
7	GND	8	GND
		10	GND

CN12 (USB port 5 and 6)

CN10 (USB port 3 and 4)

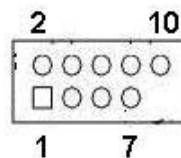

1.7.4 Front Panel Connector (CN3)

Pin	Signal
1	PWRLED+
2	EXT SPK-
3	GND
4	Buzzer
5	PWRLED-
6	N.C.
7	N.C.
8	EXT SPK+
9	PWRSW-
10	PWRSW+
11	HW RST-
12	HW RST+
13	HDDLED-
14	HDDLED+

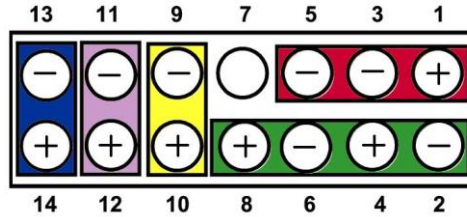

- **Power LED**

This 3-pin connector denoted as Pin 1 and Pin 5 connects the system power LED indicator to such a switch on the case. Pin 1 is assigned as +, and Pin 5 as -. The Power LED lights up when the system is powered ON. Pin 3 is defined as GND.

- **External Speaker and Internal Buzzer Connector**

Pin 2, 4, 6 and 8 can be connected to the case-mounted speaker unit or internal buzzer. While connecting the CPU card to an internal buzzer, please short pins 2-4; while connecting to an external speaker, you need to set pins 2-4 to Open and connect the speaker cable to pin 8 (+) and pin 2 (-).

- **ATX Power On/Off Button**

This 2-pin connector denoted as Pin 9 and 10 connects the front panel's ATX power button to the CPU card, which allows users to control ATX power supply to be power on/off.

- **System Reset Switch**

Pin 11 and 12 can be connected to the case-mounted reset switch that reboots your computer instead of turning OFF the power switch. It is a better way to reboot your system for a longer life of the system's power supply.

- **HDD Activity LED**

This connection is linked to hard drive activity LED on the control panel. LED flashes when HDD is being accessed. Pin 13 and 14 connect the hard disk drive to the front panel HDD LED, Pin 13 assigned as -, and Pin 14 as +.

1.7.5 External USB 3.0 Connectors (CN11 and CN9)

These are standard USB 3.0 connectors on rear I/O for installing USB 3.0 compliant interface peripherals.

Pin	Signal
1	VCC
2	D-
3	D+
4	GND
5	StdA_SSRX-
6	StdA_SSRX+
7	GND_DRAIN
8	StdA_SSTX-
9	StdA_SSTX+
10	Shield

CN11 (USB 3.0 port 1)

CN9 (USB 3.0 port 2)

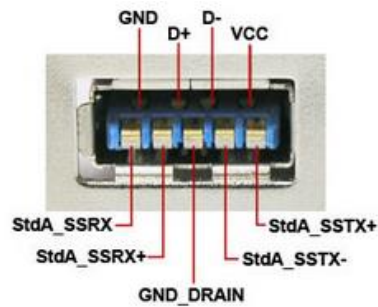

1.7.6 Internal Keyboard and Mouse Connectors (CN8)

The system comes with keyboard and mouse interfaces.

Pin	Signal
1	Mouse DATA
2	Mouse Clock
3	Keyboard DATA
4	Keyboard Clock
5	GND
6	5VSBY

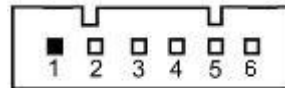

1.7.7 FAN Connectors (FAN1, FAN2)

Fans are always needed for cooling down CPU and system temperature. The board has two fan connectors. You can find fan speed option(s) at BIOS Setup Utility if either fan is installed. For further information, see BIOS Setup Utility: Advanced\HW Monitor\PC Health Status.System and auxiliary fan interfaces are available through FAN1 and FAN2, see table below.

Pin	Signal
1	GND
2	+12V level
3	Rotation detection

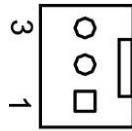

CPU fan interface is available through FAN2, see table below.

Pin	Signal
1	Ground
2	+12V
3	Rotation Detection
4	Speed Control

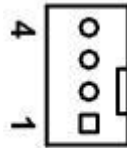

1.7.8 Ethernet Ports (LAN1 and LAN2)

The board has two RJ-45 connectors; LAN1 (for i217LM) and LAN2 (for i210AT). Ethernet connection can be established by plugging one end of the Ethernet cable into this RJ-45 connector and the other end (phone jack) to a 1000/100/10-Base-T hub.

Pin	Signal
1	Tx+ (Data transmission positive)
2	Tx- (Data transmission negative)
3	Rx+ (Data reception positive)
4	RJ-1 (For 1000-Base-T only)
5	RJ-1 (For 1000-Base-T only)
6	Rx- (Data reception negative)
7	RJ-1 (For 1000-Base-T only)
8	RJ-1 (For 1000-Base-T only)
A	Active LED
B	Speed LED

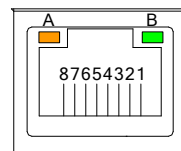

1.7.9 Serial ATA Connectors (SATA1~SATA2)

These Serial Advanced Technology Attachment (Serial ATA or SATA) connectors are for high-speed SATA interfaces. They are computer bus interfaces for connecting to devices such as hard disk drives. This system has two SATA 3.0 ports with 6Gb/s performance.



Note: Due to Gen. 2 SSD with JMicron controller has compatibility issue with Intel Q87 PCH, we strongly recommend to use Gen. 3 SSD on IPC932.

Pin	Signal
1	GND
2	SATA_TX+
3	SATA_TX-
4	GND
5	SATA_RX-
6	SATA_RX+
7	GND

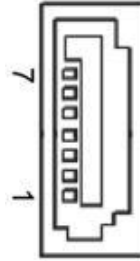

1.7.10 CFast™ Socket (SCF1)

The board is equipped with a CFast™ socket to support CFast™ card which is based on the Serial ATA bus. The socket is specially designed to avoid incorrect installation of CFast™ card. When installing or removing CFast™ card, please make sure system power is off. The CFast™ card by default identifies itself as C: or D: drive in your PC system.

Pin	Signal	Pin	Signal
S1	GND	PC1	NC
S2	TX+	PC2	GND
S3	TX-	PC3	NC
S4	GND	PC4	NC
S5	RX-	PC5	NC
S6	RX+	PC6	NC
S7	GND	PC7	GND
		PC8	NC
		PC9	NC
		PC10	NC
		PC11	NC
		PC12	NC
		PC13	3.3V
		PC14	3.3V
		PC15	GND
		PC16	GND
		PC17	NC

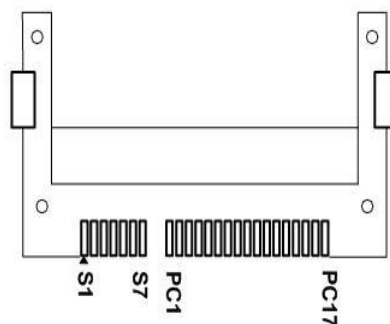

1.7.11 COM Connectors (COM1~COM4)

The COM1/2 ports supports RS-232/RS-422/RS-485 mode operation, the COM3/4 ports supports RS-232 mode operation, see table below for its pin assignments. You can change the transmission mode via BIOS setting.

Pin	RS-232	RS-422	RS-485
1	Data Carrier Detect (DCD1)	TX1-	DATA1-
2	Data Set Ready (DSR1)	No connector	No connector
3	Receive Data (RXD1)	TX1+	DATA1+
4	Request to Send (RTS1)	No connector	No connector
5	Transmit Data (TXD1)	RX1+	No connector
6	Clear to Send (CTS1)	No connector	No connector
7	Data Terminal Ready (DTR1)	RX1-	No connector
8	Ring Indicator (RI1)	No connector	No connector
9	Ground (GND)	GND	GND

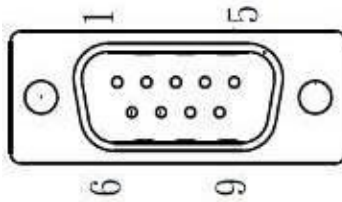

1.7.12 Intel® HD Audio Digital Header (AUDIO1)

Pin	Signal	Pin	Signal
1	MIC IN	2	GND
3	LINE_IN_L	4	GND
5	LINE_IN_R	6	GND
7	LINE_OUT_L	8	GND
9	LINE_OUT_R	10	GND

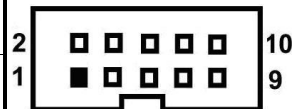

This page is intentionally left blank.

CHAPTER 2 HARDWARE INSTALLATION

The IPC932-230-FL Series are convenient for your various hardware configurations, such as CPU (Central Processing Unit), Memory Module, HDD (Hard Disk Drive) and PCIe card. The chapter 2 will show you how to install the hardware. It includes:

2.1 Installing the Processor

The Intel® Core™ i7/i5/i3 processors are available as a boxed processor for IPC932-230-FL system. Intel recommends the processors should be installed by a computer professional since this electronic device may cause serious damage to the installer, system and processor if installed improperly.

Important Notes Before attempting to install a new processor, carefully review the documentation that came with your system and make sure that you will not be voiding your warranty by opening the computer or replacing your processor.

Instructions:

1. Make sure that your system can accommodate the Intel® Core™ i7/i5/i3/Celeron® Processors that you want to install. Check for CPU Card, BIOS, and thermal compatibility by using the manufacturer's documentation for the system, or by contacting the vendor if necessary. This processor should only be installed in systems supporting the Intel® Core™ i7/i5/i3/Celeron® Processors.
2. Obtain access to your processor socket as described in the documentation for your system.
3. If the cooling solution prevents you from accessing the processor socket, you may need to remove it. Instructions on how to remove your cooling solution should be provided in the documentation that came with the system.

Procedure of Installation:

- Step 1** Turn off the system.
- Step 2** Disconnect the power connector.
- Step 3** Loosen screws to remove the Heatsink cover from the chassis.



- Step 4** After opening the HS cover, you can locate the CPU socket as marked. Align pins of the CPU with pin holes of the socket. Be careful of the CPU's orientation that you need to align the arrow mark on the CPU with the arrow key on the socket. Please remove the Mylar before you install the CPU into the socket.



- Step 5** Then, put a thermal pad on top of the CPU

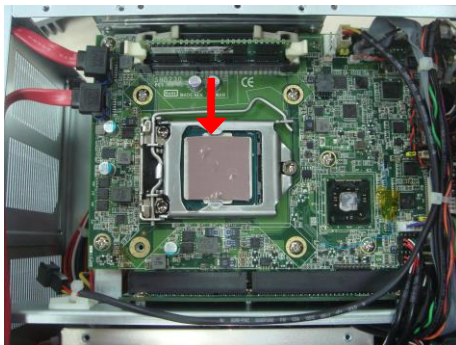

- Step 6** After install the ram module, please close the HS cover back to the chassis and fasten all screws.

2.2 Installing the Memory Module

- Step 1** Turn off the system.
- Step 2** Disconnect the power connector.
- Step 3** Loosen screws to remove the Heatsink cover from the chassis.



- Step 4** Install the memory module into the socket and push it firmly down until it is fully seated. The socket latches are clipped on to the edges of the SO-DIMM.



- Step 5** After install the ram module, please close the Heatsink cover back to the chassis and fasten all screws.

2.3 Installing the Hard Disk Drive

The IPC932-230-FL Series offers a convenient drive bay module for users to install HDD. The system offers users two 2.5" Hard Disk Drive for installation. Please follow the steps:

- Step 1** Turn off the system.
- Step 2** Disconnect the power connector.
- Step 3** Loosen screws to remove the top cover from the chassis.
- Step 4** Open the top cover and locate the Hard Disk Drives as red marked.

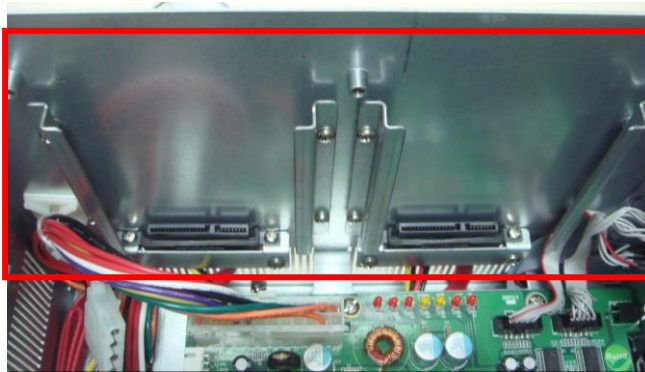

- Step 5** There is a thermal pad and 2 x HDD brackets in the accessory box, please sticker the HDD Mylar before assembly the HDD with the bracket.



- Step 6** Insert the HDD module into the HDD socket.



- Step 7** Close the HDD top cover back to the chassis and fasten all screws.

2.4 Installing the PCI or PCIe Card

IPC932-230-FL provides one PCIe x1 and one PCIe x4 or one PCI & one PCIe x4 for expansion. The procedure of installing the PCI / PCIe expansion card into IPC932-230-FL is instructed below.

Step 1 Turn off the system.

Step 2 Disconnect the power connector.

Step 3 Loosen screws to remove the top cover from the chassis. Removing the PCI or PCIe bracket by releasing the button as marked.



Step 4 Locate the PCI or PCIe slots.

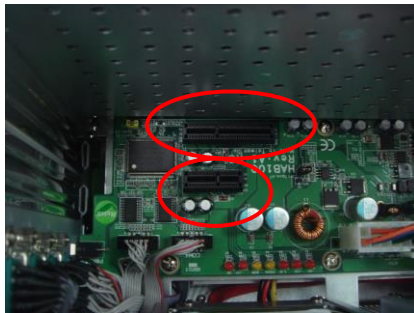

Step 5 Align the PCI or PCIe card with the slot, and press the card into the slot until it is firmly seated.



Step 6 Close the top cover back to the chassis and fasten all screws.

2.5 Installing the optional Fan Module

IPC932-230-FL provides one PCIe1 and one PCIe4 or 1 PCI & 1 PCIe4 for expansion. For the system dissipation generated by PCI/PCIe cards, we strongly suggest that customer should use our optional fan module, to install the optional system fan, please follow the steps below:

- Step 1** Turn off the system.
- Step 2** Disconnect the power connector.
- Step 3** Loosen screws to remove the top cover from the chassis and remove the two screws on the rear panel as red marked.



- Step 4** Plug the fan cables connected to the IPC932, and then attach the system fan module to the IPC932 and secure it by two screws.



CHAPTER 3

AMI BIOS UTILITY

The AMI UEFI BIOS provides users with a built-in setup program to modify basic system configuration. All configured parameters are stored in a 16MB flash chip to save the setup information whenever the power is turned off. This chapter provides users with detailed description about how to set up basic system configuration through the AMI BIOS setup utility.

3.1 Starting

To enter the setup screens, follow the steps below:

1. Turn on the computer and press the key immediately.
2. After you press the key, the main BIOS setup menu displays. You can access the other setup screens from the main BIOS setup menu, such as the Advanced and Chipset menus.



Note: *If your computer cannot boot after making and saving system changes with Setup, you can restore BIOS optimal defaults by setting JP1 (see section 1.6.2).*

It is strongly recommended that you should avoid changing the chipset's defaults. Both AMI and your system manufacturer have carefully set up these defaults that provide the best performance and reliability.

3.2 Navigation Keys

The BIOS setup/utility uses a key-based navigation system called hot keys. Most of the BIOS setup utility hot keys can be used at any time during the setup navigation process. These keys include <F1>, <F2>, <Enter>, <ESC>, <Arrow> keys, and so on.



Note: *Some of the navigation keys differ from one screen to another.*

Hot Keys	Description
→← Left/Right	The Left and Right <Arrow> keys allow you to select a setup screen.
↑↓ Up/Down	The Up and Down <Arrow> keys allow you to select a setup screen or sub-screen.
+– Plus/Minus	The Plus and Minus <Arrow> keys allow you to change the field value of a particular setup item.
Tab	The <Tab> key allows you to select setup fields.
F1	The <F1> key allows you to display the General Help screen.
F2	The <F2> key allows you to Load Previous Values.
F3	The <F3> key allows you to Load Optimized Defaults.
F4	The <F4> key allows you to save any changes you have made and exit Setup. Press the <F4> key to save your changes.
Esc	The <Esc> key allows you to discard any changes you have made and exit the Setup. Press the <Esc> key to exit the setup without saving your changes.
Enter	The <Enter> key allows you to display or change the setup option listed for a particular setup item. The <Enter> key can also allow you to display the setup sub- screens.

3.3 Main Menu

The first time you enter the setup utility, you will be in the Main setup screen. You can always return to the Main setup screen by selecting the Main tab. System Time/Date can be set up as described below. The Main BIOS setup screen is shown below.

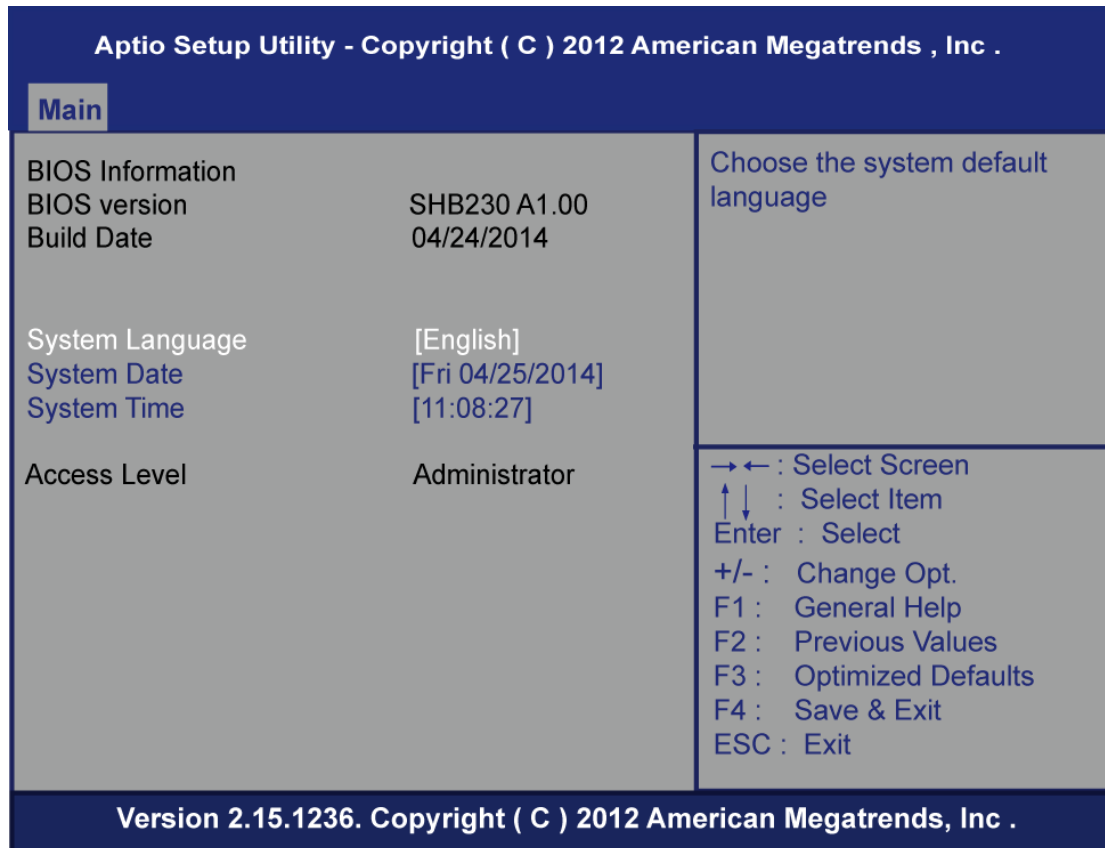

- System Language Use this item to choose the system default language.
- System Date/Time Use this option to change the system time and date. Highlight System Time or System Date using the <Arrow> keys. Enter new values through the keyboard. Press the <Tab> key or the <Arrow> keys to move between fields. The date must be entered in MM/DD/YY format. The time is entered in HH:MM:SS format.

3.4 Advanced Menu

- **Launch PXE OpROM**

Use this item to enable or disable the boot ROM function of the onboard LAN chip when the system boots up.

The Advanced menu also allows users to set configuration of the CPU and other system devices. You can select any of the items in the left frame of the screen to go to the sub menus:

- ▶ ACPI Settings
- ▶ CPU Configuration
- ▶ SATA Configuration
- ▶ PCH-FW Configuration
- ▶ AMT Configuration
- ▶ USB Configuration
- ▶ F81801 Super I/O Configuration
- ▶ F81801 HW Monitor
- ▶ Intel RC Drivers version Detail

For items marked with “▶”, please press <Enter> for more options.

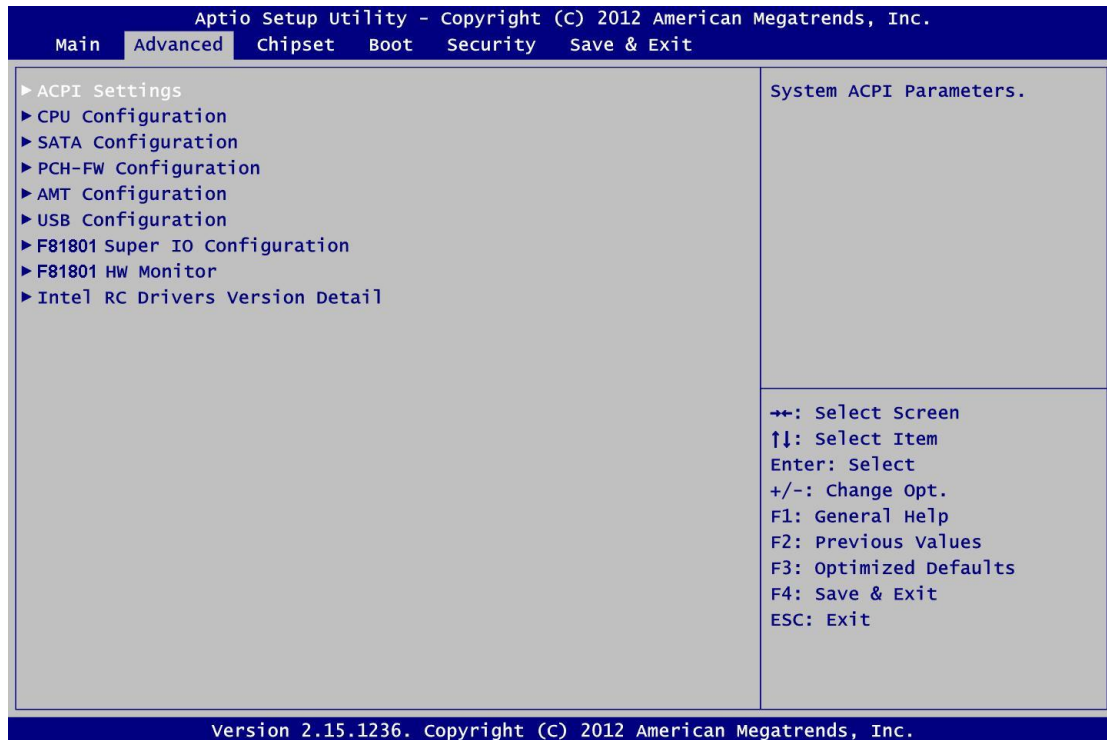

- **ACPI Settings**

ACPI configuration can be configured in ACPI Settings. A description of the selected item appears on the right side of the screen.

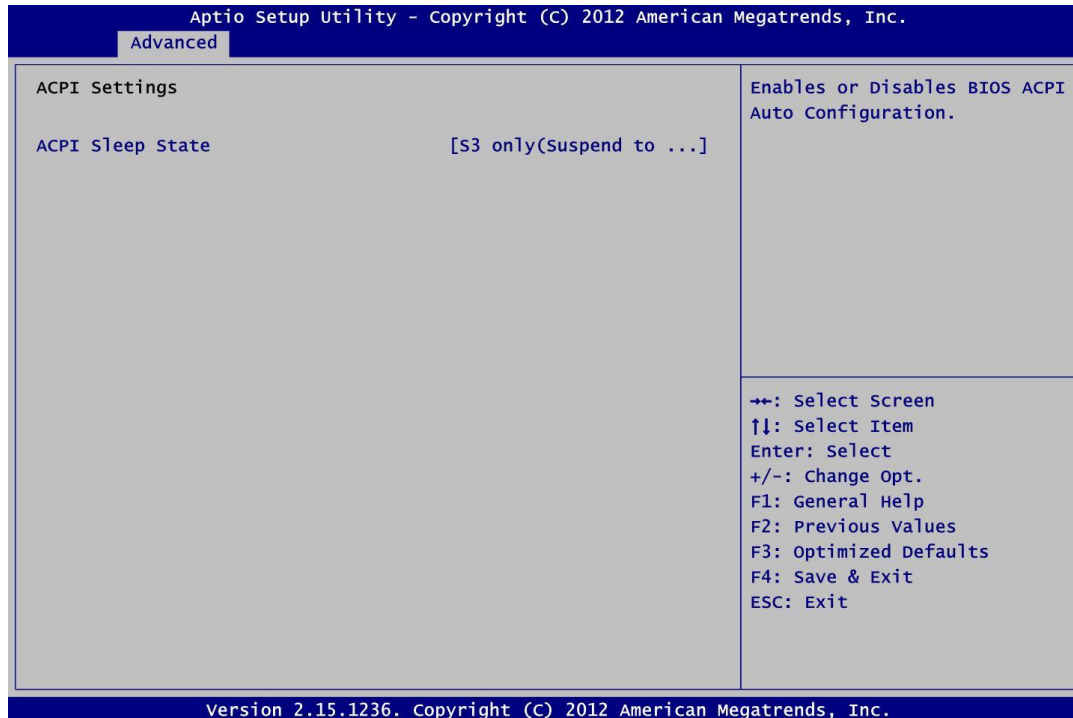

- **ACPI Sleep State**

Select the highest ACPI sleep state the system will enter when the suspend button is pressed. Configuration options are Suspend S3 only (Suspend to RAM).

● **CPU Configuration**

This screen shows the CPU Configuration, and you can change the value of the selected option.

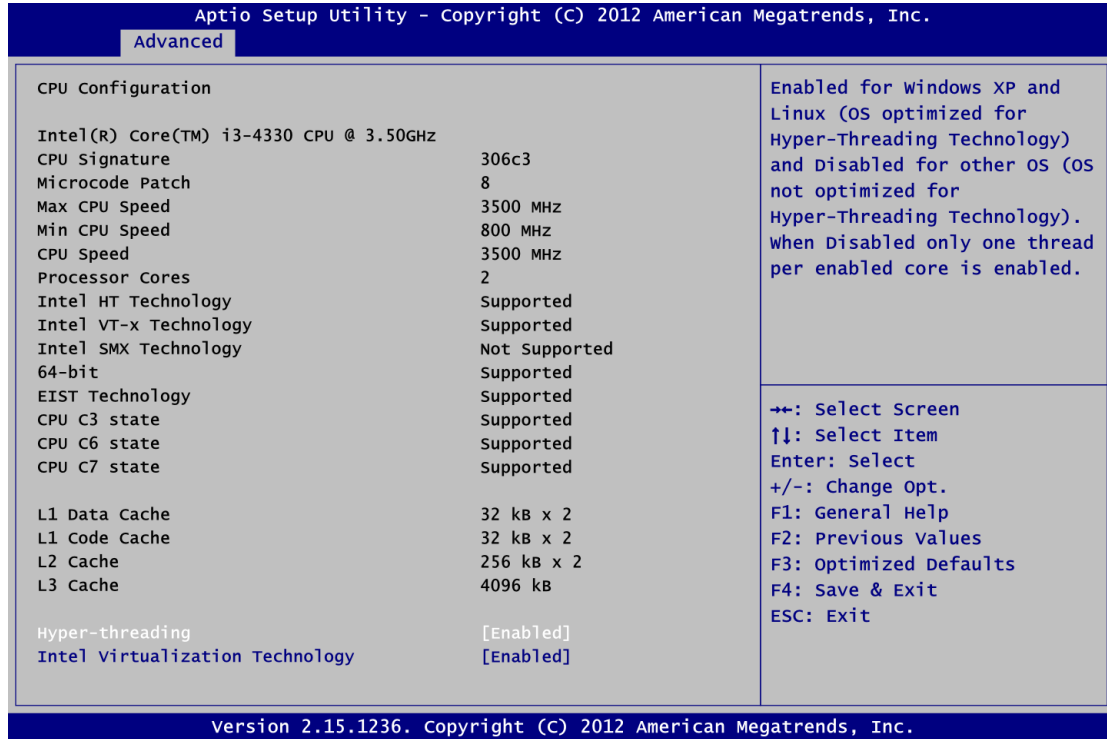

➤ **Hyper-threading**

Use this item to enable or disable Hyper-Threading Technology, which makes a single physical processor perform multi-tasking function as two logical ones.

➤ **Intel Virtualization Technology**

This item allows a hardware platform to run multiple operating systems separately and simultaneously, enabling one system to virtually function as several systems.

- **SATA Configuration**

You can read the current installed hardware configurations from those SATA ports in the SATA Configuration menu. During system boot up, BIOS will detect the present SATA devices automatically.

Aptio Setup Utility - Copyright (C) 2012 American Megatrends, Inc.

Advanced

SATA Controller(s)	[Enabled]	Determines how SATA controller(s) operate.
SATA Mode Selection	[AHCI]	
Serial ATA Port 1	ST320LT012-9WS (320.0GB)	
Serial ATA Port 2	ST380817AS (80.0GB)	
Serial ATA Port 3	Empty	

←→: Select Screen
↑↓: Select Item
Enter: Select
+/-: Change Opt.
F1: General Help
F2: Previous Values
F3: Optimized Defaults
F4: Save & Exit
ESC: Exit

Version 2.15.1236. Copyright (C) 2012 American Megatrends, Inc.

- **FCH-FW Configuration**

Display ME firmware information

The screenshot displays the Aptio Setup Utility interface. At the top, it reads "Aptio Setup Utility - Copyright (C) 2012 American Megatrends, Inc." Below this is a menu with "Advanced" selected. The main area shows the following information:

ME FW Version	N/A
ME Firmware Mode	N/A
ME Firmware Type	Full Sku Firmware
ME Firmware SKU	N/A

On the right side of the screen, a list of navigation keys is provided:

- ← : Select Screen
- ↑ ↓ : Select Item
- Enter : Select
- + / - : Change Opt.
- F1 : General Help
- F2 : Previous Values
- F3 : Optimized Defaults
- F4 : Save & Exit
- ESC : Exit

At the bottom of the utility, it reads "Version 2.15.1236 Copyright (C) 2012 American Megatrends, Inc."

- **AMT Configuration**

Enable/Disable Intel Active Management Technology.

Configuration options: [Disabled] [Enabled]

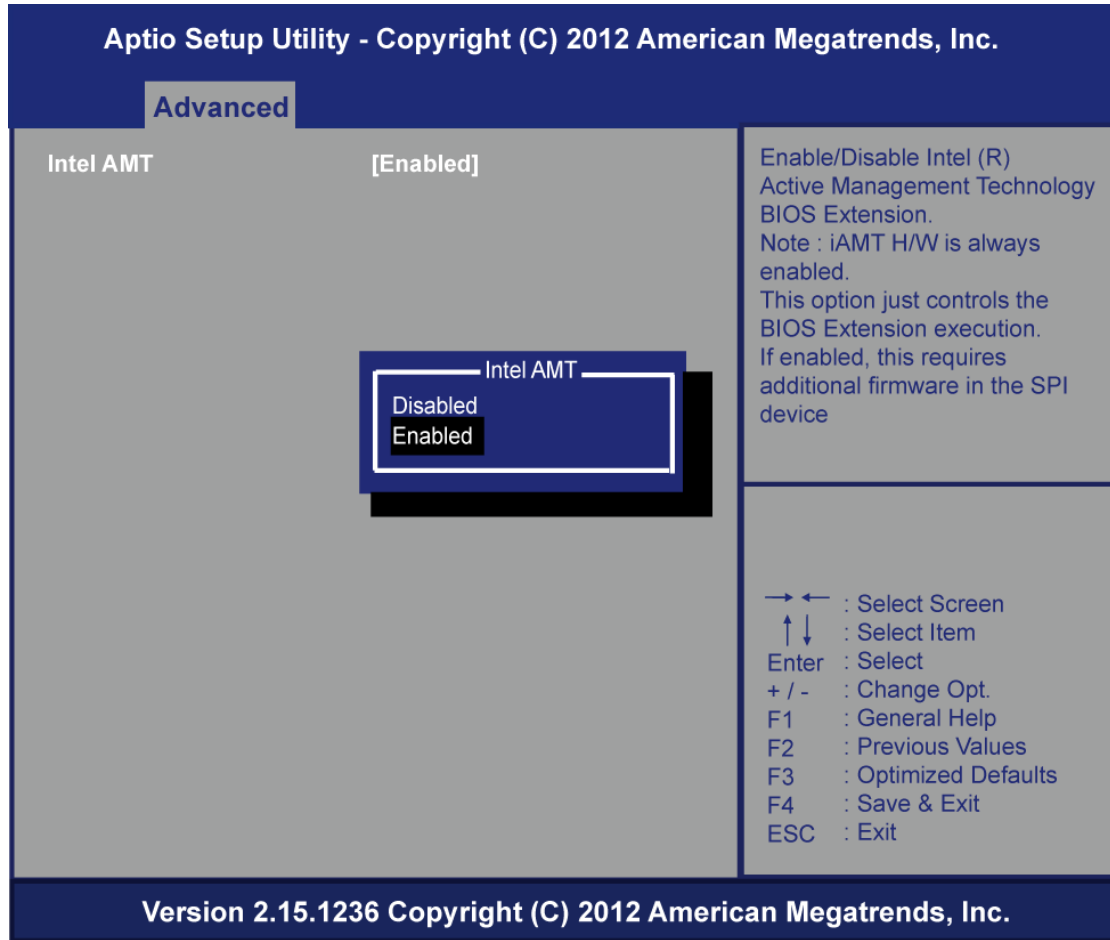

- **USB Configuration**

USB configuration can be configured here by selecting and changing each item. A description of the selected item appears on the right side of the screen.

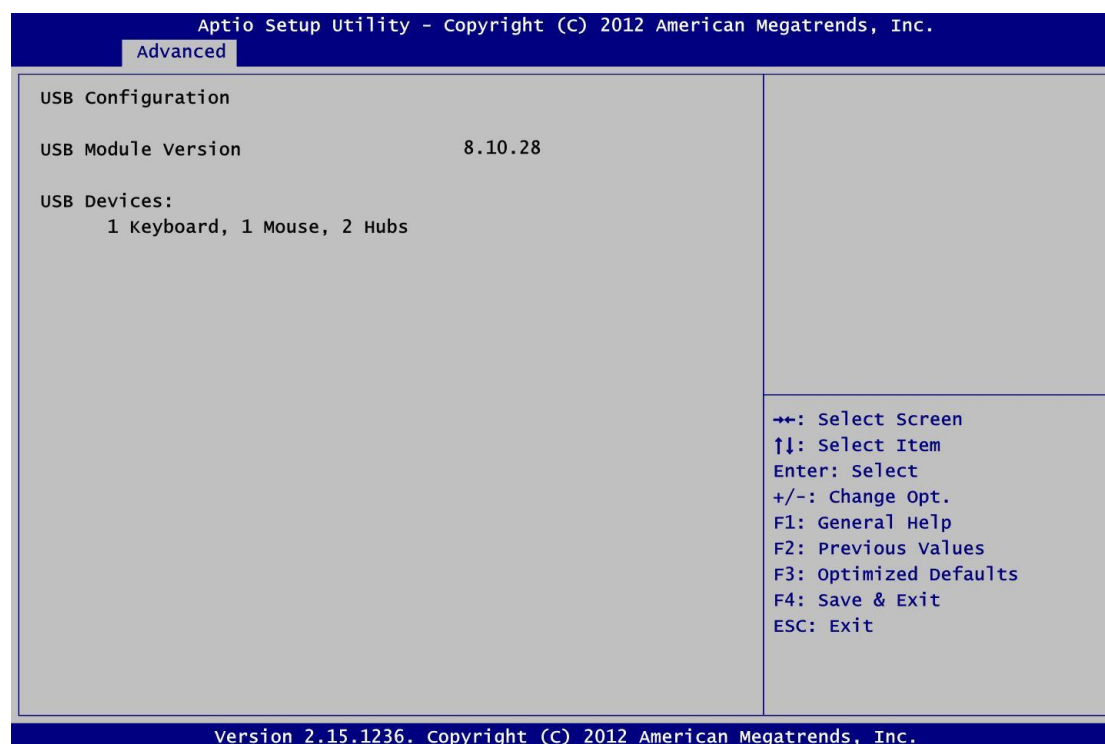

- **USB Devices**

Display all detected USB devices.

- **F81801 Super IO Configuration**

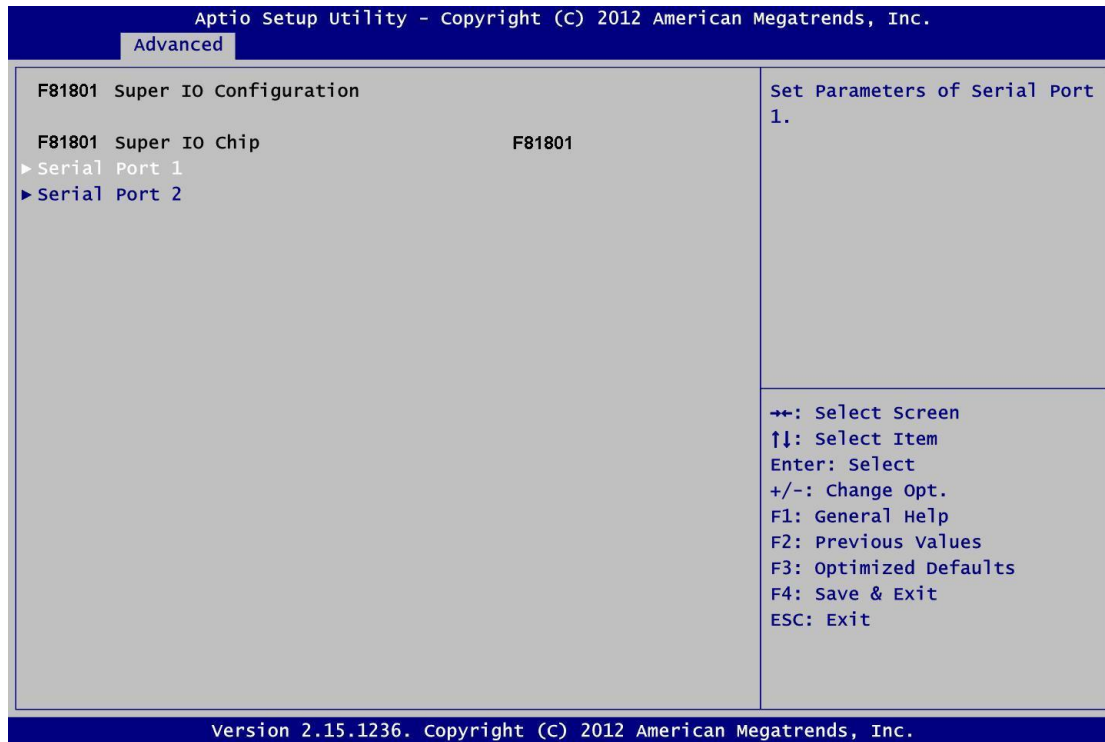

- **Serial Port 1~2 Configuration**

Use this item to set parameters of serial port 1 to 2.

● **Serial Port 1 Configuration**

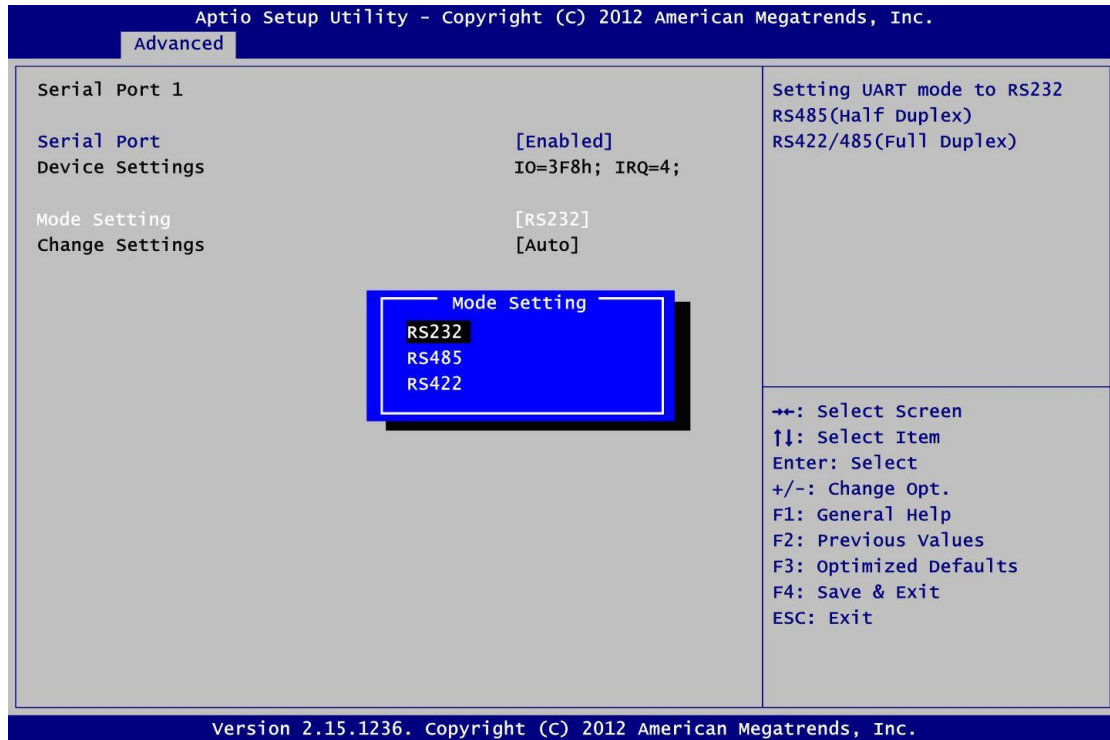

➤ **Serial Port**

Enable or disable serial port 1. The optimal setting for base I/O address is 3F8h and for interrupt request address is IRQ4.

➤ **Mode Setting**

Use this option to set RS-232/RS-422/RS-485 mode for serial port 1.

- **Serial Port 2 Configuration**

Aptio Setup Utility - Copyright (C) 2012 American Megatrends, Inc.

Advanced

Serial Port 2		Setting UART mode to RS232 RS485(Half Duplex) RS422/485(Full Duplex)
Serial Port	[Enabled]	
Device Settings	IO=2F8h; IRQ=3;	
Mode Setting	[RS232]	
Change Settings	[Auto]	

Mode Setting

RS232

RS485

RS422

→←: Select Screen
 ↑↓: Select Item
 Enter: select
 +/-: Change Opt.
 F1: General Help
 F2: Previous Values
 F3: Optimized Defaults
 F4: Save & Exit
 ESC: Exit

Version 2.15.1236. Copyright (C) 2012 American Megatrends, Inc.

- **Serial Port**

Enable or disable serial port 2. The optimal setting for base I/O address is 2F8h and for interrupt request address is IRQ3.

- **Mode Setting**

Use this option to set RS-232/RS-422/RS-485 mode for serial port 2.

- **F81801 HW Monitor**

This screen monitors hardware health.

Aptio Setup Utility - Copyright (C) 2012 American Megatrends, Inc.	
Advanced	
PC Health Status CPU Fan Function [Disabled] CPU temperature : +56 C System temperature : +49 C Fan1 Speed : N/A Fan2 Speed : N/A VCORE : +1.736 V V_SM : +1.488 V	Enable or Disable Smart Fan → ← : Select Screen ↑ ↓ : Select Item Enter : Select + / - : Change Opt. F1 : General Help F2 : Previous Values F3 : Optimized Defaults F4 : Save & Exit ESC : Exit
Version 2.15.1236 Copyright (C) 2012 American Megatrends, Inc.	

➤ **Smart Fan Function**

Enable or disable Smart Fan function.

- **Intel RC Drivers version Detail**

Displays Version String for drivers

The screenshot displays the 'Advanced' section of the Aptio Setup Utility. The title bar reads 'Aptio Setup Utility - Copyright (C) 2012 American Megatrends, Inc.'. Below the title, the 'Advanced' tab is selected. The main area shows a list of Intel RC drivers and their versions:

Intel CPU RC Version	1.6.2.0
Intel SA RC Version	1.6.2.0
Intel PCH RC Version	1.6.2.0
Intel ACPI RC Version	1.6.2.0
Intel ME RC Version	N/A
Intel RSC RC Version	1.6.2.0

At the bottom right of the screen, a legend lists the navigation keys:

- ← : Select Screen
- ↑ ↓ : Select Item
- Enter : Select
- + / - : Change Opt.
- F1 : General Help
- F2 : Previous Values
- F3 : Optimized Defaults
- F4 : Save & Exit
- ESC : Exit

The footer of the utility reads 'Version 2.15.1236 Copyright (C) 2012 American Megatrends, Inc.'.

3.5 Chipset Menu

The Chipset menu allows users to change the advanced chipset settings. You can select any of the items in the left frame of the screen to go to the sub menus:

- ▶ **PCH-IO Configuration**
- ▶ **System Agent (SA) Configuration**

For items marked with “▶”, please press <Enter> for more options.

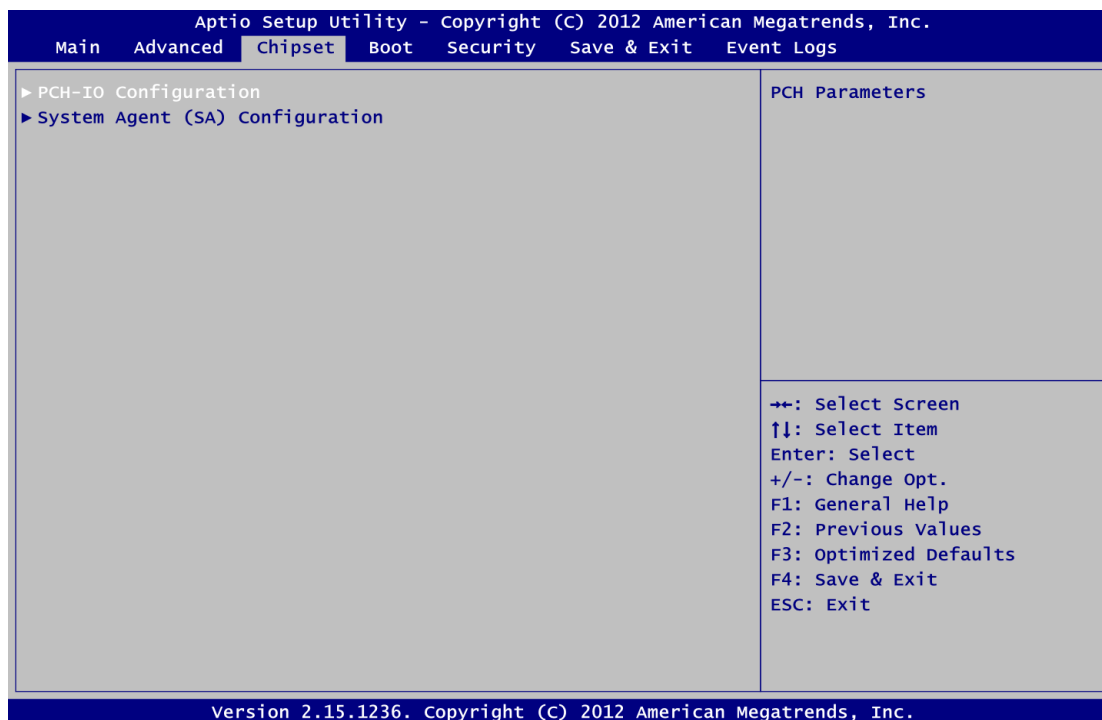

- **PCH-IO Configuration**

This screen allows you to set PCH parameters.

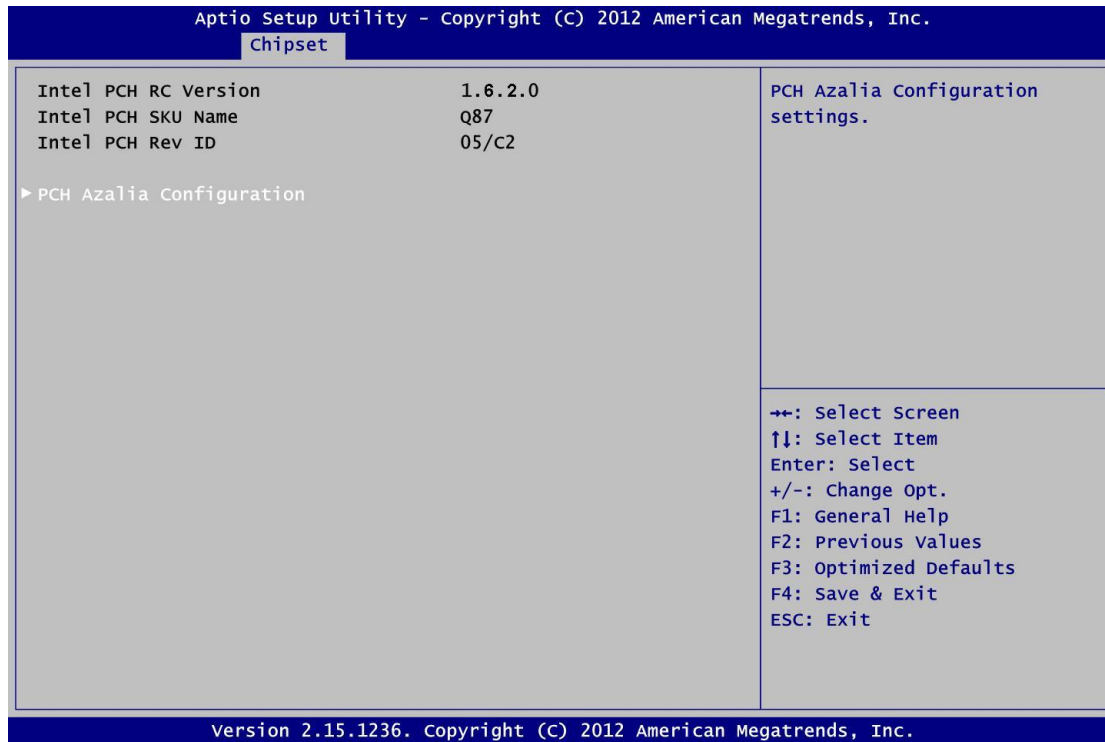

- **PCH Azalia Configuration**

Use this item for PCH Azalia configuration settings.

- **System Agent (SA) Configuration**

This screen shows System Agent information and provides function for specifying related parameters. For items marked with “▶”, please press <Enter> for more options.

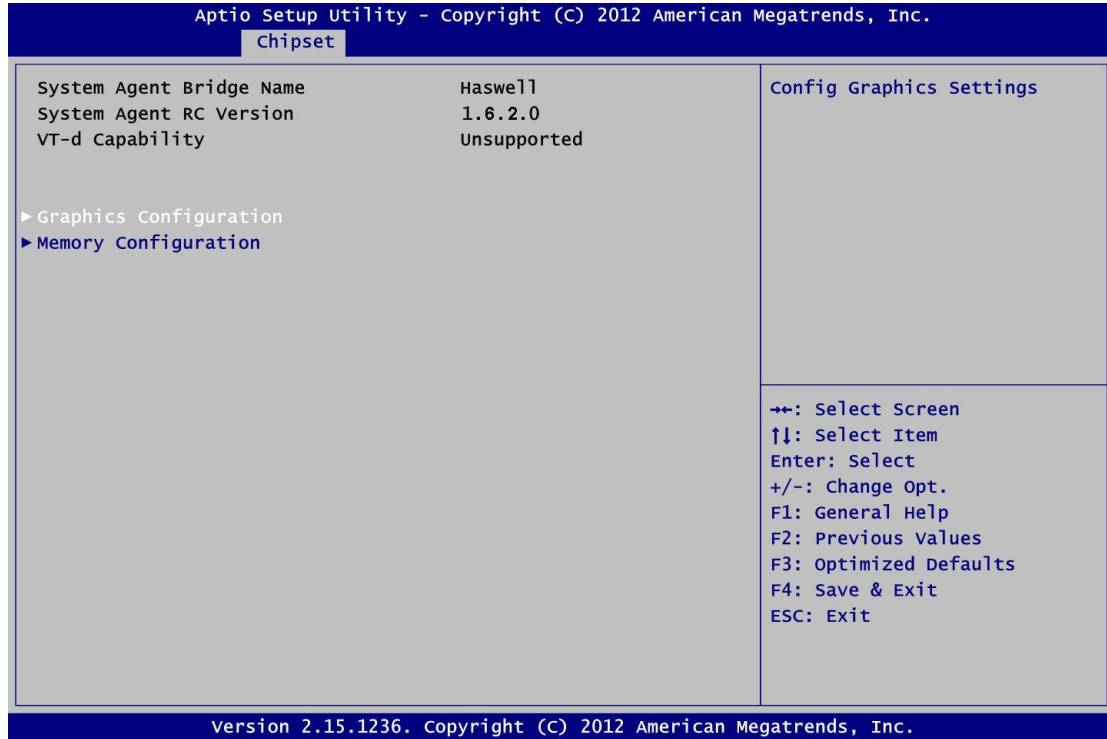

- **Graphics Configuration**

Use this item for graphics configuration settings.

- **Memory Configuration**

Use this item for memory configuration settings.

- **Graphic Configuration**

Aptio Setup Utility - Copyright (C) 2012 American Megatrends, Inc.		
Chipset		
Graphics Configuration		Select which of IGFX/PEG/PCI Graphics device should be Primary Display Or select SG for Switchable Gfx.
IGFX VBIOS Version	2179	
IGFX Frequency	700 MHz	
Primary Display	[Auto]	
Internal Graphics	[Auto]	
Aperture Size	[256MB]	
DVMT Pre-Allocated	[32M]	
DVMT Total Gfx Mem	[256M]	
Gfx Low Power Mode	[Enabled]	
LVDS Panel Type	[800x600 18Bit]	
LVDS Brightness	[70%]	
Primary IGFX Boot Display	[DVI]	
Secondary IGFX Boot Display	[CRT]	
		→ ← : Select Screen ↑ ↓ : Select Item Enter : Select + / - : Change Opt. F1 : General Help F2 : Previous Values F3 : Optimized Defaults F4 : Save & Exit ESC : Exit
Version 2.15.1236 Copyright (C) 2012 American Megatrends, Inc.		

- **Primary Display**

Allow you to select which graphics controller to use as the primary boot device.

- **Internal Graphic[Auto]**

Keep IGD enable based on the setup option.

Configuration options: [Auto] [Disabled] [Enabled].

- **Aperture Size [256MB]**

Set Aperture Size.

Configuration options: [128MB][256MB][512MB]

- **DVMT Pre-Allocated**

Select DVMT pre-allocated memory size.

- **DVMT Total Gfx Mem**

Select DVMT total memory size.

- **Gfx Low Power Mode[Disable]**

This option is applicable for SFF only.

Configuration options: [Disabled] [Enabled].

- **LVDS Panel Type**

Use this item to select LVDS panel used by internal graphics controller by selecting the appropriate setup item.

3.6 Boot Menu

The Boot menu allows users to change boot options of the system.

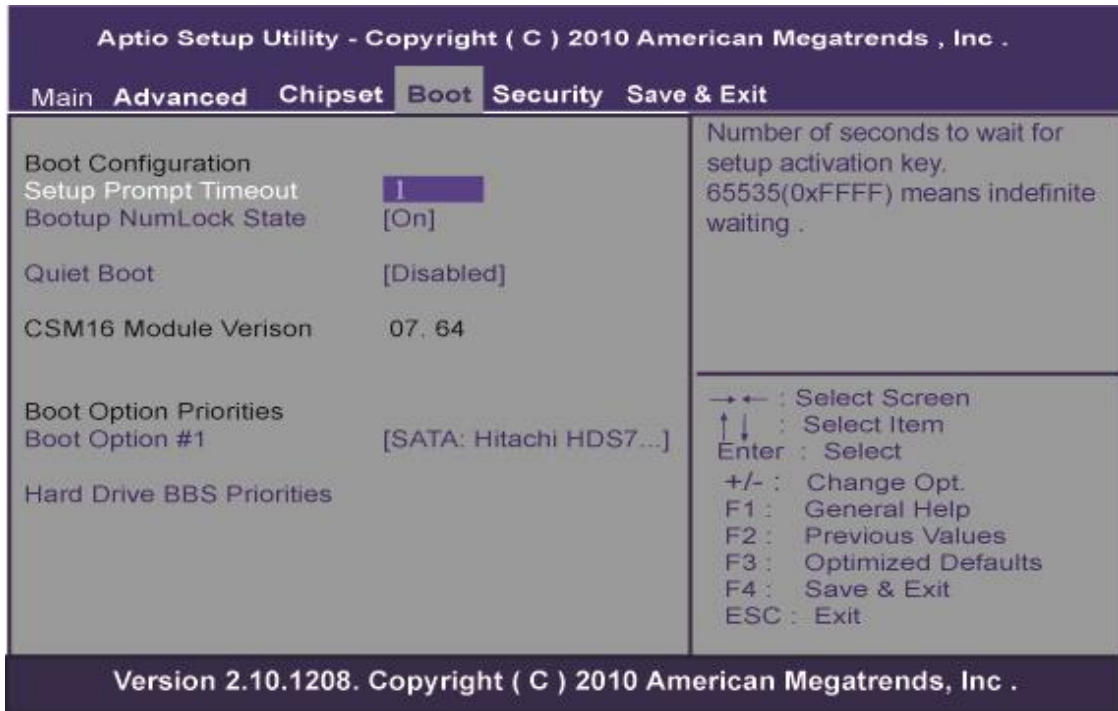

- **Setup Prompt Timeout**
Number of seconds to wait for setup activation key.65535 (0xFFFF) means indefinite waiting.
- **Boot up Unlock State**
Use this item to select the power-on state for the Unlock.
- **Quiet Boot**
Enable or disable Quiet Boot option.

3.7 Security Menu

The Security menu allows users to change the security settings for the system.

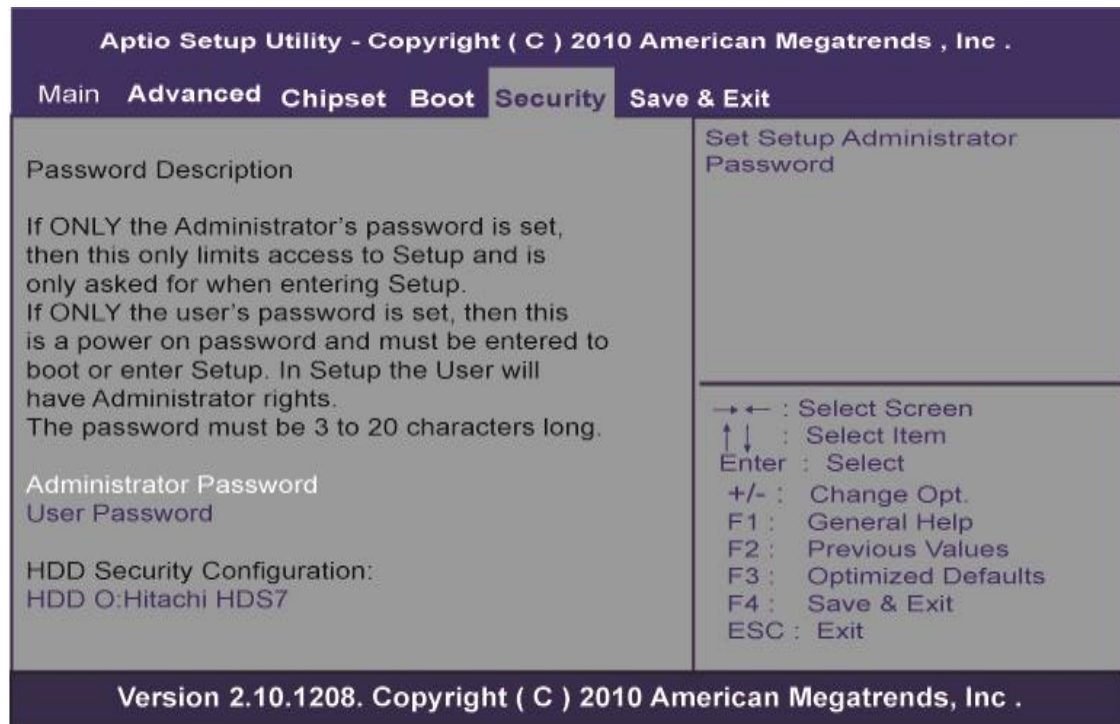

➤ **Administrator Password**

This item indicates whether an administrator password has been set (installed or uninstalled).

➤ **User Password**

This item indicates whether a user password has been set (installed or uninstalled).

3.8 Save & Exit Menu

The Save & Exit menu allows users to load your system configuration with optimal or fail-safe default values.

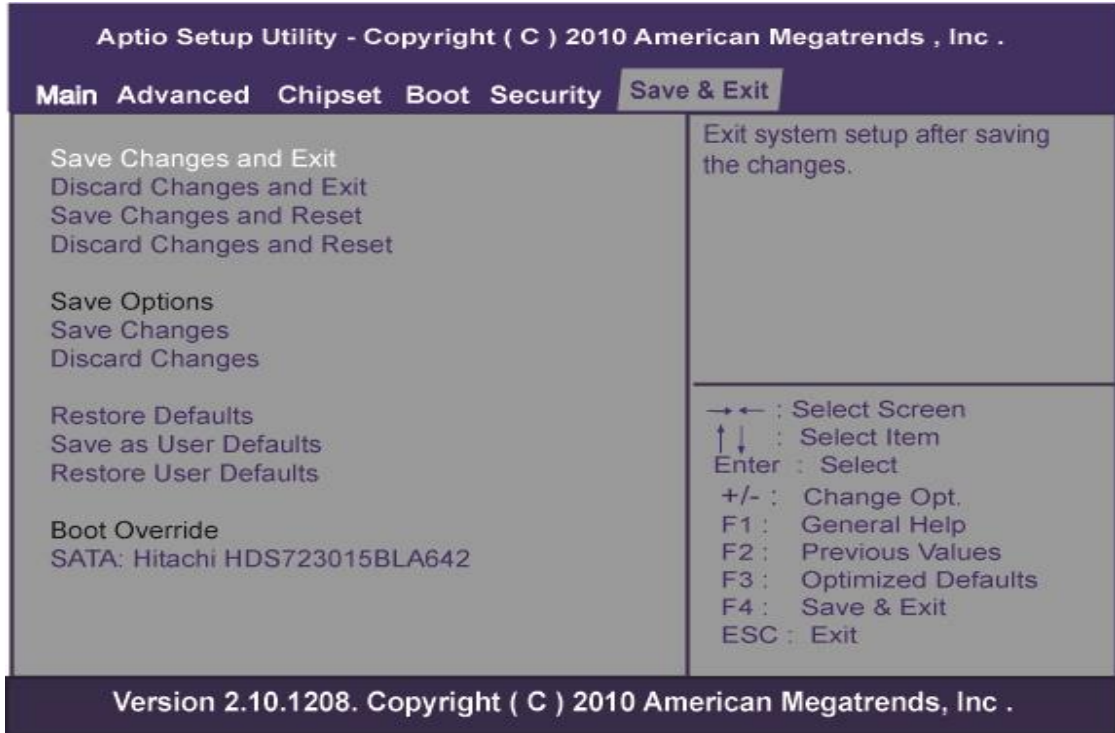

- **Save Changes and Exit**
When finish the system configuration settings, select this option to leave Setup and return to Main Menu. Select Save Changes and Exit from the Save & Exit menu and press <Enter>. Select Yes to save changes and exit.
- **Discard Changes and Exit**
Select this option to quit Setup without making any permanent changes to the system configuration and return to Main Menu. Select Discard Changes and Exit from the Save & Exit menu and press <Enter>. Select Yes to discard changes and exit.
- **Save Changes and Reset**
When finish the system configuration settings, select this option to leave Setup and reboot the computer so the new system configuration parameters can take effect. Select Save Changes and Reset from the Save & Exit menu and press <Enter>. Select Yes to save changes and reset.

➤ **Discard Changes and Reset**

Select this option to quit Setup without making any permanent changes to the system configuration and reboot the computer. Select Discard Changes and Reset from the Save & Exit menu and press <Enter>. Select Yes to discard changes and reset.

➤ **Save Changes**

When finish the system configuration settings, select this option to save changes. Select Save Changes from the Save & Exit menu and press <Enter>. Select Yes to save changes.

➤ **Discard Changes**

Select this option to quit Setup without making any permanent changes to the system configuration. Select Discard Changes from the Save & Exit menu and press <Enter>. Select Yes to discard changes.

➤ **Restore Defaults**

When select this option, all the settings will be restored to defaults automatically. Select Restore Defaults from the Save & Exit menu and press <Enter>.

➤ **Save as User Defaults**

Select this option to save your current system configuration settings as User Defaults. Select Save as User Defaults from the Save & Exit menu and press <Enter>.

➤ **Restore User Defaults**

When select this option, all the settings will be restored to user defaults automatically. Select Restore User Defaults from the Save & Exit menu and press <Enter>.

This page is intentionally left blank.