



***AXIOMTEK***

## **NA362 Series**

**Network Appliance**

**User's Manual**



## **Disclaimers**

This manual has been carefully checked and believed to contain accurate information. AXIOMTEK Co., Ltd. assumes no responsibility for any infringements of patents or any third party's rights, and any liability arising from such use.

AXIOMTEK does not warrant or assume any legal liability or responsibility for the accuracy, completeness or usefulness of any information in this document. AXIOMTEK does not make any commitment to update the information in this manual.

AXIOMTEK reserves the right to change or revise this document and/or product at any time without notice.

No part of this document may be reproduced, stored in a retrieval system, or transmitted, in any form or by any means, electronic, mechanical, photocopying, recording, or otherwise, without the prior written permission of AXIOMTEK Co., Ltd.

**©Copyright 2017 AXIOMTEK Co., Ltd.  
All Rights Reserved  
December 2017, Version A3  
Printed in Taiwan**

## Safety Approvals

- ◆ CE Marking
- ◆ FCC Class B

### ◆ FCC Compliance

This equipment has been tested and complies with the limits for a Class B digital device, pursuant to Part 15 of the FCC Rules. These limits are designed to provide reasonable protection against harmful interference in a residential installation. If not installed and used in accordance with proper instructions, this equipment might generate or radiate radio frequency energy and cause harmful interference to radio communications. However, there is no guarantee that interference will not occur in a particular installation. If this equipment does cause harmful interference to radio or television reception, which can be determined by turning the equipment off and on, the user is encouraged to try to correct the interference by one or more of the following measures:

Reorient or relocate the receiving antenna.

Increase the separation between the equipment and receiver.

Connect the equipment into an outlet on a circuit different from that to which the receiver is connected.

Consult the dealer or an experienced radio/TV technician for help.

Shielded interface cables must be used in order to comply with emission limits.

## Safety Precautions

Before getting started, read the following important cautions.

1. Be sure to ground yourself to prevent static charge when installing the internal components. Use a grounding wrist strap and place all electronic components in any static-shielded devices. Most electronic components are sensitive to static electrical charge.
2. Disconnect the power cords from the **NA362 Series** before making any installation. Be sure both the system and the external devices are turned OFF. Sudden surge of power could ruin sensitive components. Make sure the **NA362 Series** is properly grounded.
3. Do not open the system's top cover. If opening the cover for maintenance is a must, only a trained technician is allowed to do so. Integrated circuits on computer boards are sensitive to static electricity. To avoid damaging chips from electrostatic discharge, observe the following precautions:
  - Before handling a board or integrated circuit, touch an unpainted portion of the system unit chassis for a few seconds. This will help to discharge any static electricity on your body.
  - When handling boards and components, wear a wrist-grounding strap, available from most electronic component stores.

## Trademarks Acknowledgments

AXIOMTEK is a trademark of AXIOMTEK Co., Ltd.

IBM, PC/AT, PS/2, VGA are trademarks of International Business Machines Corporation.

Intel<sup>®</sup> and Pentium<sup>®</sup> are registered trademarks of Intel Corporation. MS-DOS, Microsoft C and QuickBASIC are trademarks of Microsoft Corporation.

Other brand names and trademarks are the properties and registered brands of their respective owners.

# Table of Contents

---

Disclaimers.....	ii
Safety Approvals .....	iii
Safety Precautions .....	iv
<b>CHAPTER 1 INTRODUCTION .....</b>	<b>1</b>
1.1    General Description.....	1
1.2    Features.....	1
1.3    Specifications .....	2
1.3.1    System .....	2
1.3.2    Mechanical / Environmental .....	3
1.4    Dimensions and Outlines .....	4
1.5    I/O Outlets .....	6
1.5.1    Front Panel of NA362.....	6
1.5.2    Rear Panel for NA362.....	7
1.5.3    Front Panel for NA362R.....	8
1.5.4    Rear Panel for NA362R.....	9
<b>CHAPTER 2 HARDWARE DESCRIPTION .....</b>	<b>11</b>
2.1    Checklist.....	11
2.2    Memory Module (UDIMM/RDIMM) and HDD .....	11
2.3    Board Layout.....	13
2.4    Jumper Settings.....	15
2.4.1    Clear CMOS Jumper (JP3) .....	16
2.4.2    LAN Bypass Control Selection (JP7, JP8, JP9) .....	16
2.4.3    TACT SW1 Selection (JP10).....	17
2.4.4    Case Open Connector (CN5) .....	17
2.5    Connectors.....	18
2.5.1    LCM Connector (LCM1, optional for NA362R) .....	19
2.5.2    Digital Input / Output Connector (DIO1) .....	19
2.5.3    SIM card connector (SIM1).....	20
2.5.4    Serial Port2 Connector (COM2).....	20
2.5.5    FAN Connector (FAN1, FAN2, FAN3) .....	21
2.5.6    Serial ATA Connector: (SATA1, SATA2, SATA3, SATA4).....	21
2.5.7    SATA Power Connector: (CN1, CN2) .....	21
2.5.8    Mini Card Connector (CN4).....	22
2.5.9    Mini Card Connector (CN7).....	23
2.5.10    Case Open Connector (CN5) .....	24
2.5.11    Front Panel Bezel Connector (JP2).....	24
2.5.12    DC-In Power Jack (CN14).....	25
2.5.13    4P Wafer Power Input Connector (ATX2, optional for NA362R) .....	25
2.5.14    Power Switch Connector (ATX1).....	25
2.5.15    Port0 SFP+ Cage Connector (CN8) .....	26
2.5.16    Port1 SFP+ Cage Connector(CN16).....	27
2.5.17    Console (COM1) and USB connector (CN13) .....	28
2.5.18    LED1~LED15 .....	29
<b>CHAPTER 3 AMI BIOS SETUP UTILITY .....</b>	<b>31</b>

3.1	Starting .....	31
3.2	Navigation Keys .....	31
3.3	Main Menu .....	32
3.4	Advanced Menu.....	33
3.5	IntelRCSetup .....	58
3.6	Security Menu .....	67
3.7	Boot Menu .....	68
3.8	Save & Exit Menu .....	72
<b>APPENDIX A LAN BYPASS CONFIGURATION .....</b>		<b>79</b>
	About LAN Bypass .....	79
	LAN Bypass Register Configuration .....	80
<b>APPENDIX B WDT TIMER FOR SYSTEM RESET.....</b>		<b>85</b>
<b>APPENDIX C WARNING.....</b>		<b>87</b>

# CHAPTER 1

## INTRODUCTION

This chapter contains general information and detailed specifications of the **NA362 Series** Network Appliance Server. Chapter 1 contains the following sections:

- **General Description**
- **Features**
- **Specifications**
- **Dimensions and Outlines**
- **I/O Outlets**

### 1.1 General Description

The NA362 is a 1U desktop and NA362R is a 1U rack mount network security hardware platform for VPN, firewall and other network security applications, which consists can support of Intel® ATOM C3000 family processors. This platform supports the 1U desktop and 1U rack mount form factor, and the system supports DDR4 U-DIMM/R-DIMM memory up to maximum 64/128 GB. In the meantime, the platform also can support 6 Gigabit LAN ports and 4 10G SFP+ depends on CPU SKU which can provide best throughput. For the purpose to store event log data, it can deploy one 2.5" SATA3 HDD (NA362) or two 2.5" SATA3 HDD (NA362R), and one mSATA. This platform can be easily enabled through application programs to make a user-friendly appliance for customers, and provide the highest ever performance of encryption and decryption.

### 1.2 Features

Low power and high performance for network security field applications. NA362 series supports Intel® ATOM C3000 family processors.

- Supports six 10/100/1000Mbps Ethernet ports
- Support four 10G SFP+ fiber ports depends on CPU SKU
- Supports BIOS redirected to COM port features
- Supports one 2.5" SATA Hard Disk (NA362),two 2.5" SATA Hard Disk(NA362R)
- Supports one mSATA
- Support 2 or 4 U-DIMM/R-DIMM, up to 64/128GB memory
- Reasonable computing performance and throughput for processor and LAN ports
- Suitable for Network Appliance; VPN, network bandwidth controller, firewall and UTM

## 1.3 Specifications

### 1.3.1 System

- **System CPU**
  - Intel<sup>®</sup> C3000 family processors.
- **BIOS**
  - AMI SPI flash BIOS
- **System Memory**
  - Two or four DDR4 U-DIMM/R-DIMM, non-buffer non-ECC memory, up to 64/128GB
- **Storage Interface**
  - One 2.5" SATA3 HDD for NA362/ Two 2.5" SATA3 HDD for NA362R
  - One mSATA
- **Expansion Slot**
  - Two PCI Express Mini Card Socket
  - One Full size, Support USB & M-SATA(default) or PCIe signal with SIMM Socket
  - One Full size, Support USB & PCIe(default) or M-SATA signal
- **Network Interface**
  - Six 10/100/1000Mbps Ethernet (Intel<sup>®</sup> i210)
  - Four 10GbE SFP+ depends on CPU SKU
  - One groups LAN by pass support latch relay for optional
- **Watchdog Timer**
  - One for LAN by pass :8 levels,1-64 seconds
  - One for system reset: 255 levels,1-255 sec
- **USB**
  - Two USB2.0 ports in the rear side
- **Console**
  - RS-232 Console port is the rear side(RJ-type)
- **Power**
  - NA362 :1 x 12V, 5A/7A power adapter (NA362)
  - NA362R: AC/DC 120W open frame (NA362R)
- **OS Compatibility**
  - Yocto, Linux, Windows Server 2012 R2, Windows Server 2016.



### 1.3.2 Mechanical / Environmental

- **Form Factor**
  - NA362 :1U Desktop
  - NA362R:1U Rack mount
- **LED**
  - Power, HDD, Link/Act with transfer rate
  - LAN by pass LED and programmable LED
- **Operation Temperature**
  - NA362 :0°C ~ 40°C (32°F ~ 104°F)
  - NA362R: 0°C ~ 45°C (32°F ~ 113°F)
- **Storage Temperature**
  - -20°C ~ 70°C (-4°F ~ 158°F)
- **Humidity**
  - 10% - 95% RH, non-condensing
- **Chassis Material**
  - Steel
- **Dimensions**
  - NA362 :44mm (1.73") (H) x 231mm (9.09") (W) x 197mm (7.75")
  - NA362R: 44mm (1.73") (H) x 430mm (16.93") (W) x 250mm (9.84")
- **Weight (Net/Gross)**
  - NA362 :1.64 kg /2.69kg
  - NA362R: 3.5 kg/ 4.5 kg



**NOTE:** All specifications and images are subject to change without notice.



## NA362R

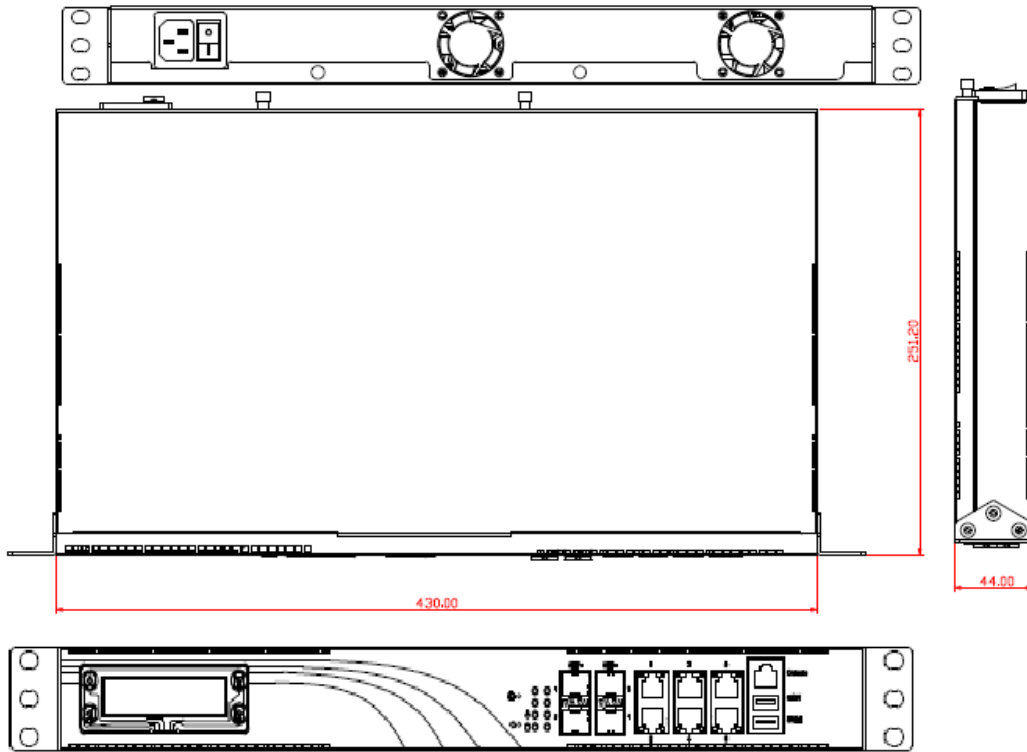

## 1.5 I/O Outlets

Locate the front panel I/O outlets on the **NA362 Series** server to connect serial and Ethernet interface devices.

### 1.5.1 Front Panel of NA362

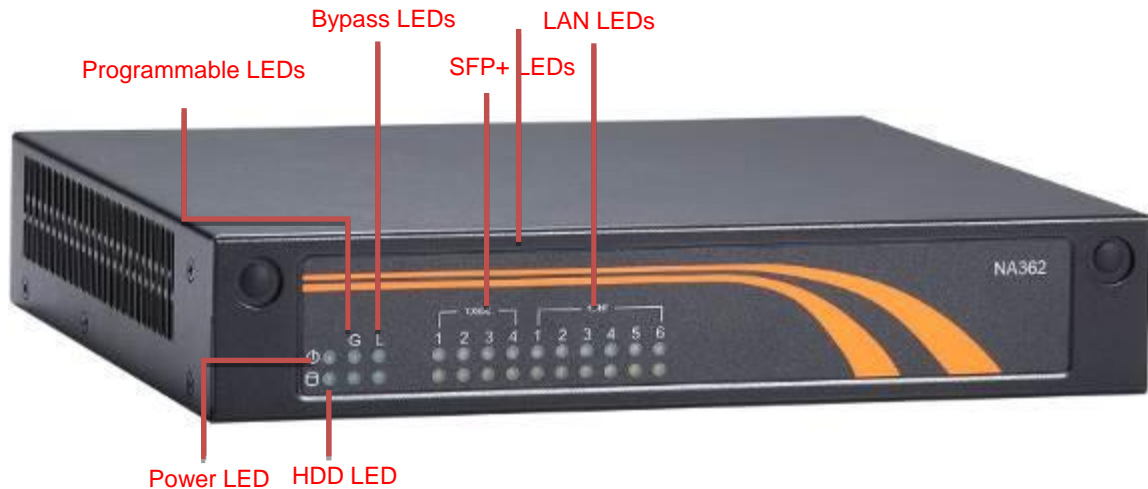

- **LAN By-Pass LED**

While running the LAN By-Pass function, the LED always lights up.

- **Programmable LED**

A sample code will be provided that allow users to define their own function.



**NOTE:** *If you need sample codes please contact our FAE directly, and they are only for customers' reference as remarked.*

- **Power LED**

It will be lighting when the server is powered on to perform diagnostic tests and check a proper operation.

- **LAN Link LED**

It will be lighting when a twisted pair is connected to another Ethernet device on the port. It shows network transfer rate while making a connection.

- **LAN Activity LED**

It will be lighting when the server is transmitting or receiving a packet through the twisted pair ports.

- **SFP+ Link LED**

It will be lighting when a SFP+ transceiver module is connected.

- **SFP+Activity LED**

It will be lighting when the server is transmitting or receiving a packet through the SFP+ transceiver modules

- **HDD LED**

The LED flashes when transmitting or receiving any signals.

## 1.5.2 Rear Panel for NA362

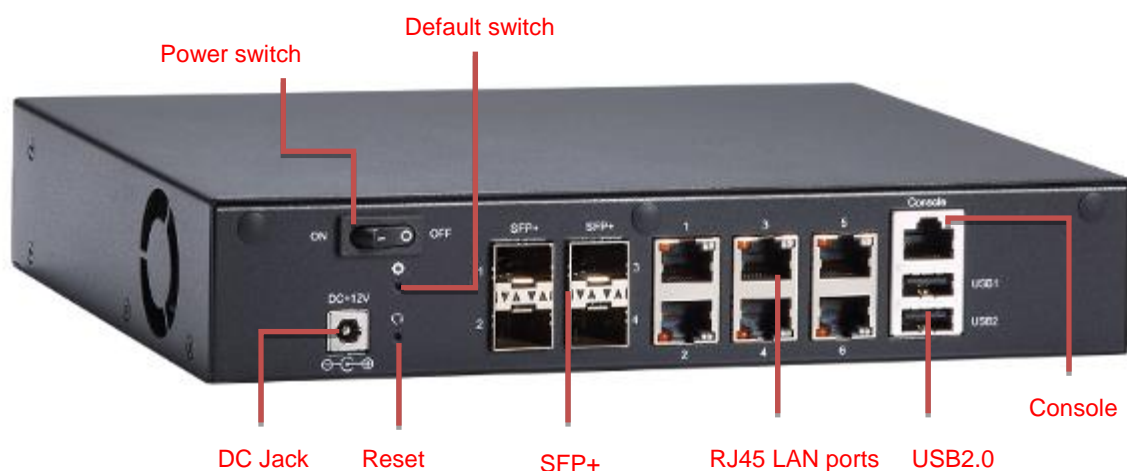

- **Console port**

RS-232 Console port is for the command of line interface and of diagnostic support by P.O.S.T (Power on Self Test).

- **Reset Switch**

It is for reset the system to reboot your computer instead of turning OFF the power switch. It is a better way to reboot your system for a longer life of the system's power supply.

- **Default Switch**

The sample code will be provided that allows users to define their own function. For example, when the system has any problems, this switch can support to reset it to the customer's OS default settings if our customer's OS supports this application.

- **Power Switch**

After plug in power supply, it can use power switch to power On/Off device.

- **USB 2.0**

Two A type USB 2.0 host. It supports 500mA power supply.

- **SFP+ ports (depends on CPU SKU)**

Four 10G SFP+ fiber ports. It depends on CPU SKU.

- **10/100/1000 Mbps Ethernet ports**

Six 10/100/1000 Mbps Ethernet ports, it complies IEEE 802.3.

- **Active LED for LAN port #1, port#2, port#3, port#4, port#5, port#6 and SFP+ port #1, port#2, port#3, port#4.**

The Amber LED is on when the LAN/Fiber port connection is working.

### 1.5.3 Front Panel for NA362R



- **Power on LED**

System and power on

- **HDD LED**

Link/Active LED (single color)

1. The green LED is on when it is a normal HD connection.
2. The LED flashes when transmitting or receiving any signals.

- **LAN By-Pass LED**

While running the LAN By-Pass function, the LED always lights up.

- **GPIO LED**

A sample code will be provided that allow users to define their own function.



**NOTE:** If you need sample codes please contact our FAE directly, and they are only for customers' reference as remarked.

- **Active LED for LAN port #1, port#2, port#3, port#4, port#5, port#6 and SFP+ port #1, port#2, port#3, port#4.**

The Amber LED is on when the LAN/Fiber port connection is working.

- **SFP+ Link LED**

It will be lighting when a SFP+ transceiver modules is connected.

- **SFP+Activity LED**

It will be lighting when the server is transmitting or receiving a packet through the SFP+ transceiver modules.

- **Console port**

RJ RS-232 Console port is for the command of line interface and of diagnostic support by P.O.S.T (Power on Self Test).

- **Reset Switch**

It is for reset the system to reboot your computer instead of turning OFF the power switch. It is a better way to reboot your system for a longer life of the system's power supply.

- **Default Switch**

The sample code will be provided that allows users to define their own function. For example, when the system has any problems, this switch can support to reset it to the customer's OS default settings if our customer's OS supports this application

### 1.5.4 Rear Panel for NA362R

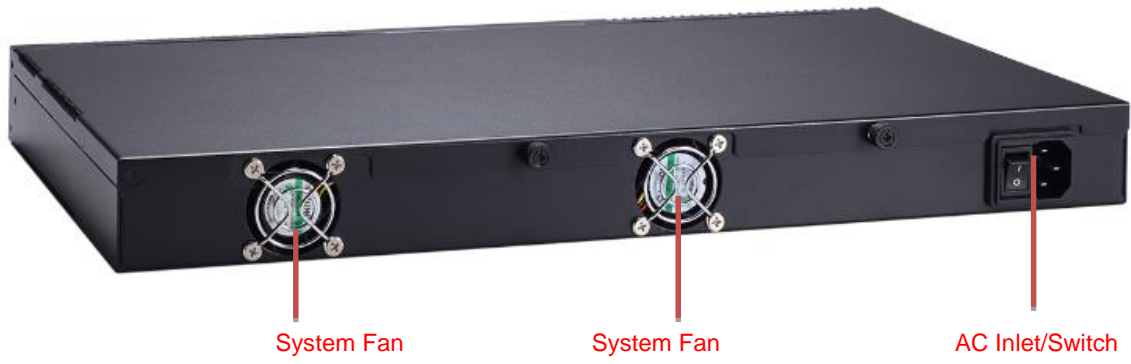

**This page is intentionally left blank.**



## CHAPTER 2

# HARDWARE DESCRIPTION

The **NA362 Series** are convenient for your various hardware configurations. The chapter 2 will help you get familiar with the hardware.

### 2.1 Checklist

The package bundled with your **NA362 Series** should contain the following items:

The **NA362 Series** network appliance hardware platform

- DC Power Adapter x 1, Power cord x 1 (NA362); power cord x 1 (NA362R)
- Mounting screws for disk drive
- cable kits (1 x SATA cable, 1 x SATA power cable for NA362; 2 x SATA cable, 1 x SATA power cable for NA362R)
- Plastic stand for stack-up x 4
- Rack mount ear kit (NA362R)

If you cannot find this package or any items are missing, please contact AXIOMTEK distributors immediately. If you order any optional components, the package might contain those additional hardware or documents accordingly.

### 2.2 Memory Module (UDIMM/RDIMM) and HDD

The main board supports two or four DDR4 UDIMM/RDIMM socket. Maximum memory capacity is up to 64/128GB ECC/Non-ECC unbuffer memory.

The following steps show you how to install the memory modules:

- 1 Push down each side of the DIMM socket.
- 2 Align the memory module with the socket that notches of memory module must match the socket keys for a correct installation.
- 3 Install the memory module into the socket and push it firmly down until it is fully seated. The socket latches are levered upwards and clipped on to the edges of the DIMM.
- 4 Install any remaining DIMM modules.

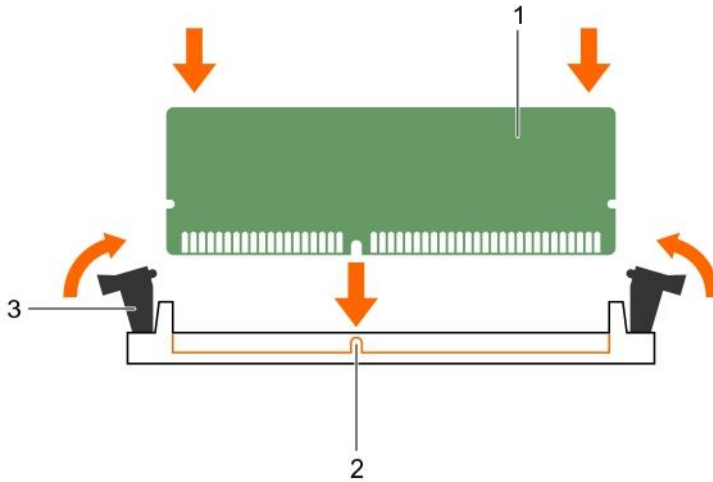

	DIMM1	DIMM0
Channel B	DIMM1	DIMM2
Channel A	DIMM3	DIMM4

**NOTE:** if processor is dual core ,please install the memory from DIMM4(channel A DIMM0),if the processor is quad core or 8 core can support dual channel from DIMM4(channel A DIMM0) and DIMM2(channel B DIMM0)

Connects SATA cable and SATA power cable from HDD to SATA connector (SATA1) and SATA power connector (CN1 or CN2) together then installs HDD by HDD rack and screws properly (NA362)



## 2.3 Board Layout

### Component Side

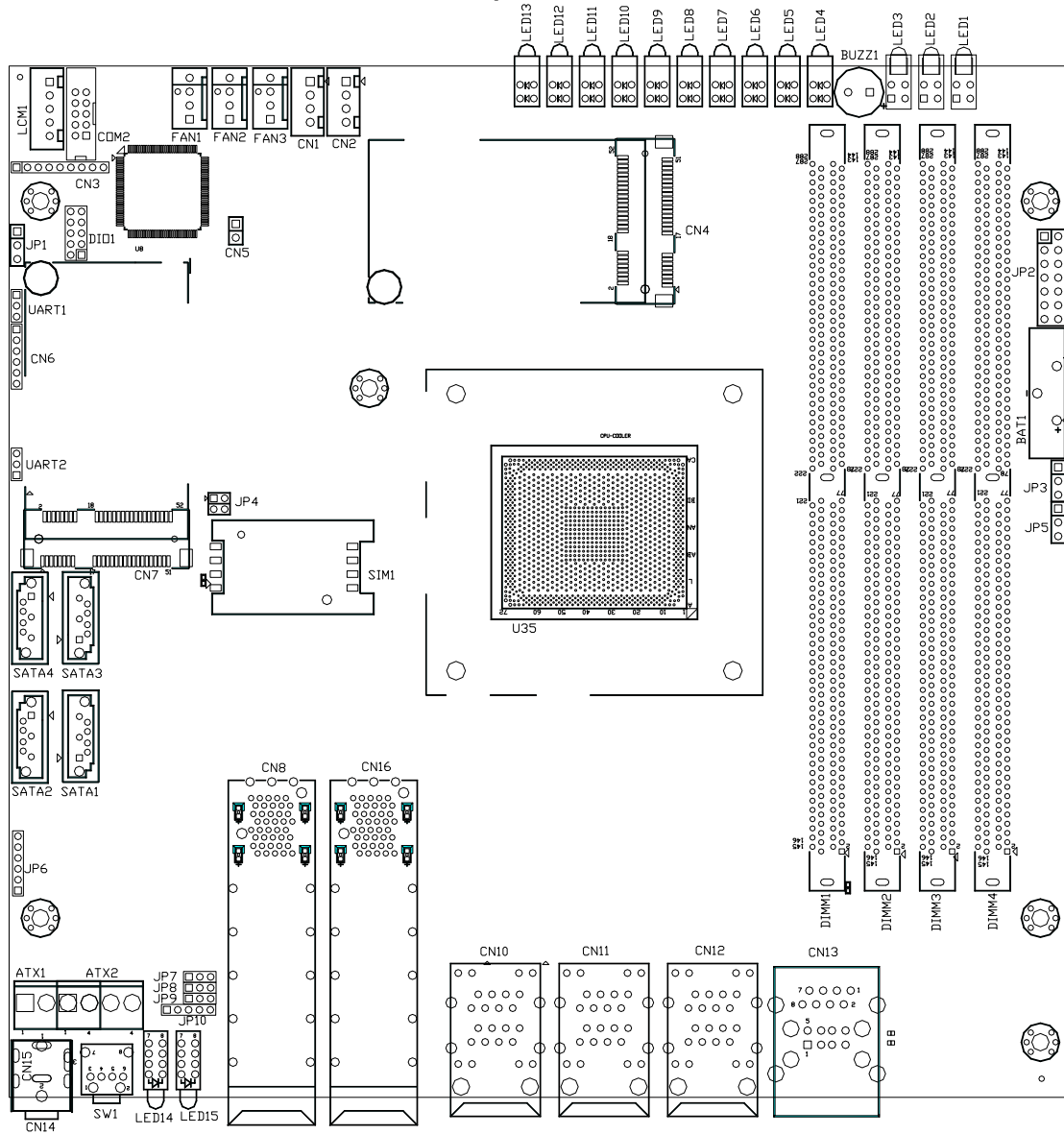

Bottom Side

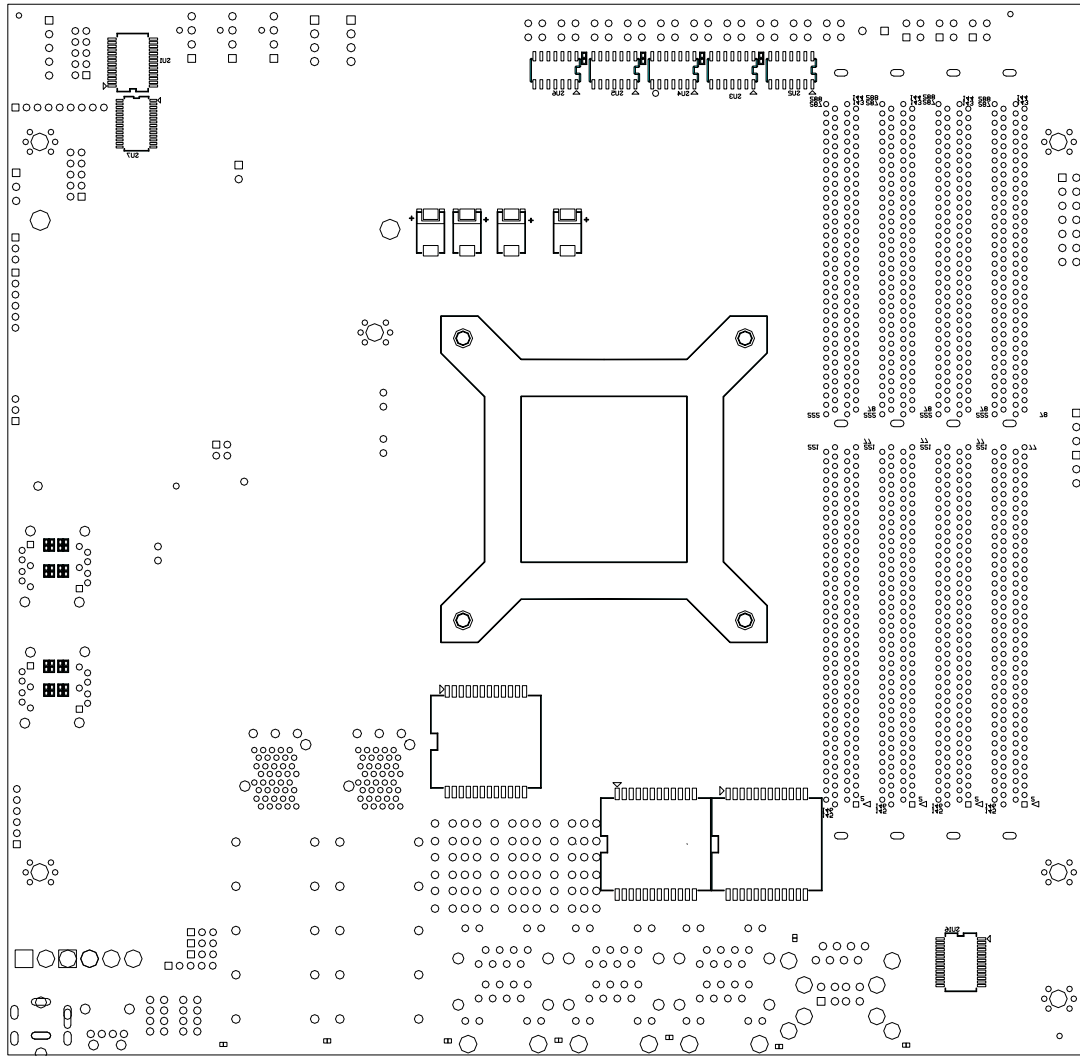



## 2.4 Jumper Settings

This section provides the information about jumpers and connectors of **NA362 Series**. Proper jumper settings configure the main board in this appliance to meet your application purpose. We are herewith listing a summary table of all jumpers and default settings for onboard devices, respectively.

Jumper	Definition	Jumper Settings
JP3	Clear CMOS Setting	1-2 : Normal (Default) 2-3 : Clear CMOS
JP7 JP8 JP9	LAN Bypass Trigger When Power On	(1-2)/(1-2)/(1-2) : Bypass as same as Power Off status (2-3)/ (1-2)/(1-2) : Bypass Disable(Default) (2-3)/(2-3)/ (1-2) : Bypass Enable
JP10	TACT SW1 Selection	1-2 : Power button function 2-3 : Reset button function 4-5 : GPI function
CN5	Case Open Function	Open : Normal (Default) Short : Case Open

### 2.4.1 Clear CMOS Jumper (JP3)

You may need to use this jumper is to clear the CMOS memory if incorrect settings in the Setup Utility.

Description	Function	Jumper Setting
COMS Clear	Normal (Default)	<p>JP3</p> 
	Clear CMOS	<p>JP3</p> 

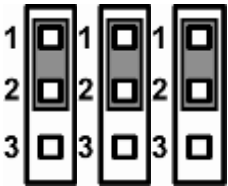
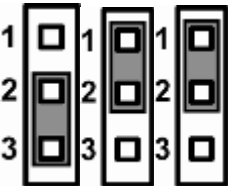
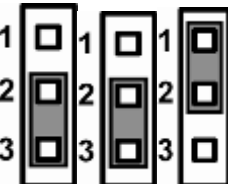

### 2.4.2 LAN Bypass Control Selection (JP7, JP8, JP9)

Description	Function	Jumper Setting
LAN Bypass Trigger when Power On	Bypass as same as Power Off status	<p>JP7 JP8 JP9</p> 
	Bypass Disable(Default)	<p>JP7 JP8 JP9</p> 
	Bypass Enable	<p>JP7 JP8 JP9</p> 

**NOTE:** When the system is turned on, you can select LAN bypass function by Jumper and Bios when power on state, when enter the OS; you can select LAN pass function at power on/ off state by software.

### 2.4.3 TACT SW1 Selection (JP10)

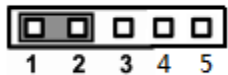
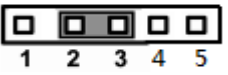
Use this jumper to select the TACT SW1 Function.

Description	Function	Jumper Setting
TACT SW1 Low Button Function Selection	Power button function	<p>JP10</p> 
	Reset button function (Default)	<p>JP10</p> 
	GPI-2 function	<p>JP10</p> 

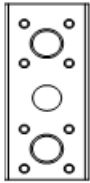

GPI-1 (Default Switch)

Lower Button



**NOTE:** If you need GPI sample codes please contact our FAE directly, and they are for reference purposes only.

### 2.4.4 Case Open Connector (CN5)

Pin	Signal
1	CASEOPEN_N
2	GND

CN5



## 2.5 Connectors

Connectors connect the board with other parts of the system. Loose or improper connection might cause problems. Make sure all connectors are properly and firmly connected. Here is a summary table shows you all connectors on the main board.

Connectors	Label
LCM Connector	LCM1
Digital Input / Output Connector	DIO1
SIM Card Connector	SIM1
Serial Port 2 Connector	COM2
Smart FAN Connector	FAN1
Smart FAN Connector	FAN2
Smart FAN Connector	FAN3
Serial ATA Connector	SATA1
Serial ATA Connector	SATA2
Serial ATA Connector	SATA3
Serial ATA Connector	SATA4
SATA Power Connector	CN1
SATA Power Connector	CN2
Mini Card Connector (PCIe interface)	CN4
Mini Card Connector (SATA interface)	CN7
Case Open Connector	CN5
Front Panel Bezel Connector	JP2
DC Power Jack (NA362)	CN14
4P Wafer Power Input Connector(NA362R)	ATX2
Power Switch Connector(NA362)	ATX1
Port0 SFP+ Cage Connector	CN8
Port1 SFP+ Cage Connector	CN16
COM1(Console) and USB2.0 Connector	CN13
LAN1 and LAN2 Connector	CN10
LAN3 and LAN4 Connector	CN11
LAN5 and LAN6 Connector	CN12
DIMM Connector	DIMM1
DIMM Connector	DIMM2
DIMM Connector	DIMM3
DIMM Connector	DIMM4



### 2.5.1 LCM Connector (LCM1, optional for NA362R)

Pin	Signal
1	+5V
2	RX
3	N.C
4	TX
5	GND

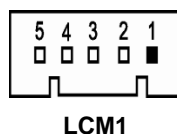

### 2.5.2 Digital Input / Output Connector (DIO1)

The board is equipped with an 8-channel (4 inputs and 4 outputs, default setting is “High”) digital I/O connector that meets requirements for a system customary automation control. The digital I/O can be configured to control cash drawers and sense warning signals from an Uninterrupted Power System (UPS), or perform store security control. You may use software programming to control these digital signals.

Pin	Signal
1	GND
2	GND
3	GPO3
4	GPI3
5	GPO2
6	GPI2
7	GPO1
8	GPI1
9	GPO0
10	GPI0

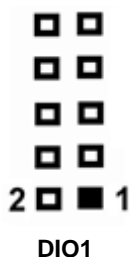

### 2.5.3 SIM card connector (SIM1)

In order to work properly, the SIM Card must be used together with Mini Card which is inserted to socket CN7. It is mainly used in 3G/LTE wireless network application.

Pin	Signal
C1	PWR
C2	RST
C3	CLK
C5	GND
C6	VPP
C7	DATA

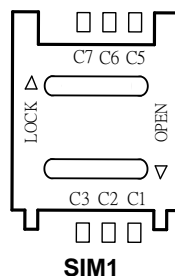

### 2.5.4 Serial Port2 Connector (COM2)

Pin	Signal
1	Data Carrier Detect (DCD)
2	Data Set Ready(DSR)
3	Receive Date(RXD)
4	Request to Send(RTS)
5	Transmit Data(TXD)
6	Clear to Send(CTS)
7	Data Terminal Ready(DTR)
8	Ring Indicator(RI)
9	GND
10	NC

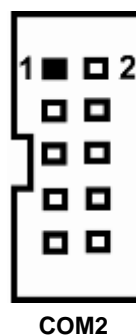

### 2.5.5 FAN Connector (FAN1, FAN2, FAN3)

Pin	Signal
1	GND
2	+12V level
3	Sensor
4	PWM

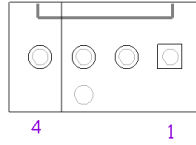

FAN1 , FAN2, FAN3

### 2.5.6 Serial ATA Connector: (SATA1, SATA2, SATA3, SATA4)

The SATA connector is for high-speed SATA interface port and it can be connected to hard disk device.

Pin	Signal	Pin	Signal
1	GND	2	TX+
3	TX-	4	GND
5	RX-	6	RX+
7	GND	—	—

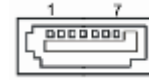

SATA1, SATA2, SATA3, SATA4

### 2.5.7 SATA Power Connector: (CN1, CN2)

The SATA power connector is for providing power to hard disk device.

Pin	Signal
1	+5V
2	GND
3	GND
4	+12V

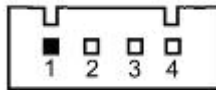

CN1, CN2

## 2.5.8 Mini Card Connector (CN4)

Default setting is PCIe signal and reserves SATA signal for optional.

Pin	Signal	Pin	Signal
1	WAKE_N	2	P3V3_STBY
3	N/C	4	GND
5	N/C	6	P1V05_S
7	CLK_REQ_N	8	N/C
9	GND	10	N/C
11	DATA	12	N/C
13	CLK_N	14	N/C
15	CLK_P	16	N/C
17	GND	18	GND
19	N/C	20	RVD
21	N/C	22	RESET_N
23	RX_N	24	P3V3_STBY
25	RX_P	26	GND
27	GND	28	P1V05_S
29	GND	30	SMB_CLK
31	TX_N	32	SMB_DATA
33	TX_P	34	GND
35	GND	36	USB_N
37	GND	38	USB_P
39	P3V3_STBY	40	GND
41	P3V3_STBY	42	N/C
43	GND	44	N/C
45	N/C	46	N/C
47	N/C	48	P1V05_S
49	N/C	50	GND
51	N/C	52	P3V3_STBY

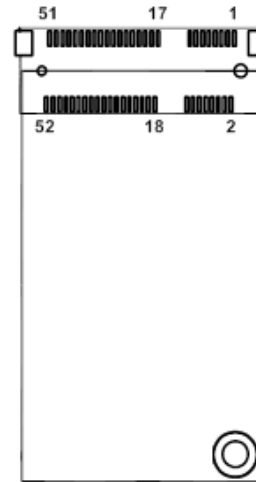

CN4

## 2.5.9 Mini Card Connector (CN7)

Default setting is SATA signal and reserves PCIe signal for optional.

Pin	Signal	Pin	Signal
1	WAKE_N	2	P3V3_STBY
3	N/C	4	GND
5	N/C	6	P1V05_S
7	CLK_REQ_N	8	N/C
9	GND	10	N/C
11	DATA	12	N/C
13	CLK_N	14	N/C
15	CLK_P	16	N/C
17	GND	18	GND
19	N/C	20	RVD
21	N/C	22	RESET_N
23	RX_P	24	P3V3_STBY
25	RX_N	26	GND
27	GND	28	P1V05_S
29	GND	30	SMB_CLK
31	TX_N	32	SMB_DATA
33	TX_P	34	GND
35	GND	36	USB_N
37	GND	38	USB_P
39	P3V3_STBY	40	GND
41	P3V3_STBY	42	N/C
43	GND	44	N/C
45	N/C	46	N/C
47	N/C	48	P1V05_S
49	N/C	50	GND
51	N/C	52	P3V3_STBY

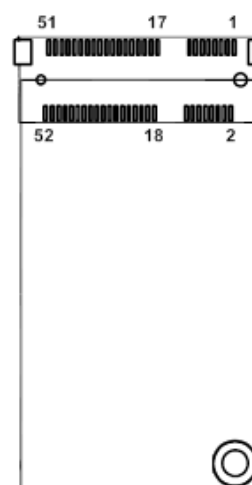

**CN7**

### 2.5.10 Case Open Connector (CN5)

Pin	Signal
1	CASEOPEN_N
2	GND

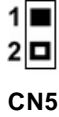

### 2.5.11 Front Panel Bezel Connector (JP2)

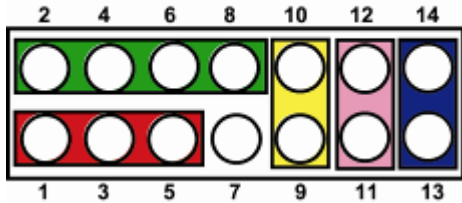

#### Power LED :

This 3-pin connector (Pin 1, 3, 5) connects a LED indicator to the system power switch on the case. Pin 1 is assigned as +, and Pin 3, Pin 5 as -. The Power LED lights up when the system is powered ON.

#### External Speaker and Internal Buzzer Connector :

This 4-pin connector (Pin 2, 4, 6, 8) can be connected to the case-mounted speaker unit or internal buzzer. While connecting the CPU card to an internal buzzer, please short pins 2-4; while connecting to an external speaker, you need to set pins 2-4 to Open and connect the speaker cable to pin 8 (+) and pin 2 (-).

#### System Reset Switch :

This 2-pin connector (Pin 11, 12) can be connected to the case-mounted reset switch that reboots your computer instead of turning OFF the power switch. It is a better way to reboot your system for a longer life of the system's power supply.

#### HDD Activity LED :

This connection is linked to hard drive activity LED on the control panel. LED flashes when HDD is being accessed. The 2-pin connector (Pin 13, 14) connects the hard disk drive to the front panel HDD LED, Pin 13 assigned as -, and Pin 14 as +.

### 2.5.12 DC-In Power Jack (CN14)

Pin	Signal
1	+12V
2	GND

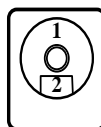

CN14

### 2.5.13 4P Wafer Power Input Connector (ATX2, optional for NA362R)

Pin	Signal
1	+12V
2	+12V
3	GND
4	GND

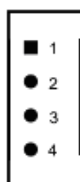

ATX2

### 2.5.14 Power Switch Connector (ATX1)

Pin	Signal
1	+12V
2	+12V
3	DC_INPUT
4	DC_INPUT

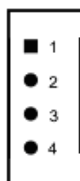

ATX1

### 2.5.15 Port0 SFP+ Cage Connector (CN8)

Pin	Signal	Pin	Signal
T1	GND	L1	GND
T2	TX_Fault	L2	TX_Fault
T3	TX_Disable	L3	TX_Disable
T4	SDA	L4	SDA
T5	SDC	L5	SDC
T6	MOD_ABS	L6	MOD_ABS
T7	RS0	L7	RS0
T8	RX_LOS	L8	RX_LOS
T9	RS1	L9	RS1
T10	GND	L10	GND
T11	GND	L11	GND
T12	RX_N	L12	RX_N
T13	RX_P	L13	RX_P
T14	GND	L14	GND
T15	VCCR	L15	VCCR
T16	VCCT	L16	VCCT
T17	GND	L17	GND
T18	TX_P	L18	TX_P
T19	TX_N	L19	TX_N
T20	GND	L20	GND
A	Down Fiber Port: Active		
B	Up Fiber Port: Active		
C	Down Fiber Port: Link		
D	Up Fiber Port: Link		

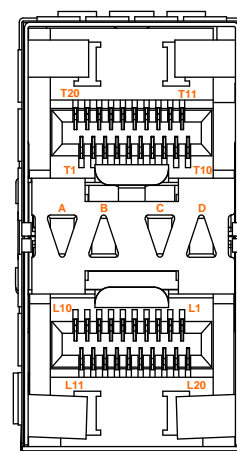

**CN8**



### 2.5.16 Port1 SFP+ Cage Connector(CN16)

Pin	Signal	Pin	Signal
T1	GND	L1	GND
T2	TX_Fault	L2	TX_Fault
T3	TX_Disable	L3	TX_Disable
T4	SDA	L4	SDA
T5	SDC	L5	SDC
T6	MOD_ABS	L6	MOD_ABS
T7	RS0	L7	RS0
T8	RX_LOS	L8	RX_LOS
T9	RS1	L9	RS1
T10	GND	L10	GND
T11	GND	L11	GND
T12	RX_N	L12	RX_N
T13	RX_P	L13	RX_P
T14	GND	L14	GND
T15	VCCR	L15	VCCR
T16	VCCT	L16	VCCT
T17	GND	L17	GND
T18	TX_P	L18	TX_P
T19	TX_N	L19	TX_N
T20	GND	L20	GND
A	Down Fiber Port: Active		
B	Up Fiber Port: Active		
C	Down Fiber Port: Link		
D	Up Fiber Port: Link		

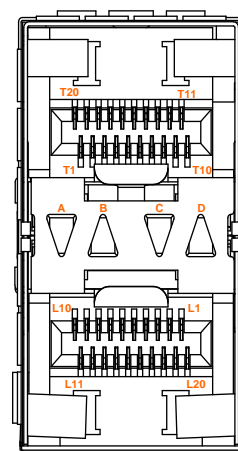

**CN16**

### 2.5.17 Console (COM1) and USB connector (CN13)

Pin	Signal
U1	5V
U2	USB0_D-
U3	USB0_D+
U4	GND
U5	5V
U6	USB1_D-
U7	USB1_D+
U8	GND
C1	Request to Send (RTS)
C2	Data Terminal Ready (DTR)
C3	Transmit Data (TXD)
C4	Ground (GND)
C5	Ground (GND)
C6	Receive Data (RXD)
C7	Data Set Ready (DSR)
C8	Clear to Send (CTS)

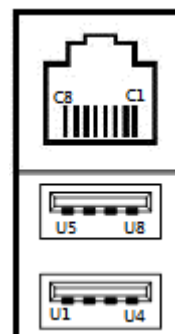

**CN13**

## 2.5.18 LED1~LED15

LED1~13 for NA362

LED14-15 for NA362R

LED	Signal
LED1	Up : Power LED (Green) Down : HDD LED (Green) Down : Active (Orange)
LED2	Up : GPO(Programmable LED) Down : GPO (Programmable LED) Down : Lan Bypass LED (Option)
LED3	Up : Lan Bypass LED (Green) Down : GPO LED
LED4	For SFP1 Up : LINK (Amber) Down : Active (Orange)
LED5	For SFP2 Up : LINK (Amber) Down : Active (Orange)
LED6	For SFP3 Up : LINK (Amber) Down : Active (Orange)
LED7	For SFP4 Up : LINK (Amber) Down : Active (Orange)
LED8	For Lan1 Up : LINK (Green : LINK100 ; Amber : LINK1000) Down : Active (Orange)
LED9	For Lan2 Up : LINK (Green : LINK100 ; Amber : LINK1000) Down : Active (Orange)
LED10	For Lan3 Up : LINK (Green : LINK100 ; Amber : LINK1000) Down : Active (Orange)
LED11	For Lan4 Up : LINK (Green : LINK100 ; Amber : LINK1000) Down : Active (Orange)
LED12	For Lan5 Up : LINK (Green : LINK100 ; Amber : LINK1000) Down : Active (Orange)

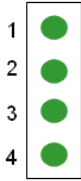
LED	Signal
LED13	For Lan6 Up : LINK (Green : LINK100 ; Amber : LINK1000) Down : Active (Orange)
LED14	Lan Bypass LED GPO LED POWER LED HDD LED 
LED15	GPO LED GPO LED GPO LED GPO LED 

## CHAPTER 3

# AMI BIOS SETUP UTILITY

This chapter provides users with detailed description how to set up basic system configuration through the AMIBIOS8 BIOS setup utility.

### 3.1 Starting

To enter the setup screens, follow the steps below:

1. Turn on the computer and press the <Del> key immediately.
2. After you press the <Delete> key, the main BIOS setup menu displays. You can access the other setup screens from the main BIOS setup menu, such as the Chipset and Power menus.

### 3.2 Navigation Keys

The BIOS setup/utility uses a key-based navigation system called hot keys. Most of the BIOS setup utility hot keys can be used at any time during the setup navigation process.

These keys include <F1>, <F10>, <Enter>, <ESC>, <Arrow> keys, and so on.



**NOTE:** Some of navigation keys differ from one screen to another.

<b>&lt; Left/Right</b>	The Left and Right <Arrow> keys allow you to select a setup screen.
<b>↑↓ Up/Down</b>	The Up and Down <Arrow> keys allow you to select a setup screen or sub-screen.
<b>+– Plus/Minus</b>	The Plus and Minus <Arrow> keys allow you to change the field value of a particular setup item.
<b>Tab</b>	The <Tab> key allows you to select setup fields.
<b>F1</b>	The <F1> key allows you to display the General Help screen.
<b>F10</b>	The <F10> key allows you to save any changes you have made and exit Setup. Press the <F10> key to save your changes.
<b>Esc</b>	The <Esc> key allows you to discard any changes you have made and exit the Setup. Press the <Esc> key to exit the setup without saving your changes.
<b>Enter</b>	The <Enter> key allows you to display or change the setup option listed for a particular setup item. The <Enter> key can also allow you to display the setup sub- screens.

### 3.3 Main Menu

When you first enter the Setup Utility, you will enter the Main setup screen. You can always return to the Main setup screen by selecting the Main tab. There are two Main Setup options. They are described in this section. The Main BIOS Setup screen is shown below.

#### System Time/Date

Use this option to change the system time and date. Highlight *System Time* or *System Date* using the <Arrow> keys. Enter new values through the keyboard. Press the <Tab> key or the <Arrow> keys to move between fields. The date must be entered in MM/DD/YY format. The time is entered in HH:MM:SS format.

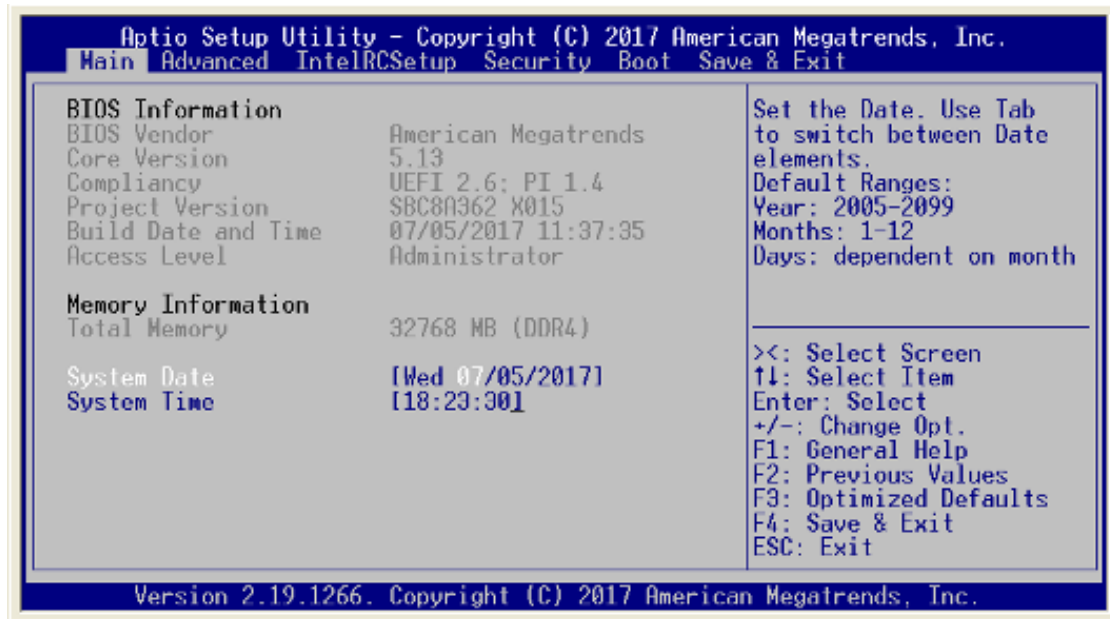

### 3.4 Advanced Menu

The Advanced menu allows users to set configuration of the CPU and other system devices. You can select any of the items in the left frame of the screen to go to the sub menus:

- ▶ **Trusted Computing**
- ▶ **NCT6102D Super IO Configuration**
- ▶ **Hardware Monitor**
- ▶ **Serial Port Console Redirection**
- ▶ **CSM Configuration**
- ▶ **USB Configuration**

For items marked with “▶”, please press <Enter> for more options.

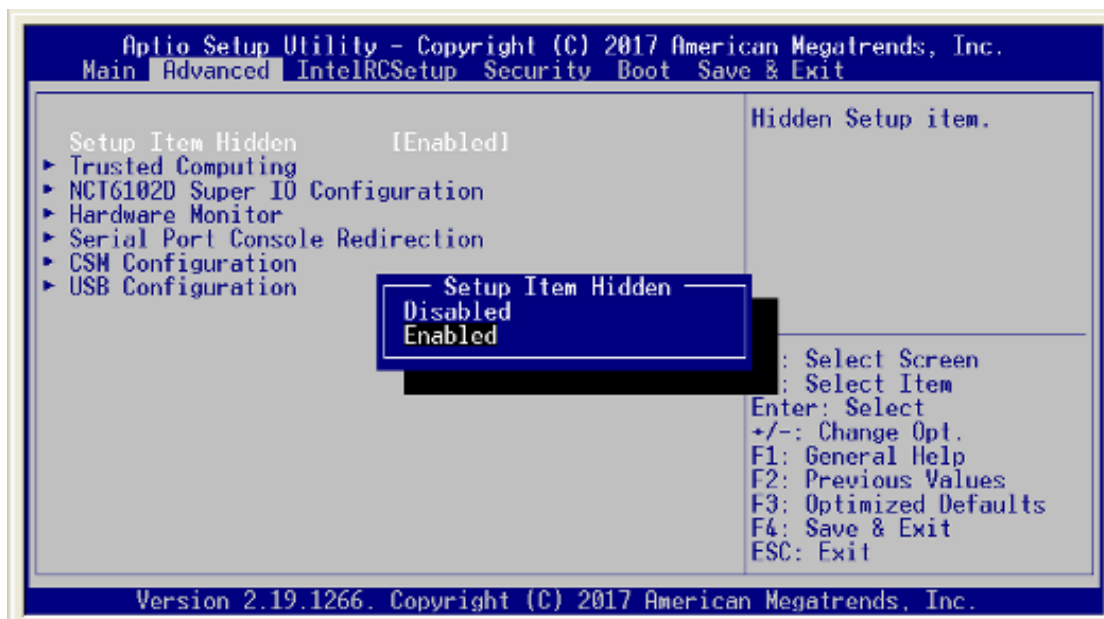
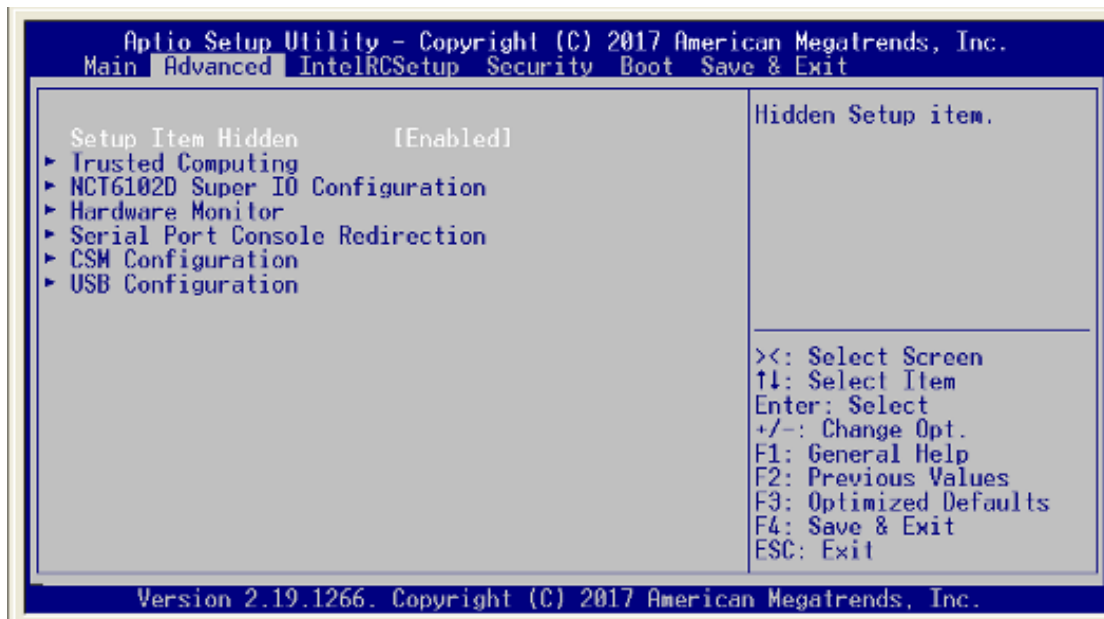

### Trusted Computing

This screen provides the function for specifying the TPM and Security device setting.

#### Security device setup

Use this item to enable or disable BIOS support for security device. OS will not show Security Device.

#### TPM State

Use this item to enable or disable control TPM function.

 **NOTE:** TPM function is available with sku of TPM on board.

 **NOTE:** Your computer will reboot during restart in order to change state of security device.

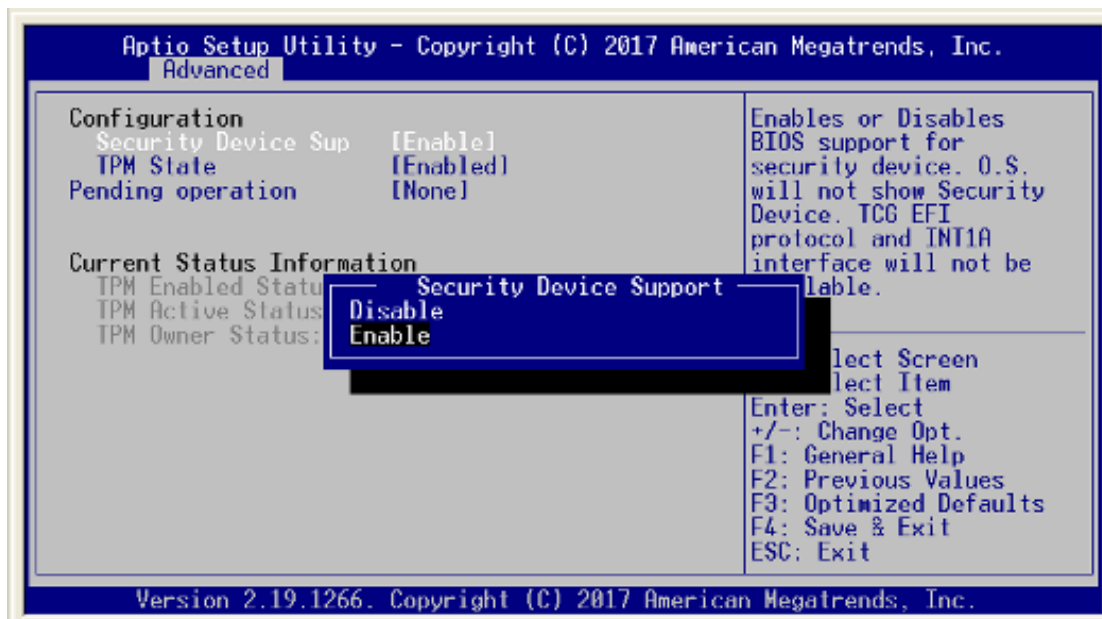
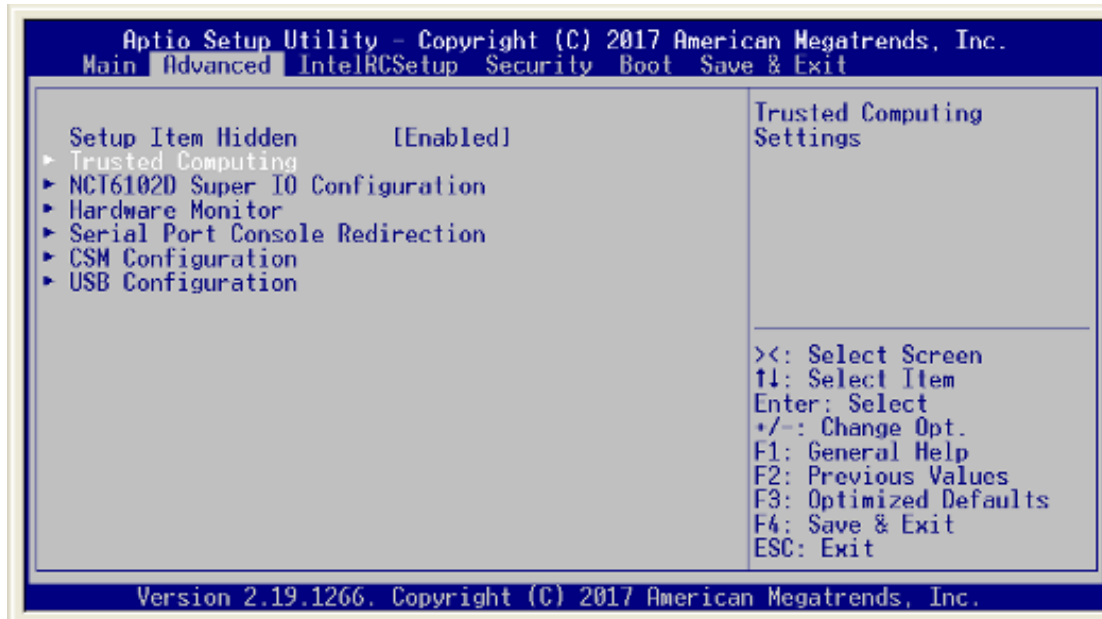



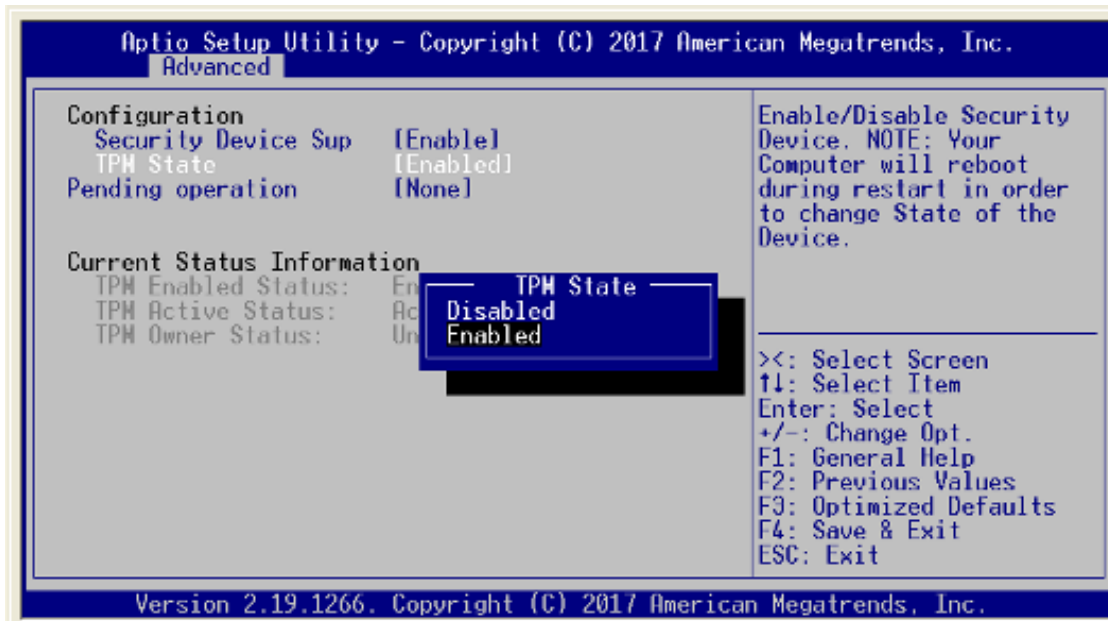

### Pending Operation

Schedule an operation for Security device.

 **NOTE:** Your computer will reboot during restart in order to change state of security device.

 **NOTE:** Clearing TPM Secured Data: When TPM State is set to [Enabled], Pending TPM Operation will appear. Set this item to [TPM Clear] to clear all data secured by TPM or [None] to discard the selection.

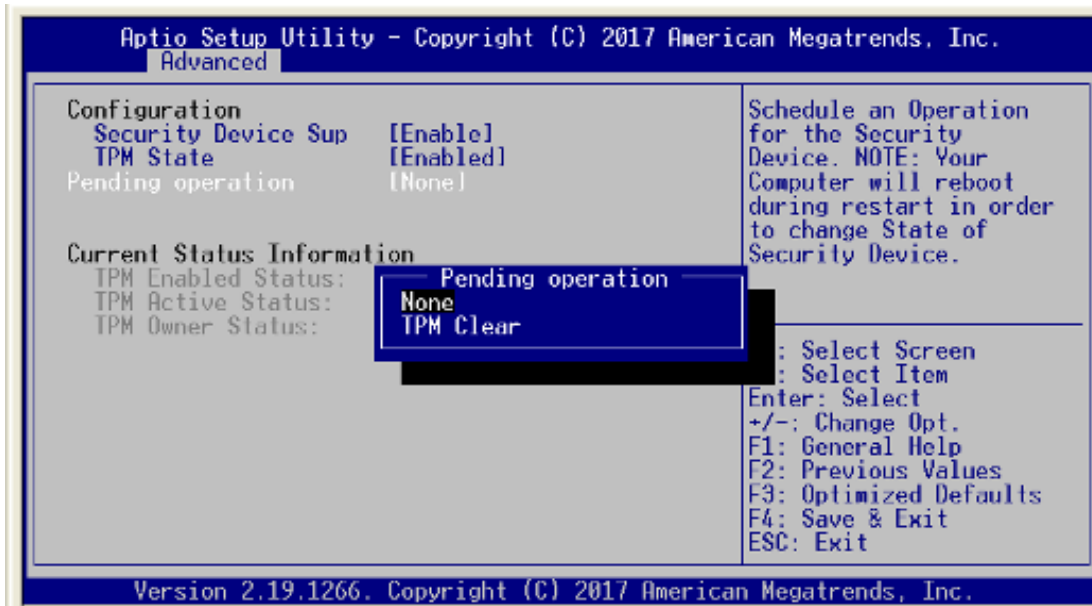

### NCT 6102D Super IO Configuration

You can use this screen to select options for the Super IO Configuration, and change the value of the selected option. A description of the selected item appears on the right side of the screen.

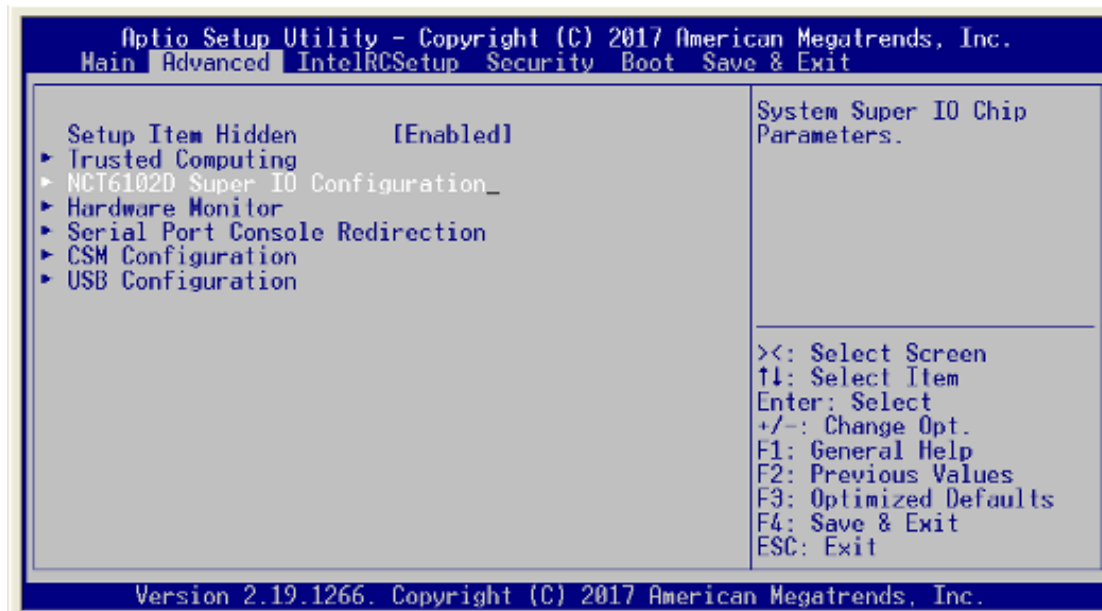

## Serial Port1 Address

This option specifies the base I/O port address and Default setting is 3F8h.  
Here are the options for your selection, Disabled.

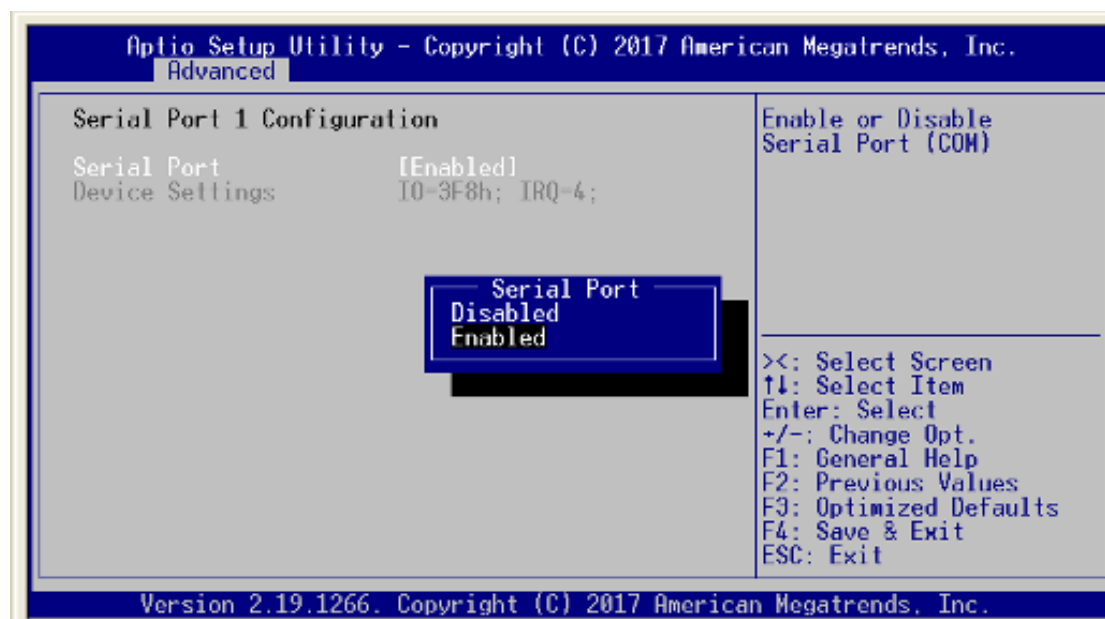
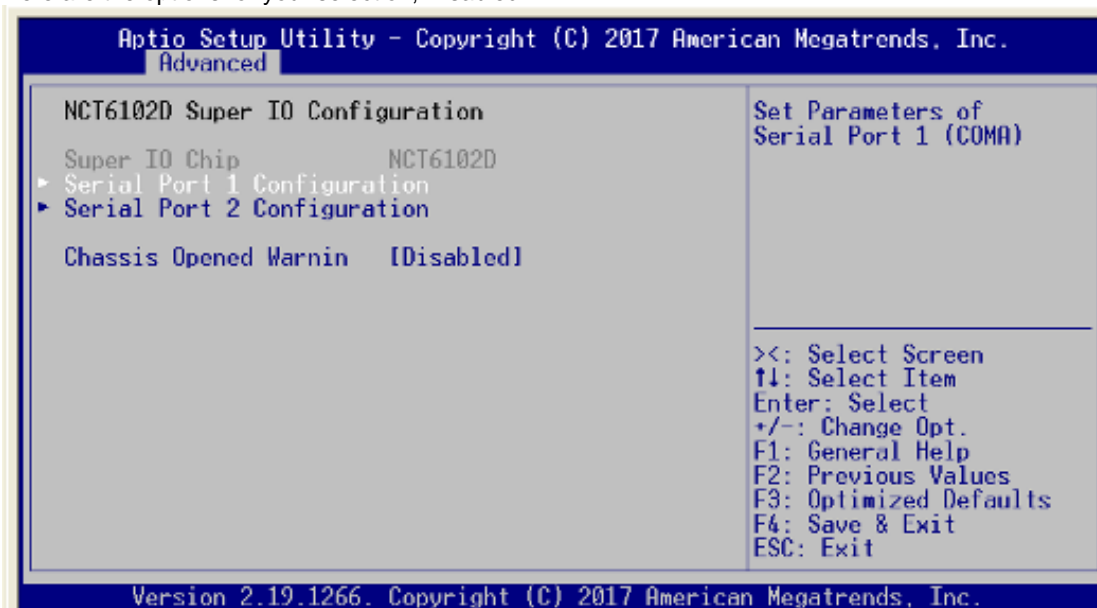

## Serial Port2 Address

This option specifies the base I/O port address and Default setting is 2F8h.

Here are the options for your selection, Disabled.

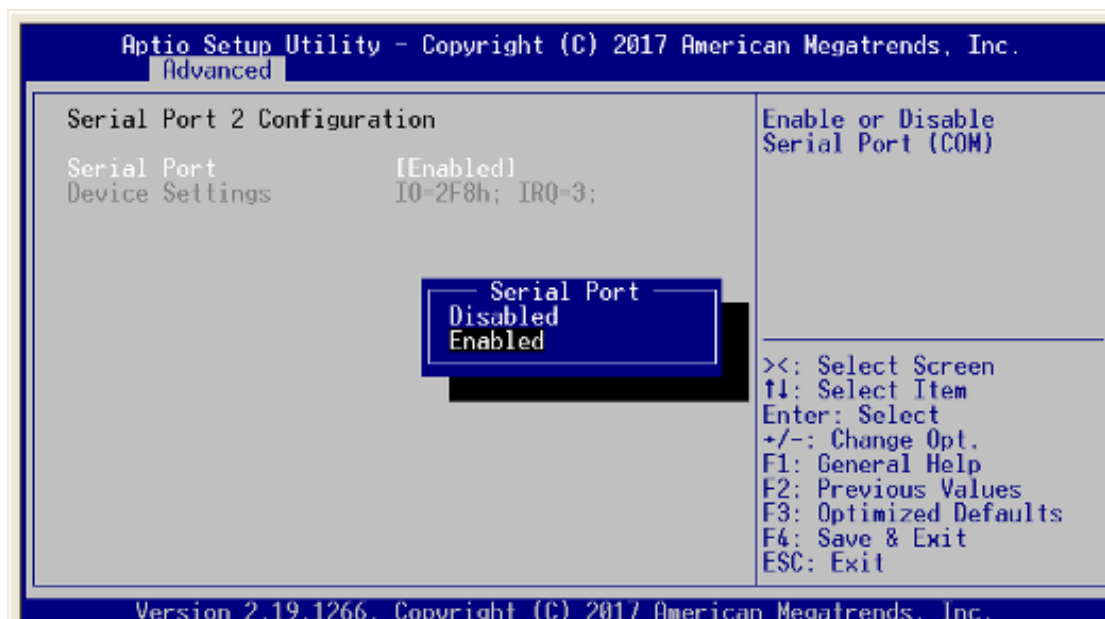
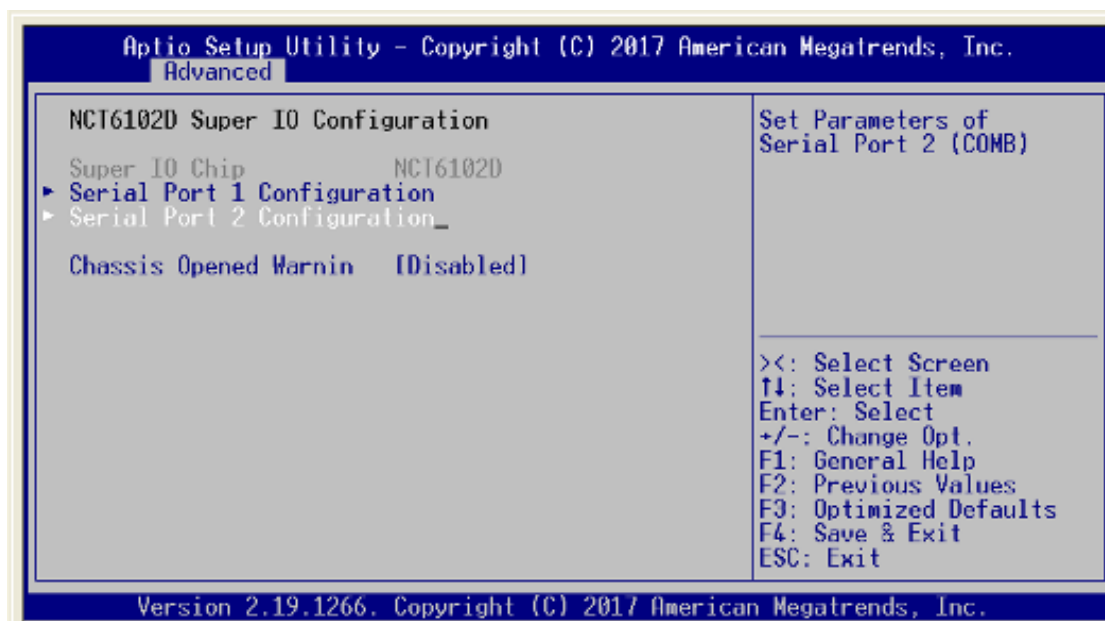

### Chassis Opened Warning

Select to enable or disable chassis intrusion detection. Chassis intrusion detection is a utility that can tell whether someone has opened the case and trigger the buzzer on board.

Remark: Pin header design has reserved for customized chassis.

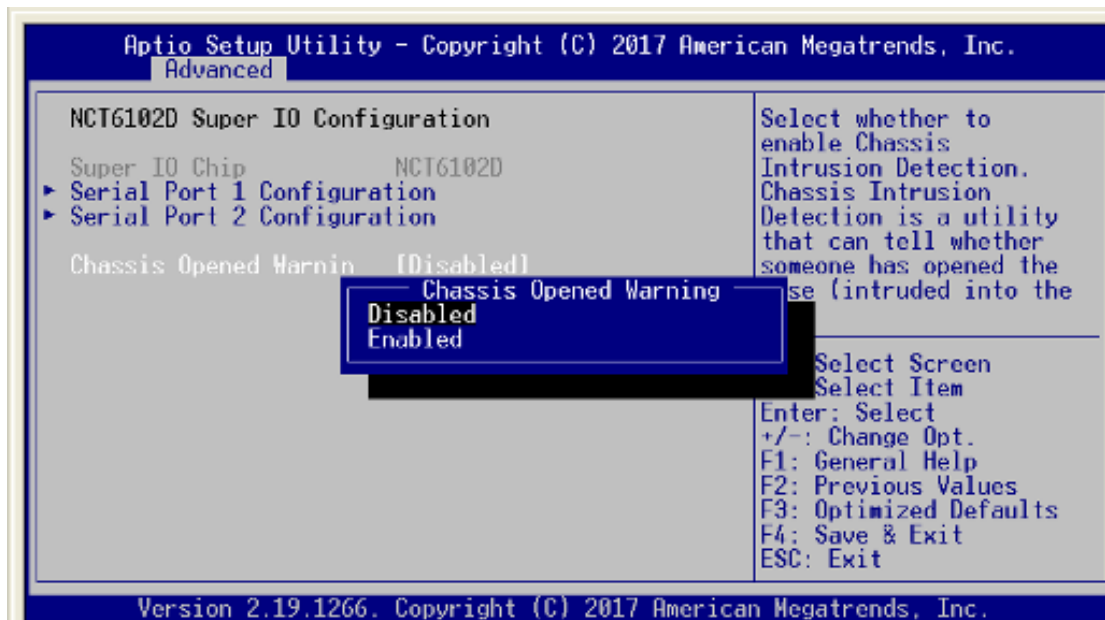

## HW Monitor

This screen shows the Hardware Health Configuration, and a description of the selected item appears on the right side of the screen.

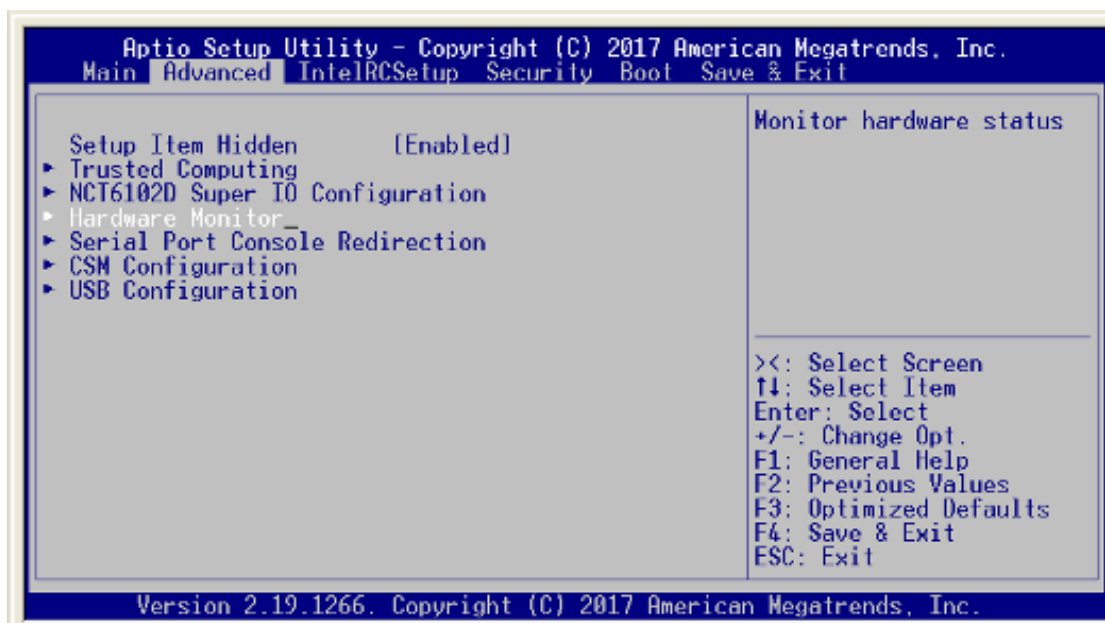

### System Temperature

Show you the current system temperature.

### CPU Temperature

These read-only fields show the functions of the hardware thermal sensor by CPU thermal diode that monitors the chip blocks to ensure a stable system.

### Fan Speed

NA362 equips 2pcs fan and it shows cooling fan speed in RPM. If the fan Speed is N/A, it means no fan available.

### Vcore 5V / 3.3V

Show you the voltage of 5V/ 3.3V and etc.

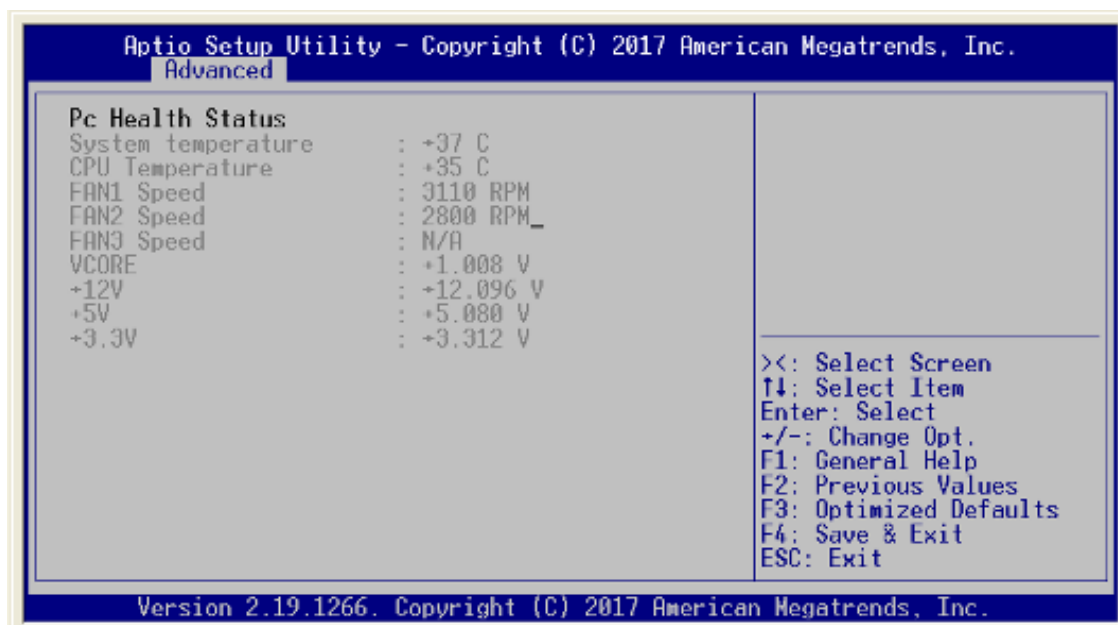

## Serial Port Console Redirection

To use the external serial port as console, it is needed to enable serial port console redirection.

### Console Redirection

Console Redirection Enable or Disable.

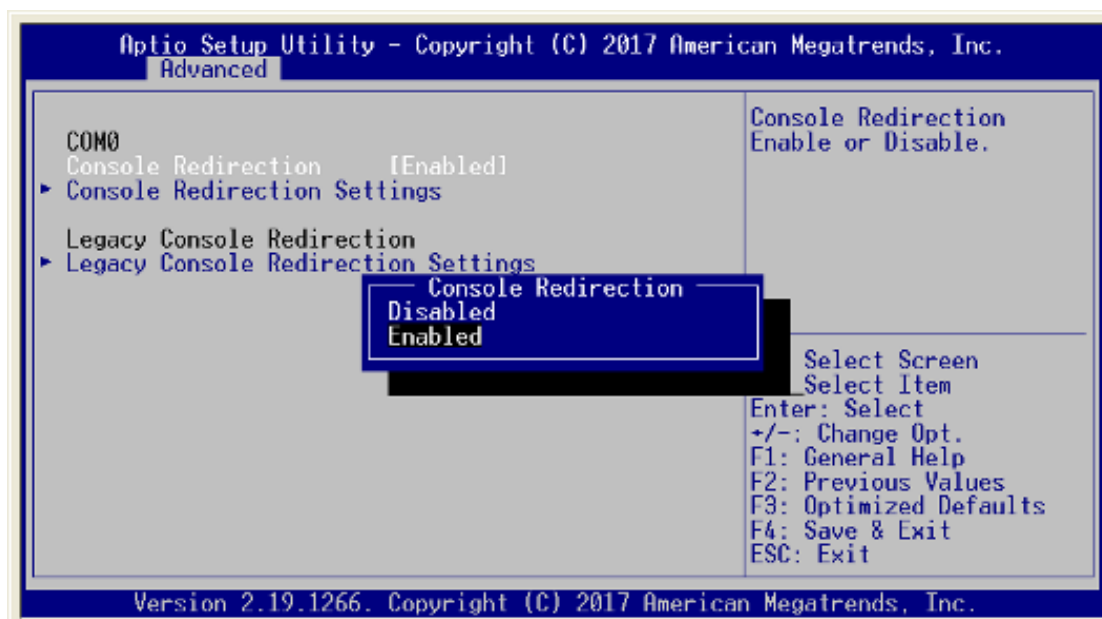
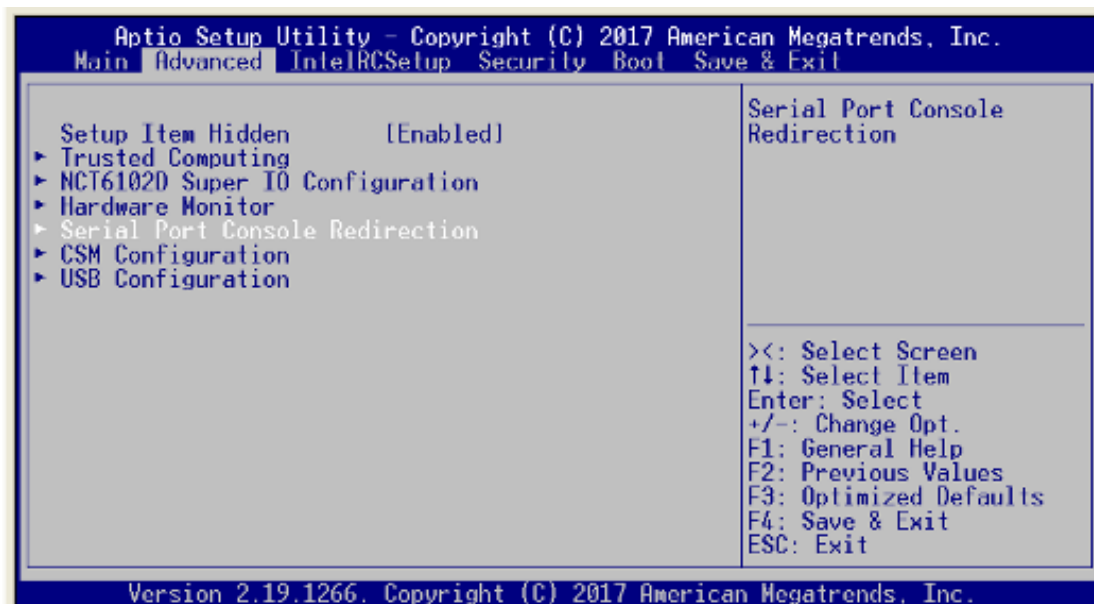



### Console Redirection Setting

This setting specifies how the host computer and the remote computer will exchange data.

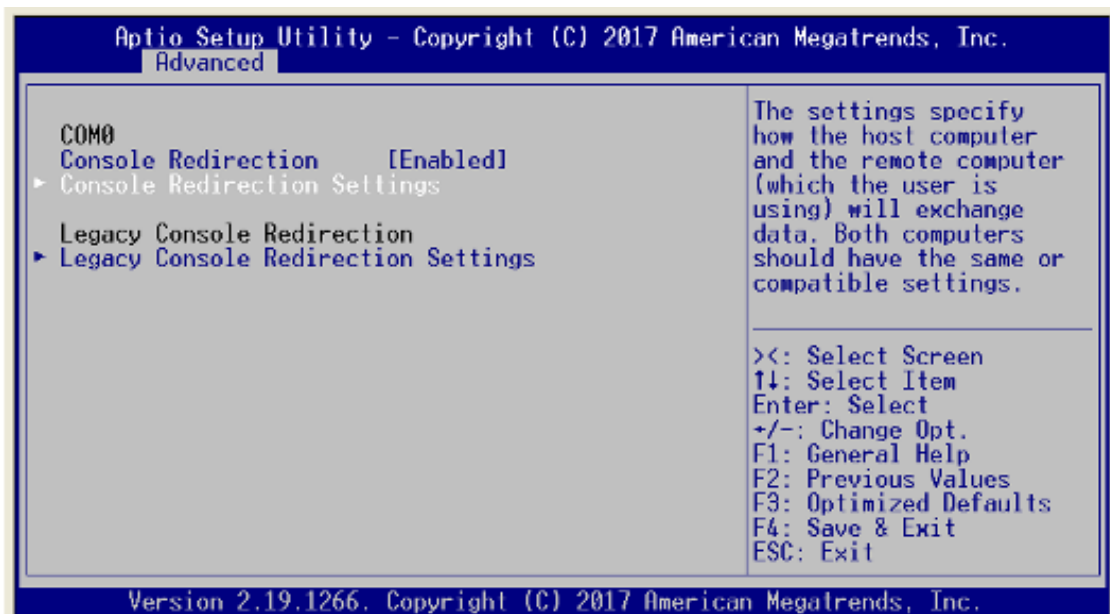

## Terminal Type

This item allows you to select the target terminal type. Configuration options: ANSI, VT100, VT100+ and VT-UTF8.

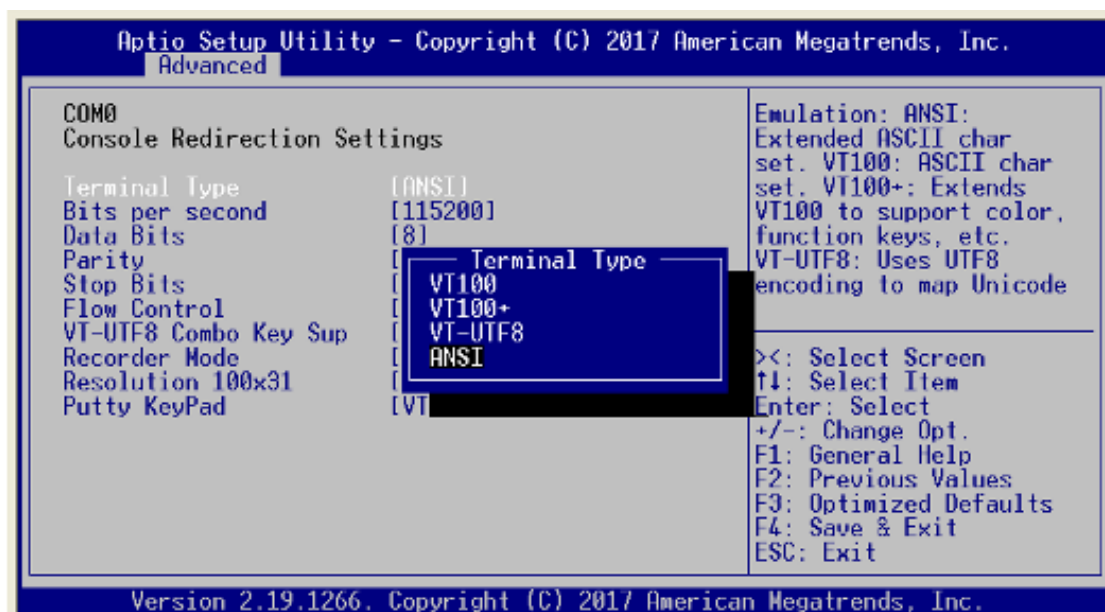

### Bits per second

This item allows you to setup the data transfer rate for the console port. The default value is 115200. Available options are "9600", "19200", "38400", "57600" and "115200".

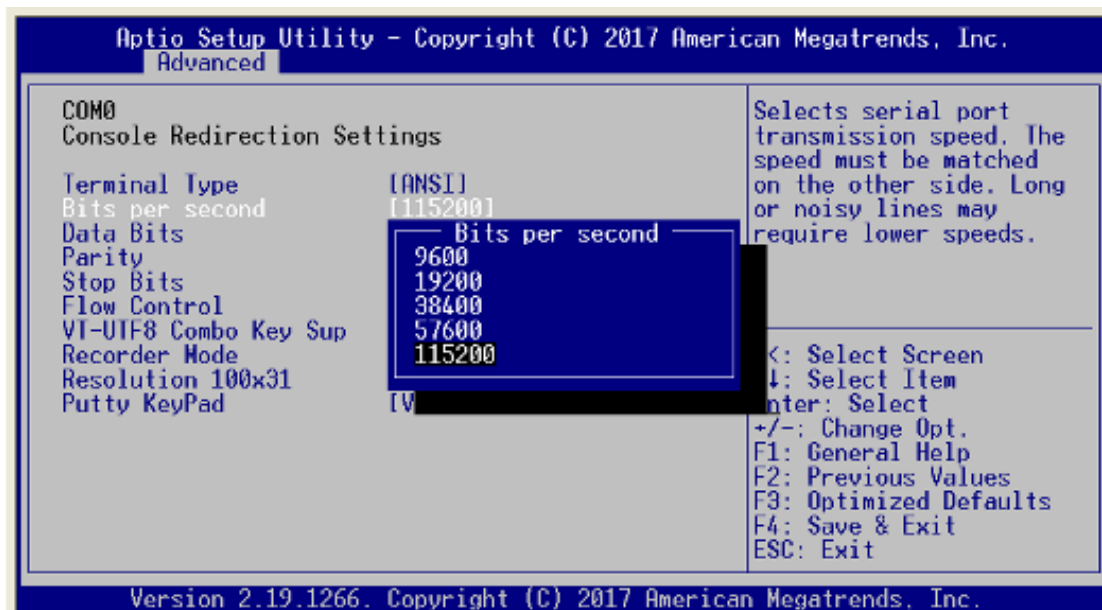

### Data Bits

This item allows you to select the data bits. The configuration options: 7 and 8.

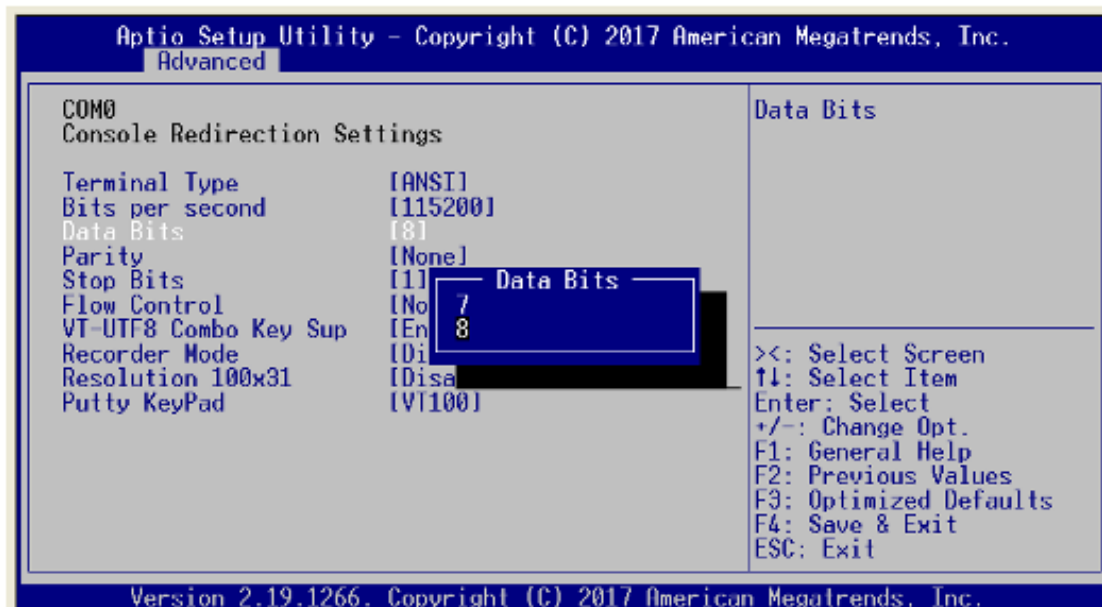

**Parity**

This item allows you to select flow control for console redirection. The configuration options: None, Even, Odd, Mark and Space.

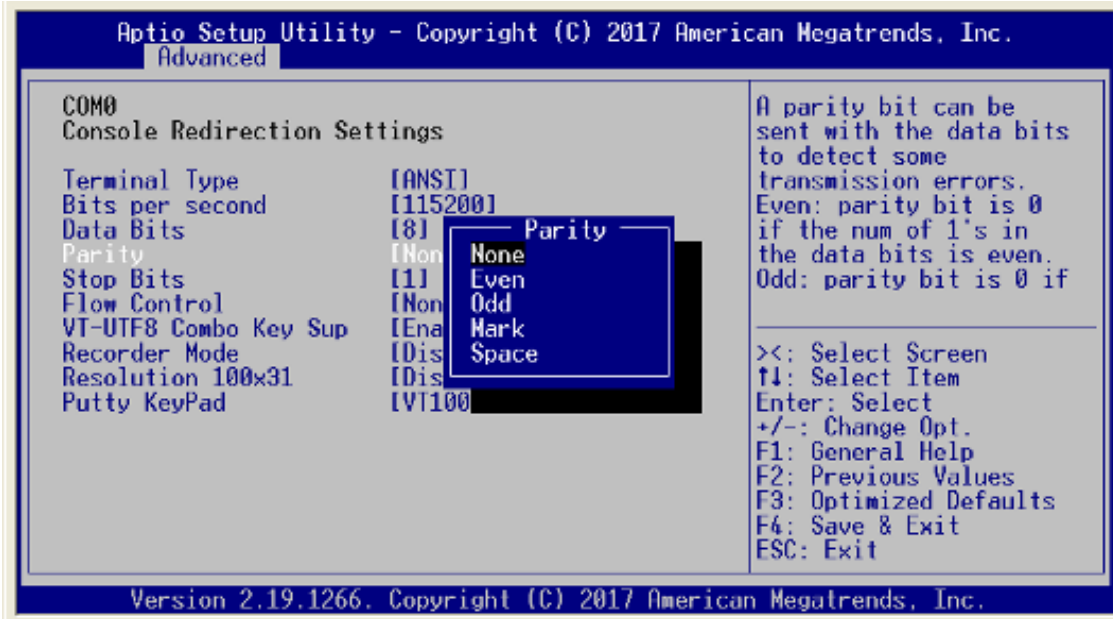

**Stop Bits**

This item allows you to select the data bits. The configuration options: 1 and 2.

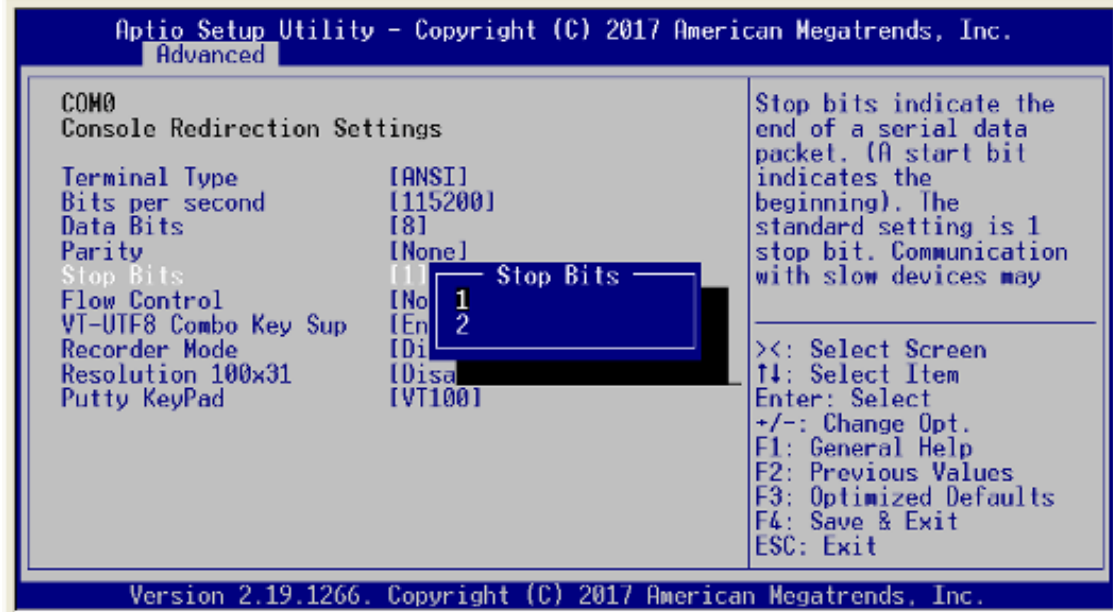

## Flow Control

This item allows you to select flow control for console redirection. The configuration options: None, Hardware and Software.

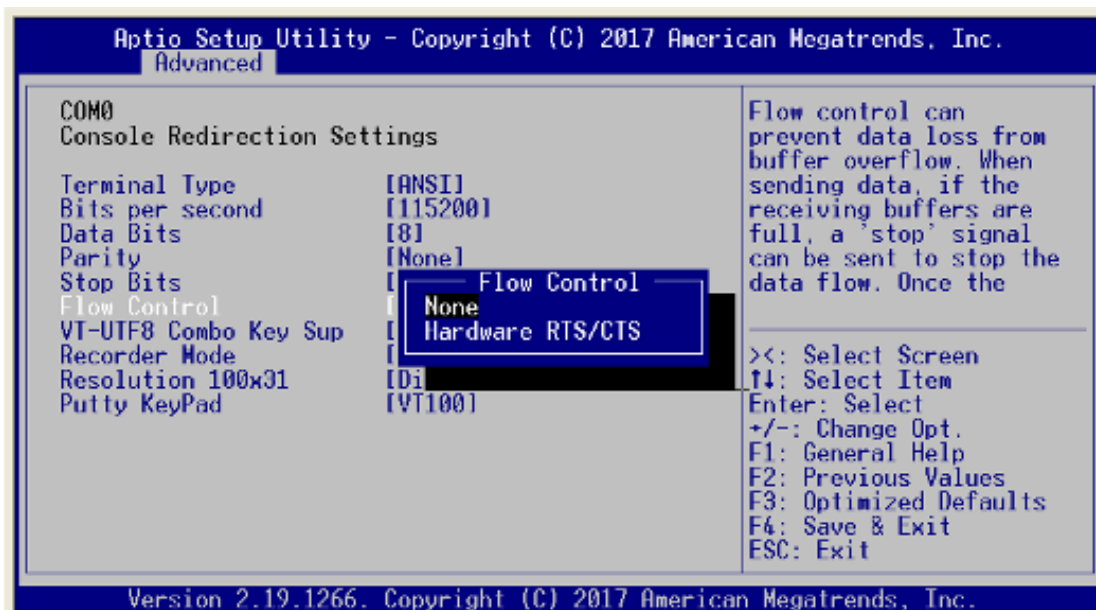

## VT-UTF8 Combo Key Support

Use this item to "Enabled" or "Disabled" VT-UTF8 combination key supports for ANSI / VT100 terminals.

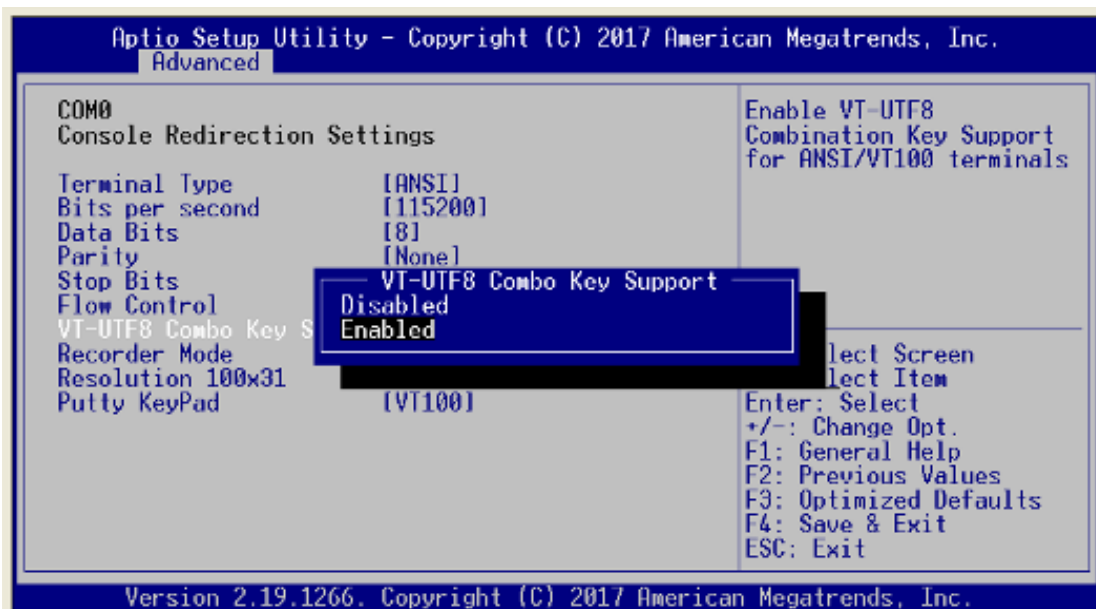

## Recorder Mode

This item allows you to select the recorder mode. The configuration options: Enabled and Disabled.

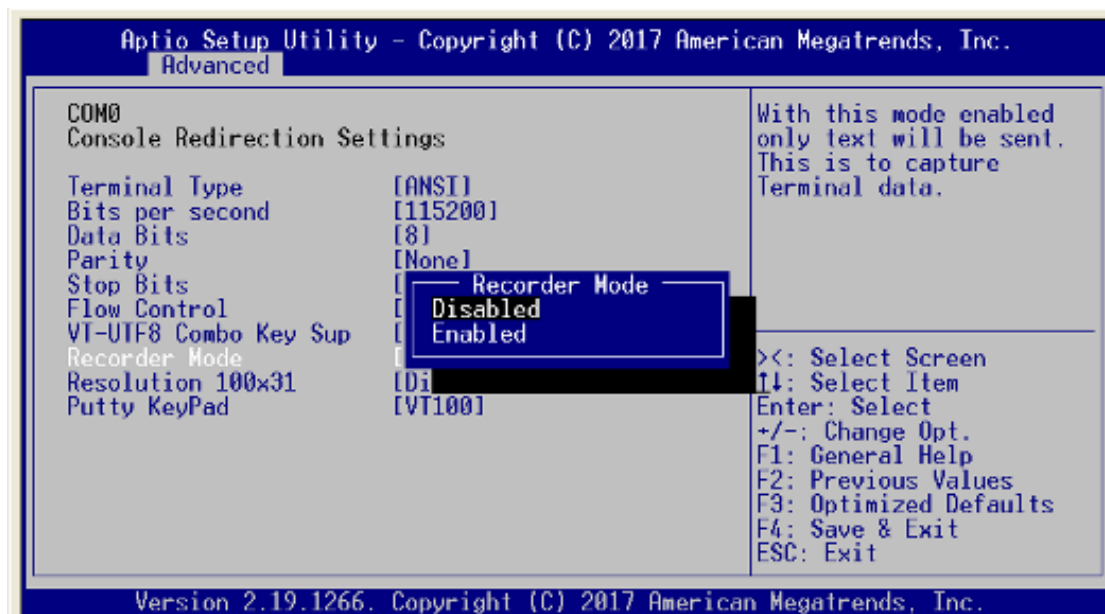

## Resolution

Enable or disable extended terminal resolution.

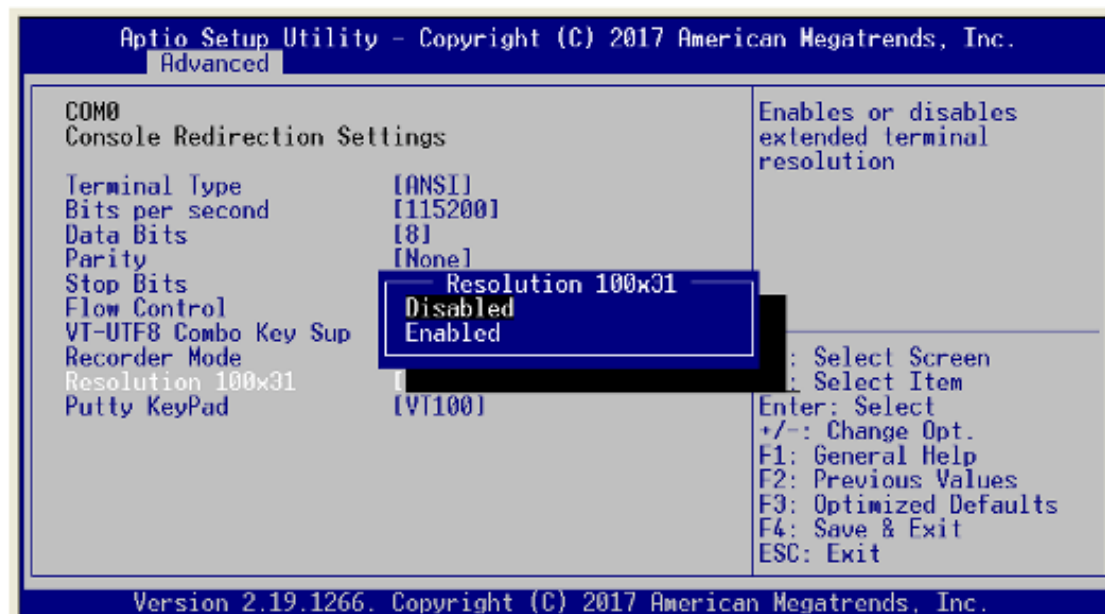

## Putty Keypad

This item allows you to select the putty keypad. The configuration options: VT100, LINUX, XTERMR6, SCO, ESCN and VT400.

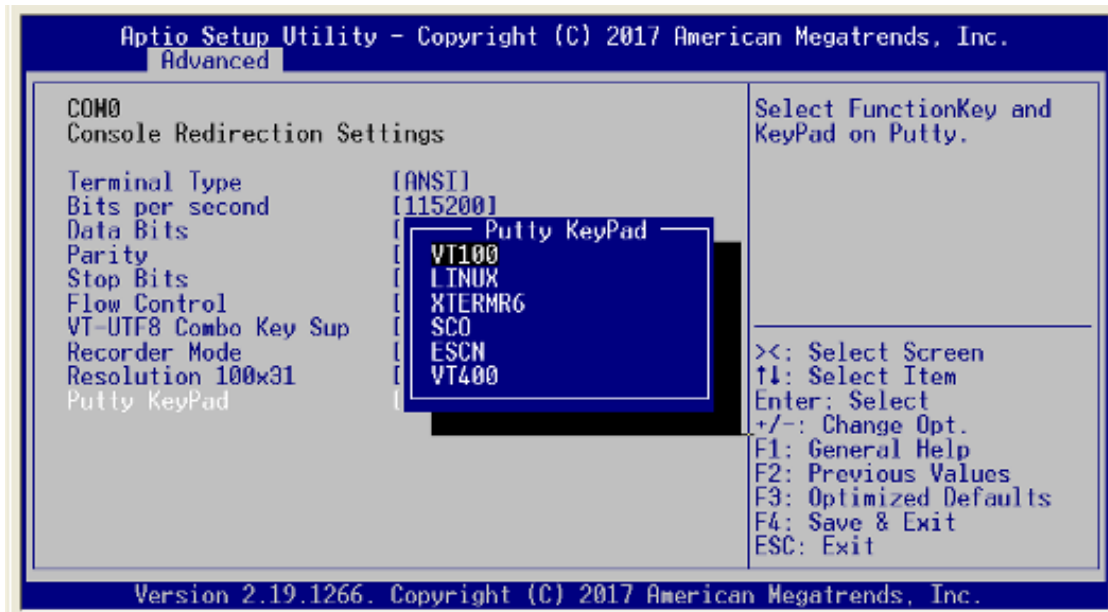

## Legacy Console Redirection Settings

This item allows you to configure the legacy console redirection.

### Redirection After BIOS POST

Use this item to enable or disable the function of Console Redirection, which allows you maintain a system from a remote location. The default setting is *Always*.

 **NOTE:** *POST, Power-on self –test is a process to check CPU, memory and mother board after system is powered on.*

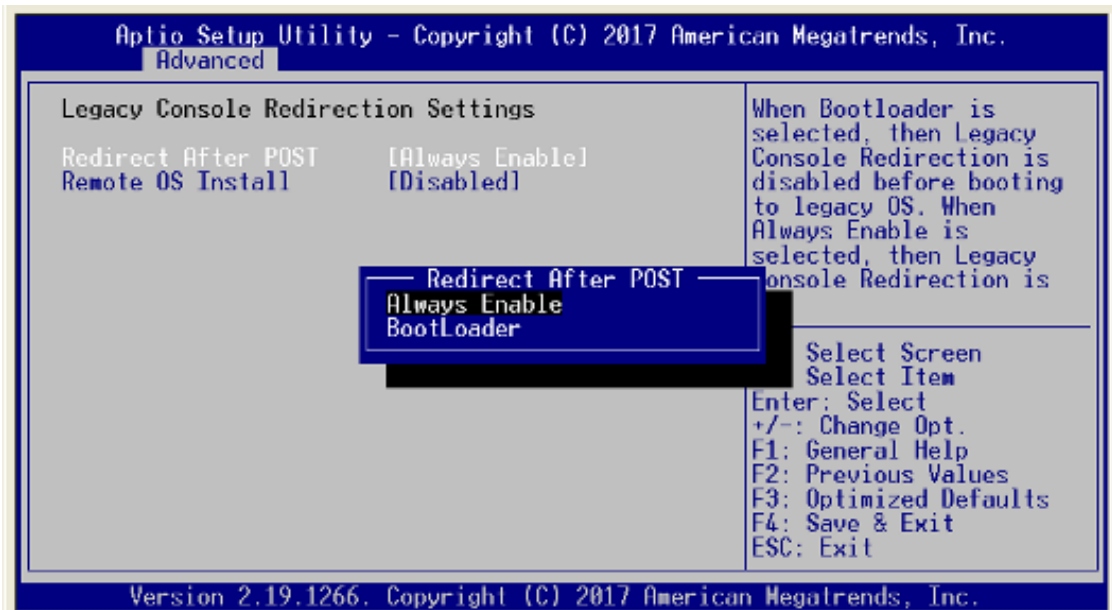
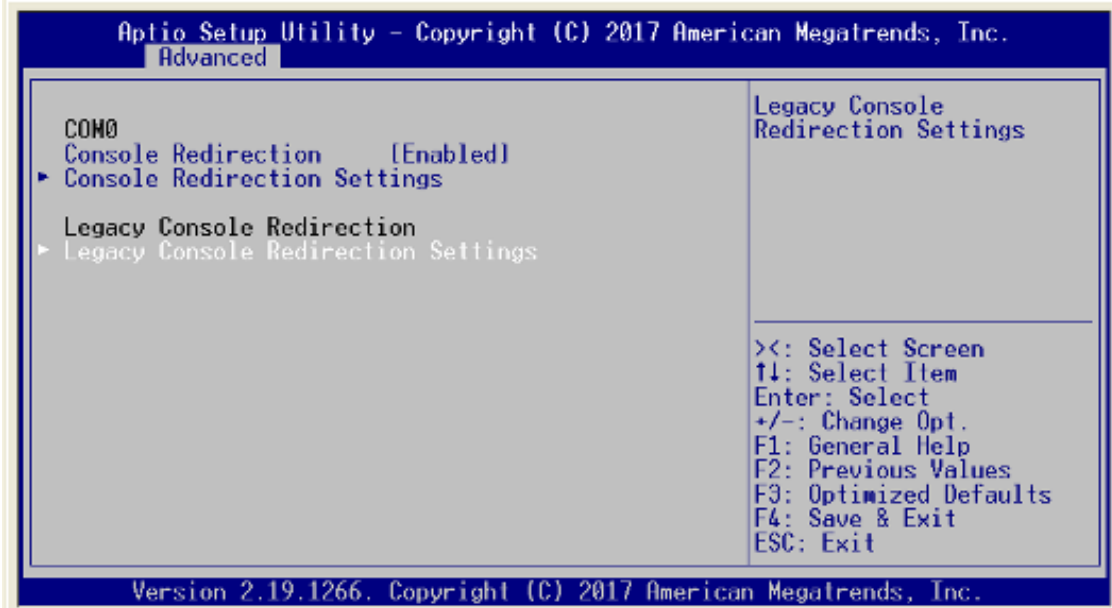



## Remote OS Install

This item allows you to select the install legacy OS through remote. The configuration options: "Enabled" or "Disabled".

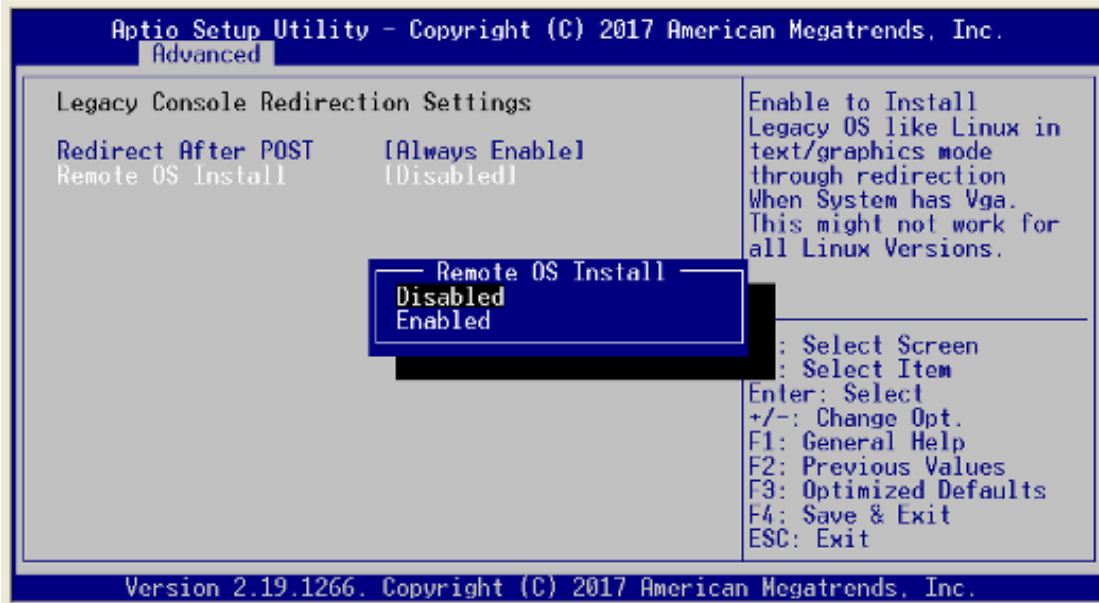

### CSM Configuration (Compatibility Support Module)

Use CSM configuration to enable/disable, Option ROM execution setting for LAN by pass function.

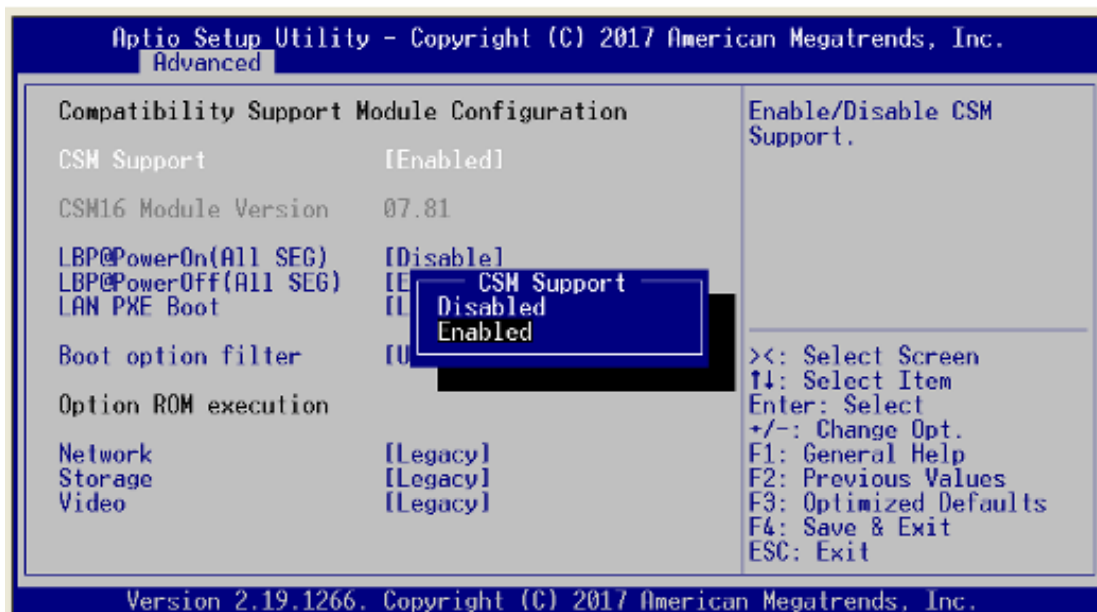
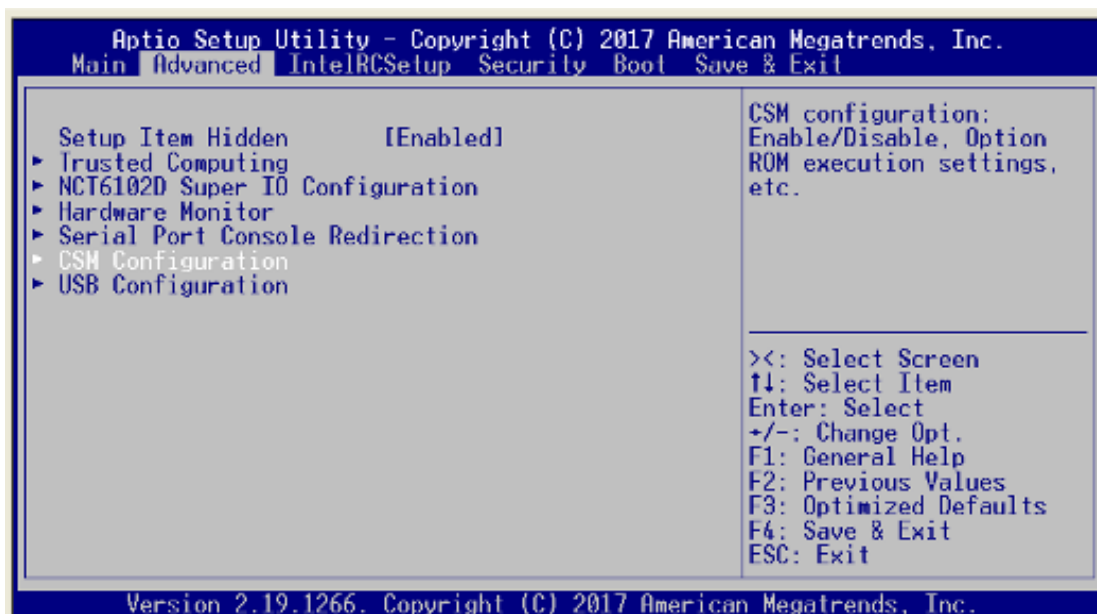

### Lanbypass Mode Configuration

#### LAN bypass Mode @power On

Use this item to select lanbypass to “disabled” or “enabled” or keep “Last State.”

#### Lanbypass Mode @power OFF

Use this item to select lanbypass to “disabled” or “enabled” or keep “last state.”

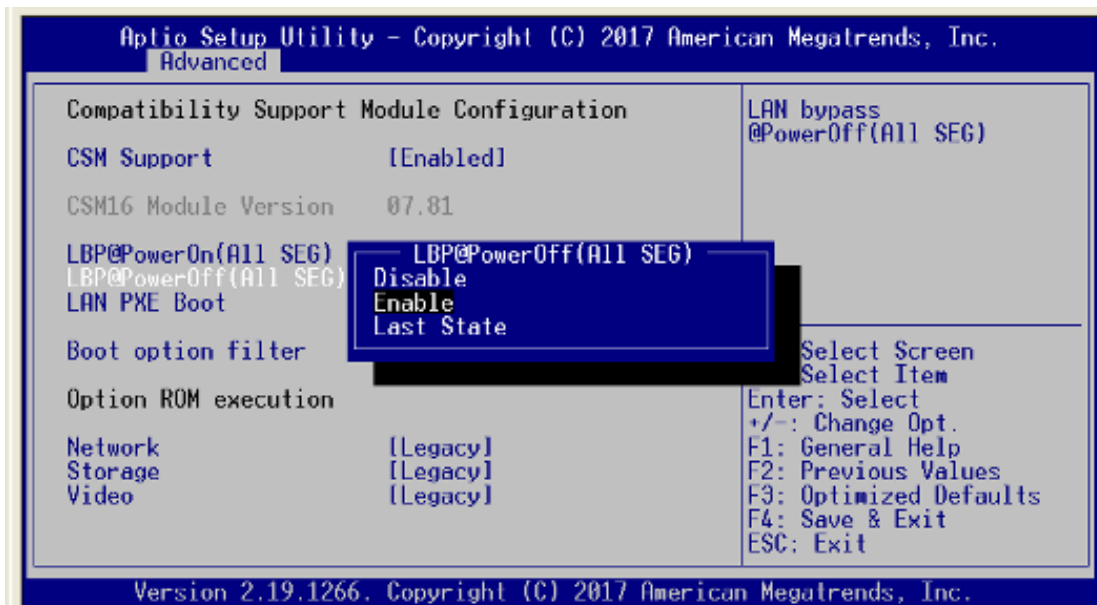
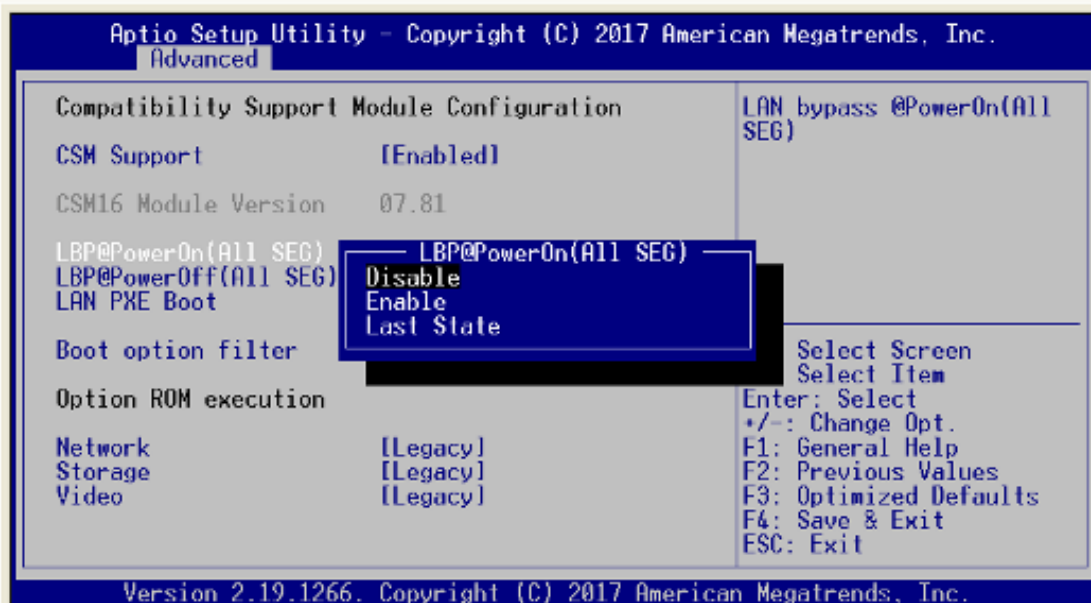

## LAN PXE Boot

This item can enable or disable boot option for legacy mass storage devices with option ROM.

In LAN PXE Boot control menu and select LAN port from LAN1~LAN6 for PXE ROM Boot to server or Disables it.

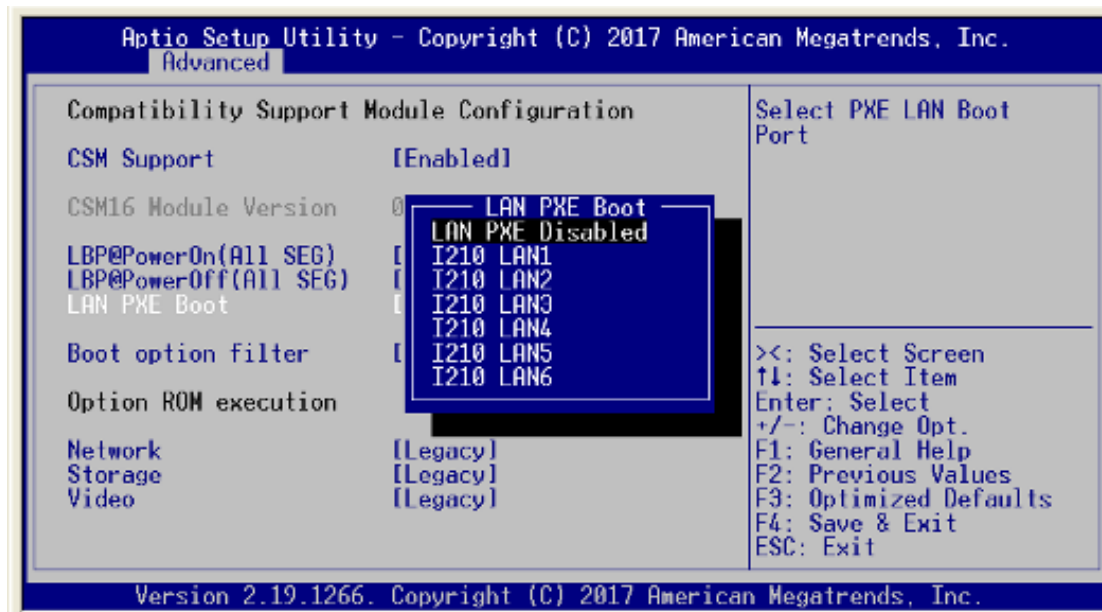

### Boot option filter

This option controls legacy/UEFI ROMs priority. Selects boot option from Boot option filter menu.

**NOTE:** UEFI is Unified Extensible Firmware Interface. It replaces the BIOS firmware interface originally present in legacy BIOS.

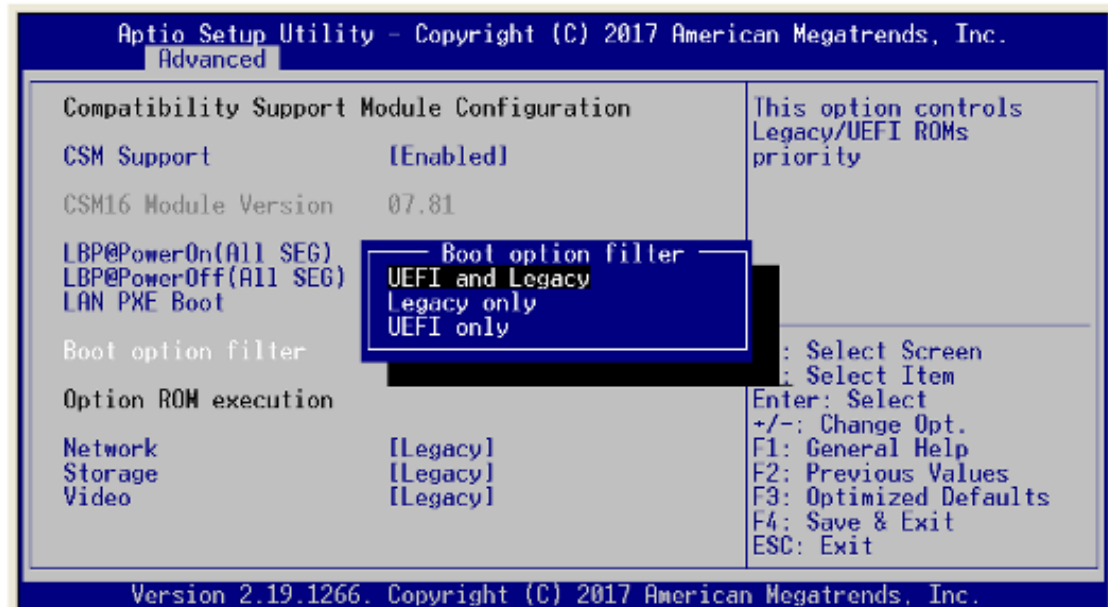
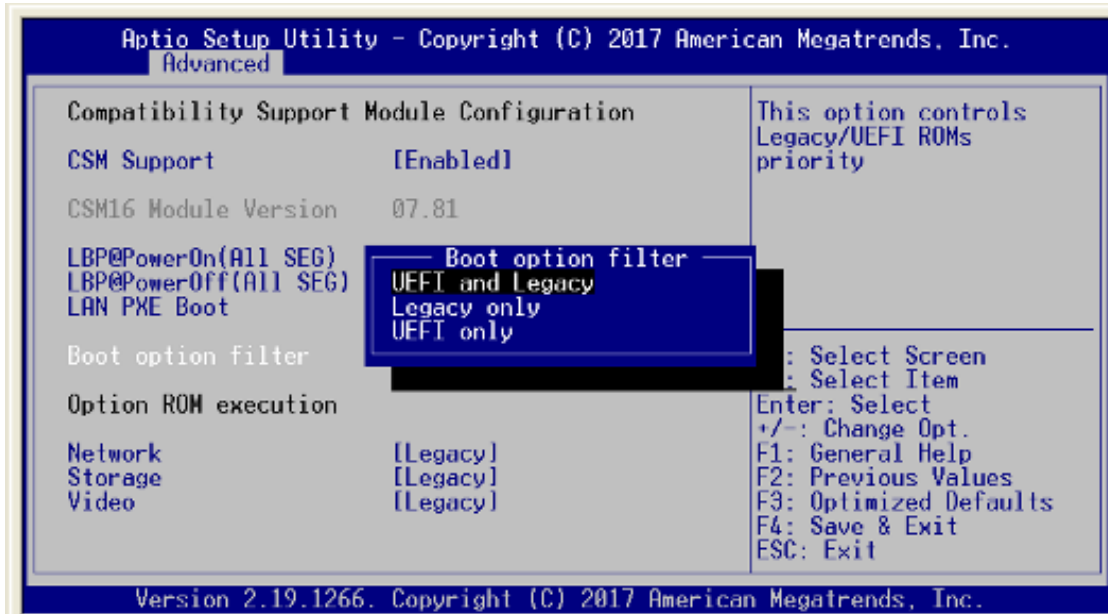

**Option ROM execution**

Controls the execution of UEFI and Legacy storage OpROM.

**NOTE:** *OpROM: Option ROM, it consists of firmware that is called by system BIOS. OpROM may be from network (PXE ROM or UEFI UNDI driver...etc.), storage (Raid ROM...etc.) or Video (vbios or GOP driver...etc.)*

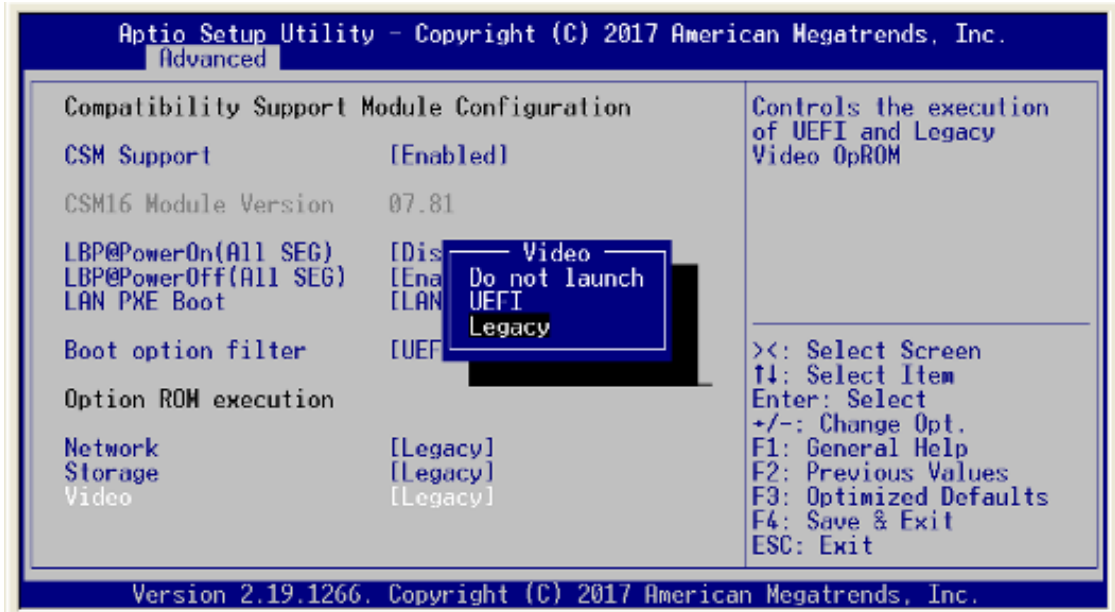
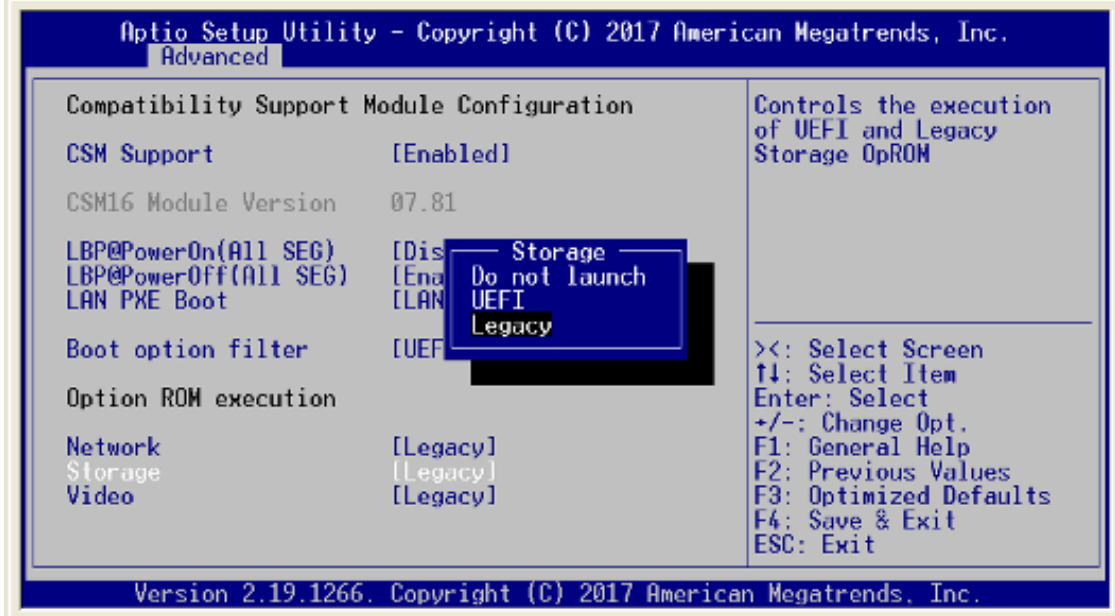

## USB Configuration

Select this item to set up USB related parameter.

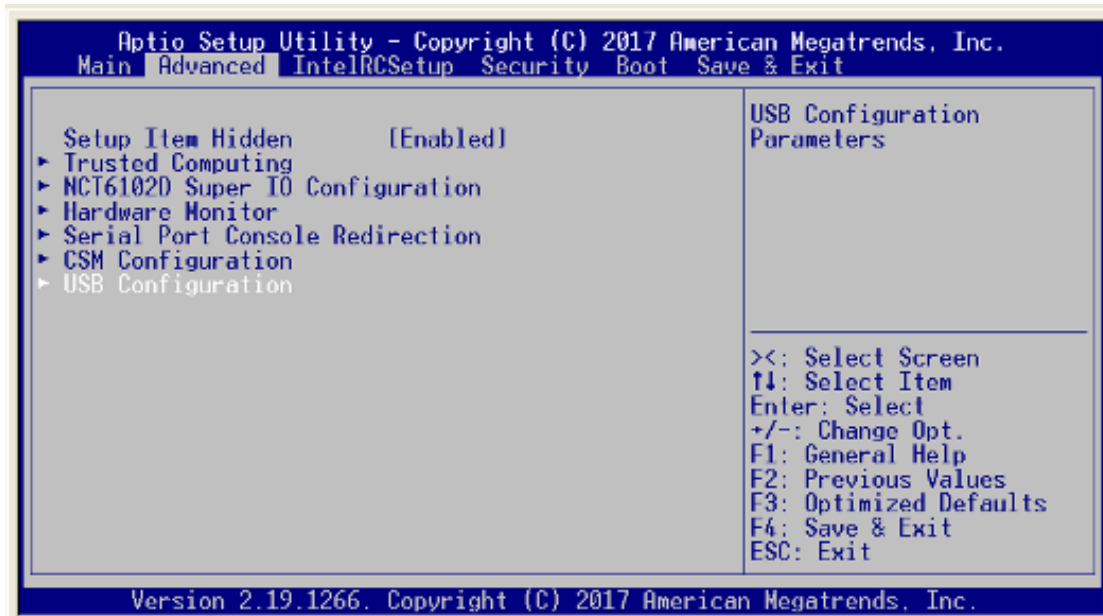

## Legacy USB support

Enables legacy USB support (like USB, KB/MS); Auto option disables legacy support if no USB device are connected; Disable option will keep USB device available only for EFI applications.

 **NOTE:** *EFI (Extensible Firmware Interface) OS: Win 10 x64; EFI Shell: MS DOS for example*

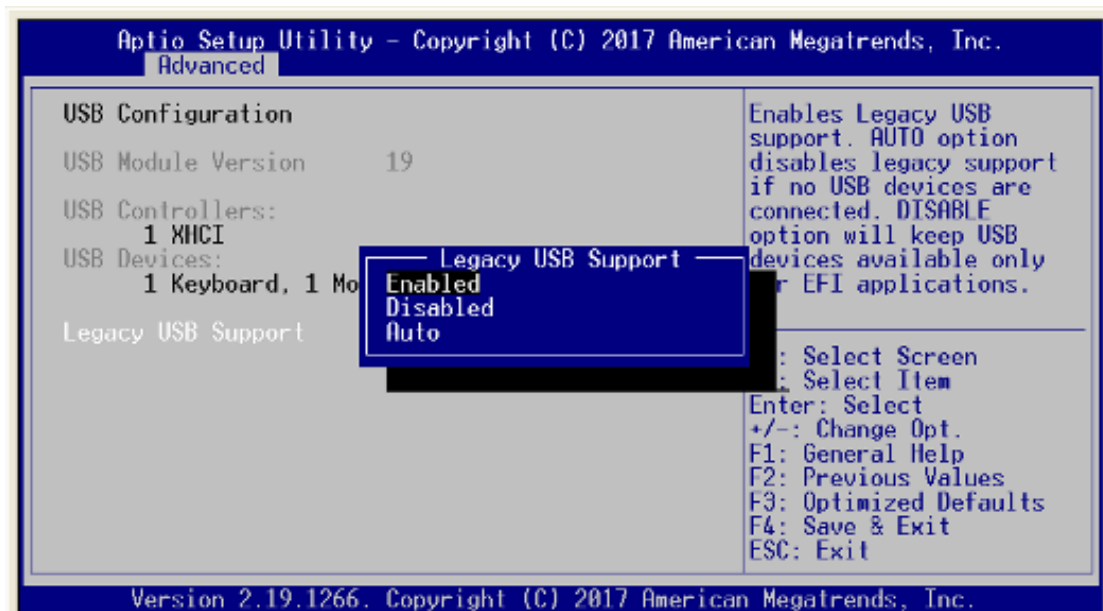

### 3.5 IntelRCSetup

#### Processor Configuration

Displays processor information and provides option to change the processor setting.

Enable or disable EIST (GV3). TM1 must be enabled for TM2 to be available. GV3 must be enabled for Turbo.

 **NOTE:** *EIST, Enhanced Intel SpeedStep Technology. It is used to automatically adjust CPU core frequency according to the real loading to reduce power consumption.*

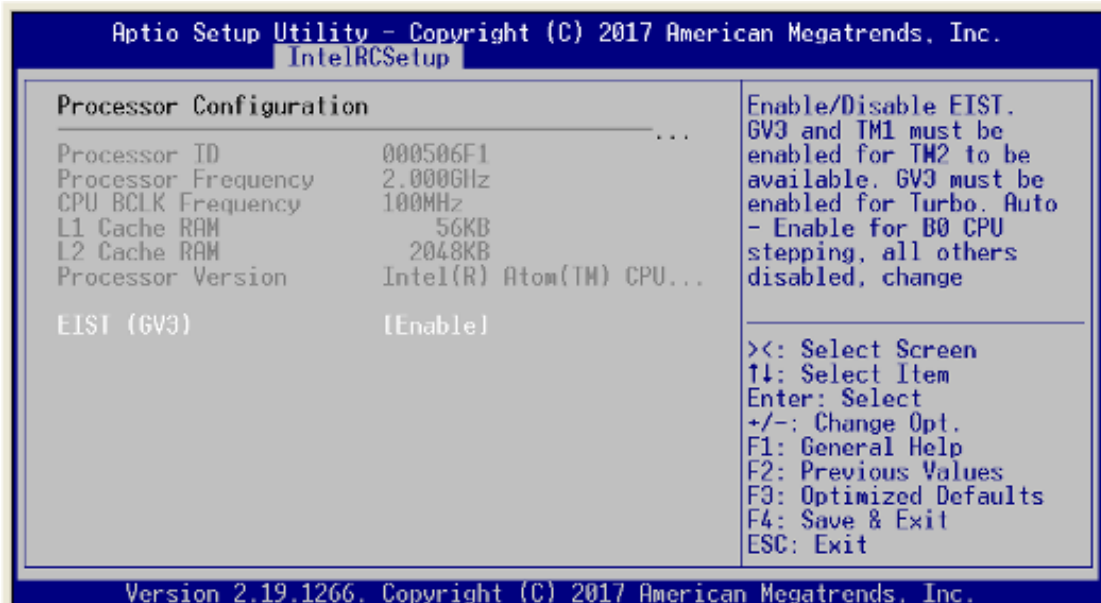
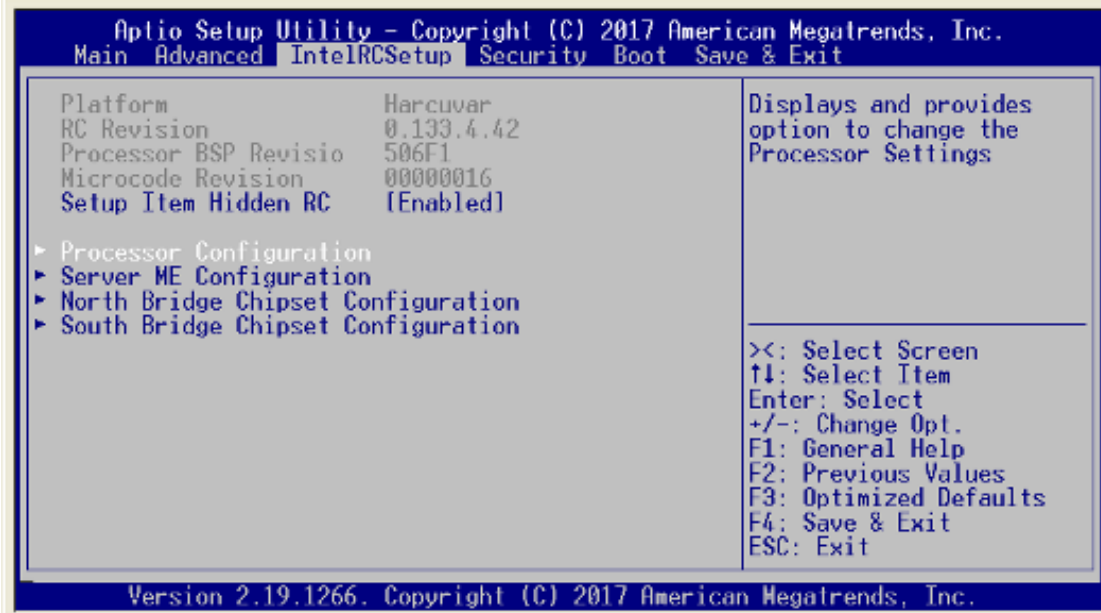



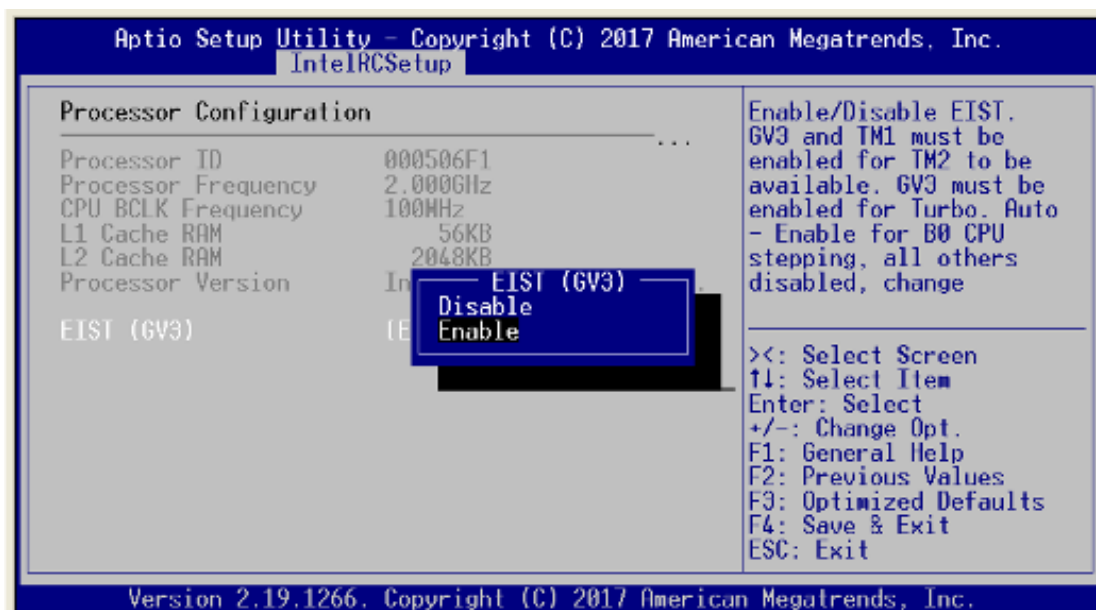

## Server ME Configuration

Configure Server ME Technology parameters. Here show the general ME configuration information.

 **NOTE:** ME, Management Engine. It is Intel's technology used for remote out-of-band management.

```

Aprio Setup Utility - Copyright (C) 2017 American Megatrends, Inc.
Main Advanced IntelRCSetup Security Boot Save & Exit

Platform          Harcuvar
RC Revision       0.133.4.42
Processor BSP Revisio 506F1
Microcode Revision 00000016
Setup Item Hidden RC [Enabled]

Configure Server ME
Technology Parameters

▶ Processor Configuration
▶ Server ME Configuration
▶ North Bridge Chipset Configuration
▶ South Bridge Chipset Configuration

><: Select Screen
↑↓: Select Item
Enter: Select
+/-: Change Opt.
F1: General Help
F2: Previous Values
F3: Optimized Defaults
F4: Save & Exit
ESC: Exit

Version 2.19.1266. Copyright (C) 2017 American Megatrends, Inc.
    
```

```

Aprio Setup Utility - Copyright (C) 2017 American Megatrends, Inc.
IntelRCSetup

General ME Configuration
Operational Firmware 0B:4.0.3.68
ME Firmware Type     SPS
Backup Firmware Versi N/A
Recovery Firmware Ver 0B:4.0.3.68
ME Firmware Features SiEn
ME Firmware Status #1 0x000F0355
ME Firmware Status #2 0x8811A000
Current State        Operational
Error Code           No Error

><: Select Screen
↑↓: Select Item
Enter: Select
+/-: Change Opt.
F1: General Help
F2: Previous Values
F3: Optimized Defaults
F4: Save & Exit
ESC: Exit

Version 2.19.1266. Copyright (C) 2017 American Megatrends, Inc.
    
```

### North Bridge Chipset Configuration

North Bridge handles high speed interface. For example: RAM and PCIe. Show or configure related information/parameters in this item.

### SSA Configuration

Enable or disable VT-d function.

 **NOTE:** VT-d, stands for "Intel Virtualization Technology for Directed I/O. VT-d is for isolating and restricting device accesses to the owner of the partition managing the device.

 **NOTE:** SSA, System Agent. Intel's naming for North Bridge.

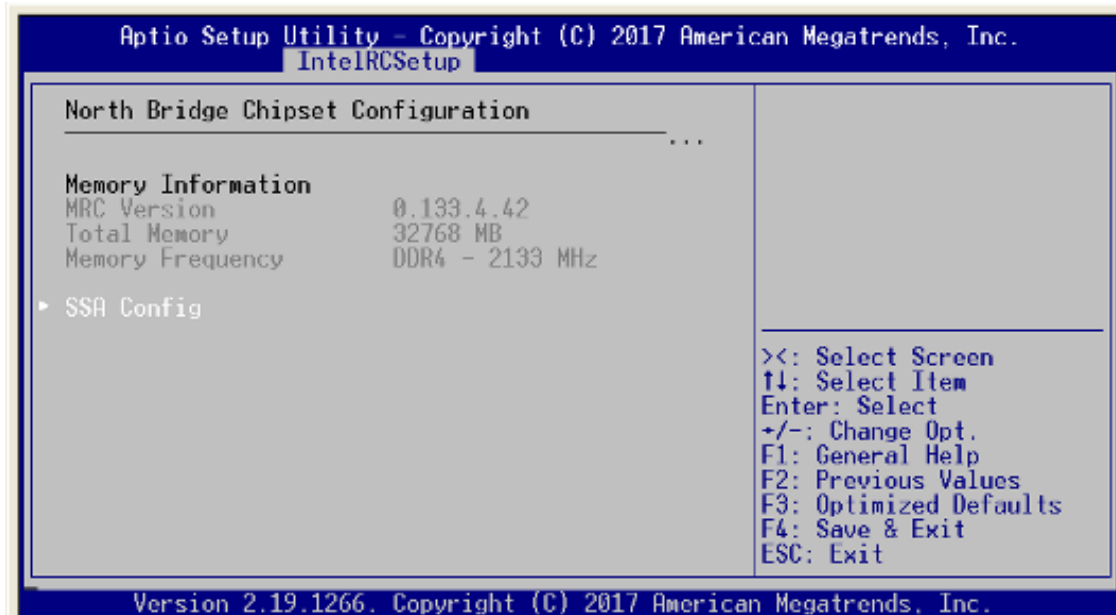
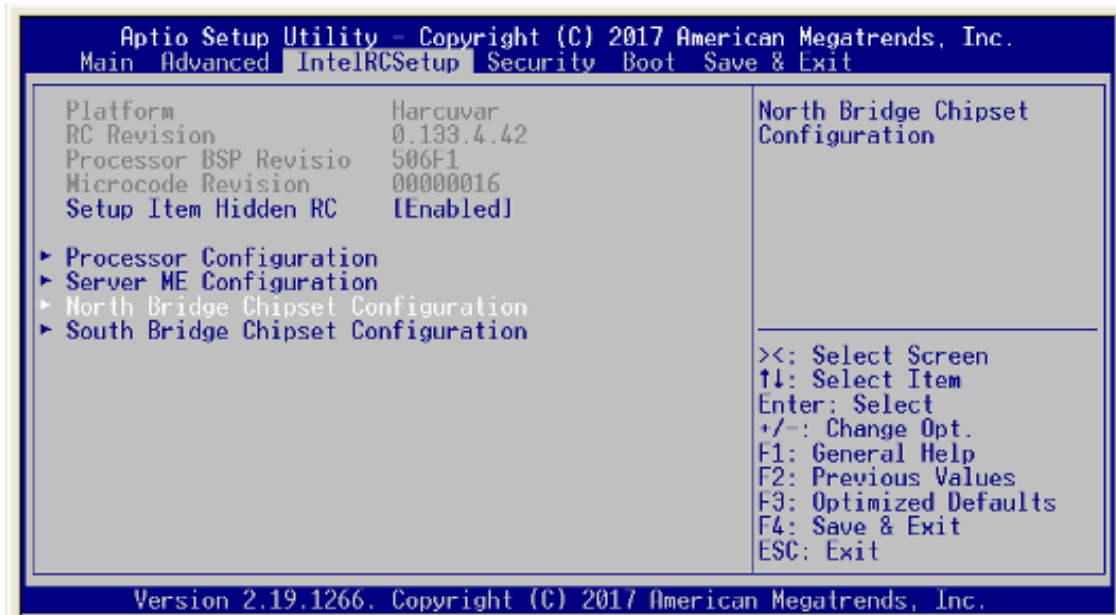

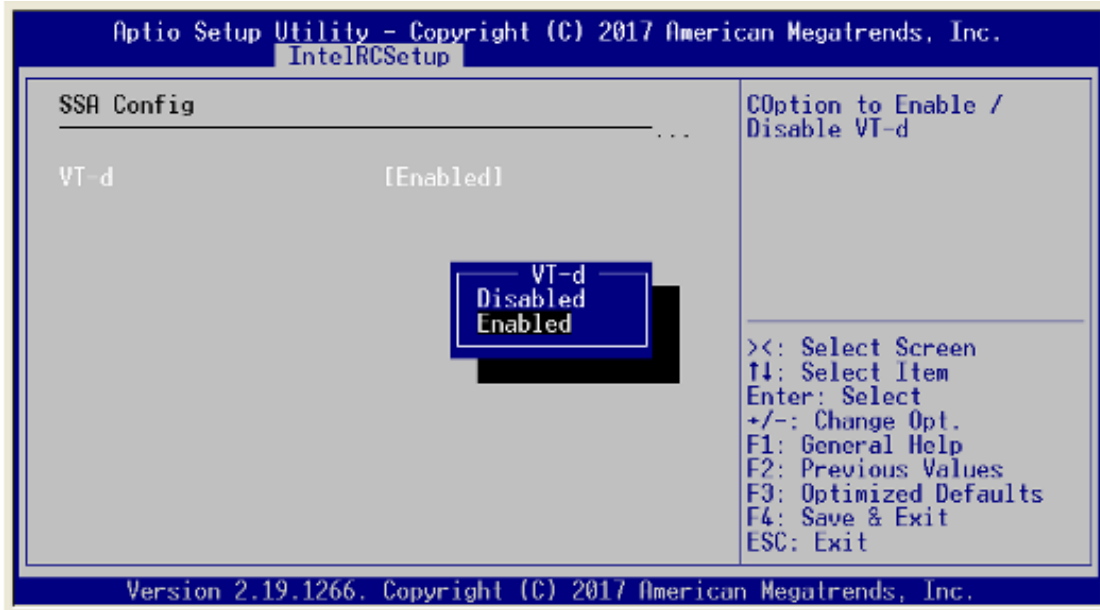

### South Bridge Chipset Configuration

South Bridge handles slow speed I/O interface. Configure related parameters in this item.

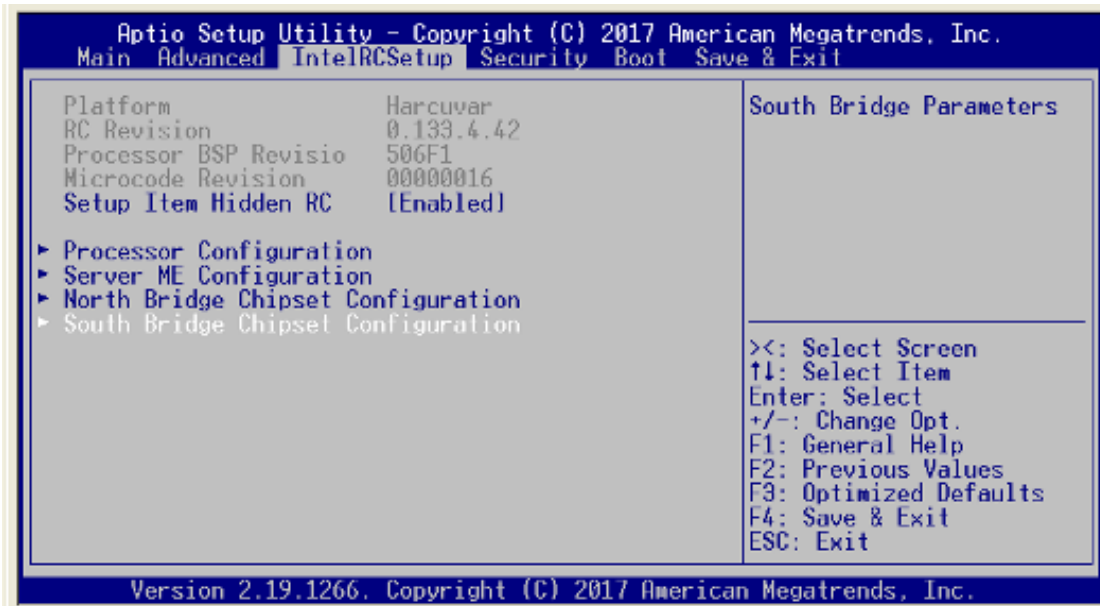

## SATA Configuration

There are options for South Bridge SATA configuration.

### Enable SATA Controller

Enable or disable SATA controller if supported by current CPU SKU. There are SATA and mSATA devices list. Select one to show information of SATA device. Enable or disable SATA device.

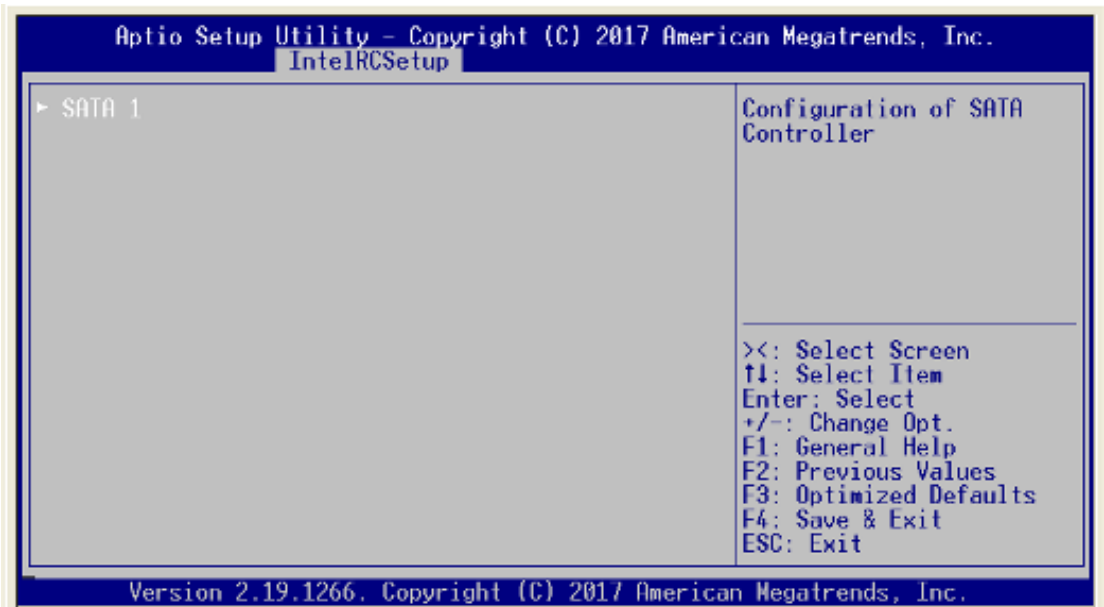
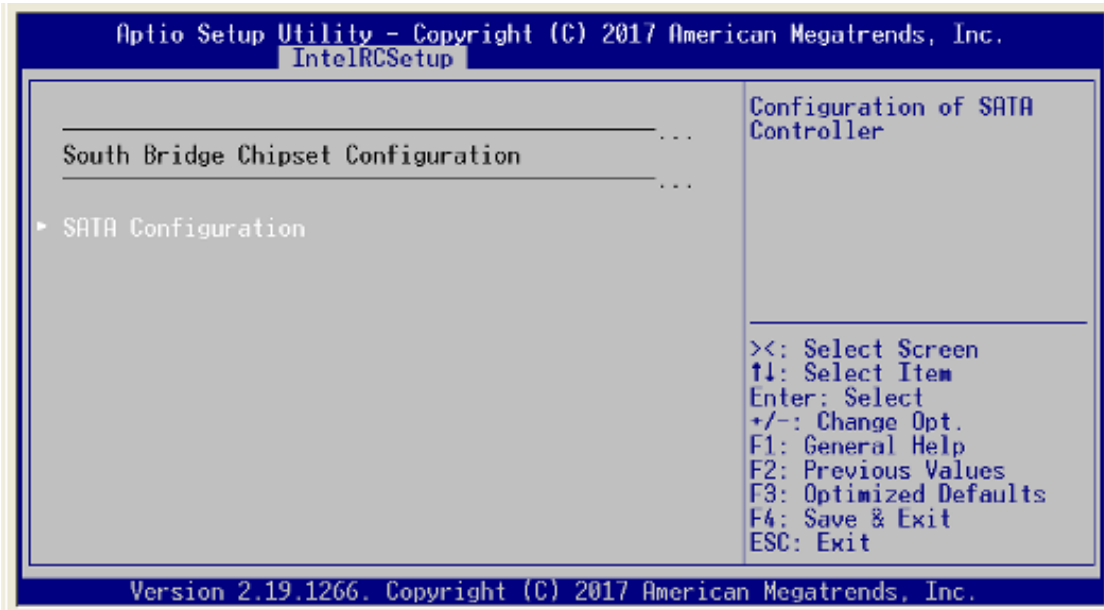

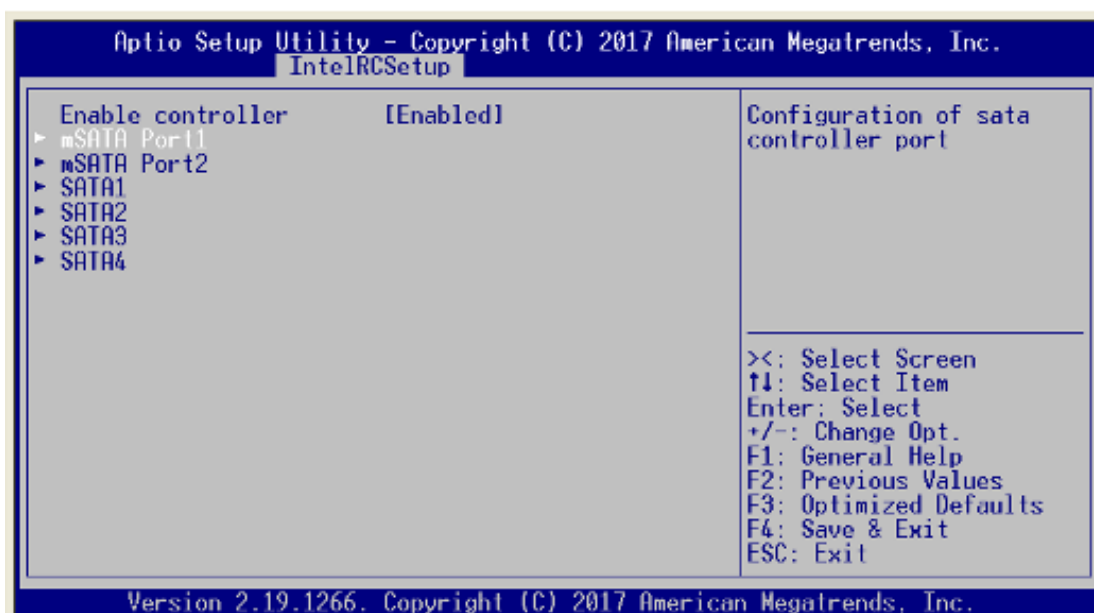
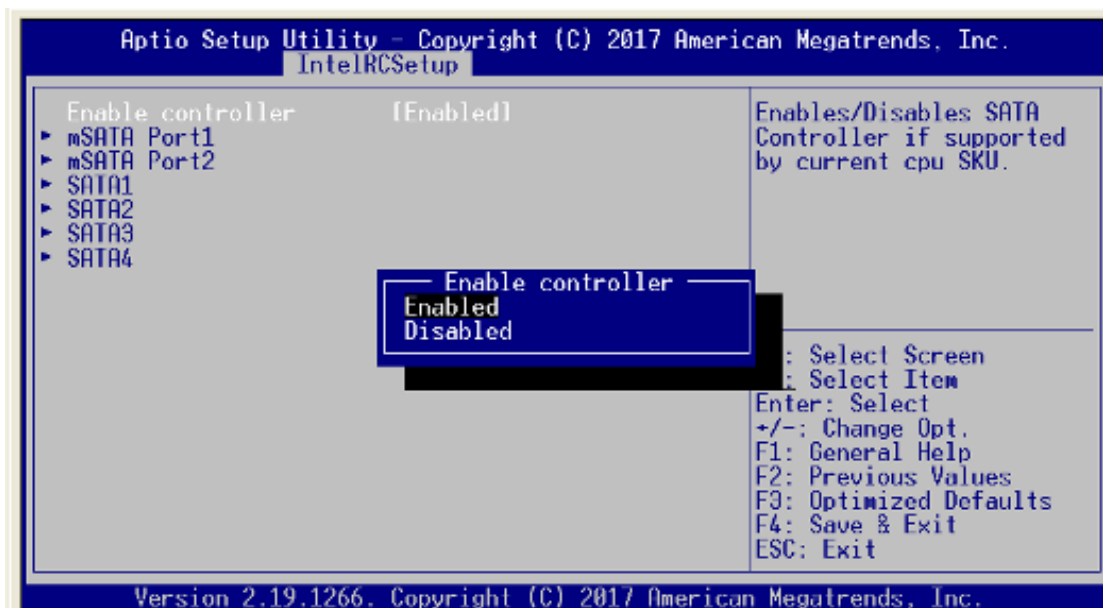

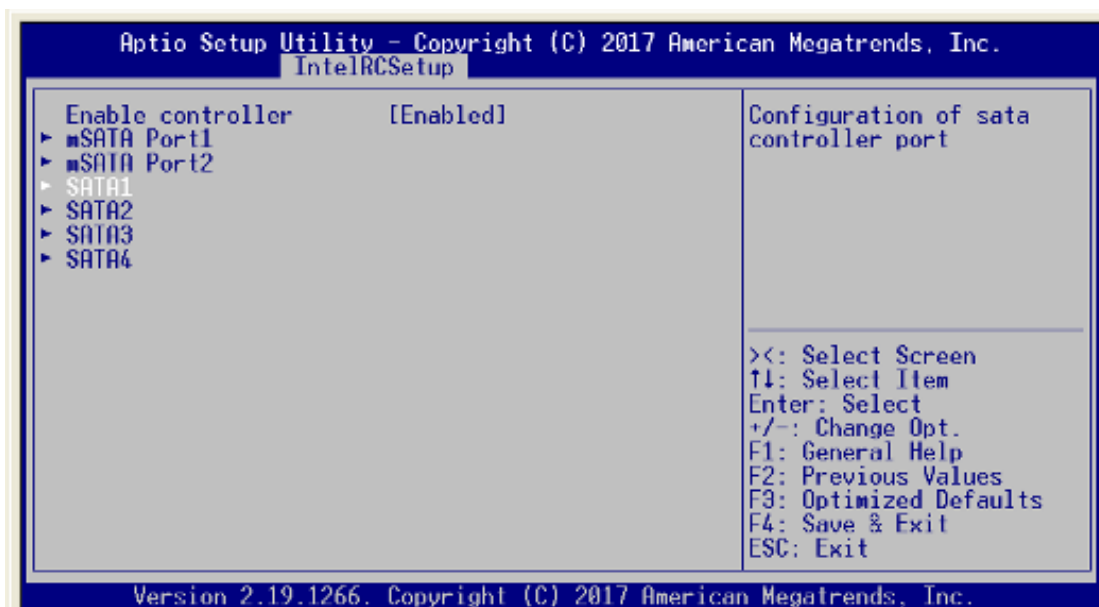
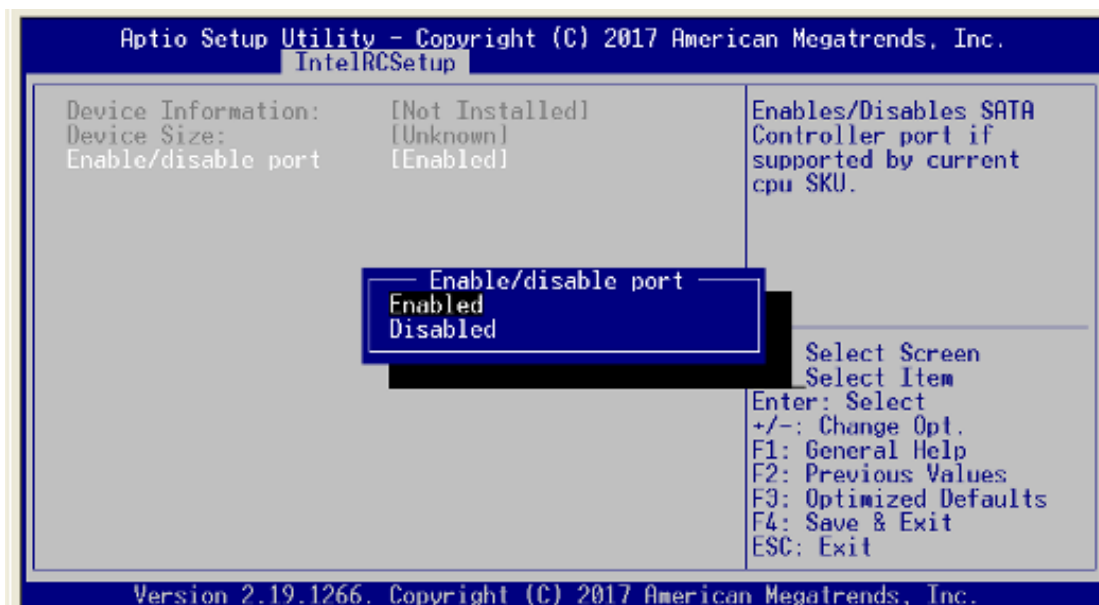

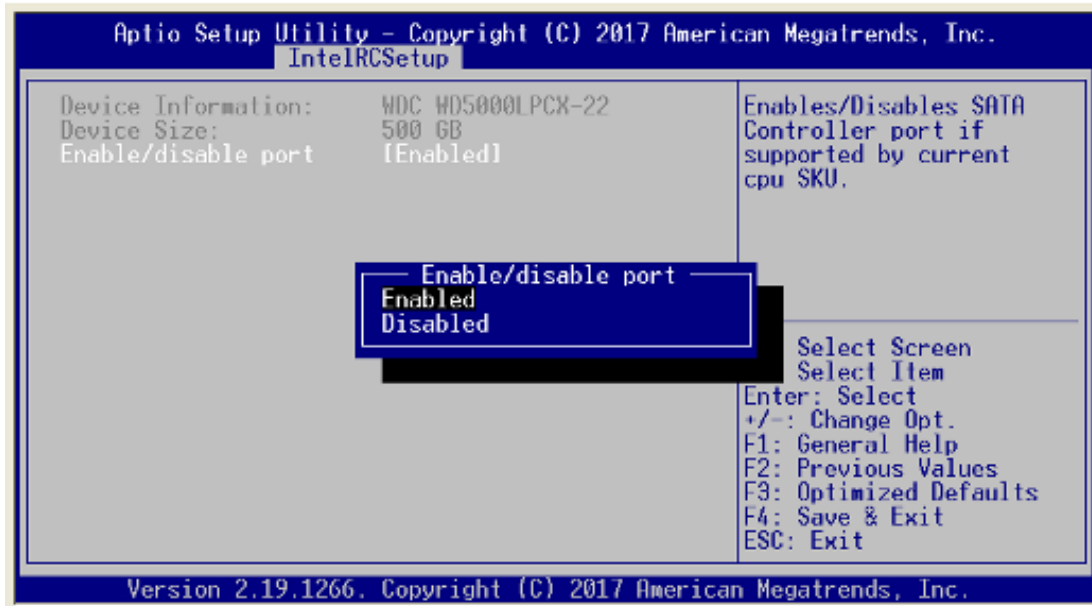



### 3.6 Security Menu

The Security menu allows users to change the security settings for the system.

#### Administrator Password

This item indicates whether an administrator password has been set (installed or uninstalled).

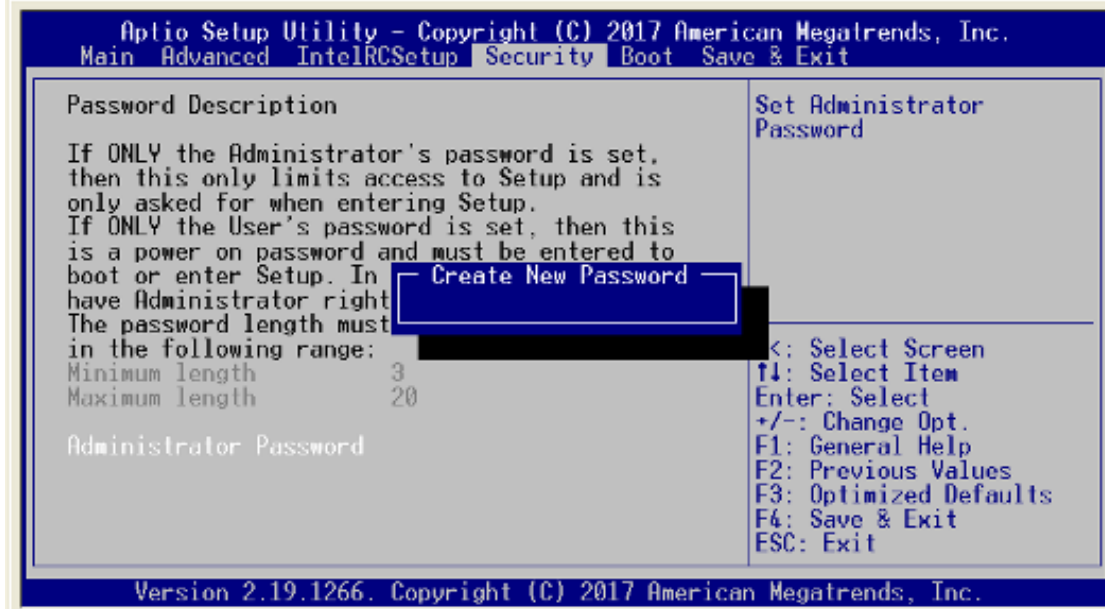

### 3.7 Boot Menu

The Boot menu allows users to change boot options of the system. You can select any of the items in the left frame of the screen to go to the sub menus:

For items marked with “▶”, please press <Enter> for more options.

#### Boot Configuration

##### Setup Prompt Timeout

Number of seconds to wait for setup activation key.

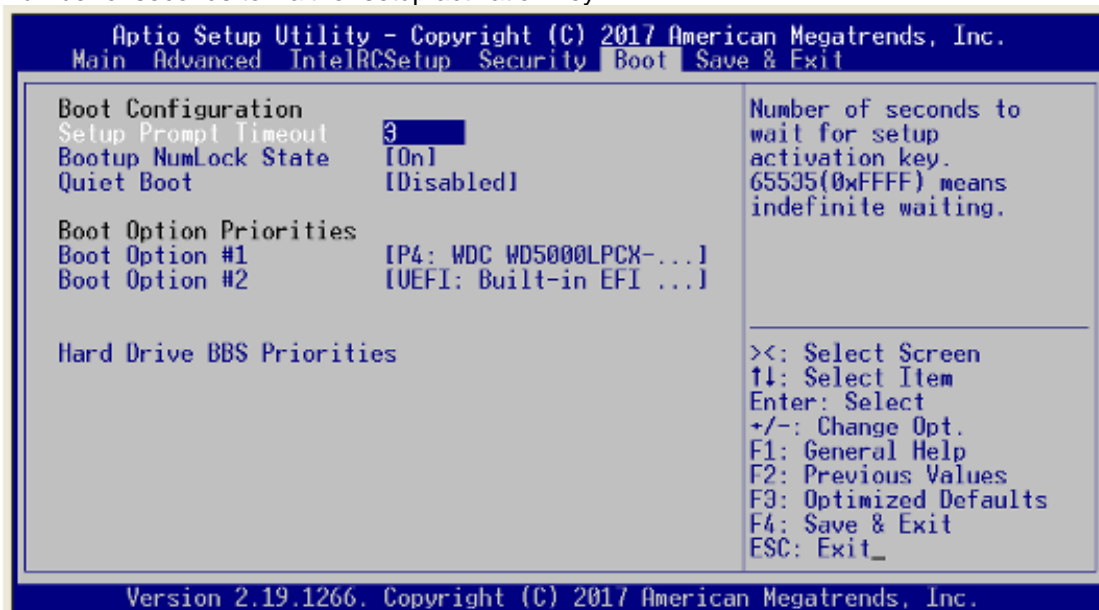

## Boot Num-Lock

Use this item to select the power-on state for the NumLock. The default setting is on.

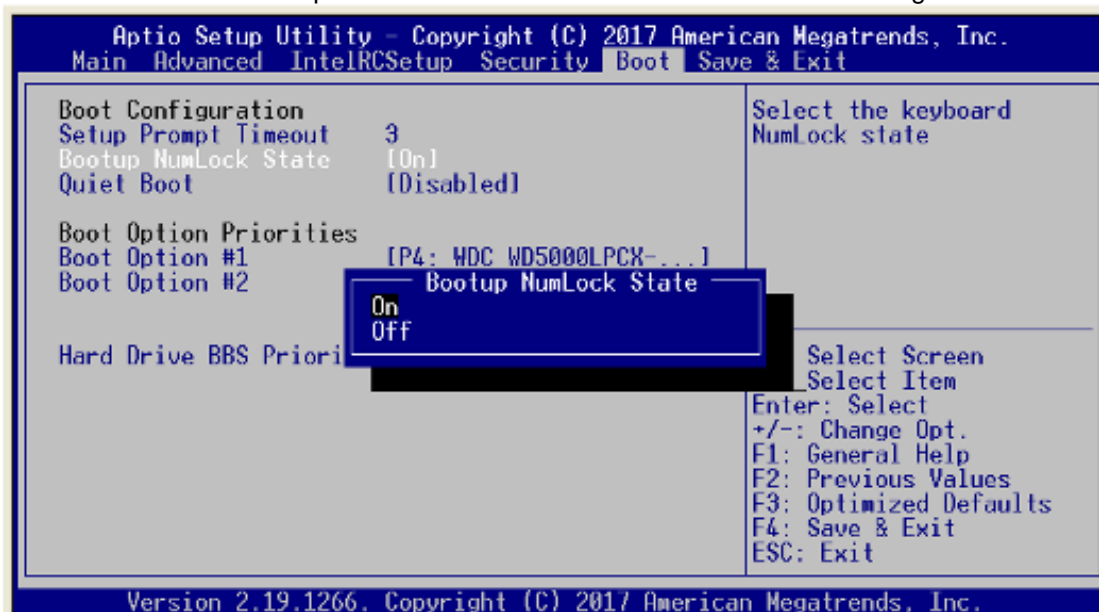

## Quiet Boot

Enable or disable quiet boot option.

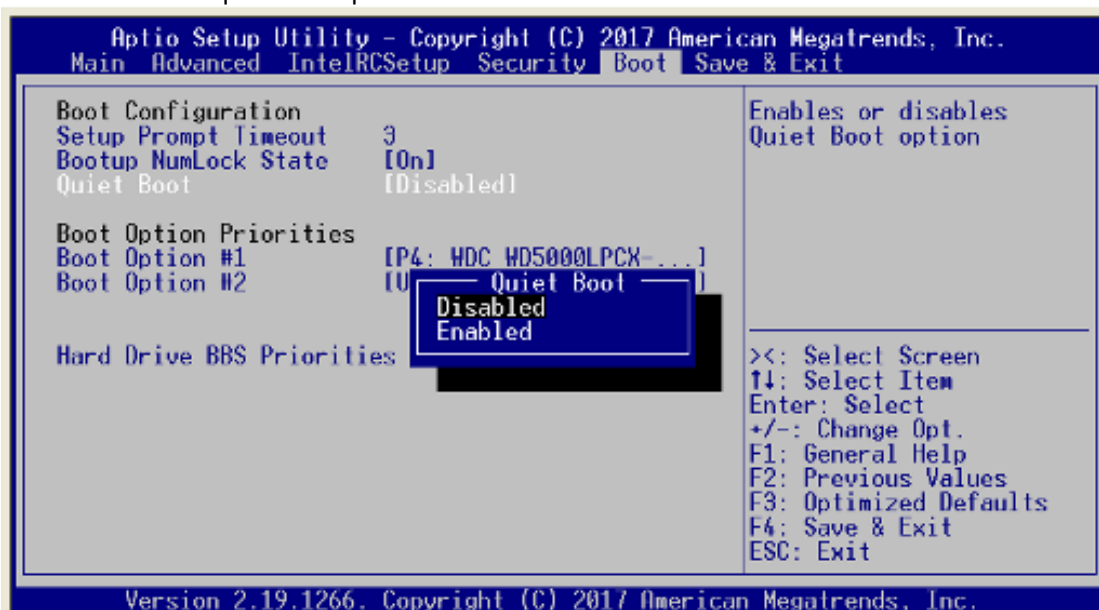

## Boot Option Priorities

### Boot Option #1 / Boot Option #1

Setup the system boot order.

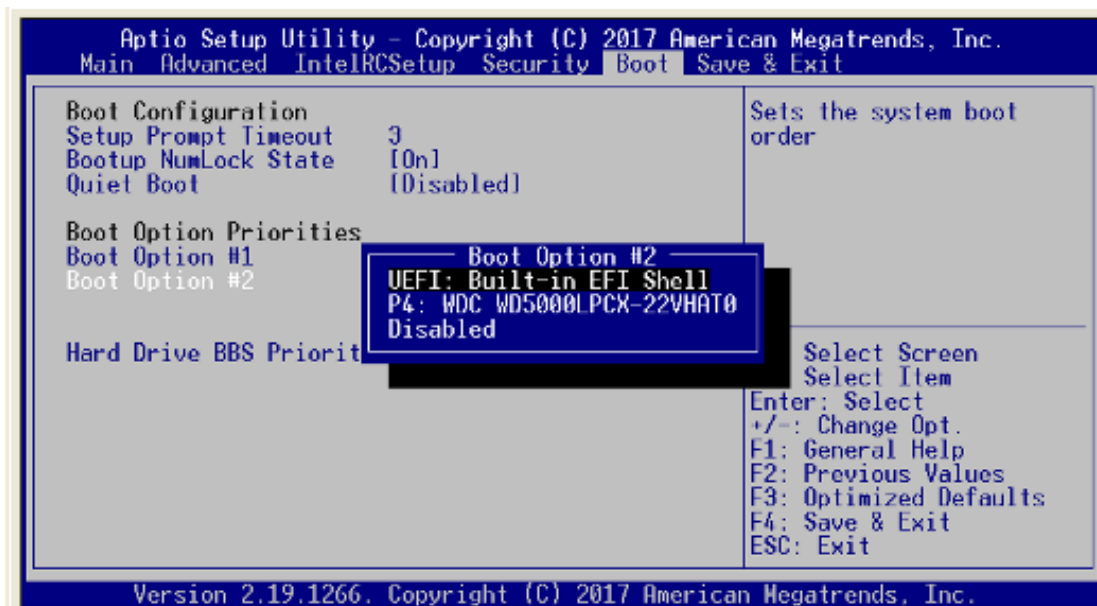
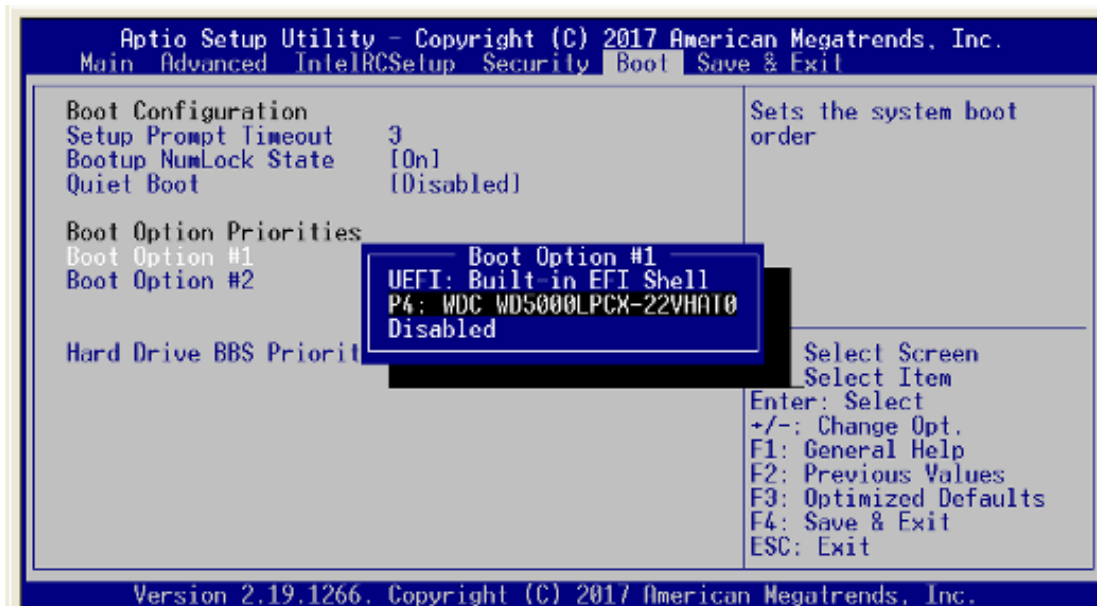

### Hard Drive BBS Priority

Setup the order of the legacy devices here.

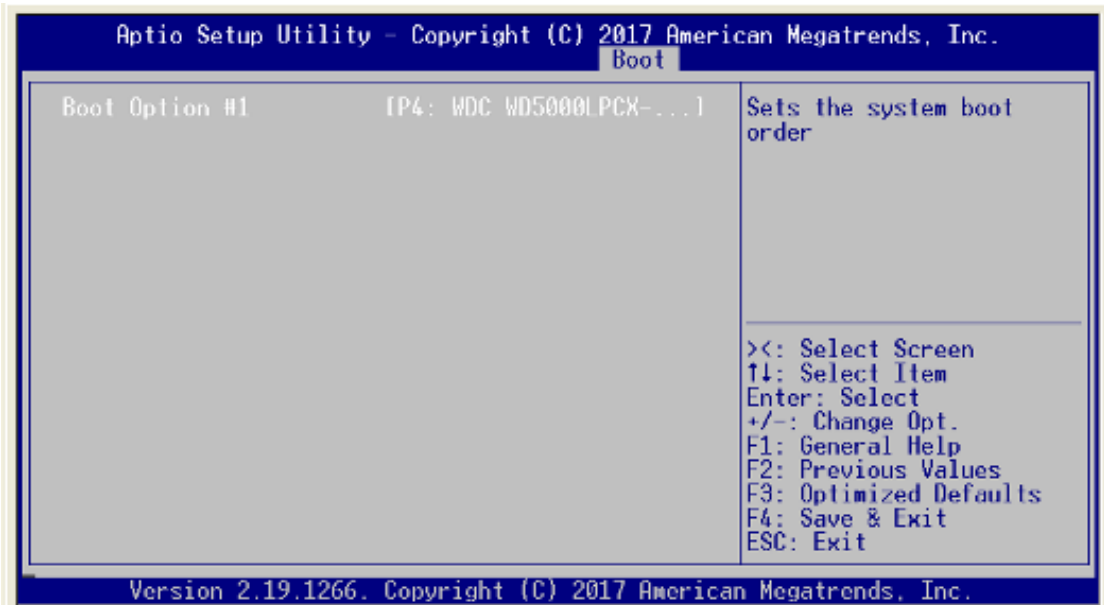
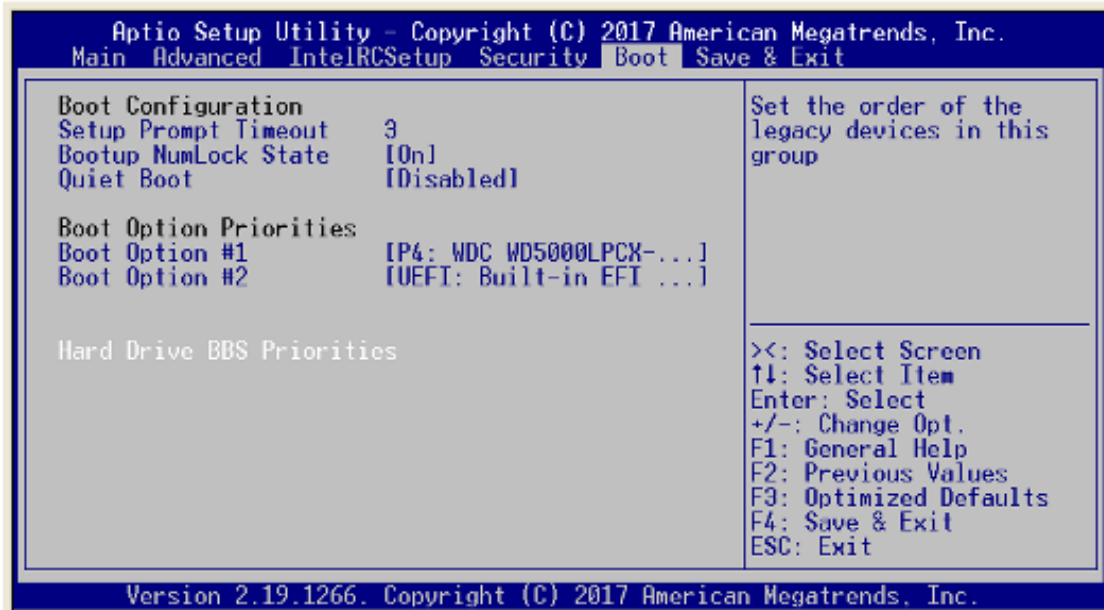

### 3.8 Save & Exit Menu

The Exit menu allows users to load your system configuration with optimal or failsafe default values.

#### Save Options

#### Save Changes and Exit

When you have completed the system configuration changes, select this option to leave Setup and reboot the computer so the new system configuration parameters can take effect. Select *Save Changes and Exit* from the Exit menu and press <Enter>. Select Ok to save changes and exit.

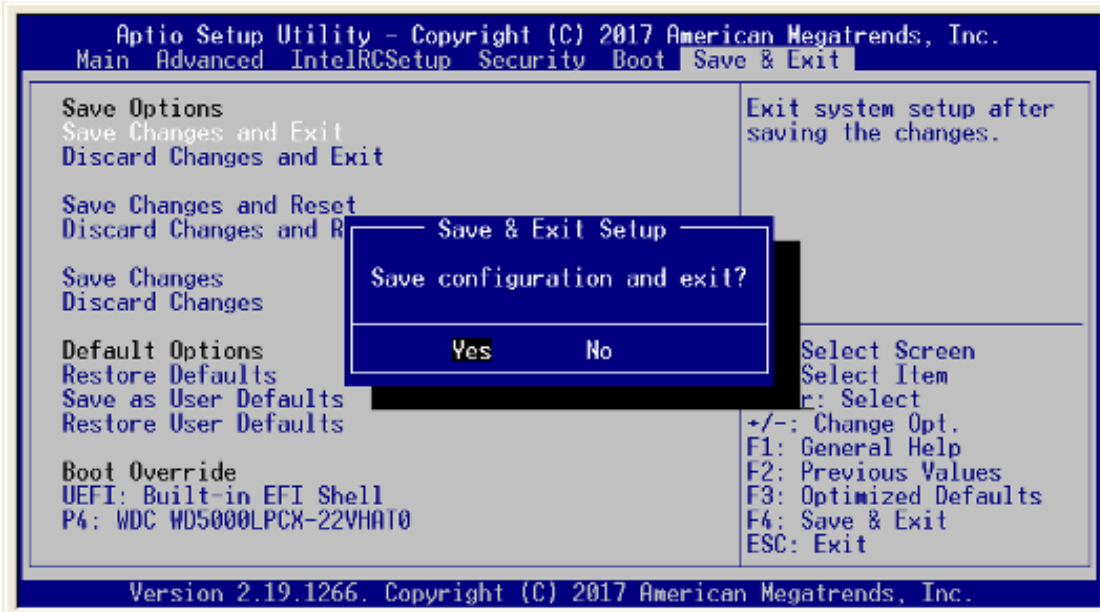

## Discard Changes and Exit

Select this option to quit Setup without making any permanent changes to the system configuration. Select *Discard Changes and Exit* from the Exit menu and press <Enter>. Select OK to discard changes and exit.

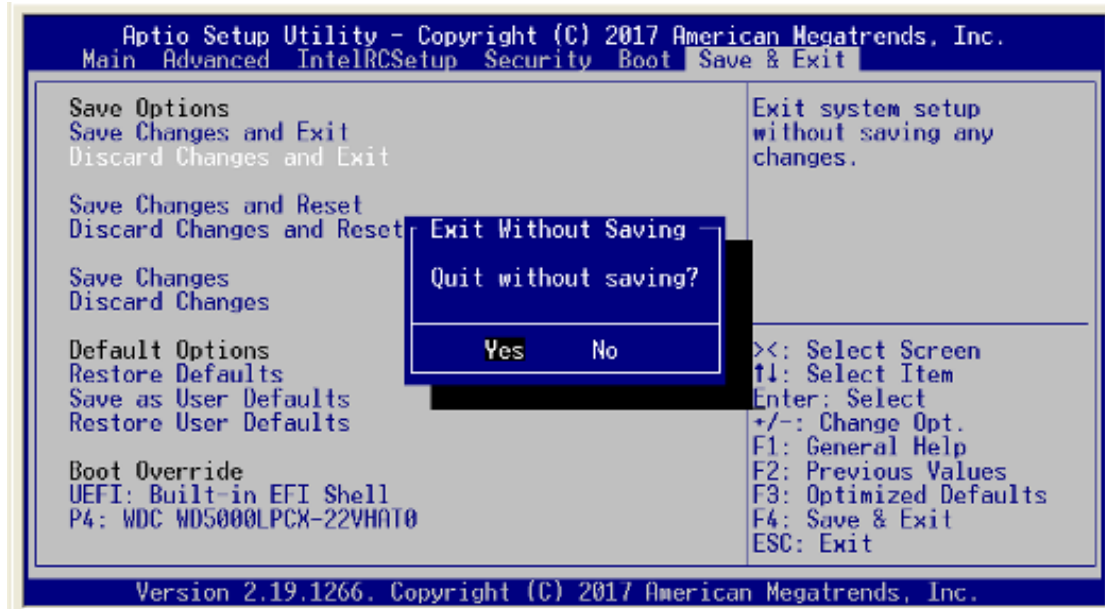

### Save Changes and Reset

Reset the system after saving the changes.

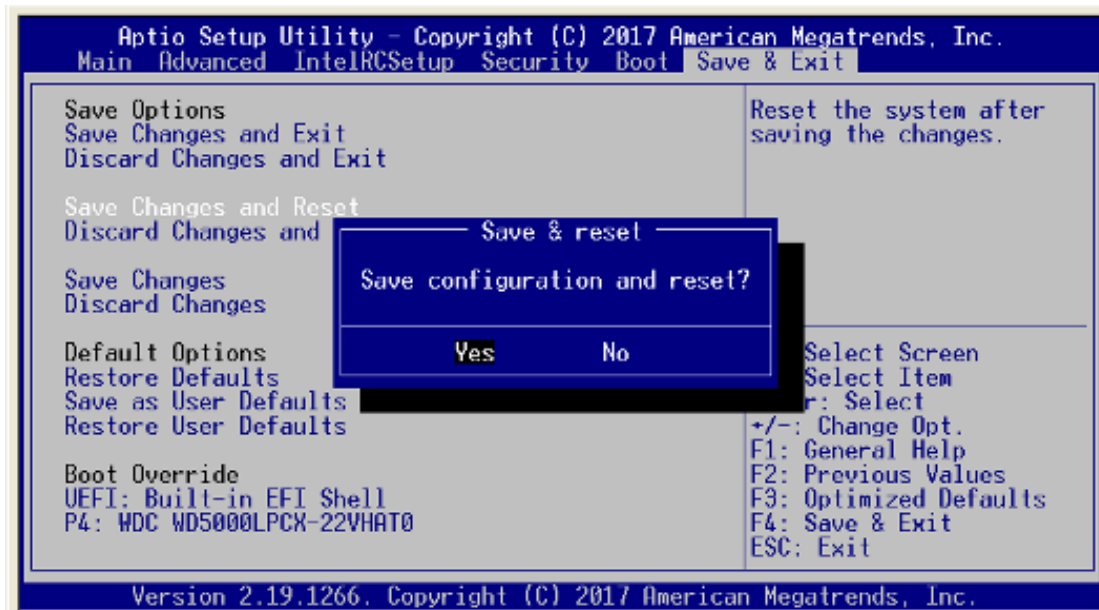

### Discard Changes and Reset

Reset system setup without saving any changes.





### Save Changes

Save Change done so far to any of the setup options.

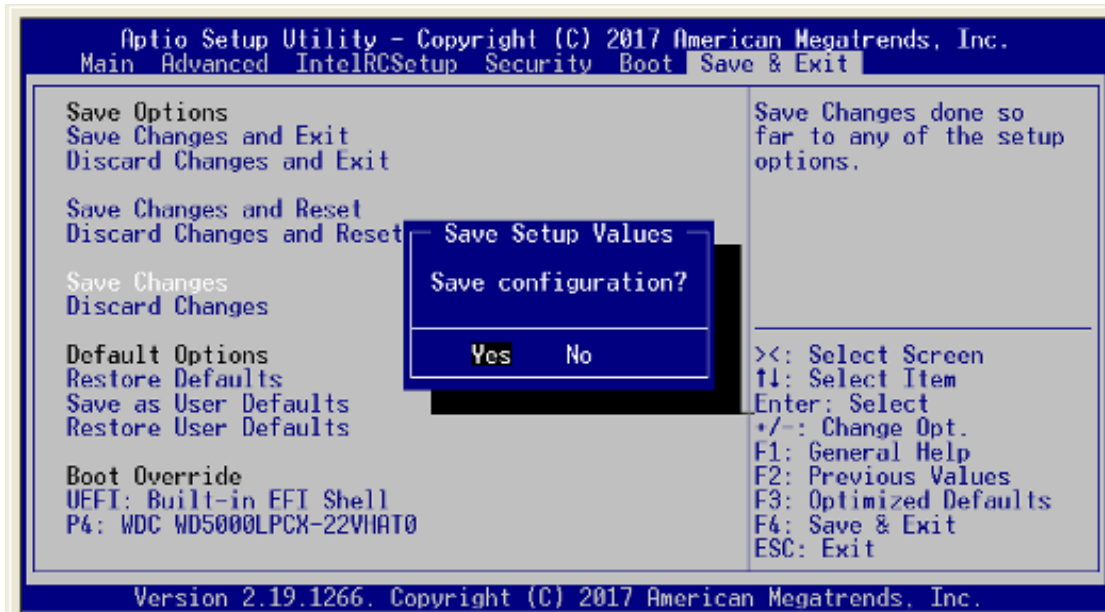

### Discard Changes

Use this item to abandon all changes.

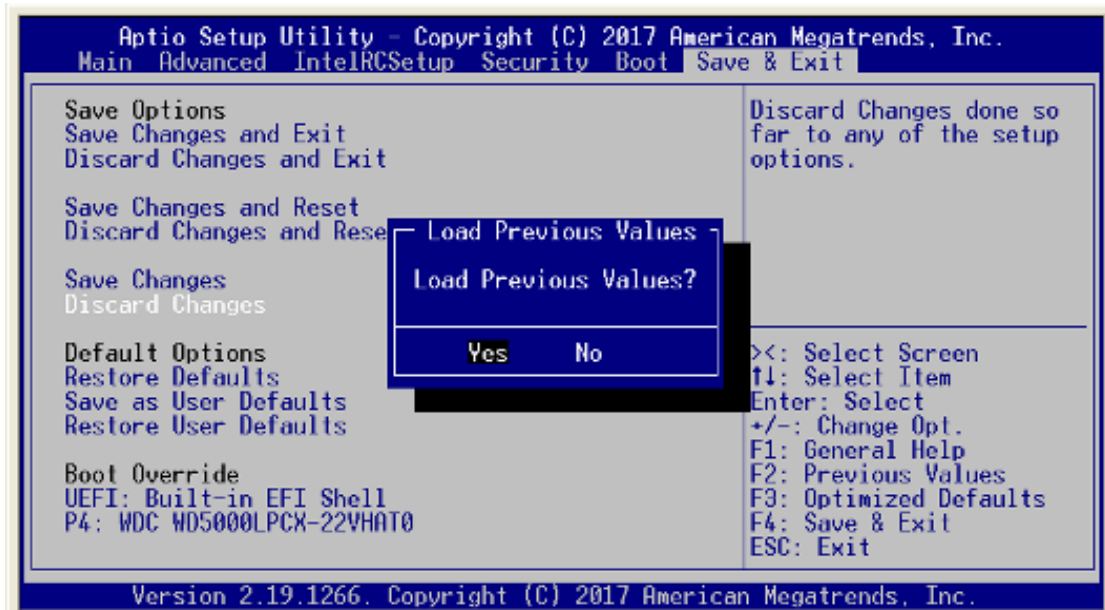

## Default Options

### Restore Defaults

Restore/Load default value for all the setup options.

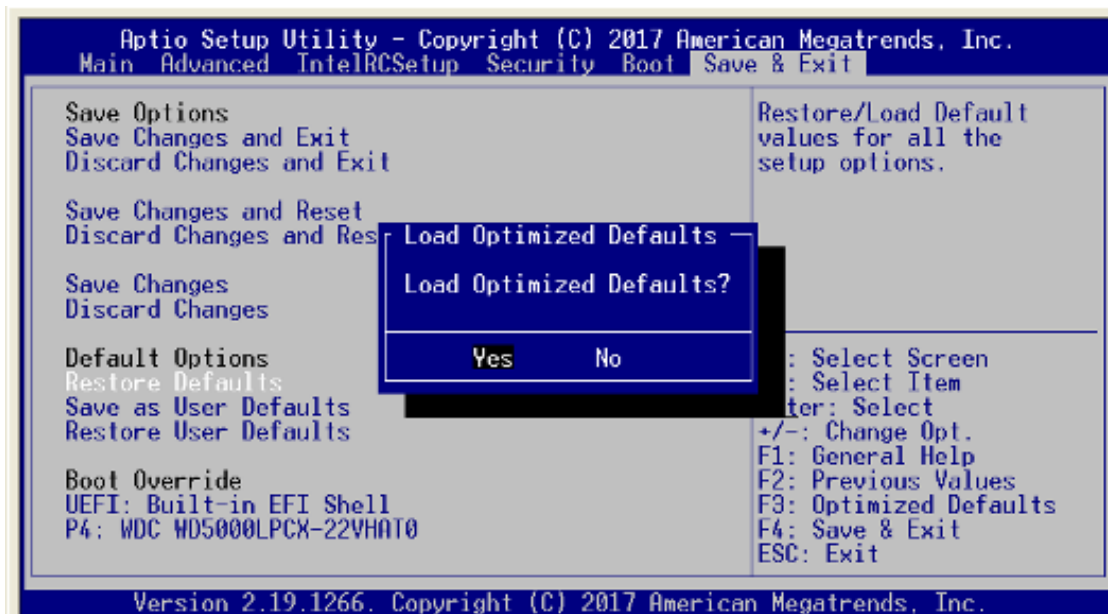

### Save as User Defaults

Save the changes done so far as User Defaults.

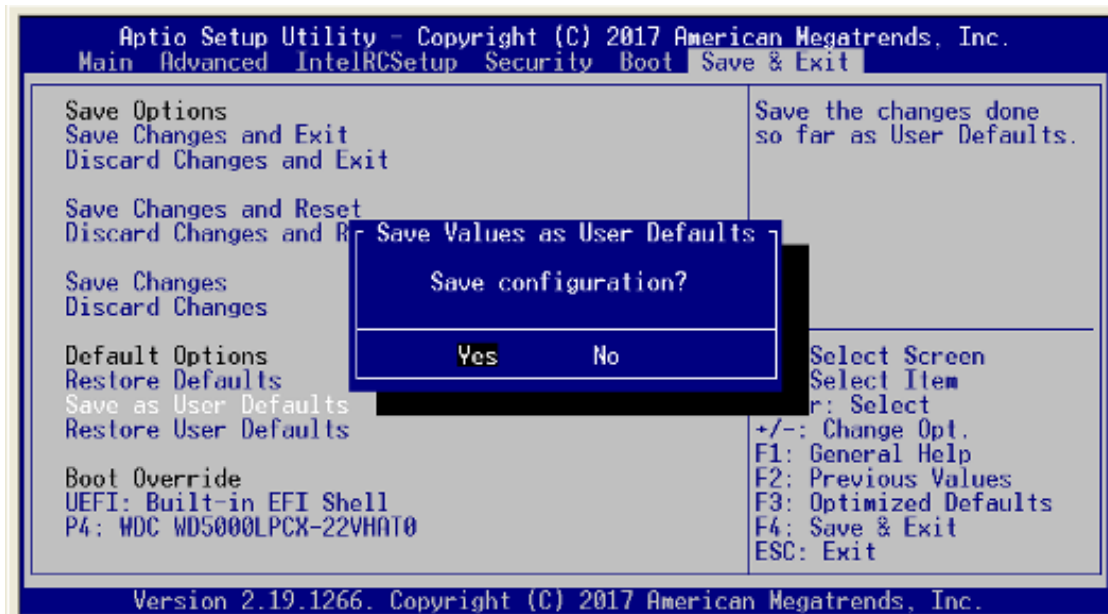

### Restore User Default

Restore the User Default to all the setup options.

 **NOTE:** There are 2 kind of BIOS default setting: factory default and optimized default.

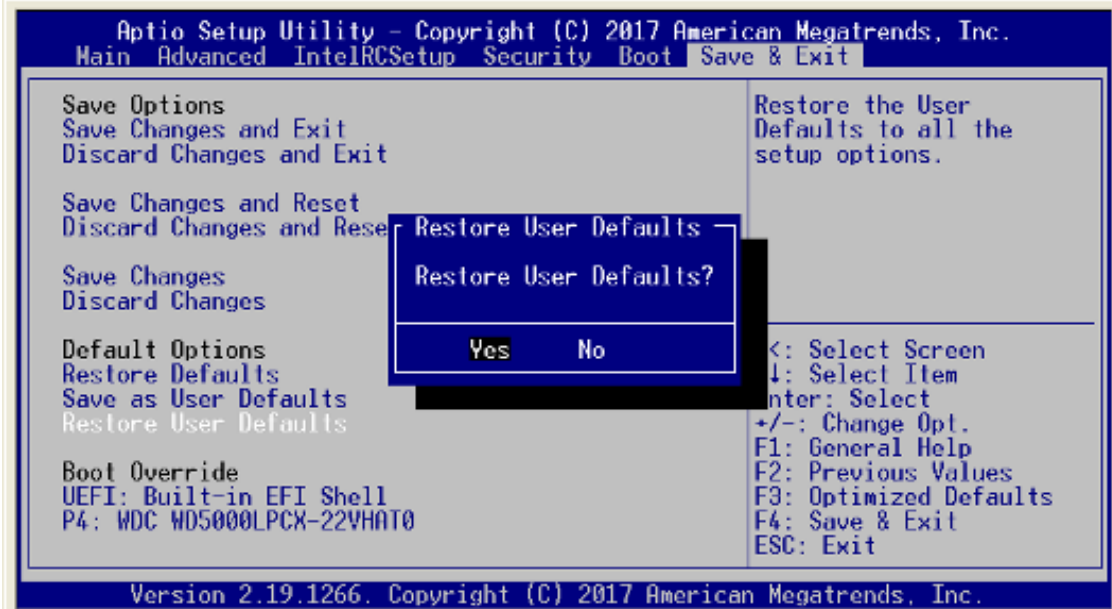

## Boot Override

Launch EFI Shell from filesystem device

Attempts to launch EFI shell application (Shellx64.efi) from one of the available filesystem device.

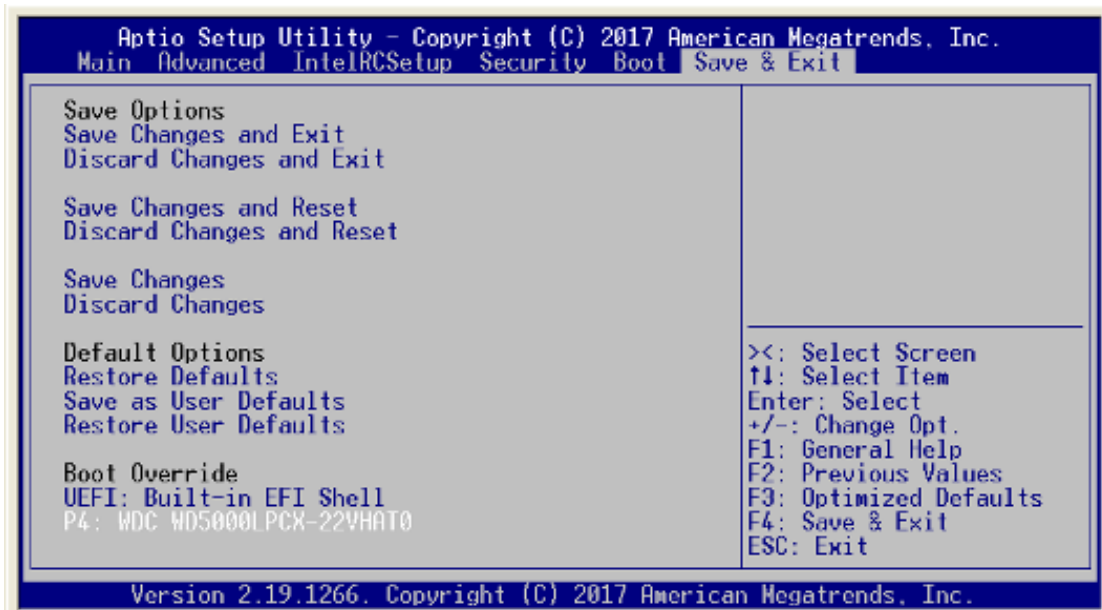
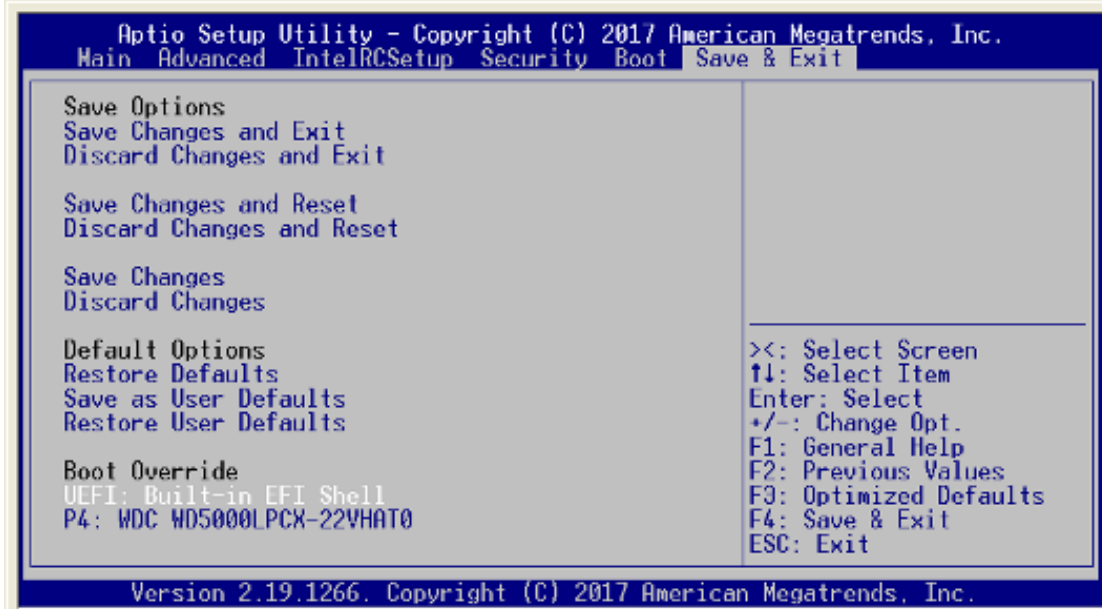

## APPENDIX A LAN BYPASS CONFIGURATION

### About LAN Bypass

In network security application, it is very important to ensure that network traffic to continue passing through the device even if a hardware failure occurs or operating system crashes. LAN bypass gives us a solution for this problem.

The NA362 series LAN bypass function is very flexible. It can be selected at any time and any stage. You can enable LAN bypass for power on state by jumper, BIOS, or by software program when entering into the OS. Moreover, for power off state, you can set up LAN Bypass through BIOS, or use software program when entering into the OS. If you don't make any change, the state will keep the previous power off state.

The NA362 series has LAN bypass capability with the special designed latch relay circuitry. When a LAN bypass function is enabled, a relay closes to act as a bridge to route network data flow between LAN port 1 & 2. The bypass feature can be activated immediately or according to timer which is configurable from 1 up to 64 seconds. You can write a software program to control bypass operation behavior to fit your requirement.



***NOTE: If you need sample codes, please contact our FAE directly, and they are for reference purposes only.***

## LAN Bypass Register Configuration

### Power ON Bypass Control Register (0x8E0)

7	6	5	4	3	2	1	0
<b>BYM1</b>	<b>BYM0</b>	<b>X</b>	<b>X</b>	<b>X</b>	<b>X</b>	<b>X</b>	<b>SEGN1</b>
W	W	--	--	--	--	--	W

Default value: 00000000

#### Bit 7~6 BYM1~0

These bits are used to set bypass mode.

- 00 Not used.
- 01 Force bypass enable  
The relay closes immediately to form LAN bypass on selected segment when power on.
- 10 Force bypass disable  
LAN bypass is disabled immediately on selected segment when power on.
- 11 Timer enable  
When power on, the selected segments are controlled by the setting of LAN bypass Timer Control register.

#### Bit 5~1 Not used

#### Bit 0 SEGN1

Select each segment by setting the corresponding bit to 1. When the bit is set to 0, no action happens upon the segment.



**NOTE:** NA362 series support SEGN1 for LAN1 and LAN2.

Data read back from this register is not defined and therefore must be ignored. Reading from this register makes no effect on LAN bypass function. All data in this register will be cleared when the system is turned off. If you still want to use the power on LAN bypass function, turn on the system and make sure to rewrite the register. Otherwise, if you don't rewrite the register, the status will be kept on last status.

**Power OFF Bypass Control Register (0x8E1)**

7	6	5	4	3	2	1	0
X	X	X	X	X	X	X	<b>SEGF1</b>
--	--	--	--	--	--	--	W

Default value: 00000000

Bit 1~7 Not used.

Bit 0 SEGF1

Use the corresponding bit to configure each segment. Setting the bit to 1 enables LAN bypass on the segment when power off. Clearing the bit to 0 disables LAN bypass on the segment when power off.



**NOTE:** NA362 series support SEGF1 for LAN1 and LAN2.

Data read back from this register is not defined and therefore must be ignored. Reading from this register makes no effect on LAN bypass function. When the system is turned off, last data written onto this register will be kept. If you want to make any change, turn on the system and make sure to reconfigure the register.

### LAN Bypass Timer Control Register (0x8E2)

7	6	5	4	3	2	1	0
<b>TEXP</b>	<b>X</b>	<b>X</b>	<b>X</b>	<b>X</b>	<b>TVAL2</b>	<b>TVAL1</b>	<b>TVAL0</b>
R	--	--	--	--	W	W	W

Default value: 00000000

Bit 7      TEXP (Read Only)

This bit indicates the status of hardware timer.

0          Timer has not expired

1          Timer has expired

Bits 6~3 Not used.

Bits 2~0 TVAL2~0

These bits determine the amount of count value in second(s).

001      1 (sec)

010      2 (sec)

011      4 (sec)

100      8 (sec)

101      16 (sec)

110      32 (sec)

111      64 (sec)

000      Timer is not activated.

Writing a value to these bits will reset the hardware timer. The counting process begins again according to the new written value. Software must write count value periodically to ensure that timer will never expire. If timer timeout occurs, relay(s) automatically close to form LAN bypass on selected segment(s) based on the setting of Power On Bypass Control register (SEGN1).

 **NOTE:** NA362 series support SEGN1 for LAN1 and LAN2.

Data (bits 6~0) read back from this register is not defined and therefore must be ignored. A read operation upon this register should not refresh the hardware timer.



**LAN Bypass Status Register (0x8E3)**

7	6	5	4	3	2	1	0
<b>VER3</b>	<b>VER2</b>	<b>VER1</b>	<b>VER0</b>	<b>BY4</b>	<b>BY3</b>	<b>BY2</b>	<b>BY1</b>
R	R	R	R	X	X	X	R

Bit 0 LAN Bypass Seg.1 status → Disable=0; Enable=1

Bit 1-3 Not used

Bit 7~4 Firmware version

Without LAN Bypass function=1111

**This page is intentionally left blank.**

## APPENDIX B WDT TIMER FOR SYSTEM RESET

### WDT (Watchdog Timer)

The hardware supports the WDT (Watchdog Timer) function. While time-out happens after a defaulted period, the WDT will reset the system.



**NOTE:** *If you need sample codes please contact our FAE directly, and they are for reference purposes only.*

**This page is intentionally left blank.**

## APPENDIX C WARNING

- This is a class B Product. In a domestic Environment this Product may cause radio interference in which case the user may be required to take adequate measures.

- It will be danger if battery is incorrectly replaced. Replacing only with the same or equivalent type is highly recommended by the manufacturer. Dispose of used batteries according to the manufacturer's instructions.

- **Warning for Hard Disk Drive Selection:**  
TUV approved Hard Disk Drive is preferred for TUV compliance Hard Disk drive-Optional, (NWGQ2), generic, Input Voltage rated 5V DC/1.0A, 12V DC/1.8A maximum. Minimum clearance from uninsulated live parts 4.0 mm.

- The equipment is to be installed in an environment with maximum ambient temperature must not exceed 40°C
- The openings on the enclosure are for air convection hence protected the equipment from overheating. DO NOT COVER THE OPENINGS.
- Lay this equipment on a reliable surface when install. A drop or fall could cause injury.
- The equipment shall be installed according to specification as nameplate. Make sure the voltage of the power source when connect the equipment to the power outlet.
- The current of load and output power of loads shall be not over the specification.
- This equipment must be connected to the reliable earthing before using.



**Electric shock hazard inside the redundant power supply.**

The exchange of modules shall be done by service person.

**This page is intentionally left blank.**