



AXIOMTEK

P6101

10.4" XGA TFT Monitor

User's Manual



Disclaimers

This manual has been carefully checked and believed to contain accurate information. Axiomtek Co., Ltd. assumes no responsibility for any infringements of patents or any third party's rights, and any liability arising from such use.

Axiomtek does not warrant or assume any legal liability or responsibility for the accuracy, completeness or usefulness of any information in this document. Axiomtek does not make any commitment to update the information in this manual.

Axiomtek reserves the right to change or revise this document and/or product at any time without notice.

No part of this document may be reproduced, stored in a retrieval system, or transmitted, in any form or by any means, electronic, mechanical, photocopying, recording, or otherwise, without the prior written permission of Axiomtek Co., Ltd.

CAUTION

If you replace wrong batteries, it causes the danger of explosion. It is recommended by the manufacturer that you follow the manufacturer's instructions to only replace the same or equivalent type of battery, and dispose of used ones.

©Copyright 2017 Axiomtek Co., Ltd.

All Rights Reserved

Apr 2017, Version A1

Printed in Taiwan

Safety Precautions

Before getting started, read the following important cautions.

1. Be sure to ground yourself to prevent static charge when installing the internal components. Use a grounding wrist strap and place all electronic components in any static-shielded devices. Most electronic components are sensitive to static electrical charge.
2. Disconnect the power cords from the P6101 Series before making any installation. Be sure both the system and the external devices are turned OFF. Sudden surge of power could ruin sensitive components. Make sure the P6101 Series is properly grounded.
3. Do not open the system's top cover. If opening the cover for maintenance is a must, only a trained technician is allowed to do so. Integrated circuits on computer boards are sensitive to static electricity. To avoid damaging chips from electrostatic discharge, observe the following precautions:
 - Before handling a board or integrated circuit, touch an unpainted portion of the system unit chassis for a few seconds. This will help to discharge any static electricity on your body.
 - When handling boards and components, wear a wrist-grounding strap, available from most electronic component stores.

Trademarks Acknowledgments

Axiomtek is a trademark of Axiomtek Co., Ltd.

Windows[®] is a trademark of Microsoft Corporation.

IBM, PC/AT, PS/2, VGA are trademarks of International Business Machines Corporation.

Intel[®] and Pentium[®] are trademarks of Intel Corporation.

AMI is trademark of American Megatrend Inc.

Other brand names and trademarks are the properties and registered brands of their respective owners.

Table of Contents

Disclaimers.....	ii
Safety Precautions.....	iii
Chapter 1 Introduction.....	1
1.1 General Description	1
1.2 Features	2
1.3 Specifications.....	2
1.4 Dimensions and Outlines	3
1.5 I/O Outlets	4
1.6 Packing List	5
Chapter 2 System Setup	7
2.1 System Configuration	7
2.2 Panel Mounting	8
2.3 Wall Mounting.....	8
2.4 VESA Mounting	9
2.5 System Jumper Setting	10
Appendix A Supported Input Timing Modes	11
Appendix B OSD Operation.....	13
Function Description of OSD Menu.....	13

Chapter 1

Introduction

This chapter contains general information and detailed specifications of the P6101. Chapter 1 includes the following sections:



- **General Description**
- **Features**
- **Specifications**
- **Dimensions and Outlines**
- **I/O Outlets**
- **Package List**

1.1 General Description

The P6101, an industrial 10.4 inches view area LCD Monitor comes with slim, light and reliable features to replace traditional bulky CRT for Industrial application. Its unique flat design is fit for panel mounting, VESA mounts and Wall mounting. The display interface offers DVI-D, HDMI and VGA for different input source from PC system or multimedia system that let you upgrade the display don't change anything from your system. Besides, for varied HMI field, you can choose one of resistive touch or glass interface to meet your application. In addition, this monitor has more comfort, safety, and environmental protection for humanized & health consideration those would be the benefit that users can get.

This LCD monitor builds in color active matrix thin-film-transistor (TFT) liquid crystal display to provide superior display performance. A maximum resolution of 1024x768 is ideal for displaying complex graphics and high definition images. Other outstanding designs that enhance this LCD monitor's performance are Plug & Play compatibility, and OSD (On Screen Display) controls, especially OSD, it made you ease adjustment on screen image.

1.2 Features

- High contrast color 10.4" XGA TFT LCD display support resolution up to 1024x768
- Flat design with NEMA4/IP65-compliant
- Suits with resistive touch or glass
- High Brightness and Ultra-wide viewing angle with anti-glare features.
- Power management system conforms to VESA DPMS standard
- Advanced OSD control for picture quality adjustment
- Supports VESA ARMs, Desktop Stand Rear, Panel and Wall mounting

1.3 Specifications

- 10.4" XGA(1024x768) LCD with LED backlight
- Resistive Touch or glass
- Front bezel design with NEMA4/IP65
- Control: OSD (On Screen Display) control pad on the side
- Mounting: Support Panel mount, VESA arm mount and Wall mount (optional)
- Net Weight
 - P6101O: 1.59KG
 - P6101P:1.94KG
- Dimension (Main Body Size)
 - P6101O: 246.3x 192.3x 51 mm
 - P6101P: 277.5x 223.55x 48 mm
- Operation Temperature
 - -20°C to 55°C
- Relative Humidity
 - 20% to 90% @ 40°C, Non-Condensing
- Power input
 - Screw-type external AC or 12V/24VDC-in
 - Max power consumption: 8W



NOTE: 1. All specifications and images are subject to change without notice.
2. If vibration is over 1GHz, LCD will have twinkle that is a normal phenomenon.
When the vibration of system goes back 1GHz, the twinkle would disappear.
3. Maximum for Line in: 1V

1.4 Dimensions and Outlines

The following diagrams show the dimensions and outlines of P6101 P6101P:

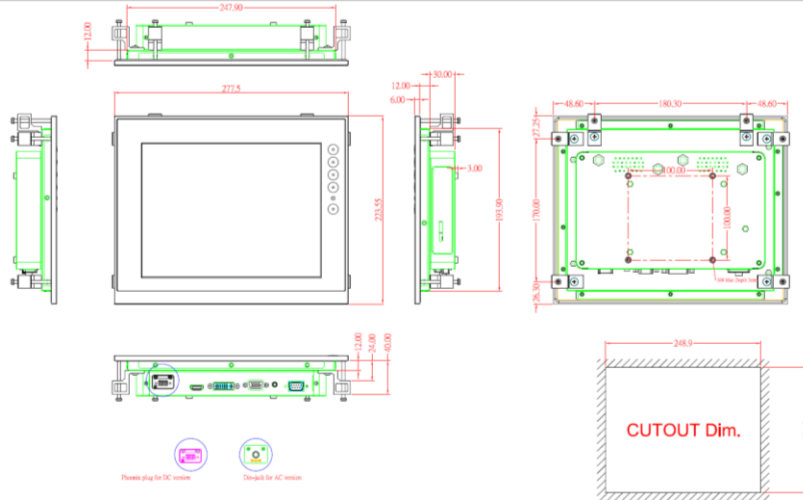

P6101O:

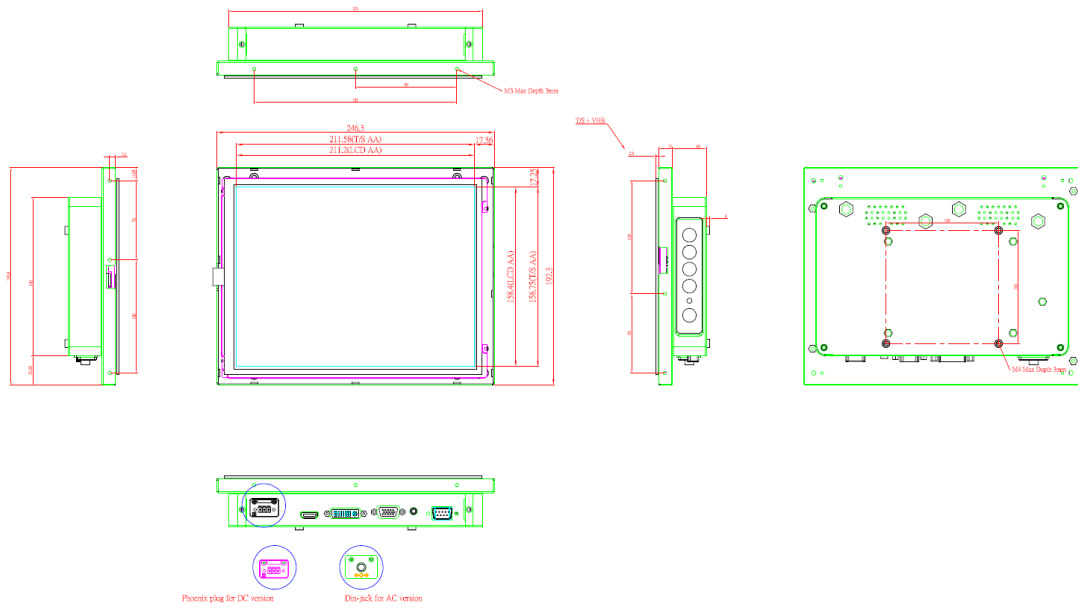

1.5 I/O Outlets

Please refer to the following illustration for I/O locations of the P6101.

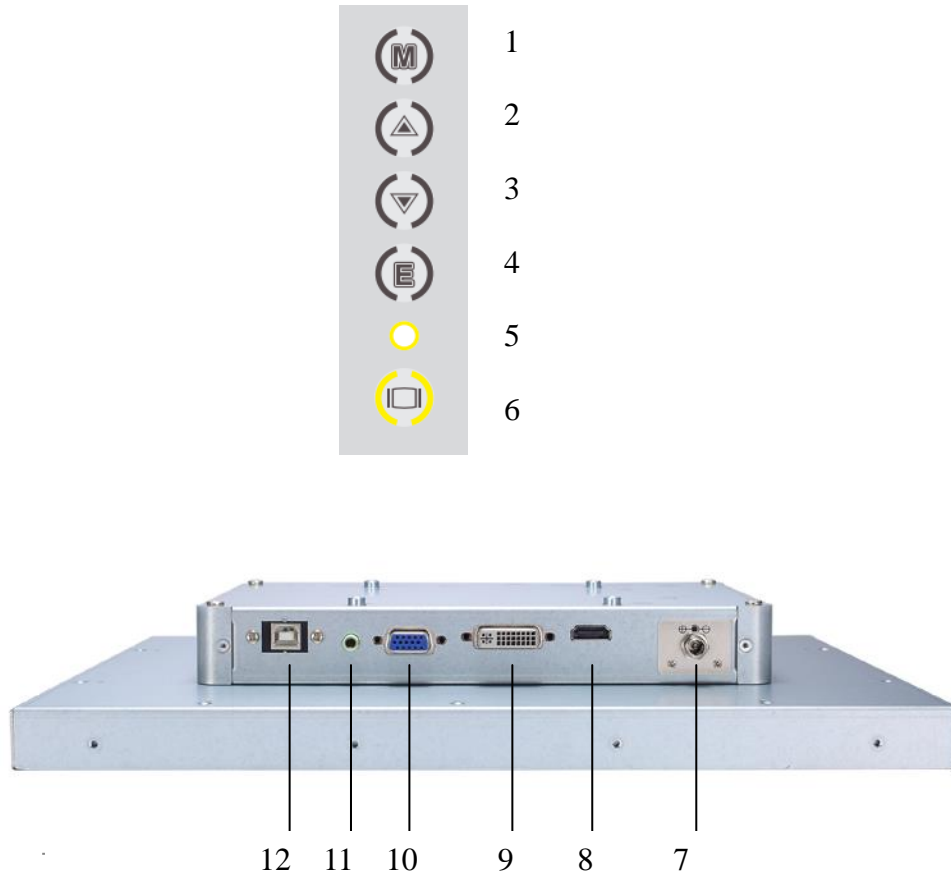

No	Function	No	Function
1	Menu (Enter function)	7	Screw type or Phoenix type power input
2	SEL+	8	HDMI
3	SEL-	9	DVI-D
4	Exit/Auto Adjust	10	VGA
5	Power LED	11	Audio
6	Power Switch	12	RS-232 or USB for Touch

1.6 Packing List

When you receive the P6101, the bundled package should contain the following items:

- **P6101 unit x 1**
- **VGA cable x1**
- **USB cable or RS-232 cable x1 (for resistive touch version only)**
- **Adaptor x1 (for AC version only)**
- **Panel mount kit x 4 (optional)**
- **HDMI cable x1 (optional)**
- **DVI cable x1 (optional)**
- **Wall mount bracket x1 (optional)**

If you can not find the package or any items are missing, please contact Axiomtek distributors immediately.

This page is intentionally left blank.

Chapter 2

System Setup

This chapter details the system parts and components with figures. Sections include:

- **System Configuration**
- **Panel Mounting**
- **Wall Mounting**
- **VESA Mounting**

2.1 System Configuration

The figure below shows the side views of P6101 series.



- 1. Menu:**
Press this button to turn on/off the OSD (On Screen Display) main menu.
Press this button to activate selected items.
- 2. SEL+:**
To scroll up the menu.
To increase the value of selected item.
- 3. SEL-:**
To scroll down the menu.
To decrease the value of selected item.
- 4. Exit:**
Jump out the selection icon.
Auto adjusts.
- 5. Power LED:**
When the light is green, the power is on, red light when stand by.
- 6. Power switch:**
Press this button to turn on/off the monitor.

2.2 Panel Mounting

The P6101 is designed for panel mount application. To mount the P6101, the standard set of mounting kit (included in the system packaging) is needed.

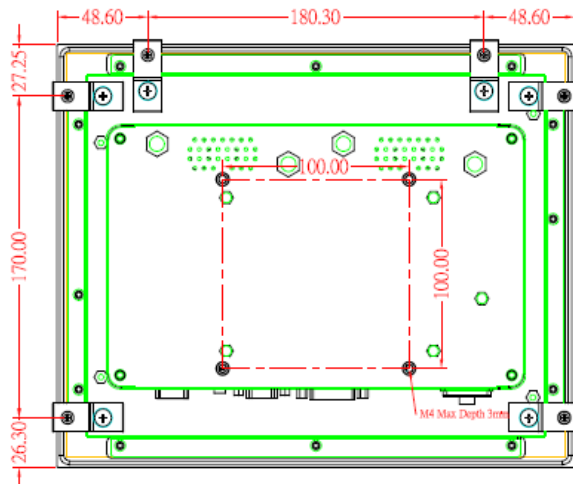

▲ P6101 Panel Mount kits

2.3 Wall Mounting

The P6101 provides VESA mount and wall mount. Screw four screws to fix the kit in the back chassis.

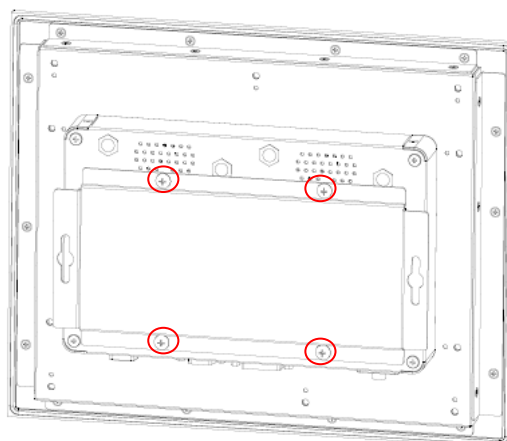

2.4 VESA Mounting

The P6101 provides VESA mount at the back of system. Screw four screws to fix the kit in the back chassis.

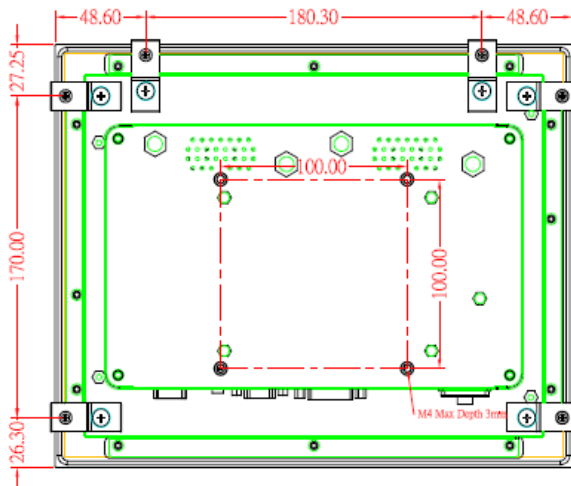

2.5 System Jumper Setting

12V DC IN

12V in only: JP3(1-3)(2-4), JP4(1-3)(2-4)

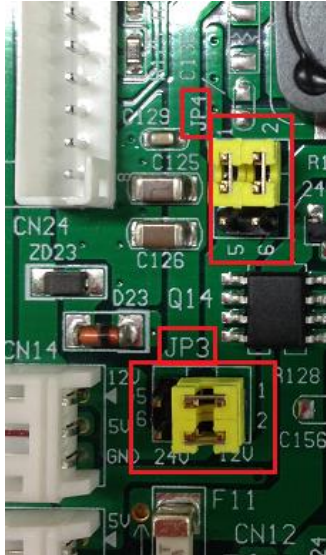

24V DC IN

24V in only: JP3(3-5)(4-6), JP4(3-5)(4-6)

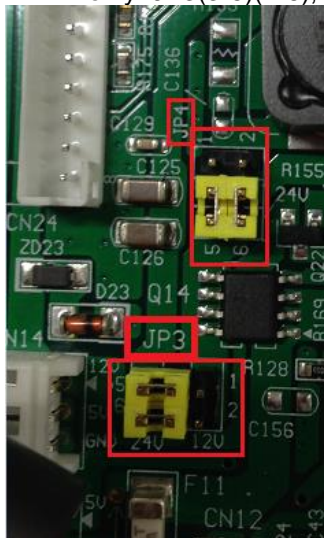

Jumper	★ Default Setting	Jumper Setting
JP3	12V DC in (VINO-12V) (Default) 24V DC in (VINO-12V)	Short 1-3, Short 2-4 Short 3-5, Short 4-6
JP4	12V DC in (Default) 24V DC to 12V DC	Short 1-3, Short 2-4 Short 3-5, Short 4-6

Appendix A

Supported Input Timing Modes

Supported Input Timing Modes

Pixel Format	Refresh Rate	Horizontal Frequency	vertical Frequency	Pixel Frequency	Standard Type	NOTE
640*480	60 Hz	31.5 kHz	59.94 Hz	25.175 MHz	Industry Standard	
	72 Hz	37.9 kHz	72.80 Hz	31.500 MHz	VESA Standard	
	75 Hz	37.5 kHz	75 Hz	31.500 MHz	VESA Standard	
800*600	56 Hz	35.2 kHz	56.25 Hz	36.000 MHz	VESA Guidelines	
	60 Hz	37.9 kHz	60.317 Hz	40.000 MHz	VESA Guidelines	
	75 Hz	46.9 kHz	75 Hz	49.500 MHz	VESA Standard	
1024*768	60 Hz	48.4 kHz	60 Hz	65.000 MHz	VESA Guidelines	
	70 Hz	56.5 kHz	70 Hz	75.000 MHz	VESA Standard	
	75 Hz	60.0 kHz	75 Hz	78.750 MHz	VESA Standard	
1280*1024	60 Hz	64.0 kHz	60.020 Hz	108.000 MHz	VESA Standard	
	75 Hz	80.0 kHz	75.025 Hz	135.000 MHz	VESA Standard	
1360*768	60 Hz	47.7 kHz	60.015 Hz	85.500 MHz	VESA Standard	//VGA Only
1366*768	60 Hz	47.7 kHz	59.79 Hz	85.500 MHz	VESA Standard	//DVI, HDMI Only
1680*1050	60 Hz	65.3 kHz	59.954 Hz	146.250 MHz	CVT	
1920*1080	60 Hz	67.5 kHz	60 Hz	148.500 MHz	CEA Standard	



NOTE: Timing depends on LCD Panel's requirement.

This page is intentionally left blank.

Appendix B

OSD Operation

Function Description of OSD Menu

※The layout and format of OSD depends on customer's request.

OSD MENU	Description
 <p>Luminance</p>	Luminance : <ul style="list-style-type: none"> • Brightness • Contrast • Sharpness
 <p>Picture</p>	Picture <ul style="list-style-type: none"> • Phase • Clock • H position • V position
 <p>Color</p>	Color: <ul style="list-style-type: none"> • Color Temperature (6500,7500,9300,user define) • Red • Green • Blue.
 <p>OSD</p>	OSD Settings : <ul style="list-style-type: none"> • Horizontal • Vertical • Transparency • OSD Time out .
 <p>Setup</p>	Setup: <ul style="list-style-type: none"> • Language • Volume • Mute • Input • Reset

This page is intentionally left blank.