



AXIOMTEK

PICO511

**7th Generation Intel® Core™ i7/ i5/ i3
and Celeron® ULT Processors
Pico-ITX Board**

User's Manual



Disclaimers

This manual has been carefully checked and believed to contain accurate information. Axiomtek Co., Ltd. assumes no responsibility for any infringements of patents or any third party's rights, and any liability arising from such use.

Axiomtek does not warrant or assume any legal liability or responsibility for the accuracy, completeness or usefulness of any information in this document. Axiomtek does not make any commitment to update the information in this manual.

Axiomtek reserves the right to change or revise this document and/or product at any time without notice.

No part of this document may be reproduced, stored in a retrieval system, or transmitted, in any form or by any means, electronic, mechanical, photocopying, recording, or otherwise, without the prior written permission of Axiomtek Co., Ltd.

CAUTION

If you replace wrong batteries, it causes the danger of explosion. It is recommended by the manufacturer that you follow the manufacturer's instructions to only replace the same or equivalent type of battery, and dispose of used ones.

©Copyright 2017 Axiomtek Co., Ltd.

All Rights Reserved

March 2017, Version A1

Printed in Taiwan

ESD Precautions

Computer boards have integrated circuits sensitive to static electricity. To prevent chipsets from electrostatic discharge damage, please take care of the following jobs with precautions:

- Do not remove boards or integrated circuits from their anti-static packaging until you are ready to install them.
- Before holding the board or integrated circuit, touch an unpainted portion of the system unit chassis for a few seconds. It discharges static electricity from your body.
- Wear a wrist-grounding strap, available from most electronic component stores, when handling boards and components.

Trademarks Acknowledgments

Axiomtek is a trademark of Axiomtek Co., Ltd.

Intel[®] and Celeron[®] are trademarks of Intel Corporation.

Windows[®] is a trademark of Microsoft Corporation.

AMI is trademark of American Megatrend Inc.

IBM, PC/AT, PS/2, VGA are trademarks of International Business Machines Corporation.

Other brand names and trademarks are the properties and registered brands of their respective owners.

Table of Contents

Disclaimers.....	ii
ESD Precautions.....	iii
Chapter 1 Introduction.....	1
1.1 Features.....	2
1.2 Specifications.....	2
1.3 Utilities.....	3
Chapter 2 Board and Pin Assignments.....	5
2.1 Board Dimensions and Fixing Holes.....	5
2.2 Board Layout.....	7
2.3 Assembly Drawing.....	9
2.4 Jumper Settings.....	11
2.4.1 Restore BIOS Optimal Defaults (JP2).....	12
2.4.2 Auto Power On (JP3).....	12
2.4.3 LVDS Voltage Selection (JP4).....	12
2.5 Connectors.....	13
2.5.1 Board to Board Connectors (CN2 and CN3).....	14
2.5.2 SATA Connector (CN4).....	16
2.5.3 USB 2.0 Wafer Connector (CN5).....	16
2.5.4 SATA Power Connector (CN6).....	16
2.5.5 I2C Connector (CN7).....	16
2.5.6 CMOS Battery Connector (CN8).....	17
2.5.7 Front Panel Connector (CN9).....	17
2.5.8 SMBus Connector (CN10).....	17
2.5.9 Fan Power Connector (CN11).....	18
2.5.10 LVDS Connector (CN12).....	18
2.5.11 Inverter Connector (CN13).....	20
2.5.12 Power Connector (CN14).....	20
2.5.13 Ethernet Connector (CN15).....	20
2.5.14 Full-size PCI-Express Mini Card or mSATA Connector (SCN1).....	21
2.5.15 Half-size PCI-Express Mini Card Connector (SCN3).....	22
Chapter 3 Hardware Description.....	23
3.1 Microprocessors.....	23
3.2 BIOS.....	23
3.3 System Memory.....	23

3.4	I/O Port Address Map	24
3.5	Interrupt Controller (IRQ) Map	26
3.6	Memory Map	35
Chapter 4 AMI BIOS Setup Utility		37
4.1	Starting	37
4.2	Navigation Keys	37
4.3	Main Menu	39
4.4	Advanced Menu	40
4.5	Chipset Menu	52
4.6	Security Menu	58
4.7	Boot Menu	59
4.8	Save & Exit Menu	61
Appendix A I/O Board		63
A.1	AX93A07 Specifications	63
A.2	AX93A07 Dimensions and Fixing Holes	63
A.3	AX93A07 Board Layout	64
A.4	AX93A07 Connectors	65
A.4.1	Ethernet Board to Board Connector (CN1)	65
A.4.2	DC Power Output Connector (CN2)	65
A.4.3	LVDS Input Connector (CN3)	66
A.4.4	SMBus Connector (CN4)	66
A.4.5	DC Jack Power Input Connector w/ Screw (CN5)	66
A.4.6	RJ-45 Ethernet Port (CN6)	67
A.4.7	D-Sub VGA Connector (CN8)	67
Appendix B Watchdog Timer		69
B.1	About Watchdog Timer	69
B.2	How to Use Watchdog Timer	69
Appendix C iAMT Settings		71
C.1	Entering MEBx	71
C.2	Set and Change Password	71
C.3	iAMT Configuration	73
C.4	iAMT Web Console	81
Appendix D BIOS Flash Utility		83

This page is intentionally left blank.

Chapter 1

Introduction

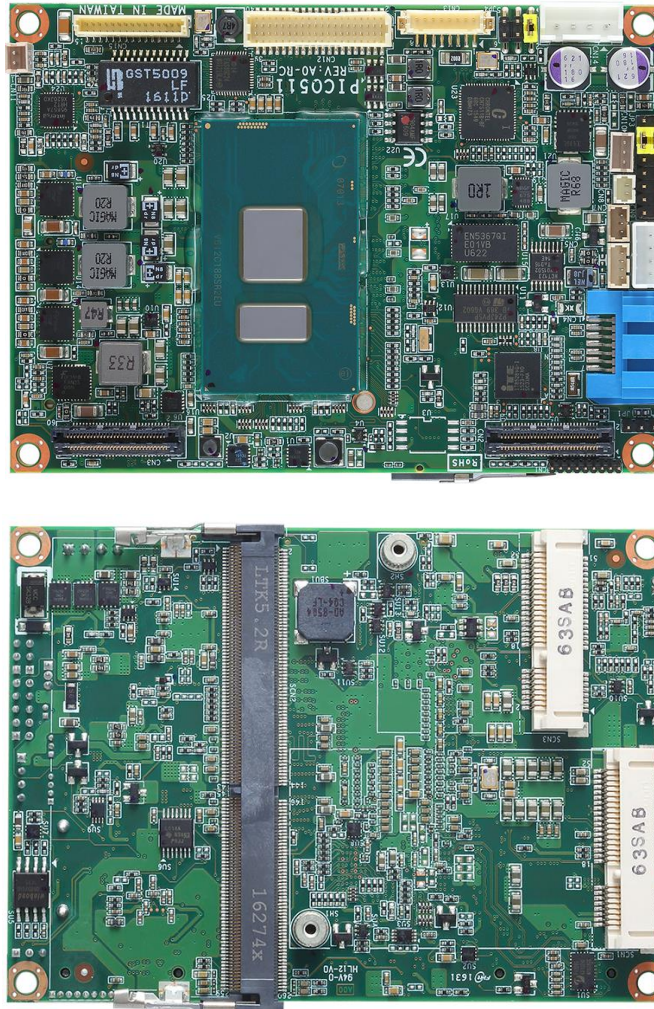

The PICO511 is a Pico-ITX board with 7th Generation Intel® Core™ i7/ i5/ i3 and Celeron® ULT processor that delivers outstanding system performance through high-bandwidth interfaces, multiple I/O functions for interactive applications and various embedded computing solutions.

The board has one 260-pin unbuffered SO-DIMM socket for DDR4 2133MHz SO-DIMM memory with maximum memory capacity up to 16GB. It also features one Gigabit/Fast Ethernet, one SATA port with transfer rates up to 6Gb/s and one USB 2.0 high speed compliant, that can achieve the best stability and reliability for industrial applications. Additionally, it provides you with unique embedded feature such as Pico-ITX form factor that applies an extensive array of PC peripherals. The board can be enhanced by its built-in watchdog timer function, a special industrial feature not commonly seen on other motherboards.

1.1 Features

- 7th Generation Intel® Core™ i7/ i5/ i3 and Celeron® ULT processor
- 1 DDR4 SO-DIMM supports up to 16GB memory capacity
- 1 USB 2.0 port and 1 Gigabit Ethernet port
- 1 PCI-Express Mini Card

1.2 Specifications

- **CPU**
 - 7th Generation Intel® Core™ i7-7600U 2.8GHz dual core.
 - 7th Generation Intel® Core™ i5-7300U 2.6GHz dual core.
 - 7th Generation Intel® Core™ i3-7100U 2.4GHz dual core.
 - Intel® Celeron® 3965U 2.2GHz.
- **Thermal Solution**
 - Active.
- **BIOS**
 - American Megatrends Inc. UEFI (Unified Extensible Firmware Interface) BIOS.
 - 128Mbit SPI Flash, DMI, Plug and Play.
 - RPL/PXE Ethernet Boot ROM.
- **System Memory**
 - One 260-pin unbuffered DDR4 SO-DIMM socket.
 - Maximum up to 16GB DDR4 2133MHz memory.
- **Serial ATA**
 - One SATA-600 connector.
 - mSATA support.
- **USB Interface**
 - One USB port with fuse protection and complies with USB Spec. Rev. 2.0.
- **Display**
 - One 2x20-pin connector for 18/24-bit single and dual channel LVDS and one 8-pin wafer connector for inverter control. LVDS resolution is up to 1920x1200 in 24-bit dual channel.
- **Watchdog Timer**
 - 1~65535 seconds or minutes; up to 255 levels.
- **Ethernet**
 - One 1000/100/10Mbps Gigabit/Fast Ethernet port through internal wafer.
 - Support Wake-on-LAN, PXE Boot ROM with Intel® i219LM.
- **Expansion Interface**
 - One PCI-Express Mini Card socket complies with PCI-Express Mini Card Spec. V1.2.
 - One board to board connector (high speed signal).
 - One board to board connector (low speed signal).

- **Power Input**
 - DC jack power connector, co-layout with 1x2-pin right angle connector.
 - +12V DC-in only.
 - AT auto power on function supported.
- **Power Management**
 - ACPI (Advanced Configuration and Power Interface).
- **Form Factor**
 - Pico-ITX form factor.



All specifications and images are subject to change without notice.

Note

1.3 Utilities

- Chipset and graphics driver
- Ethernet driver (i219LM)
- Audio driver
- Intel Management Engine Software for AMT support

This page is intentionally left blank.

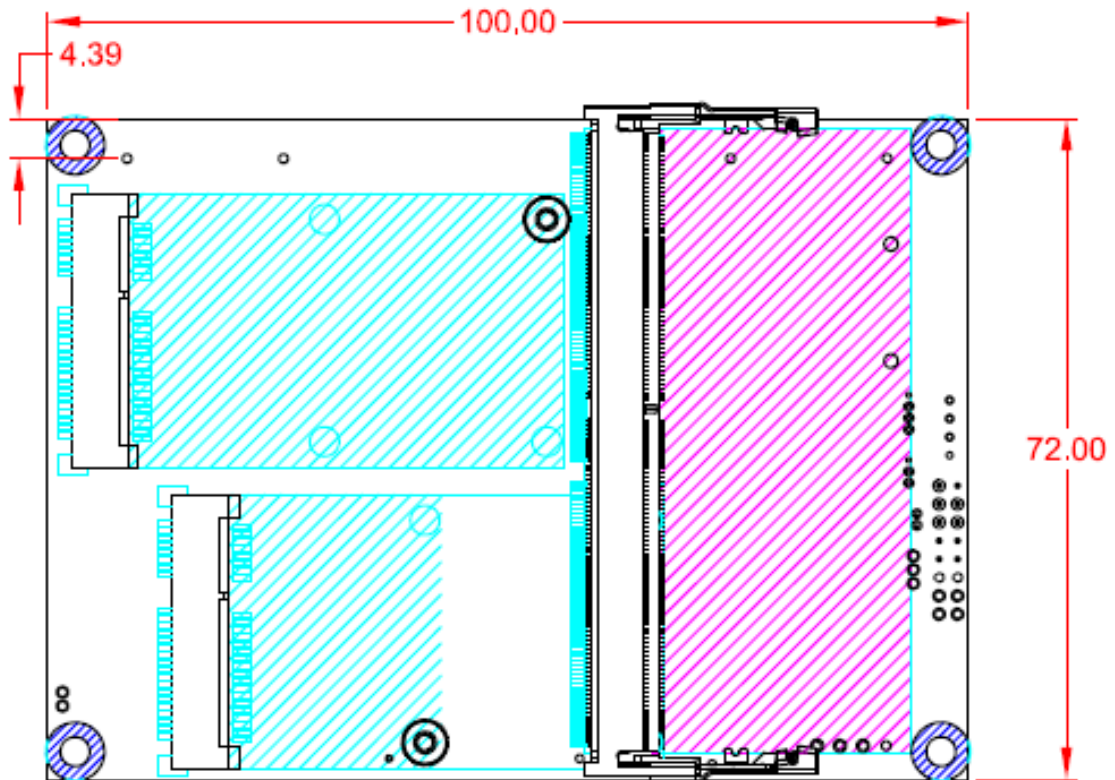

Bottom View

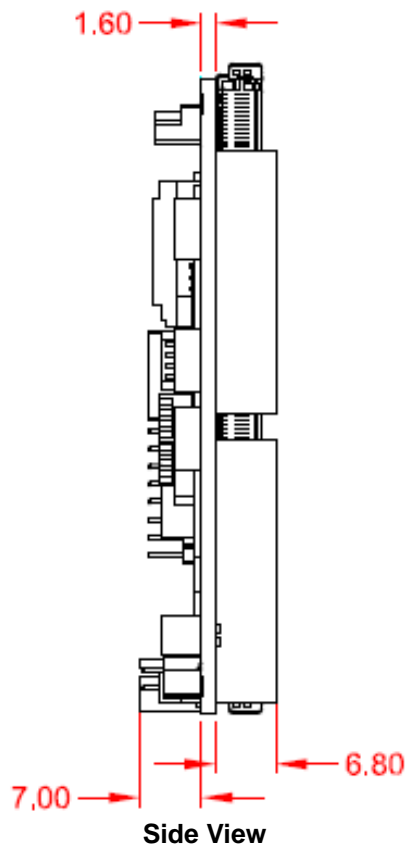

Side View

2.2 Board Layout

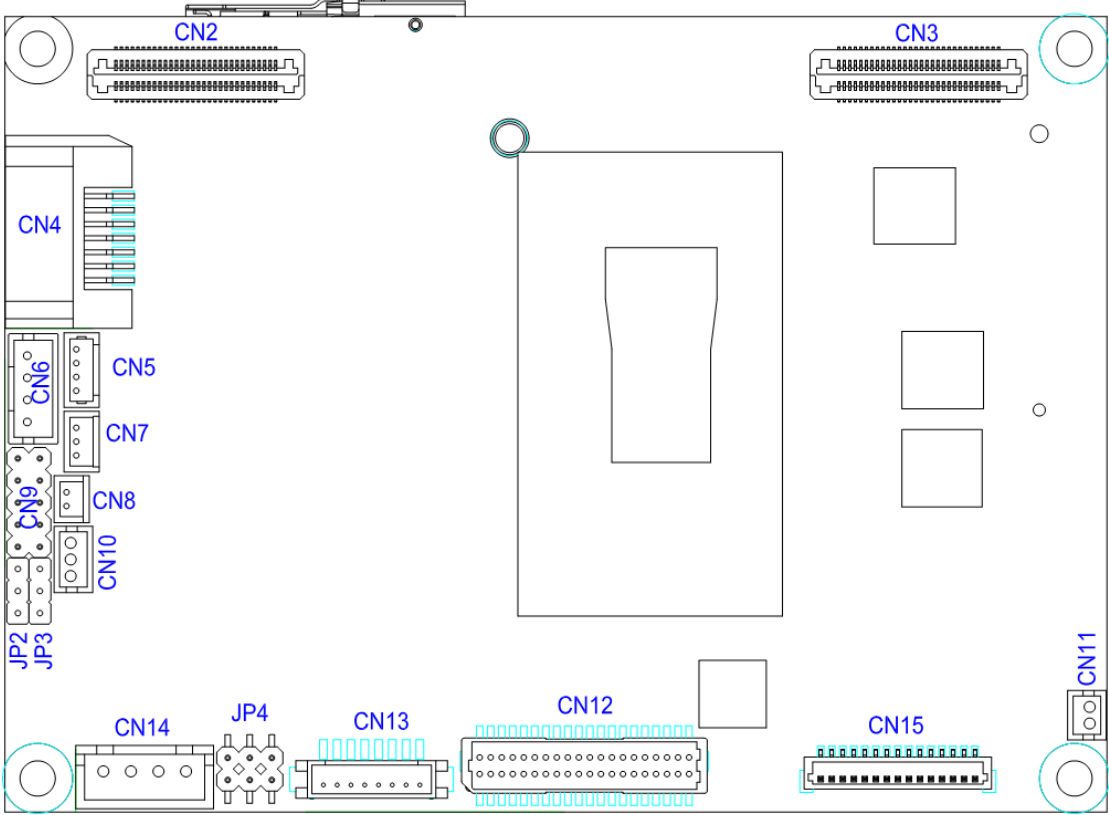

Top View

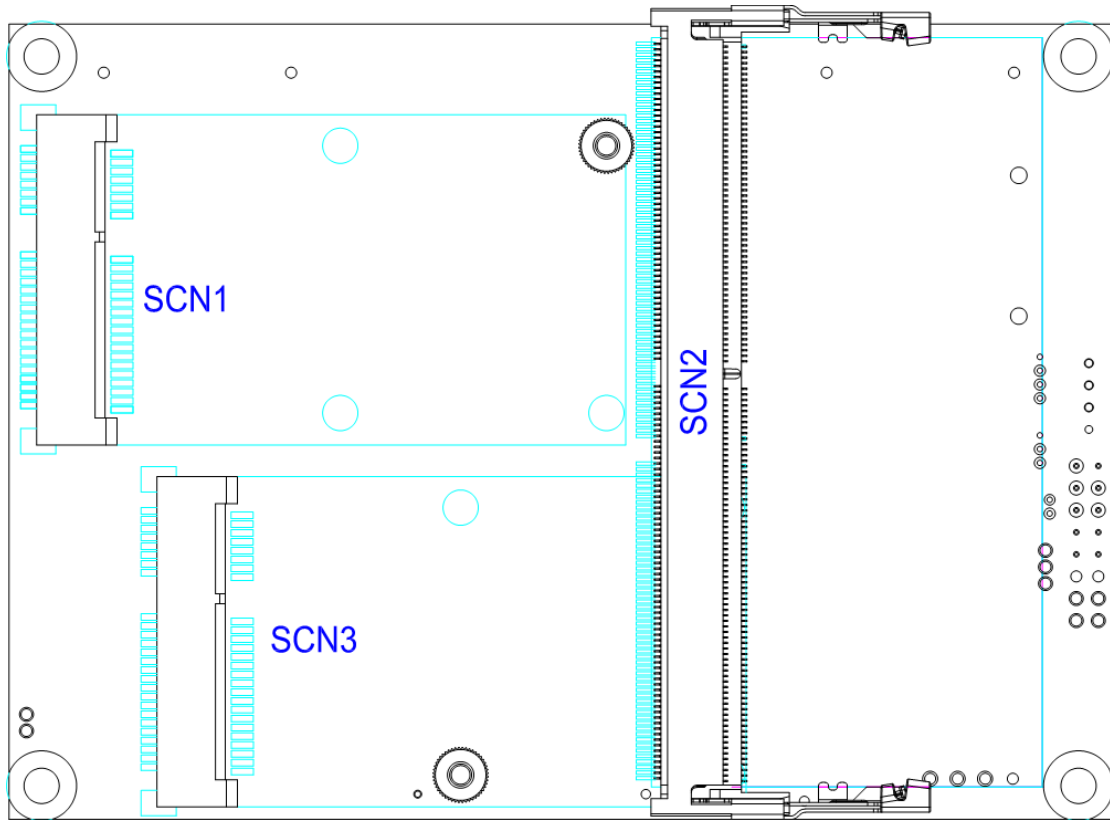

Bottom View

2.3 Assembly Drawing

For thermal dissipation, a thermal solution enables the PICO511's components to dissipate heat efficiently. All heat generating components are thermally conducted to the heatsink in order to avoid hot spots. Images below illustrate how to install the thermal solution on PICO511.

1. Heatsink for PICO511 (see image below):

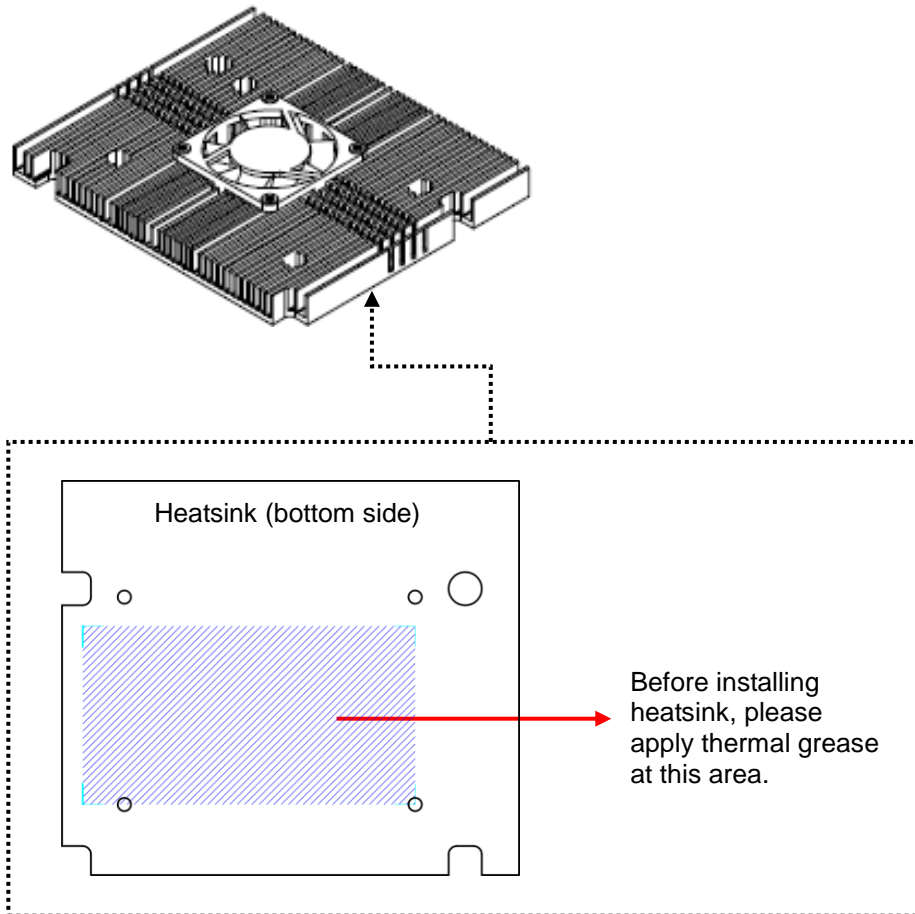

2. Heatspreader for PICO511 (see image below):

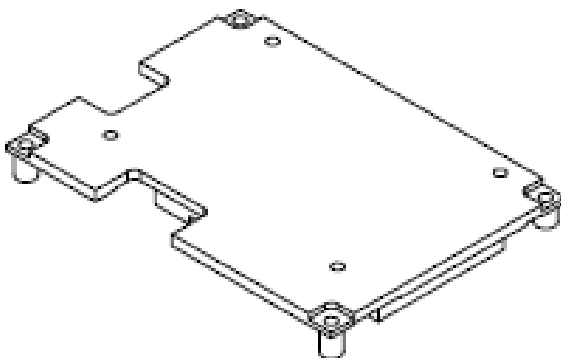

3. Use the following four screws to secure heatsink on heatspreader.

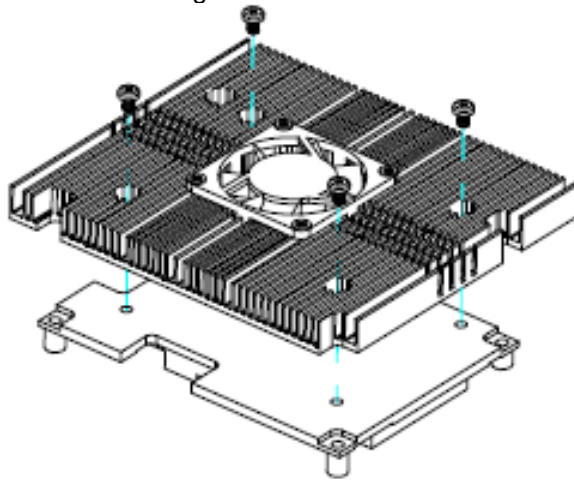

x4

4. The PICO511 has four assembly holes for installation. Align and firmly secure thermal solution and AX93A07 I/O board to PICO511. Be careful not to over-tighten the screws.

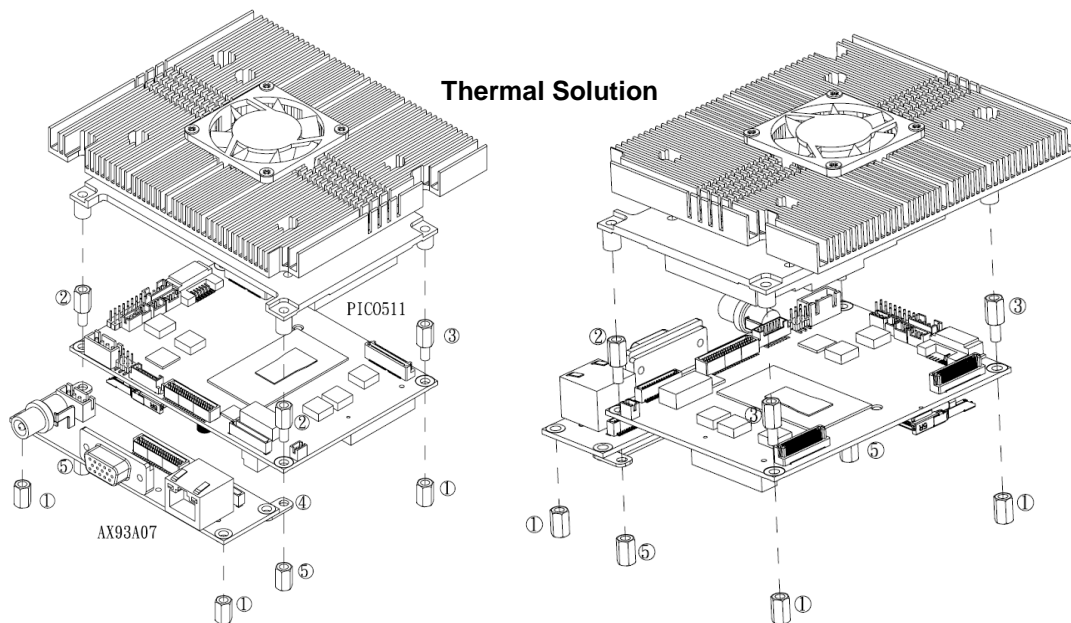

PICO511:

- ① 4pcs, 793803ZZ600E - 5H*8L*M3 Hex female copper stand-off, true color
- ② 2pcs, 79380363600E - 5H*8L*6L*M3 Hex male-female copper stand-off, true color
- ③ 2pcs, 79395363200E - 5H*9.5L*6L*M3 Hex male-female copper stand-off, nickel-plated

AX93A07:

- ④ 1pcs, 72932670100e - AX93A07 bracket
- ⑤ 2pcs, 793703ZZ600E - 5H*7L*M3 Hex female copper stand-off, true color

2.4 Jumper Settings

Jumper is a small component consisting of jumper clip and jumper pins. Install jumper clip on 2 jumper pins to close. And remove jumper clip from 2 jumper pins to open. Below illustration shows how to set up jumper.

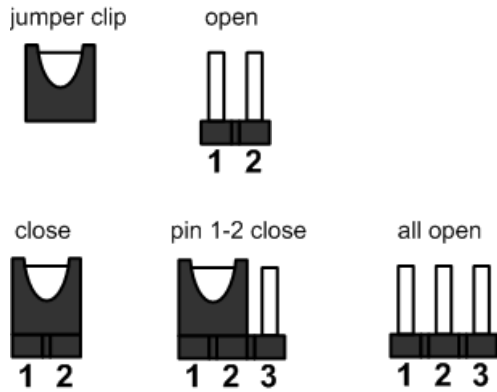

Properly configure jumper settings on the PICO511 to meet your application purpose. Below you can find a summary table of jumpers and onboard default settings.



Note

Once the default jumper setting needs to be changed, please do it under power-off condition.

Jumper	Description	Setting
JP2	Restore BIOS Optimal Defaults Default: Normal Operation	1-2 Close
JP3	Auto Power On Default: Enable	2-3 Close
JP4	LVDS Voltage Selection Default: +3.3V Level	1-2 Close

2.4.1 Restore BIOS Optimal Defaults (JP2)

Put jumper clip to pin 2-3 for a few seconds then move it back to pin 1-2. Doing this procedure can restore BIOS optimal defaults.

Function	Setting
Normal (Default)	1-2 close
Restore BIOS optimal defaults	2-3 close



2.4.2 Auto Power On (JP3)

If JP3 is enabled for power input, the system will be automatically power on without pressing soft power button. If JP3 is disabled for power input, it is necessary to manually press soft power button to power on the system.

Function	Setting
Disable auto power on	1-2 close
Enable auto power on (Default)	2-3 close



2.4.3 LVDS Voltage Selection (JP4)

The board supports voltage selection for flat panel displays. Use this jumper to set LVDS connector (CN12) pin 1~6 VCCM to +3.3V, +5V or +12V. To prevent hardware damage, before connecting please make sure that the input voltage of flat panel is correct.

Function	Setting
+3.3V level (Default)	1-2 close
+5V level	2-4 close
+12V level	5-6 close

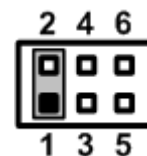

2.5 Connectors

Signals go to other parts of the system through connectors. Loose or improper connection might cause problems, please make sure all connectors are properly and firmly connected. Here is a summary table which shows all connectors on the hardware.

Connector	Description
CN2	Board to Board Connector 1 (Low Speed Signal)
CN3	Board to Board Connector 2 (High Speed Signal)
CN4	SATA Connector
CN5	USB 2.0 Wafer Connector
CN6	SATA Power Connector
CN7	I2C Connector
CN8	CMOS Battery Connector
CN9	Front Panel Connector
CN10	SMBus Connector
CN11	Fan Power Connector
CN12	LVDS Connector
CN13	Inverter Connector
CN14	Power Connector
CN15	Ethernet Connector
SCN1	Full-size PCI-Express Mini Card or mSATA Connector
SCN2	DDR4 SO-DIMM Connector
SCN3	Half-size PCI-Express Mini Card

2.5.1 Board to Board Connectors (CN2 and CN3)

CN2 is a 2x30-pin board to board connector. The pin assignments are given as follows.

Pin	Signal	Pin	Signal
1	HDA_SYNC	2	HDA_BCLK
3	HDA_SDI	4	HDA_RST
5	HDA_SDO	6	HDA_VCCIO
7	COM3_EN	8	COM4_EN
9	COM3_TERM	10	COM4_TERM
11	COM3_GPIO0	12	COM4_GPIO0
13	COM3_GPIO1	14	COM4_GPIO1
15	COM1_TERM	16	COM2_TERM
17	COM1_GPIO0	18	COM2_GPIO0
19	COM1_GPIO1	20	COM2_GPIO1
21	COM1_TERM	22	COM2_TERM
23	GND	24	N.A..
25	LPC_CLK	26	LAD3
27	FRAME	28	LAD2
29	SERIRQ	30	LAD1
31	NA	32	LAD0
33	USB_OC01	34	USB_OC23
35	GND	36	GND
37	DP0	38	DP2
39	DN0	40	DN2
41	GND	42	GND
43	DP1	44	DN3
45	DN1	46	DP3
47	GND	48	GND
49	PS_IN	50	+V5_SBY
51	HDD_LED	52	+V5_SBY
53	HW RESET	54	+V5_SBY
55	PLT_PREST	56	GND
57	+V3.3S	58	+V5S
59	+V3.3S	60	+V5S

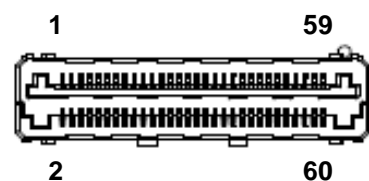

Samtec
LSHM-130-04.0-F-DV-A-N-K-TR

CN3 is a 2x30-pin board to board connector. The pin assignments are given as follows.

Pin	Signal	Pin	Signal
1	USB3_RXP1	2	PCIE_IO_RXP
3	USB3_RXN1	4	PCIE_IO_RXN
5	GND	6	GND
7	USB3_TXP1	8	PCIE_IO_TXP
9	USB3_TXN1	10	PCIE_IO_TXN
11	GND	12	GND
13	USB3_RXP2	14	B2B_PCIE_CLK
15	USB3_RXN2	16	B2B_PCIE_CLK#
17	GND	18	GND
19	USB3_TXP2	20	DDI2_TXP0
21	USB3_TXN2	22	DDI2_TXN0
23	GND	24	GND
25	USB3_RXP3	26	DDI2_TXP1
27	USB3_RXN3	28	DDI2_TXN1
29	GND	30	GND
31	USB3_TXP3	32	DDI2_TXP2
33	USB3_TXN3	34	DDI2_TXN2
35	GND	36	GND
37	USB3_RXP4	38	DDI2_TXP3
39	USB3_RXN4	40	DDI2_TXN3
41	GND	42	GND
43	USB3_TXP4	44	DDPC_CTRLDATA
45	USB3_TXN4	46	DDPC_CTRLCLK
47	GND	48	GND
49	DDPC_AUXP	50	DDPC_HPD
51	DDPC_AUXN	52	PCIE_WAKE
53	GND	54	SMB_DATA
55	+12V	56	SMB_CLK
57	+3.3V_SBY	58	+5V
59	+3.3V_SBY	60	+5V



Samtec
LSHM-130-04.0-F-DV-A-N-K-TR



Note

- *It is suggested to insert I/O board (AX93A00, AX93A01, AX93A02 or AX93A09) into CN2 and CN3 on PICO511.*
- *If the VGA or HDMI display on I/O board (AX93A00 or AX93A01) is set as primary, then the secondary (LVDS) will be disabled due to Intel® graphics limitation.*

2.5.2 SATA Connector (CN4)

This Serial Advanced Technology Attachment (Serial ATA or SATA) connector is for high speed SATA interface. It is a computer bus interface for connecting to devices such as hard disk drive.

Pin	Signal
1	GND
2	TXP
3	TXN
4	GND
5	RXN
6	RXP
7	GND

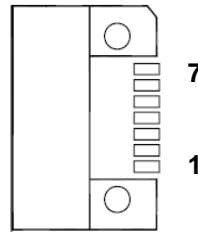

2.5.3 USB 2.0 Wafer Connector (CN5)

This is a 4-pin (pitch=1.25mm) wafer connector, which is compliant with Molex 530470410, for USB 2.0 interface.

Pin	Signal
1	USB_PWR
2	D+
3	D-
4	GND

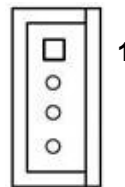

2.5.4 SATA Power Connector (CN6)

The CN6 is a 4-pin (pitch=2.0mm) wafer connector, which is compliant with JST B4B-PH-K-S, for SATA power interface.

Pin	Signal
1	+5V
2	GND
3	GND
4	+12V

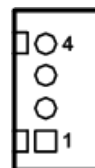

2.5.5 I2C Connector (CN7)

This is a 3-pin (pitch=1.25mm) wafer connector. The I2C is a simple bus for the purpose of lightweight communication.

Pin	Signal
1	I2C clock
2	I2C data
3	GND



2.5.6 CMOS Battery Connector (CN8)

This connector is for CMOS battery interface.

Pin	Signal
1	+3.3V
2	GND



2.5.7 Front Panel Connector (CN9)

This is a 2x5-pin (pitch=2.0mm) wafer connector.

Pin	Signal
1	GND
2	PS_ON
3	Power LED-
4	Power LED+
5	GND
6	PS_IN
7	GND
8	HW Reset
9	HDD LED-
10	HDD LED+

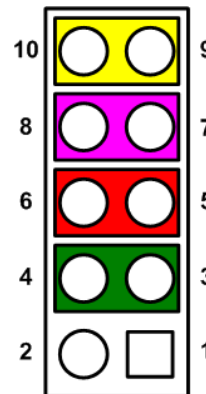

Power LED

Pin 4 connects anode (+) of LED and pin 3 connects cathode(-) of LED. The power LED lights up when the system is powered on.

Power On/Off Button

Pin 5 and 6 connect the power button on front panel to CPU board, which allows users to turn on or off power supply.

System Reset Switch

Pin 7 and 8 connect the case-mounted reset switch that reboots your computer without turning off the power switch. It is a better way to reboot your system for a longer life of system power supply.

HDD Activity LED

This connection is linked to hard drive activity LED on the control panel. LED flashes when HDD is being accessed. Pin 9 and 10 connect the hard disk drive to the front panel HDD LED, pin 9 is assigned as cathode(-) and pin 10 is assigned as anode(+).

2.5.8 SMBus Connector (CN10)

This is a 3-pin (pitch=1.5mm) wafer connector. The SMBus (System Management Bus) is a simple bus for the purpose of lightweight communication.

Pin	Signal
1	SMBus clock
2	SMBus data
3	GND

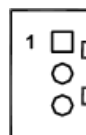

2.5.9 Fan Power Connector (CN11)

The CN11 is a 2-pin (pitch=1.5mm) wafer connector for fan power interface.

Pin	Signal
1	+5V
2	GND



2.5.10 LVDS Connector (CN12)

This board has a 2x20-pin connector for LVDS LCD interface. It is strongly recommended to use the matching JST SHDR-40VS-B connector for LVDS interface. Pin 1~6 VCCM can be set to +3.3V, +5V or +12V by setting JP4 (see section 2.4.3).

18-bit single channel

Pin	Signal	Pin	Signal
1	VCCM	2	VCCM
3	VCCM	4	VCCM
5	VCCM	6	VCCM
7	N.C	8	N.C
9	GND	10	GND
11	N.C	12	N.C
13	N.C	14	N.C
15	GND	16	GND
17	N.C	18	N.C
19	N.C	20	N.C
21	GND	22	GND
23	Channel A D0-	24	N.C
25	Channel A D0+	26	N.C
27	GND	28	GND
29	Channel A D1-	30	N.C
31	Channel A D1+	32	N.C
33	GND	34	GND
35	Channel A D2-	36	Channel A CLK-
37	Channel A D2+	38	Channel A CLK+
39	GND	40	GND

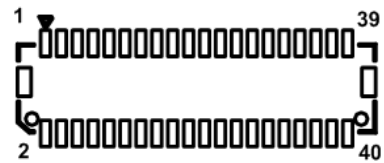

24-bit single channel

Pin	Signal	Pin	Signal
1	VCCM	2	VCCM
3	VCCM	4	VCCM
5	VCCM	6	VCCM
7	N.C	8	N.C
9	GND	10	GND
11	N.C	12	N.C
13	N.C	14	N.C
15	GND	16	GND
17	N.C	18	N.C
19	N.C	20	N.C
21	GND	22	GND
23	Channel A D0-	24	N.C
25	Channel A D0+	26	N.C
27	GND	28	GND
29	Channel A D1-	30	Channel A D3-
31	Channel A D1+	32	Channel A D3+
33	GND	34	GND
35	Channel A D2-	36	Channel A CLK-
37	Channel A D2+	38	Channel A CLK+
39	GND	40	GND

18-bit dual channel

Pin	Signal	Pin	Signal
1	VCCM	2	VCCM
3	VCCM	4	VCCM
5	VCCM	6	VCCM
7	N.C	8	N.C
9	GND	10	GND
11	N.C	12	Channel B D0-
13	N.C	14	Channel B D0+
15	GND	16	GND
17	Channel B CLK-	18	Channel B D1-
19	Channel B CLK+	20	Channel B D1+
21	GND	22	GND
23	Channel A D0-	24	Channel B D2-
25	Channel A D0+	26	Channel B D2+
27	GND	28	GND
29	Channel A D1-	30	N.C
31	Channel A D1+	32	N.C
33	GND	34	GND
35	Channel A D2-	36	Channel A CLK-
37	Channel A D2+	38	Channel A CLK+
39	GND	40	GND

24-bit dual channel

Pin	Signal	Pin	Signal
1	VCCM	2	VCCM
3	VCCM	4	VCCM
5	VCCM	6	VCCM
7	N.C	8	N.C
9	GND	10	GND
11	Channel B D3-	12	Channel B D0-
13	Channel B D3+	14	Channel B D0+
15	GND	16	GND
17	Channel B CLK-	18	Channel B D1-
19	Channel B CLK+	20	Channel B D1+
21	GND	22	GND
23	Channel A D0-	24	Channel B D2-
25	Channel A D0+	26	Channel B D2+
27	GND	28	GND
29	Channel A D1-	30	Channel A D3-
31	Channel A D1+	32	Channel A D3+
33	GND	34	GND
35	Channel A D2-	36	Channel A CLK-
37	Channel A D2+	38	Channel A CLK+
39	GND	40	GND

2.5.11 Inverter Connector (CN13)

This is DF13-8S-1.25C 8-pin connector for inverter. We strongly recommend you to use the matching DF13-8S-1.25C connector to avoid malfunction.

Pin	Signal
1	VBL1 (+12V level)
2	VBL1 (+12V level)
3	VBL2 (+5V level)
4	VBL_ENABLE
5	GND
6	GND
7	GND
8	VBL Brightness Control

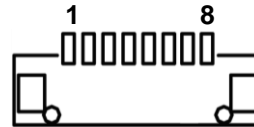

2.5.12 Power Connector (CN14)

The CN14 is a 4-pin (pitch=2.5mm) wafer connector in right angle for DC +12V input. Gently connect CN14 to AX93A07 I/O board's CN2.

Pin	Signal
1	+12V
2	+12V
3	GND
4	GND

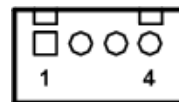

2.5.13 Ethernet Connector (CN15)

This is a JST BM16B-SRSS-TB 15-pin wafer connector for Ethernet interface. Gently connect CN15 to AX93A07 I/O board's CN1.

Pin	Signal
1	1000 LAN LED
2	100 LAN LED
3	GND
4	MDI3-
5	MDI3+
6	MDI1-
7	MDI2-
8	MDI2+
9	MDI1+
10	MDI0-
11	MDI0+
12	GND
13	LAN_VDD33
14	LAN_LINK_ACT
15	GND



2.5.14 Full-size PCI-Express Mini Card or mSATA Connector (SCN1)

This is a full-size PCI-Express Mini Card connector on the bottom side complying with PCI-Express Mini Card Spec. V1.2. It supports either PCI-Express, USB 2.0 or SATA (mSATA). To enable or disable mSATA support, please refer to BIOS setting in section 4.4.

Pin	Signal	Pin	Signal
1	WAKE#	2	+3.3VSB
3	No use	4	GND
5	No use	6	+1.5V
7	CLKREQ#	8	No use
9	GND	10	No use
11	REFCLK-	12	No use
13	REFCLK+	14	No use
15	GND	16	No use
17	No use	18	GND
19	No use	20	W_DISABLE#
21	GND	22	PERST#
23	PE_RXN/ SATA_RXP	24	+3.3VSB
25	PE_RXP/ SATA_RXN	26	GND
27	GND	28	+1.5V
29	GND	30	SMB_CLK
31	PE_TXN/ SATA_TXN	32	SMB_DATA
33	PE_TXP/ SATA_TXP	34	GND
35	GND	36	USB_D4-
37	GND	38	USB_D4+
39	+3.3VSB	40	GND
41	+3.3VSB	42	No use
43	GND	44	No use
45	No use	46	No use
47	No use	48	+1.5V
49	No use	50	GND
51	No use	52	+3.3VSB

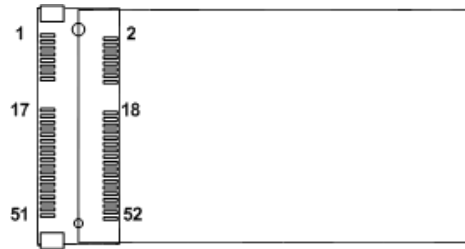

2.5.15 Half-size PCI-Express Mini Card Connector (SCN3)

This is a half-size PCI-Express Mini Card connector on the bottom side complying with PCI-Express Mini Card Spec. V1.2. It supports either PCI-Express or USB 2.0.

Pin	Signal	Pin	Signal
1	WAKE#	2	+3.3VSB
3	No use	4	GND
5	No use	6	+1.5V
7	CLKREQ#	8	No use
9	GND	10	No use
11	REFCLK-	12	No use
13	REFCLK+	14	No use
15	GND	16	No use
17	No use	18	GND
19	No use	20	W_DISABLE#
21	GND	22	PERST#
23	PE_RXN	24	+3.3VSB
25	PE_RXP	26	GND
27	GND	28	+1.5V
29	GND	30	SMB_CLK
31	PE_TXN	32	SMB_DATA
33	PE_TXP	34	GND
35	GND	36	USB_D4-
37	GND	38	USB_D4+
39	+3.3VSB	40	GND
41	+3.3VSB	42	No use
43	GND	44	No use
45	No use	46	No use
47	No use	48	+1.5V
49	No use	50	GND
51	No use	52	+3.3VSB

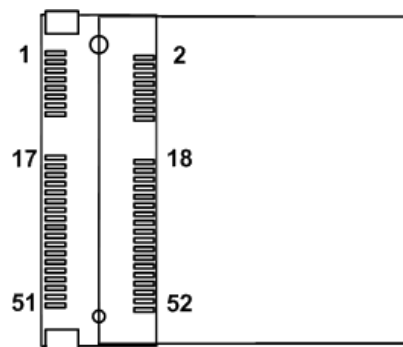

Chapter 3

Hardware Description

3.1 Microprocessors

The PICO511 supports 7th Generation Intel® Core™ i7/ i5 /i3 and Celeron® processor, which enables your system to operate under Windows® 7 and Windows® 8.1 environments. The system performance depends on the microprocessor. Make sure all correct settings are arranged for your installed microprocessor to prevent the CPU from damages.

3.2 BIOS















The PICO511 uses AMI Plug and Play BIOS with a single 128Mbit SPI Flash.

3.3 System Memory

The PICO511 supports one 260-pin DDR4 SO-DIMM socket for maximum memory capacity up to 16GB DDR4 SDRAMs. The memory module comes in sizes of 1GB, 2GB, 4GB, 8GB and 16GB.



















































3.4 I/O Port Address Map

















































▼	Input/output (IO)	
▶	[0000000000000000 - 000000000000CF7]	PCI Express Root Complex
▶	[0000000000000020 - 0000000000000021]	Programmable interrupt controller
▶	[0000000000000020 - 0000000000000021]	Programmable interrupt controller
▶	[0000000000000024 - 0000000000000025]	Programmable interrupt controller
▶	[0000000000000024 - 0000000000000025]	Programmable interrupt controller
▶	[0000000000000028 - 0000000000000029]	Programmable interrupt controller
▶	[0000000000000028 - 0000000000000029]	Programmable interrupt controller
▶	[000000000000002C - 000000000000002D]	Programmable interrupt controller
▶	[000000000000002C - 000000000000002D]	Programmable interrupt controller
▶	[000000000000002E - 000000000000002F]	Motherboard resources
▶	[0000000000000030 - 0000000000000031]	Programmable interrupt controller
▶	[0000000000000030 - 0000000000000031]	Programmable interrupt controller
▶	[0000000000000034 - 0000000000000035]	Programmable interrupt controller
▶	[0000000000000034 - 0000000000000035]	Programmable interrupt controller
▶	[0000000000000038 - 0000000000000039]	Programmable interrupt controller
▶	[0000000000000038 - 0000000000000039]	Programmable interrupt controller
▶	[000000000000003C - 000000000000003D]	Programmable interrupt controller
▶	[000000000000003C - 000000000000003D]	Programmable interrupt controller
▶	[0000000000000040 - 0000000000000043]	System timer
▶	[0000000000000040 - 0000000000000043]	System timer
▶	[000000000000004E - 000000000000004F]	Motherboard resources
▶	[0000000000000050 - 0000000000000053]	System timer
▶	[0000000000000050 - 0000000000000053]	System timer
▶	[0000000000000061 - 0000000000000061]	Motherboard resources
▶	[0000000000000063 - 0000000000000063]	Motherboard resources
▶	[0000000000000065 - 0000000000000065]	Motherboard resources
▶	[0000000000000067 - 0000000000000067]	Motherboard resources
▶	[0000000000000070 - 0000000000000070]	Motherboard resources
▶	[0000000000000070 - 0000000000000077]	System CMOS/real time clock
▶	[0000000000000070 - 0000000000000077]	System CMOS/real time clock
▶	[0000000000000080 - 0000000000000080]	Motherboard resources
▶	[0000000000000092 - 0000000000000092]	Motherboard resources
▶	[00000000000000A0 - 00000000000000A1]	Programmable interrupt controller
▶	[00000000000000A0 - 00000000000000A1]	Programmable interrupt controller
▶	[00000000000000A4 - 00000000000000A5]	Programmable interrupt controller
▶	[00000000000000A4 - 00000000000000A5]	Programmable interrupt controller
▶	[00000000000000A8 - 00000000000000A9]	Programmable interrupt controller
▶	[00000000000000A8 - 00000000000000A9]	Programmable interrupt controller
▶	[00000000000000AC - 00000000000000AD]	Programmable interrupt controller
▶	[00000000000000AC - 00000000000000AD]	Programmable interrupt controller
▶	[00000000000000B0 - 00000000000000B1]	Programmable interrupt controller
▶	[00000000000000B0 - 00000000000000B1]	Programmable interrupt controller
▶	[00000000000000B2 - 00000000000000B3]	Motherboard resources
▶	[00000000000000B4 - 00000000000000B5]	Programmable interrupt controller
▶	[00000000000000B4 - 00000000000000B5]	Programmable interrupt controller
▶	[00000000000000B8 - 00000000000000B9]	Programmable interrupt controller
▶	[00000000000000B8 - 00000000000000B9]	Programmable interrupt controller
▶	[00000000000000BC - 00000000000000BD]	Programmable interrupt controller
▶	[00000000000000BC - 00000000000000BD]	Programmable interrupt controller

















































-  [0000000000002F8 - 0000000000002FF] Communications Port (COM2)
-  [0000000000003B0 - 0000000000003BB] Intel(R) HD Graphics 620
-  [0000000000003C0 - 0000000000003DF] Intel(R) HD Graphics 620
-  [0000000000003F8 - 0000000000003FF] Communications Port (COM1)
-  [0000000000004D0 - 0000000000004D1] Programmable interrupt controller
-  [0000000000004D0 - 0000000000004D1] Programmable interrupt controller
-  [000000000000680 - 00000000000069F] Motherboard resources
-  [000000000000D00 - 000000000000FFF] PCI Express Root Complex
-  [00000000000164E - 00000000000164F] Motherboard resources
-  [000000000001800 - 0000000000018FE] Motherboard resources
-  [000000000001854 - 000000000001857] Motherboard resources
-  [000000000001854 - 000000000001857] Motherboard resources
-  [000000000000E00 - 000000000000E0F] Ethernet Controller
-  [000000000000E00 - 000000000000E0F] Intel(R) I210 Gigabit Network Connection
-  [000000000000E00 - 000000000000E0F] Intel(R) I210 Gigabit Network Connection #2
-  [000000000000E00 - 000000000000FFF] Mobile 6th/7th Generation Intel(R) Processor Family I/O PCI Express Root Port #3 - 9D12
-  [000000000000F00 - 000000000000F03F] Intel(R) HD Graphics 520
-  [000000000000F00 - 000000000000F03F] Intel(R) HD Graphics 620
-  [000000000000F040 - 000000000000F05F] Mobile 6th/7th Generation Intel(R) Processor Family I/O SMBUS - 9D23
-  [000000000000F060 - 000000000000F07F] Standard SATA AHCI Controller
-  [000000000000F080 - 000000000000F083] Standard SATA AHCI Controller
-  [000000000000F090 - 000000000000F097] Standard SATA AHCI Controller
-  [000000000000F0A0 - 000000000000F0A7] Intel(R) Active Management Technology - SOL (COM3)
-  [000000000000FF0 - 000000000000FFE] Motherboard resources
-  [000000000000FFF - 000000000000FFF] Motherboard resources
-  [000000000000FFF - 000000000000FFF] Motherboard resources
-  [000000000000FFF - 000000000000FFF] Motherboard resources

















































3.5 Interrupt Controller (IRQ) Map

















































The interrupt controller (IRQ) mapping list is shown as follows:

















































- ▼  Interrupt request (IRQ)
 -  (ISA) 0x00000000 (00) System timer
 -  (ISA) 0x00000000 (00) System timer
 -  (ISA) 0x00000003 (03) Communications Port (COM2)
 -  (ISA) 0x00000004 (04) Communications Port (COM1)
 -  (ISA) 0x00000008 (08) System CMOS/real time clock
 -  (ISA) 0x00000008 (08) System CMOS/real time clock
 -  (ISA) 0x0000000A (10) Intel SD Host Controller
 -  (ISA) 0x0000000A (10) Intel(R) Dual Band Wireless-AC 7260
 -  (ISA) 0x0000000A (10) Mobile 6th/7th Generation Intel(R) Processor Family I/O PCI Express Root Port #6 - 9D15
 -  (ISA) 0x0000000B (11) Ethernet Controller
 -  (ISA) 0x0000000B (11) High Definition Audio Controller
 -  (ISA) 0x0000000B (11) Intel SD Host Controller
 -  (ISA) 0x0000000B (11) Intel(R) CSI2 Host Controller
 -  (ISA) 0x0000000B (11) Intel(R) HD Graphics 520
 -  (ISA) 0x0000000B (11) Intel(R) I210 Gigabit Network Connection
 -  (ISA) 0x0000000B (11) Intel(R) I210 Gigabit Network Connection #2
 -  (ISA) 0x0000000B (11) Mobile 6th/7th Generation Intel(R) Processor Family I/O PCI Express Root Port #3 - 9D12
 -  (ISA) 0x0000000B (11) Mobile 6th/7th Generation Intel(R) Processor Family I/O PCI Express Root Port #3 - 9D12
 -  (ISA) 0x0000000B (11) Mobile 6th/7th Generation Intel(R) Processor Family I/O PCI Express Root Port #5 - 9D14
 -  (ISA) 0x0000000B (11) Mobile 6th/7th Generation Intel(R) Processor Family I/O PCI Express Root Port #5 - 9D14
 -  (ISA) 0x0000000B (11) Mobile 6th/7th Generation Intel(R) Processor Family I/O PCI Express Root Port #4 - 9D13
 -  (ISA) 0x0000000B (11) Mobile 6th/7th Generation Intel(R) Processor Family I/O PCI Express Root Port #1 - 9D10
 -  (ISA) 0x0000000B (11) Standard SATA AHCI Controller
 -  (ISA) 0x0000000E (14) Intel(R) Serial IO GPIO Host Controller - INT344B
 -  (ISA) 0x0000000E (14) Motherboard resources
 -  (ISA) 0x00000036 (54) Microsoft ACPI-Compliant System
 -  (ISA) 0x00000037 (55) Microsoft ACPI-Compliant System
 -  (ISA) 0x00000038 (56) Microsoft ACPI-Compliant System
 -  (ISA) 0x00000039 (57) Microsoft ACPI-Compliant System
 -  (ISA) 0x0000003A (58) Microsoft ACPI-Compliant System
 -  (ISA) 0x0000003B (59) Microsoft ACPI-Compliant System
 -  (ISA) 0x0000003C (60) Microsoft ACPI-Compliant System
 -  (ISA) 0x0000003D (61) Microsoft ACPI-Compliant System
 -  (ISA) 0x0000003E (62) Microsoft ACPI-Compliant System
 -  (ISA) 0x0000003F (63) Microsoft ACPI-Compliant System
 -  (ISA) 0x00000040 (64) Microsoft ACPI-Compliant System
 -  (ISA) 0x00000041 (65) Microsoft ACPI-Compliant System
 -  (ISA) 0x00000042 (66) Microsoft ACPI-Compliant System
 -  (ISA) 0x00000043 (67) Microsoft ACPI-Compliant System
 -  (ISA) 0x00000044 (68) Microsoft ACPI-Compliant System
 -  (ISA) 0x00000045 (69) Microsoft ACPI-Compliant System
 -  (ISA) 0x00000046 (70) Microsoft ACPI-Compliant System
 -  (ISA) 0x00000047 (71) Microsoft ACPI-Compliant System
 -  (ISA) 0x00000048 (72) Microsoft ACPI-Compliant System
 -  (ISA) 0x00000049 (73) Microsoft ACPI-Compliant System
 -  (ISA) 0x0000004A (74) Microsoft ACPI-Compliant System
 -  (ISA) 0x0000004B (75) Microsoft ACPI-Compliant System
 -  (ISA) 0x0000004C (76) Microsoft ACPI-Compliant System
 -  (ISA) 0x0000004D (77) Microsoft ACPI-Compliant System

















































 (ISA) 0x0000004E (78)	Microsoft ACPI-Compliant System
 (ISA) 0x0000004F (79)	Microsoft ACPI-Compliant System
 (ISA) 0x00000050 (80)	Microsoft ACPI-Compliant System
 (ISA) 0x00000051 (81)	Microsoft ACPI-Compliant System
 (ISA) 0x00000052 (82)	Microsoft ACPI-Compliant System
 (ISA) 0x00000053 (83)	Microsoft ACPI-Compliant System
 (ISA) 0x00000054 (84)	Microsoft ACPI-Compliant System
 (ISA) 0x00000055 (85)	Microsoft ACPI-Compliant System
 (ISA) 0x00000056 (86)	Microsoft ACPI-Compliant System
 (ISA) 0x00000057 (87)	Microsoft ACPI-Compliant System
 (ISA) 0x00000058 (88)	Microsoft ACPI-Compliant System
 (ISA) 0x00000059 (89)	Microsoft ACPI-Compliant System
 (ISA) 0x0000005A (90)	Microsoft ACPI-Compliant System
 (ISA) 0x0000005B (91)	Microsoft ACPI-Compliant System
 (ISA) 0x0000005C (92)	Microsoft ACPI-Compliant System
 (ISA) 0x0000005D (93)	Microsoft ACPI-Compliant System
 (ISA) 0x0000005E (94)	Microsoft ACPI-Compliant System
 (ISA) 0x0000005F (95)	Microsoft ACPI-Compliant System
 (ISA) 0x00000060 (96)	Microsoft ACPI-Compliant System
 (ISA) 0x00000061 (97)	Microsoft ACPI-Compliant System
 (ISA) 0x00000062 (98)	Microsoft ACPI-Compliant System
 (ISA) 0x00000063 (99)	Microsoft ACPI-Compliant System
 (ISA) 0x00000064 (100)	Microsoft ACPI-Compliant System
 (ISA) 0x00000065 (101)	Microsoft ACPI-Compliant System
 (ISA) 0x00000066 (102)	Microsoft ACPI-Compliant System
 (ISA) 0x00000067 (103)	Microsoft ACPI-Compliant System
 (ISA) 0x00000068 (104)	Microsoft ACPI-Compliant System
 (ISA) 0x00000069 (105)	Microsoft ACPI-Compliant System
 (ISA) 0x0000006A (106)	Microsoft ACPI-Compliant System
 (ISA) 0x0000006B (107)	Microsoft ACPI-Compliant System
 (ISA) 0x0000006C (108)	Microsoft ACPI-Compliant System
 (ISA) 0x0000006D (109)	Microsoft ACPI-Compliant System
 (ISA) 0x0000006E (110)	Microsoft ACPI-Compliant System
 (ISA) 0x0000006F (111)	Microsoft ACPI-Compliant System
 (ISA) 0x00000070 (112)	Microsoft ACPI-Compliant System
 (ISA) 0x00000071 (113)	Microsoft ACPI-Compliant System
 (ISA) 0x00000072 (114)	Microsoft ACPI-Compliant System
 (ISA) 0x00000073 (115)	Microsoft ACPI-Compliant System
 (ISA) 0x00000074 (116)	Microsoft ACPI-Compliant System
 (ISA) 0x00000075 (117)	Microsoft ACPI-Compliant System
 (ISA) 0x00000076 (118)	Microsoft ACPI-Compliant System
 (ISA) 0x00000077 (119)	Microsoft ACPI-Compliant System
 (ISA) 0x00000078 (120)	Microsoft ACPI-Compliant System
 (ISA) 0x00000079 (121)	Microsoft ACPI-Compliant System
 (ISA) 0x0000007A (122)	Microsoft ACPI-Compliant System
 (ISA) 0x0000007B (123)	Microsoft ACPI-Compliant System
 (ISA) 0x0000007C (124)	Microsoft ACPI-Compliant System
 (ISA) 0x0000007D (125)	Microsoft ACPI-Compliant System
 (ISA) 0x0000007E (126)	Microsoft ACPI-Compliant System





















































 (ISA) 0x0000007F (127)	Microsoft ACPI-Compliant System
 (ISA) 0x00000080 (128)	Microsoft ACPI-Compliant System
 (ISA) 0x00000081 (129)	Microsoft ACPI-Compliant System
 (ISA) 0x00000082 (130)	Microsoft ACPI-Compliant System
 (ISA) 0x00000083 (131)	Microsoft ACPI-Compliant System
 (ISA) 0x00000084 (132)	Microsoft ACPI-Compliant System
 (ISA) 0x00000085 (133)	Microsoft ACPI-Compliant System
 (ISA) 0x00000086 (134)	Microsoft ACPI-Compliant System
 (ISA) 0x00000087 (135)	Microsoft ACPI-Compliant System
 (ISA) 0x00000088 (136)	Microsoft ACPI-Compliant System
 (ISA) 0x00000089 (137)	Microsoft ACPI-Compliant System
 (ISA) 0x0000008A (138)	Microsoft ACPI-Compliant System
 (ISA) 0x0000008B (139)	Microsoft ACPI-Compliant System
 (ISA) 0x0000008C (140)	Microsoft ACPI-Compliant System
 (ISA) 0x0000008D (141)	Microsoft ACPI-Compliant System
 (ISA) 0x0000008E (142)	Microsoft ACPI-Compliant System
 (ISA) 0x0000008F (143)	Microsoft ACPI-Compliant System
 (ISA) 0x00000090 (144)	Microsoft ACPI-Compliant System
 (ISA) 0x00000091 (145)	Microsoft ACPI-Compliant System
 (ISA) 0x00000092 (146)	Microsoft ACPI-Compliant System
 (ISA) 0x00000093 (147)	Microsoft ACPI-Compliant System
 (ISA) 0x00000094 (148)	Microsoft ACPI-Compliant System
 (ISA) 0x00000095 (149)	Microsoft ACPI-Compliant System
 (ISA) 0x00000096 (150)	Microsoft ACPI-Compliant System
 (ISA) 0x00000097 (151)	Microsoft ACPI-Compliant System
 (ISA) 0x00000098 (152)	Microsoft ACPI-Compliant System
 (ISA) 0x00000099 (153)	Microsoft ACPI-Compliant System
 (ISA) 0x0000009A (154)	Microsoft ACPI-Compliant System
 (ISA) 0x0000009B (155)	Microsoft ACPI-Compliant System
 (ISA) 0x0000009C (156)	Microsoft ACPI-Compliant System
 (ISA) 0x0000009D (157)	Microsoft ACPI-Compliant System
 (ISA) 0x0000009E (158)	Microsoft ACPI-Compliant System
 (ISA) 0x0000009F (159)	Microsoft ACPI-Compliant System
 (ISA) 0x000000A0 (160)	Microsoft ACPI-Compliant System
 (ISA) 0x000000A1 (161)	Microsoft ACPI-Compliant System
 (ISA) 0x000000A2 (162)	Microsoft ACPI-Compliant System
 (ISA) 0x000000A3 (163)	Microsoft ACPI-Compliant System
 (ISA) 0x000000A4 (164)	Microsoft ACPI-Compliant System
 (ISA) 0x000000A5 (165)	Microsoft ACPI-Compliant System
 (ISA) 0x000000A6 (166)	Microsoft ACPI-Compliant System
 (ISA) 0x000000A7 (167)	Microsoft ACPI-Compliant System
 (ISA) 0x000000A8 (168)	Microsoft ACPI-Compliant System
 (ISA) 0x000000A9 (169)	Microsoft ACPI-Compliant System
 (ISA) 0x000000AA (170)	Microsoft ACPI-Compliant System
 (ISA) 0x000000AB (171)	Microsoft ACPI-Compliant System
 (ISA) 0x000000AC (172)	Microsoft ACPI-Compliant System
 (ISA) 0x000000AD (173)	Microsoft ACPI-Compliant System
 (ISA) 0x000000AE (174)	Microsoft ACPI-Compliant System
 (ISA) 0x000000AF (175)	Microsoft ACPI-Compliant System



















































 (ISA) 0x000000B0 (176)	Microsoft ACPI-Compliant System
 (ISA) 0x000000B1 (177)	Microsoft ACPI-Compliant System
 (ISA) 0x000000B2 (178)	Microsoft ACPI-Compliant System
 (ISA) 0x000000B3 (179)	Microsoft ACPI-Compliant System
 (ISA) 0x000000B4 (180)	Microsoft ACPI-Compliant System
 (ISA) 0x000000B5 (181)	Microsoft ACPI-Compliant System
 (ISA) 0x000000B6 (182)	Microsoft ACPI-Compliant System
 (ISA) 0x000000B7 (183)	Microsoft ACPI-Compliant System
 (ISA) 0x000000B8 (184)	Microsoft ACPI-Compliant System
 (ISA) 0x000000B9 (185)	Microsoft ACPI-Compliant System
 (ISA) 0x000000BA (186)	Microsoft ACPI-Compliant System
 (ISA) 0x000000BB (187)	Microsoft ACPI-Compliant System
 (ISA) 0x000000BC (188)	Microsoft ACPI-Compliant System
 (ISA) 0x000000BD (189)	Microsoft ACPI-Compliant System
 (ISA) 0x000000BE (190)	Microsoft ACPI-Compliant System
 (ISA) 0x000000BF (191)	Microsoft ACPI-Compliant System
 (ISA) 0x000000C0 (192)	Microsoft ACPI-Compliant System
 (ISA) 0x000000C1 (193)	Microsoft ACPI-Compliant System
 (ISA) 0x000000C2 (194)	Microsoft ACPI-Compliant System
 (ISA) 0x000000C3 (195)	Microsoft ACPI-Compliant System
 (ISA) 0x000000C4 (196)	Microsoft ACPI-Compliant System
 (ISA) 0x000000C5 (197)	Microsoft ACPI-Compliant System
 (ISA) 0x000000C6 (198)	Microsoft ACPI-Compliant System
 (ISA) 0x000000C7 (199)	Microsoft ACPI-Compliant System
 (ISA) 0x000000C8 (200)	Microsoft ACPI-Compliant System
 (ISA) 0x000000C9 (201)	Microsoft ACPI-Compliant System
 (ISA) 0x000000CA (202)	Microsoft ACPI-Compliant System
 (ISA) 0x000000CB (203)	Microsoft ACPI-Compliant System
 (ISA) 0x000000CC (204)	Microsoft ACPI-Compliant System
 (ISA) 0x00000100 (256)	Microsoft ACPI-Compliant System
 (ISA) 0x00000101 (257)	Microsoft ACPI-Compliant System
 (ISA) 0x00000102 (258)	Microsoft ACPI-Compliant System
 (ISA) 0x00000103 (259)	Microsoft ACPI-Compliant System
 (ISA) 0x00000104 (260)	Microsoft ACPI-Compliant System
 (ISA) 0x00000105 (261)	Microsoft ACPI-Compliant System
 (ISA) 0x00000106 (262)	Microsoft ACPI-Compliant System
 (ISA) 0x00000107 (263)	Microsoft ACPI-Compliant System
 (ISA) 0x00000108 (264)	Microsoft ACPI-Compliant System
 (ISA) 0x00000109 (265)	Microsoft ACPI-Compliant System
 (ISA) 0x0000010A (266)	Microsoft ACPI-Compliant System
 (ISA) 0x0000010B (267)	Microsoft ACPI-Compliant System
 (ISA) 0x0000010C (268)	Microsoft ACPI-Compliant System
 (ISA) 0x0000010D (269)	Microsoft ACPI-Compliant System
 (ISA) 0x0000010E (270)	Microsoft ACPI-Compliant System
 (ISA) 0x0000010F (271)	Microsoft ACPI-Compliant System
 (ISA) 0x00000110 (272)	Microsoft ACPI-Compliant System
 (ISA) 0x00000111 (273)	Microsoft ACPI-Compliant System
 (ISA) 0x00000112 (274)	Microsoft ACPI-Compliant System

 (ISA) 0x00000113 (275)	Microsoft ACPI-Compliant System
 (ISA) 0x00000114 (276)	Microsoft ACPI-Compliant System
 (ISA) 0x00000115 (277)	Microsoft ACPI-Compliant System
 (ISA) 0x00000116 (278)	Microsoft ACPI-Compliant System
 (ISA) 0x00000117 (279)	Microsoft ACPI-Compliant System
 (ISA) 0x00000118 (280)	Microsoft ACPI-Compliant System
 (ISA) 0x00000119 (281)	Microsoft ACPI-Compliant System
 (ISA) 0x0000011A (282)	Microsoft ACPI-Compliant System
 (ISA) 0x0000011B (283)	Microsoft ACPI-Compliant System
 (ISA) 0x0000011C (284)	Microsoft ACPI-Compliant System
 (ISA) 0x0000011D (285)	Microsoft ACPI-Compliant System
 (ISA) 0x0000011E (286)	Microsoft ACPI-Compliant System
 (ISA) 0x0000011F (287)	Microsoft ACPI-Compliant System
 (ISA) 0x00000120 (288)	Microsoft ACPI-Compliant System
 (ISA) 0x00000121 (289)	Microsoft ACPI-Compliant System
 (ISA) 0x00000122 (290)	Microsoft ACPI-Compliant System
 (ISA) 0x00000123 (291)	Microsoft ACPI-Compliant System
 (ISA) 0x00000124 (292)	Microsoft ACPI-Compliant System
 (ISA) 0x00000125 (293)	Microsoft ACPI-Compliant System
 (ISA) 0x00000126 (294)	Microsoft ACPI-Compliant System
 (ISA) 0x00000127 (295)	Microsoft ACPI-Compliant System
 (ISA) 0x00000128 (296)	Microsoft ACPI-Compliant System
 (ISA) 0x00000129 (297)	Microsoft ACPI-Compliant System
 (ISA) 0x0000012A (298)	Microsoft ACPI-Compliant System
 (ISA) 0x0000012B (299)	Microsoft ACPI-Compliant System
 (ISA) 0x0000012C (300)	Microsoft ACPI-Compliant System
 (ISA) 0x0000012D (301)	Microsoft ACPI-Compliant System
 (ISA) 0x0000012E (302)	Microsoft ACPI-Compliant System
 (ISA) 0x0000012F (303)	Microsoft ACPI-Compliant System
 (ISA) 0x00000130 (304)	Microsoft ACPI-Compliant System
 (ISA) 0x00000131 (305)	Microsoft ACPI-Compliant System
 (ISA) 0x00000132 (306)	Microsoft ACPI-Compliant System
 (ISA) 0x00000133 (307)	Microsoft ACPI-Compliant System
 (ISA) 0x00000134 (308)	Microsoft ACPI-Compliant System
 (ISA) 0x00000135 (309)	Microsoft ACPI-Compliant System
 (ISA) 0x00000136 (310)	Microsoft ACPI-Compliant System
 (ISA) 0x00000137 (311)	Microsoft ACPI-Compliant System
 (ISA) 0x00000138 (312)	Microsoft ACPI-Compliant System
 (ISA) 0x00000139 (313)	Microsoft ACPI-Compliant System
 (ISA) 0x0000013A (314)	Microsoft ACPI-Compliant System
 (ISA) 0x0000013B (315)	Microsoft ACPI-Compliant System
 (ISA) 0x0000013C (316)	Microsoft ACPI-Compliant System
 (ISA) 0x0000013D (317)	Microsoft ACPI-Compliant System
 (ISA) 0x0000013E (318)	Microsoft ACPI-Compliant System
 (ISA) 0x0000013F (319)	Microsoft ACPI-Compliant System
 (ISA) 0x00000140 (320)	Microsoft ACPI-Compliant System
 (ISA) 0x00000141 (321)	Microsoft ACPI-Compliant System
 (ISA) 0x00000142 (322)	Microsoft ACPI-Compliant System

	(ISA) 0x00000143 (323)	Microsoft ACPI-Compliant System
	(ISA) 0x00000144 (324)	Microsoft ACPI-Compliant System
	(ISA) 0x00000145 (325)	Microsoft ACPI-Compliant System
	(ISA) 0x00000146 (326)	Microsoft ACPI-Compliant System
	(ISA) 0x00000147 (327)	Microsoft ACPI-Compliant System
	(ISA) 0x00000148 (328)	Microsoft ACPI-Compliant System
	(ISA) 0x00000149 (329)	Microsoft ACPI-Compliant System
	(ISA) 0x0000014A (330)	Microsoft ACPI-Compliant System
	(ISA) 0x0000014B (331)	Microsoft ACPI-Compliant System
	(ISA) 0x0000014C (332)	Microsoft ACPI-Compliant System
	(ISA) 0x0000014D (333)	Microsoft ACPI-Compliant System
	(ISA) 0x0000014E (334)	Microsoft ACPI-Compliant System
	(ISA) 0x0000014F (335)	Microsoft ACPI-Compliant System
	(ISA) 0x00000150 (336)	Microsoft ACPI-Compliant System
	(ISA) 0x00000151 (337)	Microsoft ACPI-Compliant System
	(ISA) 0x00000152 (338)	Microsoft ACPI-Compliant System
	(ISA) 0x00000153 (339)	Microsoft ACPI-Compliant System
	(ISA) 0x00000154 (340)	Microsoft ACPI-Compliant System
	(ISA) 0x00000155 (341)	Microsoft ACPI-Compliant System
	(ISA) 0x00000156 (342)	Microsoft ACPI-Compliant System
	(ISA) 0x00000157 (343)	Microsoft ACPI-Compliant System
	(ISA) 0x00000158 (344)	Microsoft ACPI-Compliant System
	(ISA) 0x00000159 (345)	Microsoft ACPI-Compliant System
	(ISA) 0x0000015A (346)	Microsoft ACPI-Compliant System
	(ISA) 0x0000015B (347)	Microsoft ACPI-Compliant System
	(ISA) 0x0000015C (348)	Microsoft ACPI-Compliant System
	(ISA) 0x0000015D (349)	Microsoft ACPI-Compliant System
	(ISA) 0x0000015E (350)	Microsoft ACPI-Compliant System
	(ISA) 0x0000015F (351)	Microsoft ACPI-Compliant System
	(ISA) 0x00000160 (352)	Microsoft ACPI-Compliant System
	(ISA) 0x00000161 (353)	Microsoft ACPI-Compliant System
	(ISA) 0x00000162 (354)	Microsoft ACPI-Compliant System
	(ISA) 0x00000163 (355)	Microsoft ACPI-Compliant System
	(ISA) 0x00000164 (356)	Microsoft ACPI-Compliant System
	(ISA) 0x00000165 (357)	Microsoft ACPI-Compliant System
	(ISA) 0x00000166 (358)	Microsoft ACPI-Compliant System
	(ISA) 0x00000167 (359)	Microsoft ACPI-Compliant System
	(ISA) 0x00000168 (360)	Microsoft ACPI-Compliant System
	(ISA) 0x00000169 (361)	Microsoft ACPI-Compliant System
	(ISA) 0x0000016A (362)	Microsoft ACPI-Compliant System
	(ISA) 0x0000016B (363)	Microsoft ACPI-Compliant System
	(ISA) 0x0000016C (364)	Microsoft ACPI-Compliant System
	(ISA) 0x0000016D (365)	Microsoft ACPI-Compliant System
	(ISA) 0x0000016E (366)	Microsoft ACPI-Compliant System
	(ISA) 0x0000016F (367)	Microsoft ACPI-Compliant System
	(ISA) 0x00000170 (368)	Microsoft ACPI-Compliant System
	(ISA) 0x00000171 (369)	Microsoft ACPI-Compliant System
	(ISA) 0x00000172 (370)	Microsoft ACPI-Compliant System

	(ISA) 0x00000173 (371)	Microsoft ACPI-Compliant System
	(ISA) 0x00000174 (372)	Microsoft ACPI-Compliant System
	(ISA) 0x00000175 (373)	Microsoft ACPI-Compliant System
	(ISA) 0x00000176 (374)	Microsoft ACPI-Compliant System
	(ISA) 0x00000177 (375)	Microsoft ACPI-Compliant System
	(ISA) 0x00000178 (376)	Microsoft ACPI-Compliant System
	(ISA) 0x00000179 (377)	Microsoft ACPI-Compliant System
	(ISA) 0x0000017A (378)	Microsoft ACPI-Compliant System
	(ISA) 0x0000017B (379)	Microsoft ACPI-Compliant System
	(ISA) 0x0000017C (380)	Microsoft ACPI-Compliant System
	(ISA) 0x0000017D (381)	Microsoft ACPI-Compliant System
	(ISA) 0x0000017E (382)	Microsoft ACPI-Compliant System
	(ISA) 0x0000017F (383)	Microsoft ACPI-Compliant System
	(ISA) 0x00000180 (384)	Microsoft ACPI-Compliant System
	(ISA) 0x00000181 (385)	Microsoft ACPI-Compliant System
	(ISA) 0x00000182 (386)	Microsoft ACPI-Compliant System
	(ISA) 0x00000183 (387)	Microsoft ACPI-Compliant System
	(ISA) 0x00000184 (388)	Microsoft ACPI-Compliant System
	(ISA) 0x00000185 (389)	Microsoft ACPI-Compliant System
	(ISA) 0x00000186 (390)	Microsoft ACPI-Compliant System
	(ISA) 0x00000187 (391)	Microsoft ACPI-Compliant System
	(ISA) 0x00000188 (392)	Microsoft ACPI-Compliant System
	(ISA) 0x00000189 (393)	Microsoft ACPI-Compliant System
	(ISA) 0x0000018A (394)	Microsoft ACPI-Compliant System
	(ISA) 0x0000018B (395)	Microsoft ACPI-Compliant System
	(ISA) 0x0000018C (396)	Microsoft ACPI-Compliant System
	(ISA) 0x0000018D (397)	Microsoft ACPI-Compliant System
	(ISA) 0x0000018E (398)	Microsoft ACPI-Compliant System
	(ISA) 0x0000018F (399)	Microsoft ACPI-Compliant System
	(ISA) 0x00000190 (400)	Microsoft ACPI-Compliant System
	(ISA) 0x00000191 (401)	Microsoft ACPI-Compliant System
	(ISA) 0x00000192 (402)	Microsoft ACPI-Compliant System
	(ISA) 0x00000193 (403)	Microsoft ACPI-Compliant System
	(ISA) 0x00000194 (404)	Microsoft ACPI-Compliant System
	(ISA) 0x00000195 (405)	Microsoft ACPI-Compliant System
	(ISA) 0x00000196 (406)	Microsoft ACPI-Compliant System
	(ISA) 0x00000197 (407)	Microsoft ACPI-Compliant System
	(ISA) 0x00000198 (408)	Microsoft ACPI-Compliant System
	(ISA) 0x00000199 (409)	Microsoft ACPI-Compliant System
	(ISA) 0x0000019A (410)	Microsoft ACPI-Compliant System
	(ISA) 0x0000019B (411)	Microsoft ACPI-Compliant System
	(ISA) 0x0000019C (412)	Microsoft ACPI-Compliant System
	(ISA) 0x0000019D (413)	Microsoft ACPI-Compliant System
	(ISA) 0x0000019E (414)	Microsoft ACPI-Compliant System
	(ISA) 0x0000019F (415)	Microsoft ACPI-Compliant System
	(ISA) 0x000001A0 (416)	Microsoft ACPI-Compliant System
	(ISA) 0x000001A1 (417)	Microsoft ACPI-Compliant System
	(ISA) 0x000001A2 (418)	Microsoft ACPI-Compliant System

 (ISA) 0x000001A3 (419)	Microsoft ACPI-Compliant System
 (ISA) 0x000001A4 (420)	Microsoft ACPI-Compliant System
 (ISA) 0x000001A5 (421)	Microsoft ACPI-Compliant System
 (ISA) 0x000001A6 (422)	Microsoft ACPI-Compliant System
 (ISA) 0x000001A7 (423)	Microsoft ACPI-Compliant System
 (ISA) 0x000001A8 (424)	Microsoft ACPI-Compliant System
 (ISA) 0x000001A9 (425)	Microsoft ACPI-Compliant System
 (ISA) 0x000001AA (426)	Microsoft ACPI-Compliant System
 (ISA) 0x000001AB (427)	Microsoft ACPI-Compliant System
 (ISA) 0x000001AC (428)	Microsoft ACPI-Compliant System
 (ISA) 0x000001AD (429)	Microsoft ACPI-Compliant System
 (ISA) 0x000001AE (430)	Microsoft ACPI-Compliant System
 (ISA) 0x000001AF (431)	Microsoft ACPI-Compliant System
 (ISA) 0x000001B0 (432)	Microsoft ACPI-Compliant System
 (ISA) 0x000001B1 (433)	Microsoft ACPI-Compliant System
 (ISA) 0x000001B2 (434)	Microsoft ACPI-Compliant System
 (ISA) 0x000001B3 (435)	Microsoft ACPI-Compliant System
 (ISA) 0x000001B4 (436)	Microsoft ACPI-Compliant System
 (ISA) 0x000001B5 (437)	Microsoft ACPI-Compliant System
 (ISA) 0x000001B6 (438)	Microsoft ACPI-Compliant System
 (ISA) 0x000001B7 (439)	Microsoft ACPI-Compliant System
 (ISA) 0x000001B8 (440)	Microsoft ACPI-Compliant System
 (ISA) 0x000001B9 (441)	Microsoft ACPI-Compliant System
 (ISA) 0x000001BA (442)	Microsoft ACPI-Compliant System
 (ISA) 0x000001BB (443)	Microsoft ACPI-Compliant System
 (ISA) 0x000001BC (444)	Microsoft ACPI-Compliant System
 (ISA) 0x000001BD (445)	Microsoft ACPI-Compliant System
 (ISA) 0x000001BE (446)	Microsoft ACPI-Compliant System
 (ISA) 0x000001BF (447)	Microsoft ACPI-Compliant System
 (ISA) 0x000001C0 (448)	Microsoft ACPI-Compliant System
 (ISA) 0x000001C1 (449)	Microsoft ACPI-Compliant System
 (ISA) 0x000001C2 (450)	Microsoft ACPI-Compliant System
 (ISA) 0x000001C3 (451)	Microsoft ACPI-Compliant System
 (ISA) 0x000001C4 (452)	Microsoft ACPI-Compliant System
 (ISA) 0x000001C5 (453)	Microsoft ACPI-Compliant System
 (ISA) 0x000001C6 (454)	Microsoft ACPI-Compliant System
 (ISA) 0x000001C7 (455)	Microsoft ACPI-Compliant System
 (ISA) 0x000001C8 (456)	Microsoft ACPI-Compliant System
 (ISA) 0x000001C9 (457)	Microsoft ACPI-Compliant System
 (ISA) 0x000001CA (458)	Microsoft ACPI-Compliant System
 (ISA) 0x000001CB (459)	Microsoft ACPI-Compliant System
 (ISA) 0x000001CC (460)	Microsoft ACPI-Compliant System
 (ISA) 0x000001CD (461)	Microsoft ACPI-Compliant System
 (ISA) 0x000001CE (462)	Microsoft ACPI-Compliant System
 (ISA) 0x000001CF (463)	Microsoft ACPI-Compliant System
 (ISA) 0x000001D0 (464)	Microsoft ACPI-Compliant System
 (ISA) 0x000001D1 (465)	Microsoft ACPI-Compliant System
 (ISA) 0x000001D2 (466)	Microsoft ACPI-Compliant System
 (ISA) 0x000001D3 (467)	Microsoft ACPI-Compliant System
 (ISA) 0x000001D4 (468)	Microsoft ACPI-Compliant System
 (ISA) 0x000001D5 (469)	Microsoft ACPI-Compliant System
 (ISA) 0x000001D6 (470)	Microsoft ACPI-Compliant System

 (ISA) 0x000001D7 (471)	Microsoft ACPI-Compliant System
 (ISA) 0x000001D8 (472)	Microsoft ACPI-Compliant System
 (ISA) 0x000001D9 (473)	Microsoft ACPI-Compliant System
 (ISA) 0x000001DA (474)	Microsoft ACPI-Compliant System
 (ISA) 0x000001DB (475)	Microsoft ACPI-Compliant System
 (ISA) 0x000001DC (476)	Microsoft ACPI-Compliant System
 (ISA) 0x000001DD (477)	Microsoft ACPI-Compliant System
 (ISA) 0x000001DE (478)	Microsoft ACPI-Compliant System
 (ISA) 0x000001DF (479)	Microsoft ACPI-Compliant System
 (ISA) 0x000001E0 (480)	Microsoft ACPI-Compliant System
 (ISA) 0x000001E1 (481)	Microsoft ACPI-Compliant System
 (ISA) 0x000001E2 (482)	Microsoft ACPI-Compliant System
 (ISA) 0x000001E3 (483)	Microsoft ACPI-Compliant System
 (ISA) 0x000001E4 (484)	Microsoft ACPI-Compliant System
 (ISA) 0x000001E5 (485)	Microsoft ACPI-Compliant System
 (ISA) 0x000001E6 (486)	Microsoft ACPI-Compliant System
 (ISA) 0x000001E7 (487)	Microsoft ACPI-Compliant System
 (ISA) 0x000001E8 (488)	Microsoft ACPI-Compliant System
 (ISA) 0x000001E9 (489)	Microsoft ACPI-Compliant System
 (ISA) 0x000001EA (490)	Microsoft ACPI-Compliant System
 (ISA) 0x000001EB (491)	Microsoft ACPI-Compliant System
 (ISA) 0x000001EC (492)	Microsoft ACPI-Compliant System
 (ISA) 0x000001ED (493)	Microsoft ACPI-Compliant System
 (ISA) 0x000001EE (494)	Microsoft ACPI-Compliant System
 (ISA) 0x000001EF (495)	Microsoft ACPI-Compliant System
 (ISA) 0x000001F0 (496)	Microsoft ACPI-Compliant System
 (ISA) 0x000001F1 (497)	Microsoft ACPI-Compliant System
 (ISA) 0x000001F2 (498)	Microsoft ACPI-Compliant System
 (ISA) 0x000001F3 (499)	Microsoft ACPI-Compliant System
 (ISA) 0x000001F4 (500)	Microsoft ACPI-Compliant System
 (ISA) 0x000001F5 (501)	Microsoft ACPI-Compliant System
 (ISA) 0x000001F6 (502)	Microsoft ACPI-Compliant System
 (ISA) 0x000001F7 (503)	Microsoft ACPI-Compliant System
 (ISA) 0x000001F8 (504)	Microsoft ACPI-Compliant System
 (ISA) 0x000001F9 (505)	Microsoft ACPI-Compliant System
 (ISA) 0x000001FA (506)	Microsoft ACPI-Compliant System
 (ISA) 0x000001FB (507)	Microsoft ACPI-Compliant System
 (ISA) 0x000001FC (508)	Microsoft ACPI-Compliant System
 (ISA) 0x000001FD (509)	Microsoft ACPI-Compliant System
 (ISA) 0x000001FE (510)	Microsoft ACPI-Compliant System
 (ISA) 0x000001FF (511)	Microsoft ACPI-Compliant System
 (PCI) 0x0000000B (11)	Mobile 6th/7th Generation Intel(R) Processor Family I/O Thermal subsystem - 9D31
 (PCI) 0x0000000B (11)	Mobile 6th/7th Generation Intel(R) Processor Family I/O SMBUS - 9D23
 (PCI) 0x00000010 (16)	High Definition Audio Controller
 (PCI) 0x00000013 (19)	Intel(R) Active Management Technology - SOL (COM3)
 (PCI) 0xFFFFFFFF (-6)	Intel(R) Management Engine Interface
 (PCI) 0xFFFFFFFFB (-5)	Intel(R) USB 3.0 eXtensible Host Controller - 1.0 (Microsoft)
 (PCI) 0xFFFFFFFFC (-4)	Intel(R) HD Graphics 620
 (PCI) 0xFFFFFFFFD (-3)	Intel(R) Ethernet Connection I219-LM
 (PCI) 0xFFFFFFFFE (-2)	Standard SATA AHCI Controller

3.6 Memory Map

The memory mapping list is shown as follows:

- Memory
 - [0000000000A0000 - 0000000000BFFFFF] Intel(R) HD Graphics 620
 - [0000000000A0000 - 0000000000BFFFFF] PCI Express Root Complex
 - [00000000009000000 - 00000000DFFFFFFF] PCI Express Root Complex
 - [00000000C0000000 - 00000000CFFFFFFF] Intel(R) HD Graphics 520
 - [00000000C0000000 - 00000000CFFFFFFF] Intel(R) HD Graphics 620
 - [00000000DE000000 - 00000000DEFFFFFF] Intel(R) HD Graphics 520
 - [00000000DE000000 - 00000000DEFFFFFF] Intel(R) HD Graphics 620
 - [00000000DF000000 - 00000000DF01FFFF] Intel(R) Dual Band Wireless-AC 7260
 - [00000000DF000000 - 00000000DF01FFFF] Intel(R) Ethernet Connection I219-LM
 - [00000000DF000000 - 00000000DF07FFFF] Intel(R) I210 Gigabit Network Connection
 - [00000000DF000000 - 00000000DF07FFFF] Intel(R) I210 Gigabit Network Connection #2
 - [00000000DF000000 - 00000000DF07FFFF] Mobile 6th/7th Generation Intel(R) Processor Family I/O PCI Express Root Port #6 - 9D15
 - [00000000DF000000 - 00000000DF7FFFFF] Ethernet Controller
 - [00000000DF020000 - 00000000DF02FFFF] High Definition Audio Controller
 - [00000000DF020000 - 00000000DF02FFFF] High Definition Audio Controller
 - [00000000DF030000 - 00000000DF03FFFF] Intel(R) USB 3.0 eXtensible Host Controller - 1.0 (Microsoft)
 - [00000000DF040000 - 00000000DF043FFF] High Definition Audio Controller
 - [00000000DF040000 - 00000000DF043FFF] High Definition Audio Controller
 - [00000000DF044000 - 00000000DF047FFF] Mobile 6th/7th Generation Intel(R) Processor Family I/O PMC - 9D21
 - [00000000DF048000 - 00000000DF049FFF] Standard SATA AHCI Controller
 - [00000000DF04A000 - 00000000DF04A0FF] Mobile 6th/7th Generation Intel(R) Processor Family I/O SMBUS - 9D23
 - [00000000DF04B000 - 00000000DF04B7FF] Standard SATA AHCI Controller
 - [00000000DF04C000 - 00000000DF04C0FF] Standard SATA AHCI Controller
 - [00000000DF04D000 - 00000000DF04DFFF] Intel(R) Active Management Technology - SOL (COM3)
 - [00000000DF04F000 - 00000000DF04FFFF] Mobile 6th/7th Generation Intel(R) Processor Family I/O Thermal subsystem - 9D31
 - [00000000DF080000 - 00000000DF081FFF] Standard SATA AHCI Controller
 - [00000000DF080000 - 00000000DF083FFF] Intel(R) I210 Gigabit Network Connection
 - [00000000DF080000 - 00000000DF083FFF] Intel(R) I210 Gigabit Network Connection #2
 - [00000000DF100000 - 00000000DF11FFFF] Mobile 6th/7th Generation Intel(R) Processor Family I/O PCI Express Root Port #3 - 9D12
 - [00000000DF130000 - 00000000DF13FFFF] Intel(R) CSI2 Host Controller
 - [00000000DF15B000 - 00000000DF15BFFF] Intel SD Host Controller
 - [00000000DF15C000 - 00000000DF15CFFF] Intel SD Host Controller
 - [00000000DF800000 - 00000000DF803FFF] Ethernet Controller
 - [00000000DFFE0000 - 00000000DFFFFFFF] Motherboard resources
 - [00000000E0000000 - 00000000EFFFFFFF] Motherboard resources
 - [00000000FD000000 - 00000000FDABFFFF] Motherboard resources
 - [00000000FD000000 - 00000000FE7FFFFF] PCI Express Root Complex
 - [00000000FDAC0000 - 00000000FDACFFFF] Intel(R) Serial IO GPIO Host Controller - INT344B
 - [00000000FDAC0000 - 00000000FDACFFFF] Motherboard resources
 - [00000000FDAD0000 - 00000000FDADFFFF] Motherboard resources
 - [00000000FDAE0000 - 00000000FDAEFFFF] Intel(R) Serial IO GPIO Host Controller - INT344B
 - [00000000FDAE0000 - 00000000FDAEFFFF] Motherboard resources
 - [00000000FDAF0000 - 00000000FDAFFFFF] Intel(R) Serial IO GPIO Host Controller - INT344B
 - [00000000FDAF0000 - 00000000FDAFFFFF] Motherboard resources
 - [00000000FDB00000 - 00000000FDBFFFFF] Motherboard resources
 - [00000000FE000000 - 00000000FE01FFFF] Motherboard resources
 - [00000000FE028000 - 00000000FE028FFF] Motherboard resources
 - [00000000FE029000 - 00000000FE029FFF] Motherboard resources
 - [00000000FE036000 - 00000000FE03BFFF] Motherboard resources
 - [00000000FE03D000 - 00000000FE3FFFFF] Motherboard resources
 - [00000000FE40F000 - 00000000FE40FFFF] Intel(R) Management Engine Interface
 - [00000000FE410000 - 00000000FE7FFFFF] Motherboard resources
 - [00000000FED00000 - 00000000FED003FF] High precision event timer
 - [00000000FED10000 - 00000000FED17FFF] Motherboard resources
 - [00000000FED18000 - 00000000FED18FFF] Motherboard resources
 - [00000000FED19000 - 00000000FED19FFF] Motherboard resources
 - [00000000FED20000 - 00000000FED3FFFF] Motherboard resources
 - [00000000FED40000 - 00000000FED40FFF] Trusted Platform Module 1.2
 - [00000000FED45000 - 00000000FED8FFFF] Motherboard resources
 - [00000000FED90000 - 00000000FED93FFF] Motherboard resources
 - [00000000FEE00000 - 00000000FEEFFFFFFF] Motherboard resources
 - [00000000FF000000 - 00000000FFFFFFFF] Legacy device
 - [00000000FF000000 - 00000000FFFFFFFF] Legacy device
 - [00000000FF000000 - 00000000FFFFFFFF] Motherboard resources

This page is intentionally left blank.

Chapter 4

AMI BIOS Setup Utility

The AMI UEFI BIOS provides users with a built-in setup program to modify basic system configuration. All configured parameters are stored in a flash chip to save the setup information whenever the power is turned off. This chapter provides users with detailed description about how to set up basic system configuration through the AMI BIOS setup utility.

4.1 Starting

To enter the setup screens, follow the steps below:

1. Turn on the computer and press the key immediately.
2. After you press the key, the main BIOS setup menu displays. You can access the other setup screens from the main BIOS setup menu, such as the Advanced and Chipset menus.



Note

If your computer cannot boot after making and saving system changes with BIOS setup, you can restore BIOS optimal defaults by setting JP2 (see section 2.4.1).

It is strongly recommended that you should avoid changing the chipset's defaults. Both AMI and your system manufacturer have carefully set up these defaults that provide the best performance and reliability.

4.2 Navigation Keys

The BIOS setup/utility uses a key-based navigation system called hot keys. Most of the BIOS setup utility hot keys can be used at any time during the setup navigation process. These keys include <F1>, <F2>, <Enter>, <ESC>, <Arrow> keys, and so on.



Note

Some of the navigation keys differ from one screen to another.

Hot Keys	Description
→← Left/Right	The Left and Right <Arrow> keys allow you to select a setup screen.
↑↓ Up/Down	The Up and Down <Arrow> keys allow you to select a setup screen or sub-screen.
+– Plus/Minus	The Plus and Minus <Arrow> keys allow you to change the field value of a particular setup item.
Tab	The <Tab> key allows you to select setup fields.
F1	The <F1> key allows you to display the General Help screen.
F2	The <F2> key allows you to Load Previous Values.
F3	The <F3> key allows you to Load Optimized Defaults.
F4	The <F4> key allows you to save any changes you have made and exit Setup. Press the <F4> key to save your changes.
Esc	The <Esc> key allows you to discard any changes you have made and exit the Setup. Press the <Esc> key to exit the setup without saving your changes.
Enter	The <Enter> key allows you to display or change the setup option listed for a particular setup item. The <Enter> key can also allow you to display the setup sub- screens.

4.3 Main Menu

When you first enter the setup utility, you will enter the Main setup screen. You can always return to the Main setup screen by selecting the Main tab. System Time/Date can be set up as described below. The Main BIOS setup screen is shown below.

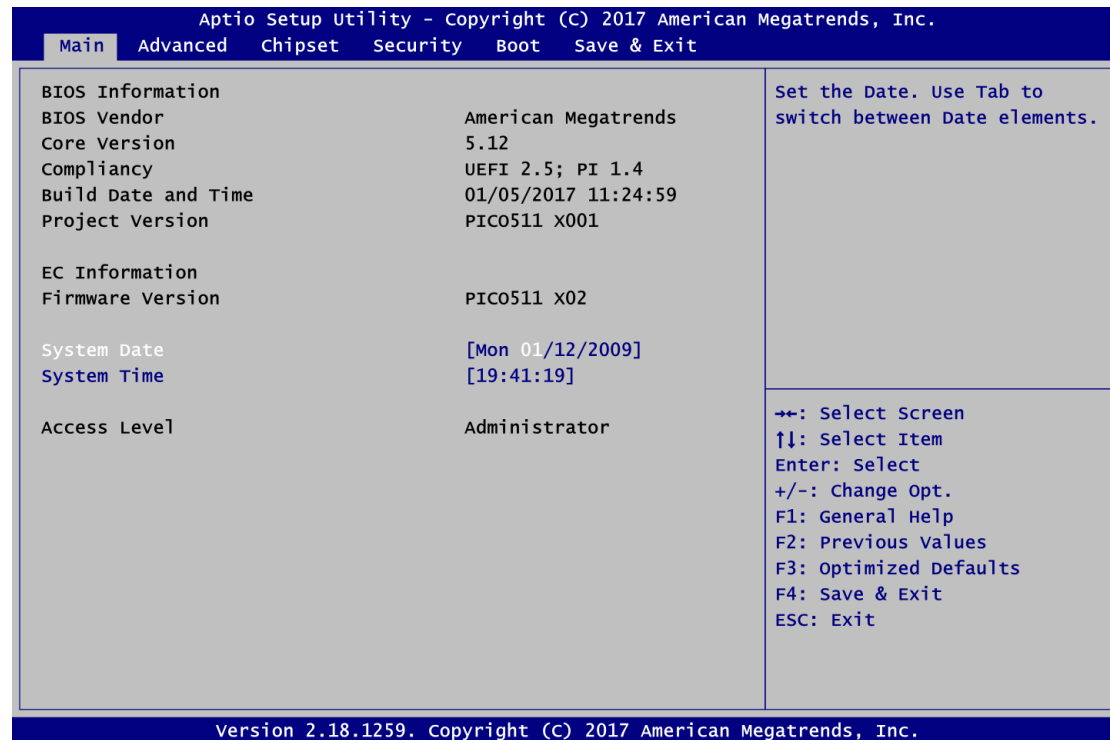

- BIOS and EC Information**
 Display BIOS and EC firmware information.
- System Date/Time**
 Use this option to change the system time and date. Highlight System Time or System Date using the <Arrow> keys. Enter new values through the keyboard. Press the <Tab> key or the <Arrow> keys to move between fields. The date must be entered in MM/DD/YY format. The time is entered in HH:MM:SS format.
- Access Level**
 Display the access level of current user.

4.4 Advanced Menu

The Advanced menu also allows users to set configuration of the CPU and other system devices. You can select any of the items in the left frame of the screen to go to the sub menus:

- ▶ Hardware Monitor
- ▶ ACPI Settings
- ▶ CPU Configuration
- ▶ SATA Configuration
- ▶ PCH-FW Configuration
- ▶ AMT Configuration
- ▶ USB Configuration
- ▶ Utility Configuration
- ▶ Device Configuration (This option appears only if an I/O board is connected.)

For items marked with “▶”, please press <Enter> for more options.

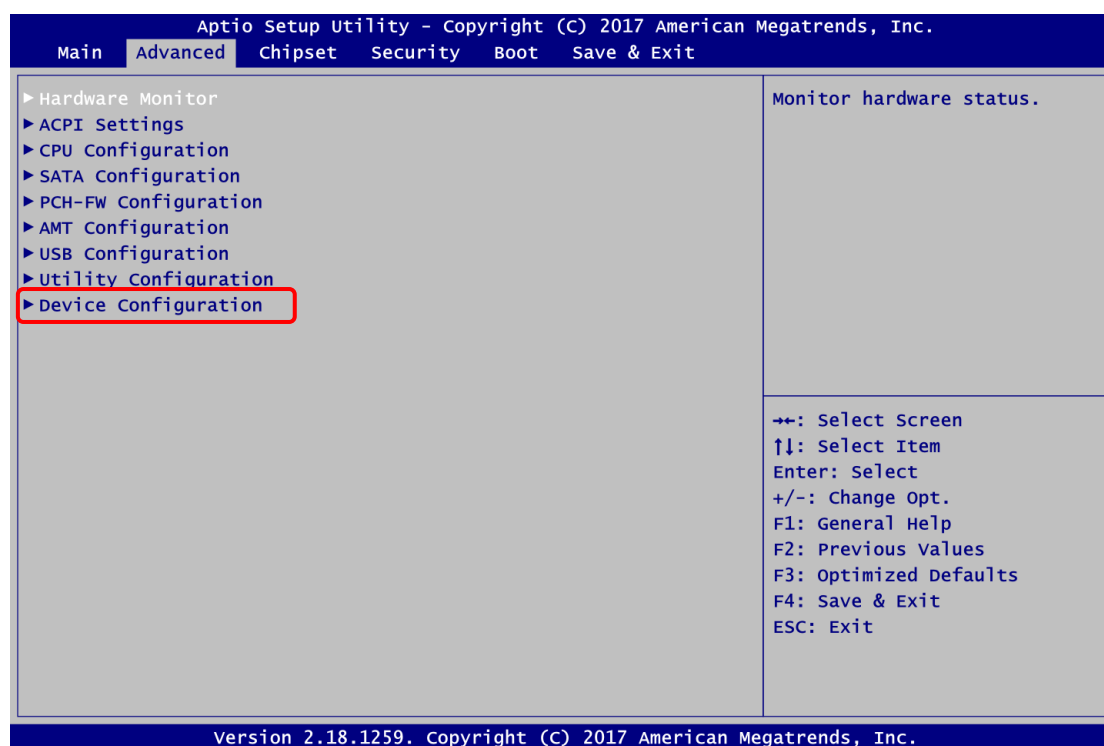

- **Hardware Monitor**

This screen monitors hardware health status.

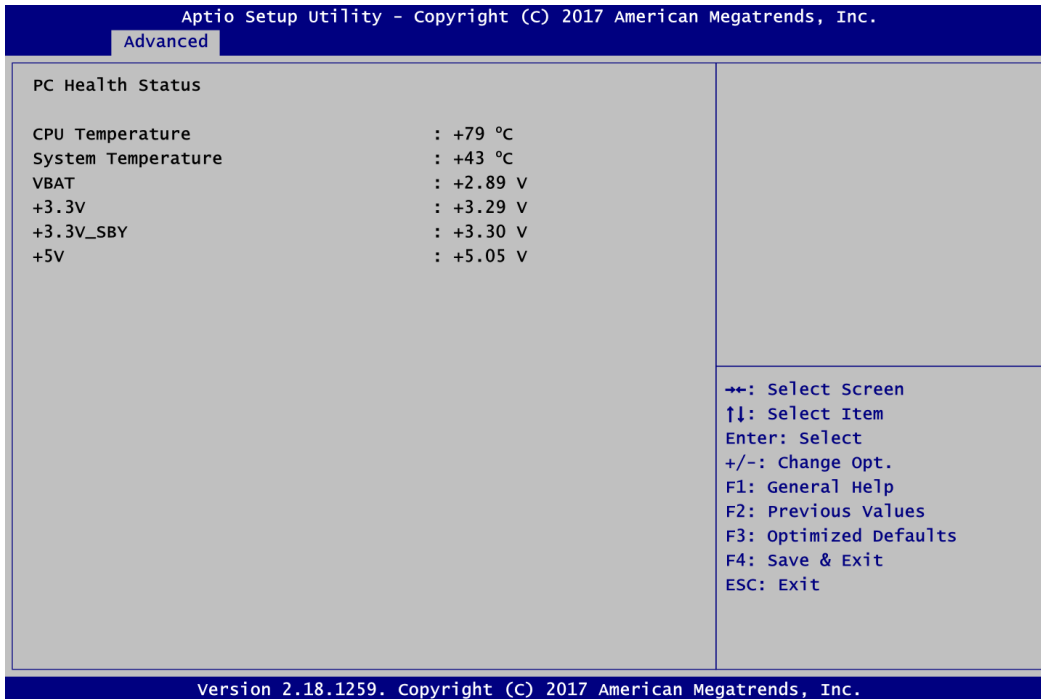

This screen displays the temperature of system and CPU, system voltages (VBAT, +3.3V, +3.3V_SBY and +5V).

- **ACPI Settings**

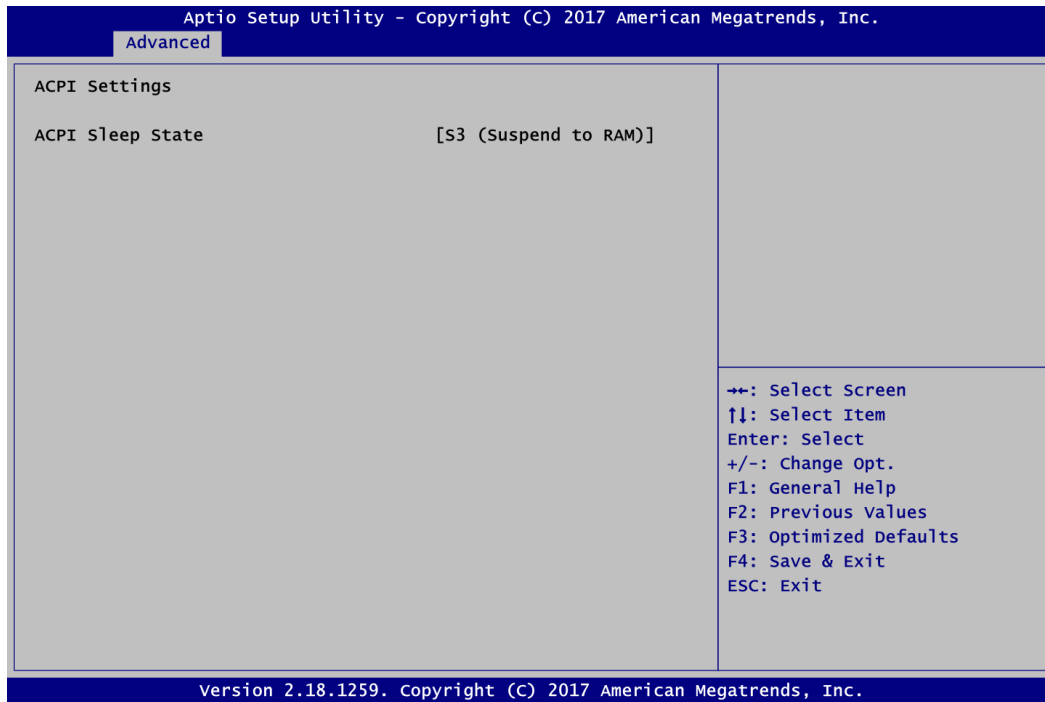

ACPI Sleep State

The setting is S3 (Suspend to RAM); this option selects ACPI sleep state the system will enter when suspend button is pressed.

- **CPU Configuration**

This screen shows the CPU Configuration and you can change the value of the selected option.

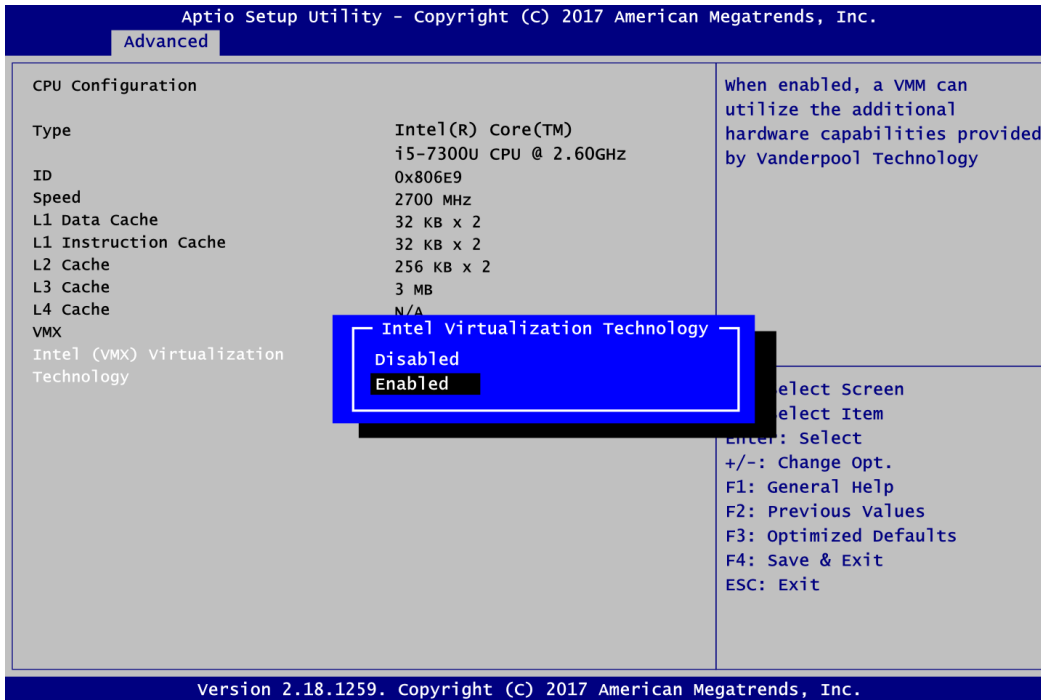

Intel (VMX) Virtualization Technology

Enable or disable Intel Virtualization Technology. When enabled, a VMM (Virtual Machine Mode) can utilize the additional hardware capabilities. It allows a platform to run multiple operating systems and applications independently, hence enabling a computer system to work as several virtual systems.

- **SATA Configuration**

In the SATA Configuration menu, you can see the current installed hardware in the SATA ports. During system boot up, the BIOS automatically detects the presence of SATA devices.

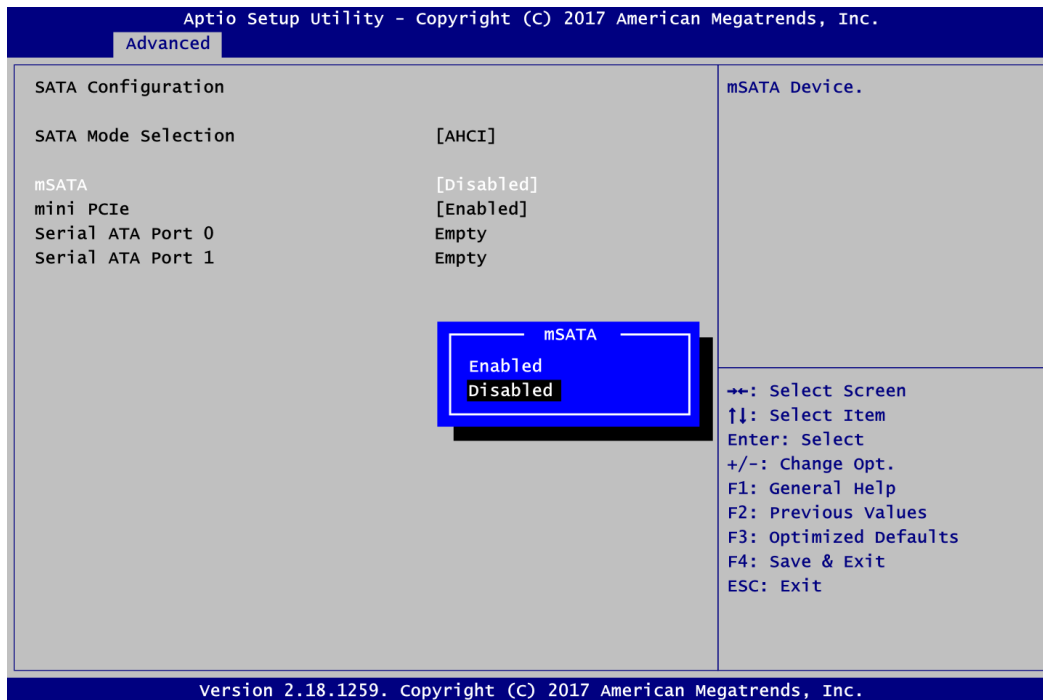

SATA Mode Selection

The SATA mode is set to AHCI.

mSATA

Enable or disable mSATA feature.

- **PCH-FW Configuration**

This screen displays ME Firmware information.

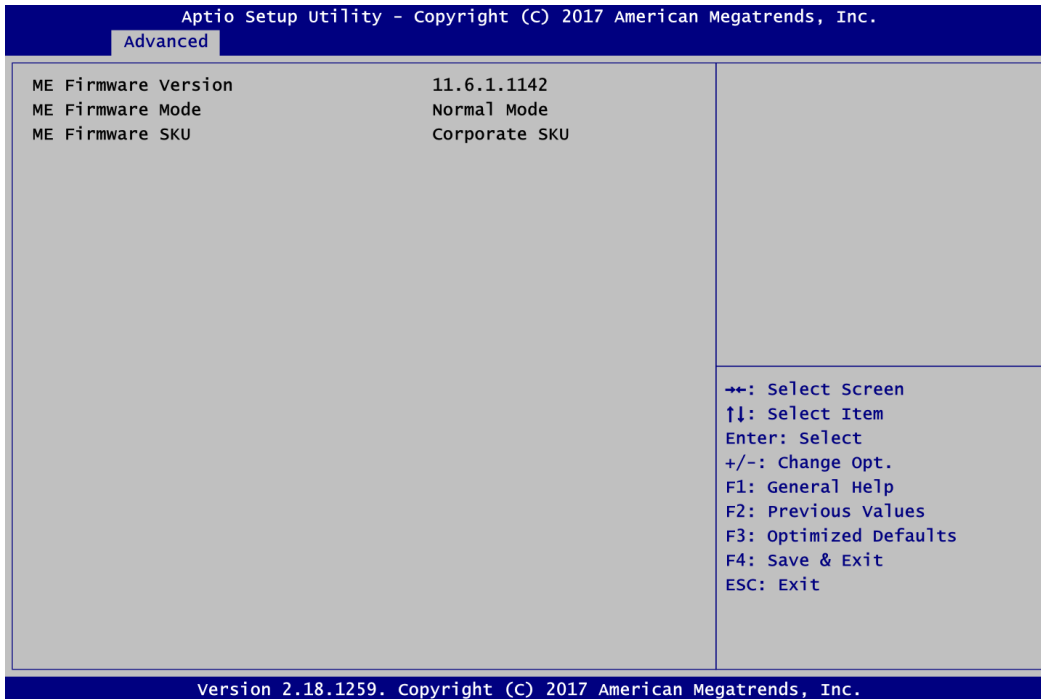

- **AMT Configuration**

Use this screen to configure AMT parameters.

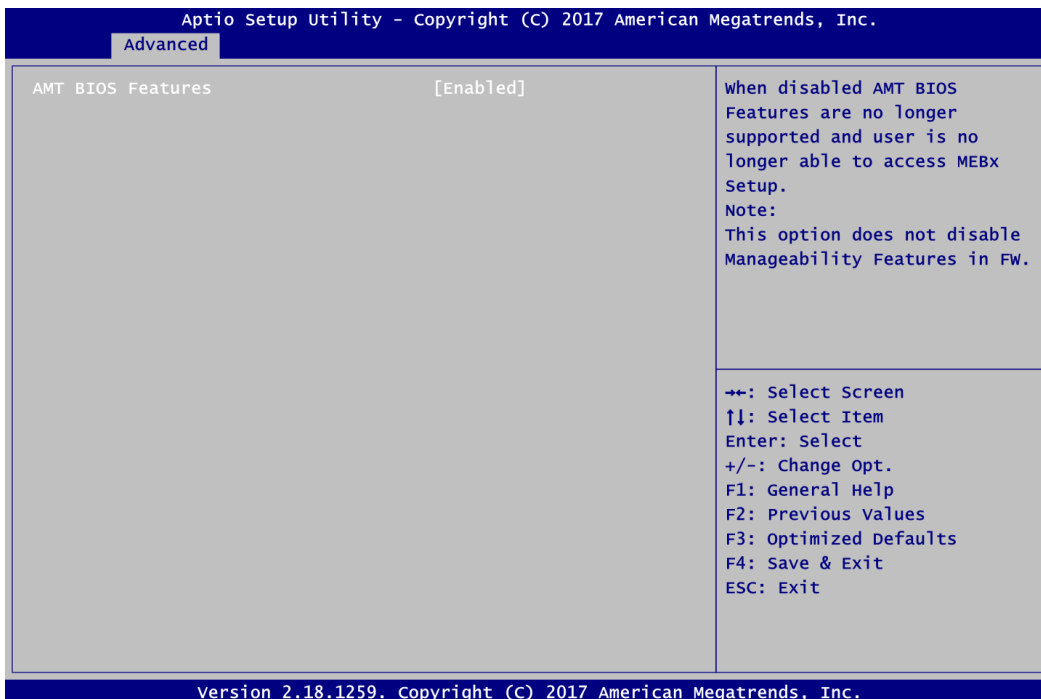

AMT BIOS Features

Enable or disable AMT (Active Management Technology) BIOS features. The default is Enabled. After enabling, please refer to Appendix C for iAMT settings.

- **USB Configuration**

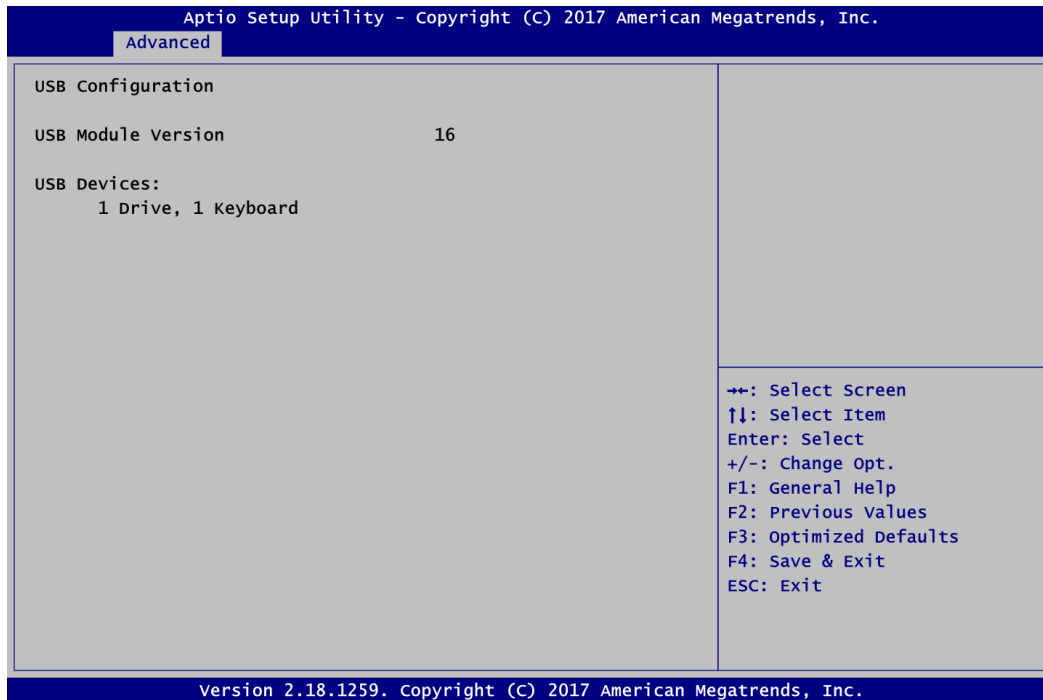

USB Devices

Display all detected USB devices.

- **Utility Configuration**

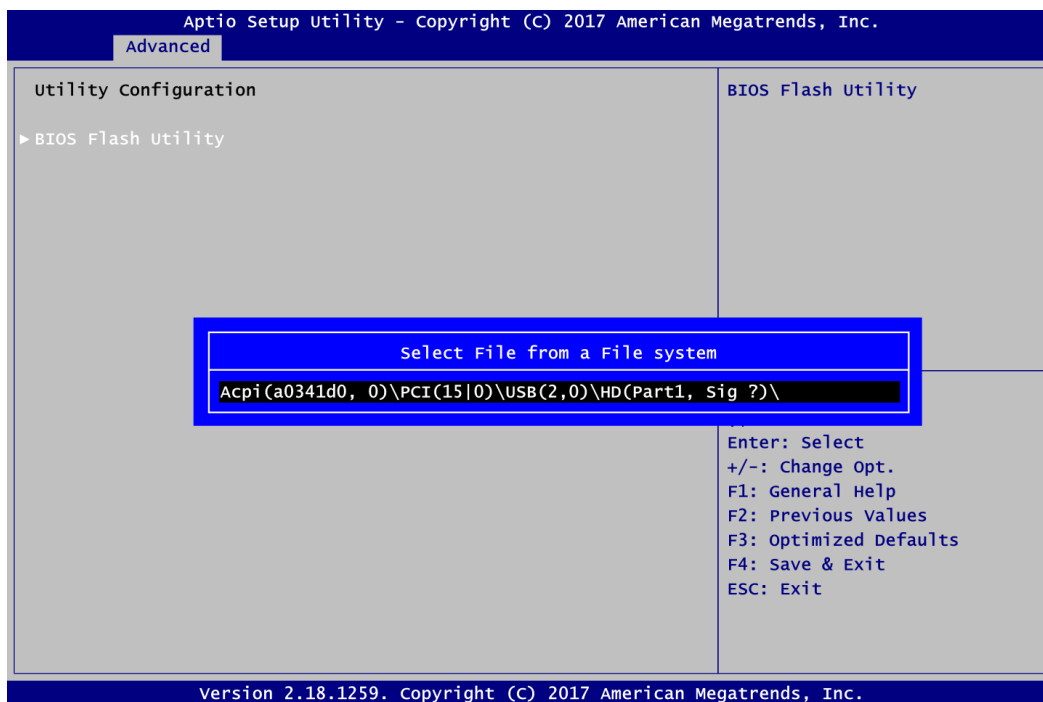

BIOS Flash Utility

BIOS flash utility configuration. For more detailed information, please refer to Appendix D.

- **Device Configuration**

A description of selected item appears on the right side of the screen. For items marked with “▶”, please press <Enter> for more options.

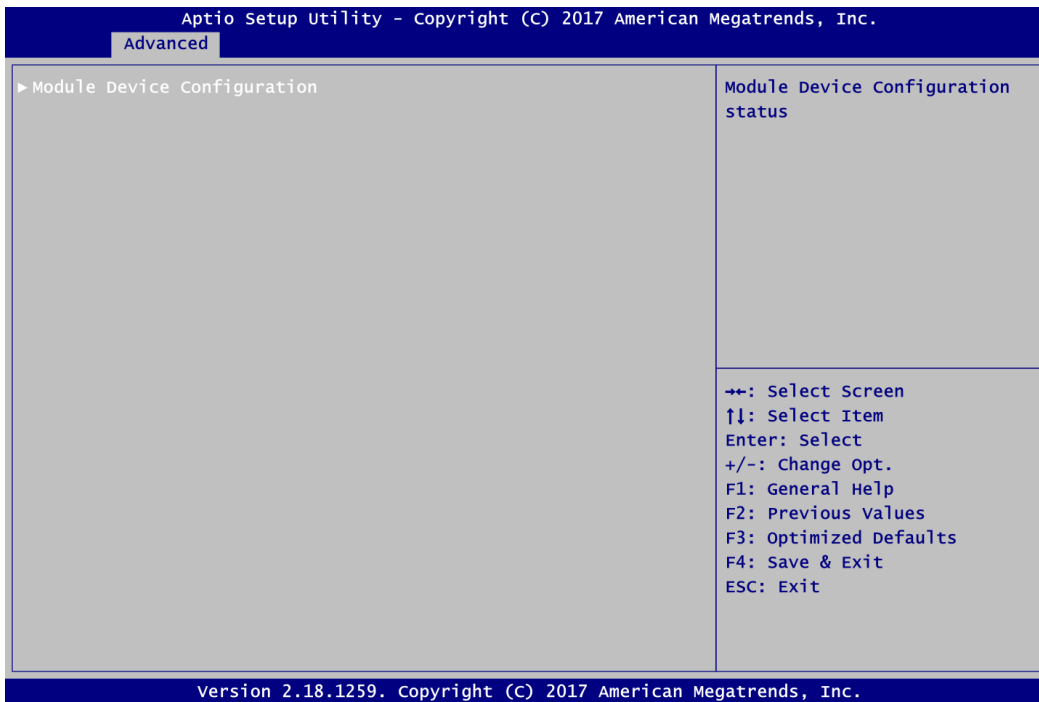

Module Device Configuration

This option appears only if an I/O board is installed. BIOS will auto-detect all supported functions and you can use it to change settings on the I/O board. The PICO511 supports the following I/O boards: AX93A00, AX93A01 and AX93A02.

- **Module Device Configuration**

This screen is available only if an I/O board with serial ports is connected. For items marked with “▶”, please press <Enter> for more options.

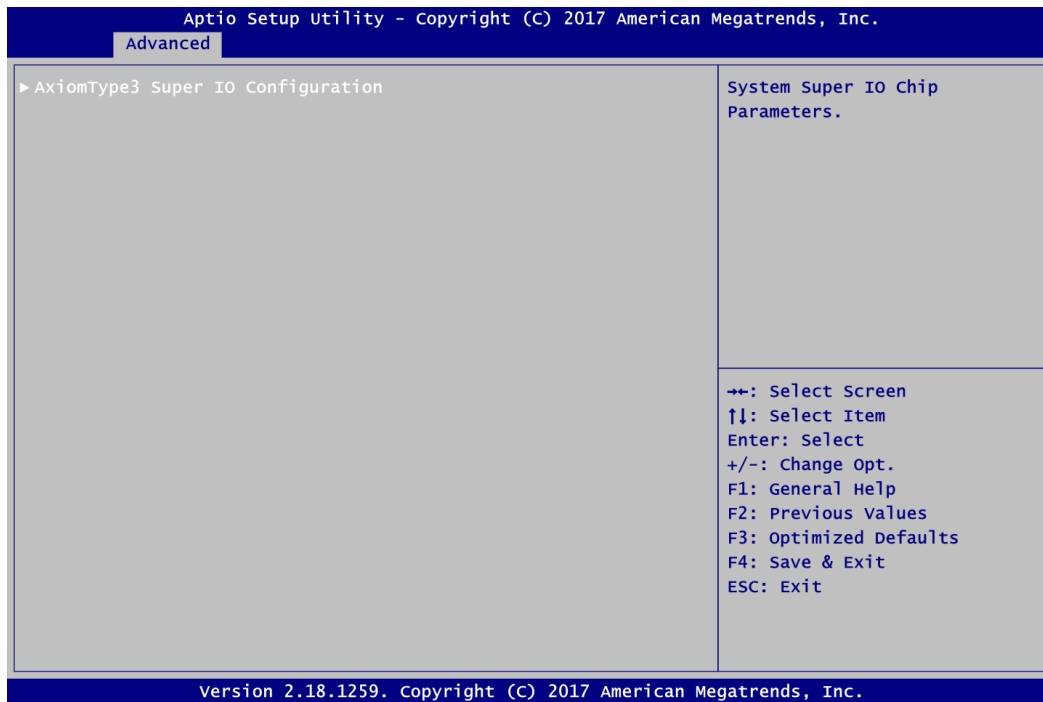

- **AxiomType3 Super IO Configuration**

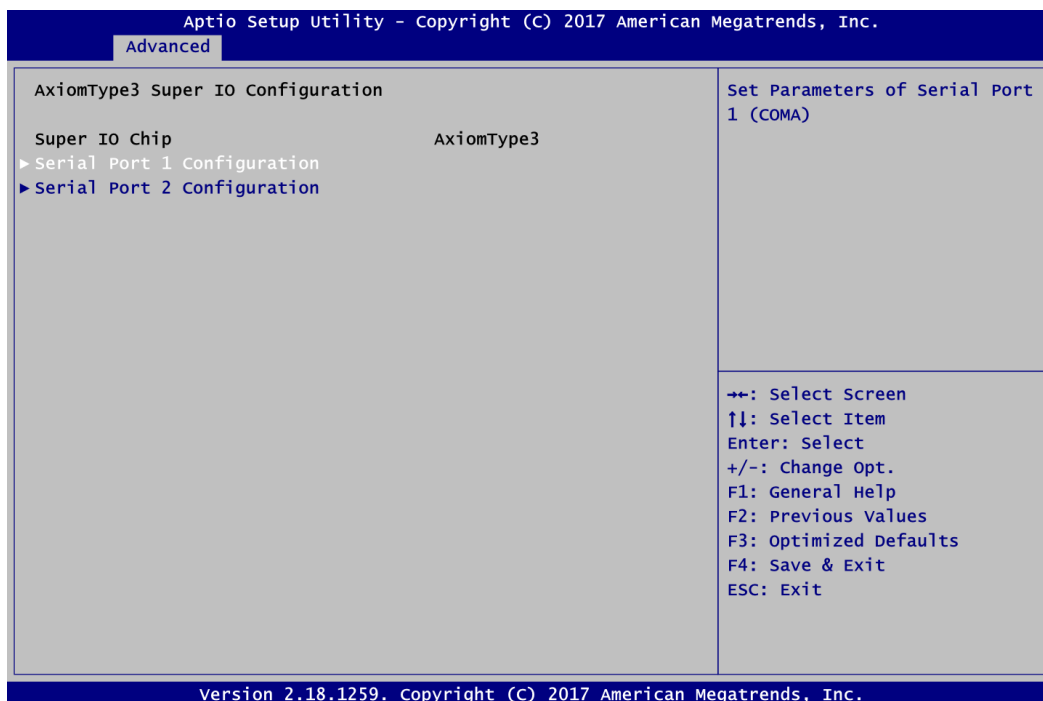

Serial Port 1~2 Configuration

Set parameters related to serial port 1~2 on I/O board.

- **Serial Port 1 Configuration**

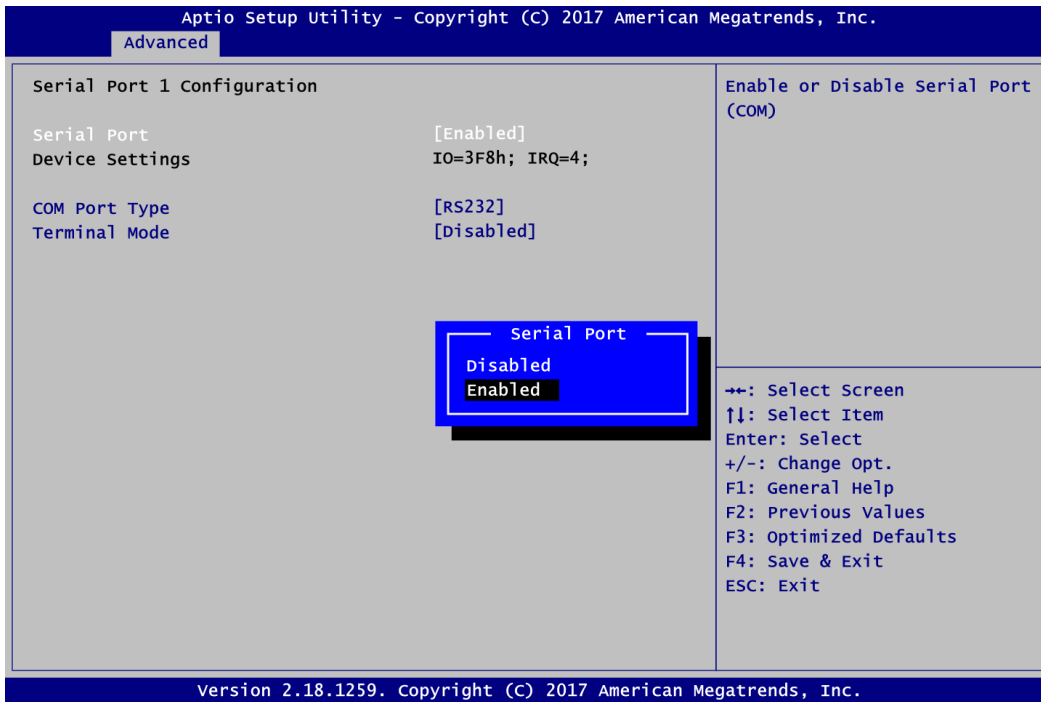

Serial Port

Enable or disable serial port 1 on I/O board. The optimal setting for base I/O address is 3F8h and for interrupt request address is IRQ4.

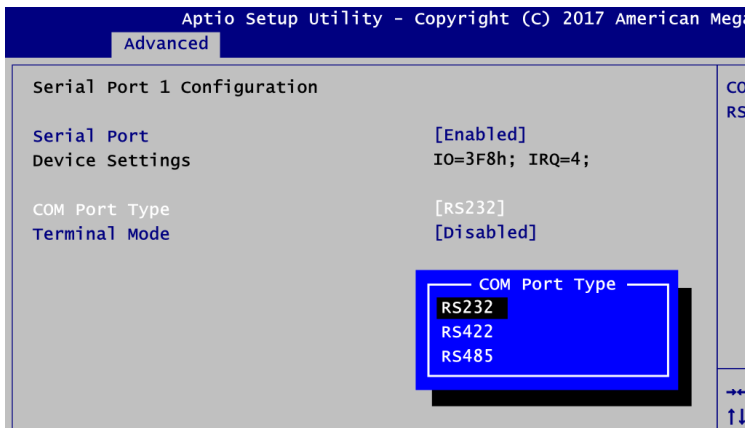

COM Port Type

Use this item to set RS-232/422/485 communication mode.

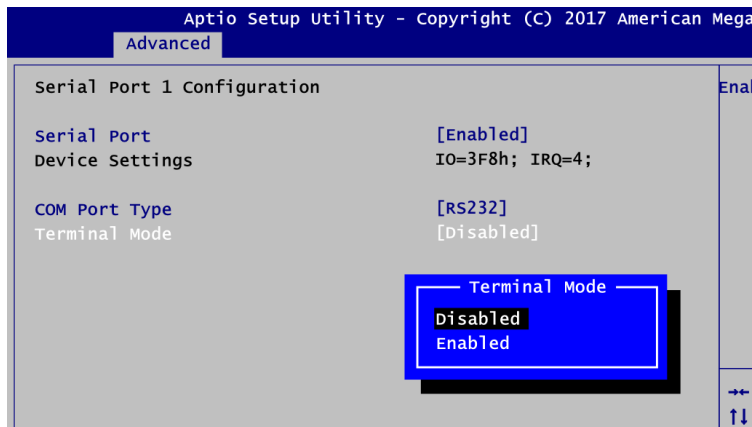

Terminal Mode

Enable or disable terminal mode.

- Serial Port 2 Configuration

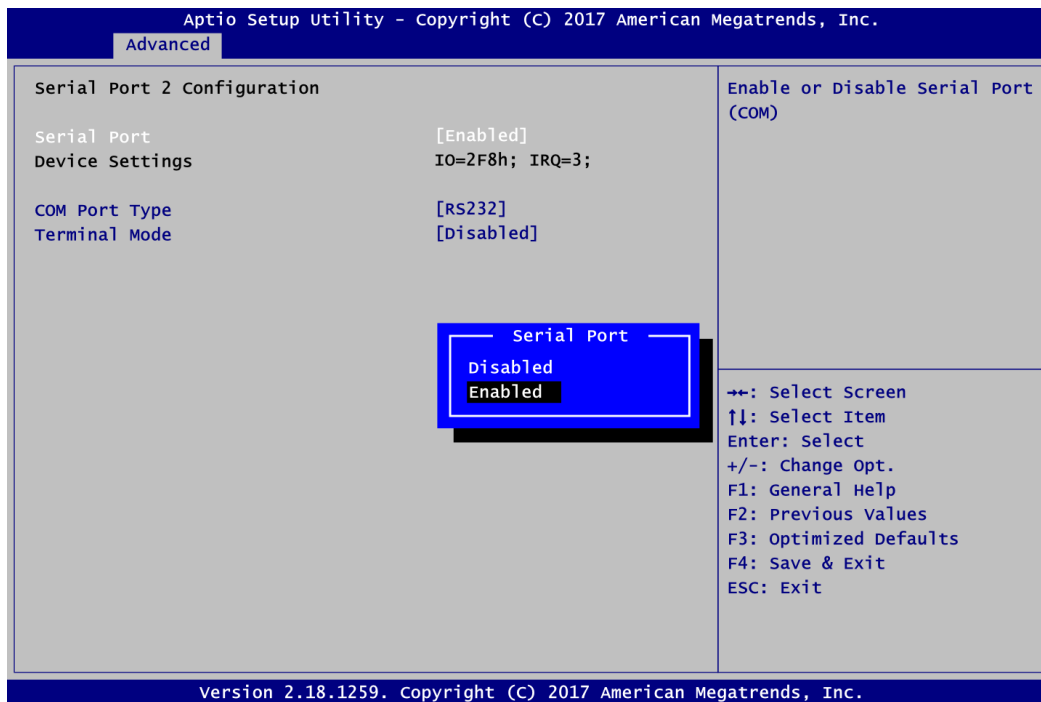

Serial Port

Enable or disable serial port 2 on I/O board. The optimal setting for base I/O address is 2F8h and for interrupt request address is IRQ3.

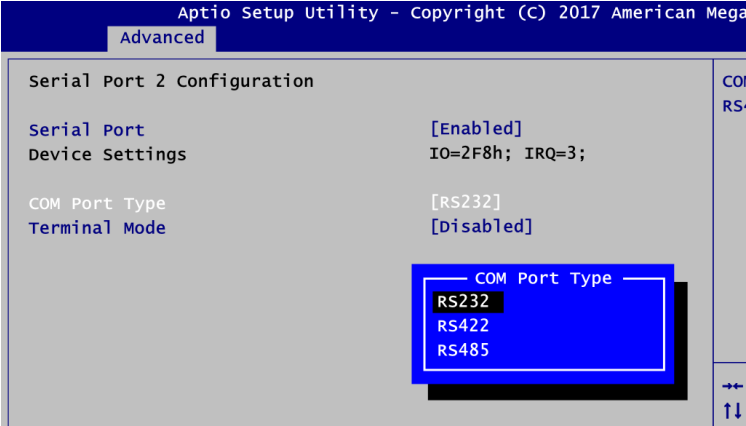

COM Port Type
Use this item to set RS-232/422/485 communication mode.

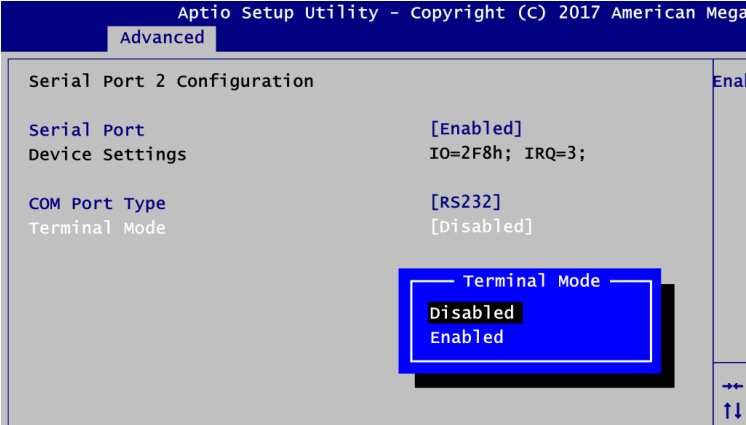

Terminal Mode
Enable or disable terminal mode.

4.5 Chipset Menu

The Chipset menu allows users to change the advanced chipset settings. You can select any of the items in the left frame of the screen to go to the sub menus:

- ▶ PCH-IO Configuration
- ▶ System Agent (SA) Configuration

For items marked with “▶”, please press <Enter> for more options.

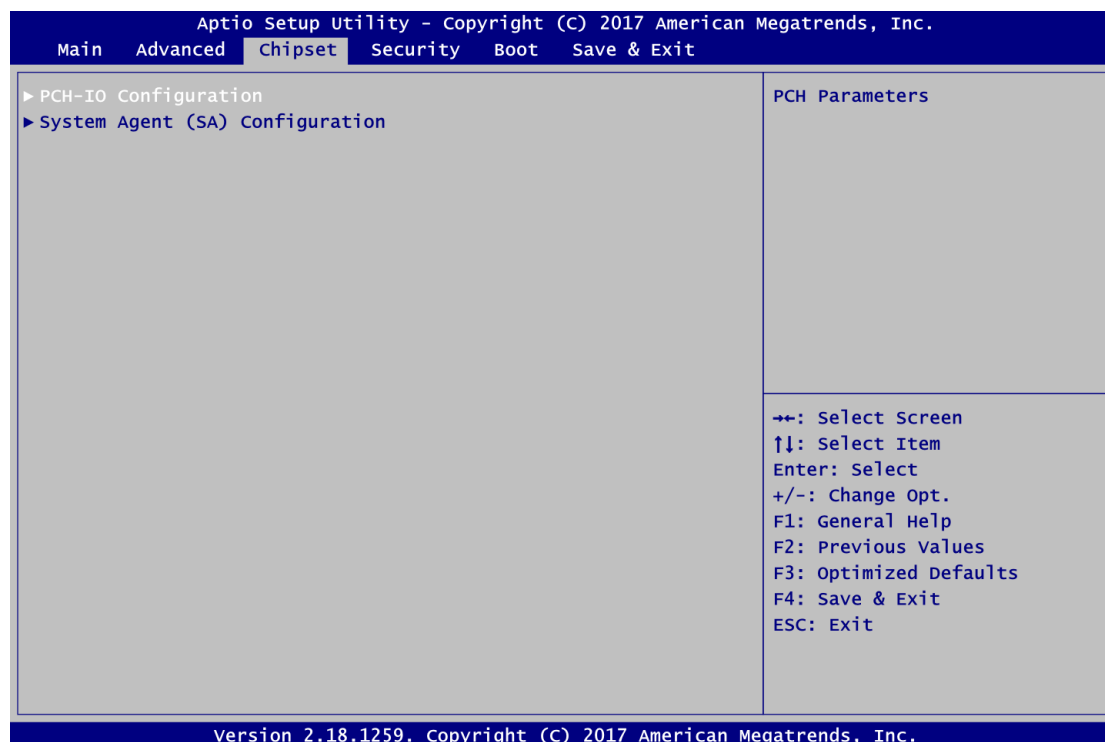

- **HD Audio Configuration**

For items marked with “▶”, please press <Enter> for more options.

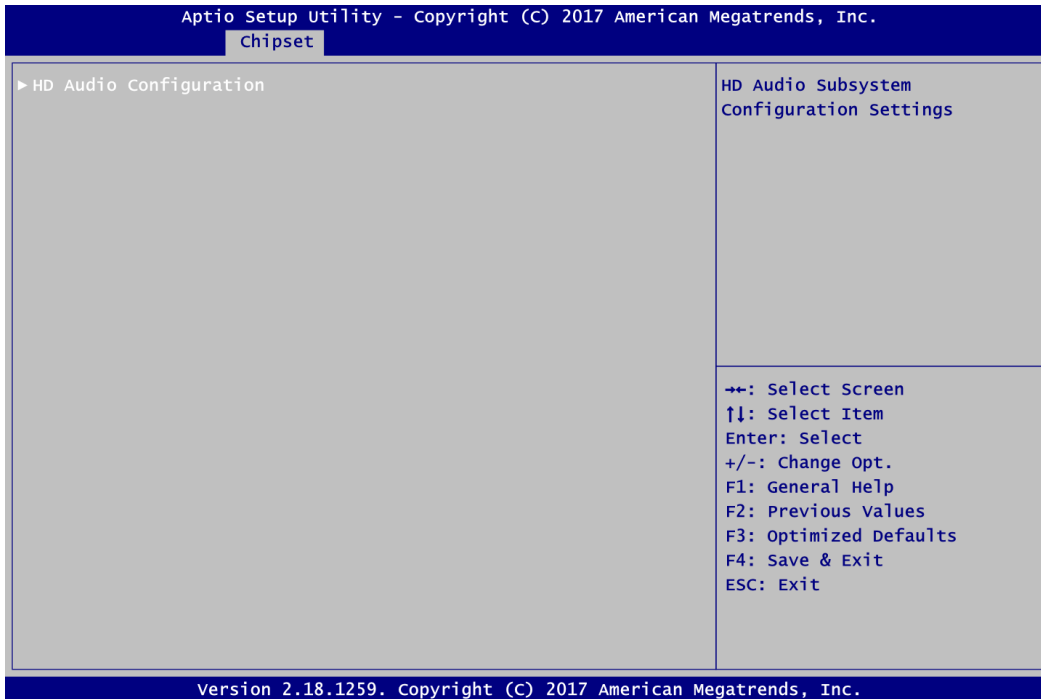

HD Audio Configuration

Use this item to set HD audio configuration.

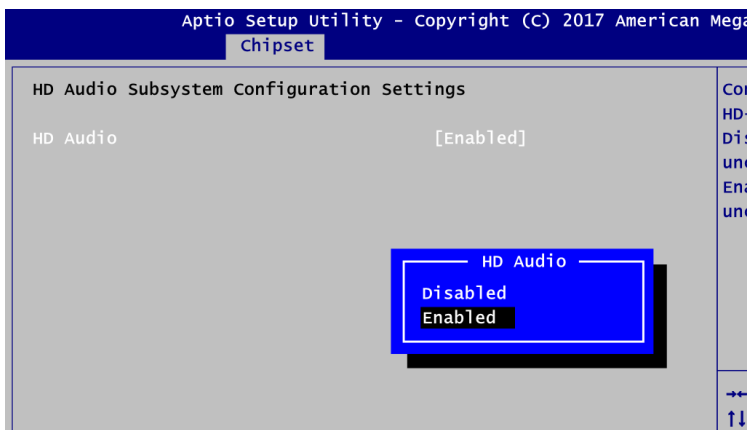

HD Audio

Enable or disable HD audio device.

- **System Agent (SA) Configuration**

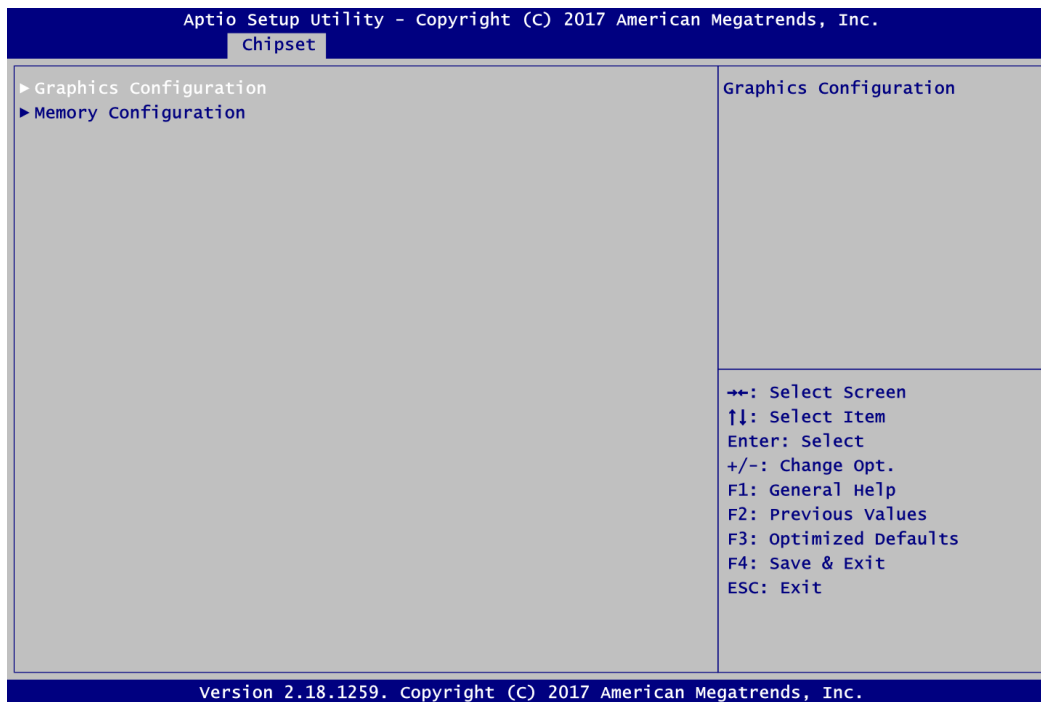

Graphics Configuration

Use this item to open graphics configuration sub screen.

Memory Configuration

Use this item to refer to information related to system memory.

For PICO511 with VGA (AX93A00):

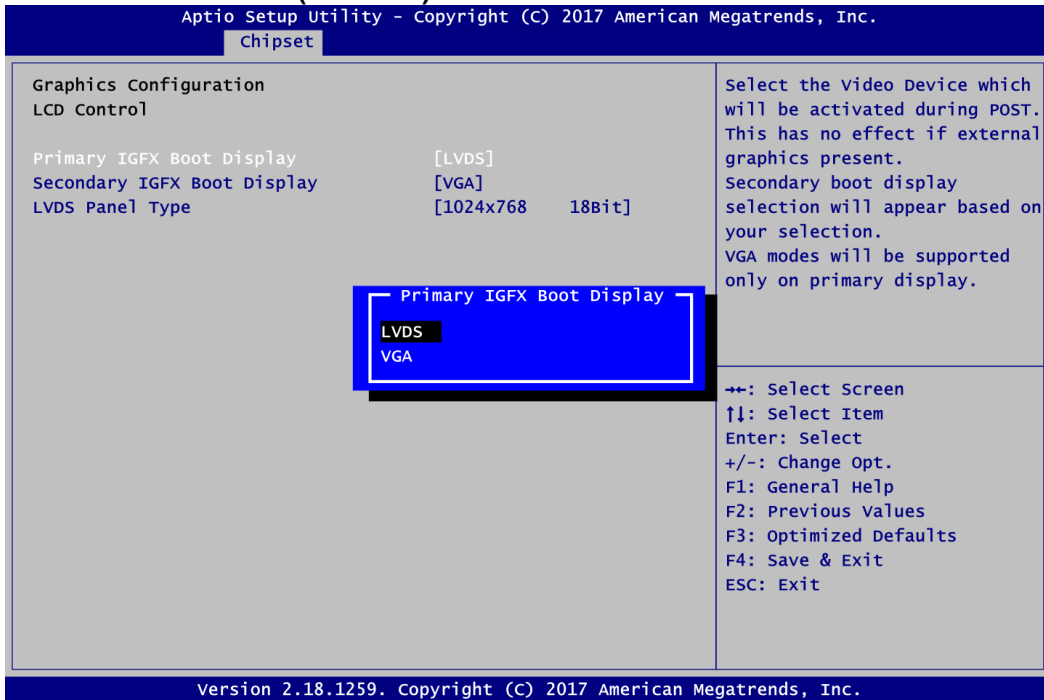

For PICO511 with HDMI (AX93A01):

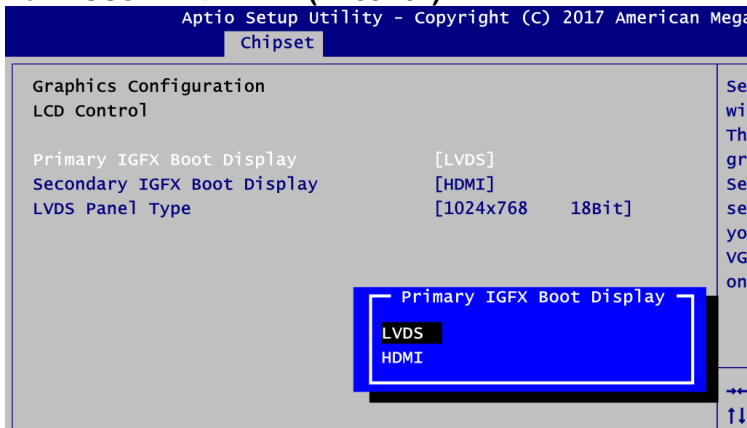

Primary IGFX Boot Display

Select the video device which will be activated during POST (Power-On Self Test).

The images below show Primary IGFX Boot Display option list when AX93A07 I/O board is installed.

For PICO511+AX93A07 with VGA (AX93A00):

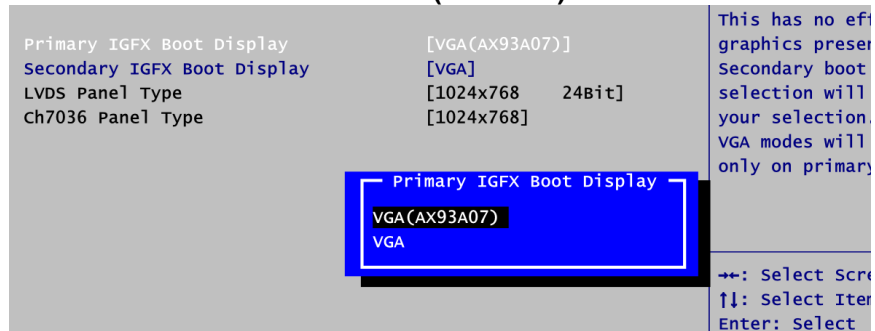

For PICO511+AX93A07 with HDMI (AX93A01):

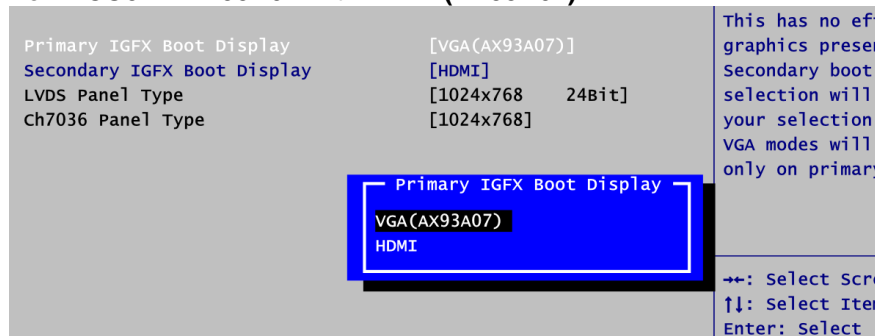

For PICO511+AX93A07:

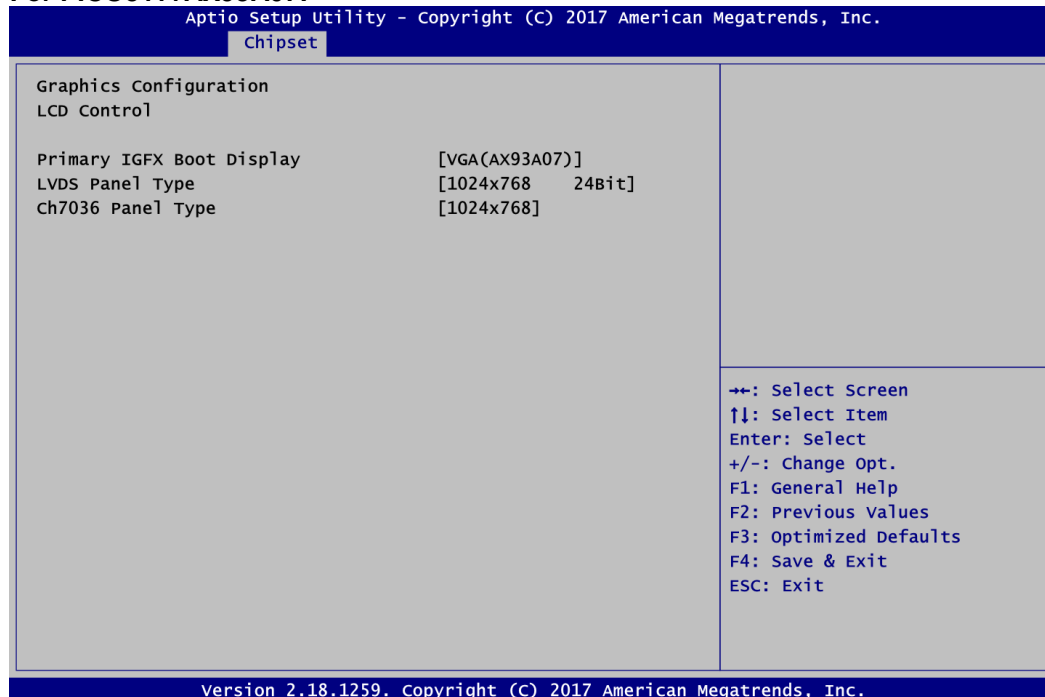

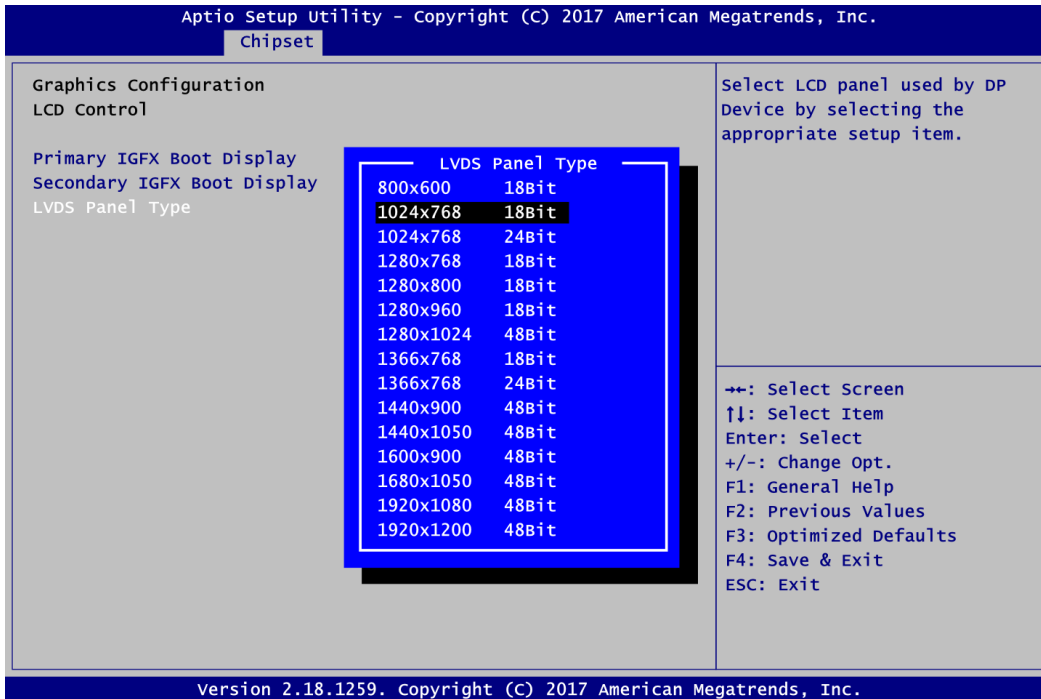

LVDS Panel Type

Select LVDS panel resolution.

- **Memory Information**

This screen shows the system memory information.

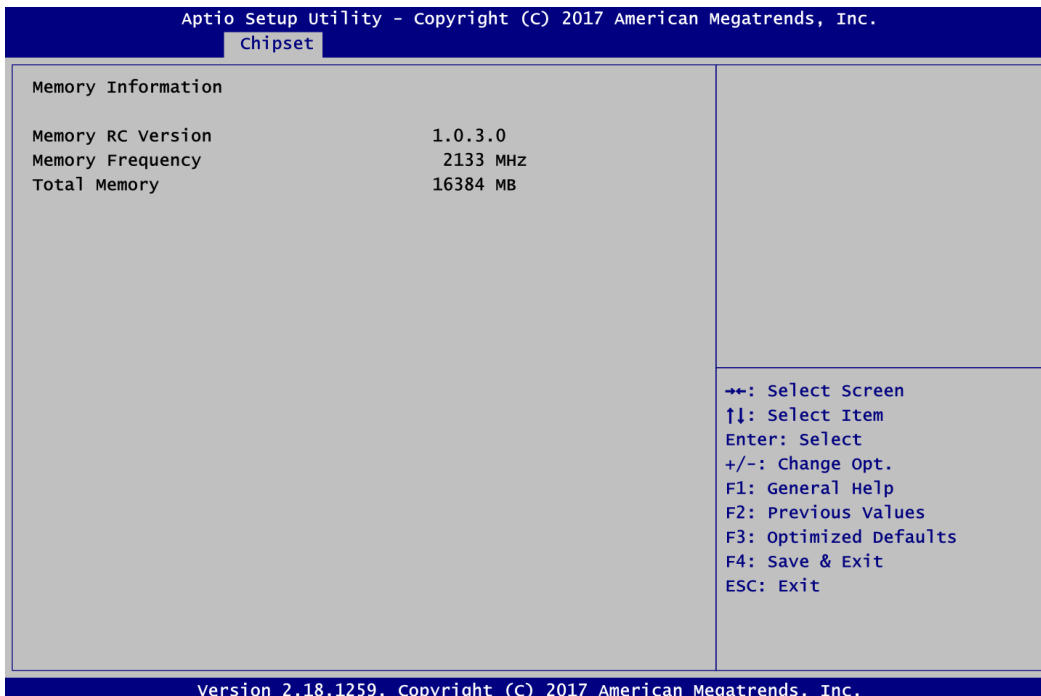

4.6 Security Menu

The Security menu allows users to change the security settings for the system.



- **Setup Administrator Password**
Use this item to set setup administrator password.
- **User Password**
Use this item to set user password.

4.7 Boot Menu

The Boot menu allows users to change boot options of the system.

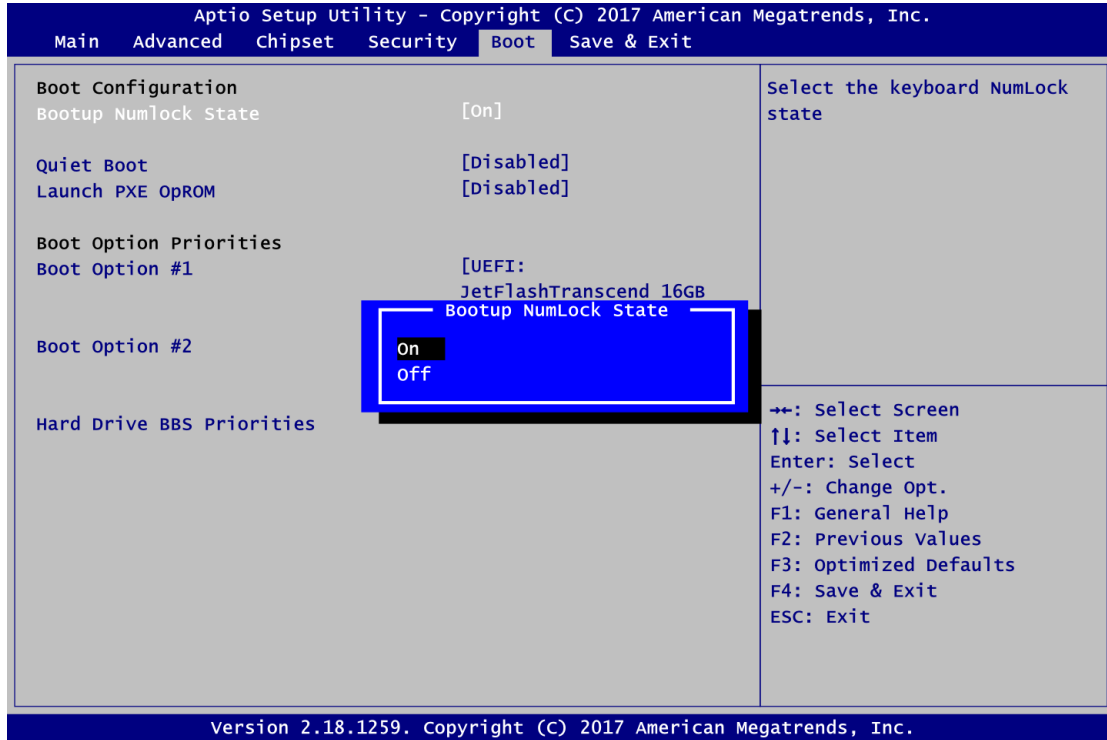

- Bootup NumLock State**
 Use this item to select the power-on state for the keyboard NumLock.
- Quiet Boot**
 Select to display either POST output messages or a splash screen during boot-up.

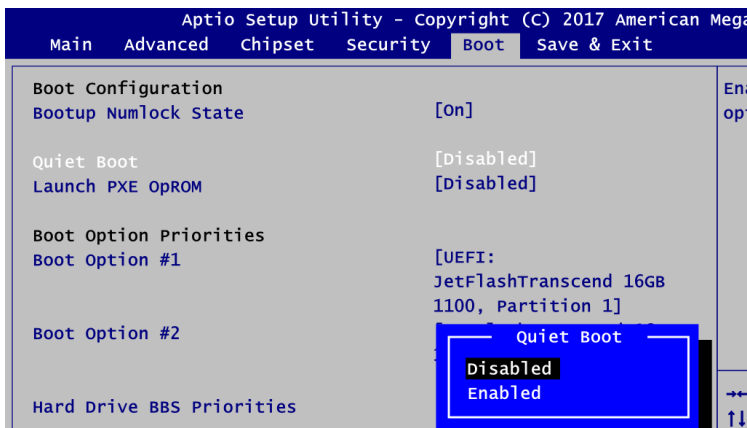

- **Launch PXE OpROM**

Use this item to enable or disable the boot ROM function of the onboard LAN chip when the system boots up.

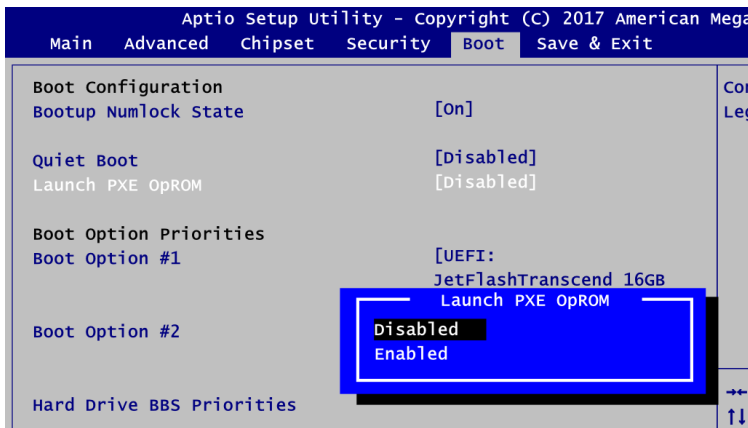

- **Boot Option Priorities [Boot Option #1, ...]**

These are settings for boot priority. Specify the boot device priority sequence from the available devices.

- **Hard Drive BBS Priorities**

These are settings for configuring the order for a specific device group. These options are only visible if at least one device for this group is present.

4.8 Save & Exit Menu

The Save & Exit menu allows users to load your system configuration with optimal or fail-safe default values.

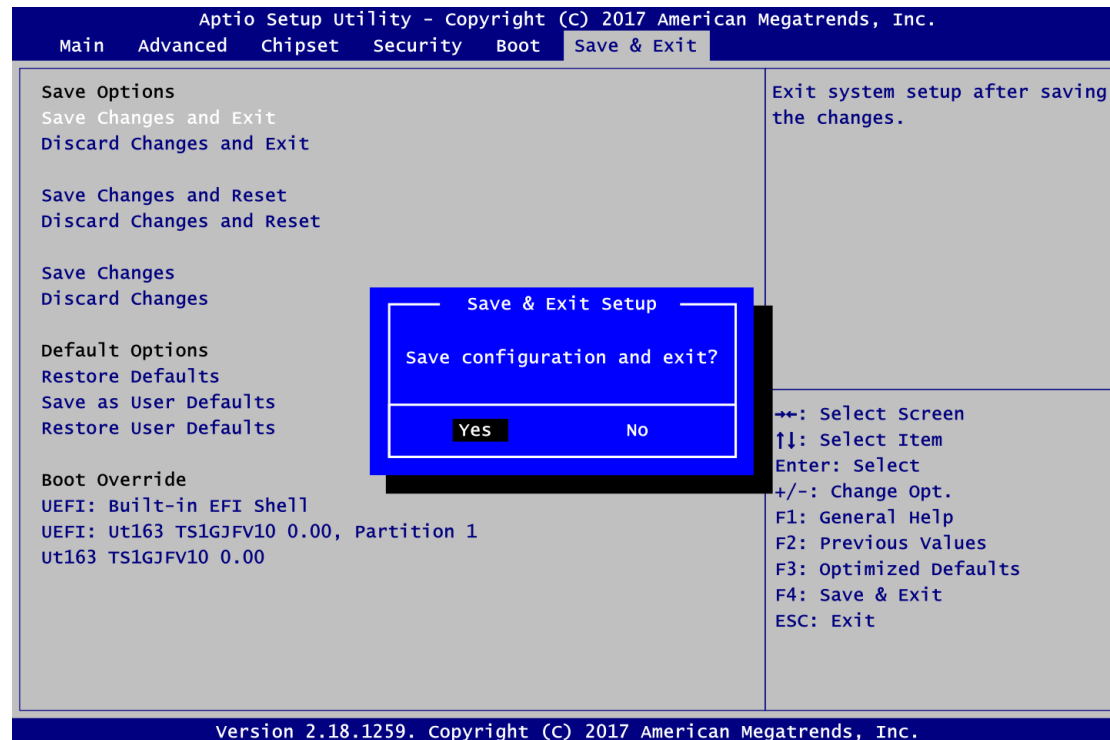

- Save Changes and Exit**
 When you have completed the system configuration changes, select this option to leave Setup and return to Main Menu. Select Save Changes and Exit from the Save & Exit menu and press <Enter>. Select Yes to save changes and exit.
- Discard Changes and Exit**
 Select this option to quit Setup without making any permanent changes to the system configuration and return to Main Menu. Select Discard Changes and Exit from the Save & Exit menu and press <Enter>. Select Yes to discard changes and exit.
- Save Changes and Reset**
 When you have completed the system configuration changes, select this option to leave Setup and reboot the computer so the new system configuration parameters can take effect. Select Save Changes and Reset from the Save & Exit menu and press <Enter>. Select Yes to save changes and reset.
- Discard Changes and Reset**
 Select this option to quit Setup without making any permanent changes to the system configuration and reboot the computer. Select Discard Changes and Reset from the Save & Exit menu and press <Enter>. Select Yes to discard changes and reset.
- Save Changes**
 Select this option to save changes done so far. Select Save Changes from the Save & Exit menu and press <Enter>. Select Yes to save changes.

- **Discard Changes**
Select this option to discard changes done so far and load previous values. Select Discard Changes from the Save & Exit menu and press <Enter>. Select Yes to discard changes.
- **Restore Defaults**
It automatically sets all Setup options to a complete set of default settings when you select this option. Select Restore Defaults from the Save & Exit menu and press <Enter>.
- **Save as User Defaults**
Select this option to save system configuration changes done so far as User Defaults. Select Save as User Defaults from the Save & Exit menu and press <Enter>.
- **Restore User Defaults**
It automatically sets all Setup options to a complete set of User Defaults when you select this option. Select Restore User Defaults from the Save & Exit menu and press <Enter>.
- **Boot Override**
Select a drive to immediately boot that device regardless of the current boot order.

Appendix A

I/O Board

The AX93A07 is an I/O expansion board which is suggested to attach carefully to PICO511. Its specifications and detailed information are given in this appendix.

A.1 AX93A07 Specifications

- **Size**
 - 100mm x 26mm
- **Features**
 - One D-Sub VGA port. VGA resolution is up to 1024x768 @60Hz.
 - One RJ-45 Ethernet port.
 - DC jack power connector.



Note

All specifications and images are subject to change without notice.

A.2 AX93A07 Dimensions and Fixing Holes

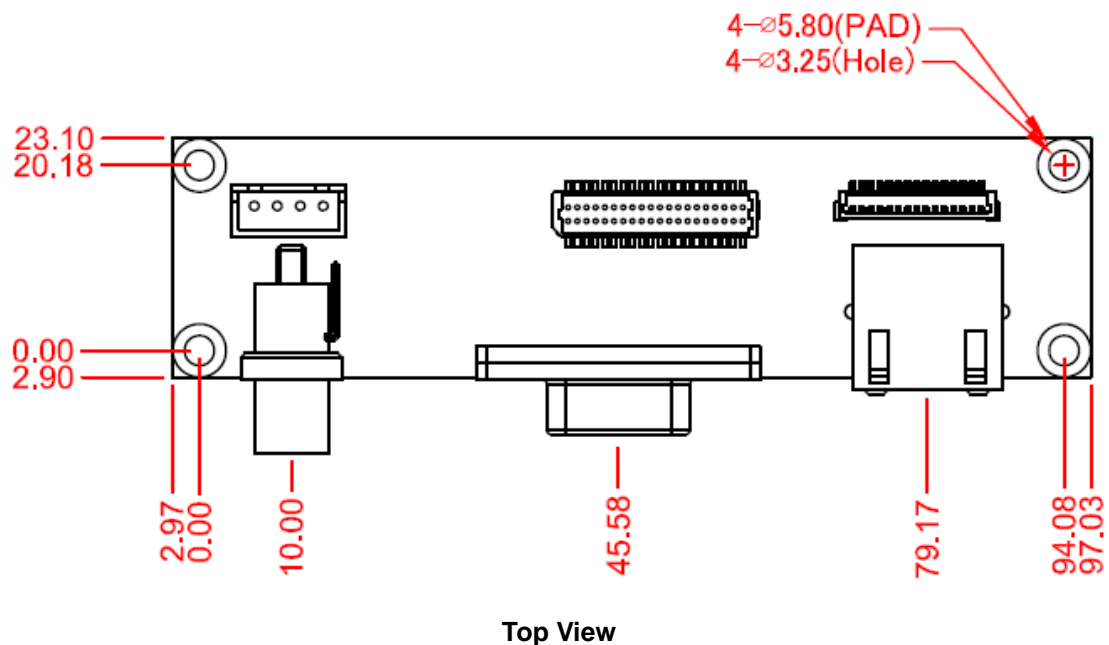

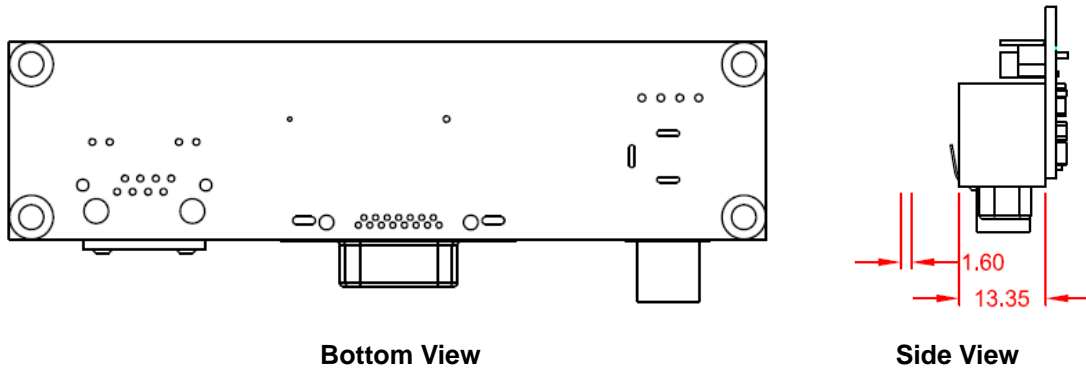

A.3 AX93A07 Board Layout

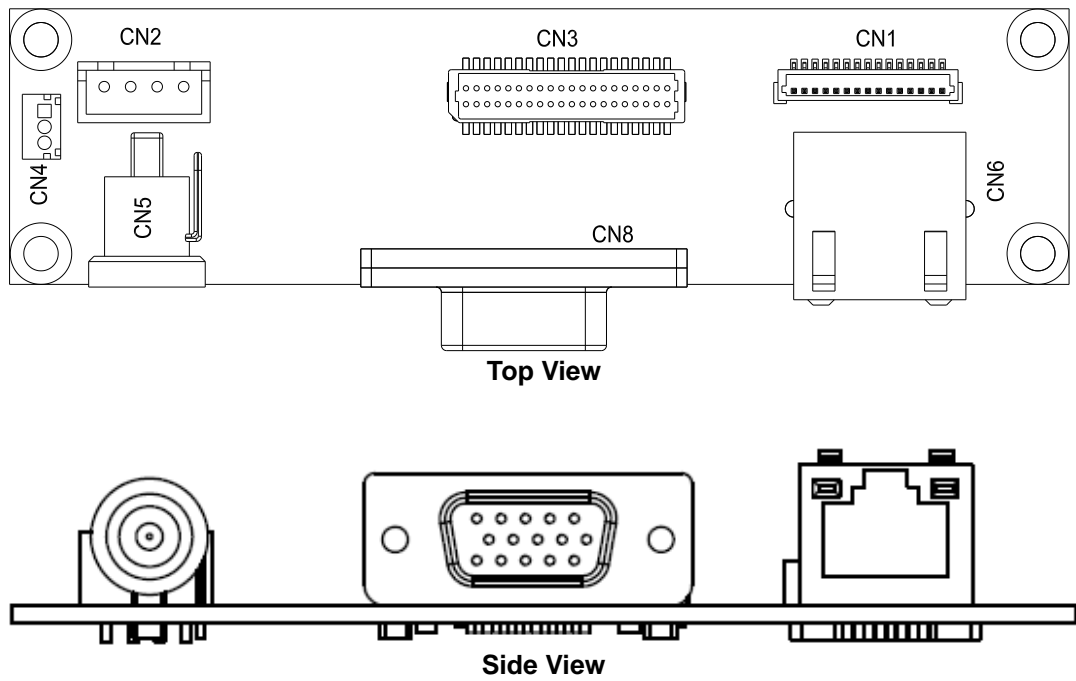

A.4 AX93A07 Connectors

Signals go to other parts of the system through connectors. Loose or improper connection might cause problems, please make sure all connectors are properly and firmly connected. Here is a summary table which shows all connectors on the hardware.

Connector	Description
CN1	Ethernet Board to Board Connector
CN2	DC Power Output Connector
CN3	LVDS Input Connector
CN4	SMBus Connector
CN5	DC Jack Power Input Connector w/ Screw
CN6	RJ-45 Ethernet Port
CN8	D-Sub VGA Output Connector

A.4.1 Ethernet Board to Board Connector (CN1)

This is a 15-pin wafer connector for Ethernet interface. Gently connect this CN1 to PICO511's CN15.

Pin	Signal
1	1000 LAN LED
2	100 LAN LED
3	GND
4	MDI3-
5	MDI3+
6	MDI1-
7	MDI2-
8	MDI2+
9	MDI1+
10	MDI0-
11	MDI0+
12	GND
13	LAN_VDD33
14	LAN_LINK_ACT
15	GND



A.4.2 DC Power Output Connector (CN2)

This is a 4-pin wafer connector for DC +12V. Gently connect this CN2 to PICO511's CN14.

Pin	Signal
1	+12V
2	+12V
3	GND
4	GND

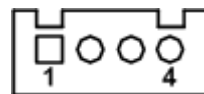

A.4.3 LVDS Input Connector (CN3)

This board has a 2x20-pin connector for LVDS LCD interface. It is strongly recommended to use the matching JST SHDR-40VS-B connector. The LVDS input signals go through this connector and converted by CH7036 IC to VGA signals on CN8. Note that pin 1~6 VCCM must be set to +5V. Gently connect this CN3 to PICO511's CN12.

18-bit single channel

Pin	Signal	Pin	Signal
1	VCCM	2	VCCM
3	VCCM	4	VCCM
5	VCCM	6	VCCM
7	N.C.	8	BKL_EN
9	GND	10	GND
11	N.C.	12	N.C.
13	N.C.	14	N.C.
15	GND	16	GND
17	N.C.	18	N.C.
19	N.C.	20	N.C.
21	GND	22	GND
23	Channel A D0-	24	N.C.
25	Channel A D0+	26	N.C.
27	GND	28	GND
29	Channel A D1-	30	N.C.
31	Channel A D1+	32	N.C.
33	GND	34	GND
35	Channel A D2-	36	Channel A CLK-
37	Channel A D2+	38	Channel A CLK+
39	GND	40	GND



A.4.4 SMBus Connector (CN4)

This is a 3-pin (pitch=1.5mm) wafer connector. The SMBus (System Management Bus) is a simple bus for the purpose of lightweight communication. Gently connect this CN4 to PICO511's CN10.

Pin	Signal
1	SMBus clock
2	SMBus data
3	GND



A.4.5 DC Jack Power Input Connector w/ Screw (CN5)

The CN5 is a DC jack with screw. Firmly insert at least 60W adapter into this connector. Loose connection may cause system instability and make sure all components/devices are properly installed before connecting.

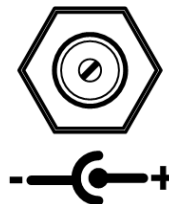

A.4.6 RJ-45 Ethernet Port (CN6)

The board has one RJ-45 Ethernet connector. Connection can be established by plugging one end of the Ethernet cable into this RJ-45 and the other end (phone jack) to a 1000/100/10 Base-T hub.

Pin	Signal	Pin	Signal
L1	MDI0P	L5	MDI2P
L2	MDI0N	L6	MDI2N
L3	MDI1P	L7	MDI3P
L4	MDI1N	L8	MDI3N
A	Active LED (Yellow)		
B	1000 LAN LED (Orange) / 100 LAN LED (Green)		

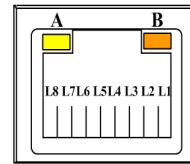

A.4.7 D-Sub VGA Connector (CN8)

The CN8 is a standard 15-pin D-Sub connector which is commonly used for VGA display. This VGA interface configuration can be configured via software utility.

Pin	Signal	Pin	Signal
1	RED	2	GREEN
3	BLUE	4	N.C
5	GND	6	CRT_DETE
7	GND	8	GND
9	CRT_VCC	10	GND
11	N.C	12	DDC_DATA
13	HSYNC	14	VSYNC
15	DDC_CLK		

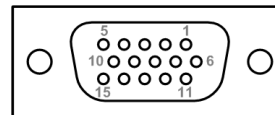

This page is intentionally left blank.

Appendix B

Watchdog Timer

B.1 About Watchdog Timer

After the system stops working for a while, it can be auto-reset by the watchdog timer. The integrated watchdog timer can be set up in the system reset mode by program.

B.2 How to Use Watchdog Timer

Assembly sample code :

```
mov    dx,fa10          ; 5 seconds (Maximum is 65535 seconds; fill in
                        ; 0xFA10 and 0xFA11 register, ex: 0xFA11=0x01,
                        ; 0xFA10=0x68 means 360 seconds)
mov    al,05
out    dx,al

mov    dx,fa12          ; Enable WDT
mov    al,01
out    dx,al
```

This page is intentionally left blank.

Appendix C

iAMT Settings

The Intel® Active Management Technology (Intel® iAMT) has decreased a major barrier to IT efficiency that uses built-in platform capabilities and popular third-party management and security applications to allow IT a better discovering, healing, and protection their networked computing assets.

In order to utilize Intel® iAMT you must enter the ME BIOS (<Ctrl + P> during system startup), change the ME BIOS password, and then select “Intel® iAMT” as the manageability feature.

C.1 Entering MEBx

1. Go to BIOS to enable iAMT function (see section 4.4).
2. Exit from BIOS after starting iAMT, and press <Ctrl + P> to enter MEBx Setting.



Note

It is better to press <Ctrl + P> before the screen popping out.

C.2 Set and Change Password

1. You will be asked to set a password when first log in. The default password is “admin”.

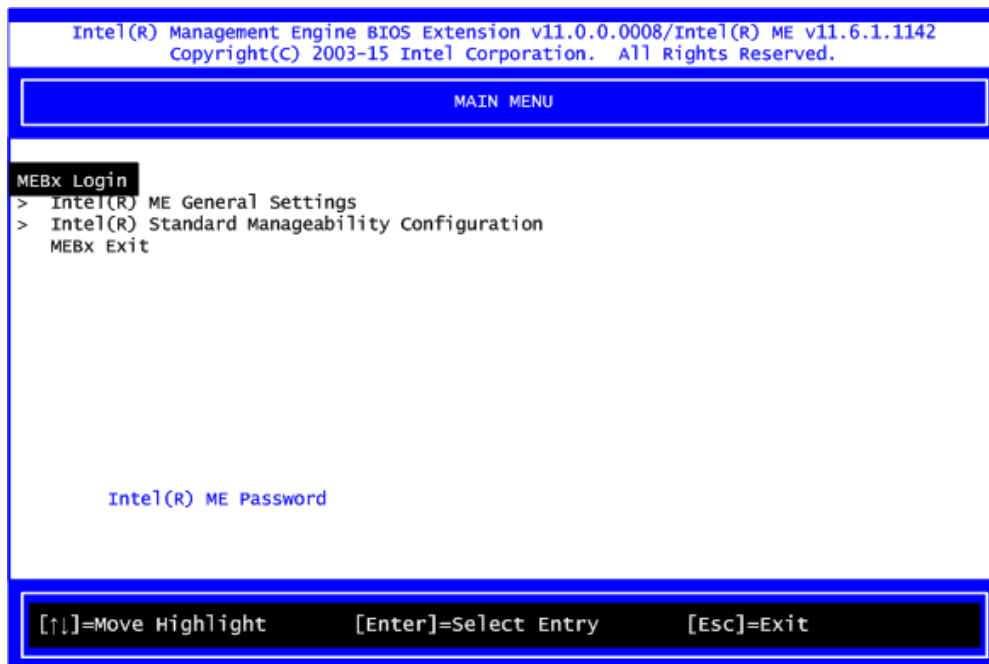

2. You will be asked to change the password before setting ME.
3. You must confirm your new password while revising. The new password must contain:
(example: **!!11qqQQ**) (default value).
 - Eight characters
 - One upper case
 - One lower case
 - One number
 - One special symbol, such as ! ` \$ or ; ` (` " , excepted)

Underline (_) and space are valid characters for password, but they won't make higher complexity.

4. From Main Menu, select ME General Settings to get into ME Platform Configuration screen. In this screen you can modify Local FW Update setting.

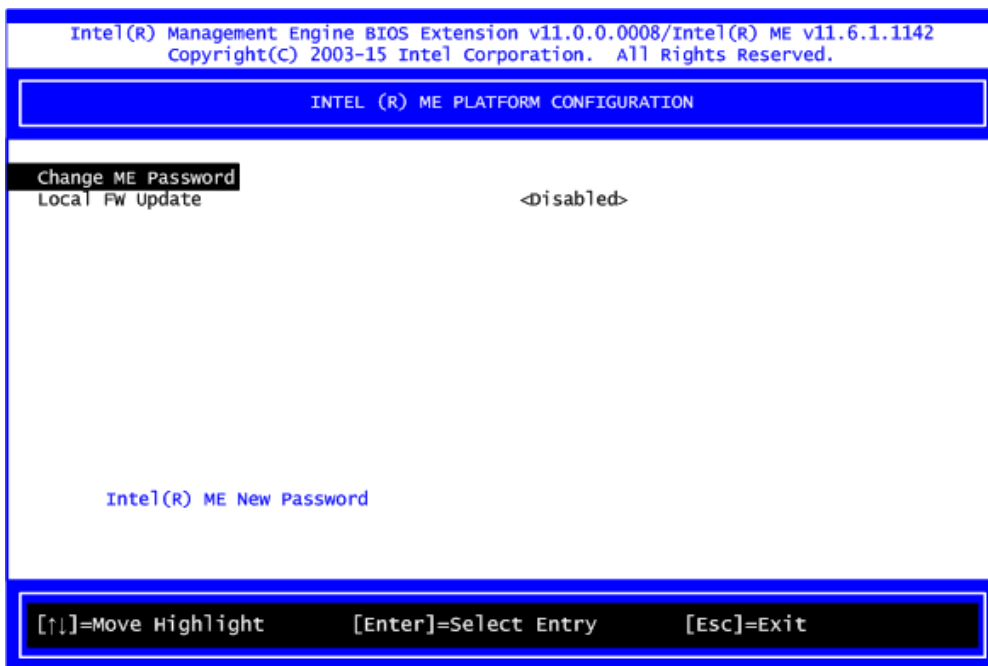

5. Return to Main Menu.

C.3 iAMT Configuration

1. From Main Menu, select Intel® Standard Manageability Configuration and press <Enter>.
2. Set Manageability Feature Selection to Enabled.

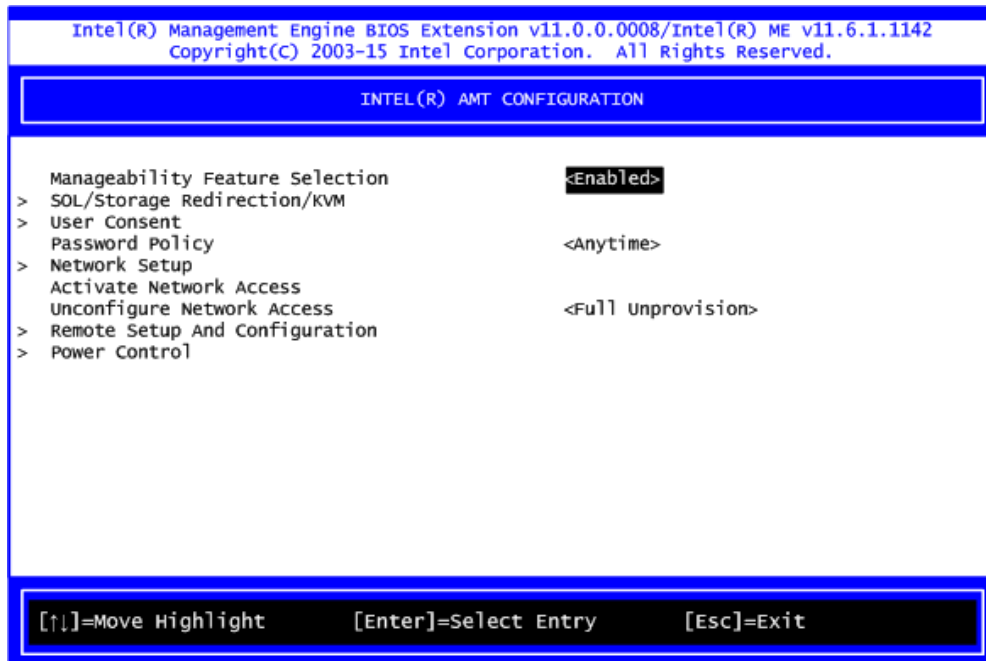

- **SOL/Storage Redirection/KVM**

This screen is for enabling or disabling Serial-over-LAN (SOL)/Storage Redirection/Keyboard Video Mouse (KVM) functionality.

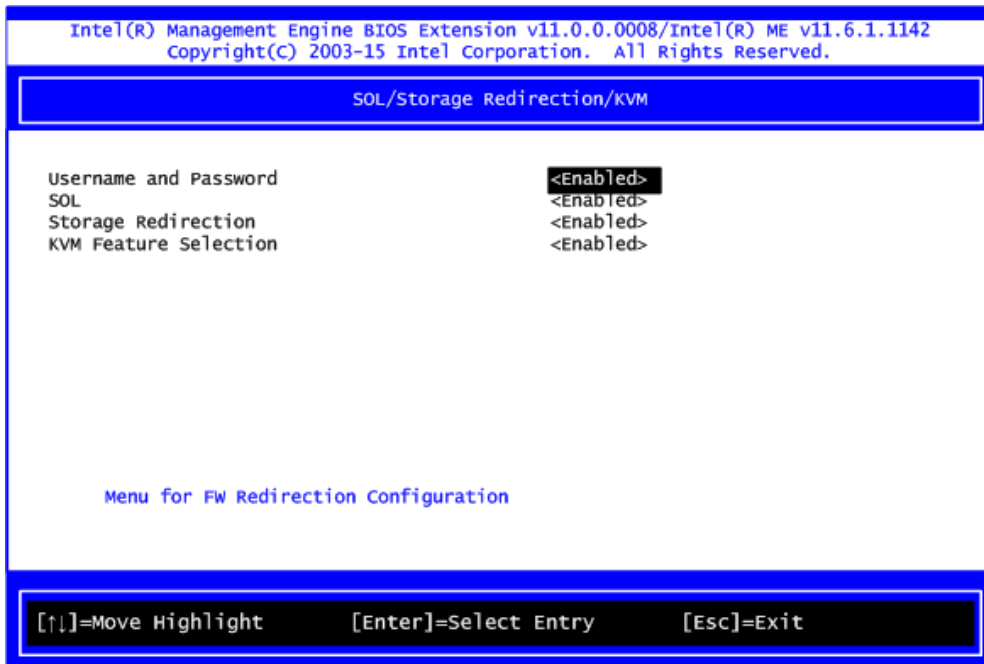

- **User Consent**

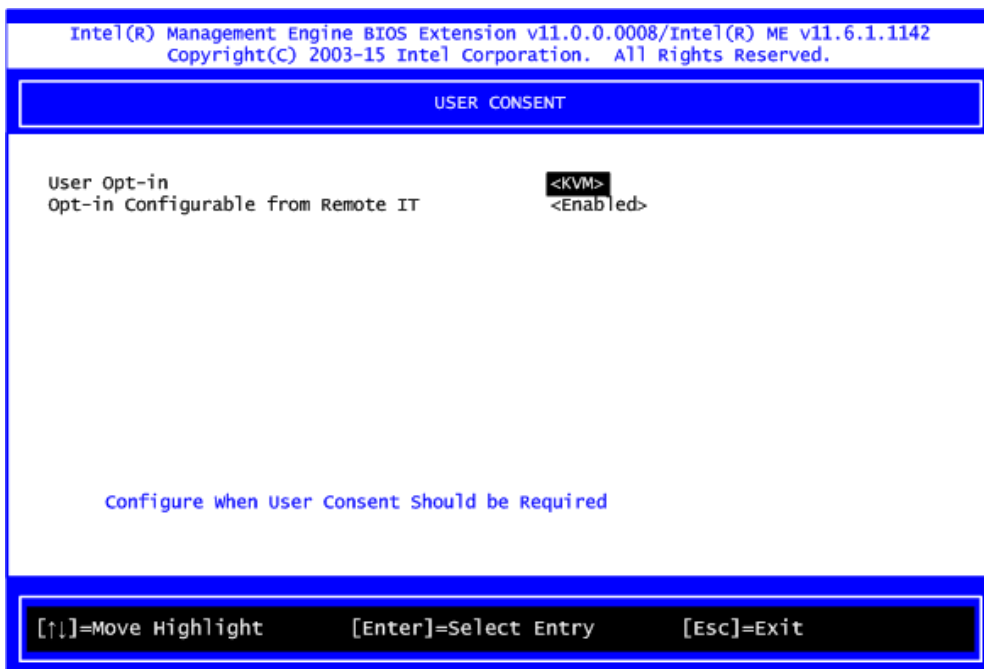

User Opt-in

Configure this item when user consent should be required.

Opt-in Configurable from Remote IT

Enable or disable remote change capability of user consent feature.

- **Network Setup**

1. From Intel® AMT Configuration Menu, select Network Setup.
2. Select ME Network Name Settings to set computer host and domain name.

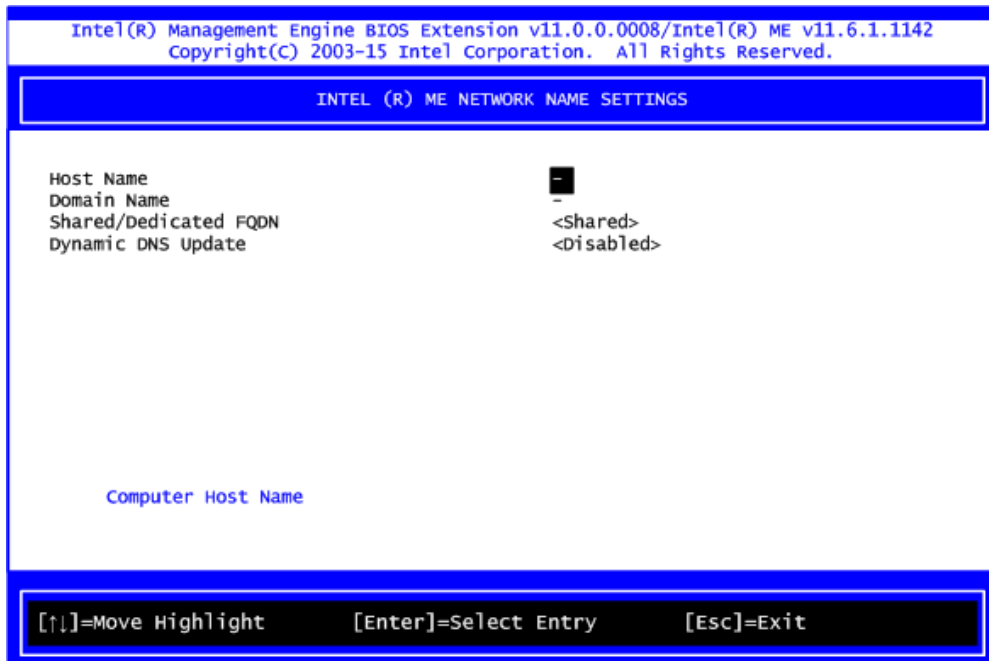
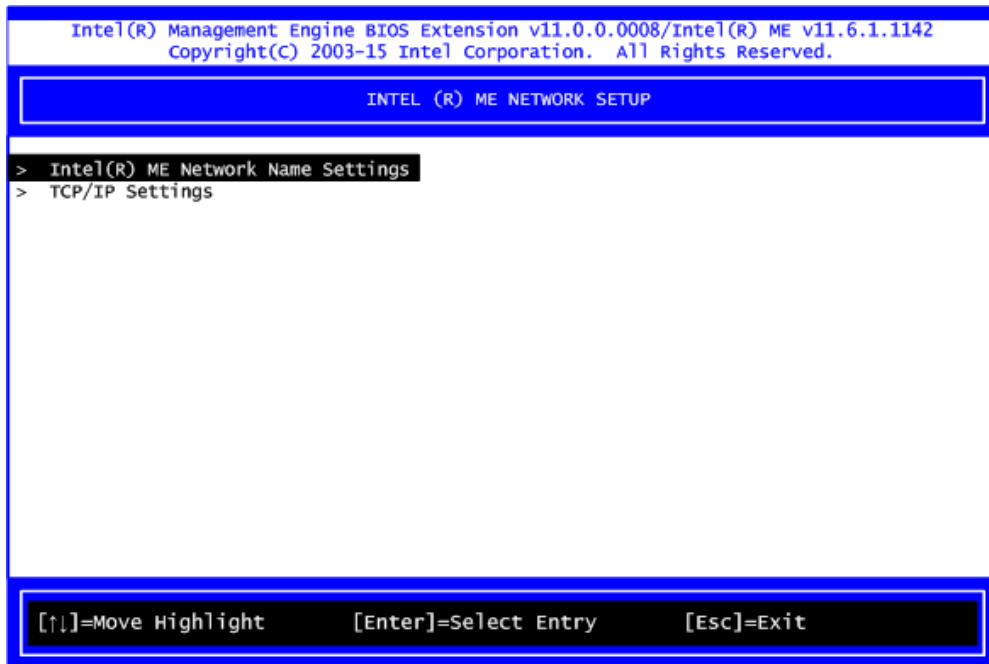

3. Select TCP/IP to get into Network interface. Get into DHCP Mode and set it to Disabled.

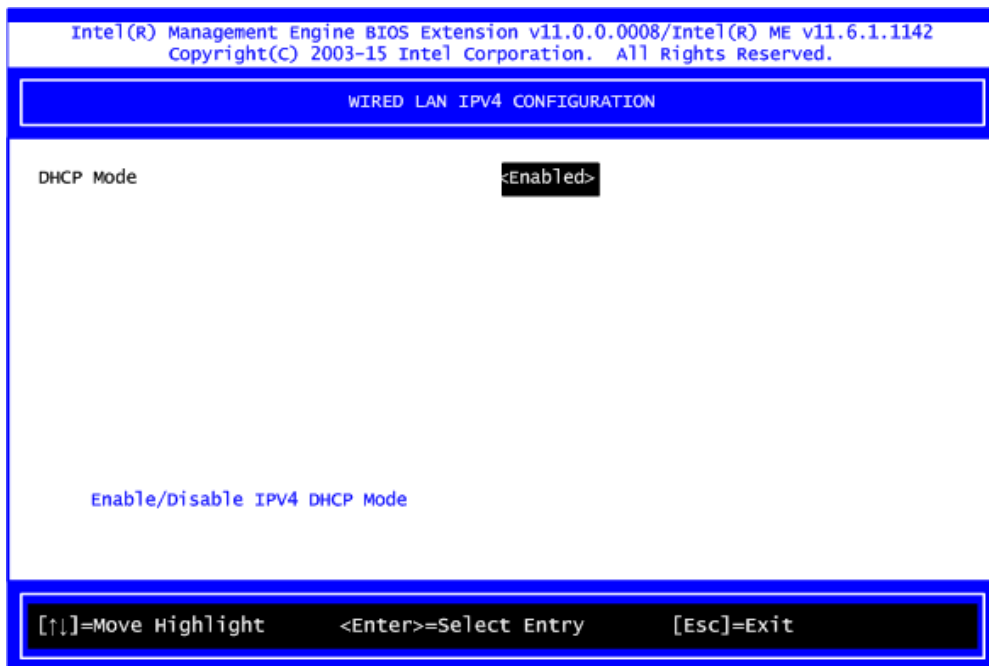
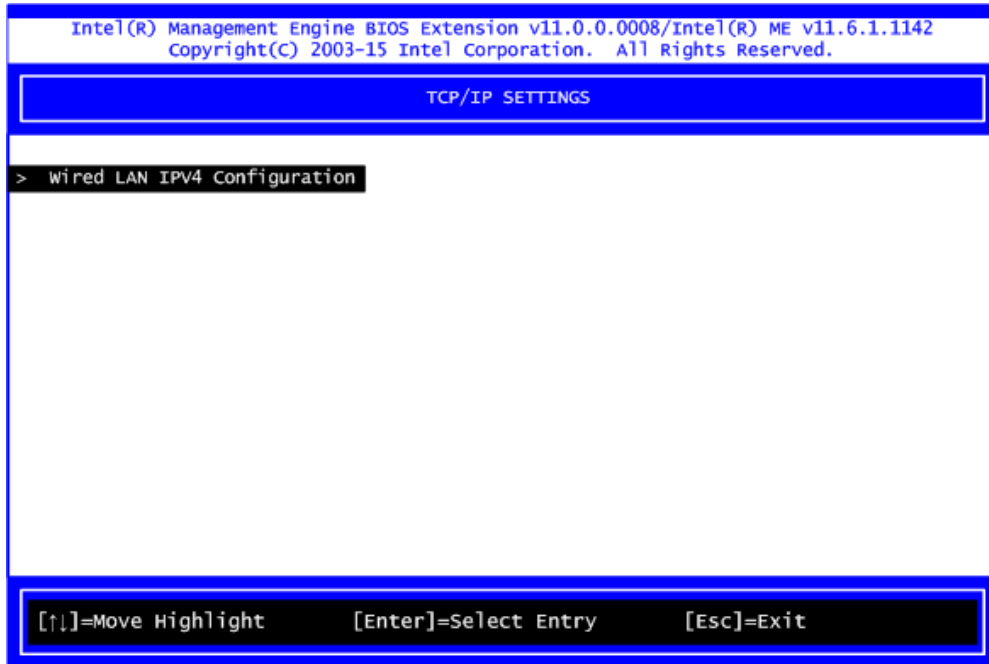

4. If DHCP Mode is disabled, set the following settings:
 - IP address
 - Subnet mask

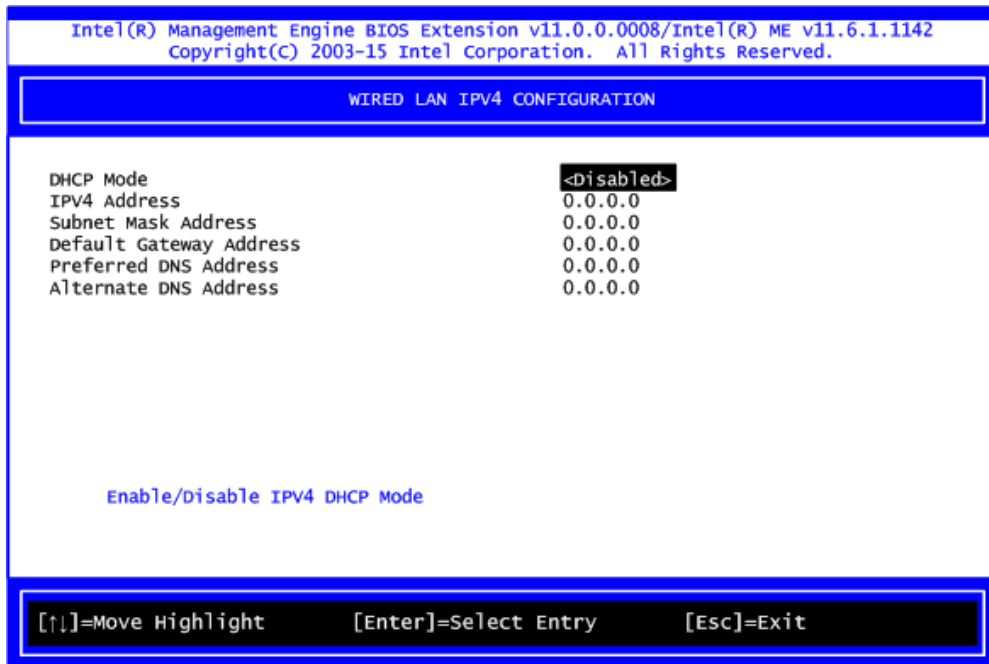

5. Go back to Intel® iAMT Configuration, then select Activate Network Access and press <Enter>.

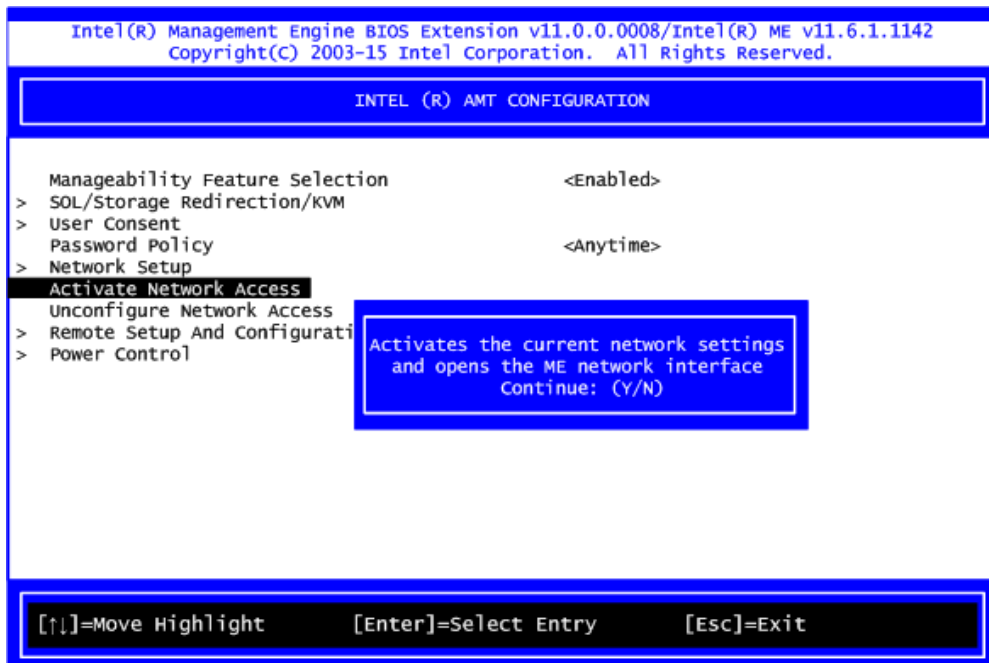

6. Exit from MEBx after completing the iAMT settings.

- Remote Setup and Configuration

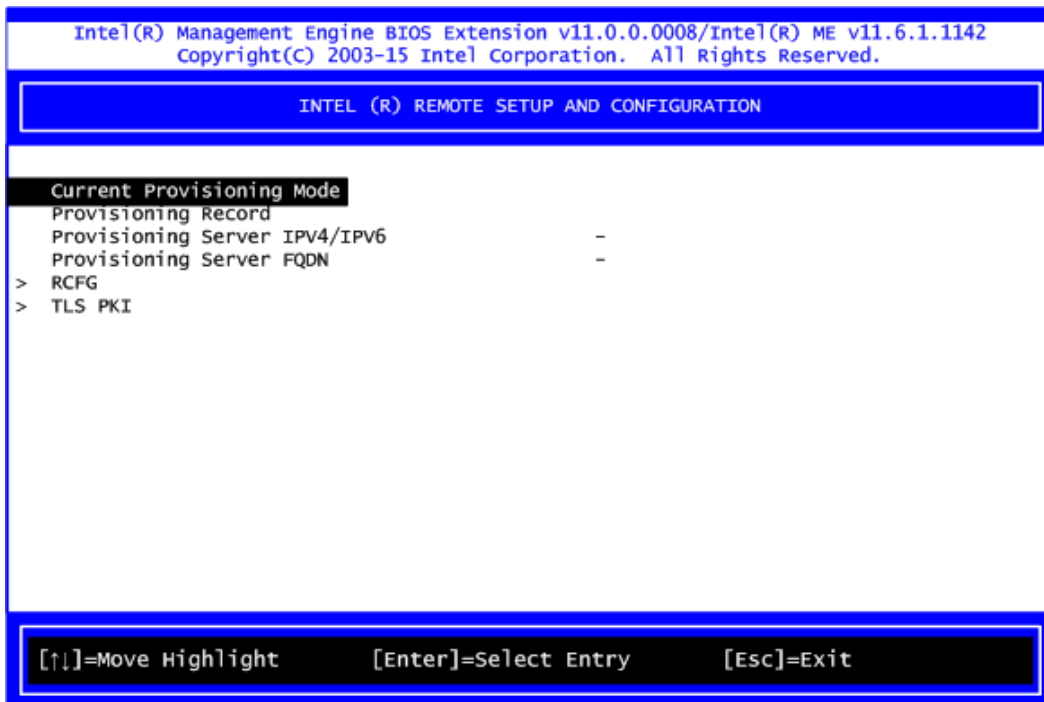

1. Select TLS PKI to get into remote configuration screen. Then select Start Configuration to activate it.

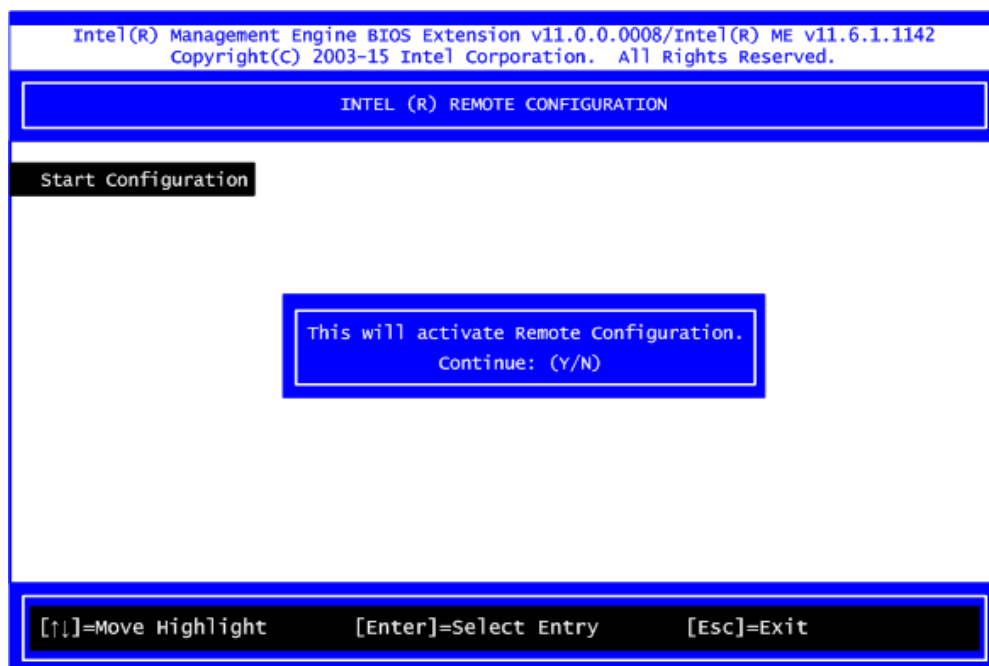

2. Select Manage Hashes to add, delete and activate hash.

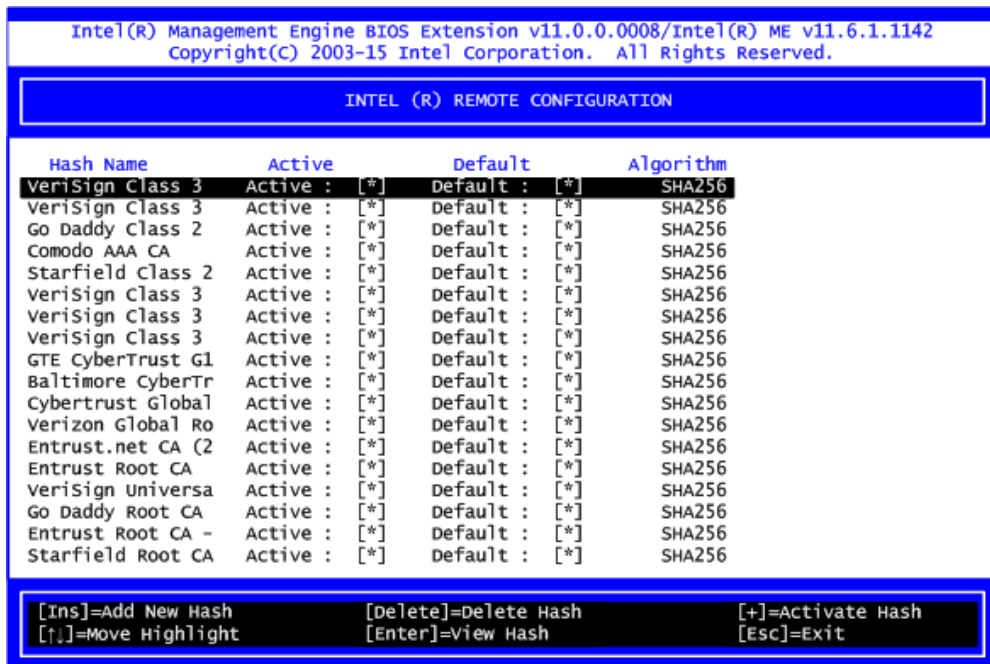
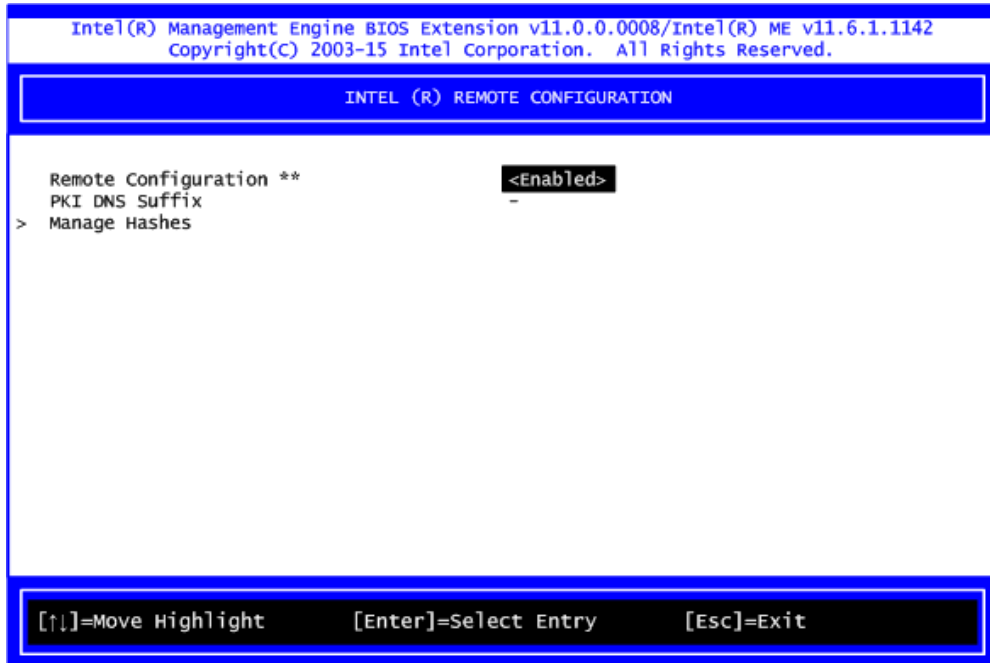

- **Power Control**

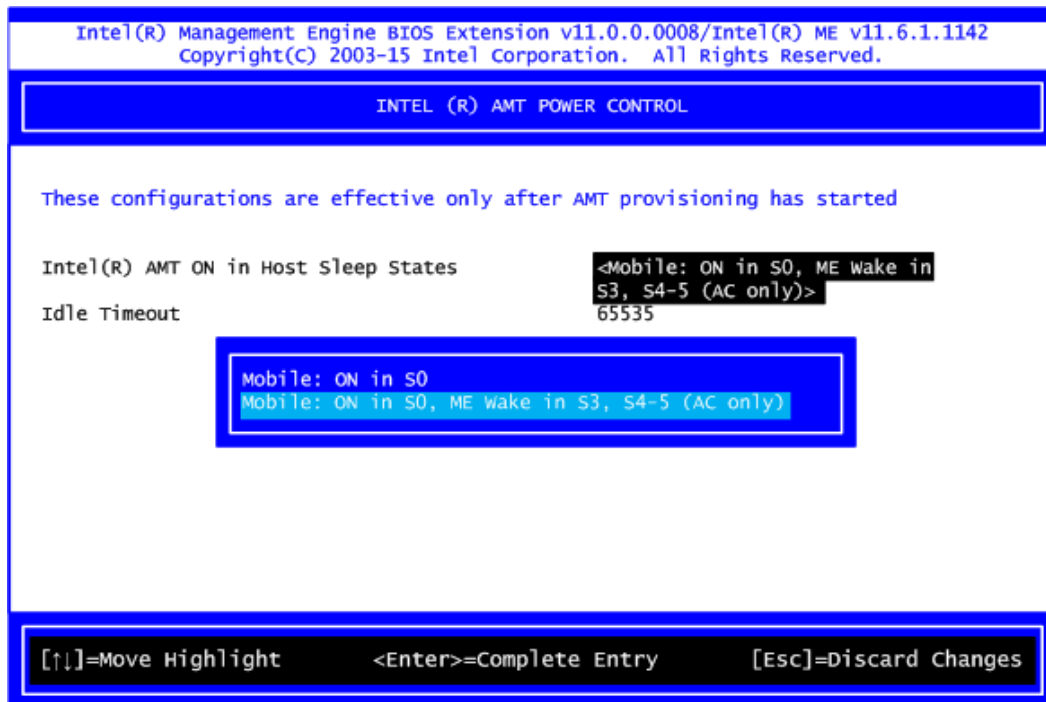

AMT ON in Host Sleep States

Select the appropriate AMT ON in Host Sleep States setting. Options are ON in S0 and ON in S0, ME Wake in S3, S4-5 (AC only).

Idle Timeout

This is timeout value for Wake_On_ME in minutes. It must be set to a non-zero value.

C.4 iAMT Web Console

1. From a web browser, please type `http://(IP ADDRESS):16992`, which connects to iAMT Web.

Example: <http://10.1.40.214:16992>

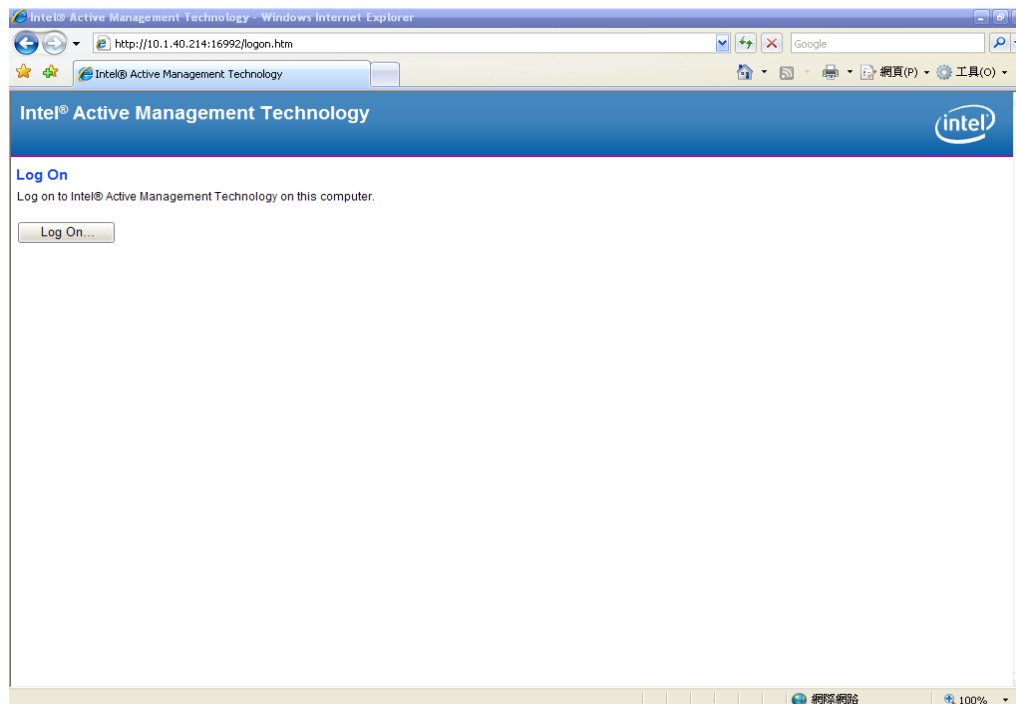

2. To log on, you will be required to type in username and password for access to the Web.

USER: admin (default value)
PASS: (MEBx password)

3. Enter the iAMT Web.

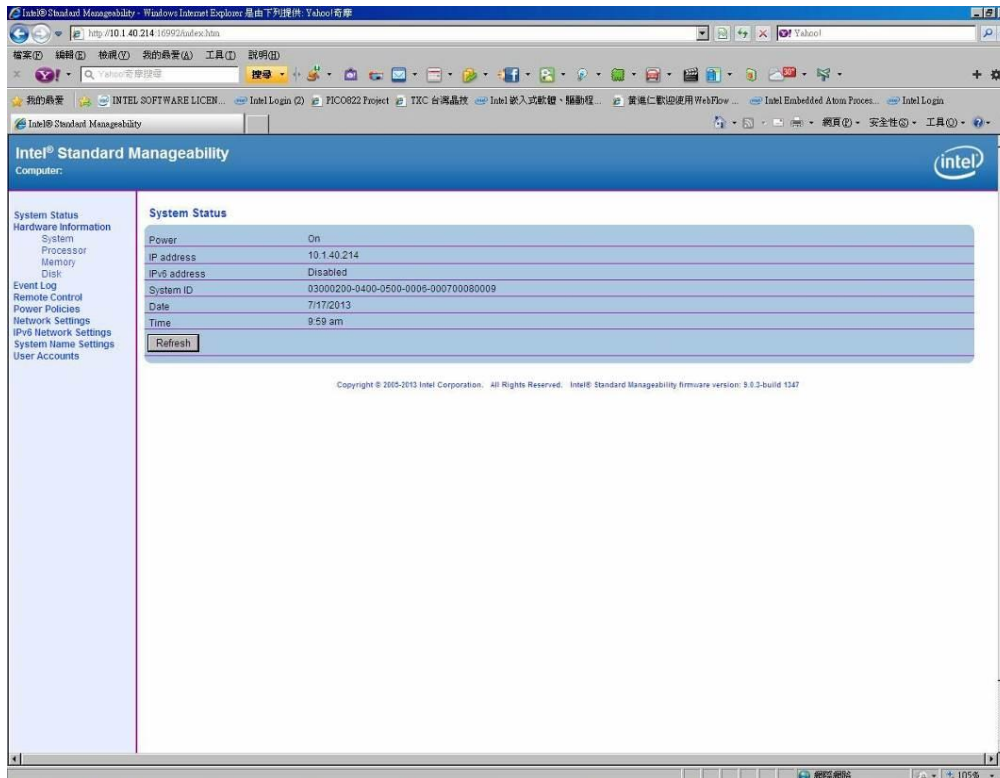

4. Click Remote Control, and select commands on the right side.

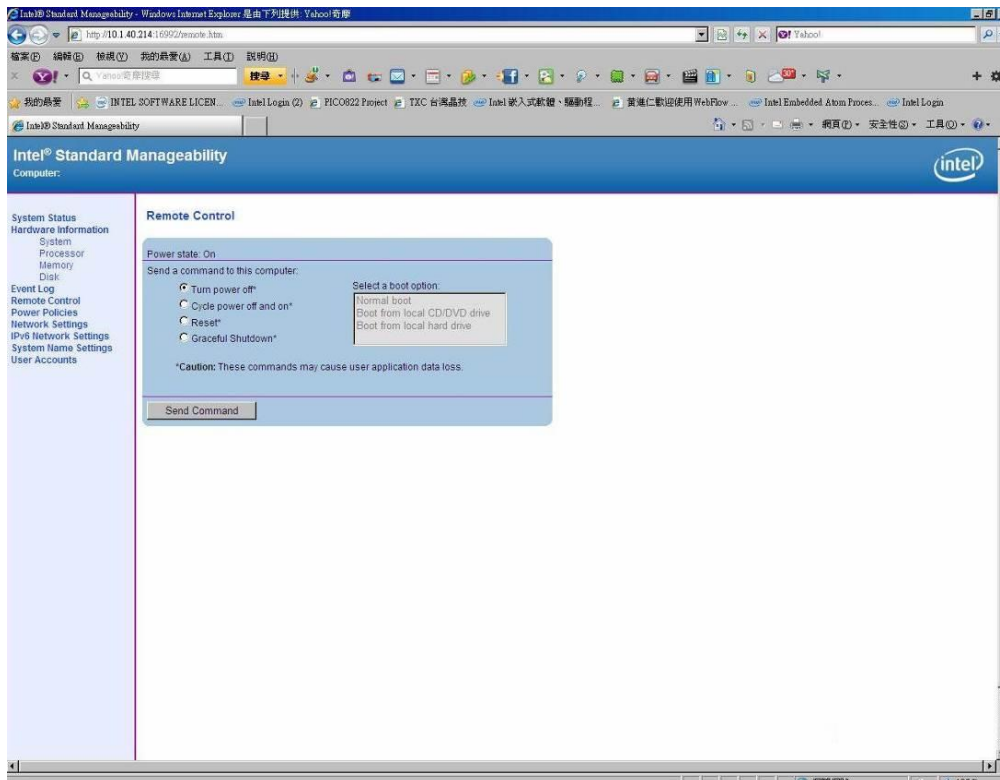

5. When you have finished using the iAMT Web console, close the Web browser.

Appendix D

BIOS Flash Utility

The BIOS Flash utility is a new helpful function in BIOS setup program. With this function you can easily update system BIOS without having to enter operating system. In this appendix you may learn how to do it in just a few steps. Please read and follow the instructions below carefully.

1. In your USB flash drive, create a new folder and name it “Axiomtek”, see figure below.

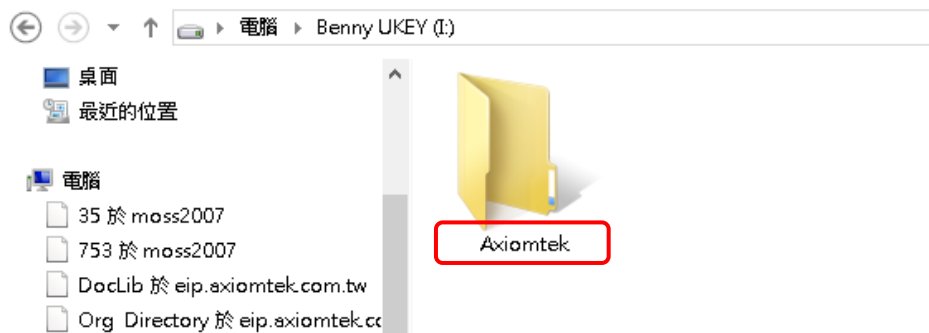

2. Copy BIOS ROM file (e.g. PICO511.005) to “Axiomtek” folder.

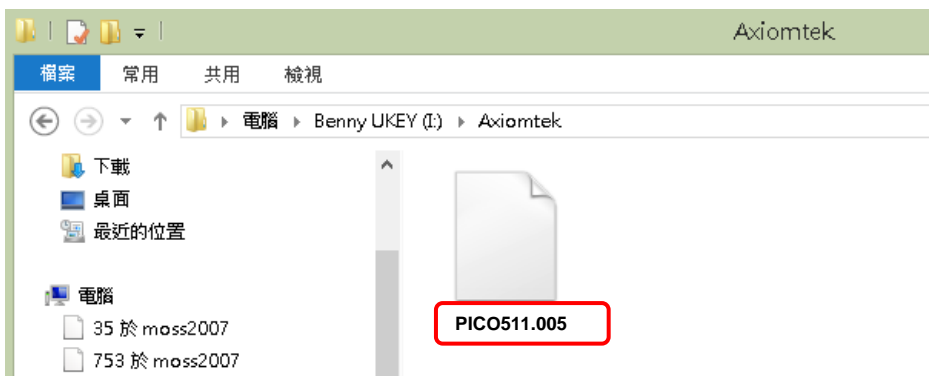

3. Insert the USB flash drive to your system.
4. Enter BIOS setup menu and go to Advanced\Utility Configuration. Select BIOS Flash Utility and press <Enter>.

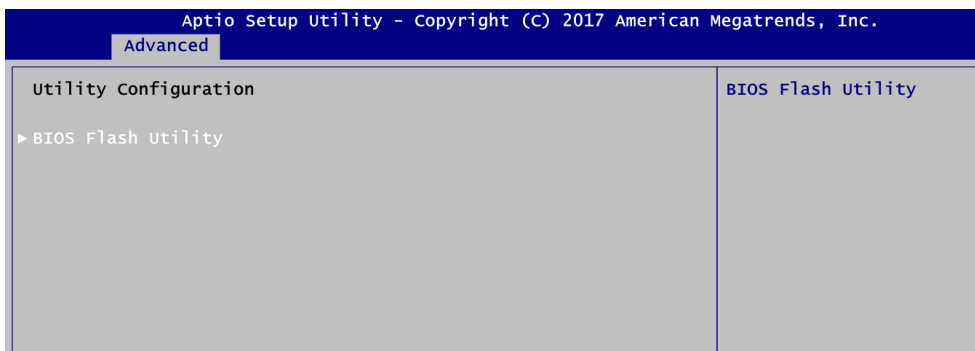

5. BIOS automatically detect all USB drive(s) attached to the system. In this example only one USB drive is attached to the system. That's why, you can see only one device is displayed in figure below.

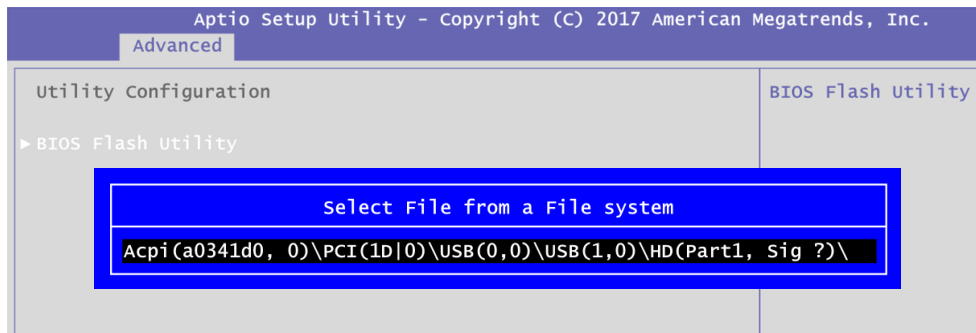

6. Select the USB drive containing BIOS ROM file you want to update using the <↑> or <↓> key. Then press <Enter> to get into "Axiomtek" folder.

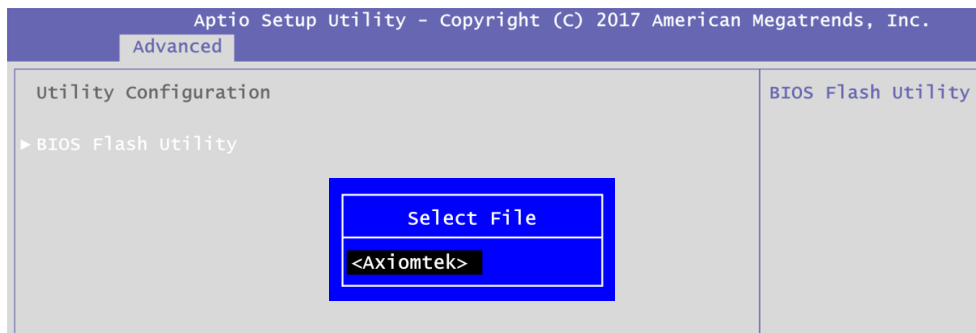

7. Now you can see the BIOS ROM file on the screen, press <Enter> to select.

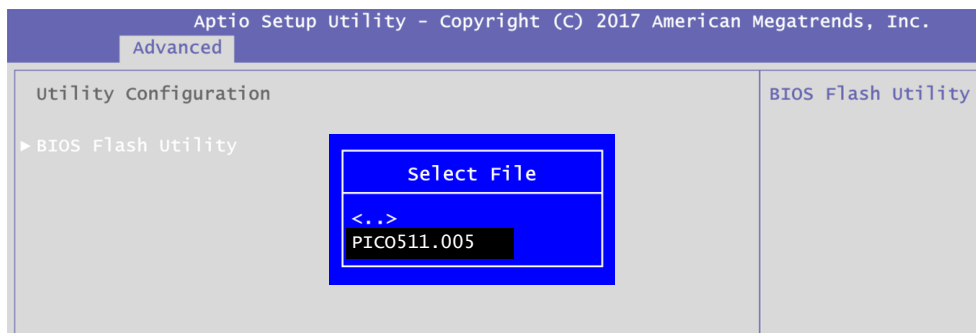

8. Select Start to flash system BIOS option to begin updating procedure.

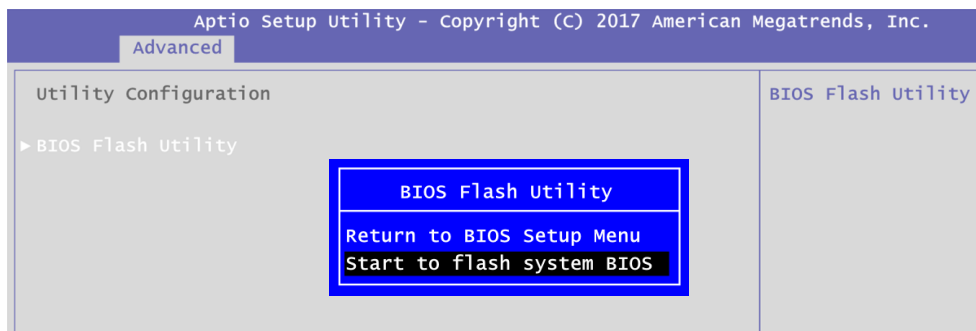

- Please wait while BIOS completes the entire flash update process: erase data, write new data and verify data.

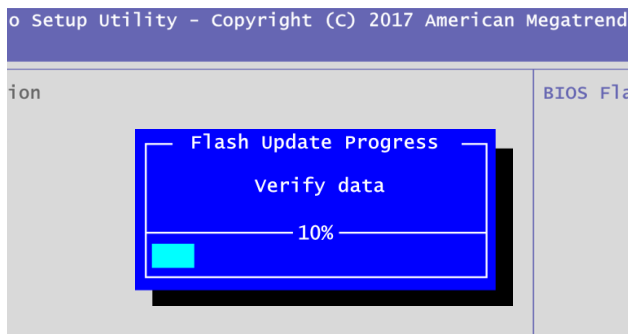
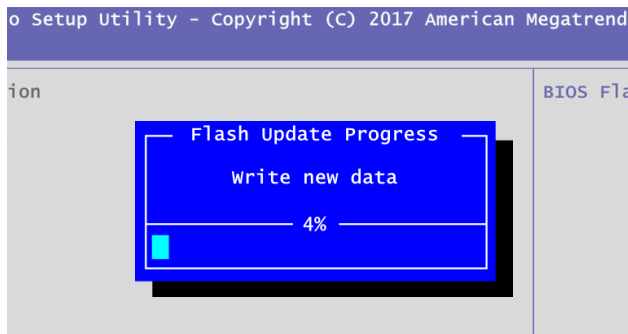
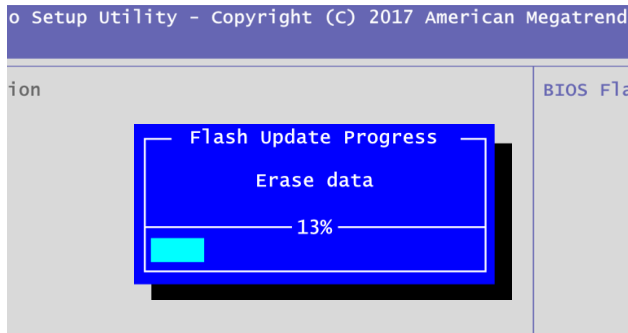

- When you see the following figure, press <Enter> to finish the update process. After that the system will shut down and restart immediately.

