



AXIOMTEK

SHB140 Series

**Intel® Socket 1151 Core™ i7/ i5/ i3
Processors PICMG® v1.3 Full-size
CPU Card**

User's Manual



Disclaimers

This manual has been carefully checked and believed to contain accurate information. Axiomtek Co., Ltd. assumes no responsibility for any infringements of patents or any third party's rights, and any liability arising from such use.

Axiomtek does not warrant or assume any legal liability or responsibility for the accuracy, completeness or usefulness of any information in this document. Axiomtek does not make any commitment to update the information in this manual.

Axiomtek reserves the right to change or revise this document and/or product at any time without notice.

No part of this document may be reproduced, stored in a retrieval system, or transmitted, in any form or by any means, electronic, mechanical, photocopying, recording, or otherwise, without the prior written permission of Axiomtek Co., Ltd.

CAUTION

If you replace wrong batteries, it causes the danger of explosion. It is recommended by the manufacturer that you follow the manufacturer's instructions to only replace the same or equivalent type of battery, and dispose of used ones.

©Copyright 2017 Axiomtek Co., Ltd.

All Rights Reserved

July 2017, Version A3

Printed in Taiwan

ESD Precautions

Computer boards have integrated circuits sensitive to static electricity. To prevent chipsets from electrostatic discharge damage, please take care of the following jobs with precautions:

- Do not remove boards or integrated circuits from their anti-static packaging until you are ready to install them.
- Before holding the board or integrated circuit, touch an unpainted portion of the system unit chassis for a few seconds. It discharges static electricity from your body.
- Wear a wrist-grounding strap, available from most electronic component stores, when handling boards and components.

Trademarks Acknowledgments

Axiomtek is a trademark of Axiomtek Co., Ltd.

Intel® Core™ i7/ i5/ i3 are trademarks of Intel Corporation.

Windows® is a trademark of Microsoft Corporation.

AMI is a trademark of American Megatrend Inc.

IBM, PC/AT, PS/2, VGA are trademarks of International Business Machines Corporation.

Other brand names and trademarks are the properties and registered brands of their respective owners.

Table of Contents

Disclaimers.....	ii
ESD Precautions.....	iii
Chapter 1 Introduction.....	1
1.1 Features.....	1
1.2 Specifications.....	2
1.3 Utilities Supported.....	3
Chapter 2 Board and Pin Assignments.....	5
2.1 Board Dimensions and Fixing Holes.....	5
2.2 Board Layout.....	6
2.3 Jumper Settings.....	8
2.3.1 Auto Power On (JP2).....	9
2.3.2 Restore BIOS Optimal Defaults (JP3).....	9
2.3.3 PCI IO Voltage Selection (JP4).....	9
2.4 Connectors.....	10
2.4.1 SMBus Connector (CN1).....	11
2.4.2 Temperature Sensor Connector (CN2).....	11
2.4.3 LAN LED Connectors (CN3 and CN5).....	11
2.4.4 Ethernet Ports (CN4).....	12
2.4.5 Front Panel Connector (CN6).....	12
2.4.6 DVI-I Connector (CN8).....	13
2.4.7 Internal USB 2.0 Connectors (CN9~CN11).....	14
2.4.8 External USB 3.0 Connectors (CN12 and CN15).....	14
2.4.9 Internal PS/2 Keyboard and Mouse Connectors (CN13 and CN14).....	14
2.4.10 COM Connectors (COM1~COM6).....	15
2.4.11 FAN Connectors (FAN1, FAN2 and FAN3).....	15
2.4.12 SATA 3.0 Connectors (SATA1~SATA6).....	16
2.4.13 Intel® HD Audio Digital Header (HDA1).....	16
2.4.14 ATX Power Connector (ATX2).....	16
Chapter 3 Hardware Installation.....	17
3.1 Installing the Processor.....	17
3.2 Installing the Memory.....	20
Chapter 4 Hardware Description.....	21
4.1 Microprocessors.....	21

4.2	BIOS	21
4.3	System Memory.....	21
Chapter 5 AMI BIOS Setup Utility		23
5.1	Starting.....	23
5.2	Navigation Keys	23
5.3	Main Menu.....	24
5.4	Advanced Menu.....	25
5.5	Chipset Menu.....	34
5.6	Security Menu.....	36
5.7	Boot Menu.....	37
5.8	Save & Exit Menu	38
Appendix A Watchdog Timer.....		41
A.1	About Watchdog Timer	41
A.2	How to Use Watchdog Timer	41
Appendix B PCI IRQ Routing		43
B.1	PICMG [®] PCI IRQ Routing.....	43
Appendix C Configuring SATA for RAID		45
C.1	Configuring SATA Hard Drive(s) for RAID (Controller: Intel [®] Q170) 45	
Appendix D iAMT Settings		53
D.1	Entering MEBx.....	53
D.2	Set and Change Password	53
D.3	iAMT Settings	55
D.4	iAMT Web Console.....	58
Appendix E PICMG[®] v1.3 Interface Definition.....		61

This page is intentionally left blank.

Chapter 1

Introduction



The SHB140 PICMG® v1.3 full-size Single Board Computer supports LGA1151 socket for Intel® Core™ i7/ i5/ i3 desktop processors with 14nm technology and transfer rate 2133MHz. The board integrates Intel® Q170/H110 chipset that delivers outstanding system performance through high-bandwidth interfaces, multiple I/O functions for interactive applications and various embedded computing solutions. There are two 288-pin DDR4 DIMM sockets for dual channel DDR4 2133MHz with maximum memory capacity up to 32GB. The board also features dual Gigabit Ethernet, SATA 6Gbps with SATA RAID 0/1/5/10(Q170) by PCH, USB 2.0, and USB 3.0 high speed compliant ports and built-in Intel® HD Audio Digital Header to achieve the best stability and reliability for industrial applications.

1.1 Features

- LGA1151 socket 6th Generation Intel® Core™ processors up to 65W
- Intel® Q170/H110 PCH
- 2 DDR4 unbuffered DIMM max. up to 32GB memory capacity
- Intel® iAMT 11.0 (Q170 PCH Only) and TPM supported (Optional, Q170 PCH only)
- PCIe Gen. 3 at 8GT/s supported
- USB 3.0 supported

1.2 Specifications

- **CPU**
 - Intel® Core™ i7 desktop processor.
 - Intel® Core™ i5 desktop processor.
 - Intel® Core™ i3 desktop processor.
 - CPU TDP up to 65W
- **System Chipset**
 - Intel® Q170/H110
- **CPU Socket**
 - LGA1151 Socket.
- **DRAM Transfer Rate**
 - 2133MHz.
- **BIOS**
 - AMI BIOS via SPI interface with socket.
- **System Memory**
 - Two 288-pin DDR4 2133MHz DIMM sockets.
 - Maximum up to 32GB DDR4 memory.
- **L1, L2, L3 Cache: Integrated in CPU**
- **Onboard Multi I/O**
 - Serial ports: One RS-232/422/485 port in 2x5-pin (pitch=2.54mm) box-header (COM1) and five RS-232 ports in 2x5-pin (pitch=2.54mm) box-header (COM2/3/4/5/6).
- **USB Interface**

Q170

 - Two USB ports compliant with USB Spec. Rev. 3.0 on rear I/O.
 - Ten USB ports compliant with USB Spec. Rev. 2.0 (6 ports onboard, 4 ports on SHB connector-C golden fingers).

H110

 - Two USB ports compliant with USB Spec. Rev. 3.0 on rear I/O.
 - Eight USB ports compliant with USB Spec. Rev. 2.0 (4 ports onboard, 4 ports on SHB connector-C golden fingers).
- **Onboard Graphic**
 - Integrated Intel® HD graphic supporting DVI-I.
 - DVI/VGA: Max. resolution is 1920x1200.
- **Ethernet**
 - LAN1/LAN2: Intel® i219LM with iAMT 9.0 / Intel® i211AT Ethernet controller.
 - Support 1000/100/10Mbps Gigabit/Fast Ethernet.
- **Serial ATA**
 - Six SATA 3.0 ports (6Gbps performance) with SATA RAID 0/1/5/10 by Q170
 - four SATA 3.0 ports (6Gbps performance) by Q170



Note

Due to Gen. 2 SSD with JMicron controller has compatibility issue with Intel® Q170/H110 PCH, we strongly recommend to use Gen. 3 SSD on SHB140.

- **Audio**
 - 2x8-pin (pitch=2.0mm) box-header (Intel® HD Audio Digital Header).
- **Watchdog Timer**
 - 1~255 seconds or minutes; up to 255 levels.
- **Hardware Monitoring**
 - Monitoring temperatures, voltages and cooling fan status.
- **Dimensions**
 - 338mm x 126mm.
- **Expansion Interface**
 - One PCI-Express x16 (Gen.3).
 - One PCI-Express x4 (or four PCI-Express x1) (Gen.2).
 - Four PCI.



Note

All specifications and images are subject to change without notice.

1.3 Utilities Supported

- Intel® Q170/H110 utility and drivers
- DVI-I drivers
- Audio utility and drivers
- Ethernet utility and drivers
- RAID utility (Q170)
- iAMT utility and drivers
- TPM utility(Q170)

This page is intentionally left blank.

Chapter 2

Board and Pin Assignments

2.1 Board Dimensions and Fixing Holes

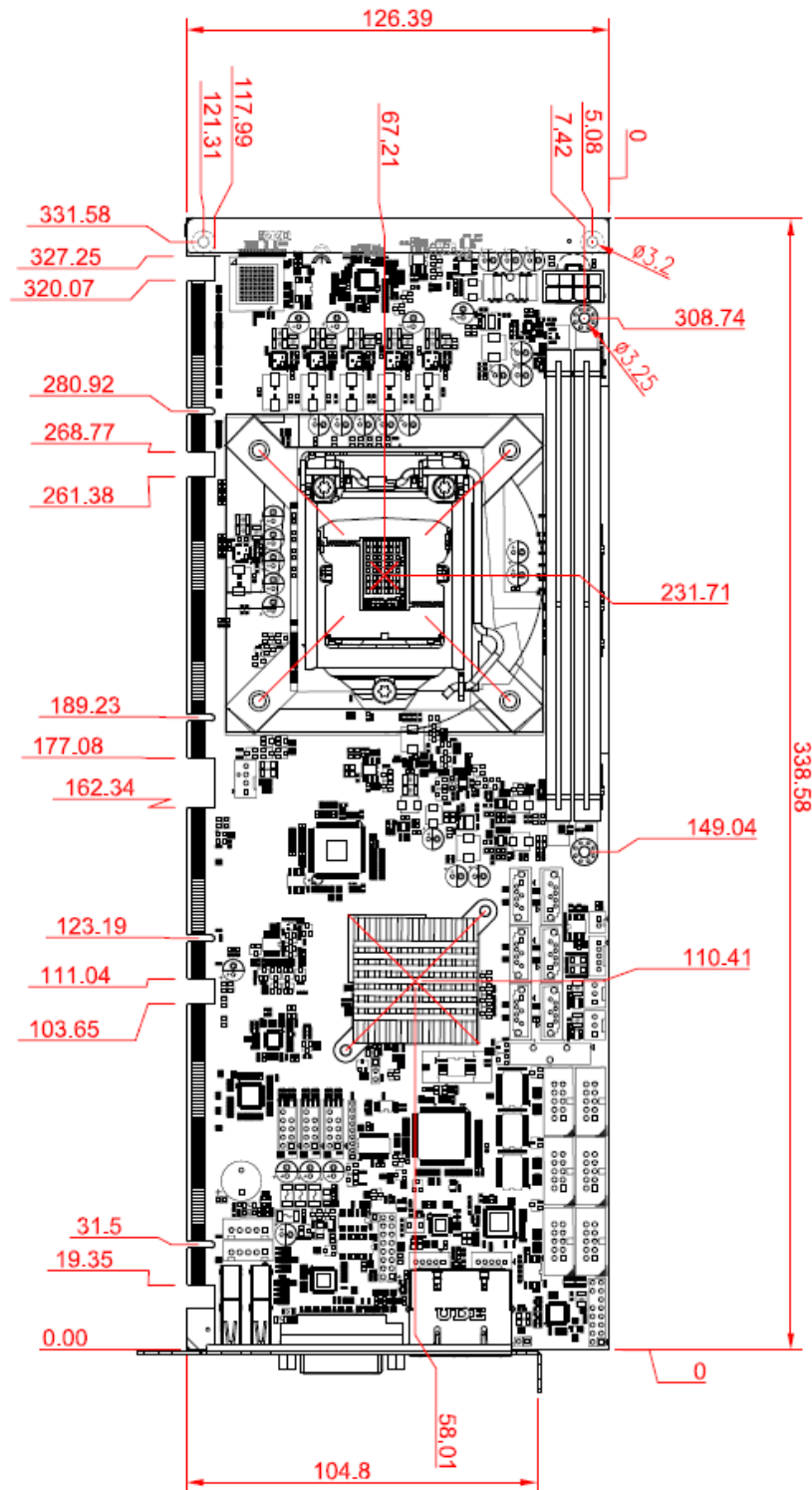

2.2 Board Layout

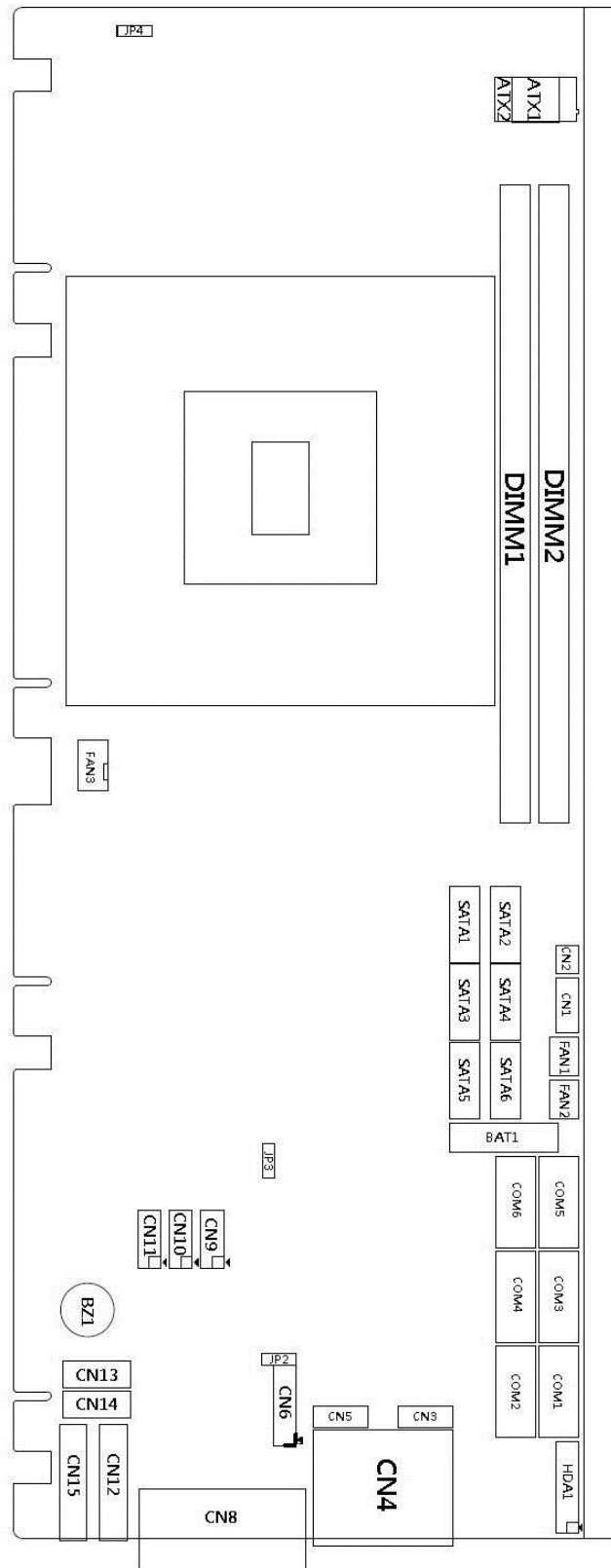

Top View

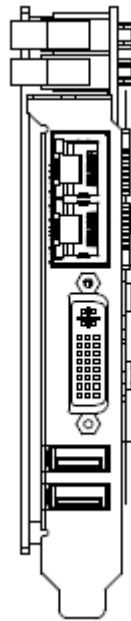

Rear Panel I/O

2.3 Jumper Settings

Jumper is a small component consisting of jumper clip and jumper pins. Install jumper clip on 2 jumper pins to close. And remove jumper clip from 2 jumper pins to open. The following illustration shows how to set up jumper.

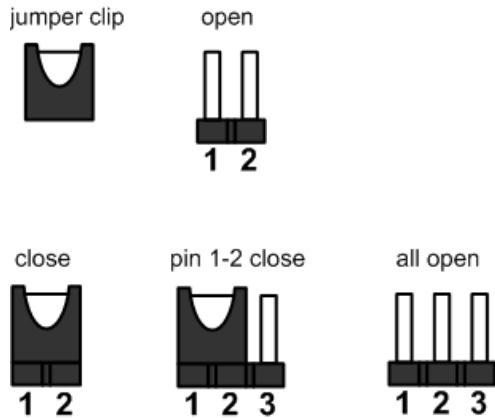

Before applying power to SHB140 Series, please make sure all of the jumpers are in factory default position. Below you can find a summary table and onboard default settings.



Note

Once the default jumper setting needs to be changed, please do it under power-off condition.

Jumper	Description	Setting
JP2	Auto Power On Default: Disable	1-2 Close
JP3	Restore BIOS Optimal Defaults Default: Normal Operation	1-2 Close
JP4	PCI IO Voltage Selection Default: 5V	2-3 Close

2.3.1 Auto Power On (JP2)

If JP2 is enabled for power input, the system will be automatically power on without pressing soft power button. If JP2 is disabled for power input, it is necessary to manually press soft power button to power on the system.

Function	Setting
Disable auto power on (Default)	1-2 close
Enable auto power on	2-3 close



2.3.2 Restore BIOS Optimal Defaults (JP3)

Put jumper clip to pin 2-3 for a few seconds then move it back to pin 1-2. Doing this procedure can restore BIOS optimal defaults.

Function	Setting
Normal operation (Default)	1-2 close
Restore BIOS optimal defaults	2-3 close



2.3.3 PCI IO Voltage Selection (JP4)

This jumper is for PCI IO power source selection.

Function	Setting
3.3V	1-2 close
5V (Default)	2-3 close



2.4 Connectors

Signals go to other parts of the system through connectors. Loose or improper connection might cause problems, please make sure all connectors are properly and firmly connected. Here is a summary table which shows all connectors on the hardware.

Connector	Description
CN1	SMBus Connector
CN2	Temperature Sensor Connector
CN3, CN5	LAN2 and LAN1 LED Connectors
CN4	Ethernet Ports
CN6	Front Panel Connector
CN8	DVI-I Connector
CN9~CN11	Internal USB 2.0 Port 6~11
CN12, CN15	External USB 3.0 Port 0 and 1
CN13	Internal PS/2 Mouse Connector
CN14	Internal PS/2 Keyboard Connector
COM1~COM6	COM1~COM6 Connectors
FAN1	Auxiliary Fan Connector
FAN2	System Fan Connector
FAN3	CPU Fan Connector
SATA1~SATA6	SATA 3.0 Port 1~6
HDA1	Intel® HD Audio Digital Header
ATX2	ATX Power Connector
DIMM1~DIMM2	DDR4 DIMM Sockets

2.4.1 SMBus Connector (CN1)

This is a 5-pin connector for SMBus interface. The SMBus (System Management Bus) is a simple bus for the purpose of lightweight communication.

Pin	Signal
1	CLOCK
2	N.C
3	GND
4	DATA
5	+5V

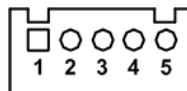

2.4.2 Temperature Sensor Connector (CN2)

This is a 2-pin connector for temperature sensor (NTC thermistor) interface. The thermistor value should be 10K and its B value is 3435K.

Pin	Signal
1	Sensor Input
2	GND



2.4.3 LAN LED Connectors (CN3 and CN5)

The LAN2 and LAN1 LED interfaces are available through CN3 and CN5.

Pin	Signal
1	+3.3V
2	LINK_ACT LED(-)
3	100, Low Active
4	+3.3V
5	1000, Low Active

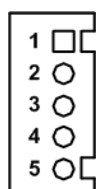

2.4.4 Ethernet Ports (CN4)

The board has two RJ-45 connectors; LAN1 (i219LM) and LAN2 (i211AT). Ethernet connection can be established by plugging one end of the Ethernet cable into this RJ-45 connector and the other end (phone jack) to a 1000/100/10 Base-T hub.

Pin	1000 Base-T	100/10 Base-T	Description
L1	BI_DA+	TX+	Bidirectional or Transmit Data+
L2	BI_DA-	TX-	Bidirectional or Transmit Data-
L3	BI_DB+	RX+	Bidirectional or Receive Data+
L4	BI_DC+	N.C.	Bidirectional or Not Connected
L5	BI_DC-	N.C.	Bidirectional or Not Connected
L6	BI_DB-	RX-	Bidirectional or Receive Data-
L7	BI_DD+	N.C.	Bidirectional or Not Connected
L8	BI_DD-	N.C.	Bidirectional or Not Connected
A	Active Link LED (Yellow) Off: No link Blinking: Data activity detected		
B	Speed LED 1000: Orange 100/10: OFF/Green		

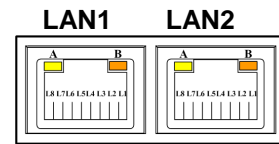

2.4.5 Front Panel Connector (CN6)

Pin	Signal
1	PWRLED+
2	EXT SPK-
3	GND
4	Buzzer
5	PWRLED-
6	N.C.
7	N.C.
8	EXT SPK+
9	PWRSW-
10	PWRSW+
11	HW RST-
12	HW RST+
13	HDDLED-
14	HDDLED+

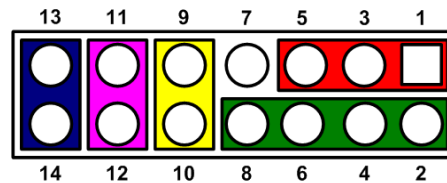

Power LED

Pin 1 connects anode(+) of LED and pin 5 connects cathode(-) of LED. The power LED lights up when the system is powered on. The pin 3 is defined as GND.

External Speaker and Internal Buzzer

Pin 2, 4, 6 and 8 connect the case-mounted speaker unit or internal buzzer. While connecting the CPU board to an internal buzzer, please set pin 2 and 4 closed; while connecting to an external speaker, you need to set pins 2 and 4 opened and connect the speaker cable to pin 8(+) and pin 2(-).

Power On/Off Button

Pin 9 and 10 connect the power button on front panel to the CPU board, which allows users to turn on or off power supply.

System Reset Switch

Pin 11 and 12 connect the case-mounted reset switch that reboots your computer without turning off the power switch. It is a better way to reboot your system for a longer life of system power supply.

HDD Activity LED

This connection is linked to hard drive activity LED on the control panel. LED flashes when HDD is being accessed. Pin 13 and 14 connect the hard disk drive to the front panel HDD LED, pin 13 is assigned as cathode(-) and pin 14 is assigned as anode(+).

2.4.6 DVI-I Connector (CN8)

DVI-I (integrated, combines digital and analog in the same connector; digital may be single or dual link) provides transmission of fast and high quality digital video between source device (graphic card) and display device.

Pin	Signal	Pin	Signal
1	DVI_DATA2-	2	DVI_DATA2+
3	GND	4	N.C.
5	N.C.	6	DVI_SPC
7	DVI_SPD	8	N.C.
9	DVI_DATA1-	10	DVI_DATA1+
11	GND	12	N.C.
13	N.C.	14	+5V
15	GND	16	DVI_HTPLG
17	DVI_DATA0-	18	DVI_DATA0+
19	GND	20	N.C.
21	N.C.	22	GND
23	DVI_CLK+	24	DVI_CLK-
C1	Analog red	C2	Analog green
C3	Analog blue	C4	Analog horizontal sync
C5	Analog ground		

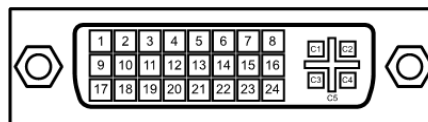

2.4.7 Internal USB 2.0 Connectors (CN9~CN11)

These are internal connectors for USB 2.0 interfaces.

Pin	Signal	Pin	Signal
1	USB_PWR	2	USB_PWR
3	USB -	4	USB -
5	USB +	6	USB +
7	GND	8	GND
		10	GND

CN9: USB port 6 and 7
CN10: USB port 8 and 9
CN11: USB port 10 and 11

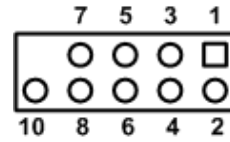

2.4.8 External USB 3.0 Connectors (CN12 and CN15)

These are standard USB (Universal Serial Bus) 3.0 connectors on the rear I/O for installing USB peripherals such as keyboard, mouse, scanner, etc.

Pin	Signal
1	VCC
2	D-
3	D+
4	GND
5	StdA_SSRX-
6	StdA_SSRX+
7	GND_DRAIN
8	StdA_SSTX-
9	StdA_SSTX+

CN12: USB 3.0 port 0
CN15: USB 3.0 port 1

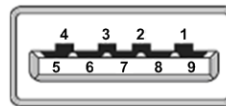

2.4.9 Internal PS/2 Keyboard and Mouse Connectors (CN13 and CN14)

The board has two 5-pin connectors for PS/2 keyboard (CN14) and mouse (CN13) interfaces.

Pin	Signal
1	Clock
2	DATA
3	No connector
4	GND
5	5VSBY

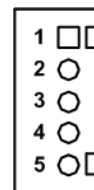

2.4.10 COM Connectors (COM1~COM6)

Only COM1 port supports RS-232/RS-422/RS-485 mode operation, see table below for the pin assignments. You can change the transmission mode from BIOS setting in section 5.4. The other COM ports (COM2/3/4/5/6) support RS-232 only.

Pin	RS-232	RS-422	RS-485
1	Data Carrier Detect (DCD)	TX-	DATA-
2	Data Set Ready (DSR)	No connector	No connector
3	Receive Data (RXD)	TX+	DATA+
4	Request to Send (RTS)	No connector	No connector
5	Transmit Data (TXD)	RX+	No connector
6	Clear to Send (CTS)	No connector	No connector
7	Data Terminal Ready (DTR)	RX-	No connector
8	Ring Indicator (RI)	No connector	No connector
9	Ground (GND)	GND	GND
10	Disconnect (NI)	NI	NI

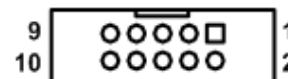

2.4.11 FAN Connectors (FAN1, FAN2 and FAN3)

Fans are needed for cooling down CPU and system temperature. The board has three fan connectors. You can find fan speed option(s) at BIOS Setup Utility if either fan is installed. For further information, see BIOS Setup Utility: Advanced\HW Monitor\PC Health Status.

Auxiliary and system fan interfaces are available through FAN1 and FAN2, see table below.

Pin	Signal
1	GND
2	+12V level
3	Rotation detection

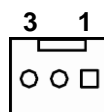

CPU fan interface is available through FAN3, see table below.

Pin	Signal
1	Ground
2	+12V
3	Rotation Detection
4	Speed Control

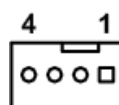

2.4.12 SATA 3.0 Connectors (SATA1~SATA6)

These Serial Advanced Technology Attachment (Serial ATA or SATA) connectors are for high-speed SATA 3.0 interfaces. They are computer bus interfaces for connecting to devices such as hard disk drives.

This board has six SATA 3.0 ports with 6Gb/s performance.

Pin	Signal
1	GND
2	SATA_TX+
3	SATA_TX-
4	GND
5	SATA_RX-
6	SATA_RX+
7	GND

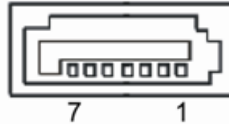

2.4.13 Intel® HD Audio Digital Header (HDA1)

This is a 2x8-pin header for connecting external HD Audio board (AX93242).

Pin	Signal	Pin	Signal
1	BCLK	2	GND
3	RST#	4	N.C
5	SYNC	6	GND
7	SDO	8	+3.3S
9	SDIO	10	+12VS
11	N.C	12	
13	N.C	14	N.C
15	N.C	16	GND

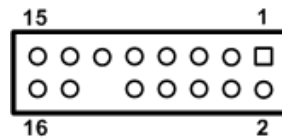

2.4.14 ATX Power Connector (ATX2)

Steady and sufficient power can be supplied to all components on the board by connecting power connector. Please make sure all components and devices are properly installed before connecting the power connector.

External power supply plug fits into this connector in only one orientation. Properly press down power supply plug until it completely and firmly fits into this connector. Loose connection may cause system instability.

The ATX2 is an 8-pin ATX power connector. Its pin assignments are given in table below.

Pin	Signal	Pin	Signal
1	GND	5	+12V
2	GND	6	+12V
3	GND	7	+12V
4	GND	8	+12V

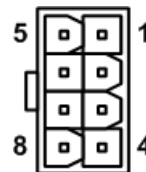

Chapter 3

Hardware Installation

3.1 Installing the Processor

The LGA1151 processor socket comes with a cover to protect the processor. Please install the processor into the CPU socket step by step as below:



Note

Make sure that you install the correct CPU designed for LGA1151 socket only. DO NOT install a CPU designed for LGA1156, LGA1155 or LGA1150 CPU on LGA1151 socket.

Step1 Opening the socket:

- Disengage load lever by releasing down and out on the hook. This will clear retention tab.
- Rotate load lever to open position at approximately 135°.
- Rotate load plate to open position at approximately 150°.

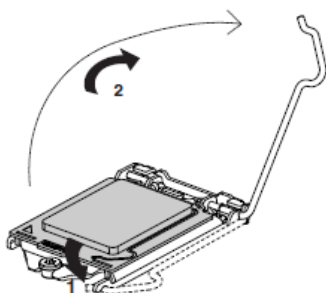

Step2 Removing the socket protective cover:

- Place thumb against the front edge of the protective cover and rest index finger on the rear grip to maintain control of the cover.
- Lift the front edge of the protective cover to disengage from the socket. Keep control of the cover by holding the rear grip with index finger.
- Lift protective cover away from the socket, being careful not to touch the electrical contacts.

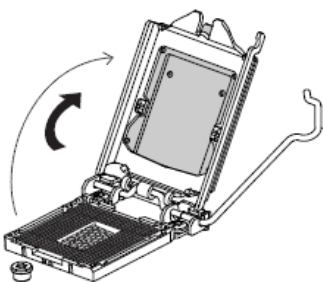

Step3 Processor installation:

- Lift processor package from shipping media by grasping the substrate edges.
- Scan the processor package gold pads for any presence of foreign material. If necessary, the gold pads can be wiped clean with a soft lint-free cloth and isopropyl alcohol.
- Locate connection 1 indicator on the processor which aligns with connection 1 indicator chamfer on the socket, and notice processor keying features that line up with posts along socket walls.

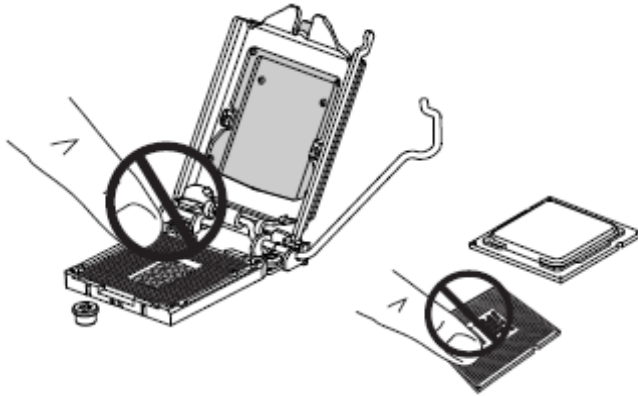

Note

Never touch fragile socket contacts to avoid damage and do not touch processor sensitive contacts at any time during installation.

- Carefully place the processor into the socket body vertically (see image below).

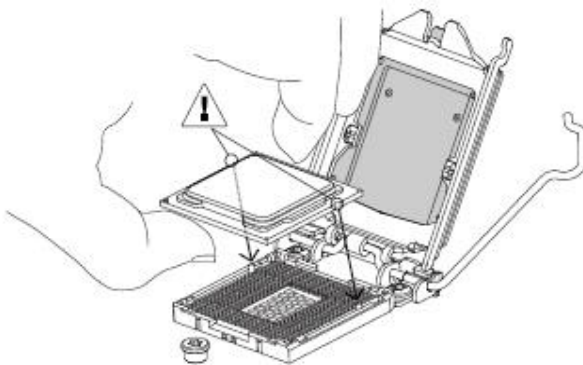

Step4 Close the socket (see image below):

- Gently lower the load plate.
- Make sure load plate's front edge slides under the shoulder screw cap as the lever is lowered.
- Latch the lever under the top plate's corner tab, being cautious not to damage the motherboard with the tip of the lever.

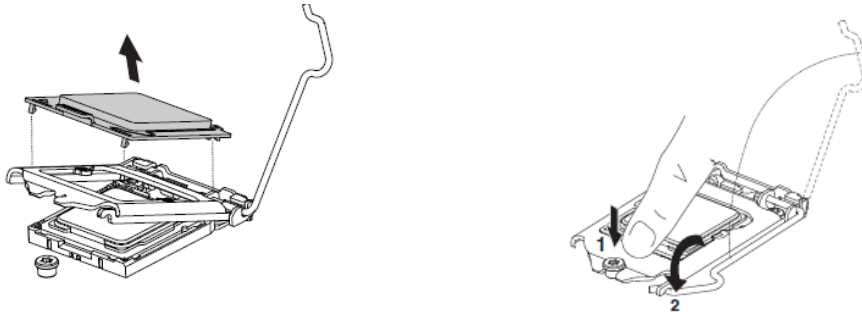

Step5 Fan heatsink handling:

1. Orientate the CPU cooling fan to fixing holes on the board.

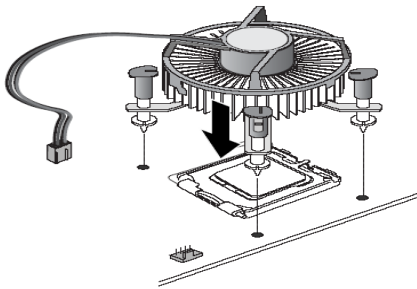

2. Screw the CPU cooling fan onto the board.

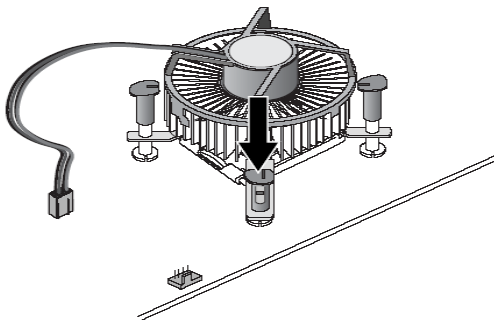

3. Make sure the CPU fan is plugged to the CPU fan connector.

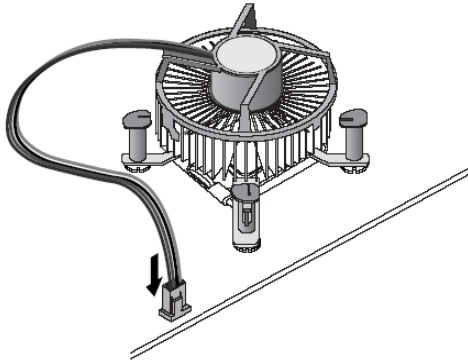

3.2 Installing the Memory

The board supports two 288-pin DDR4 DIMM memory sockets with maximum memory capacity up to 32GB.

Please follow steps below to install the memory modules:

- Push down latches on each side of the DIMM socket.
- Align the memory module with the socket that notches of memory module must match the socket keys for a correct installation.
- Install the memory module into the socket and push it firmly down until it is fully seated. The socket latches are levered upwards and clipped on to the edges of the DIMM.
- Install any remaining DIMM modules.

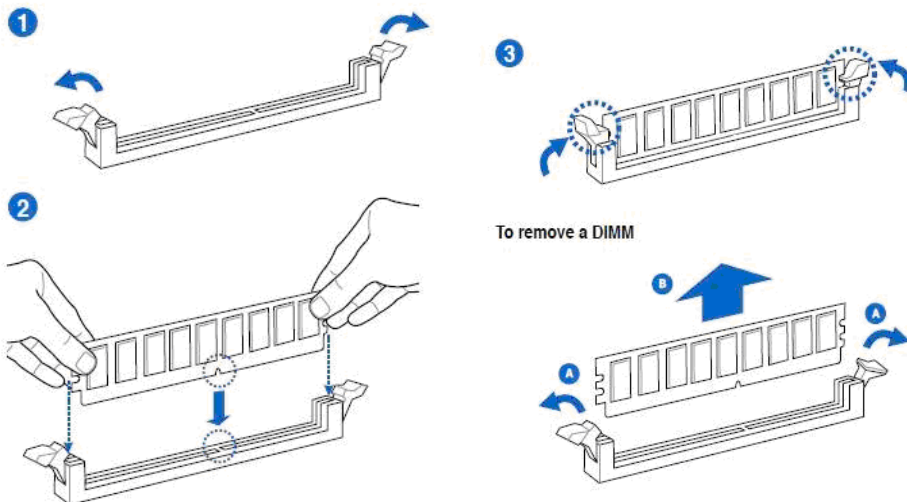

Chapter 4

Hardware Description

4.1 Microprocessors

The SHB140 Series supports Intel® 6th/7th Core™ i7/ i5/ i3 processors, which enable your system to operate under Windows® 7, Windows® 8.1, Windows® 10 and Linux environments. The system performance depends on the microprocessor. Make sure all correct settings are arranged for your installed microprocessor to prevent the CPU from damages.

4.2 BIOS

The SHB140 Series uses AMI Plug and Play BIOS with a single 64Mbit SPI Flash.

4.3 System Memory

The SHB140 Series supports two 288-pin DDR4 DIMM sockets for maximum memory capacity up to 32GB DDR4 SDRAMs. The memory module comes in sizes of 2GB, 4GB, 8GB, and 16GB.

This page is intentionally left blank.

Chapter 5

AMI BIOS Setup Utility

The AMI UEFI BIOS provides users with a built-in setup program to modify basic system configuration. All configured parameters are stored in a flash chip to save the setup information whenever the power is turned off. This chapter provides users with detailed description about how to set up basic system configuration through the AMI BIOS setup utility.

5.1 Starting

To enter the setup screens, follow the steps below:

1. Turn on the computer and press the key immediately.
2. After you press the key, the main BIOS setup menu displays. You can access the other setup screens from the main BIOS setup menu, such as the Advanced and Chipset menus.



Note

If your computer cannot boot after making and saving system changes with BIOS setup, you can restore BIOS optimal defaults by setting JP3 (see section 2.3.2).

It is strongly recommended that you should avoid changing the chipset's defaults. Both AMI and your system manufacturer have carefully set up these defaults that provide the best performance and reliability.

5.2 Navigation Keys

The BIOS setup/utility uses a key-based navigation system called hot keys. Most of the BIOS setup utility hot keys can be used at any time during the setup navigation process. These keys include <F1>, <F2>, <Enter>, <ESC>, <Arrow> keys, and so on.



Note

Some of the navigation keys differ from one screen to another.

Hot Keys	Description
→← Left/Right	The Left and Right <Arrow> keys allow you to select a setup screen.
↑↓ Up/Down	The Up and Down <Arrow> keys allow you to select a setup screen or sub-screen.
+– Plus/Minus	The Plus and Minus <Arrow> keys allow you to change the field value of a particular setup item.
Tab	The <Tab> key allows you to select setup fields.
F1	The <F1> key allows you to display the General Help screen.
F2	The <F2> key allows you to Load Previous Values.
F3	The <F3> key allows you to Load Optimized Defaults.
F4	The <F4> key allows you to save any changes you have made and exit Setup. Press the <F4> key to save your changes.
Esc	The <Esc> key allows you to discard any changes you have made and exit the Setup. Press the <Esc> key to exit the setup without saving your changes.
Enter	The <Enter> key allows you to display or change the setup option listed for a particular setup item. The <Enter> key can also allow you to display the setup sub- screens.

5.3 Main Menu

The first time you enter the setup utility, you will enter the Main setup screen. You can always return to the Main setup screen by selecting the Main tab. System Time/Date can be set up as described below. The Main BIOS setup screen is shown below.

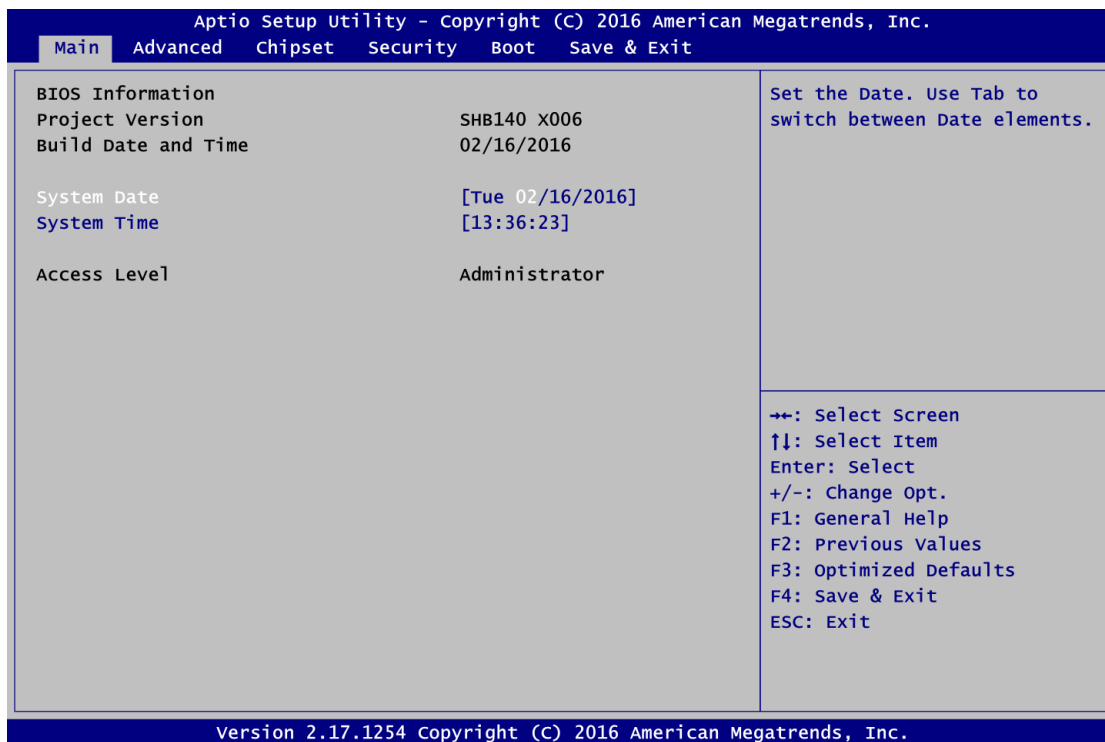

BIOS Information

Display the auto-detected BIOS information.

System Date/Time

Use this option to change the system time and date. Highlight System Time or System Date using the <Arrow> keys. Enter new values through the keyboard. Press the <Tab> key or the <Arrow> keys to move between fields. The date must be entered in MM/DD/YY format. The time is entered in HH:MM:SS format.

Access Level

Display the access level of current user.

5.4 Advanced Menu

The Advanced menu also allows users to set configuration of the CPU and other system devices. You can select any of the items in the left frame of the screen to go to the sub menus:

- ▶ NCT6106D Super IO Configuration
- ▶ NCT6106D HW Monitor
- ▶ ACPI Settings
- ▶ Trusted Computing
- ▶ CPU Configuration
- ▶ SATA Configuration
- ▶ PCH-FW Configuration
- ▶ AMT Configuration

For items marked with “▶”, please press <Enter> for more options.

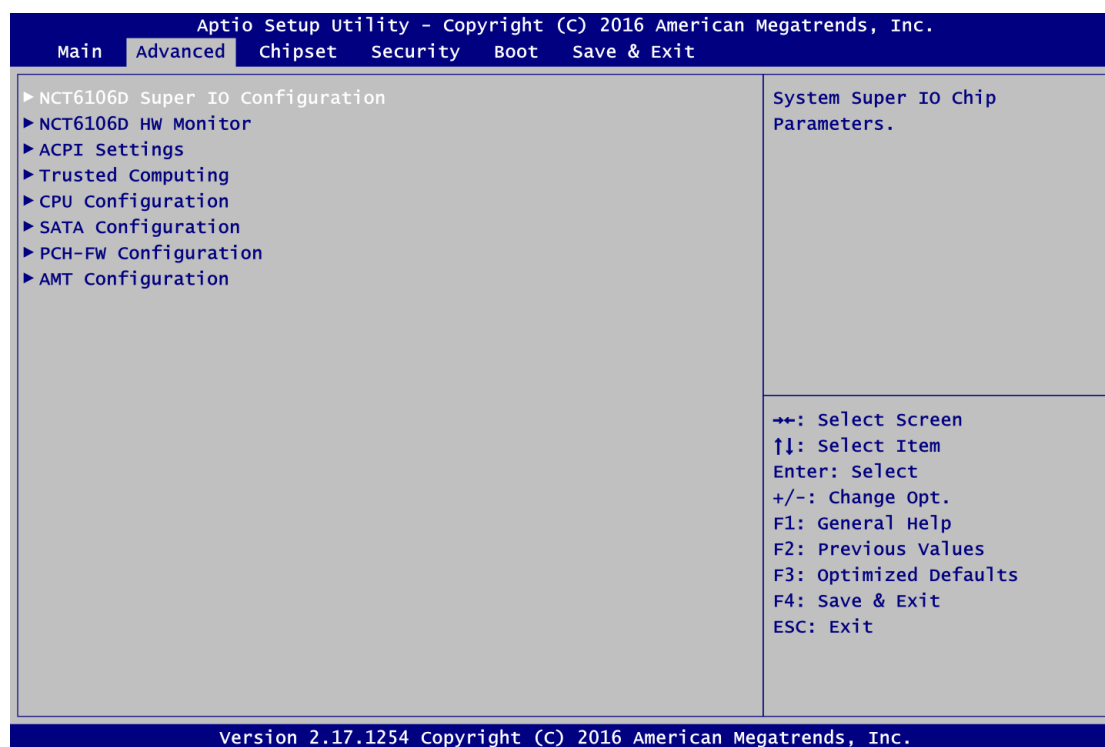

- **NCT6106D Super IO Configuration**

You can use this screen to select options for the Super IO Configuration, and change the value of the selected option. A description of the selected item appears on the right side of the screen. For items marked with "▶", please press <Enter> for more options.

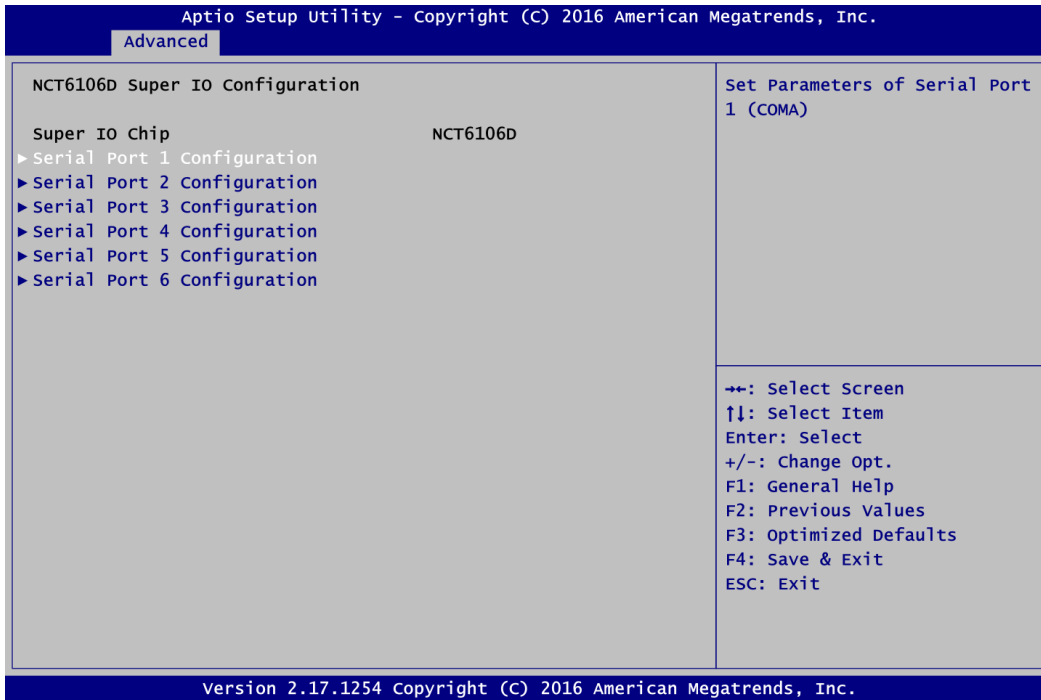

Serial Port 1~6 Configuration

Use this item to set parameters of serial port 1 to 6.

- Serial Port 1 Configuration

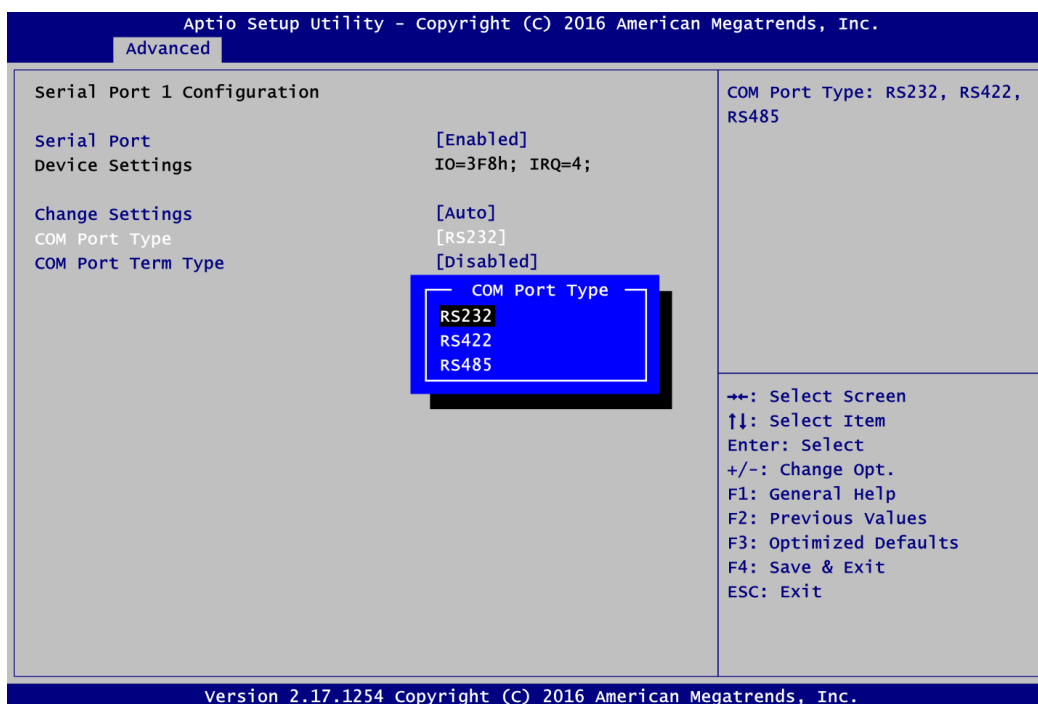

Serial Port

Enable or disable serial port 1. The optimal setting for base I/O address is 3F8h and for interrupt request address is IRQ4.

Change Settings

Use this item to change base I/O address and IRQ settings.

COM Port Type

Select RS-232/422/485 communication mode for serial port 1.

COM Port Term Type

Enable or disable serial port termination.

- **NCT6106D HW Monitor**

Use this screen for Smart Fan configuration and hardware health status monitoring.

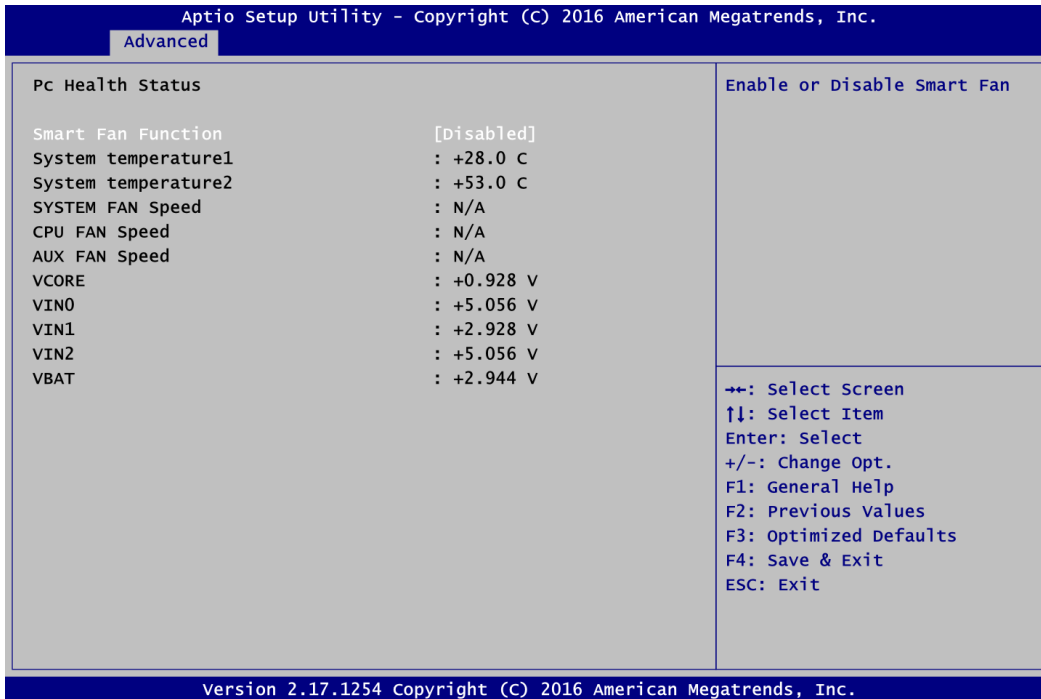

This screen displays the temperature of system, cooling fans speed in RPM and system voltages (VCORE, VIN0, VIN1, VIN2 and VBAT).

Smart Fan Function

Enable or disable Smart Fan function.

Temperature 1<Temperature 2<Temperature 3<Temperature 4

- **ACPI Settings**

You can use this screen to select options for the ACPI configuration, and change the value of the selected option. A description of the selected item appears on the right side of the screen.

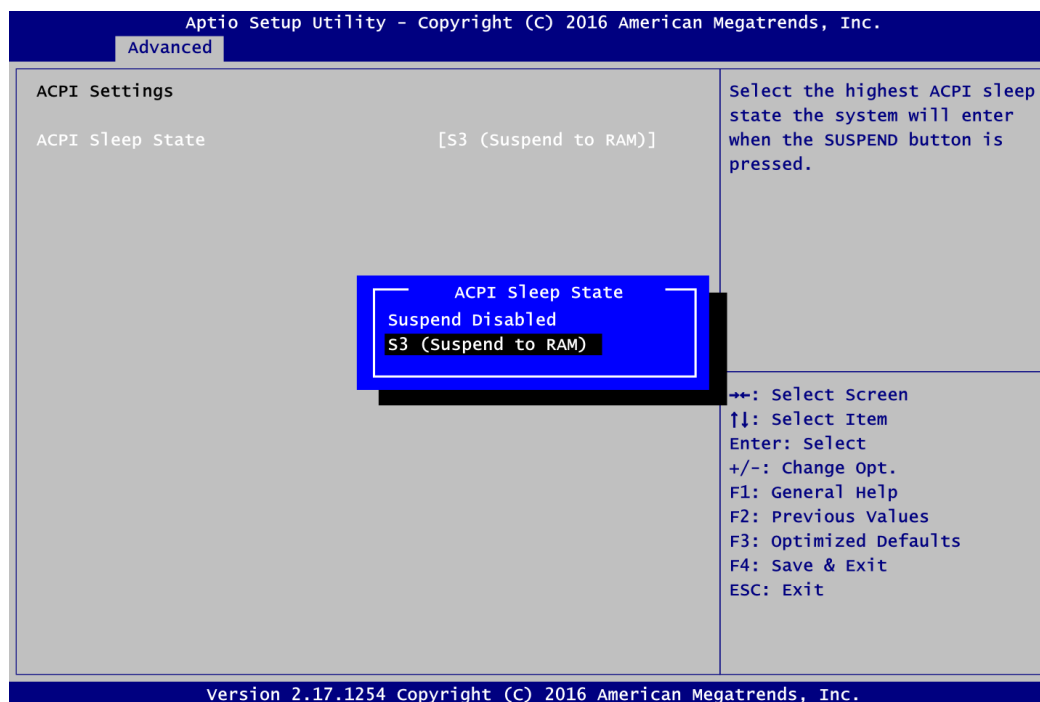
**ACPI Sleep State**

Select the ACPI (Advanced Configuration and Power Interface) sleep state. Configuration options are Suspend Disabled and S3 (Suspend to RAM). The default is S3 (Suspend to RAM); this option selects ACPI sleep state the system will enter when suspend button is pressed.

- **Trusted Computing**

This screen provides function for specifying the Trusted Computing.

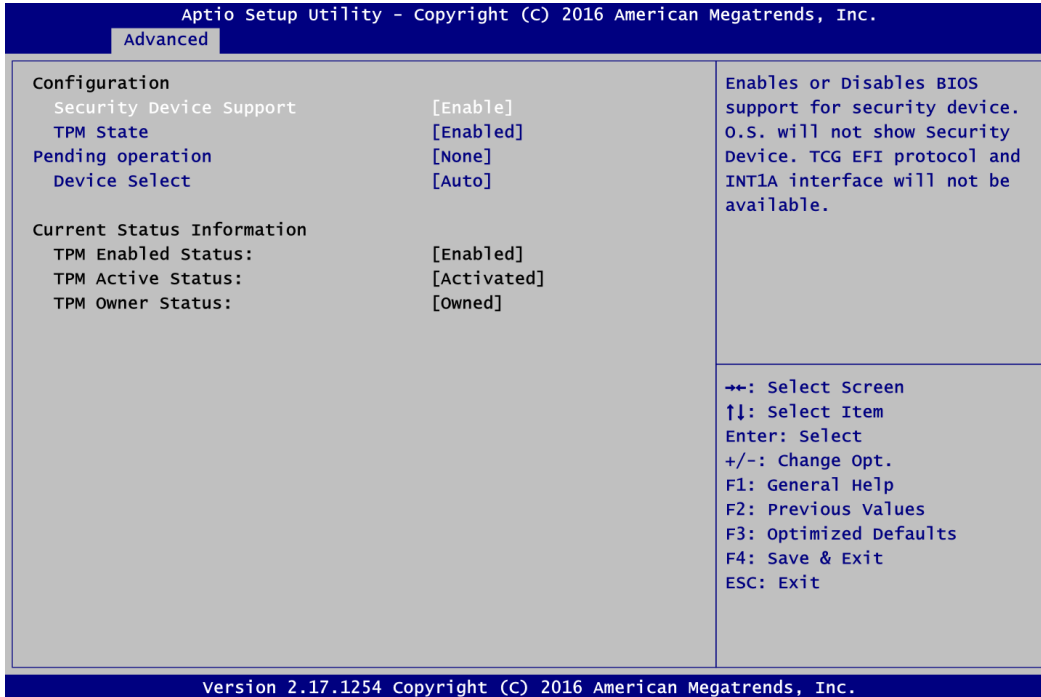

Security Device Support

Enable or disable BIOS support for security device. The default setting is Disabled.

TPM State

Once the Security Device Support is Enabled, TPM (Trusted Platform Module) can be used by the operating system.

Current Status Information

Display current TPM status information.

Pending Operation

Schedule a TPM operation which will take effect at the next bootup process.

- **CPU Configuration**

This screen shows the CPU information, and you can change the value of the selected option.

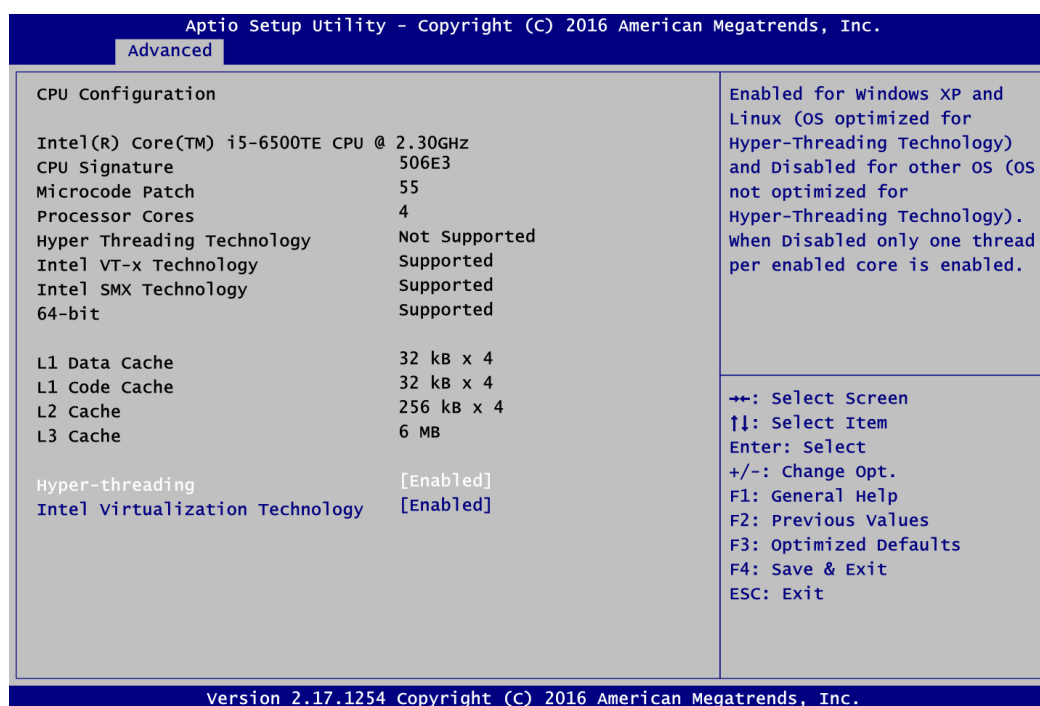

Hyper-threading

Enable or disable Hyper-Threading Technology. When enabled, it allows a single physical processor to multitask as multiple logical processors. When disabled, only one thread per enabled core is enabled.

Intel Virtualization Technology

Enable or disable Intel Virtualization Technology. When enabled, a VMM (Virtual Machine Mode) can utilize the additional hardware capabilities. It allows a platform to run multiple operating systems and applications independently, hence enabling a single computer system to work as several virtual systems.

- **SATA Configuration**

In this Configuration menu, you can see the currently installed hardware in SATA ports. During system boot up, BIOS automatically detects the presence of SATA devices.

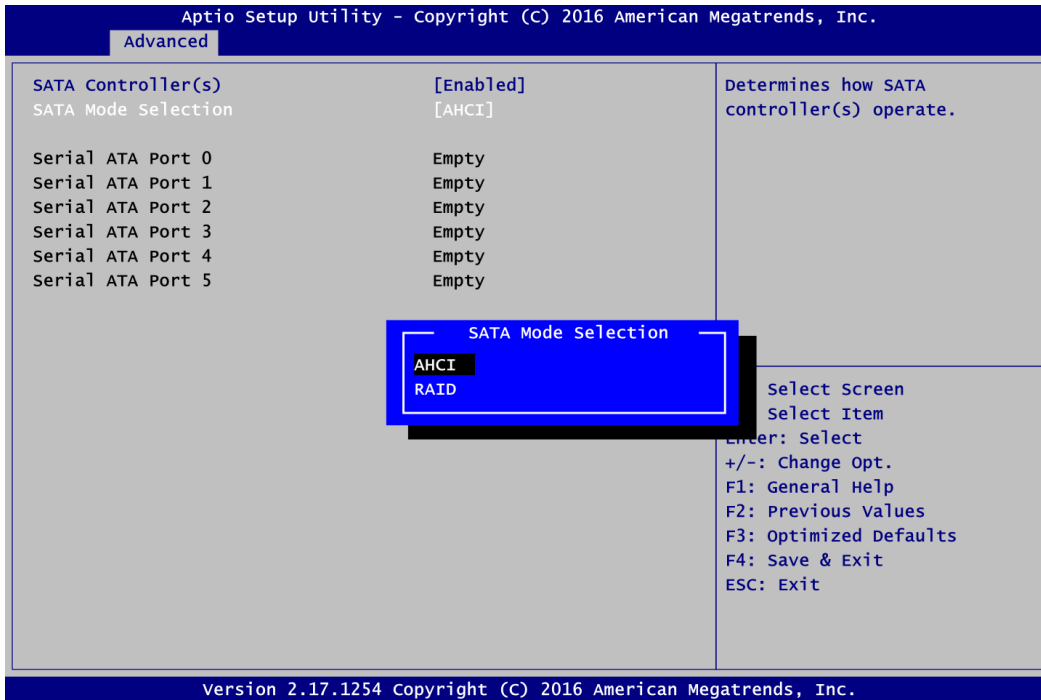

SATA Controller(s)

Enable or disable SATA controller feature.

SATA Mode Selection

Determine how SATA controller(s) operate. Operation options are: AHCI and RAID Mode.

- **PCH-FW Configuration**

This screen displays ME (Management Engine) Firmware information.

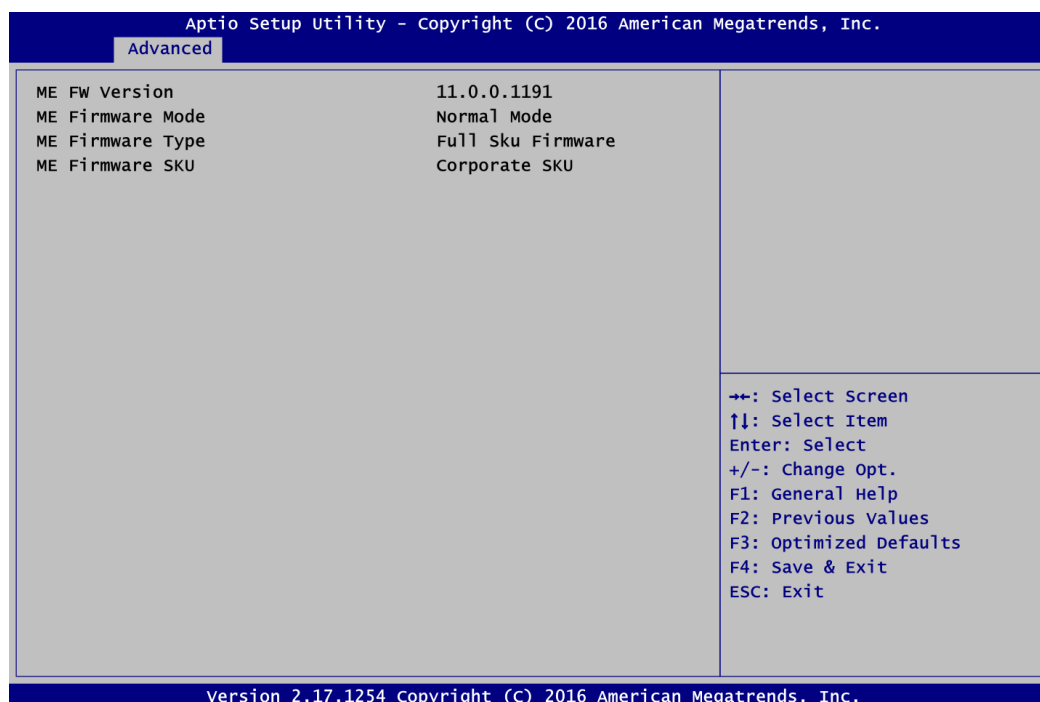

- **AMT Configuration**

Use this screen to configure AMT parameters.

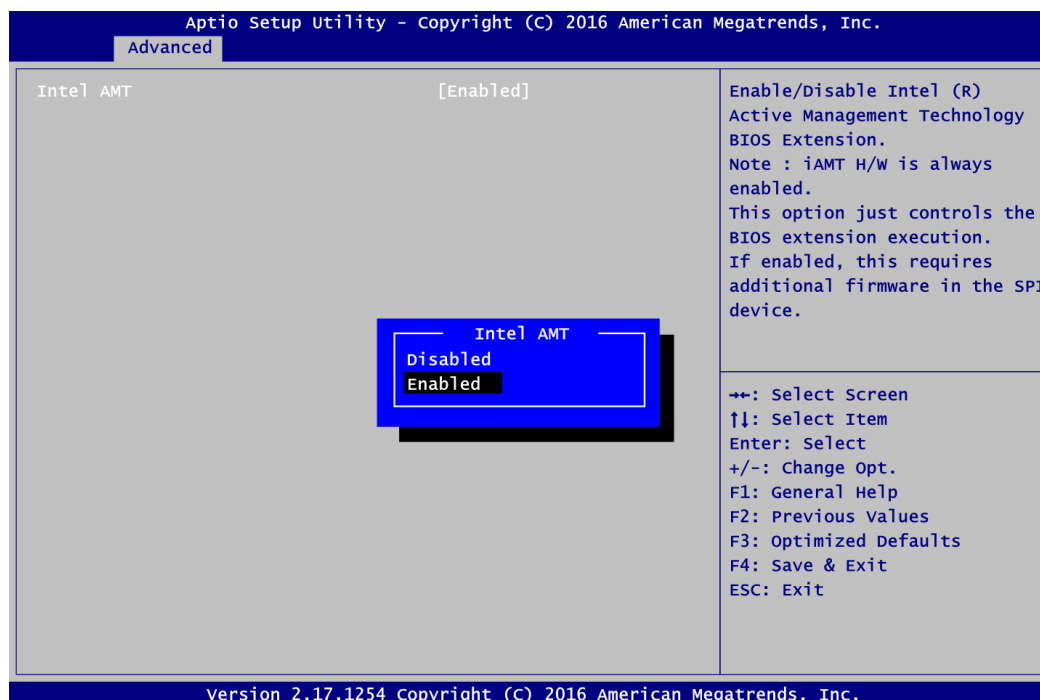

Intel AMT

Enable or disable Intel® Active Management Technology BIOS Extension. The default is Enabled. After enabling, please refer to Appendix D for iAMT settings.

5.5 Chipset Menu

The Chipset menu allows users to change the advanced chipset settings. You can select any of the items in the left frame of the screen to go to the sub menus:

- ▶ System Agent (SA) Configuration
- ▶ PCH-IO Configuration

For items marked with “▶”, please press <Enter> for more options.

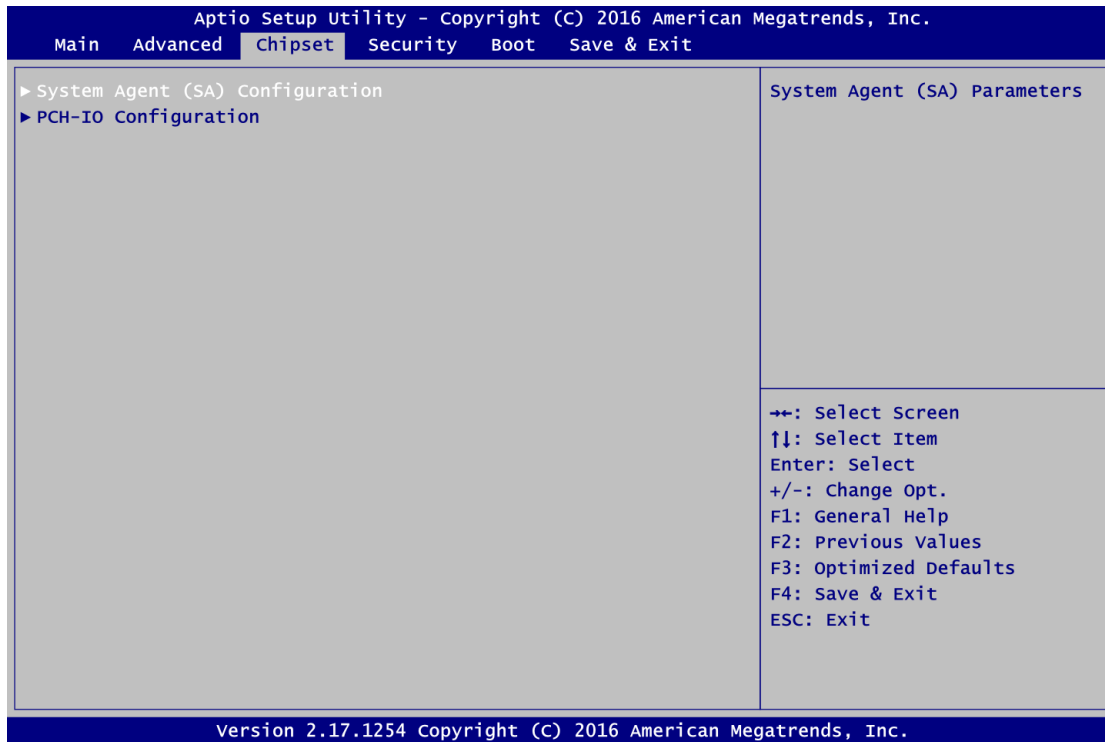

- **System Agent (SA) Configuration**

This screen shows System Agent information.

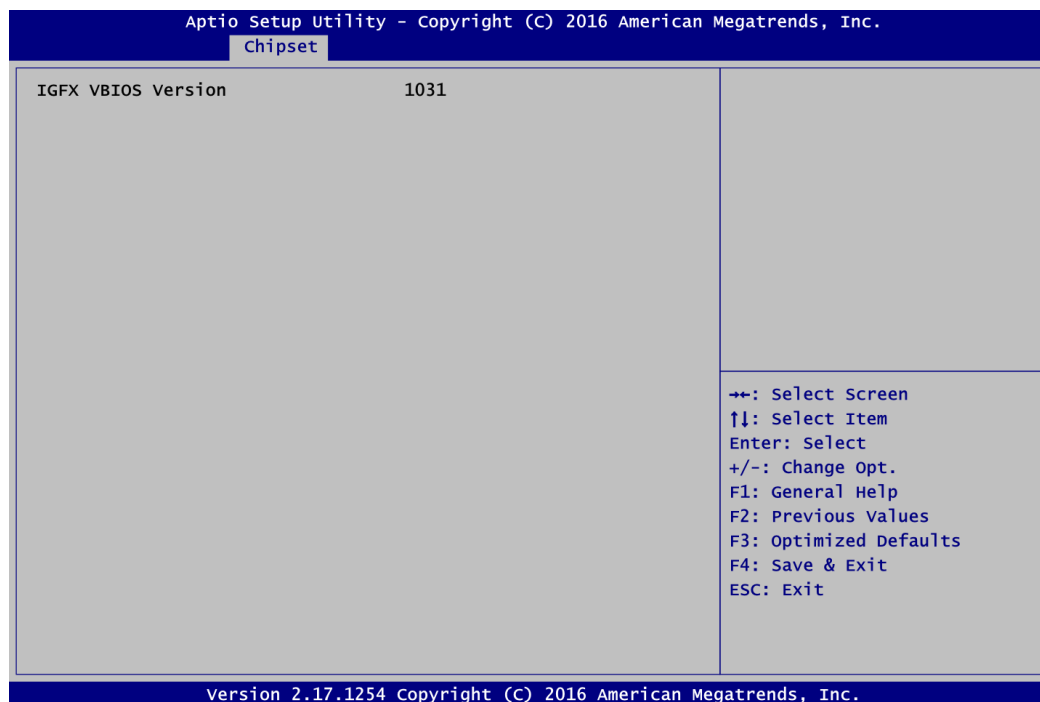

- **PCH-IO Configuration**

This screen shows system memory information.

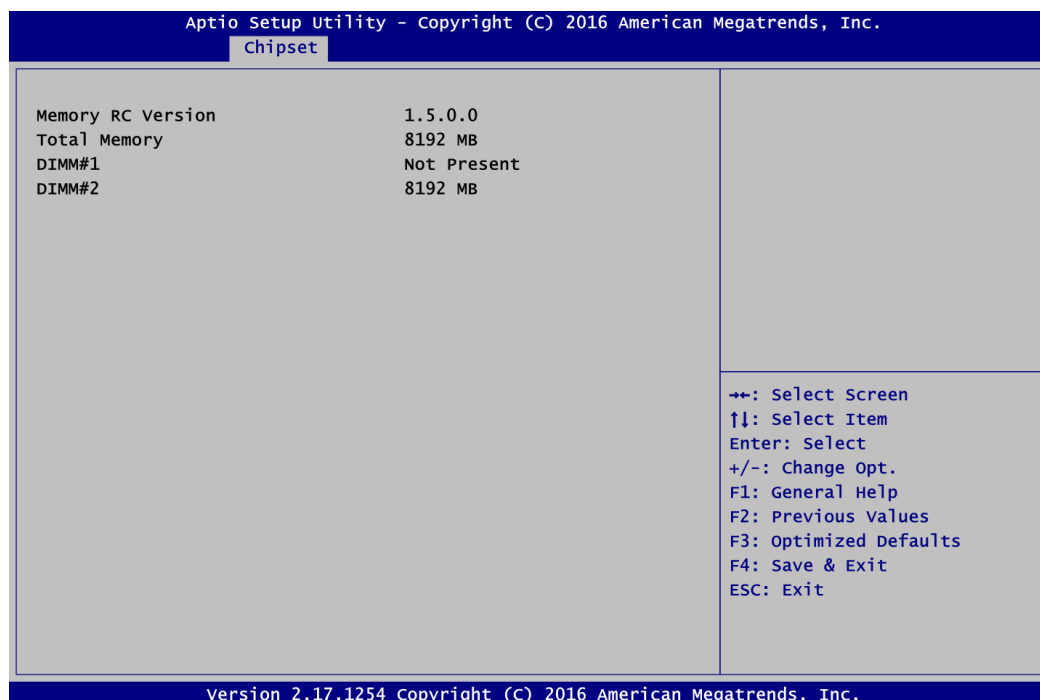

5.6 Security Menu

The Security menu allows users to change the security settings for the system.

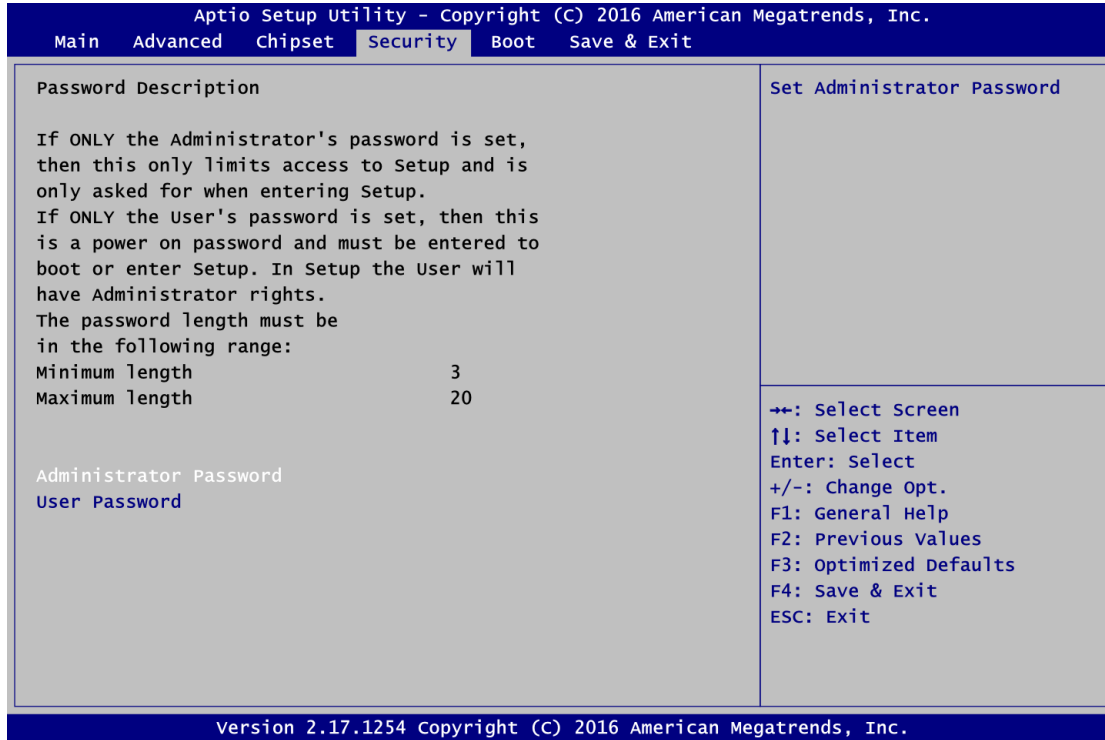

- Administrator Password**
 This item indicates whether an administrator password has been set (installed or uninstalled).
- User Password**
 This item indicates whether a user password has been set (installed or uninstalled).

5.7 Boot Menu

The Boot menu allows users to change boot options of the system.

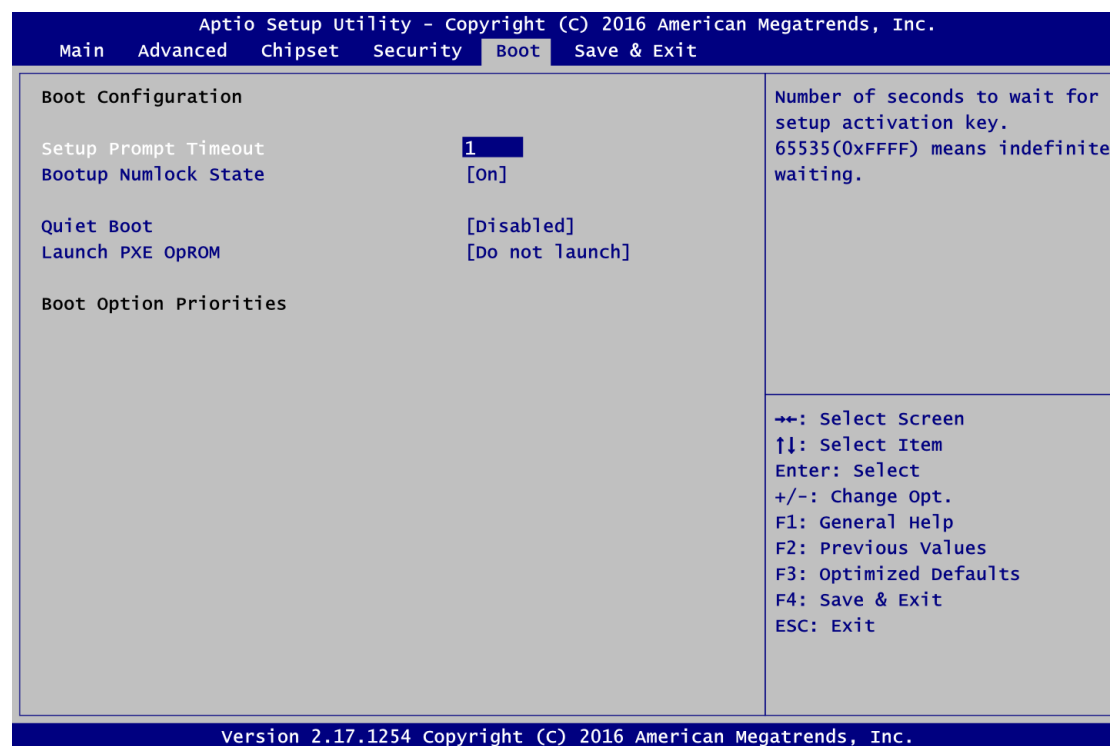

- Setup Prompt Timeout**
 Number of seconds to wait for setup activation key. 65535(0xFFFF) means indefinite waiting.
- Bootup NumLock State**
 Use this item to select the power-on state for the keyboard NumLock.
- Quiet Boot**
 Select to display either POST output messages or a splash screen during boot-up.
- Launch PXE OpROM**
 Use this item to enable or disable the boot ROM function of the onboard LAN chip when the system boots up.
- Boot Option Priorities**
 These are settings for boot priority. Specify the boot device priority sequence from the available devices.

5.8 Save & Exit Menu

The Save & Exit menu allows users to load your system configuration with optimal or fail-safe default values.

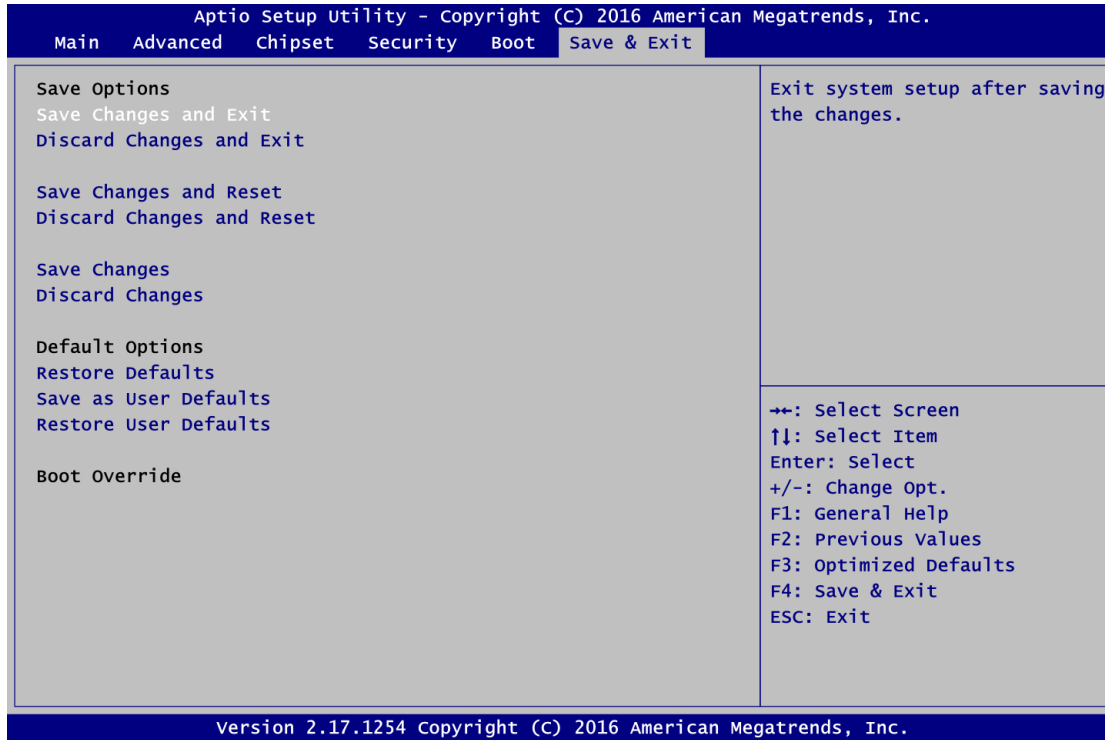

- Save Changes and Exit**
When you have completed the system configuration changes, select this option to leave Setup and return to Main Menu. Select Save Changes and Exit from the Save & Exit menu and press <Enter>. Select Yes to save changes and exit.
- Discard Changes and Exit**
Select this option to quit Setup without making any permanent changes to the system configuration and return to Main Menu. Select Discard Changes and Exit from the Save & Exit menu and press <Enter>. Select Yes to discard changes and exit.
- Save Changes and Reset**
When you have completed the system configuration changes, select this option to leave Setup and reboot the computer so the new system configuration parameters can take effect. Select Save Changes and Reset from the Save & Exit menu and press <Enter>. Select Yes to save changes and reset.
- Discard Changes and Reset**
Select this option to quit Setup without making any permanent changes to the system configuration and reboot the computer. Select Discard Changes and Reset from the Save & Exit menu and press <Enter>. Select Yes to discard changes and reset.
- Save Changes**
When you have completed the system configuration changes, select this option to save changes. Select Save Changes from the Save & Exit menu and press <Enter>. Select Yes to save changes.

- **Discard Changes**
Select this option to quit Setup without making any permanent changes to the system configuration. Select Discard Changes from the Save & Exit menu and press <Enter>. Select Yes to discard changes.
- **Restore Defaults**
It automatically sets all Setup options to a complete set of default settings when you select this option. Select Restore Defaults from the Save & Exit menu and press <Enter>.
- **Save as User Defaults**
Select this option to save system configuration changes done so far as User Defaults. Select Save as User Defaults from the Save & Exit menu and press <Enter>.
- **Restore User Defaults**
It automatically sets all Setup options to a complete set of User Defaults when you select this option. Select Restore User Defaults from the Save & Exit menu and press <Enter>.
- **Boot Override**
Select a drive to immediately boot that device regardless of the current boot order.

This page is intentionally left blank.

Appendix A

Watchdog Timer

A.1 About Watchdog Timer

After the system stops working for a while, it can be auto-reset by the watchdog timer. The integrated watchdog timer can be set up in the system reset mode by program.

A.2 How to Use Watchdog Timer

Start

↓

Un-Lock WDT:

O 2E 87 ; Un-lock super I/O
O 2E 87 ; Un-lock super I/O

↓

Select Logic device:

O 2E 07
O 2F 08

↓

Set Second or Minute:

O 2E F0
O 2F N ; N=00 or 08 (See  Note below)

↓

Set base timer:

O 2E F1
O 2F M ; M=00,01,02,...FF(Hex) ,Value=0 to 255

↓

WDT counting re-set timer:

O 2E F1
O 2F M ; M=00,01,02,...FF (See  Note below)

↓

IF No re-set timer:

; WDT time-out, generate RESET

;IF to disable WDT:

O 2E 30
O 2F 00 ; Can be disabled at any time

- Timeout Value Range
 - 1 to 255
 - Minute / Second

 **Note:**

If **N=00h**, the time base is set to second.

M = time value

00h: Time-out Disable

01h: Time-out occurs after 1 second

02h: Time-out occurs after 2 seconds

03h: Time-out occurs after 3 seconds

.

.

FFh: Time-out occurs after 255 seconds

If **N=08h**, the time base is set to minute.

M = time value

00h: Time-out Disable

01h: Time-out occurs after 1 minute

02h: Time-out occurs after 2 minutes

03h: Time-out occurs after 3 minutes

.

.

FFh: Time-out occurs after 255 minutes

Appendix B

PCI IRQ Routing

B.1 PICMG[®] PCI IRQ Routing

Device	ID	Slot	Int
PCI Slot 0	31	0	BCDA
PCI Slot 1	30	1	CDAB
PCI Slot 2	29	2	DABC
PCI Slot 3	28	3	ABCD

This page is intentionally left blank.

Appendix C

Configuring SATA for RAID

C.1 Configuring SATA Hard Drive(s) for RAID (Controller: Intel® Q170)

Before you begin the SATA configuration, please prepare:

- Two SATA hard drives (to ensure optimal performance, it is recommended that you use two hard drives with identical model and capacity). If you do not want to create RAID with the SATA controller, you may prepare only one hard drive.

Please follow up the steps below to configure SATA hard drive(s):

1. Install SATA hard drive(s) in your system.
2. Enter the BIOS Setup to configure SATA controller mode and boot sequence.
3. Configure RAID by the RAID BIOS.

1. Installing SATA hard drive(s) in your system.

Connect one end of the SATA signal cable to the rear of the SATA hard drive, and the other end to available SATA port(s) on the board. Then, connect the power connector of power supply to the hard drive.

2. Configuring SATA controller mode and boot sequence by the BIOS Setup.

You have to make sure whether the SATA controller is configured correctly by system BIOS Setup and set up BIOS boot sequence for the SATA hard drive(s).

- 2.1. Turn on your system, and then press the button to enter BIOS Setup during running POST (Power-On Self Test). If you want to create RAID, just go to the Advanced Settings menu\SATA Configuration, select the "SATA Mode Selection", and press <Enter> for more options.

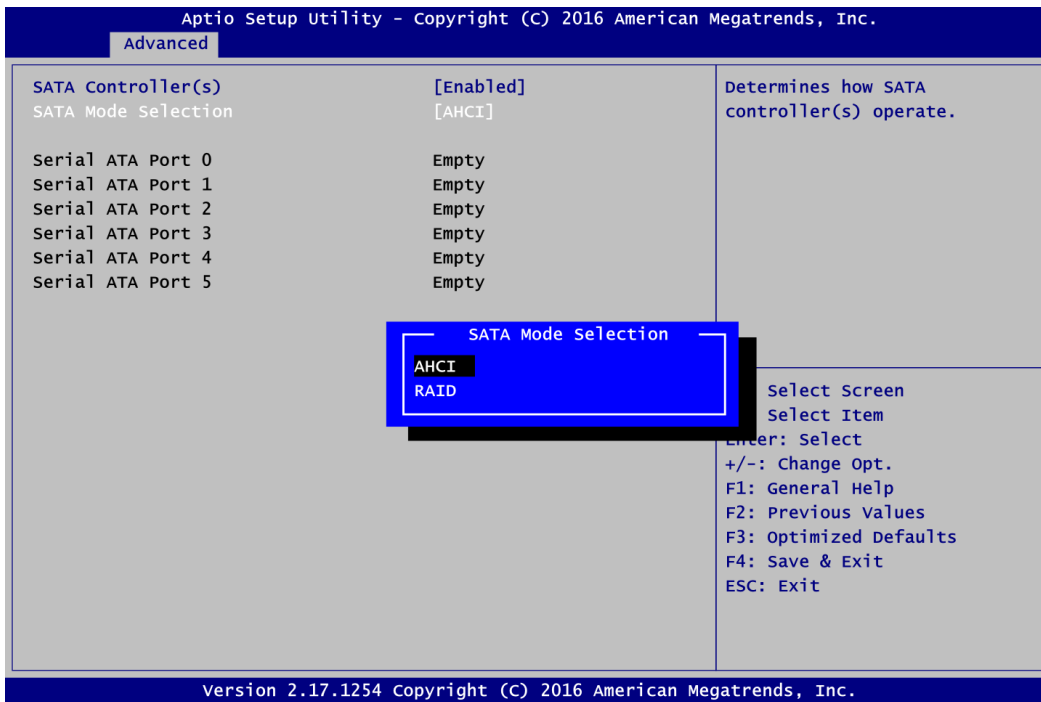

A list of options appears, please select "RAID".

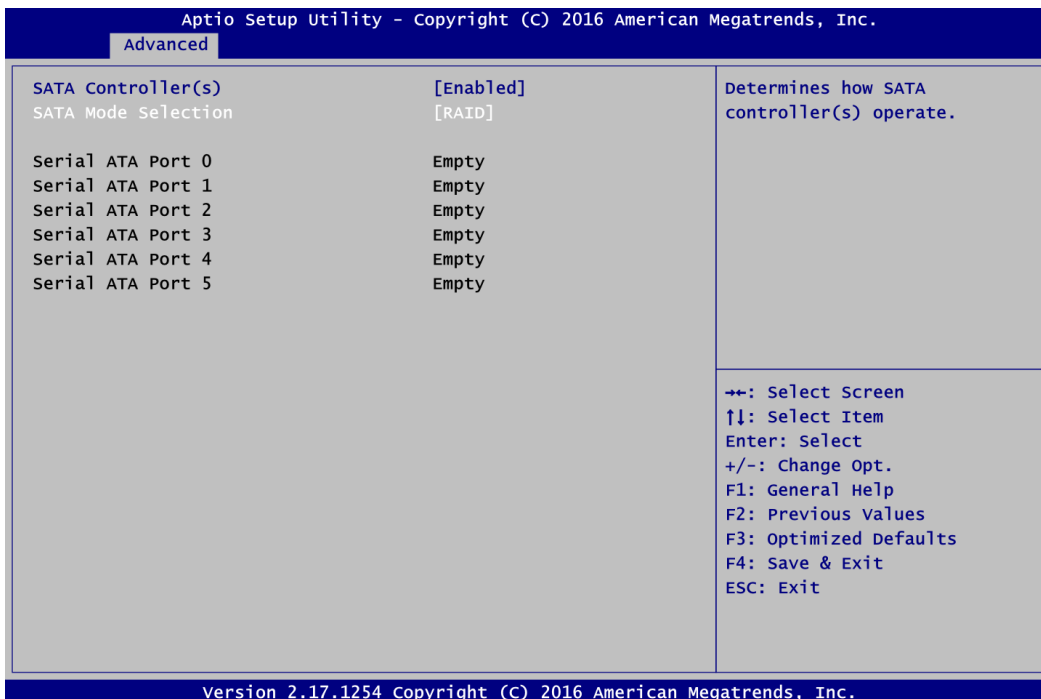

- 2.2. Save and exit the BIOS Setup.

3. Configuring RAID by the RAID BIOS.

Enter the RAID BIOS setup utility to configure a RAID array. Skip this step and proceed if you do not want to create a RAID.

- 3.1. After the POST memory testing and before the operating system booting, a message "Press <Ctrl-I> to enter Configuration Utility" shows up, accordingly, press <Ctrl + I> to enter the RAID BIOS setup utility.

```

Intel(R) Rapid Storage Technology - Option ROM - 12.5.0.1815
Copyright(C) 2003-13 Intel Corporation. All Rights Reserved.

RAID Volumes:
ID      Name           Level           Strip      Size  Status  Bootable
0       Volume1          RAID0(Stripe)  128KB     149.1GB Normal  Yes

Physical Devices:
ID      Device Model      Serial #        Size  Type/Status(Vol ID)
4       ST320LT012-9WS14  WOV20YPA       298.0GB Member Disk(0)
5       ST380817AS        5MR1BSS7       74.5GB Member Disk(0)
Press <CTRL-I> to enter Configuration Utility...

```

- 3.2. After you press <Ctrl + I>, the Create RAID Volume screen will appear. If you want to create a RAID array, select the Create RAID Volume option in the Main Menu and press <Enter>.

```

Intel(R) Rapid Storage Technology - Option ROM - 12.5.0.1815
Copyright(C) 2003-13 Intel Corporation. All Rights Reserved.

[ MAIN MENU ]

1. Create RAID Volume
2. Delete RAID Volume
3. Reset Disks to Non-RAID
4. Recovery Volume Options
5. Acceleration Options
6. Exit

[ DISK/VOLUME INFORMATION ]

RAID Volumes:
None Defined.

Physical Devices:
ID      Device Model      Serial #        Size  Type/Status(Vol ID)
4       ST320LT012-9WS14  WOV20YPA       298.0GB Non-RAID Disk
5       ST380817AS        5MR1BSS7       74.5GB Non-RAID Disk

[!!]-Select      [ESC]-Exit      [Enter]-Select Menu

```

3.3. After entering the Create Volume Menu screen, you can type the disk array name with 1~16 letters (letters cannot be special characters) in the item "Name".

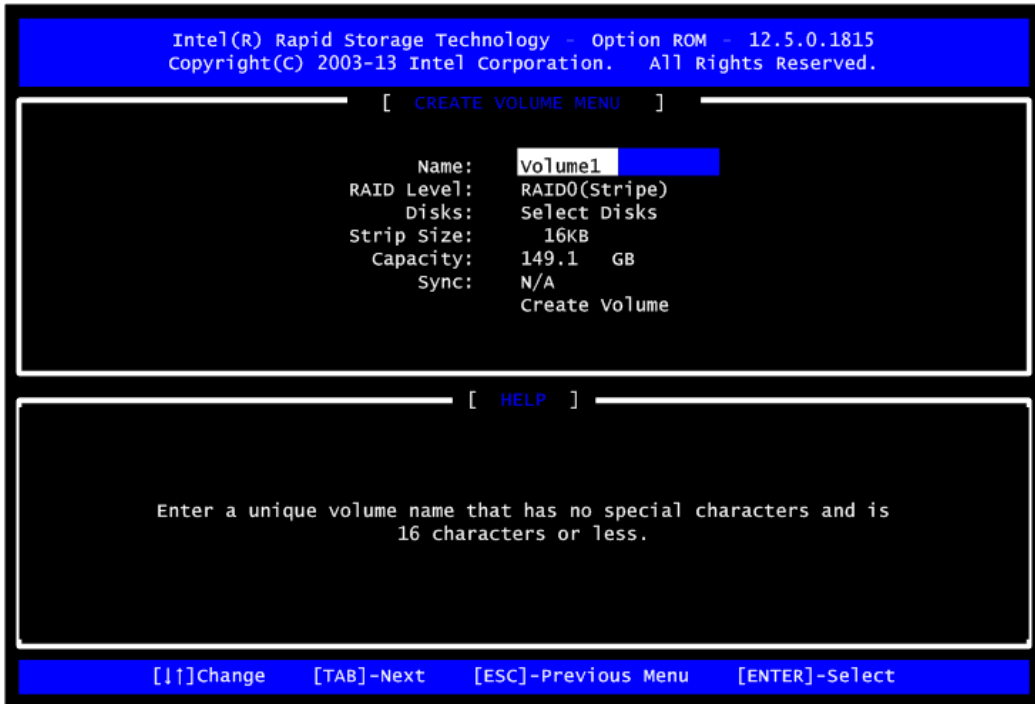

3.4. When finished, press <Enter> to select a RAID level. There are three RAID levels: RAID0, RAID1 and RAID5 and RAID10. Select a RAID level and press <Enter>.

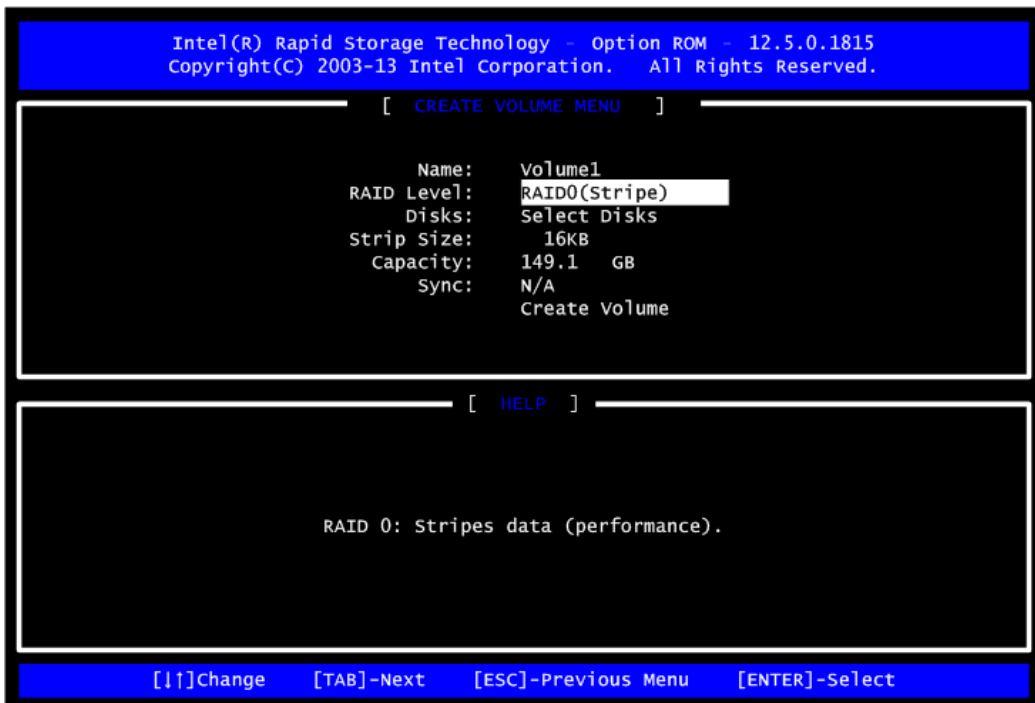

- 3.5. Set the stripe block size. The KB is the standard unit of stripe block size. The stripe block size can be 4KB to 128KB. After the setting, press <Enter> for the array capacity.

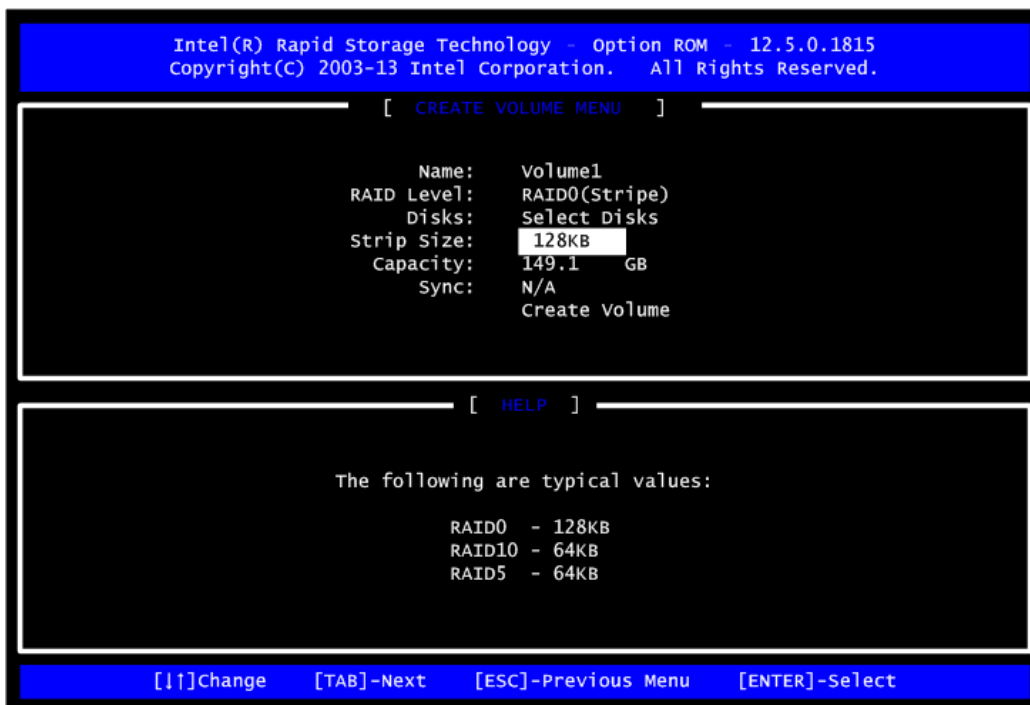

- 3.6. After setting all the items on the menu, select Create Volume and press <Enter> to start creating the RAID array.

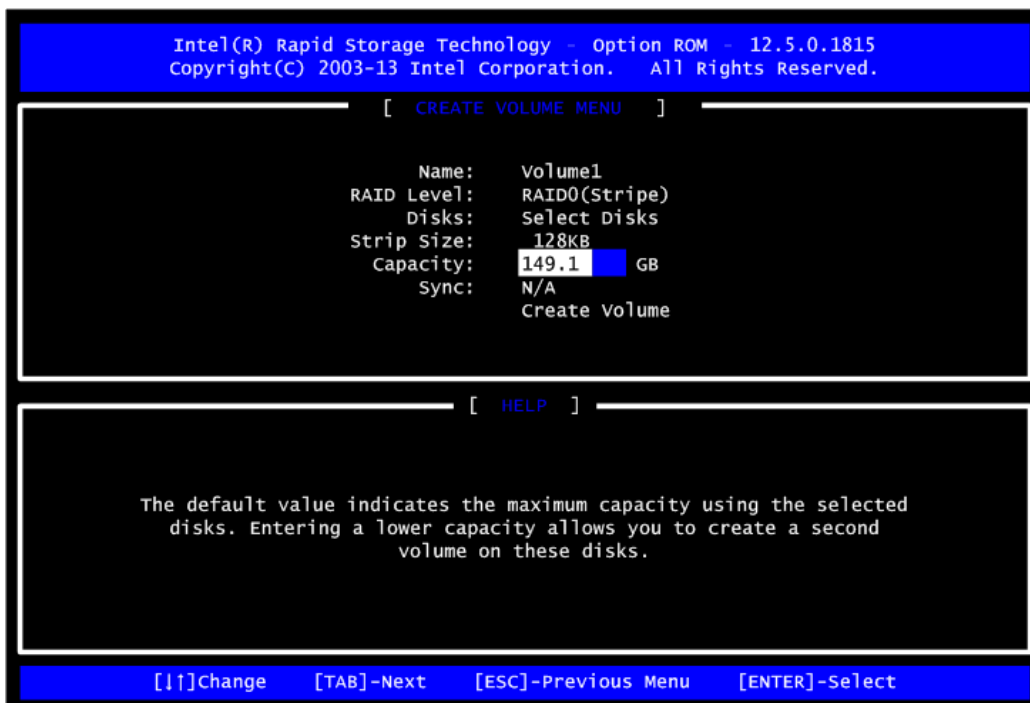

3.7. When prompting the confirmation, press <Y> to create this volume, or <N> to cancel the creation.

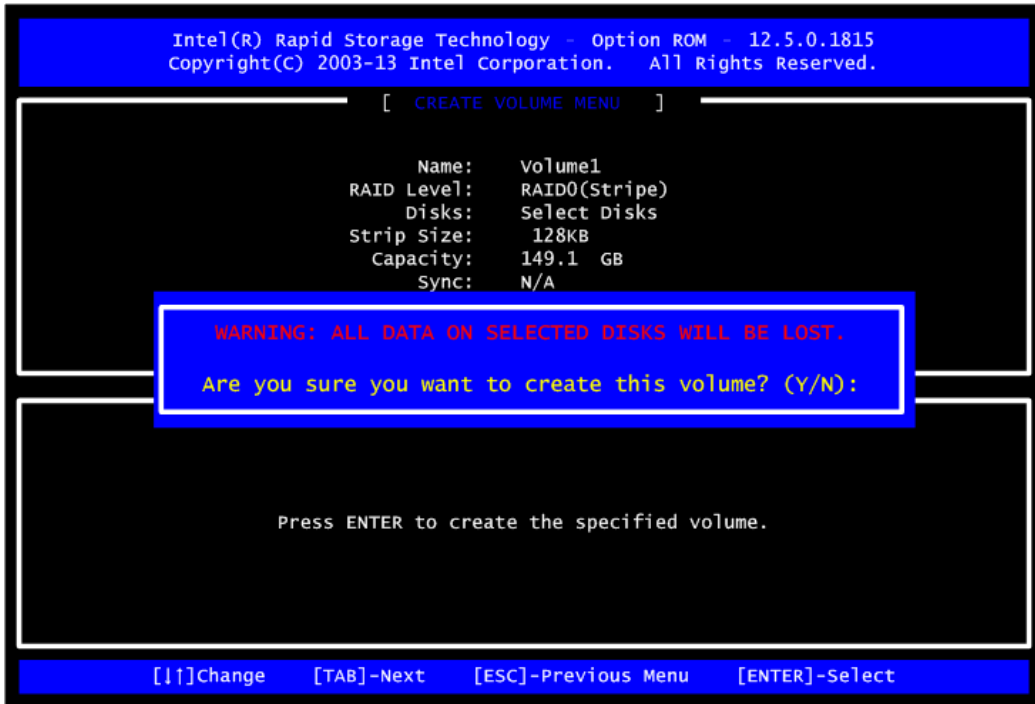

After the creation is completed, you can see detailed information about the RAID Array in the Disk/Volume Information section, including RAID mode, disk block size, disk name, and disk capacity, etc.

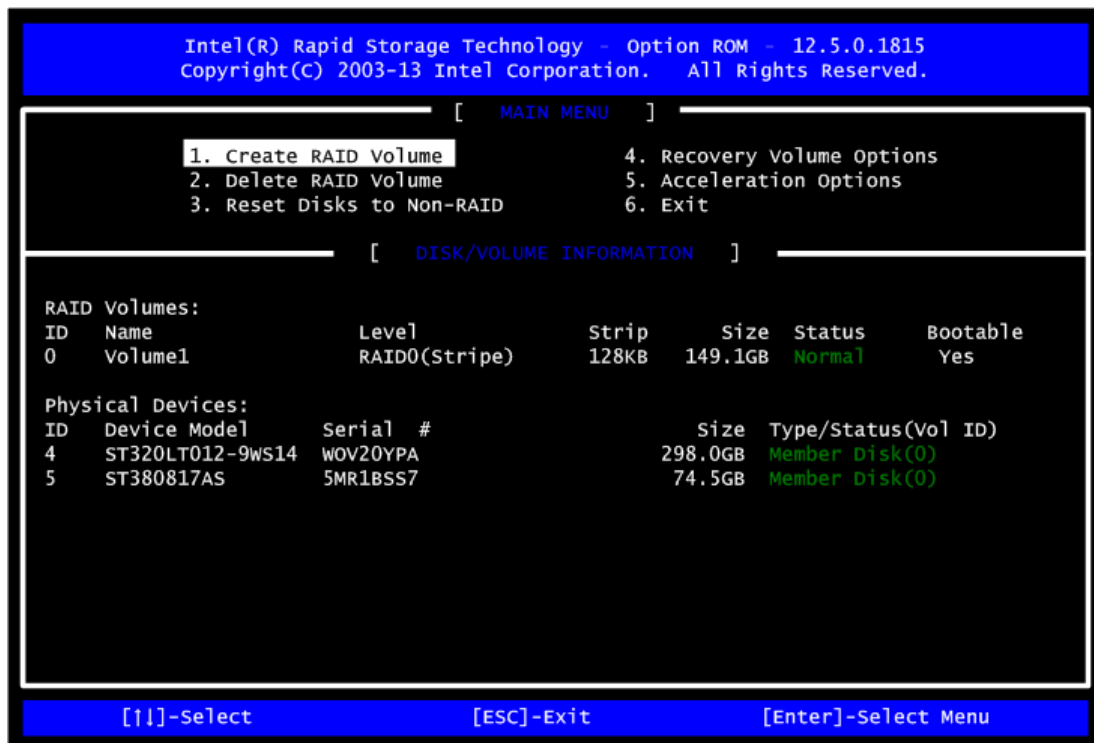

Delete RAID volume

If you want to delete a RAID volume, select the Delete RAID Volume option in Main Menu. Press <Enter> and follow on-screen instructions.

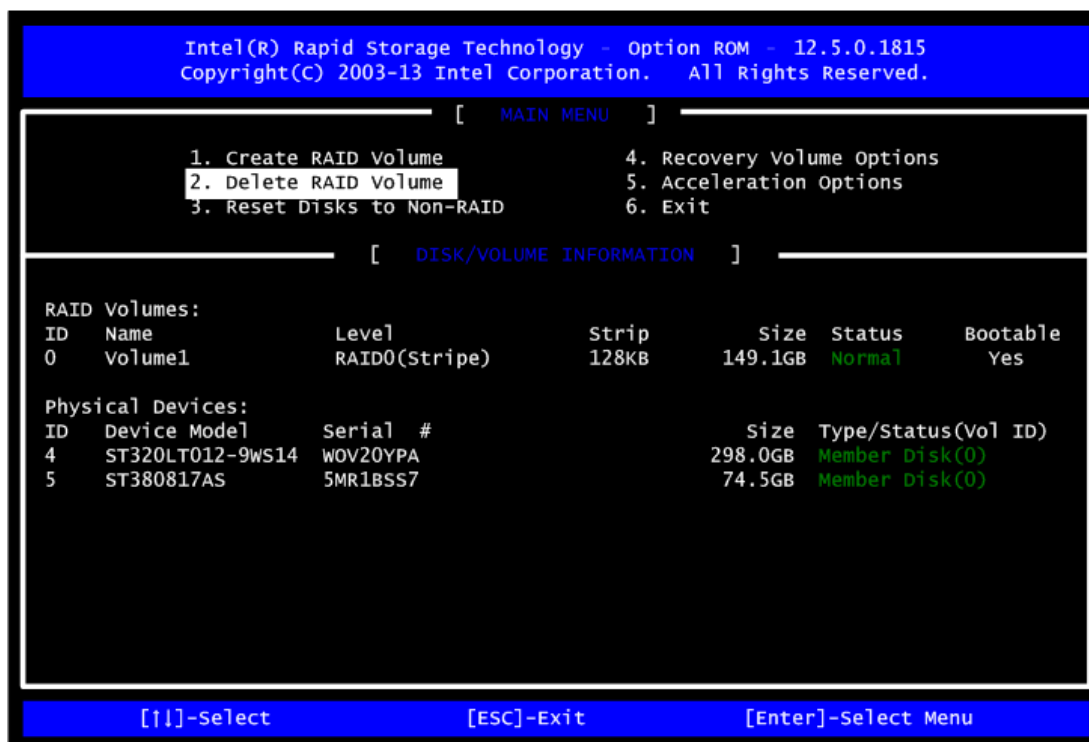

Please press <Esc> to exit the RAID BIOS utility. Now, you can proceed to install a SATA driver controller and the operating system.

This page is intentionally left blank.

Appendix D

iAMT Settings

The Intel® Active Management Technology (Intel® iAMT) has decreased a major barrier to IT efficiency that uses built-in platform capabilities and popular third-party management and security applications to allow IT a better discovering, healing, and protection their networked computing assets.

In order to utilize Intel® iAMT you must enter the ME BIOS (<Ctrl + P> during system startup), change the ME BIOS password, and then select “Intel® iAMT” as the manageability feature.

D.1 Entering MEBx

1. You must go to BIOS to enable iAMT function.
2. Exit from BIOS after starting iAMT, and press <Ctrl + P> to enter MEBx Setting.



Note

It is better to press <Ctrl + P> before the screen popping out.

D.2 Set and Change Password

1. You will be asked to set a password when first log in. The default password is “admin”.

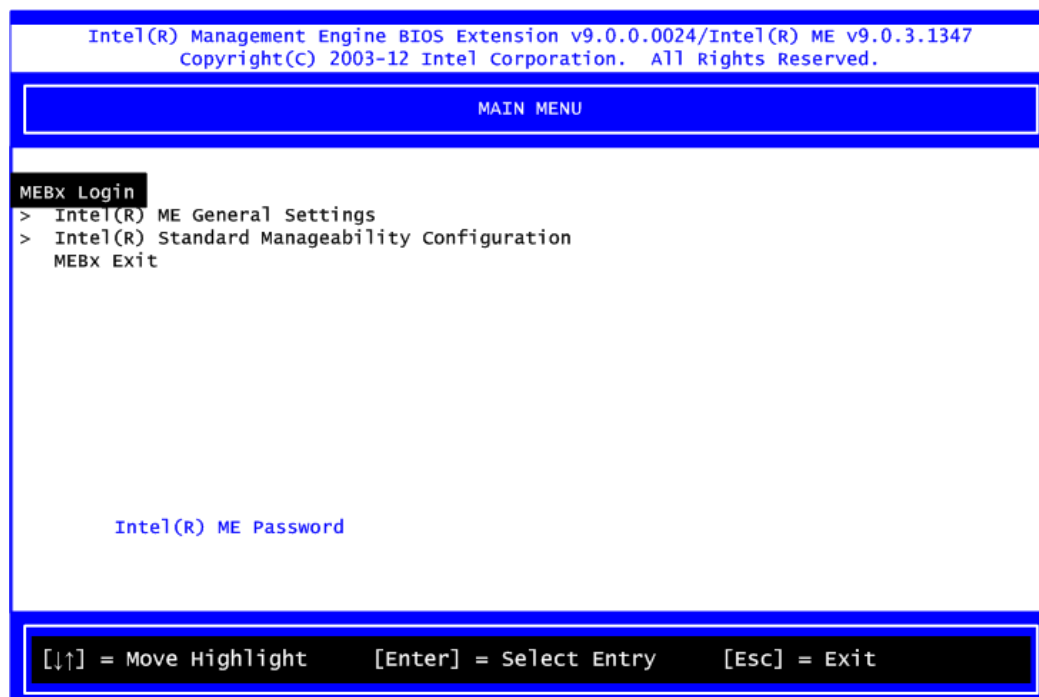

2. You will be asked to change the password before setting ME.

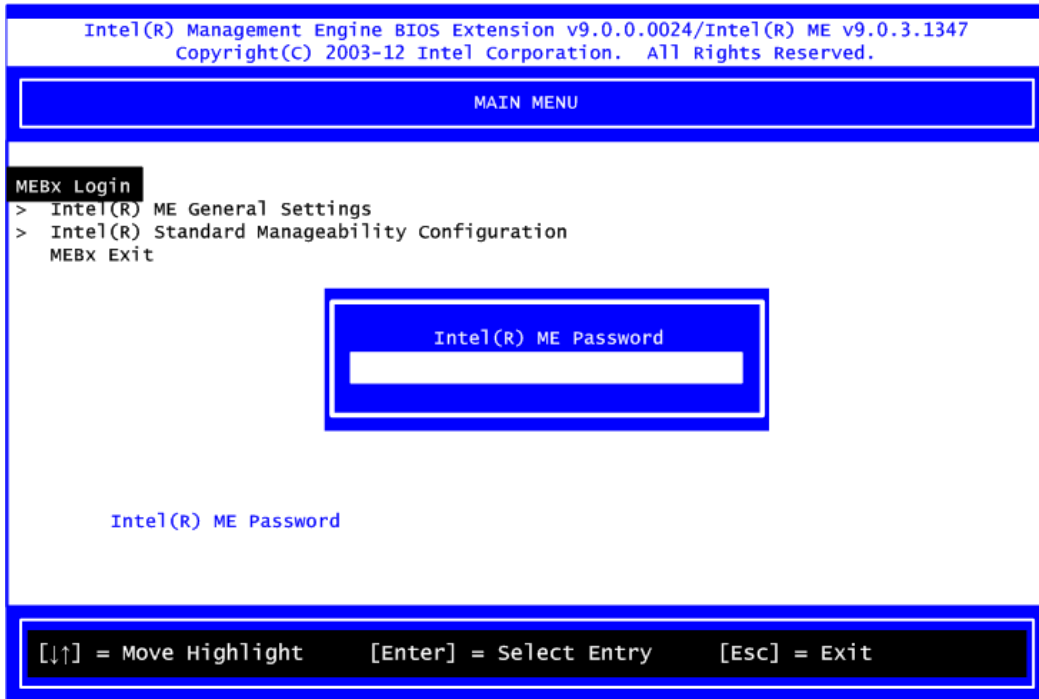

3. You must confirm your new password while revising. The new password must contain: (example: **!!11qqQQ**) (default value).

- Eight characters
- One upper case
- One lower case
- One number
- One special symbol, such as ! , \$ or ; , (, " , , excepted)

Underline (_) and space are valid characters for password, but they won't make higher complexity.

D.3 iAMT Settings

Select Intel® iAMT configuration and press <Enter>.

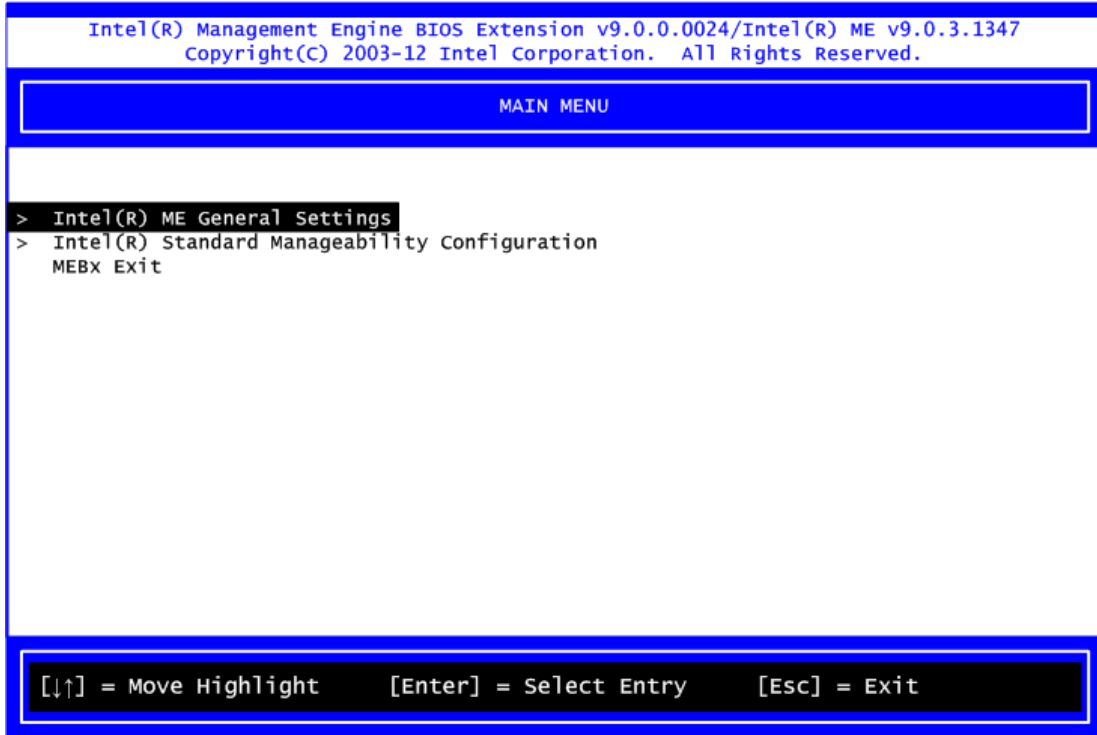

1. Select Network Setup to configure iAMT.

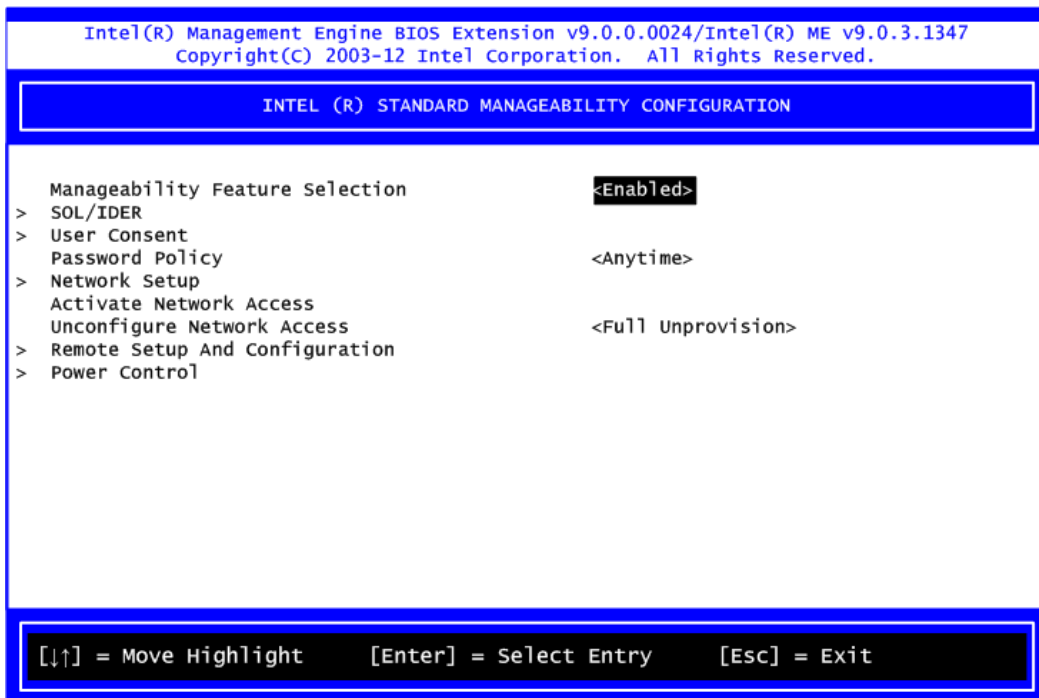

2. Select TCP/IP to get into Network interface and set it to Enabled. Get into DHCP Mode and set it to Disabled.

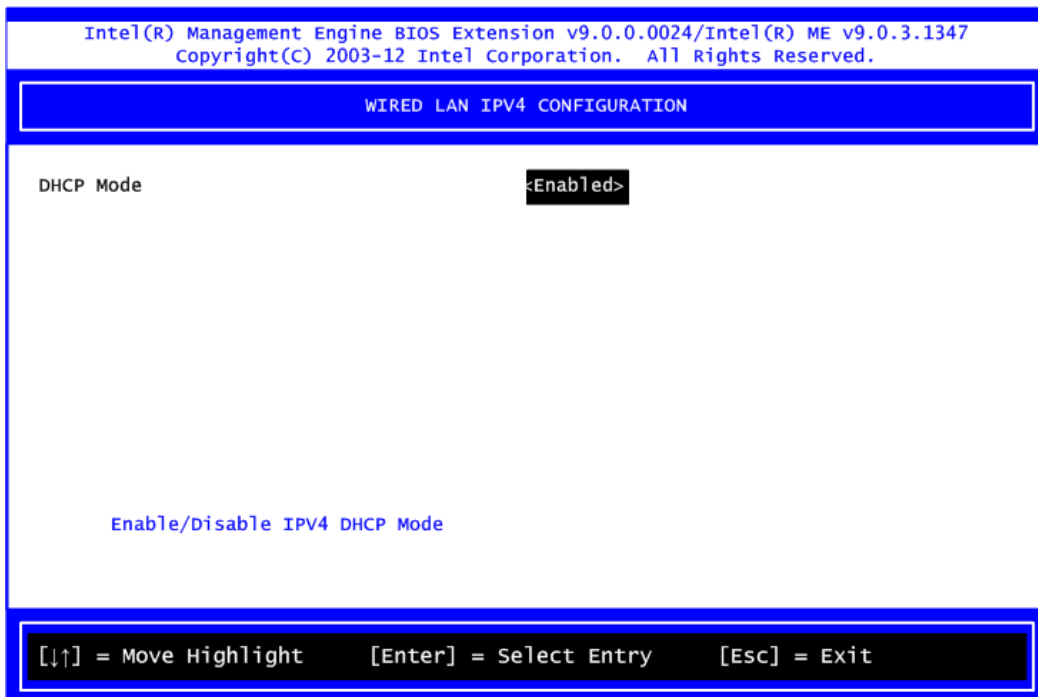
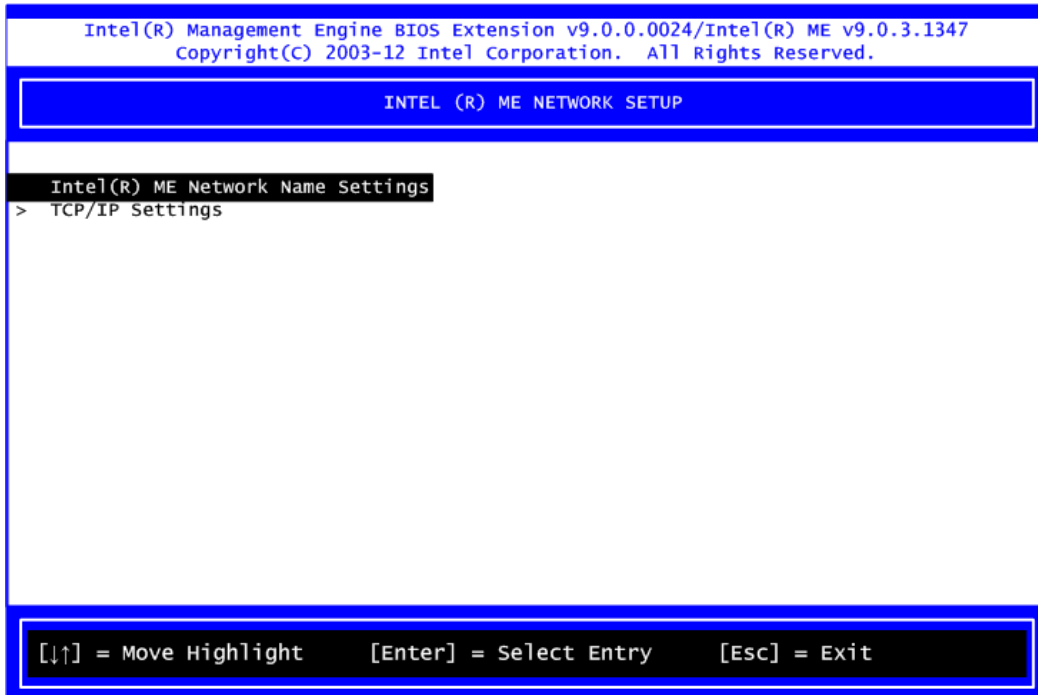

3. If DHCP Mode is disabled, set the following settings:

- IP address
- Subnet mask

Intel(R) Management Engine BIOS Extension v9.0.0.0024/Intel(R) ME v9.0.3.1347
Copyright(C) 2003-12 Intel Corporation. All Rights Reserved.

WIRED LAN IPV4 CONFIGURATION

DHCP Mode	<Disabled>
IPV4 Address	10.1.40.214
Subnet Mask Address	255.255.255.0
Default Gateway Address	0.0.0.0
Preferred DNS Address	0.0.0.0
Alternate DNS Address	0.0.0.0

Subnet mask (e.g. 255.255.255.0)
255.255.255.0

<Enter> = Complete Entry [Esc] = Discard Changes

4. Go back to Intel® iAMT Configuration, then select Activate Network Access and press <Enter>.

Intel(R) Management Engine BIOS Extension v9.0.0.0024/Intel(R) ME v9.0.3.1347
Copyright(C) 2003-12 Intel Corporation. All Rights Reserved.

INTEL (R) STANDARD MANAGEABILITY CONFIGURATION

Manageability Feature Selection	<Enabled>
> SOL/IDER	
> User Consent	
Password Policy	<Anytime>
> Network Setup	
Activate Network Access	
Unconfigure Network Access	
> Remote Setup And Configurati	
> Power Control	

Activates the current network settings
and opens the ME network interface
Continue: (Y/N)

[↓↑] = Move Highlight [Enter] = Select Entry [Esc] = Exit

5. Exit from MEBx after completing the iAMT settings.

D.4 iAMT Web Console

1. From a web browser, please type [http://\(IP ADDRESS\):16992](http://(IP ADDRESS):16992), which connects to iAMT Web.

Example: <http://10.1.40.214:16992>

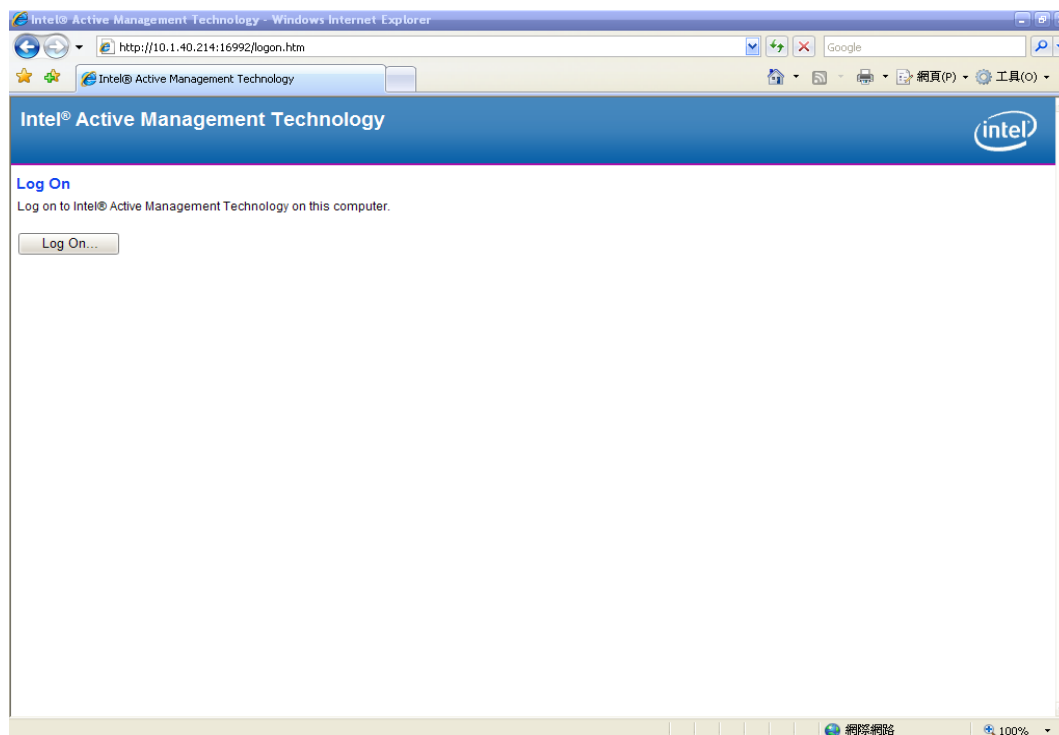

2. To log on, you will be required to type in username and password for access to the Web.

USER: admin (default value)

PASS: (MEBx password)

3. Enter the iAMT Web.

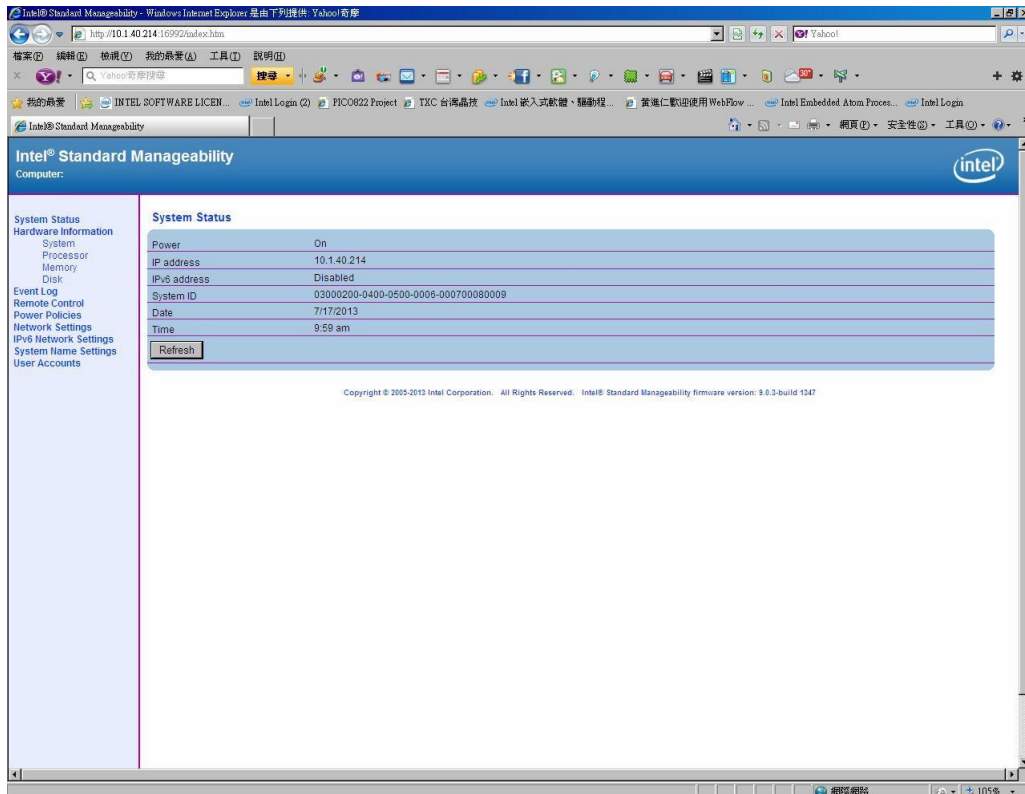

4. Click Remote Control, and select commands on the right side.

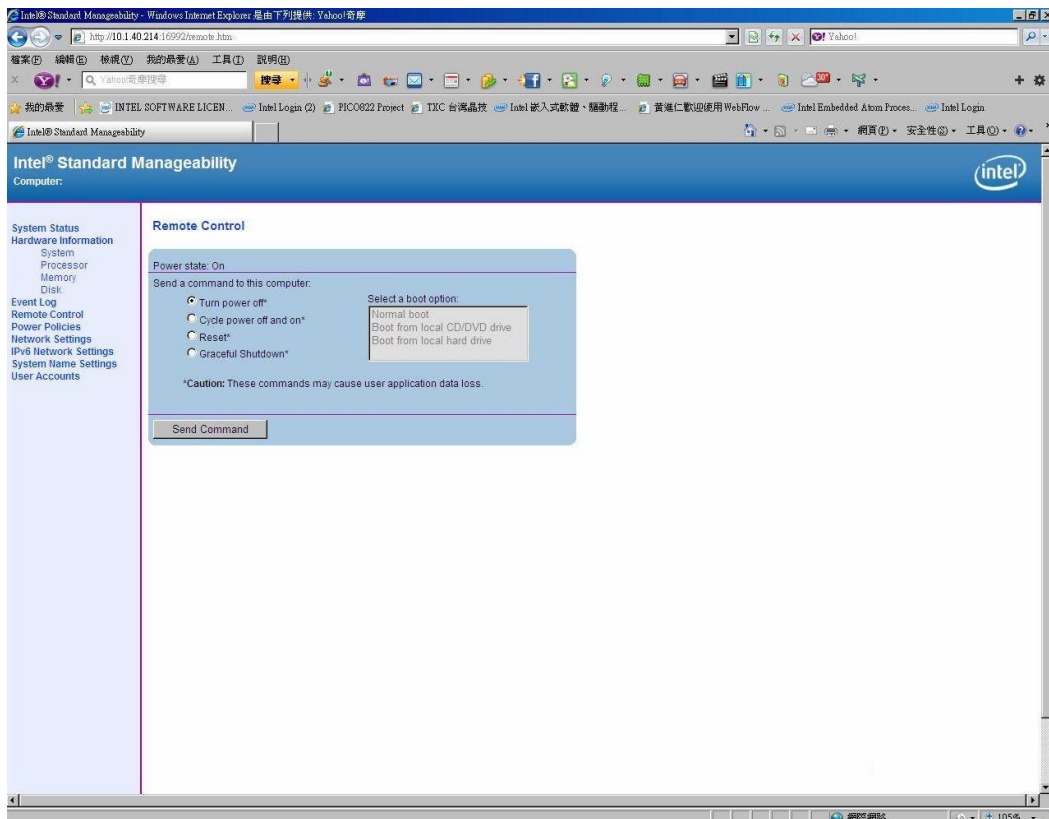

5. When you have finished using the iAMT Web console, close the Web browser.

Appendix E

PICMG[®] v1.3 Interface Definition

x16 PCIe Connector A			x16 PCIe Connector C		
No.	Side B	Side A	No.	Side B	Side A
1	N.C	N.C	1	USB0P	GND
2	GND	GND	2	USB0N	GND
3	N.C	N.C	3	GND	USB1P
4	N.C	N.C	4	GND	USB1N
5	N.C	WAKE#	5	USB2P	GND
6	PWRBT#	PME#	6	USB2N	GND
7	PWRGD	PSON#	7	GND	USB3P
8	SHB_RST#	PERST#	8	GND	USB3N
9	CFG0	CFG1	9	USBOC0#	GND
10	CFG2	CFG3	10	GND	USBOC1#
11	RSVD	GND	11	USBOC2#	GND
Mechanical Key					
12	GND	N.C	12	GND	USBOC3#
13	b_PETp0	GND	13	N.C	GND
14	b_PETn0	GND	14	N.C	GND
15	GND	b_PERp0	15	GND	N.C
16	GND	b_PERn0	16	GND	N.C
17	b_PETp1	GND	17	N.C	GND
18	b_PETn1	GND	18	N.C	GND
19	GND	b_PERp1	19	GND	N.C
20	GND	b_PERn1	20	GND	N.C
21	b_PETp2	GND	21	N.C	GND
22	b_PETn2	GND	22	N.C	GND
23	GND	b_PERp2	23	GND	N.C
24	GND	b_PERn2	24	GND	N.C
25	b_PETp3	GND	25	N.C	GND
26	b_PETn3	GND	26	N.C	GND

Mechanical Key					
27	GND	b_PERp3	27	GND	N.C
28	GND	b_PERn3	28	GND	N.C
29	REFCLK0+	GND	29	N.C	GND
30	REFCLK0-	GND	30	N.C	GND
31	GND	REFCLK1+	31	N.C	N.C
32	RSVD	REFCLK1-	32	N.C	N.C
33	REFCLK2+	GND	33	N.C	N.C
34	REFCLK2-	GND	34	N.C	GND
35	GND	REFCLK3+	35	N.C	GND
36	RSVD	REFCLK3-	36	GND	N.C
37	REFCLK4+	GND	37	GND	N.C
38	REFCLK4-	GND	38	N.C	GND
39	GND	N.C	39	N.C	GND
40	RSVD	N.C	40	GND	N.C
41	N.C	GND	41	GND	N.C
42	N.C	GND	42	+3.3V	+3.3V
43	GND	N.C	43	+3.3V	+3.3V
44	GND	N.C	44	+3.3V	+3.3V
45	a_PETp0	GND	45	+3.3V	+3.3V
46	a_PETn0	GND	46	+3.3V	+3.3V
47	GND	a_PERp0	47	+3.3V	+3.3V
48	GND	a_PERn0	48	+3.3V	+3.3V
49	a_PETp1	GND	49	+3.3V	+3.3V
50	a_PETn1	GND	50	+3.3V	+3.3V
51	GND	a_PERp1	51	GND	GND
52	GND	a_PERn1	52	GND	GND
53	a_PETp2	GND	53	GND	GND
54	a_PETn2	GND	54	GND	GND
55	GND	a_PERp2	55	GND	GND
56	GND	a_PERn2	56	GND	GND
57	a_PETp3	GND	57	GND	GND

Mechanical Key					
58	a_PETn3	GND	58	GND	GND
59	GND	a_PERp3	59	+5V	+5V
60	GND	a_PERn3	60	+5V	+5V
61	a_PETp4	GND	61	+5V	+5V
62	a_PETn4	GND	62	+5V	+5V
63	GND	a_PERp4	63	GND	GND
64	GND	a_PERn4	64	GND	GND
65	a_PETp5	GND	65	GND	GND
66	a_PETn5	GND	66	GND	GND
67	GND	a_PERp5	67	GND	GND
68	GND	a_PERn5	68	GND	GND
69	a_PETp6	GND	69	GND	GND
70	a_PETn6	GND	70	GND	GND
71	GND	a_PERp6	71	GND	GND
72	GND	a_PERn6	72	GND	GND
73	a_PETp7	GND	73	+12V	+12V
74	a_PETn7	GND	74	+12V	+12V
75	GND	a_PERp7	75	+12V	+12V
76	GND	a_PERn7	76	+12V	+12V
77	N.C	GND	77	+12V	+12V
78	+3.3V	+3.3V	78	+12V	+12V
79	+3.3V	+3.3V	79	+12V	+12V
80	+3.3V	+3.3V	80	+12V	+12V
81	+3.3V	+3.3V	81	+12V	+12V
82	RSVD	RSVD	82	+12V	+12V

x8 PCIe Connector B			x8 PCIe Connector D		
No.	Side B	Side A	No.	Side B	Side A
1	+5Vaux	+5Vaux	1	INTB#	INTA#
2	GND	N.C	2	INTD#	INTC#
3	a_PETp8	GND	3	GND	N.C
4	a_PETn8	GND	4	REQ3#	GNT3#
5	GND	a_PERp8	5	REQ2#	GNT2#
6	GND	a_PERn8	6	PCI_RST#	GNT1#
7	a_PETp9	GND	7	REQ1#	GNT0#
8	a_PETn9	GND	8	REQ0#	SERR#
9	GND	a_PERp9	9	N.C	+3.3V
10	GND	a_PERn9	10	GND	N.C
11	N.C	GND	11	N.C	GND
Mechanical Key					
12	GND	N.C	12	CLKC	CLKD
13	a_PETp10	GND	13	GND	+3.3V
14	a_PETn10	GND	14	CLKA	CLKB
15	GND	a_PERp10	15	+3.3V	GND
16	GND	a_PERn10	16	AD31	GND
17	a_PETp11	GND	17	AD29	+3.3V
18	a_PETn11	GND	18	N.C	AD30
19	GND	a_PERp11	19	AD27	AD28
20	GND	a_PERn11	20	AD25	GND
21	a_PETp12	GND	21	GND	AD26
22	a_PETn12	GND	22	C/BE3#	AD24
23	GND	a_PERp12	23	AD23	+3.3V
24	GND	a_PERn12	24	GND	AD22
25	a_PETp13	GND	25	AD21	AD20
26	a_PETn13	GND	26	AD19	N.C
27	GND	a_PERp13	27	+5V	AD18
28	GND	a_PERn13	28	AD17	AD16

Mechanical Key					
29	a_PETp14	GND	29	C/BE2#	GND
30	a_PETn14	GND	30	PCI_PRST#	FRAME#
31	GND	a_PERp14	31	IRDY#	TRDY#
32	GND	a_PERn14	32	DEVSEL#	+5V
33	a_PETp15	GND	33	LOCK#	STOP#
34	a_PETn15	GND	34	PERR#	GND
35	GND	a_PERp15	35	GND	C/BE1#
36	GND	a_PERn15	36	PAR	AD14
37	N.C	GND	37	N.C	GND
38	N.C	N.C	38	GND	AD12
39	GND	GND	39	AD15	AD10
40	GND	GND	40	AD13	GND
41	GND	GND	41	GND	AD09
42	GND	GND	42	AD11	C/BE0#
43	GND	GND	43	AD08	GND
44	+12V	+12V	44	GND	AD06
45	+12V	+12V	45	AD07	AD05
46	+12V	+12V	46	AD04	GND
47	+12V	+12V	47	GND	AD02
48	+12V	+12V	48	AD03	AD01
49	+12V	+12V	49	AD00	GND

**Note**

Please contact your vendor to get the backplane design guide if it's required. The backplane design guide is NDA required.