



®

AXIOMTEK

tBOX323-835-FL Series

Embedded System

User's Manual



Disclaimers

This manual has been carefully checked and believed to contain accurate information. Axiomtek Co., Ltd. assumes no responsibility for any infringements of patents or any third party's rights, and any liability arising from such use.

Axiomtek does not warrant or assume any legal liability or responsibility for the accuracy, completeness or usefulness of any information in this document. Axiomtek does not make any commitment to update the information in this manual.

Axiomtek reserves the right to change or revise this document and/or product at any time without notice.

No part of this document may be reproduced, stored in a retrieval system, or transmitted, in any form or by any means, electronic, mechanical, photocopying, recording, or otherwise, without the prior written permission of Axiomtek Co., Ltd.

©Copyright 2017 Axiomtek Co., Ltd.
All Rights Reserved
Feb. 2017, Version A4
Printed in Taiwan

Safety Precautions

Before getting started, please read the following important safety precautions.

1. User should not modify any unmentioned jumper setting without Axiomtek FAE's instruction. Any modification without instruction might cause system to become damage
2. The tBOX323-835-FL does not come equipped with an operating system. An operating system must be loaded first before installing any software into the computer.
3. Be sure to ground yourself to prevent static charge when installing the internal components. Use a grounding wrist strap and place all electronic components in any static-shielded devices. Most electronic components are sensitive to static electrical charge.
4. Disconnect the power cord from the tBOX323-835-FL before making any installation. Be sure both the system and the external devices are turned OFF. Sudden surge of power could ruin sensitive components. Make sure the tBOX323-835-FL is properly grounded.
5. Make sure the voltage of the power source is correct before connecting the equipment to the power outlet.
6. Turn OFF the system power before cleaning. Clean the system using a cloth only. Do not spray any liquid cleaner directly onto the screen.
7. Do not leave this equipment in an uncontrolled environment where the storage temperature is below -40°C or above 80°C . It may damage the equipment.
8. Do not open the system's back cover. If opening the cover for maintenance is a must, only a trained technician is allowed to do so. Integrated circuits on computer boards are sensitive to static electricity. To avoid damaging chips from electrostatic discharge, observe the following precautions:
 - Before handling a board or integrated circuit, touch an unpainted portion of the system unit chassis for a few seconds. This will help to discharge any static electricity on your body.
 - When handling boards and components, wear a wrist-grounding strap, available from most electronic component stores.

Classification

1. Degree of protection against electric shock: not classified
2. Degree of protection against the ingress of water: IP40
3. Equipment not suitable for use in the presence of a flammable anesthetic mixture with air or with oxygen or nitrous oxide.
4. Mode of operation: Continuous

General Cleaning Tips

You may need the following precautions before you begin to clean the computer. When you clean any single part or component for the computer, please read and understand the details below fully.

When you need to clean the device, please rub it with a piece of dry cloth.

1. Be cautious of the tiny removable components when you use a vacuum cleaner to absorb the dirt on the floor.
2. Turn the system off before you start to clean up the component or computer.
3. Never drop the components inside the computer or get circuit board damp or wet.
4. Be cautious of all kinds of cleaning solvents or chemicals when you use it for the sake of cleaning. Some individuals may be allergic to the ingredients.
5. Try not to put any food, drink or cigarette around the computer.

Cleaning Tools:

Although many companies have created products to help improve the process of cleaning your computer and peripherals users can also use household items to clean their computers and peripherals. Below is a listing of items you may need or want to use while cleaning your computer or computer peripherals.

Keep in mind that some components in your computer may only be able to be cleaned using a product designed for cleaning that component, if this is the case it will be mentioned in the cleaning.

- Cloth: A piece of cloth is the best tool to use when rubbing up a component. Although paper towels or tissues can be used on most hardware as well, we still recommend you to rub it with a piece of cloth.
- Water or rubbing alcohol: You may moisten a piece of cloth a bit with some water or rubbing alcohol and rub it on the computer. Unknown solvents may be harmful to the plastics parts.
- Vacuum cleaner: Absorb the dust, dirt, hair, cigarette particles, and other particles out of a computer can be one of the best methods of cleaning a computer. Over time these items can restrict the airflow in a computer and cause circuitry to corrode.
- Cotton swabs: Cotton swabs moistened with rubbing alcohol or water are excellent tools for wiping hard to reach areas in your keyboard, mouse, and other locations.
- Foam swabs: Whenever possible it is better to use lint free swabs such as foam swabs.



NOTE: We strongly recommended that you should shut down the system before you start to clean any single components.

Please follow the steps below:

1. Close all application programs
2. Close operating software
3. Turn off power switch
4. Remove all device
5. Pull out power cable

Scrap Computer Recycling

If the computer equipments need the maintenance or are beyond repair, we strongly recommended that you should inform your Axiomtek distributor as soon as possible for the suitable solution. For the computers that are no longer useful or no longer working well, please contact your Axiomtek distributor for recycling and we will make the proper arrangement.

Trademarks Acknowledgments

Axiomtek is a trademark of Axiomtek Co., Ltd.

Windows® is a trademark of Microsoft Corporation.

AMI® is a registered trademark of American Megatrends Inc.

IBM, PC/AT, PS/2, VGA are trademarks of International Business Machines Corporation.

Intel® and Atom™ are trademarks of Intel Corporation.

Winbond is a trademark of Winbond Electronics Corp.

Other brand names and trademarks are the properties and registered brands of their respective owners.

Table of Contents

Disclaimers.....	ii
Safety Precautions.....	iii
Classification.....	iv
CHAPTER 1 INTRODUCTION	1
1.1 General Description.....	1
1.2 System Specifications	2
1.2.1 CPU	2
1.2.2 System I/O	2
1.2.3 System Specification.....	2
1.2.4 Driver CD Content.....	3
1.3 Dimensions	4
1.4 I/O Outlets.....	5
1.5 Packing List.....	6
CHAPTER 2 HARDWARE INSTALLATION	7
2.1 Installing the swappable HDD/SSD or CFast Card.....	7
2.2 Installing the Express Mini Card and SIM card	8
2.3 Installing HDMI bracket	9
CHAPTER 3 JUMPER SETTING & CONNECTOR.....	11
3.1 mSATA/CFast Setting	11
3.2 Connectors.....	12
3.2.1 VGA Connector	12
3.2.2 Remote switch Connector	12
3.3.3 Serial Port Connector	13
3.3.4 USB2.0 Stack Ports	14
3.3.5 LED Indicators.....	14
3.3.6 DC Power Input connector.....	14
3.3.7 M12 LAN Connector (LAN1,2).....	15
3.3.8 Digital I/O Connector	15
3.3.9 SIM Card Connector	16
3.3.10 PCI-Express Mini Card Connector	17
3.3.11 CFast™ Socket	18
3.2.12 Serial Port Connector.....	19
3.2.13 HDD tray locker.....	19
3.2.14 HDMI Connecetor	20
3.2.15 Fuse	20
3.2.16 Antenna opening	20
CHAPTER 4 AMI BIOS SETUP UTILITY	21
4.1 Starting	21
4.2 Navigation Keys	22
4.3 Main Menu	23
4.4 Advanced Menu	24
4.5 Chipset Menu	30
4.6 Boot Menu	31
4.7 Security Menu	32
4.8 Save & Exit Menu	33
APPENDIX A WATCHDOG TIMER	35
What is Watchdog Timer	35

How to Use the Watchdog Timer	35
APPENDIX B DIGITAL I/O	37
Digital I/O Specification	37
Digital I/O Software Programming	37

CHAPTER 1 INTRODUCTION

This chapter contains general information and detailed specifications of the tBOX323-835-FL. The Chapter 1 includes the following sections:

- General Description
- System Specifications
- Dimensions
- I/O Outlets
- Package List

1.1 General Description

The tBOX323-835-FL is an embedded system that supports onboard Intel® Atom™ E3845 processor (1.91 GHz), to provide Windows® 7, Windows® 8, Windows® embedded and Linux, suitable for the most endurable operation. It features fanless design with full feature I/O, supports onboard 4GB DDR3L memory, and enhanced system dependability by built-in Watchdog Timer.

● Features

- Intel® Atom™ E3845 quad core (10W) processor onboard
- High performance DDR3L-1333 4GB memory onboard
- Fanless operating temperature range of -40°C ~ +70°C
- Isolated RS-232(4pin)/422/485 and DIO
- Support USB 2.0 and SATA2
- 1 removable & lockable 2.5" SATA HDD and 1 CFast™
- 3 internal PCI Express Mini Card slot and 2 SIM slot
- Lockable I/O interface and M12 LAN and power connector
- Comply to fire protection of railway vehicles Europe standard PrCEN TS 45545-2

● Reliable and Stable Design

- The tBOX323-835-FL adopts the advanced cooling system and supporting the CFast™, which makes it especially suitable for vibration environments, best for mobility control unit, passenger information system, video surveillance and many more applications.

● Embedded O.S. Supported

- The tBOX323-835-FL not only supports Windows® 7, but also supports embedded OS, such as Windows® 7/8 embedded, WinCE and Linux. For storage device, the tBOX323-835-FL support one 2.5" SATA HDD drive bays, and one CFast™ slot.

1.2 System Specifications

1.2.1 CPU

- **CPU**
 - Onboard Intel® Atom™ E3845 processor (2M Cache, 1.91 GHz)
- **BIOS**
 - American Megatrends Inc. BIOS.
 - “Load Optimized Default” to backup customized Setting in the BIOS flash chip to prevent from CMOS battery fail
- **System Memory**
 - Onboard 4GB DDR3L-1333 Memory
- **Graphics**
 - Integrated in the Intel® HD Graphics for HDMI, VGA

1.2.2 System I/O

- **Two terminal connectors, COM1~4 for isolated RS-232(4pin)/422/485**
- **One 9-pin D-Sub male connector for RS-232**
- **One HDMI female connector, One 15-pin D-Sub female connector for VGA**
- **Two Audio screw connector (Mic-IN, Line-OUT)(front/rear side)**
- **Two isolated M12 type 8-pin connector for 10/100/1000Base-T**
- **Two USB 2.0 connectors (front side)**
- **One isolated 6-in/2-out DIO connector**
- **One 14~32VDC(Typical 24VDC) power input M12 connector**

1.2.3 System Specification

- **Watchdog Timer**
 - Reset supported; 255 levels, 1~255 sec.
- **Power Supply**
 - 14~32 VDC-in power supply (Typical as +24V)
 - Power Rate:14-32Vdc, 1.5A@24Vdc
- **Operation Temperature**
 - -40°C ~ 70°C (- 40°F ~ 158°F)
- **Storage Temperature**
 - -40°C ~ 85°C (- 40°F ~ 176°F)
- **Humidity**
 - 5% ~ 95% (non-condensation)
- **Vibration Endurance**
 - 3Grms w/ SSD,CFast (5 ~ 500Hz, X, Y, Z directions; Random)

- **Weight**
 - 3 kg (6.61 lb) without package
 - 3.8 kg (8.37 lb) with package
- **Dimensions**
 - 244mm(W) x 180.5mm(D) x 65.1mm(H)



NOTE: All specifications and images are subject to change without notice.

1.2.4 Driver CD Content

- **Chipset Driver**
- **Graphic Drivers**
- **Audio Drivers**
- **Ethernet Driver**
- **User Manual**
- **Quick Manual**

1.3 Dimensions

The following diagrams show you dimensions and outlines of the tBOX323-835-FL.

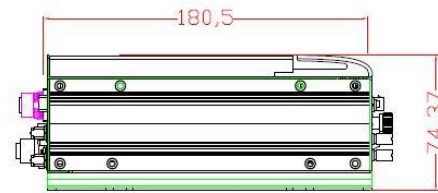
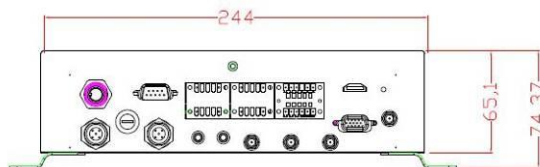
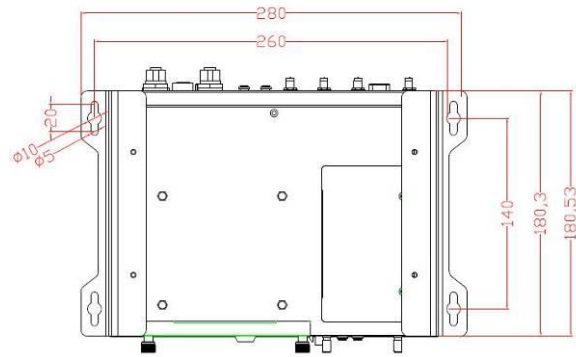
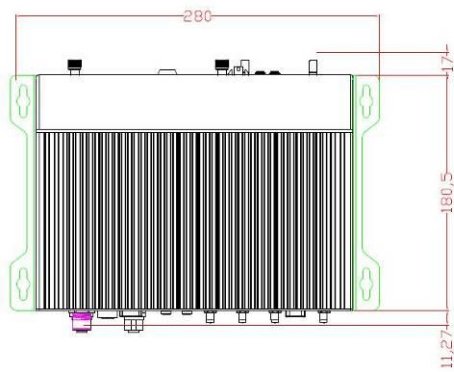
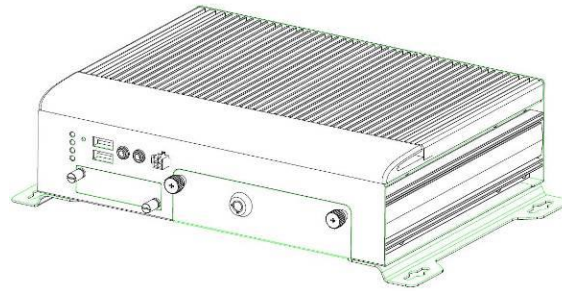

1.4 I/O Outlets

The following figures show you I/O outlets on front view of the tBOX323-835-FL.

- Front View



- Front View drawing

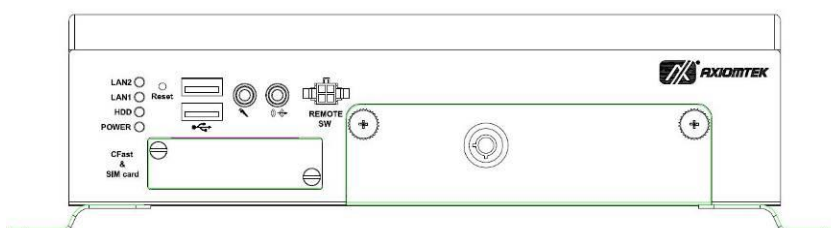

- Rear View



- Rear View drawing

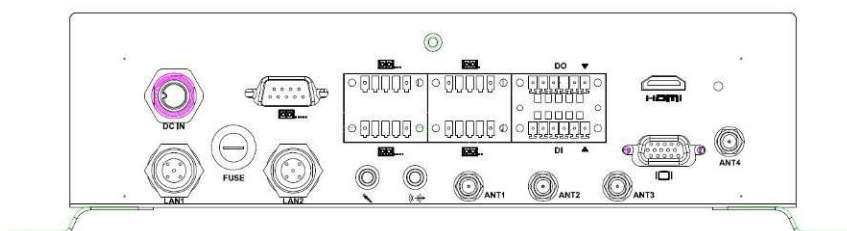

1.5 Packing List

The package bundled with your tBOX323-835-FL should contain the following items:

- **tBOX323-835-FL System Unit x 1**
- **tBOX323-835-FL Quick Manual x 1**
- **CD x 1 (For Driver and User's Manual)**
- **Screws pack**
- **Foot pad x4**
- **HDMI bracket x1**
- **Cable tie x2**
- **Wall-mount Brackets**
- **DIO & Serial connector**
- **HDD/SSD (optional)**
- **CFast (optional)**
- **M12 LAN cable (optional)**
- **M12 Power cable (optional)**
- **M12 Power Adapter (optional)**
- **Remote switch cable (optional)**
- **Express Mini Card Module (optional)**

If you can not find this package or any items are missing, please contact Axiomtek distributors immediately.

CHAPTER 2 HARDWARE INSTALLATION

The tBOX323-835-FL is convenient for your various hardware configurations, such as HDD (Hard Disk Drive), CFast™ card and Express Mini Card. The chapter 2 will show you how to install the hardware.

2.1 Installing the swappable HDD/SSD or CFast Card

Step 1 Turn off the system, and unplug the power cord. Locate thumb screw at the front side, unlock and loosen screws.



Step 2 Assemble the HDD/SSD bracket together with the SATA HDD/SSD

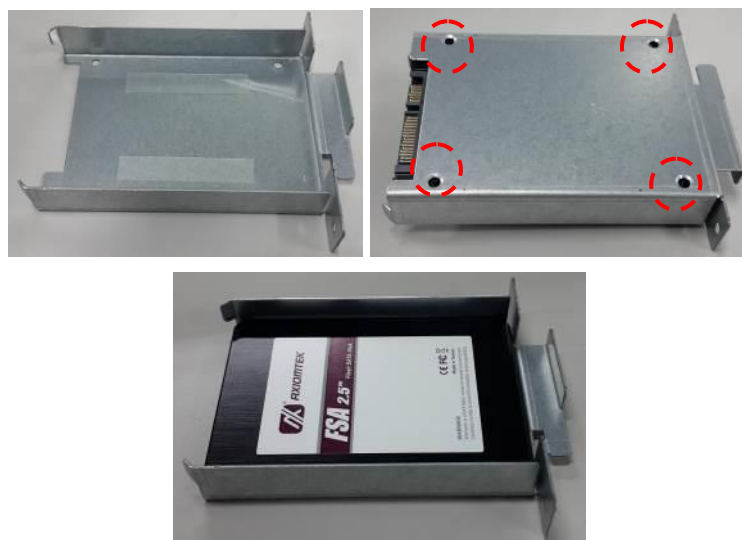

Step 3 Slide CFast card into slot cautiously.



Step 4 Fasten screws of HDD/CFast bracket

2.2 Installing the Express Mini Card and SIM card

Step 1 Turn off the system, and unplug the power cord.

Step 2 Turn the system upside down to locate screws at the bottom, loosen screws to remove the bottom cover.

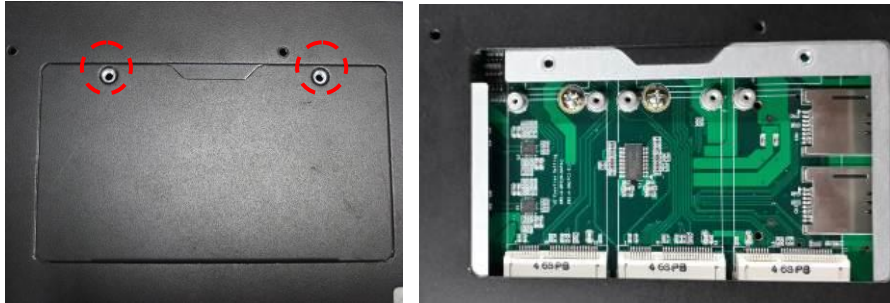

Two slot contains an internal SIM card slot which can support 3G/4G modules.

Step 3 Slide Mini card into slot cautiously.

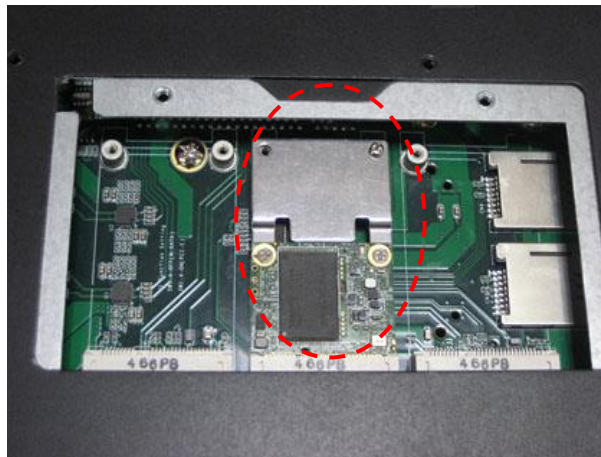

Step 4 Slide SIM card into slot cautiously.

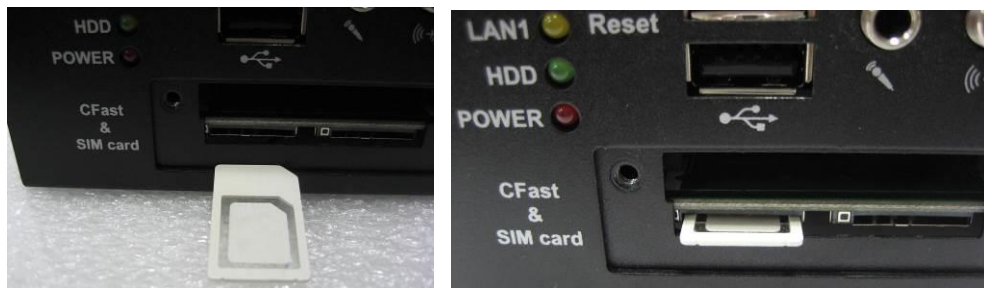

Step 5 Close the cover to the chassis, and fasten all screws.

2.3 Installing HDMI bracket

Step 1 Fasten the bracket at the position as shown.



Step 2 Connect HDMI cable and tied on bracket by cable tie as shown.



This page is intentionally left blank.

CHAPTER 3 JUMPER SETTING & CONNECTOR

3.1 mSATA/CFast Setting

- Step 1** Turn off the system, and unplug the power cord.
- Step 2** Turn the system upside down to locate screws at the bottom, loosen screws to remove the bottom cover.
- Step 3** Find the switch next to the PCIe slot.

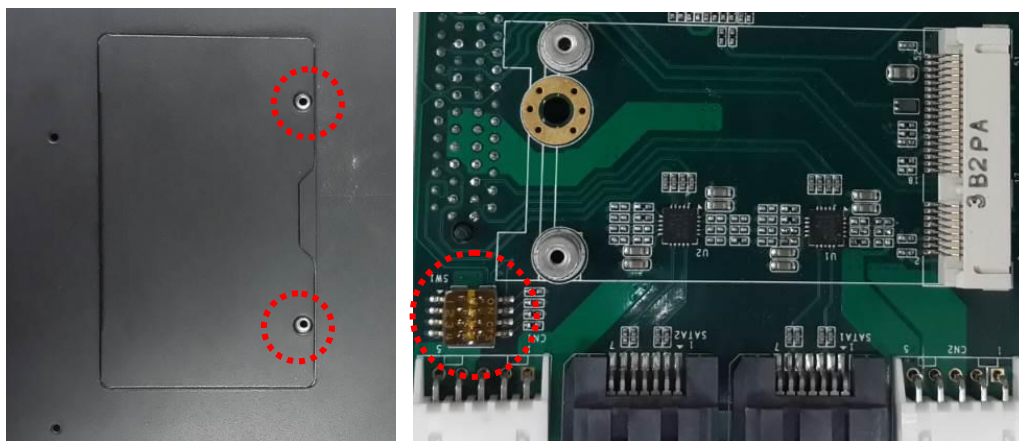

- Step 4** Change dip switch SW1 on AX93708 to select either mSATA(Only for Location J1) or CFast.

SW1 setting	Function
SW1-4 OFF (marked 1234)	mSATA(Only for Location J1)
SW1-4 ON (marked ON)	CFast+Mini Card(USB+PCIe) (Default)

3.2 Connectors

Connectors connect the CPU card with other parts of the system. Loose or improper connection might cause problems. Make sure all connectors are properly and firmly connected.

3.2.1 VGA Connector

DB15 connector is commonly used for the CRT monitor.

Pin	Signal	Pin	Signal	Pin	Signal
1	Red	2	Green	3	Blue
4	N.C.	5	GND	6	GND
7	GND	8	GND	9	VCC
10	GND	11	N.C.	12	DDC DATA
13	Horizontal Sync	14	Vertical Sync	15	DDC CLK



3.2.2 Remote switch Connector

Remote switch is ideal for a remote button which can act as an ATX power on/off button.

Pin	Signal	Description
1	NC	
2	Switch Signal	Low Active. Act as PC's ATX switch when external switch installed (Pin 3 Active) **Internal pull up resistor did not connect to any power source
3	Ext. SW Sensor	Low Active. To detect external power switch install or not. ** Internal pull up resistor did not connect to any power source
4	GND	

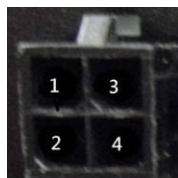

3.3.3 Serial Port Connector

The COM1~COM4 Port connector is a terminal block. The pin assignment of RS-232(4pin)/422/RS-485 is listed on the following table. If you need COM port to support RS-232(4pin)/422 or RS-485, please selection to the BIOS items.

RS-232

Pin	Signal	Pin	Signal
1	ISO_GND	6	ISO_GND
2	RTS	7	RTS
3	TXD	8	TXD
4	CTS	9	CTS
5	RXD	10	RXD

RS-422

Pin	Signal	Pin	Signal
1	ISO_GND	6	ISO_GND
2	RX-	7	RX-
3	RX+	8	RX+
4	TX-	9	TX-
5	TX+	10	TX+

RS-485

Pin	Signal	Pin	Signal
1	ISO_GND	6	ISO_GND
2		7	
3		8	
4	Data-	9	Data-
5	Data+	10	Data+

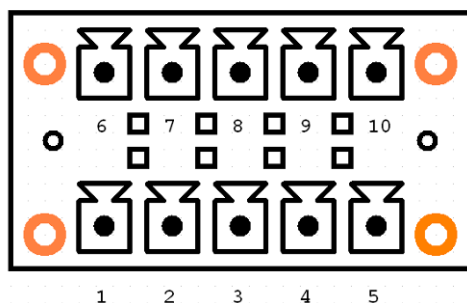

3.3.4 USB2.0 Stack Ports

Pin	Signal USB Port 0	Pin	Signal USB Port 6
1	USB VCC (+5V level)	5	USB VCC (+5V level)
2	USB #0_D-	6	USB #6_D-
3	USB #0_D+	7	USB #6_D+
4	Ground (GND)	8	Ground (GND)

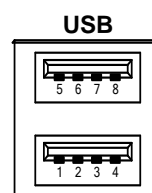

3.3.5 LED Indicators

LED Indicator	Function
Yellow(Top)	LAN 2 active
Yellow	LAN 1 active
Green	SATA HDD active
Red	Power

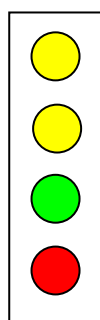

3.3.6 DC Power Input connector

The DC power input connector is M12 A-code Male 5Pin connector

Pin	Signal
1	VCC
2	VCC
3	System GND
4	System GND
5	Chassis GND

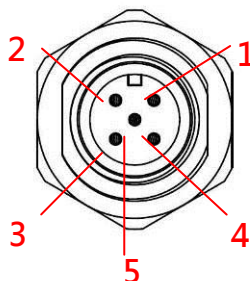

3.3.7 M12 LAN Connector (LAN1,2)

The M12-8pin LAN Connector is A-Code type which can support 10/100/1000Mbps

Pin	10/100 Mbps	1000 Mbps
1	--	MDI 2+
2	--	MDI 3+
3	--	MDI 3-
4	TX -	MDI 0-
5	RX +	MDI 1+
6	TX +	MDI 0+
7	--	MDI 2 -
8	RX -	MDI 1 -

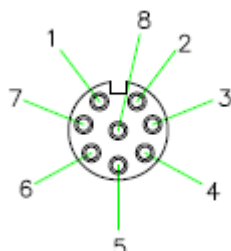

M12-A Code 8Pin/ Female

NOTE: The M12-8pin type LAN connector pin define may difference with other device.

3.3.8 Digital I/O Connector

The tBOX323-835-FL support an isolated 6-in/2-out Digital I/O (DIO)

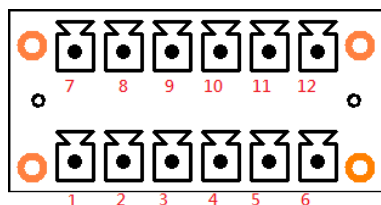

Pin	Signal	Pin	Signal
1	XOUTCOM+	7	XIN0
2	XOUT0	8	XIN1
3	XOUT1	9	XIN2
4	XOUTCOM-	10	XIN3
5	DIO_GND	11	XIN4
6	EXT_POWER	12	XIN5-

NOTE: Please refer to Appendix B for more information about Digital I/O

3.3.9 SIM Card Connector

The SIM Card slot is a ISO 7816 standard 6-pin connector for PCI Express Mini Card used.

Pin	Signal
C1	SIM_PWR
C2	SIM_RESET
C3	SIM_CLK
C5	GND
C6	SIM_VPP
C7	SIM_DATA

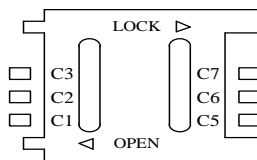

3.3.10 PCI-Express Mini Card Connector

The PCI Express Mini Card connector supports for a PCI Express x1 link and a USB 2.0 link. A PCI Express Mini Card can be applied to either PCI Express or USB 2.0. The USB 2.0 support will be helpful during the transition to PCI Express, because peripheral vendors will need time to design their chipsets to have the PCI Express function. During the transition, PCI Express Mini Cards can be quickly implemented by using USB 2.0.

Pin	Signal	Pin	Signal
1	WAKE#	2	+3.3VSB
3	No use	4	GND
5	No use	6	+1.5V
7	CLKREQ#	8	No use
9	GND	10	No use
11	REFCLK-	12	No use
13	REFCLK+	14	No use
15	GND	16	No use
17	No use	18	GND
19	No use	20	+3.3VSB
21	GND	22	PERST#
23	PE_RXN4	24	+3.3VSB
25	PE_RXP4	26	GND
27	GND	28	+1.5V
29	GND	30	SMB_CLK
31	PE_TXN4	32	SMB_DATA
33	PE_TXP4	34	GND
35	GND	36	USB_D3-
37	GND	38	USB_D3+
39	+3.3VSB	40	GND
41	+3.3VSB	42	LED_WWAN#
43	GND	44	LED_WLAN#
45	No use	46	LED_WPAN#
47	No use	48	+1.5V
49	No use	50	GND
51	No use	52	+3.3VSB

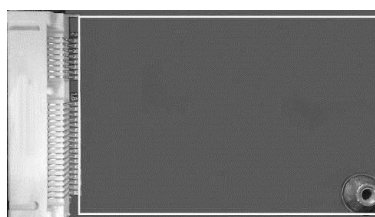
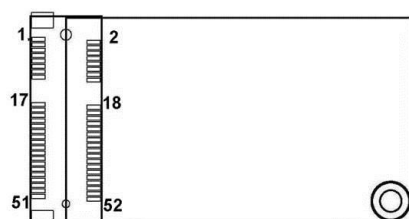

A PCI Express Mini Card can be applied to either PCI Express or USB 2.0. The USB 2.0 support will be helpful during the transition to PCI Express, because peripheral vendors will need time to design their chipsets to have the PCI Express function. During the transition, PCI Express Mini Cards can be quickly implemented by using USB 2.0.

3.3.11 CFast™ Socket

The tBOX323-835-FL is equipped with a CFast™ socket on the solder side to support an SATA interface CFast™ disk card with DMA mode supported. The socket is especially designed to avoid incorrect installation of the CFast™ disk card. When installing or removing the CFast™ disk card, please make sure the system power is off.

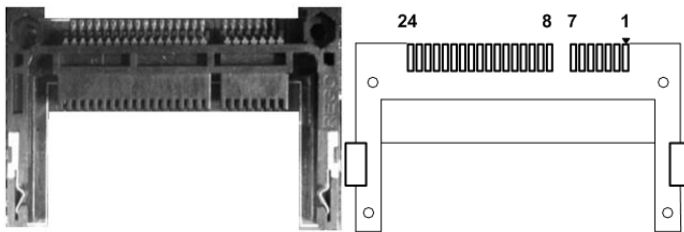

Pin	Description	Pin	Description
1	GND	13	N.C
2	SATA_TX+	14	GND
3	SATA_TX-	15	N.C
4	GND	16	CFAST_LED#
5	SATA_RX-	17	N.C
6	SATA_RX+	18	N.C
7	GND	19	N.C
8	N.C	20	+3.3V Level
9	GND	21	+3.3V Level
10	N.C	22	GND
11	N.C	23	GND
12	N.C	24	N.C

3.2.12 Serial Port Connector

The COM port connector is a terminal block. The pin assignment of RS-232 is listed on the following table.

Pin	RS-232
1	DCD, Data carrier detect
2	RXD, Receive data
3	TXD, Transmit data
4	DTR, Data terminal ready
5	GND, ground
6	DSR, Data set ready
7	RTS, Request to send
8	CTS, Clear to send
9	RI, Ring indicator

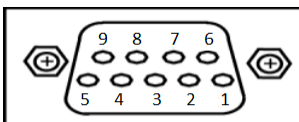

3.2.13 HDD tray locker

Lock and secure the swappable HDD/SSD bay.

Stauts	Diagram
Unlocked	
Locked	

3.2.14 HDMI Connector

HDMI connector is commonly used for the display.

Pin	Description	Pin	Description
1	TMDS data 2+	11	TMDS clock shield
2	TMDS data 2 shield	12	TMDS clock-
3	TMDS data 2-	13	CEC
4	TMDS data 1+	14	No connected
5	TMDS data 1 shield	15	DDC clock
6	TMDS data 1-	16	DDC data
7	TMDS data 0+	17	Ground
8	TMDS data 0 shield	18	+5V power
9	TMDS data 0-	19	Hot plug detect
10	TMDS clock+		

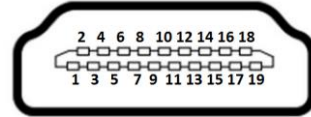

3.2.15 Fuse

Instant fuse repair designed.

- Specification: current rating: 15A, voltage rating: 125V
- FRU part number: 30092151000E

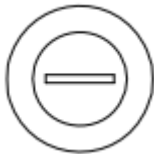

3.2.16 Antenna opening

Profile opening is reserved for Wi-Fi/3G/4G antennas.



CHAPTER 4 AMI BIOS SETUP UTILITY

This chapter provides users with detailed description about how to set up basic system configuration through the AMI BIOS setup utility.

4.1 Starting

To enter the setup screens, follow the steps below:

1. Turn on the computer and press the key immediately.
2. After pressing the <Delete> key, the main BIOS setup menu displays. You can access to other setup screens from the main BIOS setup menu, such as the Chipset and Power menus.

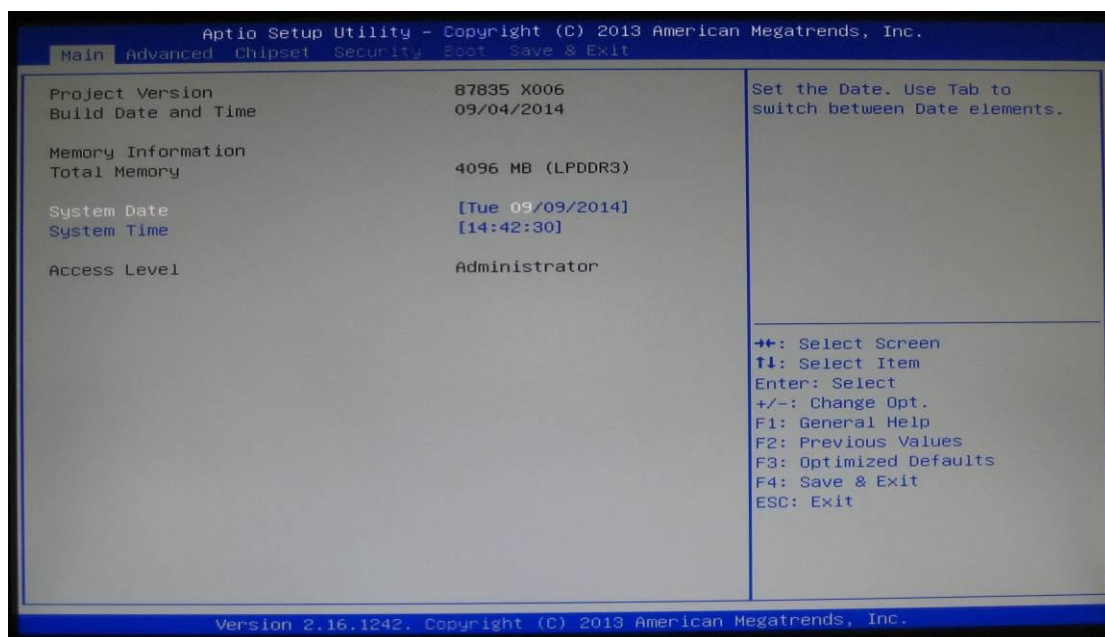

4.2 Navigation Keys

The BIOS setup/utility uses a key-based navigation system called hot keys. Most of the BIOS setup utility hot keys can be used at any time during the setup navigation process. These keys include <F1>, <F10>, <Enter>, <ESC>, <Arrow> keys, and so on.



NOTE: Some of navigation keys differ from one screen to another.

Hot Keys	Description
← Left/Right	The Left and Right <Arrow> keys allow you to select a setup screen.
↑↓ Up/Down	The Up and Down <Arrow> keys allow you to select a setup screen or sub-screen.
+– Plus/Minus	The Plus and Minus <Arrow> keys allow you to change the field value of a particular setup item.
Tab	The <Tab> key allows you to select setup fields.
F1	The <F1> key allows you to display the General Help screen.
F10	The <F10> key allows you to save any changes you have made and exit Setup. Press the <F10> key to save your changes.
Esc	The <Esc> key allows you to discard any changes you have made and exit the Setup. Press the <Esc> key to exit the setup without saving your changes.
Enter	The <Enter> key allows you to display or change the setup option listed for a particular setup item. The <Enter> key can also allow you to display the setup sub- screens.

4.3 Main Menu

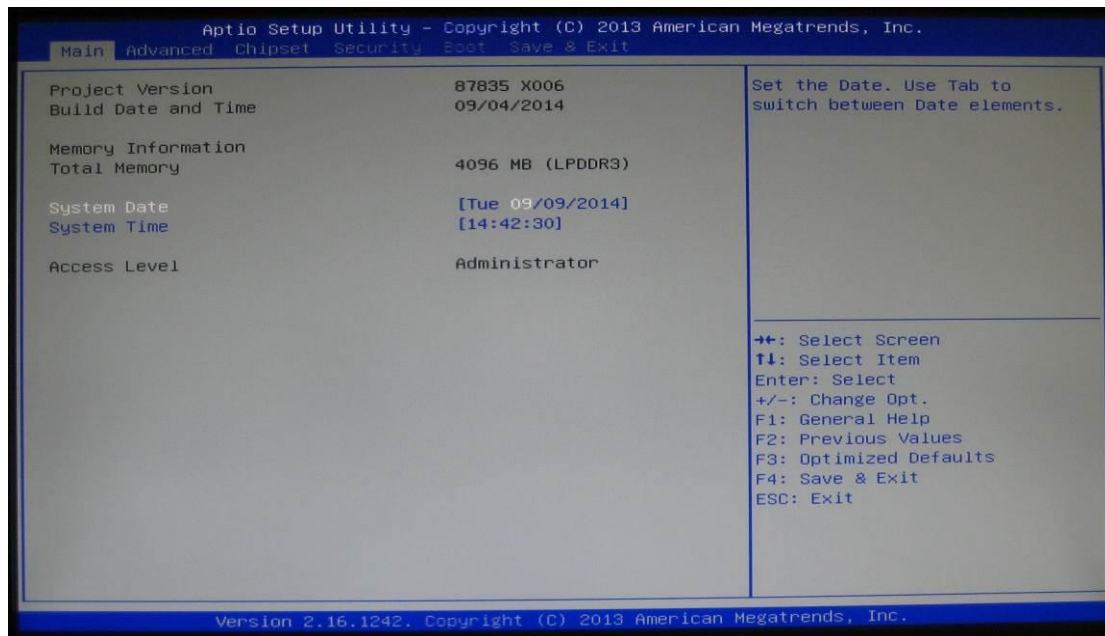

➤ System Time/Date

Use this option to change the system time and date. Highlight System Time or System Date using the <Arrow> keys. Enter new values through the keyboard. Press the <Tab> key or the <Arrow> keys to move between fields. The date must be entered in MM/DD/YY format. The time is entered in HH:MM:SS format.

4.4 Advanced Menu

The Advanced menu allows users to set configuration of the CPU and other system devices. You can select any of the items in the left frame of the screen to go to the sub menus:

- ▶ ACPI Settings
- ▶ NCT6106D Super IO Configuration
- ▶ NCT6106D H/W Monitor
- ▶ Serial Port Console Redirection
- ▶ CPU Configuration
- ▶ IDE Configuration

For items marked with “▶”, please press <Enter> for more options.

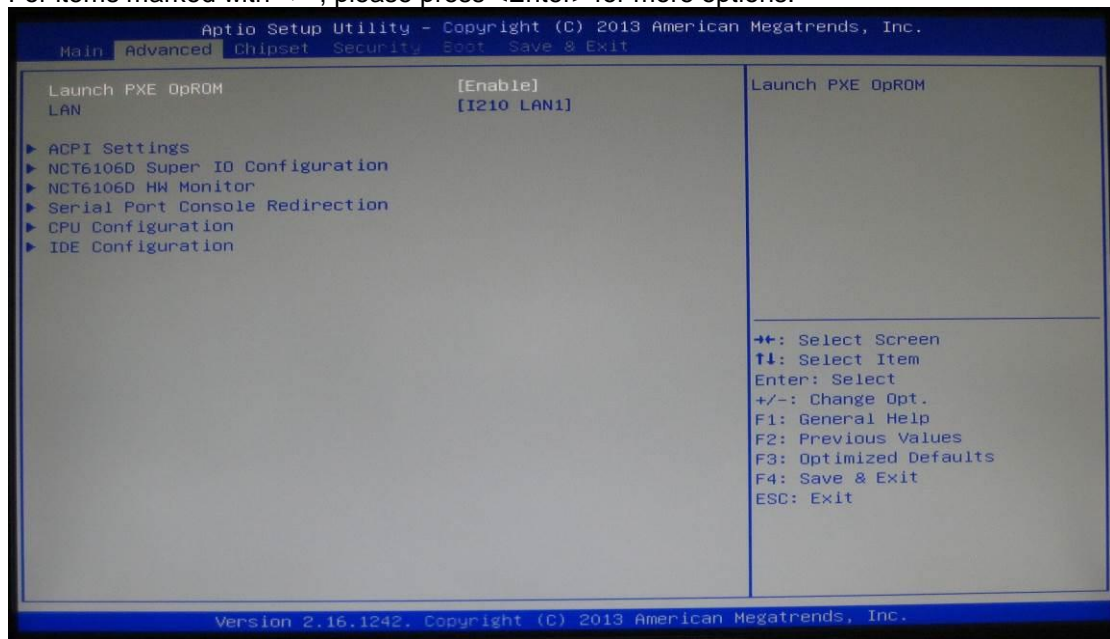

ACPI Settings

You can use this screen to select options for the ACPI Configuration, and change the value of the selected option. A description of the selected item appears on the right side of the screen.

➤ ACPI Sleep State

Allow you to select the Advanced Configuration and Power Interface (ACPI) state to be used for system suspend. Here are the options for your selection, S1 (CPU Stop Clock) and S3 (Suspend to RAM).

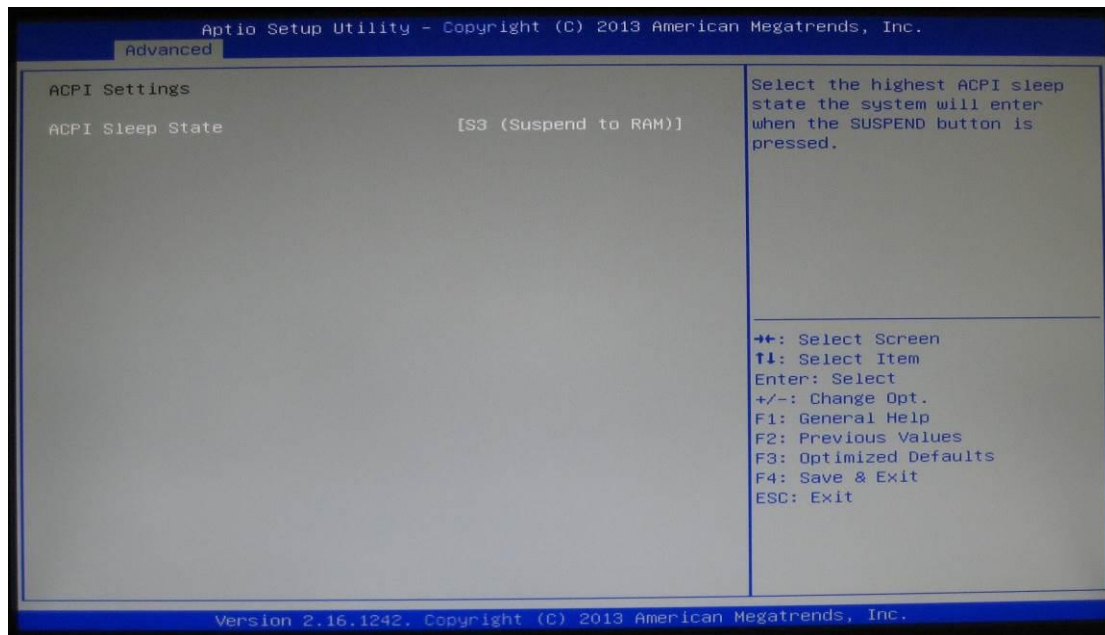

NCT6106D Super IO Configuration

Use this screen to select options for the Super IO Configuration, and change the value of the selected option

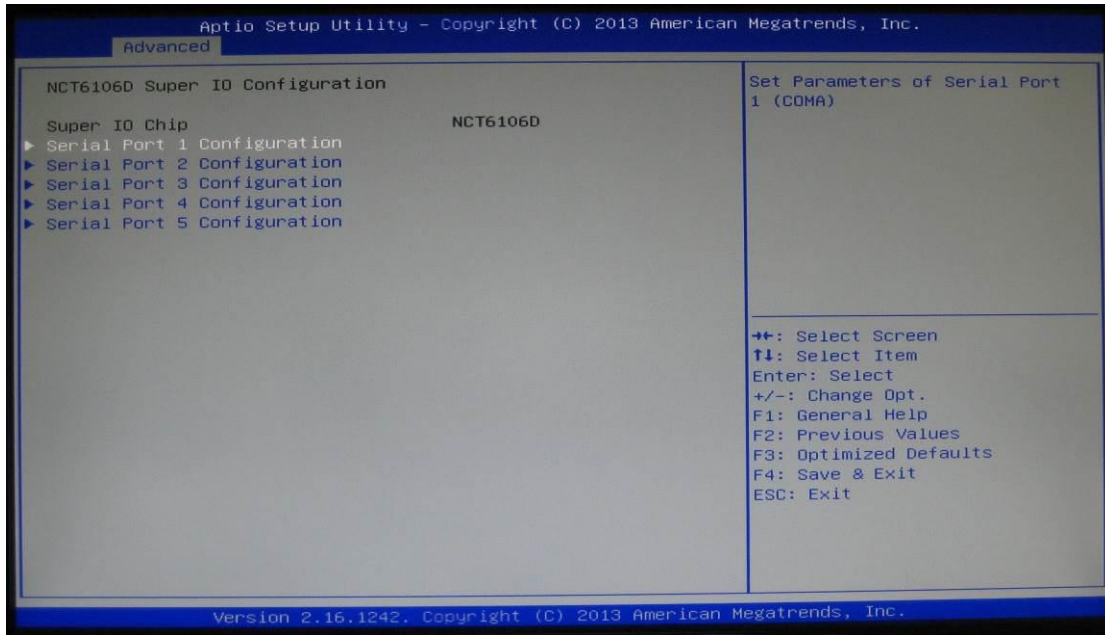

Serial Port 1-4 configuration

1. Serial port:

This option used to enable or disable the serial port.

2. Device Setting:

This item specifies the base I/O port address and Interrupt Request address of serial port.

3. Select mode:

This option used to select RS-232(4pin)/422/485 function.

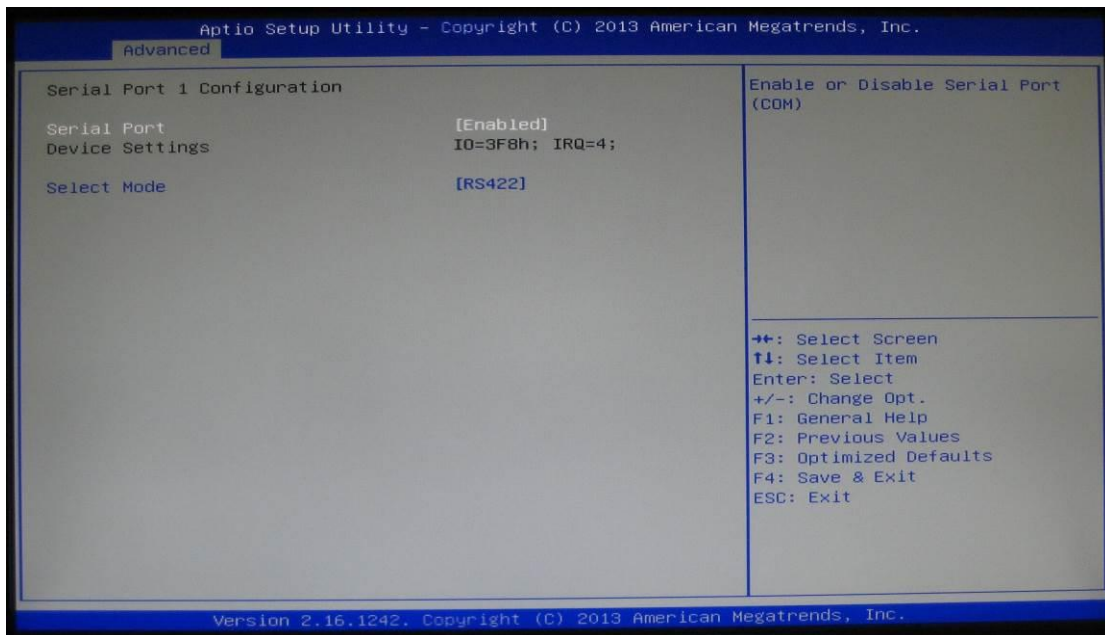

Serial Port 5 configuration

This option used to enable or disable the console redirection.

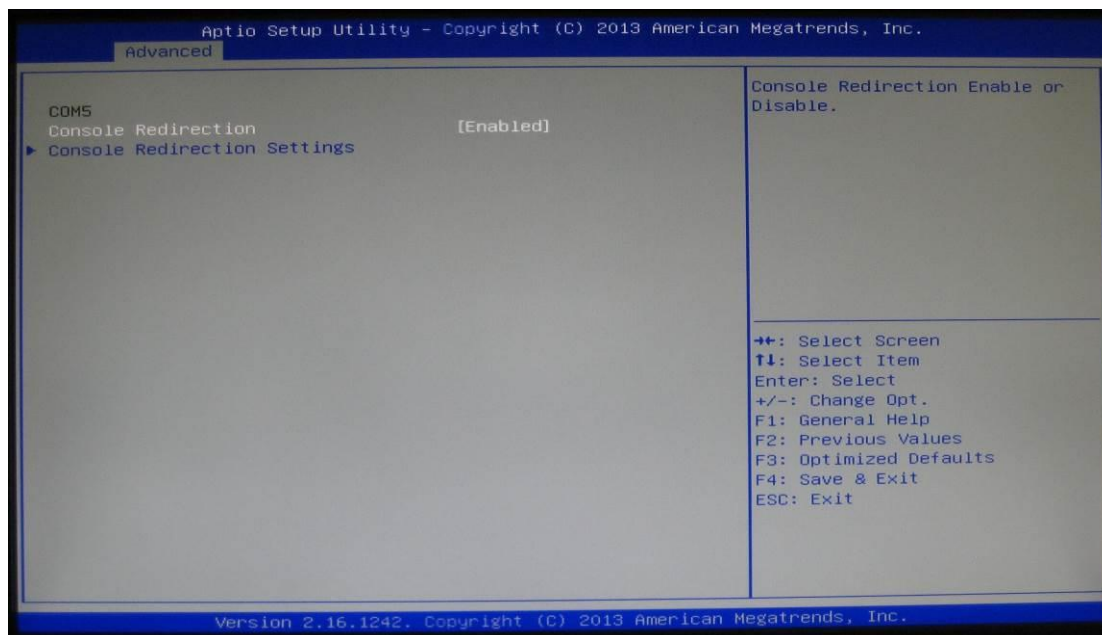

Serial Port Console Redirection

This option used to setting the console redirection

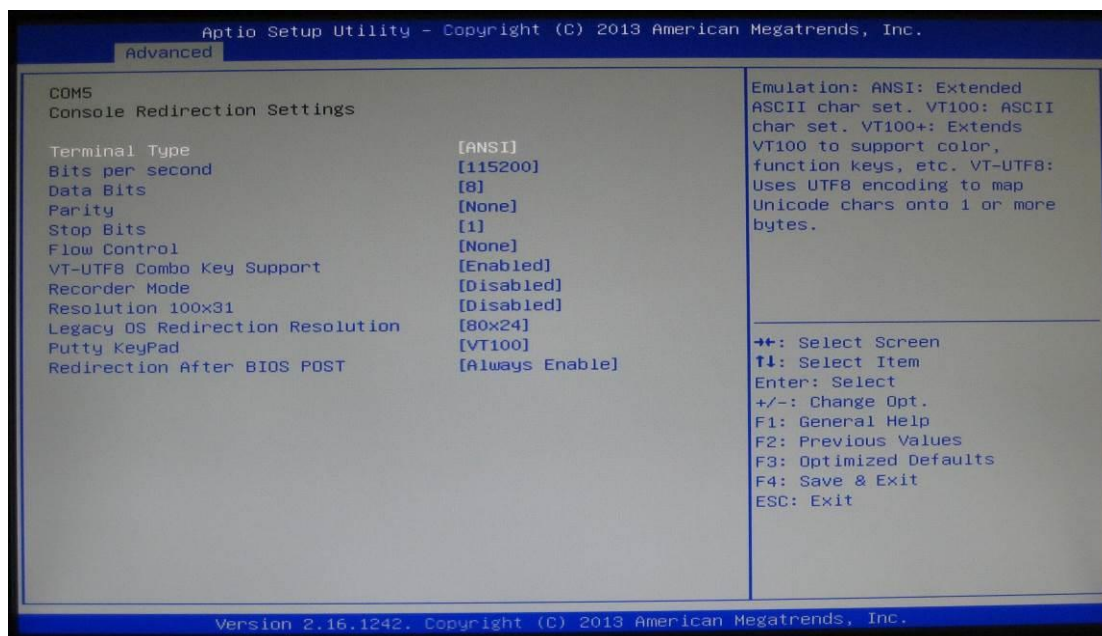

NCT6106D H/W Monitor

This screen shows the Hardware Health Configuration.

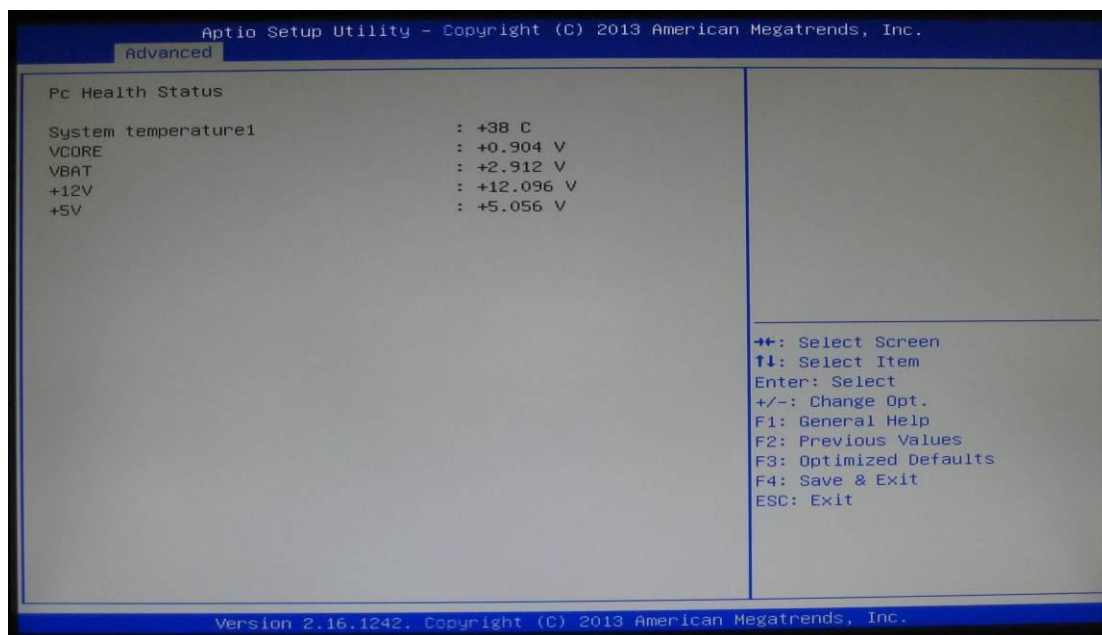

CPU Configuration

This screen shows the CPU Configuration.

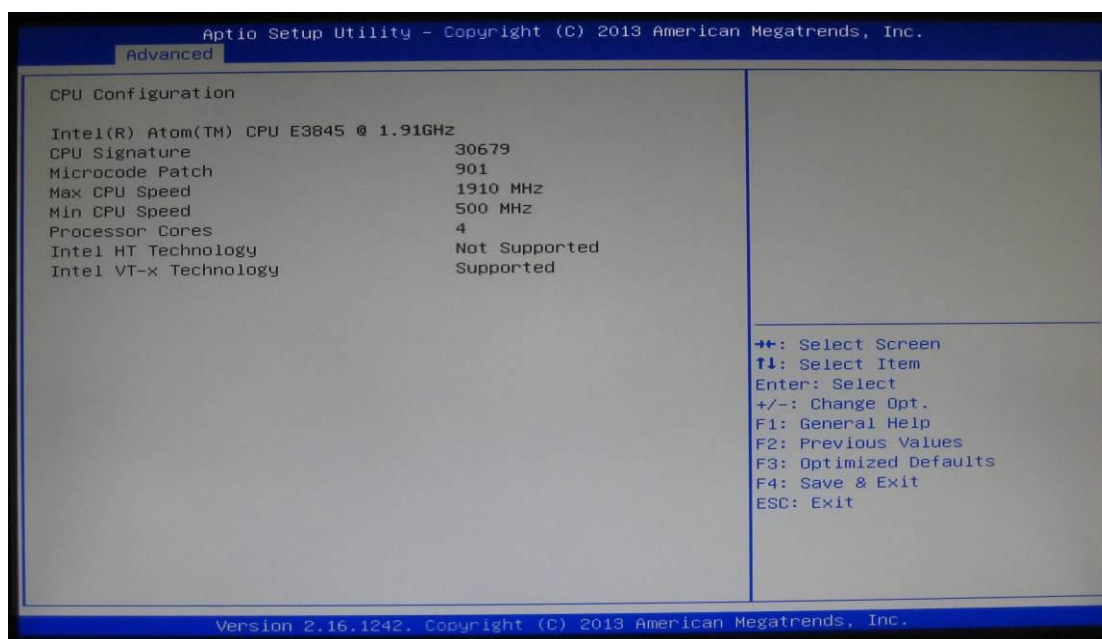

IDE Configuration

You can use this screen to select options for the SATA Configuration, and change the value of the selected option.

➤ SATA Mode

Use this item to choose the SATA operation mode. Here are the options for your selection, IDE Mode, AHCI Mode.

➤ Serial-ATA Port 0-1

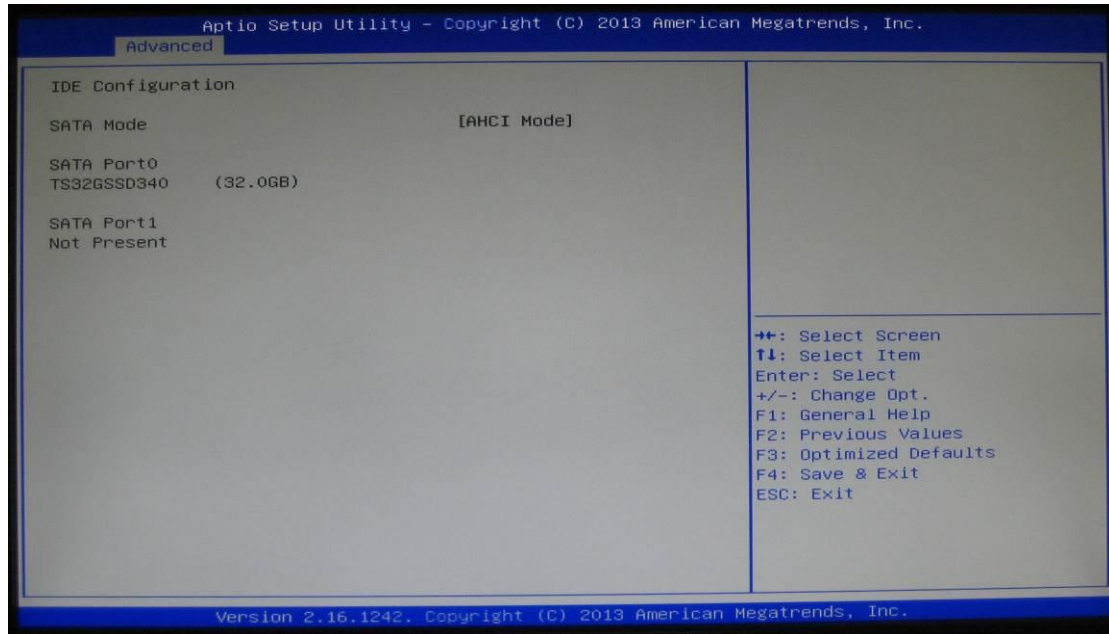

4.5 Chipset Menu

The Chipset menu allows users to change the advanced chipset settings.

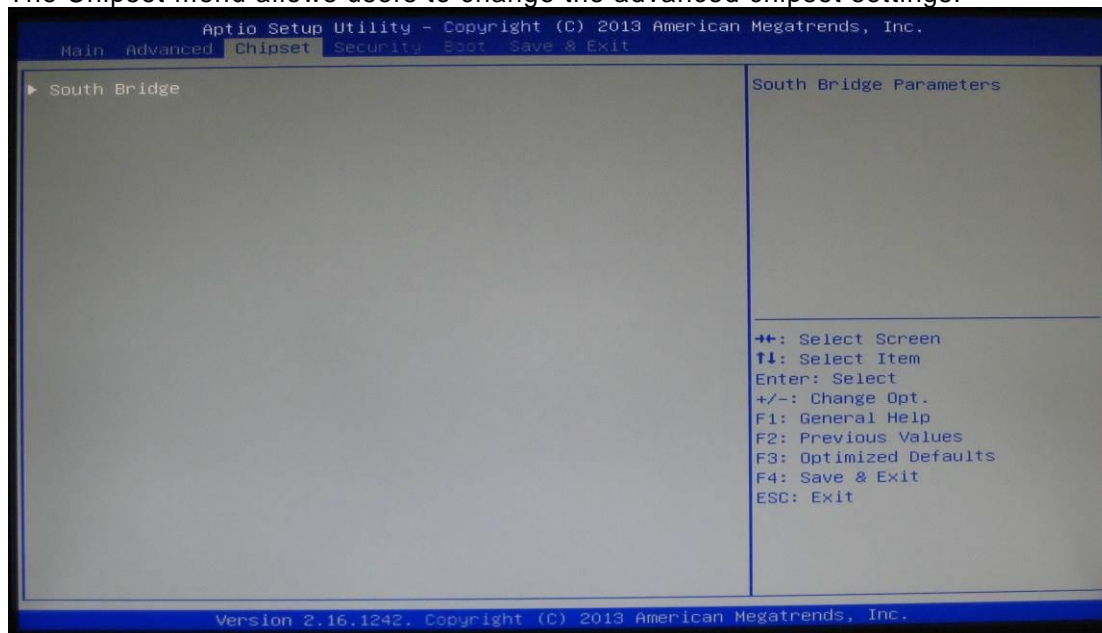

➤ USB Configuration

This screen shows the Chipset Configuration

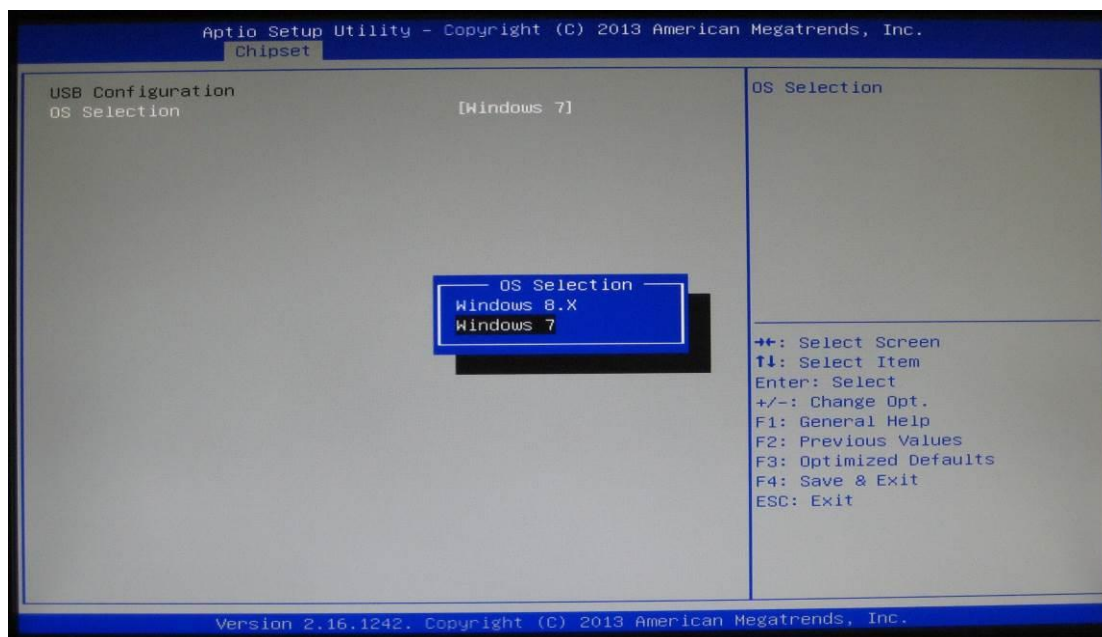

4.6 Boot Menu

The Boot menu allows users to change boot options of the system. You can select any of the items in the left frame of the screen to go to the sub menus:

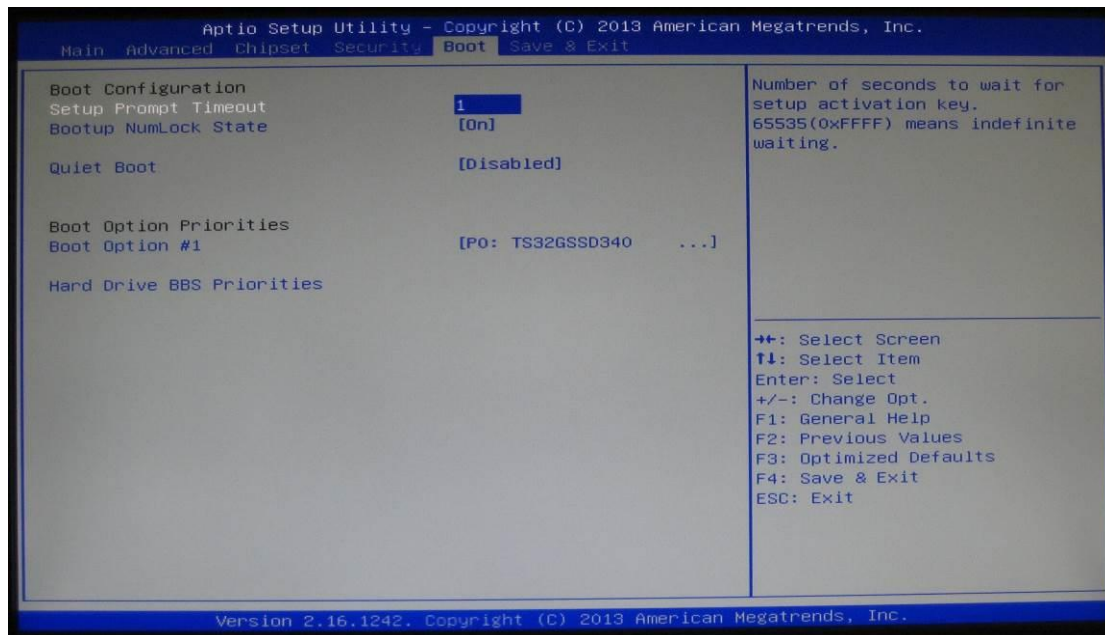

➤ Setup Prompt Timeout

Set the Timeout for wait press key to enter Setup Menu

➤ Bootup NumLock State

Use this item to select the power-on state for the NumLock. The default setting is on.

➤ Quiet Boot

Use this item to enable or disable the Quite Boot state. The default setting is disabling.

➤ Boot Option Priorities

Specifies the overall boot order from the available devices.

4.7 Security Menu

The Security menu allows users to change the security settings for the system.

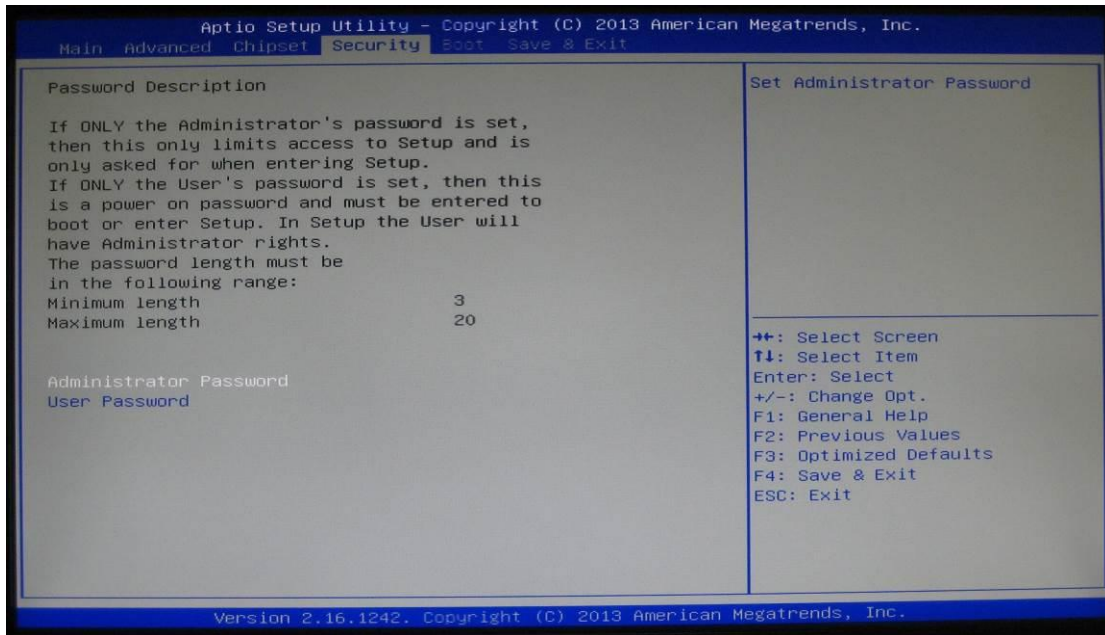

➤ Administrator Password

This item indicates whether a supervisor password has been set. If the password has been installed, 『Installed』 displays. If not, 『Not Installed』 displays.

➤ User Password

This item indicates whether a user password has been set. If the password has been installed, 『Installed』 displays. If not, 『Not Installed』 displays.

4.8 Save & Exit Menu

The Exit menu allows users to load the system configuration with optimal or failsafe default values.

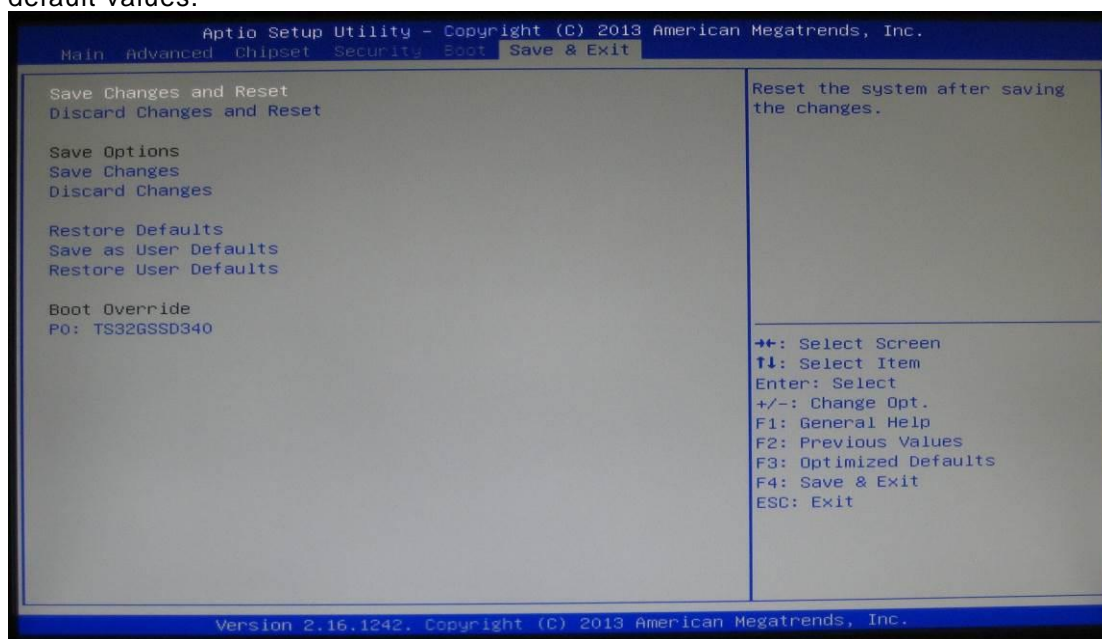

➤ Save Changes and Reset

When you have completed the system configuration changes, select this option to leave Setup and reboot the computer so the new system configuration parameters can take effect. Select *Save Changes and Exit* from the Exit menu and press <Enter>. Select Ok to save changes and exit.

➤ Discard Changes and Reset

Select this option to quit Setup without making any permanent changes to the system configuration. Select *Discard Changes and Exit* from the Exit menu and press <Enter>. Select Ok to discard changes and exit.

➤ Discard Changes

Use this item to abandon all changes.

➤ Restore Defaults

It automatically sets all Setup options to a complete set of default settings when you select this option. The Optimal settings are designed for maximum system performance, but may not work best for all computer applications. In particular, do not use the Optimal Setup options if your computer is experiencing system configuration problems. Select Load Optimal Defaults from the Exit menu and press <Enter>.

➤ Restore user Defaults

It automatically sets all Setup options to a complete set of default settings when you select this option. The Fail-Safe settings are designed for maximum system stability, but not maximum performance. Select the Fail-Safe Setup options if your computer is experiencing system configuration problems.

Select Load Fail-Safe Defaults from the Exit menu and press <Enter>. Select Ok to load Fail-Safe defaults.

This page is intentionally left blank.

APPENDIX A WATCHDOG TIMER

What is Watchdog Timer

The integrated Watchdog Timer can be set up by programming. There are 1~255 levels available. As long as the value of timer is set, after enabling, the countdown of the value is starting. It needs to reset or disable watchdog, otherwise auto-reset will be running when the value is counted to 0.

How to Use the Watchdog Timer

(Following is example to enable configuration by using debug tool)

Enable WDT

1.Enable configuration

-O 2E 87

-O 2E 87

2. Select Logic device:

-O 2E 07

-O 2F 08

3. WDT Device Enable

-O 2E 30

-O 2F 01

5. Set timer unit

-O 2E F0

-O 2F 00 → (00: Sec; 08: Minute)

4. Set base timer:

-O 2E F1

-O 2F 0A → Set Reset Time (Ex.0A:10 Sec)

Disable WDT

1.Enable configuration

-O 2E 87

-O 2E 87

2. Select Logic device:

-O 2E 07

-O 2F 08

3. WDT Device Disable

-O 2E 30

-O 2F 00

Sample of Watchdog application

Assume there is program A which needs to maintain running in a system. The value of Watchdog Timer must be set bigger than the running time of program A. Then, after the running time of program A is finished, either to disable or to reset watchdog timer.

When program A has problems to make system shut down, the system can be rebooted by Watchdog timer when the value of watchdog timer is countdowned to 0.

The below flowchart can be referred to edit program A

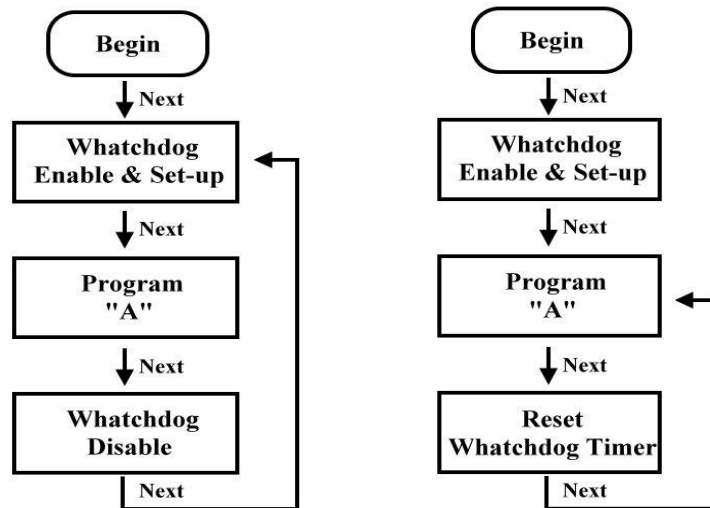

APPENDIX B DIGITAL I/O

Digital I/O Specification

Digital Input:

Input channels: 6, sink/source type

Input voltage: 0 to 30VDC at 25Hz

Input level for dry contacts:

Logic level 0: close to ground

Logic level 1: open

Input level for wet contacts:

Logic level 1: +/-3VDC max.

Logic level 0: +/- 10VDC min. to +/-30VDC max. (source to digital input)

Digital output:

output channels: 2, sink type

output current: 200mA max. per channel

on-state voltage: 12~ 24VDC nominal

max. voltage on COM+: 30VDC

Digital I/O Software Programming

- I2C to GPIO PCA9554PW GPIO [1:0] is Output; GPIO [7:2] is Int.
- I2C address: 0b0100100x.
- Registers:

Register 0: Input port register.

Table 4. Register 0 - Input Port register bit description

Bit	Symbol	Access	Value	Description
7	I7	read only	X	determined by externally applied logic level
6	I6	read only	X	
5	I5	read only	X	
4	I4	read only	X	
3	I3	read only	X	
2	I2	read only	X	
1	I1	read only	X	
0	I0	read only	X	

Register 1: Output port register.

Table 5. Register 1 - Output Port register bit description

Legend: * default value.

Bit	Symbol	Access	Value	Description
7	O7	R	1*	reflects outgoing logic levels of pins defined as outputs by Register 3
6	O6	R	1*	
5	O5	R	1*	
4	O4	R	1*	
3	O3	R	1*	
2	O2	R	1*	
1	O1	R	1*	
0	O0	R	1*	

Digital Input Wiring

Dry Contact

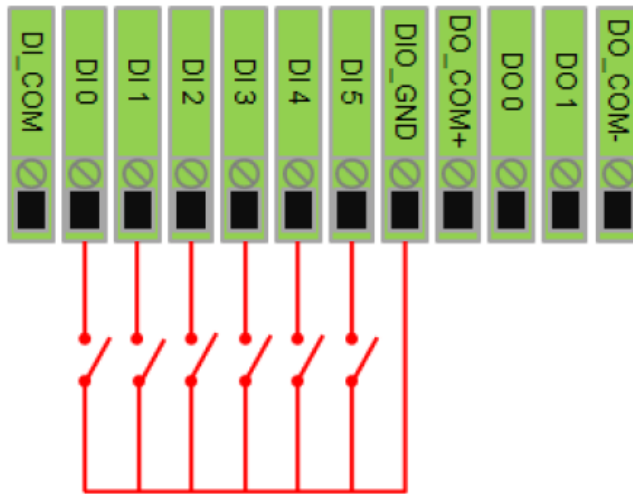

Wet Contact

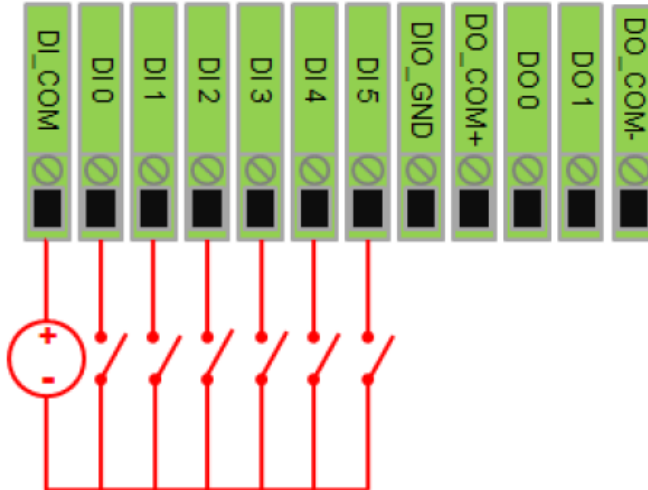

Digital Output Wiring

