

SOM200SX-PC Development Kit

With 5S / 4USB/ LAN / 2GPIO

128MB DDR2 Onboard

User's Manual

(Revision 1.0A)

● Copyright

The information in this manual is subject to change without notice for continuous improvement of the product. All rights are reserved. The manufacturer assumes no responsibility for any inaccuracy that may be contained in this document and makes no commitment to update or to keep current information contained in this manual.

No part of this manual may be reproduced, copied, translated or transmitted, in whole or in part, in any form or by any means without the prior written permission of the ICOP Technology Inc.

©Copyright 2008 ICOP Technology Inc.

Manual No. IUMSOM200SX-PC000-01 Ver.1.0A ● October, 2012

● Trademarks Acknowledgment

Vortex86SX™ is the registered trademark of DMP Electronics Inc.

Other brand names or product names appearing in this document are the properties and registered trademarks of their respective owners. All names mentioned herewith are reserved for identification purpose only.

Table of Contents

Table of Contents	iii
Chapter 1 Introduction.....	1
1.1 Packing List.....	1
1.2 Product Description	2
1.3 Specifications	3
1.4 Board Dimension.....	5
Chapter 2 Installation.....	8
2.1 Board Outline	8
2.2 Connectors & Jumpers Location	11
2.3 Connectors & Jumpers Summary.....	12
2.4 Pin Assignments & Jumper Settings.....	13
2.5 System Mapping.....	23
2.6 Watchdog Timer	28
2.7 GPIO	29
2.8 SPI flash.....	30
2.9 IDE to SD	31
Chapter 3 Driver Installation.....	32
Appendix	33
A. TCP/IP library for DOS real mode	33
B. SOM200SX-PC & SOMSX-DEV-PC Schematic.....	34
C. BIOS Default Setting.....	35
Warranty.....	36

This page is blank

Chapter 1

Introduction

1.1 Packing List

Product Name	Package
SOM200SX-DEV-PC	<ul style="list-style-type: none">● SOM200SX-DEV-PC x 1● HDD 40P (2.54mm) x 1● HDD 44P (2.0mm) x 1● RS232 cable (2.54mm) x 5● GPIO cable (2.54mm) x 2● USB (2.54mm) x 1

Product Name	Package
SOM200SX-PC	● SOM200SX-PC CPU Module x 1

Product Name	Package
PCI-VGA-Z9s	● XGI Z9s VGA/DVI PCI Display Board x 1

1.2 Product Description

The System on Module is a core module with the processor, memory and I/O that would contain the following benefits in the respect of system design.

- 300MHz Vortex86SX System-On-Chip
 - 128 / 256MB DDR2 system memory
 - 4 USB Ver. 2.0 (host)
 - 5 serial ports
 - 16-bit GPIO x2
 - PCI bus
 - 2 watchdog timer
 - Enhanced IDE (UltraDMA-100/66/33)
 - JTAG interface
 - AMI BIOS
 - 2MB SPI flash
 - Single voltage +5V DC
 - Support extended operating temperature range of -20°C to +70°
- SOM200SX-PC is suitable for broad range of data-acquisition, Industrial automation, Process control, Automotive controller, AVL, Intelligent Vehicle management device, Medical device, Human machine interface, Robotics and machinery control.
- SOM200SX-PC measured at only 52mm (L)*52mm (W)*10.5mm (H), is designed particularly as the kernel for the diverse expandable applications. Through 8 rows of 25pin connector, SOM200SX-PC is able to provide multiple functions, such as RS-232, IDE, LAN, USB and GPIO.
- To assist users easily adapt SOM200SX-PC Module into their applications, ICOP offers a complete development board and referential circuit diagram for SOM200SX-PC Module in order to reduce users' time.
- Please visit the website below for further information <http://www.dmp.com.tw/tech/vortex86sx/>
- As to the referential circuit drawing, please contact info@icop.com.tw

1.3 Specifications

■ SOM200SX-DEV-PC

Features	SOM200SX-DEV-PC
Bus Interface	PCI Bus standard compliant
Connectors	<ul style="list-style-type: none">● 1.27mm 50-pin header for signal x4● 2.54mm 40-pin header for IDE x1● 2.54mm 20-pin header for GPIO x2● 2.54mm 10-pin header for USB x1● 2.54mm 10-pin header for RS-232 x5● 2.0mm 44-pin header for IDE x1● 120-pin slot for PCI x2● External RJ-45 connector for Ethernet x1● External USB connector x2● External 9-pin D-Sub male connector for RS-232 x2● External 6-pin Mini DIN connector for Keyboard x1● External 6-pin Mini DIN connector for Mouse x1
Power Requirement	Single Voltage +5V @100mA
Dimension	170 X 170 mm (6.69 x 6.69 inches)
Weight	280g
Operating Temperature	-20°C ~ +70°C -40°C ~ +85°C (Optional)

■ SOM200SX-PC

Features	SOM200SX-PC
CPU	DM&P SoC CPU Vortex86SX- 300MHz Real Time Clock with Lithium Battery Backup
Cache	L1:16K I-Cache, 16K D-Cache
BIOS	AMI BIOS
Bus Interface	PCI bus standard compliant
System Memory	128 / 256MB DDR2 onboard
Watchdog Timer	Software programmable from 30.5 us to 512 seconds x2 sets(Watchdog 1 fully compatible with M6117D)
LAN	Integrated 10/100Mbps Ethernet
Flash Disk Support	Onboard 2MB SPI Flash Disk Onboard SST Flash Disk (512MB/1GB/2GB/4GB are optional) MSTI EmbedDisk Module (16MB and above)
Serial Console	Controlled by GP 36/37
I/O Interface	<ul style="list-style-type: none"> ● Enhanced IDE port x1 ● RS-232 port x5 ● USB port (Ver2.0) x4 ● 16-bit GPIO port x2 ● 10/100Mbps Ethernet port x1
Connectors	<ul style="list-style-type: none"> ● 1.27mm 50-pin box header for signal x4 ● 1.25mm 6-pin Wafer for JTAG x1
Power Requirement	Single Voltage +5V @ 340mA
Dimension	52 mm (L) x 52 mm (W) x 10.5 mm (H) (With Cover)
Weight	15g
Operating Temperature	-20°C ~ +70°C -40°C ~ +85°C (Optional)

1.4 Board Dimension

■ SOM200SX-DEV-PC

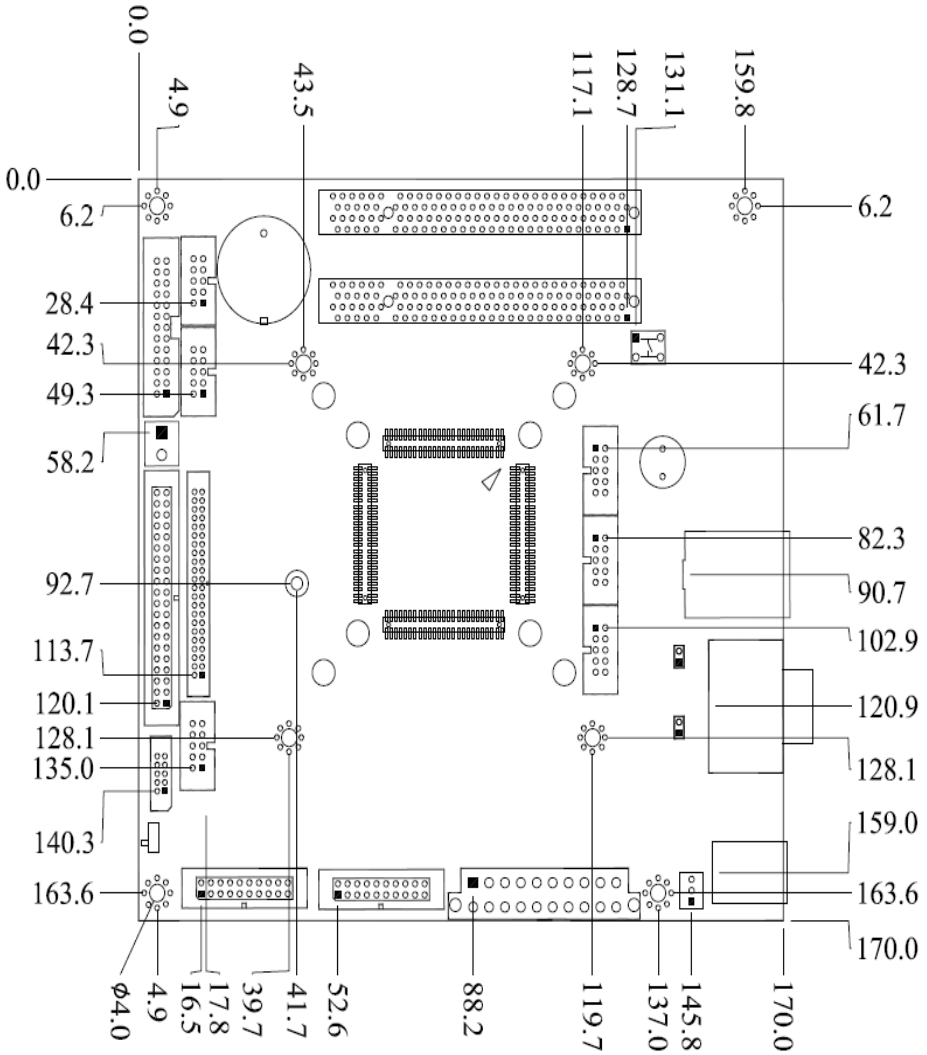

■ SOM200SX-PC

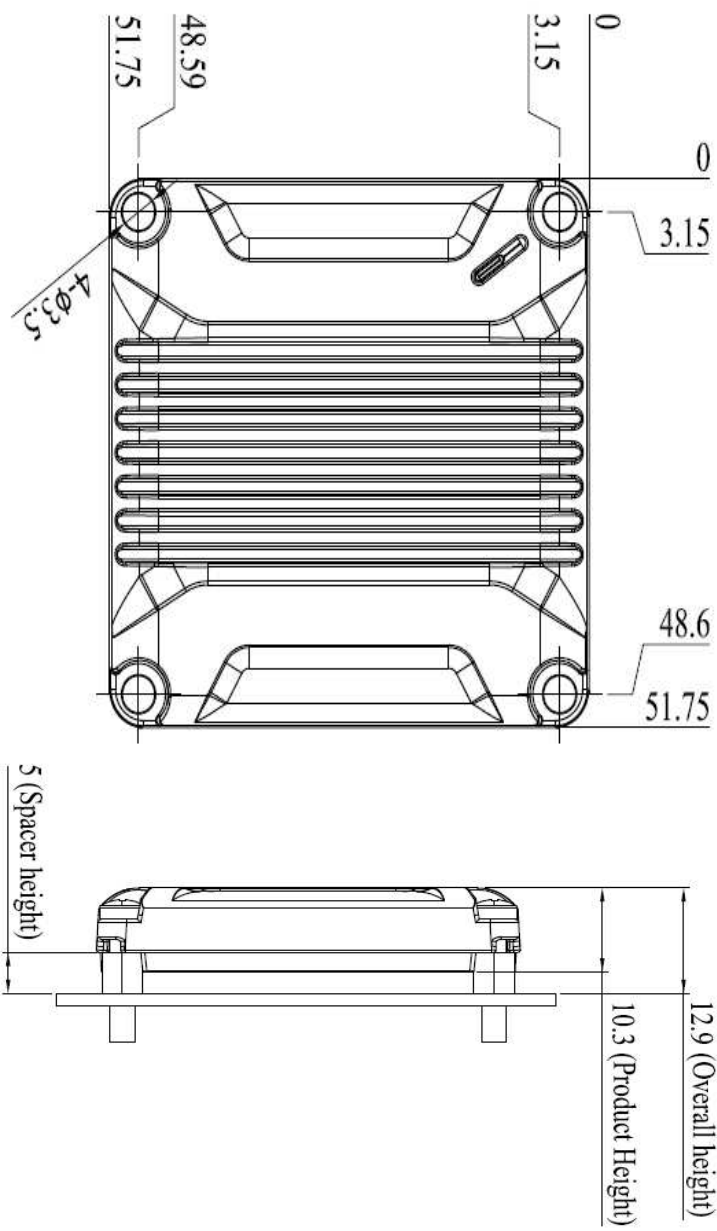

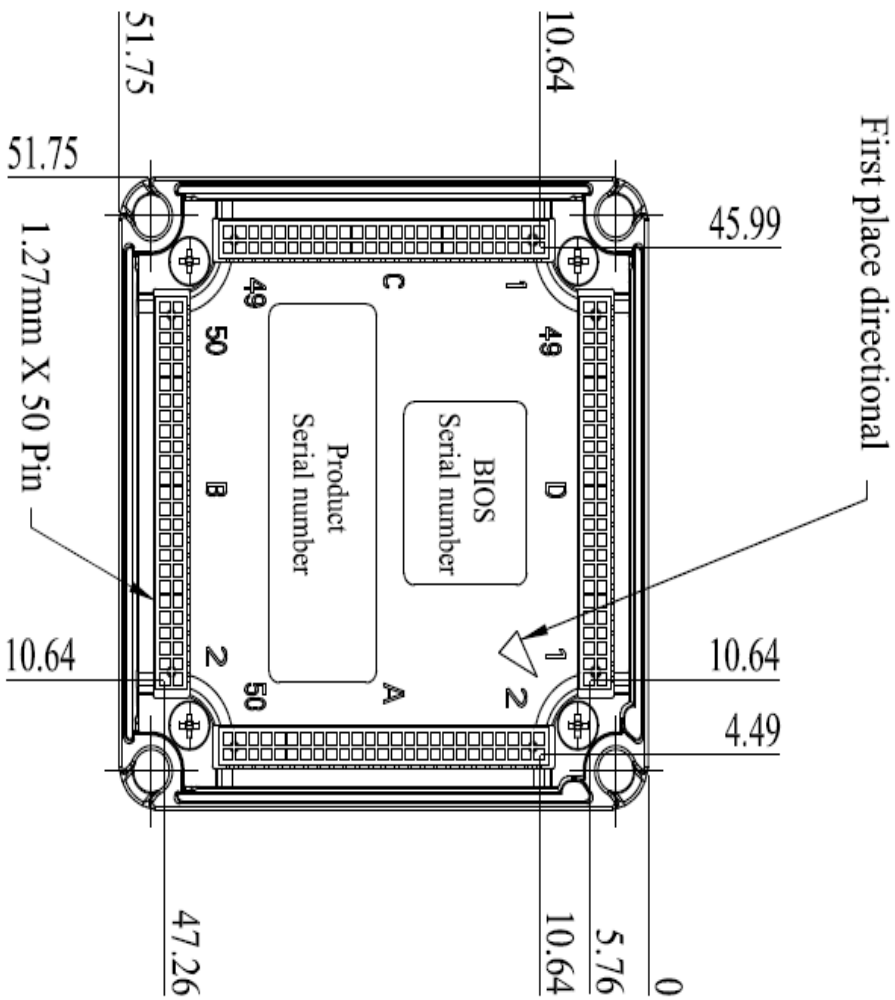

Chapter 2

Installation

2.1 Board Outline

■ SOM200SX-DEV-PC

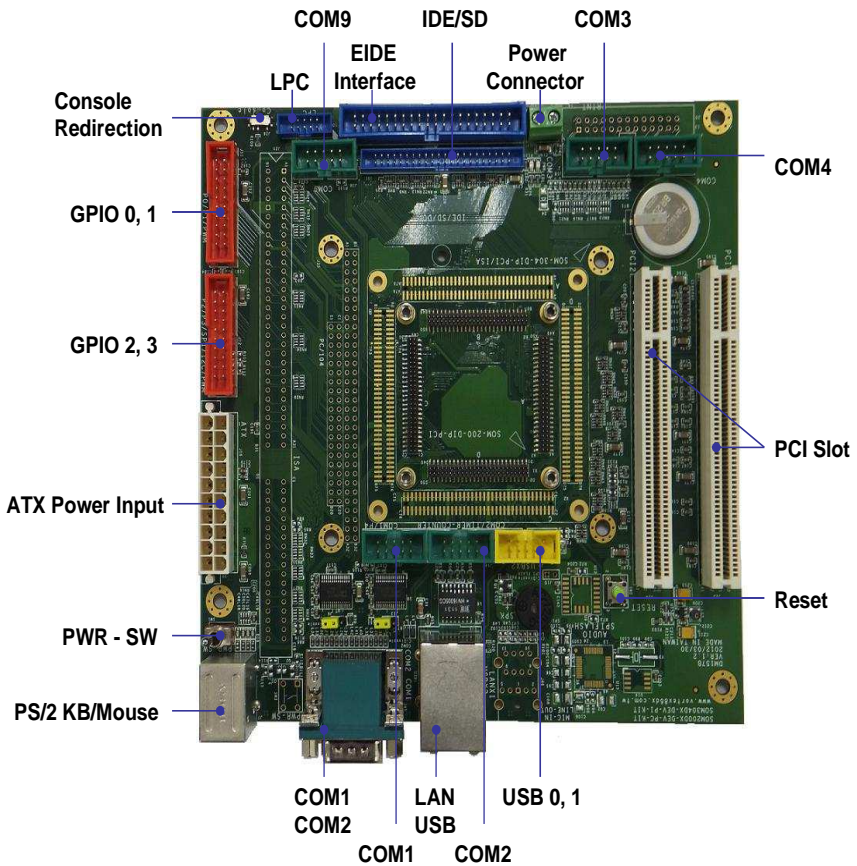

■ SOM200SX-DEV-PC with PCI-VGA-Z9s

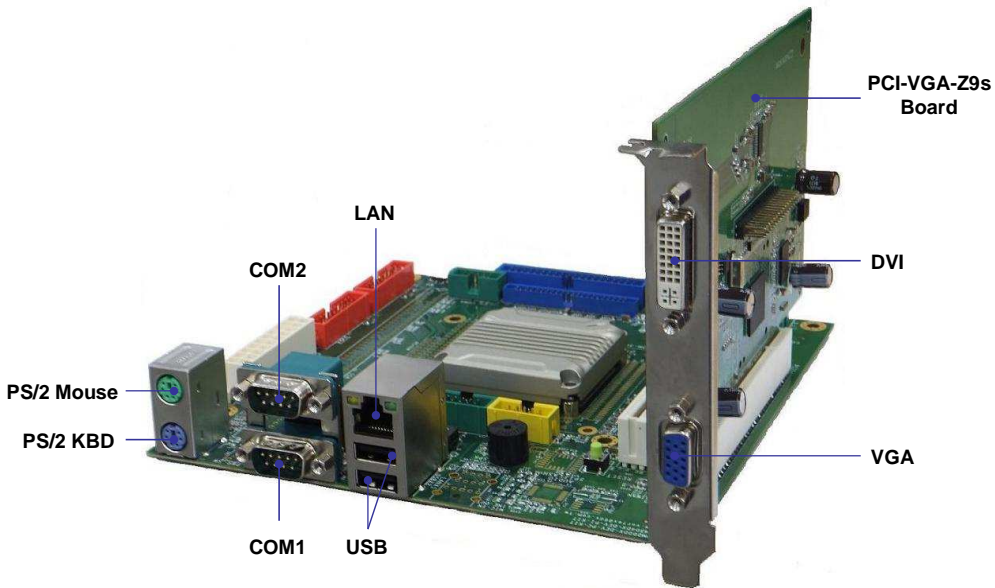

■ SOM200SX-PC

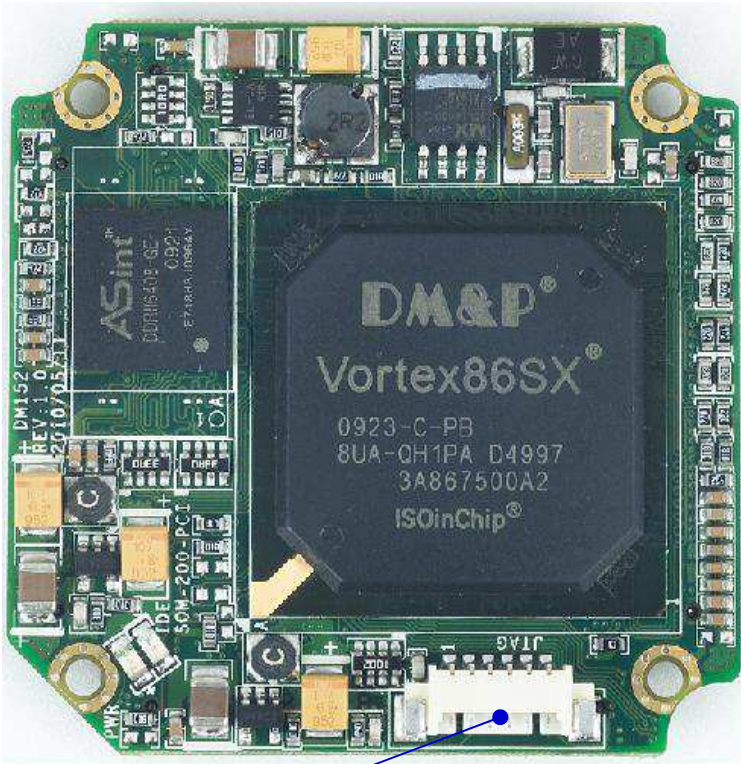

JTAG

2.2 Connectors & Jumpers Location

Connectors

■ SOM200SX-DEV-PC

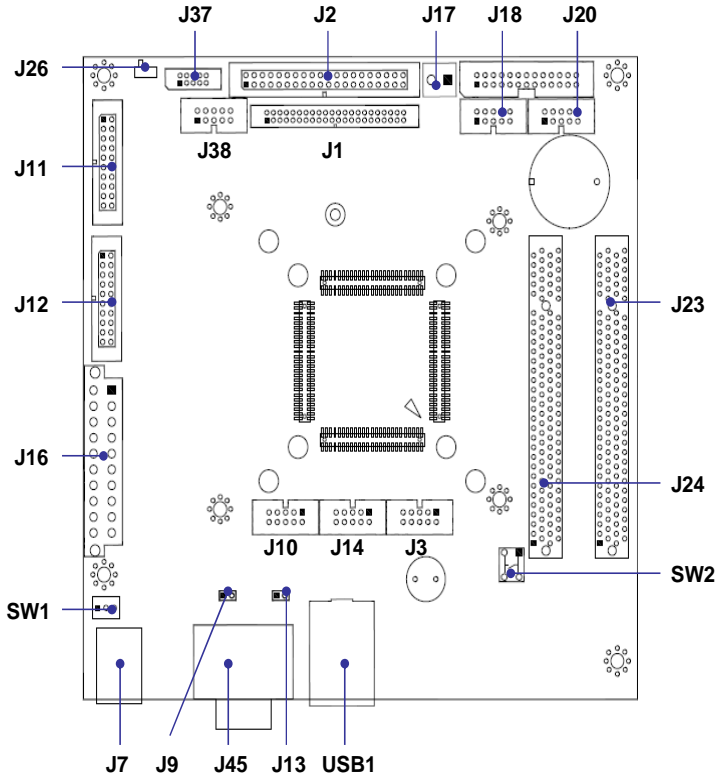

2.3 Connectors & Jumpers Summary

■ SOM200SX-DEV-PC

Nbr	Description	Type of Connections	Pin nbrs.
J1	IDE Connector	Box Header, 2.0Ø, 22x2	44-pin
J2	IDE Connector	Box Header, 2.54Ø, 20x2	40-pin
J3	USB 2/ USB 3	Box Header, 2.54Ø, 5x2	10-pin
USB1A	USB 0/ USB 1	USB connector	8-pin
USB1B	Ethernet LAN	RJ45 Connector	8-pin
J7A	PS/2 Keyboard	Mini-DIN Female	6-pin
J7B	PS/2 Mouse	Mini-DIN Female	6-pin
J9	TTL/RS232 Mode Selector	Pin Header, 2.54Ø, 1x2	2-pin
J10	COM1/P4/PWM	Box Header, 2.54Ø, 5x2	10-pin
J11	GPIO (P0 / P1 /PWM)	Box Header, 2.54Ø,10x2	20-pin
J12	GPIO (P2/P3/ SPI/2C/PWM)	Box Header, 2.54Ø, 10x2	20-pin
J13	TTL/RS232 Mode Selector	Pin Header, 2.54Ø, 1x2	2-pin
J14	COM2	Box Header, 2.54Ø, 5x2	10-pin
J16	ATX Power	ATX header	20-pin
J17	Power Connector	Terminal Block 5.0Ø, 2x1	2-pin
J18	COM3 TTL Mode	Box Header, 2.54Ø, 5x2	10-pin
J20	COM4 TTL Mode	Box Header, 2.54Ø, 5x2	10-pin
J21	ISA Slot	ISA Slot	98-pin
J23	PCI Slot1	PCI Slot	120-pin
J24	PCI Slot2	PCI Slot	120-pin
J26	Console Redirection		
J35A	PC104 Connector – 64 pin	Box Header, 2.54Ø, 32x2	64-pin
J35B	PC104 Connector – 40 pin	Box Header, 2.54Ø, 20x2	40-pin
J37	LPC	Box Header, 2.0Ø, 5x2	10-pin
J38	COM9	Box Header, 2.54Ø, 5x2	10-pin
J45A	COM1	D-Sub Male	9-pin
J45B	COM2	D-Sub Male	9-pin
SP1	BUZZER		
SW1	PWR-SW		
SW2	Reset		

2.4 Pin Assignments & Jumper Settings

■ SOM200SX-DEV-PC

J1: IDE (44 Pins)

Pin #	Signal Name	Pin #	Signal Name
1	IDERST	2	GND
3	IDED7	4	IDED8
5	IDED6	6	IDED9
7	IDED5	8	IDED10
9	IDED4	10	IDED11
11	IDED3	12	IDED12
13	IDED2	14	IDED13
15	IDED1	16	IDED14
17	IDED0	18	IDED15
19	GND	20	NC
21	IDEREQ	22	GND
23	IDEIOW	24	GND
25	IDEIOR	26	GND
27	ICHRDY	28	GND
29	IDEACK	30	GND
31	IDEINT	32	NC
33	IDESA1	34	IDECBLID
35	IDESA0	36	IDESA2
37	IDECS-0	38	IDECS1
39	IDELED	40	GND
41	VCC	42	VCC
43	GND	44	NC

J2: IDE (40 Pins)

Pin #	Signal Name	Pin #	Signal Name
1	IDERST	2	GND
3	IDED7	4	IDED8
5	IDED6	6	IDED9
7	IDED5	8	IDED10
9	IDED4	10	IDED11
11	IDED3	12	IDED12
13	IDED2	14	IDED13
15	IDED1	16	IDED14
17	IDED0	18	IDED15
19	GND	20	VCC
21	IDEREQ	22	GND
23	IDEIOW	24	GND
25	IDEIOR	26	GND
27	ICHRDY	28	GND
29	IDEACK	30	GND
31	IDEINT	32	NC
33	IDESA1	34	IDECBLID
35	IDESA0	36	IDESA2
37	IDECS0	38	IDECS1
39	IDELED	40	GND

J3: USB

Pin #	Signal Name	Pin #	Signal Name
1	VCC	2	VCC
3	LUSBD0-	4	LUSBD1-
5	LUSBD0+	6	LUSBD1+
7	GND	8	GND
9	GGND	10	GGND

USB1A: USB0/1

Pin #	Signal Name	Pin #	Signal Name
1	VCC	2	VCC
3	-DATA	4	-DATA
5	+DATA	6	+DATA
7	GND	8	GND

USB1B: Ethernet LAN

Pin #	Signal Name	Pin #	Signal Name
1	TD+	2	TD-
3	RO+	4	NC
5	NC	6	RO-
7	NC	8	NC

J7A: PS/2 Keyboard

Pin #	Signal Name	Pin #	Signal Name
1	KBDATA	2	NC
3	GND	4	VCC
5	KBCLK	6	RO-

J7B: PS/2 Mouse

Pin #	Signal Name	Pin #	Signal Name
1	TD+	2	TD-
3	RO+	4	NC
5	NC	6	RO-

J9: TTL/RS232 Mode Selector (Open: On, Close: Off)

Pin #	Signal Name	Pin #	Signal Name
1	GND	2	VCC

J10: COM1/P4/

Pin #	Signal Name	Pin #	Signal Name
1	DCD1	2	RXD1
3	TXD1	4	DTR1
5	GND	6	DSR1
7	RTS1	8	CTS1
9	RI1	10	TXDEN1/VCC

J11: GPIO (P0/ P1)

Pin #	Signal Name	Pin #	Signal Name
1	GND	2	VCC
3	GP00	4	GP10
5	GP01	6	GP11
7	GP02	8	GP12
9	GP03	10	GP13
11	GP04	12	GP14
13	GP05	14	GP15
15	GP06	16	GP16
17	GP07	18	GP17
19	VCC	20	GND

J12: GPIO (P2/ P3/ SPI)

Pin #	Signal Name	Pin #	Signal Name
1	GND	2	VCC
3	GP20	4	SPICS
5	GP21	6	SPICLK
7	GP22	8	SPIDO
9	GP23	10	SPIDI
11	GP24	12	GP34
13	GP25	14	GP35
15	GP26	16	GP36
17	GP27	18	GP37
19	VCC	20	GND

Note:

If you Enable 2M SPI flash Disk on the BIOS setting, you cannot use GP30~GP37 Pins.

J13: TTL/RS232 Mode Selector (Open: On, Close: Off)

Pin #	Signal Name	Pin #	Signal Name
1	GND	2	VCC

J14: COM2/P4/PWM

Pin #	Signal Name	Pin #	Signal Name
1	DCD2	2	RXD2
3	TXD2	4	DTR2
5	GND	6	DSR2
7	RTS2	8	CTS2
9	RI2	10	TXDEN2/VCC

J16: ATX Power

Pin #	Signal Name	Pin #	Signal Name
1	3V3	2	3V3
3	GND	4	VCC
5	GND	6	VCC
7	GND	8	NC
9	SB5V	10	+12V
11	3V3	12	-12V
13	GND	14	SB5V
15	GND	16	GND
17	GND	18	-5V
19	VCC	20	VCC

J17: Power Connector (Terminal Block 5.0mm)

Pin #	Signal Name
1	+5V
2	GND

J18: COM3 TTL Mode

Pin #	Signal Name	Pin #	Signal Name
1	DCD3	2	RXD3
3	TXD3	4	DTR3
5	GND	6	DSR3
7	RTS3	8	CTS3
9	RI3	10	VCC

J20: COM 4 TTL Mode

Pin #	Signal Name	Pin #	Signal Name
1	DCD4	2	RXD4
3	TXD4	4	DTR4
5	GND	6	DSR4
7	RTS4	8	CTS4
9	RI4	10	VCC

J37: LPC

Pin #	Signal Name	Pin #	Signal Name
1	24MHZ	2	LAD0
3	LFRAME-	4	LAD1
5	GND	6	LAD2
7	LDRQ-	8	LAD3
9	SERIRQ	10	VCC

J38: COM9

Pin #	Signal Name	Pin #	Signal Name
1	NC	2	RXD9
3	TXD9	4	NC
5	GND	6	NC
7	NC	8	NC
9	NC	10	VCC

J45A: COM 1

Pin #	Signal Name	Pin #	Signal Name
1	DCD1	2	RXD1
3	TXD1	4	DTR1
5	GND	6	DSR1
7	RTS1	8	CTS1
9	RI1		

J45B: COM 2

Pin #	Signal Name	Pin #	Signal Name
1	DCD2	2	RXD2
3	TXD2	4	DTR2
5	GND	6	DSR2
7	RTS2	8	CTS2
9	RI2		

■ SOM200SX-PC

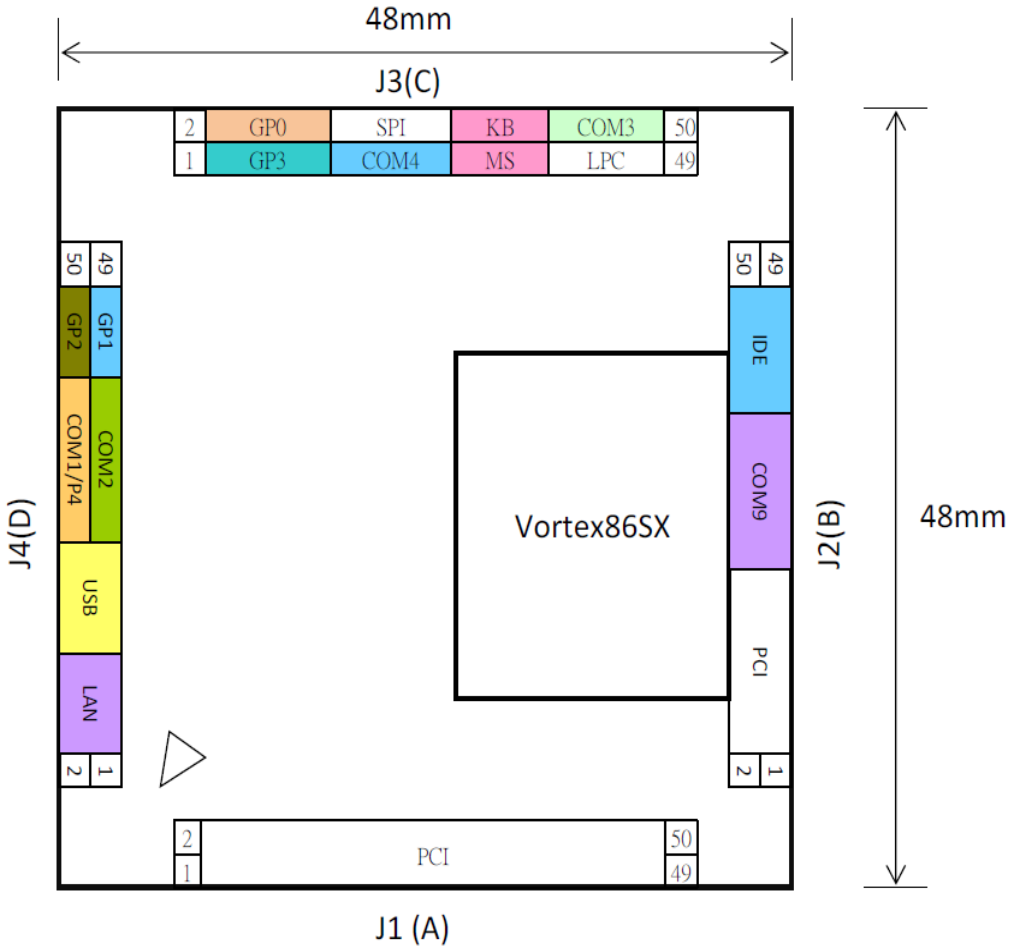

■ SOM200SX-PC

J1/J2/J3/J4: SOM200SX-PC Signal Assignment

J1(A)				J2(B)			
Pin	Signal Name	Pin	Signal Name	Pin	Signal Name	Pin	Signal Name
1	GND	2	GND	1	GND	2	GND
3	INT-A	4	PCICLK1	3	IDED0	4	PCIRST-
5	INT-B	6	PCICLK2	5	IDED1	6	FRAME-
7	INT-C	8	PCICLK3	7	IDED2	8	IRDY-
9	INT-D	10	GND	9	IDED3	10	TRDY-
11	PGNT-0	12	PREQ-0	11	IDED4	12	DEVSEL-
13	PGNT-1	14	PREQ-1	13	IDED5	14	STOP-
15	PGNT-2	16	PREQ-2	15	IDED6	16	PAR
17	GND	18	GND	17	IDED7	18	GND
19	AD31	20	AD30	19	IDED8	20	CBE-3
21	AD29	22	AD28	21	IDED9	22	CBE-2
23	AD27	24	AD26	23	IDED10	24	CBE-1
25	AD25	26	AD24	25	IDED11	26	CBE-0
27	AD23	28	AD22	27	IDED12	28	GND
29	AD21	30	AD20	29	IDED13	30	TXD9\
31	AD19	32	AD18	31	IDED14	32	RXD9\
33	AD17	34	AD16	33	IDED15	34	AIDELED
35	AD15	36	AD14	35	IDESA0	36	IDERST
37	AD13	38	AD12	37	IDESA1	38	IDEINT
39	AD11	40	AD10	39	IDESA2	40	IDEREQ
41	AD9	42	AD8	41	IDECS0	42	IDERDY
43	AD7	44	AD6	43	IDECS1	44	IDECBLID
45	AD5	46	AD4	45	IDEIOW	46	IDEACK
47	AD3	48	AD2	47	IDEIOR	48	VCC3-OUT
49	AD1	50	AD0	49	GND	50	GND

J3(C)				J4(D)			
Pin	Signal Name	Pin	Signal Name	Pin	Signal Name	Pin	Signal Name
1	GP00	2	GP34	1	LINK/ACTIVE	2	DUPLEX
3	GP01	4	GP35	3	LANTX+	4	LANTX-
5	GP02	6	GP36	5	LANRX+	6	LANRX-
7	GP03	8	GP37	7	LUSBD3+	8	LUSBD3-
9	GP04	10	SPICS	9	LUSBD2+	10	LUSBD2-
11	GP05	12	SPICLK	11	LUSBD1+	12	LUSBD1-
13	GP06	14	SPIDO	13	LUSBD0+	14	LUSBD0-
15	GP07	16	SPIDI	15	DCD2\	16	DCD1\
17	DCD4\	18	SPEAKER	17	RXD2\	18	RXD1\
19	RXD4\	20	KBCLK	19	TXD2\	20	TXD1\
21	TXD4\	22	KBDATA	21	DTR2\	22	DTR1\
23	DTR4\	24	MSCLK	23	DSR2\	24	DSR1\
25	DSR4\	26	MSDATA	25	RTS2\	26	RTS1\
27	RTS4\	28	RESET	27	CTS2\	28	CTS1\
29	CTS4\	30	VBATT	29	RI2\	30	RI1\
31	RI4\	32	24MHz	31	TXDEN2	32	TXDEN1
33	DCD3\	34	LFRAME-	33	GP10	34	GP20
35	RXD3\	36	LDRQ-	35	GP11	36	GP21
37	TXD3\	38	SERIRQ	37	GP12	38	GP22
39	DTR3\	40	LAD0	39	GP13	40	GP23
41	DSR3\	42	LAD1	41	GP14	42	GP24
43	RTS3\	44	LAD2	43	GP15	44	GP25
45	CTS3\	46	LAD3	45	GP16	46	GP26
47	RI3\	48	KEY	47	GP17	48	GP27
49	VCC	50	VCC	49	GND	50	GND

2.5 System Mapping

Memory Mapping		
Address	Description	Usage
00000000 - 9000FFFF	System RAM	*
A0000000 - A000FFFF	EGA/VGA Video Memory	
B0000000 - B0007FFF	MDA RAM, Hercules graphics display RAM	
B0008000 - B000FFFF	CGA display RAM	
C0000000 - C0007FFF	EGA/VGA BIOS ROM	
C0008000 - C000BFFF	Boot ROM enable	
C000C000 - C000FFFF	Console Redirection enable	
D0000000 - D700FFFF	Expansion ROM space	
D8000000 - DB00FFFF	SPI FLASH Emulation Floppy A Enable	
DC000000 - DF00FFFF	Expansion ROM Space	
E0000000 - E000FFFF	USB Legacy SCSI ROM space	
F0000000 - F000FFFF	Motherboard BIOS	*
FEFAD000 - FFFFF000	Standard OpenHCD USB Host Controller	*
FEFAF800 - FFFFF000	Standard OpenHCD USB Host Controller	*
FEFAF400 - FFFFF000	On board Ethernet Adapter	*
FEFAE000 - FFFFF000	Standard Enhanced PCI to USB Host Controller	*
FEFAFC00 - FFFFF000	Standard Enhanced PCI to USB Host Controller	*

I/O Mapping

I/O Address	Owner	Usage
0000h - 000Fh	DMA 8237-1	*
0010h - 0017h	COM 9	
0020h - 0021h	PIC 8259-1	*
0022h - 0023h	Indirect Access Registers (6117D configuration port)	*
002Eh - 002Fh	Forward to LPC BUS	
0040h - 0043h	Timer Counter 8254	*
0048h - 004Bh	PWM counter 8254	*
004Eh - 004Fh	Forward to LPC BUS	
0060h	Keyboard / Mouse data port	*
0061h	Port B + NMI control port	*
0062h - 0063h	8051 download 4k address counter	*
0064h	Keyboard/ Mouse status/ command port	*
0065h	WatchDog0 reload counter	*
0066h	8051 download 8bit data port	*
0067h	WatchDog1 reload counter	*
0068h - 006Dh	WatchDog1 control counter	*
0070h - 0071h	CMOS RAM port	*
0072h - 0075h	MTBF control register	*
0078h - 007Ch	GPIO port 0,1,2,3,4 default setup	*
0080h - 008Fh	DMA page register	*
0092h	System control register	*
0098h - 009Ch	GPIO direction control	*

00A0h - 00A1h	PIC 8259-2	*
00C0h - 00DFh	DMA 8237-2	*
00E0h – 00EFh	DOS 4G Page access	*
0170h – 0177h	IDE1(IRQ 15)	
01F0h – 01F7h	IDE0 (IRQ 14)	*
0220h – 0227h	COM8 Forward to LPC BUS	
0228h – 022Fh	COM7 Forward to LPC BUS	
0238h – 023Fh	COM6 Forward to LPC BUS	
0278h – 027Fh	Printer port (IRQ7, DMA 0)	*
02E8h – 02EFh	COM4 (IRQ 11)	*
02F8h – 02EFh	COM2 (IRQ3)	*
0338h – 033Fh	COM5 Forward to LPC BUS	
0376h	IDE1 ATAPI device control write only register	*
03E8h – 03EFh	COM3 (IRQ 10)	*
03F0h – 03F7h	Floppy Disk (IRQ6, DMA2)	
03F6h	IDE0 ATAPI device control write only register	*
03F8h – 03FFh	COM1 (IRQ 4)	*
0480h – 048Fh	DMA High page register	*
0490h – 0499h	Instruction counter register	*
04D0h – 04D1h	8259 Edge / level control register	*
0CF8h – 0CFFh	PCI configuration port	*
DE00h – DEFFh	On board LAN	*
FC00h – FC05h	SPI Flash BIOS control register	*
FC08h – FC0Dh	External SPI BUS control register	*

IRQ Mapping		
IRQ#	Description	Usage
IRQ0	System Timer	*
IRQ1	Keyboard Controller	*
IRQ2	Cascade for IRQ8 – 15	
IRQ3	Serial Port 2	*
IRQ4	Serial Port 1	*
IRQ5	USB	*
IRQ6	USB	*
IRQ7	Printer Port	*
IRQ8	Real Time Clock	*
IRQ9	USB/ Ethernet 10/100M LAN	*
IRQ10	Serial Port 3	*
IRQ11	Serial Port 4	*
IRQ12	Mouse	*
IRQ13	Math Coprocessor	*
IRQ14	Hard Disk Controller#1	*
IRQ15	Hard Disk Controller#2	*

DMA Mapping		
DMA#	Description	Usage
DMA0		
DMA1		
DMA2	Floppy Disk Controller	
DMA3		
DMA4		
DMA5		
DMA6		
DMA7		

2.6 Watchdog Timer

There are two watchdog timers in Vortex86SX/DX CPU. One is compatible with M6117D watchdog timer and the other is new. The M6117D compatible watchdog timer is called WDT0 and the new one is called WDT1.

We also provide DOS, Linux and WinCE example for your reference. For more technical support, please visit: <http://www.dmp.com.tw/tech> or download the PDF file:

<http://www.dmp.com.tw/tech/vortex86sx/>

2.7 GPIO (General Purpose Input / Output)

40 GPIO pins are provided by the Vortex86SX/DX for general usage in the system. All GPIO pins are independent and can be configured as inputs or outputs, with or without pull-up/pull-down resistors.

We also offer DOS, Linux and WinCE example for your reference. For more technical support, please visit: <http://www.dmp.com.tw/tech> or download the PDF file:

<http://www.dmp.com.tw/tech/vortex86sx/>

2.8 SPI flash (Serial Peripheral Interface)

As SPI Flash (Serial Peripheral Interface) offers many benefits including: reduced controller pin count, smaller and simpler PCBs, reduced switching noise, less power consumption, and lower system cost

Many of users may consider using a formatted SPI flash to boot for the system or emulate SPI flash as Floppy (A: Driver or B: Driver). Then you must know how to set for this condition in CMOS Setup and boot up under DOS 6.22, X-DOS, DR-DOS and Free DOS.

For more technical support, please visit: <http://www.dmp.com.tw/tech> or download the PDF file: <http://www.dmp.com.tw/tech/vortex86sx/>

2.9 IDE to SD (Micro-SD)

Vortex86SX SoC also built-in simulation circuit to adapt SD to IDE in order to allow your system to recognize Micro-SD card as C: or D: Driver

SD-1917: 44 pins IDE to SD Adapter is an ideal solution for industrial PC or embedded system and 44 pins IDE to SD Adapter can be easily installed on all Vortex86SX CPU boards. You or your customers just do the BIOS setting and use SD-1917 to connect IDE connector of Vortex86SX directly.

For further inquiries of SD-1917, please contact ICOP sales team or mail to: info@icop.com.tw for your request.

<BIOS setting>

- Get into the BIOS setup Utility
- Choose Primary IDE Pin Select: SD card
- Press “F10” to Save configuration changes and exit setup

SD-1917



SD-1917: <http://www.icop.com.tw/pddetail.aspx?id=125&pid=4>

Chapter 3

Driver Installation

VGA

The Vortex86SX processor also uses external Display Card “Volari™ Z9s” which is an ultra low powered graphics chipset with total power consumption at around 1-1.5 W. It is capable in providing VGA display output upto 1600x1200. With DVO interface, developers could easily connect flat Panel to support TFT and LVDS output.

Please download the Driver: http://www.xgitech.com/sd/sd_download.asp

LAN

The Vortex86SX processor also integrated 10/100Mbps Ethernet controller that supports both 10/100BASE-T and allows direct connection to your 10/100Mbps Ethernet based Local Area Network for full interaction with local servers, wide area networks such as the Internet.

The controller supports: Half / Full-Duplex Ethernet function to double channel bandwidth, auto media detection.

Operating system support

The SOM200SX-PC CPU module provides LAN drivers for DOS 6.22 Windows CE 5.0, CE 6.0, Windows 98, Windows XP Professional, Windows Embedded standard (XPE) and Windows 2000 (SP4).

Please get the drivers from the Driver CD which attached with the standard packing of SOM200SX-PC CPU module or please get it from DMP official website:

<http://www.dmp.com.tw/tech/vortex86sx/>

SOM200SX-PC CPU module also supports most of the popular Linux distributions, for more detail information, please visit DMP official website: <http://www.dmp.com.tw/tech/vortex86sx/>

Appendix

A. TCP/IP library for DOS real mode

DSock is a TCP/IP library for DOS real mode, which is used by RSIP. It provides simple C functions for programmer to write Internet applications. ICOP also provide Internet examples using DSock: BOOTP/DHCP, FTP server, SMTP client/server, HTTP server, TELNET server, Talk client/server, etc.

DSock provides a lot of example source code. Programmer can add Internet functions to their project easily and save development time. With a utility "MakeROM", programmer also can make a ROM image to fit their application, those examples can be seen in the following Application systems: Mity-Mite Serial Server, Web Camera Tiny Server and RSIP Serial Server.

DSock is free for All ICOP products using M6117D/Vortex86/Vortex86SX/Vortex86DX CPU and ICOP also provide the business version of DSock for those customers who are using other x86 CPUs.

If you would like to use DSock or business version of DSock, Please mail to info@icop.com.tw or contact your regional sales.

Please download the trial DSock software and Utilities from our website:
<http://www.dmp.com.tw/tech/dmp-lib/dsock/>

B. SOM200SX-PC & SOM200SX-DEV-PC Schematic

Schematic information can help baseboard designer to optimize exactly how each of these functions implements physically. Designer can place connectors precisely where needed for the application on a baseboard designed to optimally fit a system's packaging.

Please contact or e-mail our regional sales to get SOM200SX-PC CPU module and SOM200SX-DEV-PC Schematic.

C. BIOS Default setting

If the system cannot be booted after BIOS changes are made, Please follow below procedures in order to restore the CMOS as default setting.

- Press “End” Key, when the power on



- Press to enter the AMI BIOS setup
- Press “F9” to Load Optimized Defaults
- Press “F10” to Save configuration changes and exit setup

Warranty

This product is warranted to be in good working order for a period of one year from the date of purchase. Should this product fail to be in good working order at any time during this period, we will, at our option, replace or repair it at no additional charge except as set forth in the following terms. This warranty does not apply to products damaged by misuse, modifications, accident or disaster. Vendor assumes no liability for any damages, lost profits, lost savings or any other incidental or consequential damage resulting from the use, misuse of, originality to use this product. Vendor will not be liable for any claim made by any other related party. Return authorization must be obtained from the vendor before returned merchandise will be accepted. Authorization can be obtained by calling or faxing the vendor and requesting a Return Merchandise Authorization (RMA) number. Returned goods should always be accompanied by a clear problem description.