

**MODEL:
eKINO-BT**

Mini-ITX SBC Supports AUPS Sub-System, 22nm Intel® Atom™ or Celeron® SoC, Wide-Range 9 V ~ 26 V DC Input, VGA, Dual LVDS, Dual GbE, USB 3.0, PCIe Mini, CFast, HD Audio and RoHS

User Manual

Revision

Date	Version	Changes
June 29, 2017	1.06	Updated BIOS spec on page 8
January 23, 2017	1.05	Changed part number of the optional PS/2 keyboard and mouse Y cable (page 14)
February 16, 2016	1.04	Added notes below Figure 3-1 and Figure 3-2
December 14, 2015	1.03	Added a note in Section 3.3.6: VGA Connector
February 13, 2015	1.02	Changed power input voltage range to 9 V ~ 26 V
January 23, 2015	1.01	Updated part number of the SATA cable
September 24, 2014	1.00	Initial release

Copyright

COPYRIGHT NOTICE

The information in this document is subject to change without prior notice in order to improve reliability, design and function and does not represent a commitment on the part of the manufacturer.

In no event will the manufacturer be liable for direct, indirect, special, incidental, or consequential damages arising out of the use or inability to use the product or documentation, even if advised of the possibility of such damages.

This document contains proprietary information protected by copyright. All rights are reserved. No part of this manual may be reproduced by any mechanical, electronic, or other means in any form without prior written permission of the manufacturer.

TRADEMARKS

All registered trademarks and product names mentioned herein are used for identification purposes only and may be trademarks and/or registered trademarks of their respective owners.

Manual Conventions



WARNING

Warnings appear where overlooked details may cause damage to the equipment or result in personal injury. Warnings should be taken seriously.



CAUTION

Cautionary messages should be heeded to help reduce the chance of losing data or damaging the product.



NOTE

These messages inform the reader of essential but non-critical information. These messages should be read carefully as any directions or instructions contained therein can help avoid making mistakes.



HOT SURFACE

This symbol indicates a hot surface that should not be touched without taking care.

Table of Contents

1 INTRODUCTION.....	1
1.1 INTRODUCTION.....	2
1.2 MODEL VARIATIONS	3
1.3 FEATURES.....	3
1.4 CONNECTORS	4
1.5 DIMENSIONS.....	6
1.6 DATA FLOW	7
1.7 TECHNICAL SPECIFICATIONS	8
2 PACKING LIST.....	11
2.1 ANTI-STATIC PRECAUTIONS	12
2.2 UNPACKING PRECAUTIONS.....	12
2.3 PACKING LIST.....	13
2.4 OPTIONAL ITEMS	14
3 CONNECTORS	15
3.1 PERIPHERAL INTERFACE CONNECTORS.....	16
3.1.1 <i>Layout</i>	16
3.1.2 <i>Peripheral Interface Connectors</i>	17
3.1.3 <i>External Interface Panel Connectors</i>	19
3.2 INTERNAL PERIPHERAL CONNECTORS	19
3.2.1 <i>9 V ~ 26 V Power Connector</i>	19
3.2.2 <i>12-pin Battery Connector</i>	20
3.2.3 <i>Audio Connector</i>	21
3.2.4 <i>Backlight Inverter Connectors</i>	22
3.2.5 <i>Battery Connector</i>	23
3.2.6 <i>Battery LED Connector</i>	24
3.2.7 <i>CFast Card Slot</i>	25
3.2.8 <i>Digital I/O Connector</i>	26
3.2.9 <i>Fan Connector (CPU)</i>	27
3.2.10 <i>Fan Connector (System)</i>	28

3.2.11 Front Panel Connector.....	29
3.2.12 Infrared Interface Connector.....	30
3.2.13 Keyboard and Mouse Connector.....	31
3.2.14 LAN Active LED Connector.....	32
3.2.15 LVDS Connectors.....	33
3.2.16 microSD Card Slot (E38XX SKU Only).....	35
3.2.17 PCIe x1 Slot.....	35
3.2.18 PCIe Mini Card Slot.....	36
3.2.19 Power Button (On-board).....	38
3.2.20 Reset Button (On-board).....	38
3.2.21 SATA 3Gb/s Drive Connectors.....	39
3.2.22 SATA Power Connectors (5 V).....	41
3.2.23 Serial Port Connector, RS-232.....	41
3.2.24 Serial Port Connector, RS-422/485.....	42
3.2.25 SMBus Connector.....	44
3.2.26 SO-DIMM Connectors.....	44
3.2.27 SPI Flash Connector.....	45
3.2.28 SPI Flash Connector (EC).....	46
3.2.29 TPM Connector.....	47
3.2.30 USB 2.0 Connector.....	48
3.3 EXTERNAL INTERFACE CONNECTORS.....	49
3.3.1 9 V ~ 26 V DC In Connector.....	50
3.3.2 Audio Jacks.....	50
3.3.3 Ethernet and USB 2.0 Connectors.....	51
3.3.4 Ethernet and USB 3.0 Connectors.....	52
3.3.5 Serial Port Connectors.....	53
3.3.6 VGA Connector.....	54
4 INSTALLATION.....	56
4.1 ANTI-STATIC PRECAUTIONS.....	57
4.2 INSTALLATION CONSIDERATIONS.....	57
4.3 SO-DIMM INSTALLATION.....	59
4.4 FULL-SIZE PCIe MINI CARD INSTALLATION.....	59
4.5 HALF-SIZE PCIe MINI CARD INSTALLATION.....	61
4.6 UPS INSTALLATION.....	65

eKINO-BT Mini-ITX SBC

4.7 SYSTEM CONFIGURATION.....	66
4.7.1 AT/ATX Power Mode Selection.....	66
4.7.2 Battery Enable/Disable.....	66
4.7.3 Clear CMOS Button.....	68
4.7.4 LVDS Panel Type Selection.....	68
4.7.5 LVDS1 Voltage Selection.....	70
4.7.6 LVDS2 Voltage Selection.....	71
4.7.7 UPS/Battery Mode Selection.....	72
4.8 CHASSIS INSTALLATION.....	74
4.8.1 Airflow.....	74
4.8.2 Motherboard Installation.....	74
4.9 INTERNAL PERIPHERAL DEVICE CONNECTIONS.....	74
4.9.1 SATA Drive Connection.....	74
4.10 EXTERNAL PERIPHERAL INTERFACE CONNECTION.....	75
4.10.1 Audio Connector.....	75
4.10.2 LAN Connection.....	76
4.10.3 Serial Device Connection.....	77
4.10.4 USB Connection.....	78
4.10.5 VGA Monitor Connection.....	79
5 BIOS.....	81
5.1 INTRODUCTION.....	82
5.1.1 Starting Setup.....	82
5.1.2 Using Setup.....	82
5.1.3 Getting Help.....	83
5.1.4 Unable to Reboot after Configuration Changes.....	83
5.1.5 BIOS Menu Bar.....	83
5.2 MAIN.....	84
5.3 ADVANCED.....	85
5.3.1 ACPI Settings.....	86
5.3.2 F81866 Super IO Configuration.....	87
5.3.2.1 Serial Port n Configuration.....	87
5.3.3 iWDD H/W Monitor.....	94
5.3.3.1 Smart Fan Mode Configuration.....	95
5.3.4 RTC Wake Settings.....	96

5.3.5 Serial Port Console Redirection	98
5.3.6 CPU Configuration.....	100
5.3.7 IDE Configuration	102
5.3.8 Trusted Computing.....	103
5.3.9 USB Configuration.....	104
5.4 CHIPSET	105
5.4.1 North Bridge	106
5.4.1.1 Intel IGD Configuration.....	106
5.4.2 Southbridge Configuration	108
5.4.2.1 PCI Express Configuration	109
5.5 SECURITY.....	110
5.6 BOOT.....	111
5.7 SAVE & EXIT	112
6 SOFTWARE DRIVERS	114
6.1 AVAILABLE SOFTWARE DRIVERS	115
6.2 SOFTWARE INSTALLATION	115
6.3 CHIPSET DRIVER INSTALLATION.....	117
6.4 GRAPHICS DRIVER INSTALLATION.....	120
6.5 LAN DRIVER INSTALLATION	124
6.6 AUDIO DRIVER INSTALLATION	126
A REGULATORY COMPLIANCE	128
B PRODUCT DISPOSAL	130
C BIOS OPTIONS	132
D TERMINOLOGY	135
E DIGITAL I/O INTERFACE	139
E.1 INTRODUCTION	140
E.2 ASSEMBLY LANGUAGE SAMPLE 1	141
E.3 ASSEMBLY LANGUAGE SAMPLE 2	141
F HAZARDOUS MATERIALS DISCLOSURE.....	142

List of Figures

Figure 1-1: eKINO-BT	2
Figure 1-2: Connectors (Front Side).....	4
Figure 1-3: Connectors (Solder Side).....	5
Figure 1-4: eKINO-BT Dimensions (mm).....	6
Figure 1-5: Data Flow Diagram.....	7
Figure 3-1: Peripheral Interface Connectors (Front Side)	16
Figure 3-2: Peripheral Interface Connectors (Solder Side).....	17
Figure 3-3: 9 V ~ 26 V Power Connector Location	20
Figure 3-4: 12-pin Battery Connector Location	21
Figure 3-5: Audio Connector Location	22
Figure 3-6: Backlight Inverter Connector Locations.....	23
Figure 3-7: Battery Connector Location.....	24
Figure 3-8: Battery LED Connector Location	25
Figure 3-9: CFast Card Slot Location	26
Figure 3-10: Digital I/O Connector Location	27
Figure 3-11: CPU Fan Connector Location	28
Figure 3-12: System Fan Connector Location.....	29
Figure 3-13: Front Panel Connector Location	30
Figure 3-14: Infrared Connector Location.....	31
Figure 3-15: Keyboard and Mouse Connector Location.....	32
Figure 3-16: LAN Active LED Connector Location.....	33
Figure 3-17: LVDS Connector Locations.....	34
Figure 3-18: microSD Card Slot Location	35
Figure 3-19: PCIe x1 Slot Location	36
Figure 3-20: PCIe Mini Card Slot Location.....	36
Figure 3-21: On-board Power Button Location	38
Figure 3-22: On-board Reset Button Location	39
Figure 3-23: SATA 3Gb/s Drive Connector Locations	40
Figure 3-24: 5 V SATA Power Connector Locations	41
Figure 3-25: RS-232 Serial Port Connector Location.....	42

Figure 3-26: RS-422/485 Serial Port Connector Location.....	43
Figure 3-27: SMBus Connector Location.....	44
Figure 3-28: SO-DIMM Connector Locations.....	45
Figure 3-29: SPI Flash Connector Location.....	46
Figure 3-30: EC SPI Flash Connector Location.....	47
Figure 3-31: TPM Connector Location.....	48
Figure 3-32: USB Connector Location.....	49
Figure 3-33: External Interface Connectors.....	49
Figure 3-34: 9 V ~ 26 V DC In Connector.....	50
Figure 3-35: Audio Jacks.....	50
Figure 3-36: Ethernet Connector.....	51
Figure 3-37: Ethernet Connector.....	52
Figure 3-38: Serial Port Pinouts.....	54
Figure 3-39: VGA Connector.....	55
Figure 4-1: SO-DIMM Installation.....	59
Figure 4-2: Removing the Retention Screws.....	60
Figure 4-3: Inserting the Full-size PCIe Mini Card into the Slot at an Angle.....	60
Figure 4-4: Securing the Full-size PCIe Mini Card.....	61
Figure 4-5: Removing the Retention Screw.....	62
Figure 4-6: Removing the Standoff.....	62
Figure 4-7: Installing the Standoff.....	63
Figure 4-8: Inserting the Half-size PCIe Mini Card into the Slot at an Angle.....	64
Figure 4-9: Securing the Half-size PCIe Mini Card.....	64
Figure 4-10: UPS Installation.....	65
Figure 4-11: AT/ATX Power Mode Switch Location.....	66
Figure 4-12: Battery Enable/Disable Jumper Location.....	67
Figure 4-13: Clear CMOS Button Location.....	68
Figure 4-14: LVDS Panel Type Selection Switch Locations.....	69
Figure 4-15: LVDS1 Voltage Selection Jumper Location.....	70
Figure 4-16: LVDS2 Voltage Selection Jumper Location.....	71
Figure 4-17: UPS/Battery Mode Selection Jumper Location.....	72
Figure 4-18: SATA Drive Cable Connection.....	75
Figure 4-19: Audio Connector.....	76
Figure 4-20: LAN Connection.....	77
Figure 4-21: Serial Device Connector.....	78

eKINO-BT Mini-ITX SBC

Figure 4-22: USB Connector	79
Figure 4-23: VGA Connector	80
Figure 6-1: Driver CD Main Menu	116
Figure 6-2: Available Drivers	116
Figure 6-3: Chipset Driver Welcome Screen.....	117
Figure 6-4: Chipset Driver License Agreement	118
Figure 6-5: Chipset Driver Read Me File	118
Figure 6-6: Chipset Driver Setup Operations	119
Figure 6-7: Chipset Driver Installation Finish Screen.....	120
Figure 6-8: Graphics Driver Welcome Screen	121
Figure 6-9: Graphics Driver License Agreement.....	122
Figure 6-10: Graphics Driver Read Me File	122
Figure 6-11: Graphics Driver Setup Operations	123
Figure 6-12: Graphics Driver Installation Finish Screen	123
Figure 6-13: LAN Driver Welcome Screen	124
Figure 6-14: LAN Driver Installation	125
Figure 6-15: LAN Driver Installation Complete.....	125
Figure 6-16: Audio Driver Welcome Screen.....	126
Figure 6-17: Audio Driver Installation.....	127
Figure 6-18: Audio Driver Installation Complete	127

List of Tables

Table 1-1: Model Variations	3
Table 1-2: Technical Specifications.....	10
Table 2-1: Packing List.....	13
Table 2-2: Optional Items.....	14
Table 3-1: Peripheral Interface Connectors	18
Table 3-2: Rear Panel Connectors	19
Table 3-3: 9 V ~ 26 V Power Connector Pinouts.....	20
Table 3-4: 12-pin Battery Connector Pinouts	21
Table 3-5: Audio Connector Pinouts	22
Table 3-6: Backlight Inverter Connector Pinouts	23
Table 3-7: Battery Connector Pinouts	24
Table 3-8: Battery LED Connector Pinouts.....	25
Table 3-9: Digital I/O Connector Pinouts.....	27
Table 3-10: CPU Fan Connector Pinouts	28
Table 3-11: System Fan Connector Pinouts	29
Table 3-12: Front Panel Connector Pinouts.....	30
Table 3-13: Infrared Connector Pinouts	31
Table 3-14: Keyboard and Mouse Connector Pinouts.....	32
Table 3-15: LAN Active LED Connector Pinouts	33
Table 3-16: LVDS Connector Pinouts.....	34
Table 3-17: PCIe Mini Card Slot Pinouts	37
Table 3-18: SATA 3Gb/s Drive Connector Pinouts.....	40
Table 3-19: 5 V SATA Power Connector Pinouts	41
Table 3-20: RS-232 Serial Port Connector Pinouts	42
Table 3-21: RS-422/485 Serial Port Connector Pinouts	43
Table 3-22: DB-9 RS-422/485 Pinouts.....	43
Table 3-23: SMBus Connector Pinouts	44
Table 3-24: SPI Flash Connector Pinouts	46
Table 3-25: EC SPI Flash Connector Pinouts	47
Table 3-26: TPM Connector Pinouts.....	48

eKINO-BT Mini-ITX SBC

Table 3-27: USB 2.0 Port Connector Pinouts.....	49
Table 3-28: 9 V ~ 26 V DC In Connector Pinouts	50
Table 3-29: LAN Pinouts	51
Table 3-30: Ethernet Connector LEDs.....	51
Table 3-31: External USB 2.0 Port Pinouts	52
Table 3-32: LAN Pinouts	52
Table 3-33: Ethernet Connector LEDs.....	53
Table 3-34: External USB 3.0 Port Pinouts	53
Table 3-35: Serial Port Pinouts.....	54
Table 3-36: VGA Connector Pinouts.....	54
Table 4-1: AT/ATX Power Mode Switch Settings.....	66
Table 4-2: Battery Enable/Disable Jumper Settings	67
Table 4-3: LVDS Panel Type Selection	69
Table 4-4: LVDS1 Voltage Selection Jumper Settings.....	70
Table 4-5: LVDS2 Voltage Selection Jumper Settings.....	71
Table 4-6: UPS/Battery Mode Selection Jumper Settings	72
Table 4-7: In AT Power Mode.....	73
Table 4-8: In ATX Power Mode	73
Table 5-1: BIOS Navigation Keys	83

BIOS Menus

BIOS Menu 1: Main	84
BIOS Menu 2: Advanced	85
BIOS Menu 3: ACPI Settings	86
BIOS Menu 4: F81866 Super IO Configuration	87
BIOS Menu 5: Serial Port n Configuration Menu	87
BIOS Menu 6: IrDA Configuration Menu.....	92
BIOS Menu 7: iWDD H/W Monitor	94
BIOS Menu 8: Smart Fan Mode Configuration	95
BIOS Menu 9: RTC Wake Settings	97
BIOS Menu 10: Serial Port Console Redirection	98
BIOS Menu 11: CPU Configuration	100
BIOS Menu 12: IDE Configuration.....	102
BIOS Menu 13: Trusted Computing	103
BIOS Menu 14: USB Configuration	104
BIOS Menu 15: Chipset	105
BIOS Menu 16: North Bridge	106
BIOS Menu 17: Intel IGD Configuration.....	106
BIOS Menu 18: Southbridge Configuration	108
BIOS Menu 19: PCI Express Configuration	109
BIOS Menu 20: Security	110
BIOS Menu 21: Boot	111
BIOS Menu 22: Save & Exit.....	113

Chapter

1

Introduction

1.1 Introduction

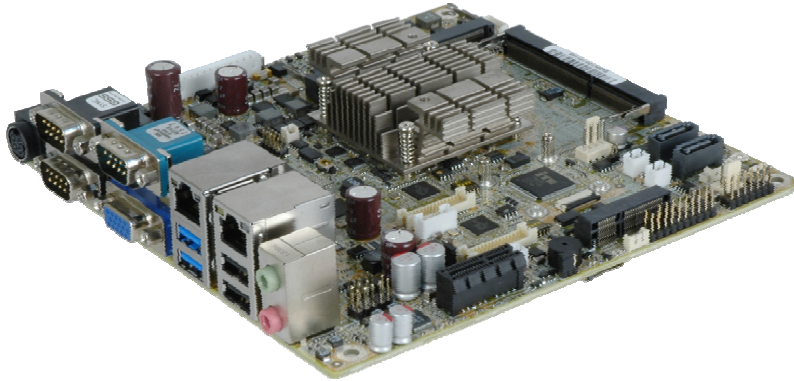

Figure 1-1: eKINO-BT

The eKINO-BT is a Mini-ITX SBC that supports AUPS sub-system. It has an on-board 22nm Intel® Atom™ or Celeron® SoC, and supports one or two 204-pin 1333/1066 MHz unbuffered DDR3L SDRAM SO-DIMMs.

The eKINO-BT provides two GbE interfaces through the Realtek RTL8111E PCIe GbE controllers. In addition, the eKINO-BT comes with one VGA and two 18-bit/24-bit dual-channel LVDS connectors for dual independent display.

Expansion and I/O include two USB 3.0 and two USB 2.0 on the rear panel, two USB 2.0 by pin header, two SATA 3Gb/s, four RS-232, one RS-422/485, one CFast card slot, one PCIe Mini card slot and one PCIe x1 slot. High Definition Audio (HDA) support ensures HDA devices can be easily implemented on the eKINO-BT.

1.2 Model Variations

The model variations for the eKINO-BT series are listed in **Table 1-1**.

Model	On-board SoC				
	Name	Clock Speed	# of Cores	L2 Cache	Max TDP
EKINO-BT-J19001	Intel® Celeron® J1900	2.0 GHz	4	2 MB	10 W
EKINO-BT-N29301	Intel® Celeron® N2930	1.83 GHz	4	2 MB	7.5 W
EKINO-BT-N28071	Intel® Celeron® N2807	1.58 GHz	2	2 MB	4.3 W
EKINO-BT-E38451	Intel® Atom™ E3845	1.91 GHz	4	2 MB	10 W
EKINO-BT-E38271	Intel® Atom™ E3827	1.75 GHz	2	1 MB	8 W
EKINO-BT-E38261	Intel® Atom™ E3826	1.46 GHz	2	1 MB	7 W
EKINO-BT-E38251	Intel® Atom™ E3825	1.33 GHz	2	1 MB	6 W
EKINO-BT-E38151	Intel® Atom™ E3815	1.46 GHz	1	512 KB	5 W

Table 1-1: Model Variations

1.3 Features

Some of the eKINO-BT motherboard features are listed below:

- Mini-ITX form factor
- On-board 22nm Intel® Atom™ or Celeron® SoC
- Supports AUPS sub-system, acts as a simple UPS system
- Wide-range 9 V ~ 26 V DC input design
- Two 204-pin 1333/1066 MHz dual-channel unbuffered DDR3L SDRAM SO-DIMM slots support up to 8 GB (for J1900, N2930, E3845, E3827 and E3826 SKUs)
- or**
- One 204-pin 1333/1066 MHz unbuffered DDR3L SDRAM SO-DIMM slot supports up to 4 GB (for N2807, E3825 and E3815 SKUs)
- Dual independent display via VGA and dual LVDS interfaces
- Complete I/O interfaces, including two USB 3.0, four USB 2.0, four RS-232, one RS-422/485 and two SATA 3Gb/s
- Flexible expansion options, including one PCIe Mini card slot, one CFast card slot, one microSD card slot (E38XX SKU only) and one PCIe x1 slot
- RoHS compliant

1.4 Connectors

The connectors on the eKINO-BT are shown in the figures below.

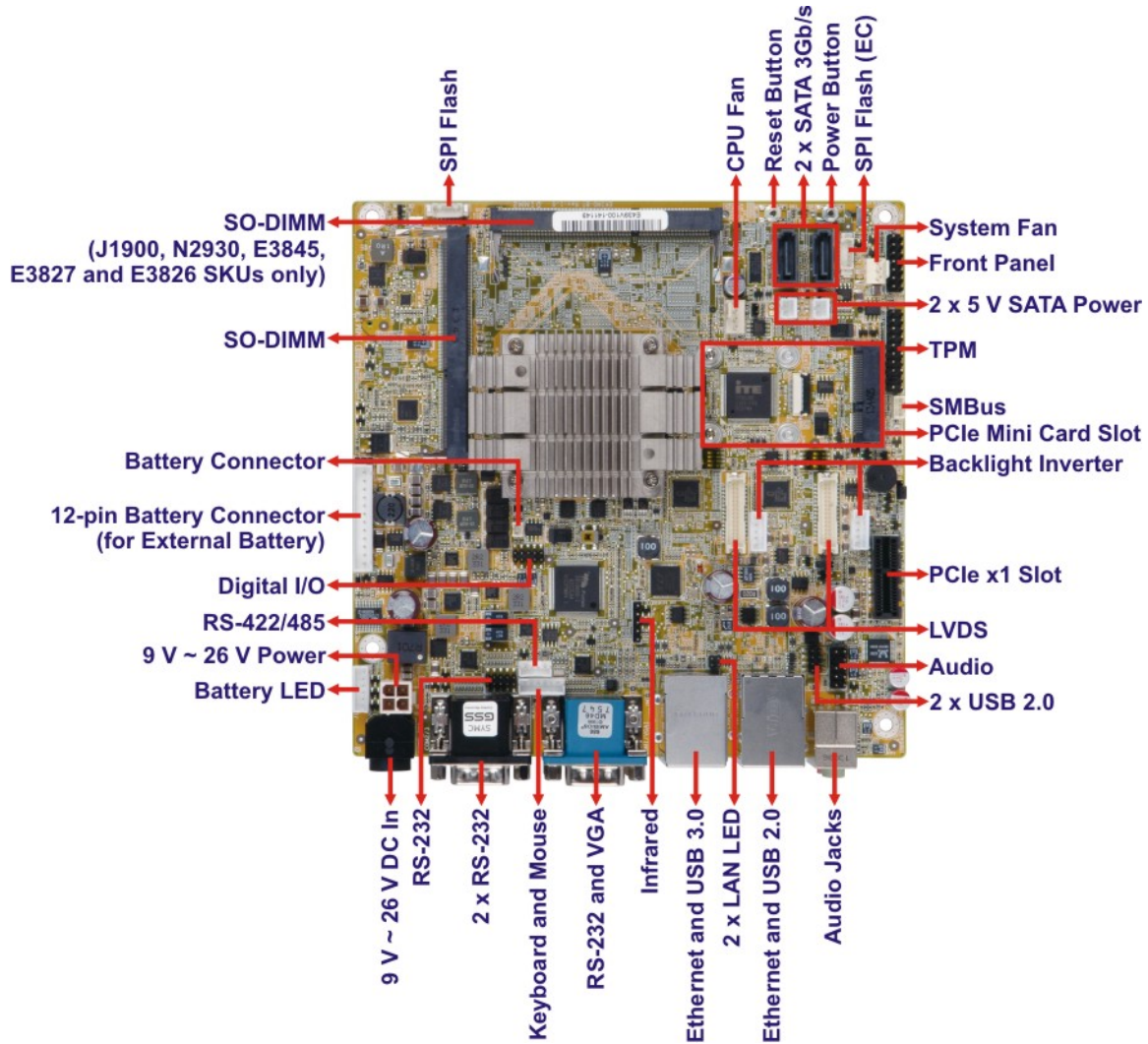

Figure 1-2: Connectors (Front Side)

eKINO-BT Mini-ITX SBC

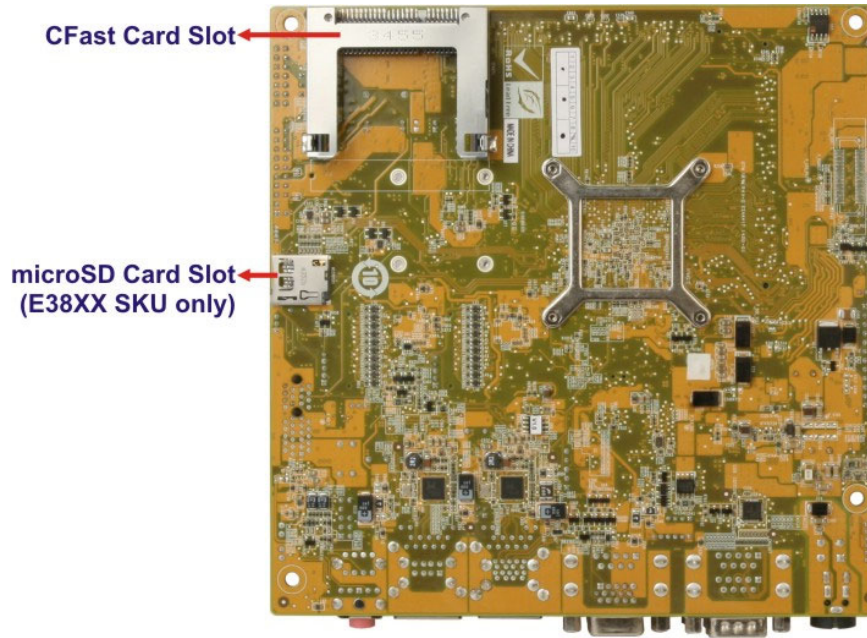

Figure 1-3: Connectors (Solder Side)

1.5 Dimensions

The main dimensions of the eKINO-BT are shown in the diagram below.

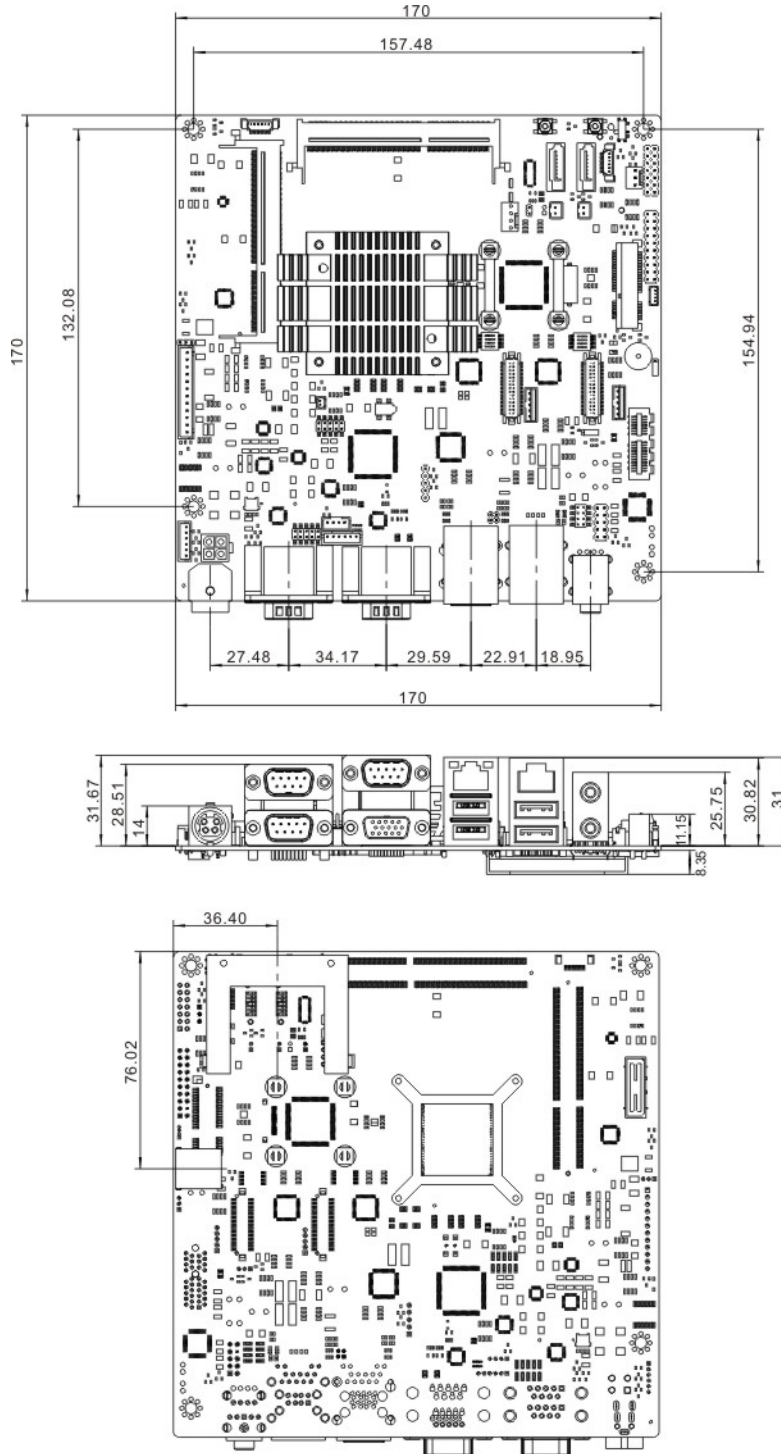

Figure 1-4: eKINO-BT Dimensions (mm)

eKINO-BT Mini-ITX SBC

1.6 Data Flow

Figure 1-5 shows the data flow between the system chipset, the CPU and other components installed on the motherboard.

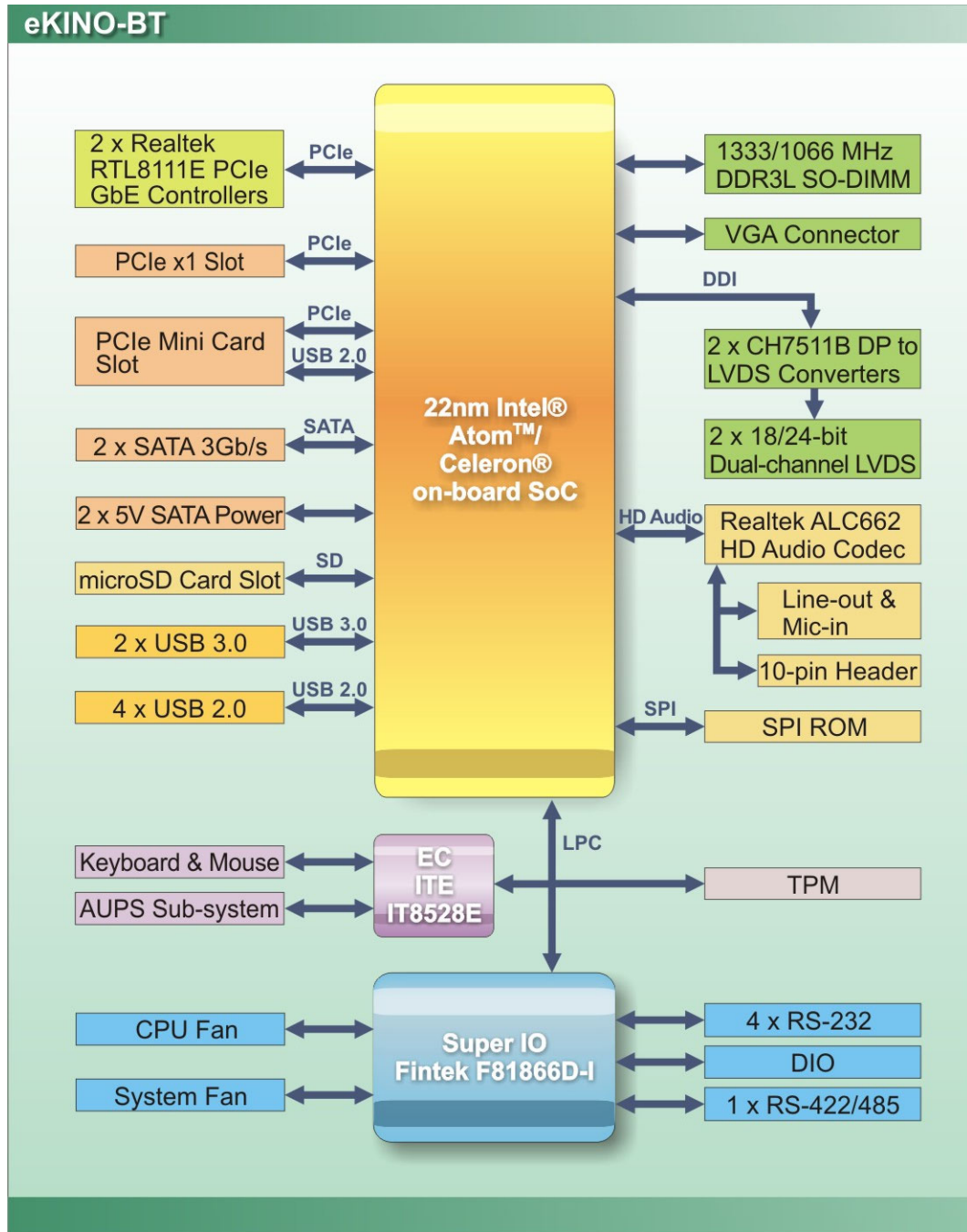

Figure 1-5: Data Flow Diagram

1.7 Technical Specifications

The eKINO-BT technical specifications are listed in **Table 1-2**.

Specification/Model	eKINO-BT
Form Factor	Mini-ITX
Onboard SoC	<p>Intel® Atom™ E3845 (1.91GHz, quad-core, 2MB cache, TDP=10W)</p> <p>Intel® Atom™ E3827 (1.75GHz, dual-core, 1MB cache, TDP=8W)</p> <p>Intel® Atom™ E3826 (1.46GHz, dual-core, 1MB cache, TDP=7W)</p> <p>Intel® Atom™ E3825 (1.33GHz, dual-core, 1MB cache, TDP=6W)</p> <p>Intel® Atom™ E3815 (1.46GHz, single-core, 512KB cache, TDP=5W)</p> <p>Intel® Celeron® J1900 (2GHz, quad-core, 2MB cache, TDP=10W)</p> <p>Intel® Celeron® N2930 (1.83GHz, quad-core, 2MB cache, TDP=7.5W)</p> <p>Intel® Celeron® N2807 (1.58GHz, dual-core, 2MB cache, TDP=4.5W)</p>
Memory	<p>For J1900, N2930, E3845, E3827and E3826 SKUs:</p> <p>Two 204-pin 1333/1066 MHz dual-channel unbuffered DDR3L SDRAM SO-DIMM slots support up to 8 GB</p> <p>For N2807, E3825 and E3815 SKUs:</p> <p>One 204-pin 1333/1066 MHz unbuffered DDR3L SDRAM SO-DIMM slot supports up to 4 GB</p> <p>* Use DIMM1 slot when installing one SO-DIMM. For the SO-DIMM slot location, refer to Figure 3-28.</p>
Graphics Engine	Intel® HD Graphics Gen 7 with 4 execution units, supporting DirectX 11.1, OpenCL 1.2 and OpenGL 4.2
Display Output	<p>One VGA (up to 2560x1600@60 Hz)</p> <p>Two 18/24-bit dual-channel LVDS* by CH7511B DP to LVDS converters (up to 1920x1200@60 Hz)</p> <p>* The eKINO-BT supports only one LCD when using the optional 7.4 V battery (BATKIT-2S2P3800-R10/BAT-LI-2S2P3800).</p>
BIOS	<p>AMI UEFI BIOS</p> <p>E439A1xx BIOS version is for E38XX SKUs</p> <p>E439AMxx BIOS version is for J1900, N2930 and N2807 SKUs</p>

eKINO-BT Mini-ITX SBC

Ethernet	Two Realtek RTL8111E PCIe GbE controllers
Audio	Realtek ALC662 HD Audio codec
Super I/O Controller	Fintek F81866D-I
Embedded Controller	ITE IT8528E
Watchdog Timer	Software programmable, supports 1~255 sec. system reset
Expansions	One full-size/half-size PCIe Mini card slot (with USB 2.0 signal) One PCIe x1 slot One CFast card slot One microSD card slot (E38XX SKU only)
I/O Interface Connectors	
Audio Connectors	Line-out and mic-in audio jacks on rear panel One front panel audio connector (10-pin header)
Battery Connectors	One 2-pin wafer connector One 12-pin wafer connector (for AUPS battery)
Digital I/O	One 8-bit digital I/O
Ethernet	Two RJ-45 GbE ports
Fan Connectors	One 4-pin wafer connector (CPU fan) One 3-pin wafer connector (system fan)
Front Panel	One 14-pin header (power LED, HDD LED, speaker, power button, reset button)
Keyboard and Mouse	One 6-pin wafer connector for PS/2 keyboard and mouse
LAN LEDs	Two 2-pin headers for LAN1 LED and LAN2 LED (link signal)
Serial ATA	Two SATA 3Gb/s connectors Two 5 V SATA power connectors
Serial Ports	Four RS-232 COM connectors (one by pin header, three on rear panel) One RS-422/485 COM connector (4-pin wafer)
SMBus	One 4-pin wafer connector

USB Ports	Two USB 3.0 ports on rear panel Four USB 2.0 ports (two on rear panel, two by pin headers)
TPM	One 20-pin header
Environmental and Power Specifications	
Power Supply	Input voltage range: 9 V ~ 26 V Recommended operating input voltage range: 12 V ~ 24 V One external 4-pin DIN DC jack One internal 4-pin (2x2) power connector
Power Consumption	+12V@1.55A (Intel® Celeron® J1900 CPU with two 4 GB 1333 MHz DDR3L memory)
Operating Temperature	0°C ~ 40°C (with AUPS sub-system) -20°C ~ 60°C (without AUPS sub-system)
Storage Temperature	-10°C ~ 50°C (with AUPS sub-system) -30°C ~ 70°C (without AUPS sub-system)
Operating Humidity	5% ~ 95% (non-condensing)
Physical Specifications	
Dimensions	170 mm x 170 mm
Weight (GW/NW)	1100 g/400 g

Table 1-2: Technical Specifications

Chapter

2

Packing List

2.1 Anti-static Precautions



WARNING!

Static electricity can destroy certain electronics. Make sure to follow the ESD precautions to prevent damage to the product, and injury to the user.

Make sure to adhere to the following guidelines:

- **Wear an anti-static wristband:** Wearing an anti-static wristband can prevent electrostatic discharge.
- **Self-grounding:** Touch a grounded conductor every few minutes to discharge any excess static buildup.
- **Use an anti-static pad:** When configuring any circuit board, place it on an anti-static mat.
- **Only handle the edges of the PCB:** Don't touch the surface of the motherboard. Hold the motherboard by the edges when handling.

2.2 Unpacking Precautions

When the eKINO-BT is unpacked, please do the following:

- Follow the anti-static guidelines above.
- Make sure the packing box is facing upwards when opening.
- Make sure all the packing list items are present.

eKINO-BT Mini-ITX SBC

2.3 Packing List



NOTE:

If any of the components listed in the checklist below are missing, do not proceed with the installation. Contact the IEI reseller or vendor the eKINO-BT was purchased from or contact an IEI sales representative directly by sending an email to sales@ieiworld.com.

The eKINO-BT is shipped with the following components:





Quantity	Item and Part Number	Image
1	eKINO-BT SBC	
2	SATA signal and power cable (P/N: 32801-000201-300-RS)	
1	I/O shielding (P/N: 45014-0052C0-00-RS)	
1	Utility CD	
1	Quick installation guide	

Table 2-1: Packing List

2.4 Optional Items

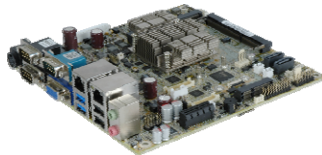
These optional items are available.

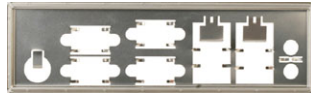
Item and Part Number	Image
12 V, 60 W power adapter (90 V AC ~ 260 V AC, 4-pin DIN) (P/N: 63000-FSP0601AD101C746-RS)	
19 V, 120 W power adapter (90 V AC ~ 264 V AC, 4-pin DIN) (P/N: 63000-FSP120AAB-RS)	
4S2P AUPS battery kit (14.8 V, 3800 mAh) (P/N: BATKIT-4S2P3800-R10)	
4S2P smart battery (14.8 V, 3800 mAh) (P/N: BAT-LI-4S2P3800)	
2S2P AUPS battery kit (7.4 V, 3800 mAh) (P/N: BATKIT-2S2P3800-R10)	
2S2P smart battery (7.4 V, 3800 mAh) (P/N: BAT-LI-2S2P3800)	
RS-422/485 cable (P/N: 32205-003800-300-RS)	
PS/2 keyboard and mouse Y cable (P/N: 32000-023800-RS)	

Table 2-2: Optional Items



NOTE:

The eKINO-BT supports only one LCD when using the optional 7.4 V battery (BATKIT-2S2P3800-R10/BAT-LI-2S2P3800).

Chapter

3

Connectors

3.1 Peripheral Interface Connectors

This chapter details all the peripheral interface connectors.

3.1.1 Layout

The figures below show all the peripheral interface connectors.

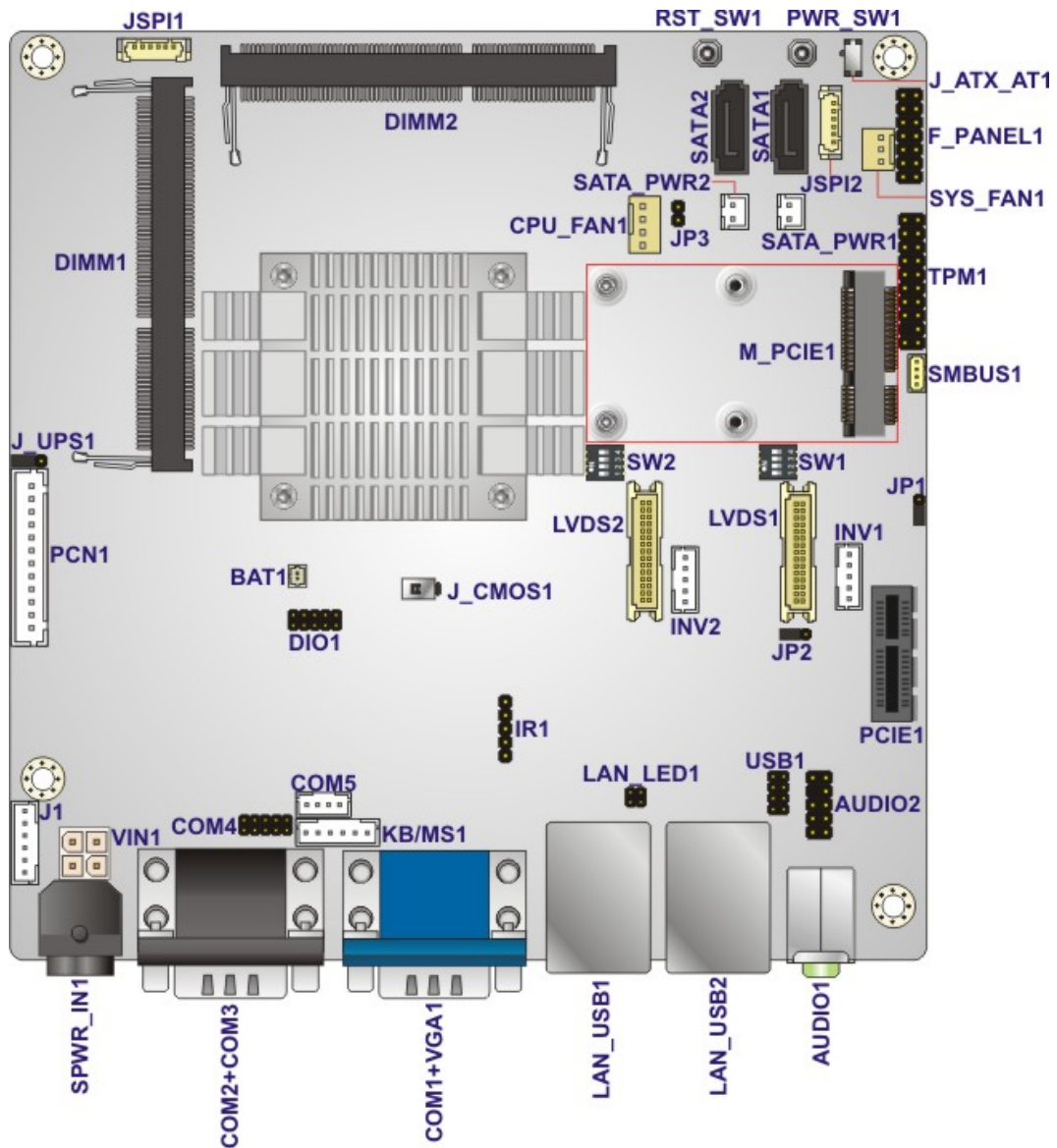

*DIMM2 slot is available for J1900, N2930, E3845, E3827 and E3826 SKUs only.

Figure 3-1: Peripheral Interface Connectors (Front Side)

eKINO-BT Mini-ITX SBC

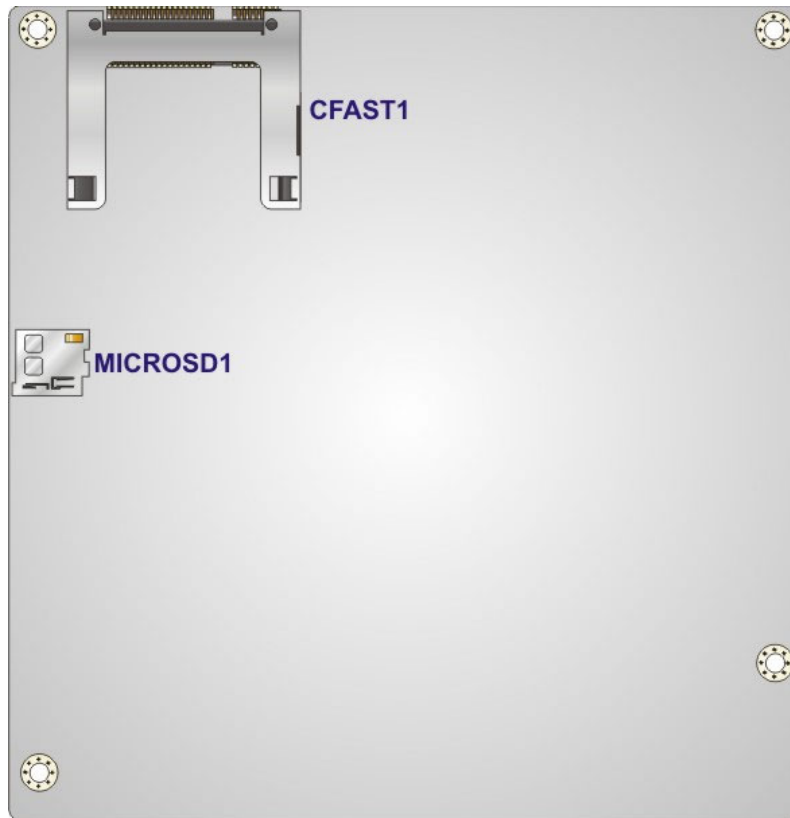

*MICROSD1 slot is available for E38XX SKU only.

Figure 3-2: Peripheral Interface Connectors (Solder Side)

3.1.2 Peripheral Interface Connectors

The table below shows a list of the peripheral interface connectors on the eKINO-BT. Detailed descriptions of these connectors can be found below.

Connector	Type	Label
9 V ~ 26 V power connector	4-pin Molex power connector	VIN1
12-pin battery connector	12-pin wafer	PCN1
Audio connector	10-pin header	AUDIO2
Backlight inverter connectors	5-pin wafer	INV1, INV2
Battery connector	2-pin wafer	BAT1
Battery LED connector	6-pin wafer	J1

Connector	Type	Label
CFAST card slot	CFAST card slot	CFAST1
Digital I/O connector	10-pin header	DIO1
Fan connector (CPU)	4-pin wafer	CPU_FAN1
Fan connector (system)	3-pin wafer	SYS_FAN1
Front panel connector	14-pin header	F_PANEL1
Infrared connector	5-pin header	IR1
Keyboard and mouse connector	6-pin wafer	KB_MS1
LAN active LED connector	4-pin header	LAN_LED1
LVDS connectors	30-pin crimp	LVDS1, LVDS2
microSD card slot	microSD card slot	MICROSD1
PCIe x1 slot	PCIe x1 slot	PCIE1
PCIe Mini card slot	PCIe Mini card slot	M_PCIE1
Power button (on-board)	Push button	PWR_SW1
Reset button (on-board)	Push button	RST_SW1
SATA 3Gb/s connectors	7-pin SATA connector	SATA1, SATA2
SATA power connectors (5 V)	2-pin wafer	SATA_PWR1, SATA_PWR2
Serial port, RS-232	10-pin header	COM4
Serial port, RS-422/485	4-pin wafer	COM5
SMBus connector	4-pin wafer	SMBUS1
SO-DIMM connectors	204-pin DDR3L SO-DIMM connector	DIMM1, DIMM2
SPI flash connector	6-pin wafer	JSPI1
SPI flash connector (EC)	6-pin wafer	JSPI2
TPM connector	20-pin header	TPM1
USB 2.0 connector	8-pin header	USB1

Table 3-1: Peripheral Interface Connectors

eKINO-BT Mini-ITX SBC

3.1.3 External Interface Panel Connectors

The table below lists the rear panel connectors on the eKINO-BT. Detailed descriptions of these connectors can be found in a later section.

Connector	Type	Label
9 V ~ 26 V DC in connector	4-pin mini-DIN	SPWR_IN1
Audio jacks (mic-in, line-out)	Audio jack	AUDIO1
Ethernet and USB 2.0 connectors	RJ-45 and USB 2.0	LAN_USB2
Ethernet and USB 3.0 connectors	RJ-45 and USB 3.0	LAN_USB1
RS-232 serial ports	DB-9	COM1, COM2, COM3
VGA connector	15-pin female	VGA1

Table 3-2: Rear Panel Connectors

3.2 Internal Peripheral Connectors

Internal peripheral connectors are found on the motherboard and are only accessible when the motherboard is outside of the chassis. This section has complete descriptions of all the internal, peripheral connectors on the eKINO-BT.

3.2.1 9 V ~ 26 V Power Connector

- CN Label:** VIN1
- CN Type:** 4-pin Molex power connector
- CN Location:** See **Figure 3-3**
- CN Pinouts:** See **Table 3-3**

This connector provides power to the system.

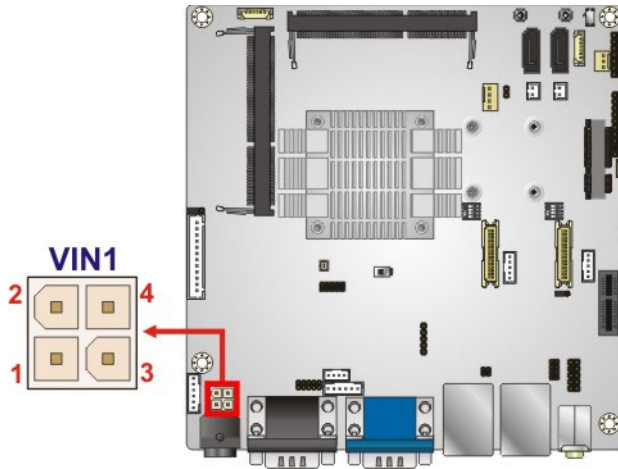

Figure 3-3: 9 V ~ 26 V Power Connector Location

Pin	Description	Pin	Description
1	GND	2	GND
3	Power (9 V ~ 26 V)	4	Power (9 V ~ 26 V)

Table 3-3: 9 V ~ 26 V Power Connector Pinouts

3.2.2 12-pin Battery Connector

- CN Label:** PCN1
- CN Type:** 12-pin connector
- CN Location:** See **Figure 3-4**
- CN Pinouts:** See **Table 3-4**

The 12-pin battery connector allows connection of the AUPS battery. When the AUPS battery is installed to the system, a battery icon will be shown on the Windows notification area.



NOTE:

The eKINO-BT supports only one LCD when using the optional 7.4 V battery (BATKIT-2S2P3800-R10/BAT-LI-2S2P3800).

eKINO-BT Mini-ITX SBC

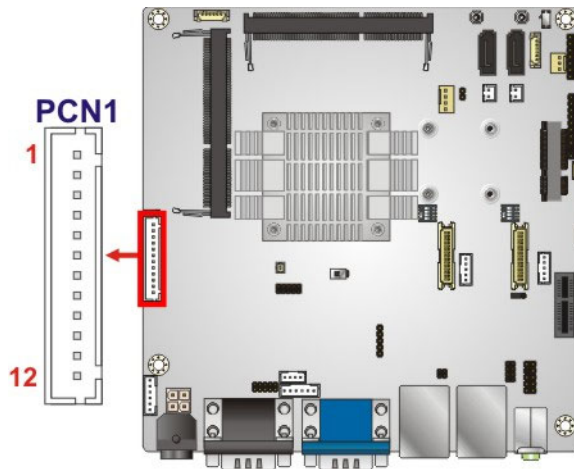

Figure 3-4: 12-pin Battery Connector Location

Pin	Description
1	VBAT
2	VBAT
3	VBAT
4	VBAT
5	BAT_SMBCLK
6	BAT_SMBDATA
7	BAT_TH
8	BAT ID
9	GND
10	GND
11	GND
12	GND

Table 3-4: 12-pin Battery Connector Pinouts

3.2.3 Audio Connector

- CN Label:** AUDIO2
- CN Type:** 10-pin header
- CN Location:** See **Figure 3-5**
- CN Pinouts:** See **Table 3-5**

This connector connects to speakers, a microphone and an audio input.

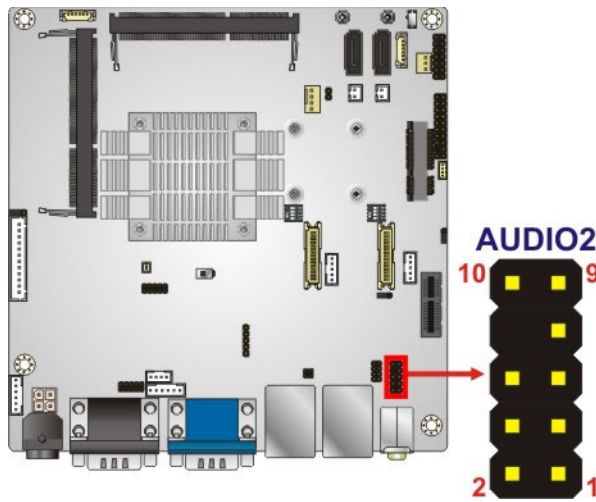

Figure 3-5: Audio Connector Location

Pin	Description	Pin	Description
1	LMIC2-L	2	ANALOG GND
3	LMIC2-R	4	PRESENCE#
5	LLINE2-R	6	MIC2-JD
7	FRONT-IO	8	NC
9	LLINE2-L	10	LINE2-JD

Table 3-5: Audio Connector Pinouts

3.2.4 Backlight Inverter Connectors

- CN Label:** INV1, INV2
- CN Type:** 5-pin wafer
- CN Location:** See **Figure 3-6**
- CN Pinouts:** See **Table 3-6**

Each backlight inverter connector provides power to an LCD panel.

eKINO-BT Mini-ITX SBC

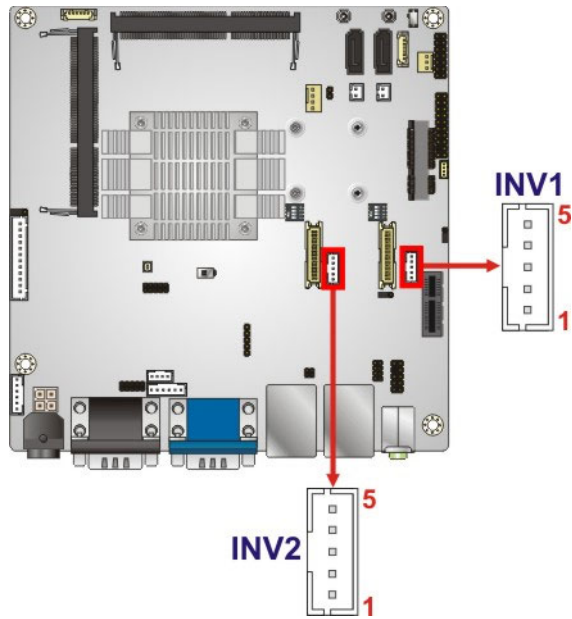

Figure 3-6: Backlight Inverter Connector Locations

Pin	Description
1	LCD_BKLTCTL
2	GROUND
3	+12V
4	GROUND
5	BACKLIGHT ENABLE

Table 3-6: Backlight Inverter Connector Pinouts

3.2.5 Battery Connector



CAUTION:

Risk of explosion if battery is replaced by an incorrect type. Only certified engineers should replace the on-board battery.

Dispose of used batteries according to instructions and local regulations.

- CN Label:** **BAT1**
- CN Type:** 2-pin wafer
- CN Location:** See **Figure 3-7**
- CN Pinouts:** See **Table 3-7**

This is connected to the system battery. The battery provides power to the system clock to retain the time when power is turned off.

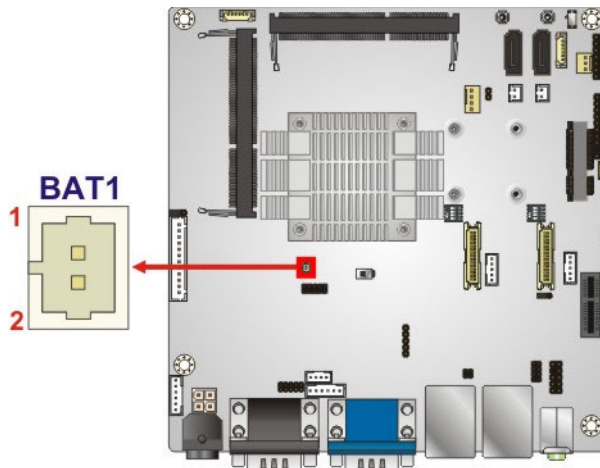

Figure 3-7: Battery Connector Location

Pin	Description
1	VBATT
2	GND

Table 3-7: Battery Connector Pinouts

3.2.6 Battery LED Connector

- CN Label:** **J1**
- CN Type:** 6-pin wafer
- CN Location:** See **Figure 3-8**
- CN Pinouts:** See **Table 3-8**

The LED connector connects to LED indicators showing the status of the connected battery kit.

eKINO-BT Mini-ITX SBC

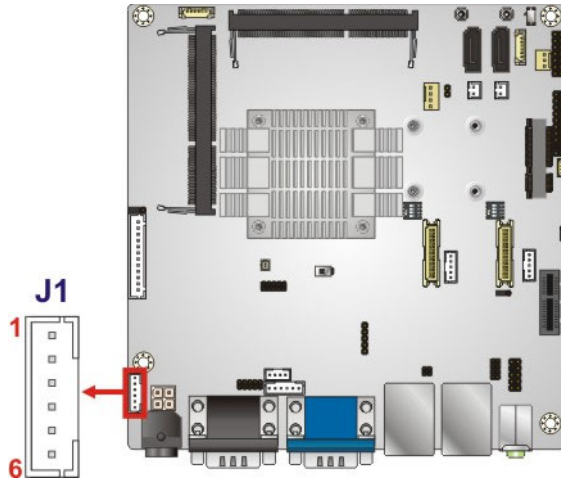

Figure 3-8: Battery LED Connector Location

Pin	Description
1	VCC5
2	DISCHARGING LED
3	VCC5
4	CHARGING LED
5	VCC5
6	DC IN LED

Table 3-8: Battery LED Connector Pinouts

3.2.7 CFAST Card Slot

CN Label: CFAST1

CN Type: CFAST card slot

CN Location: See **Figure 3-9**

The CFAST card slot is for installing a CFAST card to the system.

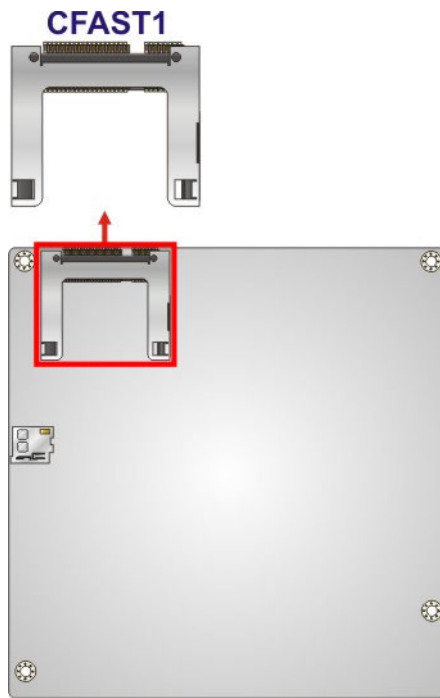

Figure 3-9: CFast Card Slot Location

3.2.8 Digital I/O Connector

- CN Label:** DIO1
- CN Type:** 10-pin header
- CN Location:** See **Figure 3-10**
- CN Pinouts:** See **Table 3-9**

The digital I/O connector provides programmable input and output for external devices.

eKINO-BT Mini-ITX SBC

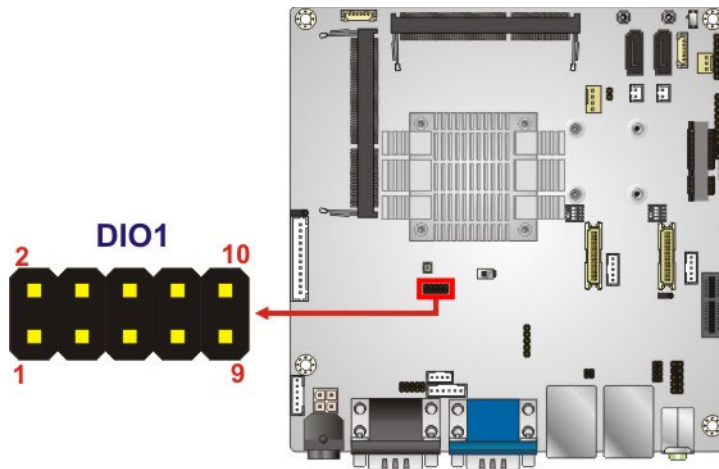

Figure 3-10: Digital I/O Connector Location

Pin	Description	Pin	Description
1	GND	2	+V5S
3	Output 3	4	Output 2
5	Output 1	6	Output 0
7	Input 3	8	Input 2
9	Input 1	10	Input 0

Table 3-9: Digital I/O Connector Pinouts

3.2.9 Fan Connector (CPU)

- CN Label:** CPU_FAN1
- CN Type:** 4-pin wafer
- CN Location:** See **Figure 3-11**
- CN Pinouts:** See **Table 3-10**

The fan connector attaches to a CPU cooling fan.

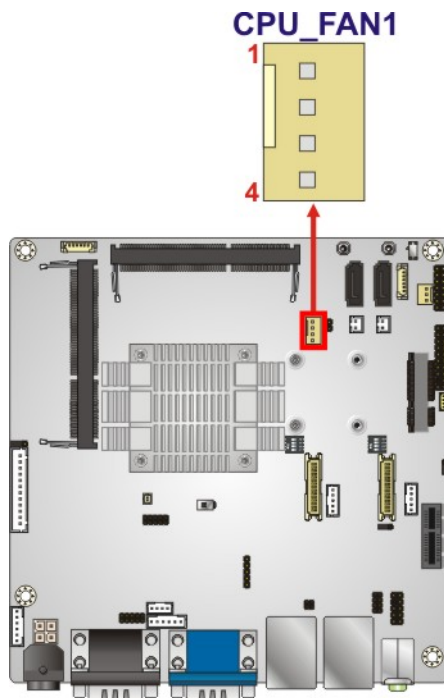

Figure 3-11: CPU Fan Connector Location

Pin	Description
1	GND
2	+V12S
3	Rotation Signal
4	PWM Control Signal

Table 3-10: CPU Fan Connector Pinouts

3.2.10 Fan Connector (System)

- CN Label:** SYS_FAN1
- CN Type:** 3-pin wafer
- CN Location:** See **Figure 3-12**
- CN Pinouts:** See **Table 3-11**

The fan connector attaches to a system cooling fan.

eKINO-BT Mini-ITX SBC

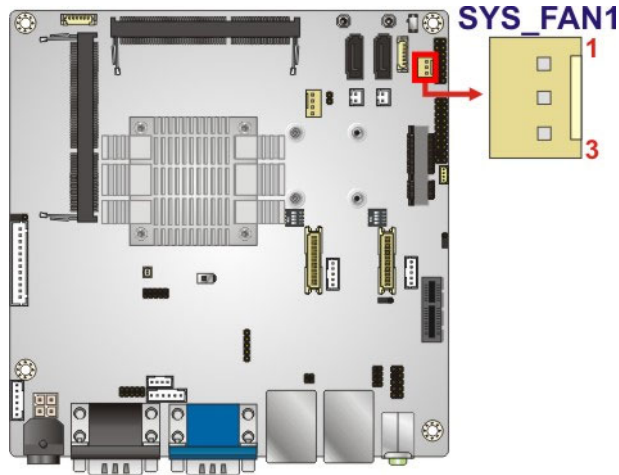

Figure 3-12: System Fan Connector Location

Pin	Description
1	Rotation Signal
2	+12V
3	GND

Table 3-11: System Fan Connector Pinouts

3.2.11 Front Panel Connector

- CN Label:** F_PANEL1
- CN Type:** 14-pin header
- CN Location:** See **Figure 3-13**
- CN Pinouts:** See **Table 3-12**

The front panel connector connects to the indicator LEDs and buttons on the computer's front panel.

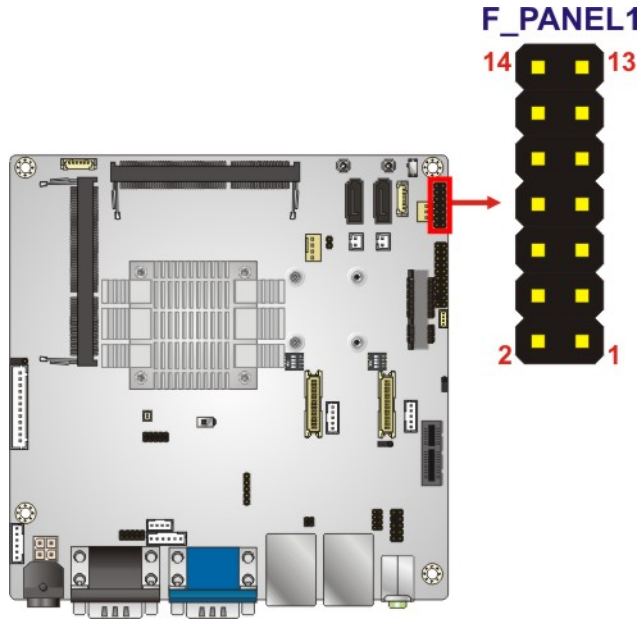

Figure 3-13: Front Panel Connector Location

Function	Pin	Description	Function	Pin	Description
Power LED	1	LED_PWR	Buzzer	2	BEEP_PWR
	3	NC		4	NC
	5	GND		6	NC
Power Button	7	PWR_BTN		8	PC_BEEP#
	9	GND	Reset	10	NC
HDD LED	11	HDD_LED+		12	RESET
	13	HDD_LED-		14	GND

Table 3-12: Front Panel Connector Pinouts

3.2.12 Infrared Interface Connector

- CN Label:** IR1
- CN Type:** 5-pin header
- CN Location:** See **Figure 3-14**
- CN Pinouts:** See **Table 3-13**

The infrared connector attaches to an infrared receiver for use with remote controls.

eKINO-BT Mini-ITX SBC

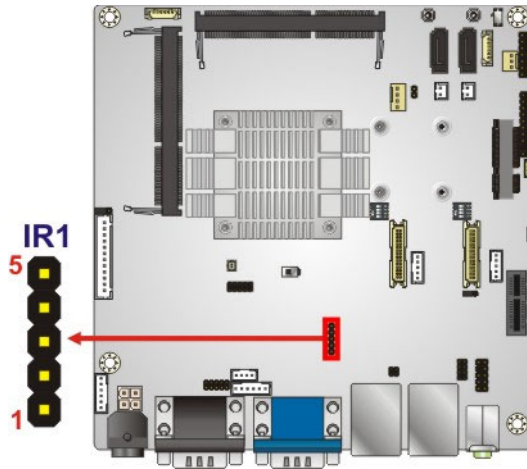

Figure 3-14: Infrared Connector Location

Pin	Description
1	+V5X
2	NC
3	IR-RX
4	GND
5	IR-TX

Table 3-13: Infrared Connector Pinouts

3.2.13 Keyboard and Mouse Connector

CN Label: KB_MS1

CN Type: 6-pin wafer

CN Location: See **Figure 3-15**

CN Pinouts: See **Table 3-14**

The keyboard and mouse connector connects to a PS/2 Y-cable that can be connected to a PS/2 keyboard and mouse.

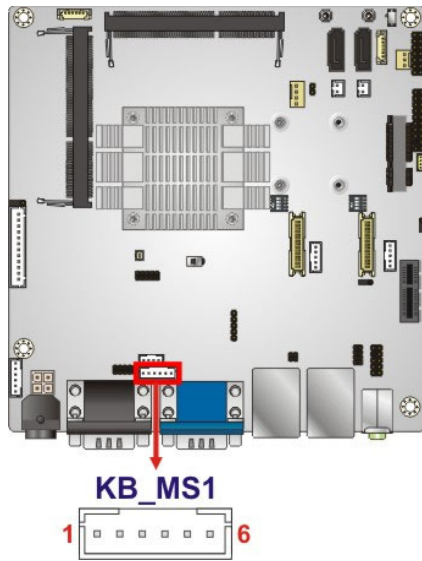

Figure 3-15: Keyboard and Mouse Connector Location

Pin	Description
1	VCC5_KBMS
2	Mouse Data
3	Mouse Clock
4	Keyboard Data
5	Keyboard Clock
6	GND

Table 3-14: Keyboard and Mouse Connector Pinouts

3.2.14 LAN Active LED Connector

CN Label: LAN_LED1

CN Type: 4-pin header

CN Location: See **Figure 3-16**

CN Pinouts: See **Table 3-15**

The LAN active LED connector is used to connect to the LAN LED indicators on the chassis to indicate users the link activities of the two LAN ports.

eKINO-BT Mini-ITX SBC

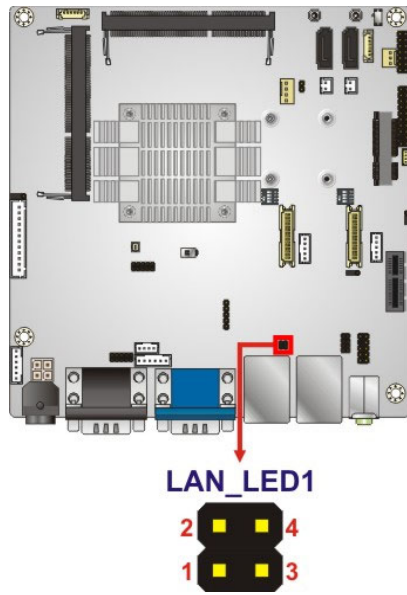

Figure 3-16: LAN Active LED Connector Location

Pin	Description
1	LAN1 LED LINK_ACT-
2	+V3.3LAN
3	LAN2 LED LINK_ACT-
4	+V3.3LAN

Table 3-15: LAN Active LED Connector Pinouts

3.2.15 LVDS Connectors

CN Label: LVDS1, LVDS2

CN Type: 30-pin crimp

CN Location: See Figure 3-17

CN Pinouts: See Table 3-16

The LVDS connectors are for LCD panels connected to the board.



NOTE:

The eKINO-BT supports only one LCD when using the optional 7.4 V battery (BATKIT-2S2P3800-R10/BAT-LI-2S2P3800)

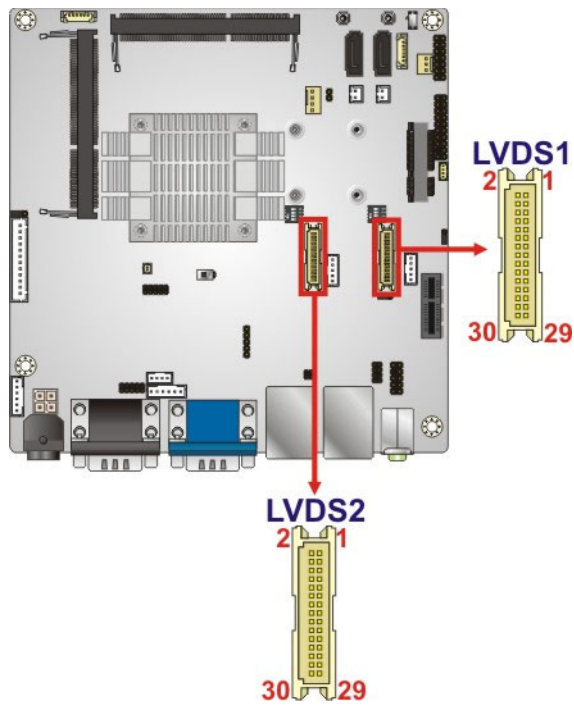

Figure 3-17: LVDS Connector Locations

Pin	Description	Pin	Description
1	GND	2	GND
3	LVDS_A_TX0-P	4	LVDS_A_TX0-N
5	LVDS_A_TX1-P	6	LVDS_A_TX1-N
7	LVDS_A_TX2-P	8	LVDS_A_TX2-N
9	LVDS_A_TXCLK-P	10	LVDS_A_TXCLK-N
11	LVDS_A_TX3-P	12	LVDS_A_TX3-N
13	GND	14	GND
15	LVDS_B_TX0-P	16	LVDS_B_TX0-N
17	LVDS_B_TX1-P	18	LVDS_B_TX1-N
19	LVDS_B_TX2-P	20	LVDS_B_TX2-N
21	LVDS_B_TXCLK-P	22	LVDS_B_TXCLK-N
23	LVDS_B_TX3-P	24	LVDS_B_TX3-N
25	GND	26	GND
27	+LCD Vcc	28	+LCD Vcc
29	+LCD Vcc	30	+LCD Vcc

Table 3-16: LVDS Connector Pinouts

eKINO-BT Mini-ITX SBC

3.2.16 microSD Card Slot (E38XX SKU Only)

CN Label: MICROSD1
CN Type: microSD card slot
CN Location: See **Figure 3-18**

The microSD card slot is for installing a microSD card to the system.

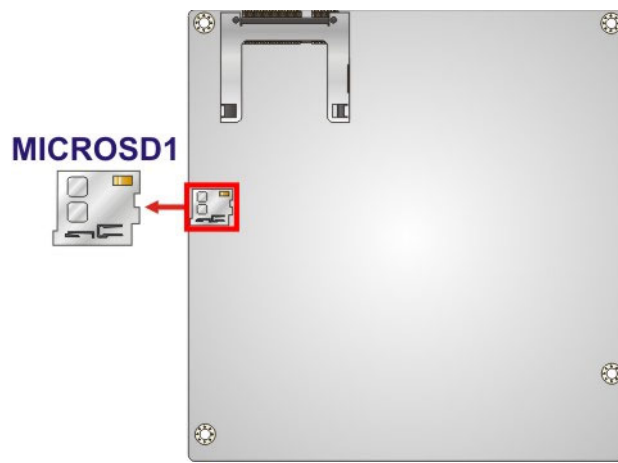

Figure 3-18: microSD Card Slot Location

3.2.17 PCIe x1 Slot

CN Label: PCIE1
CN Type: PCIe x1 slot
CN Location: See **Figure 3-19**

The PCIe x1 slot is for installing a PCIe x1 expansion card.

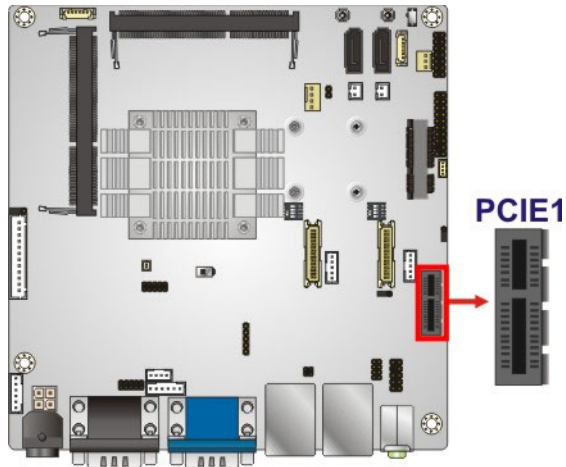

Figure 3-19: PCIe x1 Slot Location

3.2.18 PCIe Mini Card Slot

- CN Label:** M_PCIE1
- CN Type:** PCIe Mini card slot
- CN Location:** See **Figure 3-20**
- CN Pinouts:** See **Table 3-17**

The PCIe Mini card slot enables a full-size/half-size PCIe Mini card expansion module to be connected to the board.

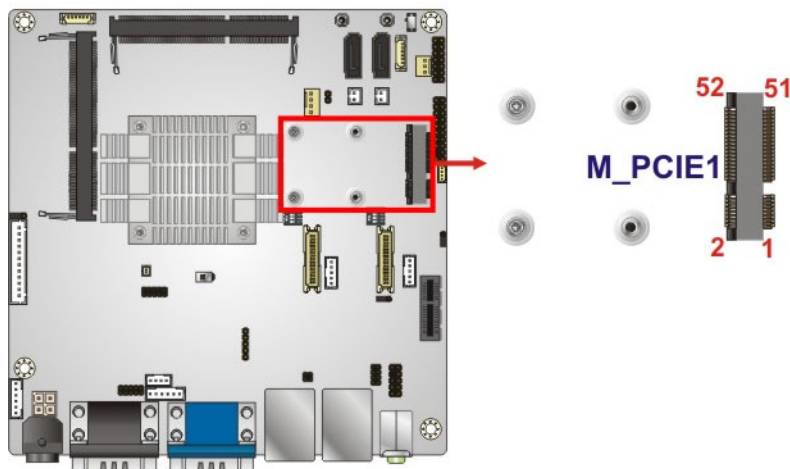

Figure 3-20: PCIe Mini Card Slot Location

eKINO-BT Mini-ITX SBC

Pin	Description	Pin	Description
1	PCIE_WAKE#	2	VCC3
3	N/C	4	GND
5	N/C	6	1.5V
7	N/C	8	N/C
9	GND	10	N/C
11	CLK-	12	N/C
13	CLK+	14	N/C
15	GND	16	N/C
17	PCIRST#	18	GND
19	N/C	20	VCC3
21	GND	22	PCIRST#
23	PERN2	24	3VDual
25	PERP2	26	GND
27	GND	28	1.5V
29	GND	30	SMBCLK
31	PETN2	32	SMBDATA
33	PETP2	34	GND
35	GND	36	USB D-
37	N/C	38	USB D+
39	N/C	40	GND
41	N/C	42	N/C
43	N/C	44	N/C
45	N/C	46	N/C
47	N/C	48	1.5V
49	N/C	50	GND
51	N/C	52	VCC3

Table 3-17: PCIe Mini Card Slot Pinouts

3.2.19 Power Button (On-board)

CN Label: PWR_SW1
CN Type: Push button
CN Location: See **Figure 3-21**

Push the on-board power button to power on the eKINO-BT.

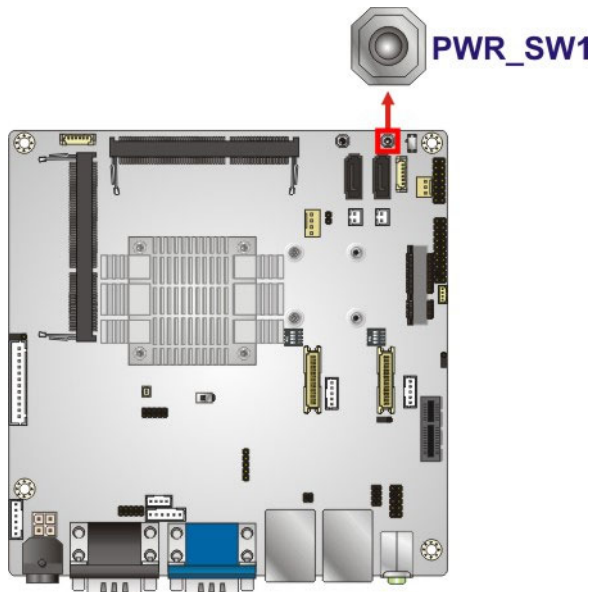

Figure 3-21: On-board Power Button Location

3.2.20 Reset Button (On-board)

CN Label: RST_SW1
CN Type: Push button
CN Location: See **Figure 3-22**

Push the on-board reset button to reset the eKINO-BT.

eKINO-BT Mini-ITX SBC

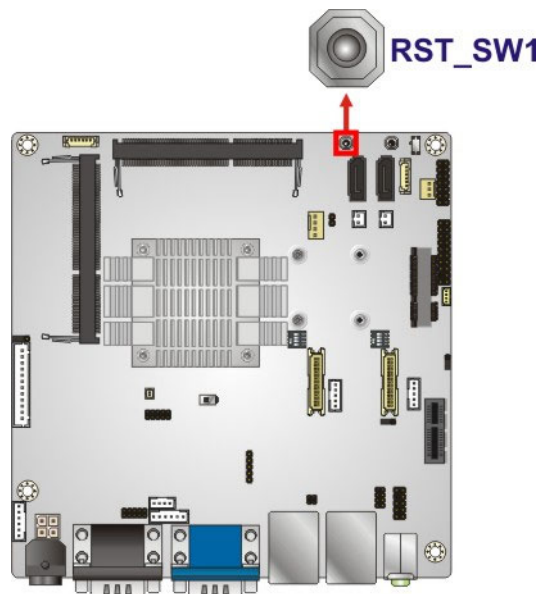

Figure 3-22: On-board Reset Button Location

3.2.21 SATA 3Gb/s Drive Connectors

CN Label:	SATA1, SATA2
CN Type:	7-pin SATA connector
CN Location:	See Figure 3-23
CN Pinouts:	See Table 3-18

The SATA drive connectors can be connected to SATA drives and support up to 3Gb/s data transfer rate.

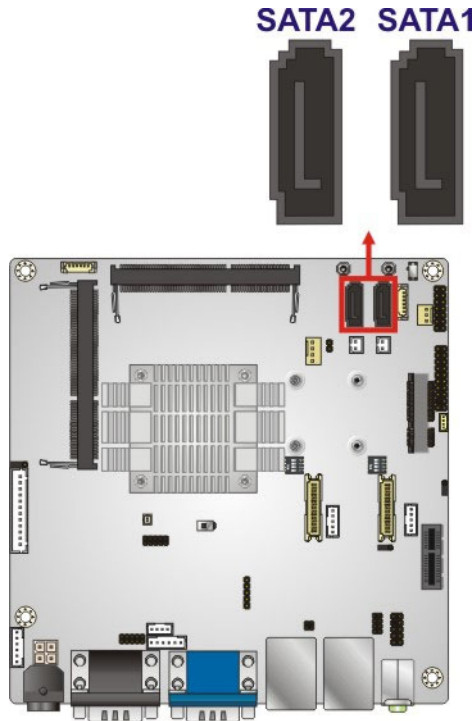

Figure 3-23: SATA 3Gb/s Drive Connector Locations

Pin	Description
1	GND
2	TX+
3	TX-
4	GND
5	RX-
6	RX+
7	GND

Table 3-18: SATA 3Gb/s Drive Connector Pinouts

eKINO-BT Mini-ITX SBC

3.2.22 SATA Power Connectors (5 V)

CN Label: SATA_PWR1, SATA_PWR2

CN Type: 2-pin wafer

CN Location: See **Figure 3-24**

CN Pinouts: See **Table 3-19**

Use the SATA power connector to connect to SATA device power connections.

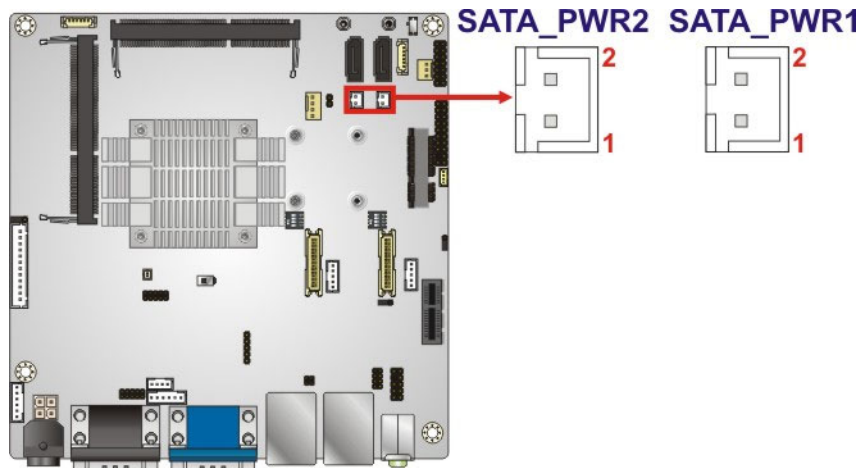

Figure 3-24: 5 V SATA Power Connector Locations

Pin	Description
1	+V5S
2	GND

Table 3-19: 5 V SATA Power Connector Pinouts

3.2.23 Serial Port Connector, RS-232

CN Label: COM4

CN Type: 10-pin header

CN Location: See **Figure 3-25**

CN Pinouts: See **Table 3-20**

The 10-pin serial port connector provides one RS-232 serial communications channel.

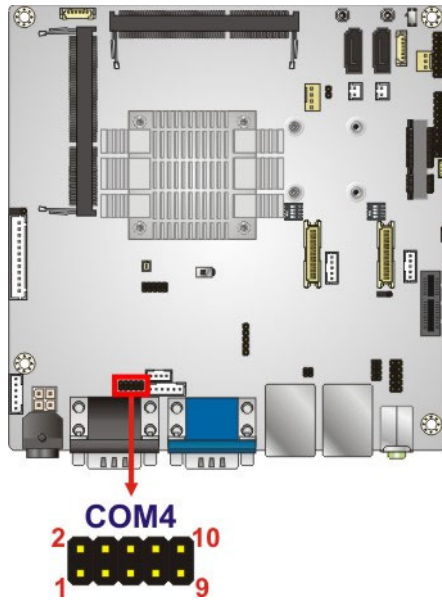

Figure 3-25: RS-232 Serial Port Connector Location

Pin	Description	Pin	Description
1	-NDCD2	2	-NDSRs
3	NSIN2	4	-NRTS2
5	NSOUT2	6	-NCTS2
7	-NDTR2	8	-XRI2
9	GND	10	GND

Table 3-20: RS-232 Serial Port Connector Pinouts

3.2.24 Serial Port Connector, RS-422/485

- CN Label:** COM5
- CN Type:** 4-pin wafer
- CN Location:** See **Figure 3-26**
- CN Pinouts:** See **Table 3-21**

This connector provides RS-422 or RS-485 communications.

eKINO-BT Mini-ITX SBC

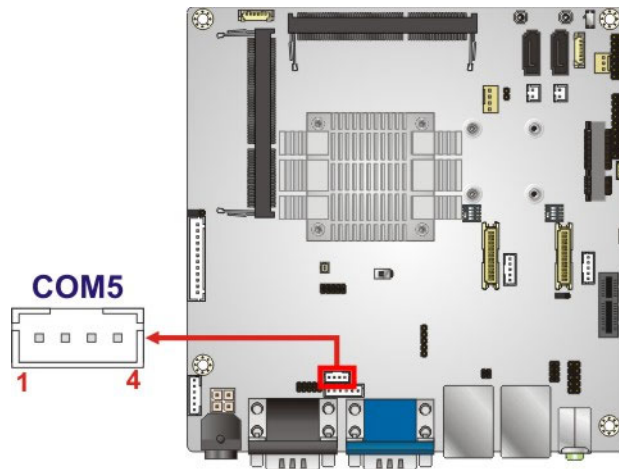

Figure 3-26: RS-422/485 Serial Port Connector Location

Pin	Description
1	RXD422-
2	RXD422+
3	TXD422+/TXD485+
4	TXD422-/TXD485-

Table 3-21: RS-422/485 Serial Port Connector Pinouts

Use the optional RS-422/485 cable to connect to a serial device. The pinouts of the DB-9 connector are listed below.

RS-422 Pinouts	RS-485 Pinouts

Table 3-22: DB-9 RS-422/485 Pinouts

3.2.25 SMBus Connector

- CN Label:** SMBUS1
- CN Type:** 4-pin wafer
- CN Location:** See **Figure 3-27**
- CN Pinouts:** See **Table 3-23**

The SMBus (System Management Bus) connector provides low-speed system management communications.

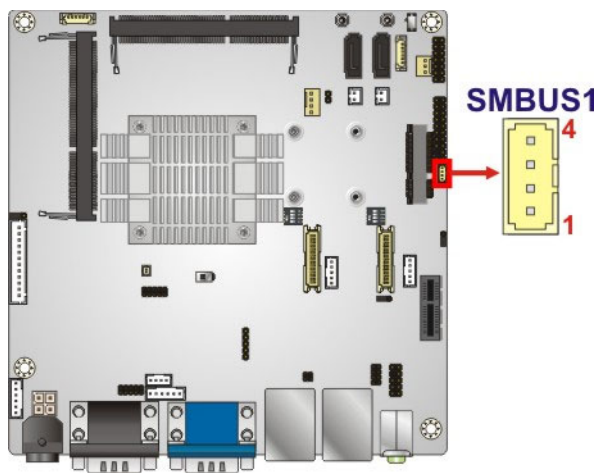

Figure 3-27: SMBus Connector Location

Pin	Description
1	GND
2	SMB_DATA
3	SMB_CLK
4	+V5S

Table 3-23: SMBus Connector Pinouts

3.2.26 SO-DIMM Connectors

- CN Label:** DIMM1, DIMM2
- CN Type:** 204-pin DDR3L SO-DIMM connector
- CN Location:** See **Figure 3-28**

eKINO-BT Mini-ITX SBC

The SO-DIMM connectors are for installing SO-DIMMs on the system.



NOTE:

Use **DIMM1** slot when installing one SO-DIMM.

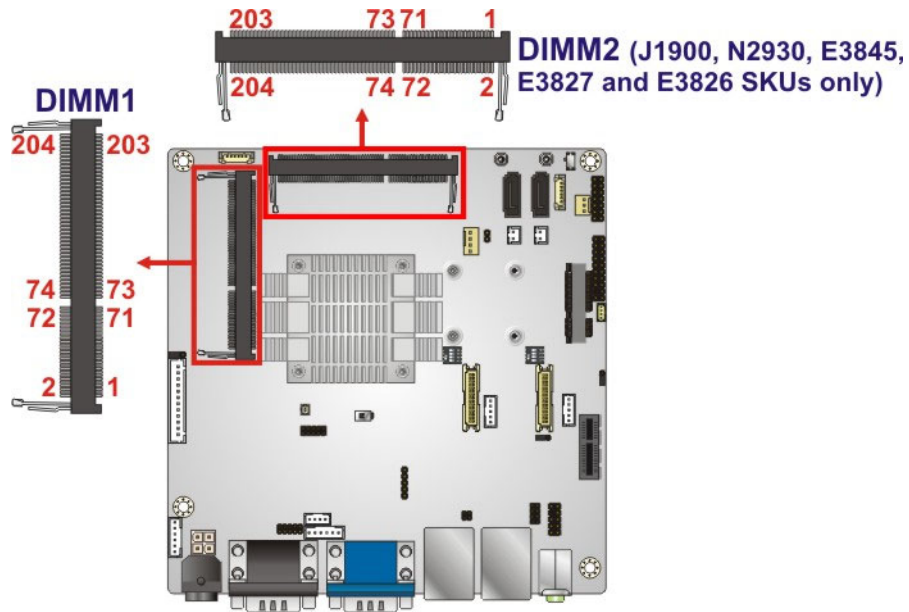

Figure 3-28: SO-DIMM Connector Locations

3.2.27 SPI Flash Connector

- CN Label:** JSPI1
- CN Type:** 6-pin wafer
- CN Location:** See **Figure 3-29**
- CN Pinouts:** See **Table 3-24**

The SPI flash connector is used to flash the SPI ROM.

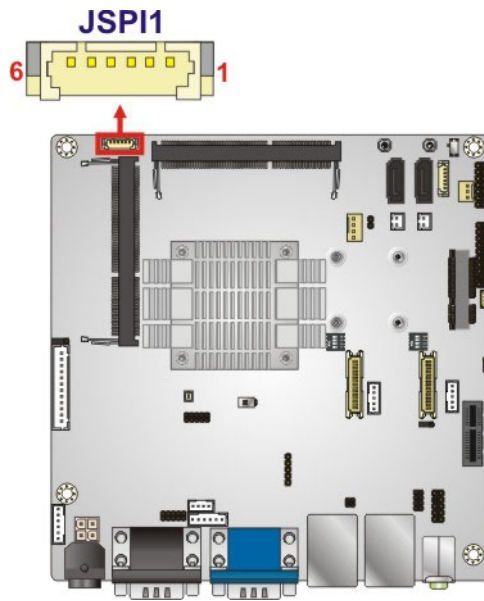

Figure 3-29: SPI Flash Connector Location

Pin	Description
1	+V3.3M_SPI_CON
2	SPI_CS
3	SPI_SO_SW
4	SPI_CLK_SW
5	SPI_SI_SW
6	GND

Table 3-24: SPI Flash Connector Pinouts

3.2.28 SPI Flash Connector (EC)

- CN Label:** JSPI2
- CN Type:** 6-pin wafer
- CN Location:** See **Figure 3-30**
- CN Pinouts:** See **Table 3-25**

The SPI flash connector is used to flash the EC ROM.

eKINO-BT Mini-ITX SBC

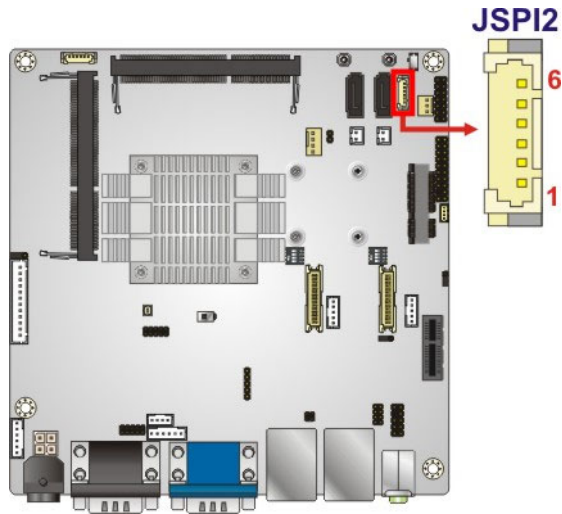

Figure 3-30: EC SPI Flash Connector Location

Pin	Description
1	+V3.3M_SPI_CON_EC
2	SPI_CS_EC
3	SPI_SO_SW_EC
4	SPI_CLK_SW_EC
5	SPI_SI_SW_EC
6	GND

Table 3-25: EC SPI Flash Connector Pinouts

3.2.29 TPM Connector

- CN Label:** TPM1
- CN Type:** 20-pin header
- CN Location:** See **Figure 3-31**
- CN Pinouts:** See **Table 3-26**

The TPM connector connects to a TPM module.

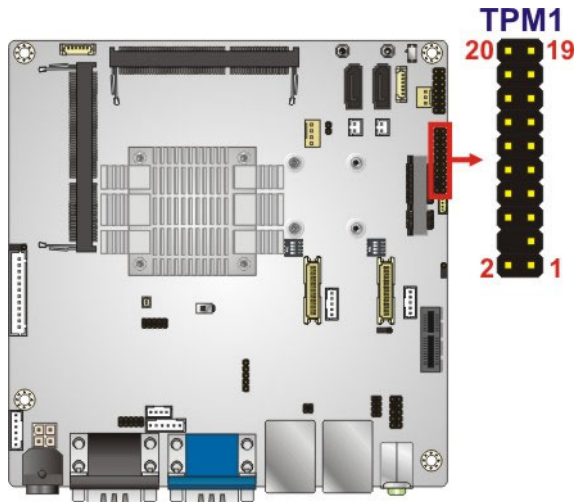

Figure 3-31: TPM Connector Location

Pin	Description	Pin	Description
1	LCLK	2	GND
3	LFRAME#	4	KEY
5	LRERST#	6	+5V
7	LAD3	8	LAD2
9	+3V	10	LAD1
11	LAD0	12	GND
13	SCL	14	SDA
15	SB3V	16	SERIRQ
17	GND	18	GLKRUN#
19	LPCPD#	20	LDRQ#

Table 3-26: TPM Connector Pinouts

3.2.30 USB 2.0 Connector

- CN Label:** USB1
- CN Type:** 8-pin header
- CN Location:** See **Figure 3-32**
- CN Pinouts:** See **Table 3-27**

The USB header can connect to two USB 2.0 devices.

eKINO-BT Mini-ITX SBC

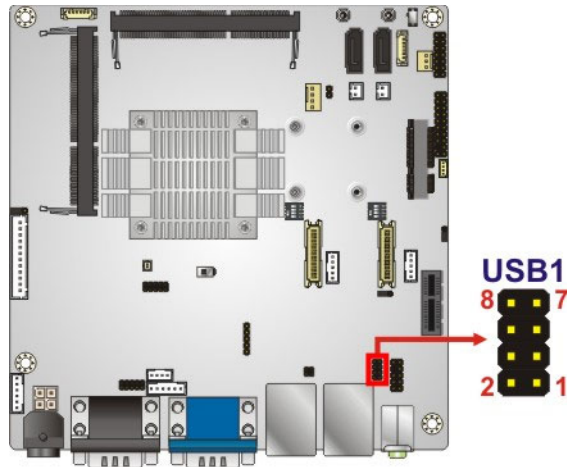

Figure 3-32: USB Connector Location

Pin	Description	Pin	Description
1	VCC	2	GND
3	DATA-	4	DATA+
5	DATA+	6	DATA-
7	GND	8	VCC

Table 3-27: USB 2.0 Port Connector Pinouts

3.3 External Interface Connectors

The figure below shows the external peripheral interface connector (EPIC) panel. The EPIC panel consists of the following:

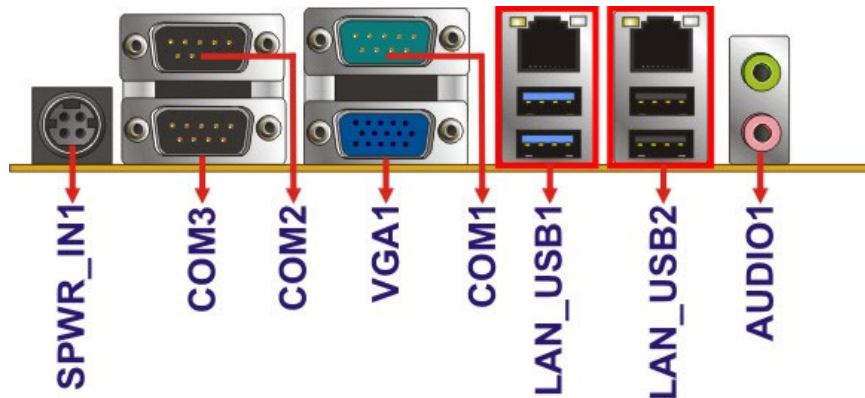

Figure 3-33: External Interface Connectors

3.3.1 9 V ~ 26 V DC In Connector

- CN Label:** SPWR_IN1
- CN Type:** 4-pin mini-DIN
- CN Location:** See **Figure 3-33**
- CN Pinouts:** See **Table 3-36**

The power connector connects to the 9 V ~ 26 V DC power adapter.

Pin	Description	Pin	Description
1	Power (9 V ~ 26 V)	2	GND
3	Power (9 V ~ 26 V)	4	GND

Table 3-28: 9 V ~ 26 V DC In Connector Pinouts

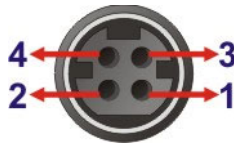

Figure 3-34: 9 V ~ 26 V DC In Connector

3.3.2 Audio Jacks

- CN Label:** AUDIO1
- CN Type:** Audio jack
- CN Location:** See **Figure 3-33**

The audio jacks connect to external audio devices.

- **Line Out port (Lime):** Connects to a headphone or a speaker. With multi-channel configurations, this port can also connect to front speakers.
- **Microphone (Pink):** Connects a microphone.



Figure 3-35: Audio Jacks

eKINO-BT Mini-ITX SBC

3.3.3 Ethernet and USB 2.0 Connectors

- CN Label:** LAN_USB2
- CN Type:** RJ-45 and USB 2.0 connector
- CN Location:** See **Figure 3-33**
- CN Pinouts:** See **Table 3-29** and **Table 3-31**

The Ethernet connector connects to a local network.

Pin	Description	Pin	Description
1	MD0+	2	MD0-
3	MD1+	4	MD1-
5	MD2+	6	MD2-
7	MD3+	8	MD3-
9	VCC	10	GND
11	LINK_ACT+	12	LINK_ACT-
13	100-	14	1000-
15	GND		

Table 3-29: LAN Pinouts

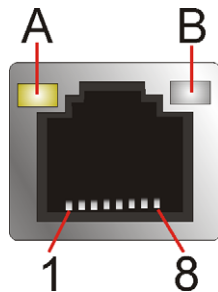

Figure 3-36: Ethernet Connector

LED	Description	LED	Description
A	on: linked blinking: data is being sent/received	B	off: 10 Mb/s green: 100 Mb/s orange: 1000 Mb/s

Table 3-30: Ethernet Connector LEDs

The eKINO-BT has two external USB 2.0 ports.

Pin	Description
1	VBUS
2	D1-
3	D1+
4	GND

Table 3-31: External USB 2.0 Port Pinouts

3.3.4 Ethernet and USB 3.0 Connectors

- CN Label:** LAN_USB1
- CN Type:** RJ-45 and USB 3.0 connector
- CN Location:** See **Figure 3-33**
- CN Pinouts:** See **Table 3-32** and **Table 3-34**

The LAN connector connects to a local network.

Pin	Description	Pin	Description
1	MD0+	2	MD0-
3	MD1+	4	MD1-
5	MD2+	6	MD2-
7	MD3+	8	MD3-
9	VCC	10	GND
11	LINK_ACT+	12	LINK_ACT-
13	100-	14	1000-
15	GND		

Table 3-32: LAN Pinouts

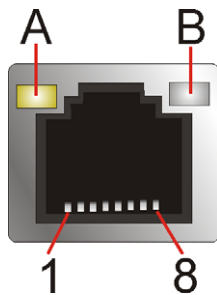

Figure 3-37: Ethernet Connector

eKINO-BT Mini-ITX SBC

LED	Description	LED	Description
A	on: linked blinking: data is being sent/received	B	off: 10 Mb/s green: 100 Mb/s orange: 1000 Mb/s

Table 3-33: Ethernet Connector LEDs

The eKINO-BT has two external USB 3.0 ports.

Pin	Description
1	VBUS
2	D1-
3	D1+
4	GND1
5	STDA_SSRX1_N
6	STDA_SSRX1_P
7	GND_DRAIN
8	STDA_SSTX1_N
9	STDA_SSTX1_P

Table 3-34: External USB 3.0 Port Pinouts

3.3.5 Serial Port Connectors

CN Label: COM1, COM2, COM3

CN Type: DB-9

CN Location: See **Figure 3-33**

CN Pinouts: See **Table 3-35** and **Figure 3-38**

Each of the serial port connects to a RS-232 serial communication device.

Pin	Description	Pin	Description
1	DATA CARRIER DETECT (DCD1)	6	DATA SET READY (DSR1)
2	RECEIVE DATA (RXD1)	7	REQUEST TO SEND (RTS1)
3	TRANSMIT DATA (TXD1)	8	CLEAR TO SEND (CTS1)

Pin	Description	Pin	Description
4	DATA TERMINAL READY (DTR1)	9	RING INDICATOR (RI1)
5	GND		

Table 3-35: Serial Port Pinouts

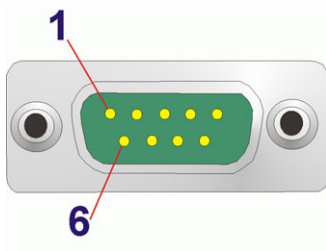

Figure 3-38: Serial Port Pinouts

3.3.6 VGA Connector

- CN Label:** VGA1
- CN Type:** 15-pin female
- CN Location:** See **Figure 3-33**
- CN Pinouts:** See **Table 3-36** and **Figure 3-39**

The VGA connector connects to a monitor that accepts a standard VGA input.

Pin	Description	Pin	Description
1	RED	2	GREEN
3	BLUE	4	NC
5	GND	6	GND
7	GND	8	GND
9	VGAVCC	10	GND
11	NC	12	DDCDAT
13	HSYNC	14	VSYNC
15	DDCCLK		

Table 3-36: VGA Connector Pinouts

eKINO-BT Mini-ITX SBC

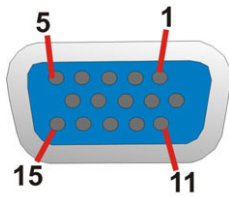

Figure 3-39: VGA Connector

**NOTE:**

After installing Intel® graphics driver, the two LVDS ports will be set to the primary display output ports and the VGA port will be disabled. The reason for this is the eKINO-BT uses two CH7511B chips to convert DP to LVDS and Intel® graphics driver recognizes the chips and the two LVDS ports as two devices. In addition, the on-board processor only supports dual display output, therefore, the display devices can only be connected to the two LVDS ports, not the VGA port.

If there is a need to change the display output port or set to VGA port only, please contact IEI for BIOS customization.

Chapter

4

Installation

eKINO-BT Mini-ITX SBC

4.1 Anti-static Precautions



WARNING:

Failure to take ESD precautions during installation may result in permanent damage to the product and severe injury to the user.

Electrostatic discharge (ESD) can cause serious damage to electronic components, including the eKINO-BT. Dry climates are especially susceptible to ESD. It is therefore critical to strictly adhere to the following anti-static precautions whenever the eKINO-BT, or any other electrical component, is handled.

- **Wear an anti-static wristband:** - Wearing a simple anti-static wristband can help to prevent ESD from damaging the board.
- **Self-grounding:**- Before handling the board touch any grounded conducting material. During the time the board is handled, frequently touch any conducting materials that are connected to the ground.
- **Use an anti-static pad:** When configuring the eKINO-BT, place it on an anti-static pad. This reduces the possibility of ESD damaging the eKINO-BT.
- **Only handle the edges of the PCB:-:** When handling the PCB, hold it by the edges.

4.2 Installation Considerations



NOTE:

The following installation notices and installation considerations should be read and understood before the eKINO-BT is installed. All installation notices pertaining to the installation of eKINO-BT should be strictly adhered to. Failing to adhere to these precautions may lead to severe damage of the eKINO-BT and injury to the person installing the motherboard.

**WARNING:**

The installation instructions described in this manual should be carefully followed in order to prevent damage to the eKINO-BT, eKINO-BT components and injury to the user.

Before and during the installation please **DO** the following:

- **Read the user manual:**
 - The user manual provides a complete description of the installation instructions and configuration options.
- **Wear an electrostatic discharge cuff (ESD):**
 - Electronic components are easily damaged by ESD. Wearing an ESD cuff removes ESD from the body and helps prevent ESD damage.
- **Place on an anti-static pad:**
 - When installing or configuring the motherboard, place it on an anti-static pad. This helps to prevent potential ESD damage.
- **Turn all power off:**
 - Make sure the product is disconnected from all power supplies and that no electricity is being fed into the system.

Before and during the installation of the eKINO-BT, **DO NOT:**

- Remove any of the stickers on the PCB board. These stickers are required for warranty validation.
- Use the product before verifying all the cables and power connectors are properly connected.
- Allow screws to come in contact with the PCB circuit, connector pins, or its components.

eKINO-BT Mini-ITX SBC

4.3 SO-DIMM Installation

To install a SO-DIMM, please follow the steps below and refer to **Figure 4-1**.



NOTE:

Use **DIMM1** slot when installing one SO-DIMM. For the SO-DIMM slot location, refer to **Figure 3-28**.

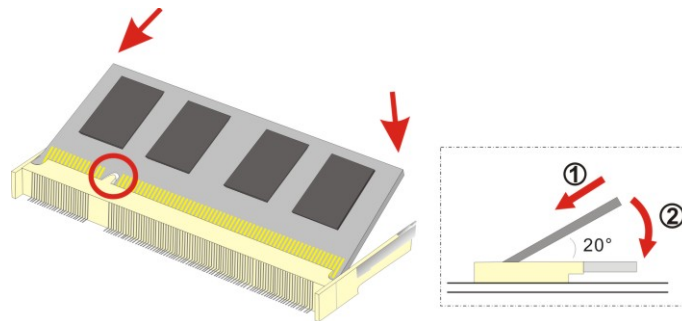

Figure 4-1: SO-DIMM Installation

- Step 1:** Locate the **SO-DIMM socket** on the solder side of the eKINO-BT. Place the board on an anti-static mat.
- Step 2:** Align the **SO-DIMM with the socket**. Align the notch on the memory with the notch on the memory socket.
- Step 3:** Insert the **SO-DIMM**. Push the memory in at a 20° angle. (See **Figure 4-1**)
- Step 4:** Seat the **SO-DIMM**. Gently push downwards and the arms clip into place. (See **Figure 4-1**)

4.4 Full-size PCIe Mini Card Installation

The PCIe Mini card slot allows installation of either a full-size or half-size PCIe Mini card. To install a full-size PCIe Mini card, please follow the steps below.

- Step 1:** Locate the **PCIe Mini card slot**. See **Figure 3-20**.

Step 2: Remove the retention screws. Remove the two retention screws as shown in Figure 4-2.

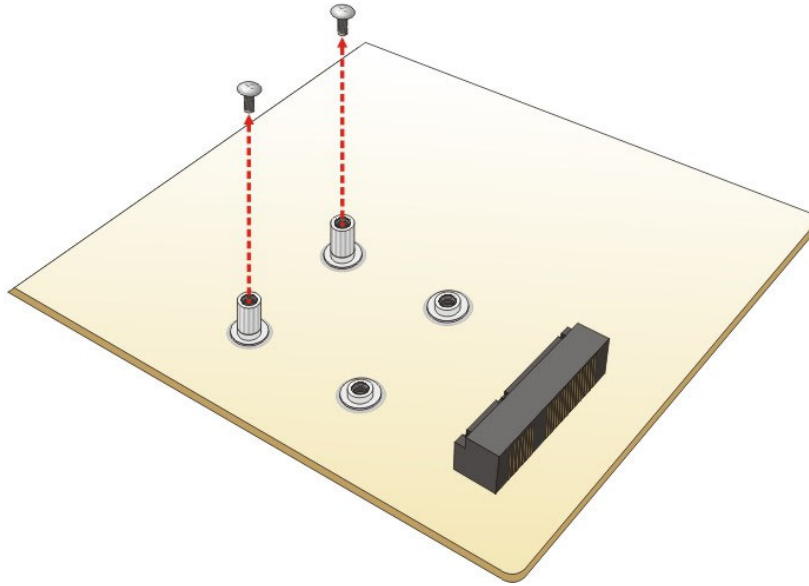

Figure 4-2: Removing the Retention Screws

Step 3: Insert into the socket at an angle. Line up the notch on the card with the notch on the slot. Slide the PCIe Mini card into the socket at an angle of about 20° (Figure 4-3).

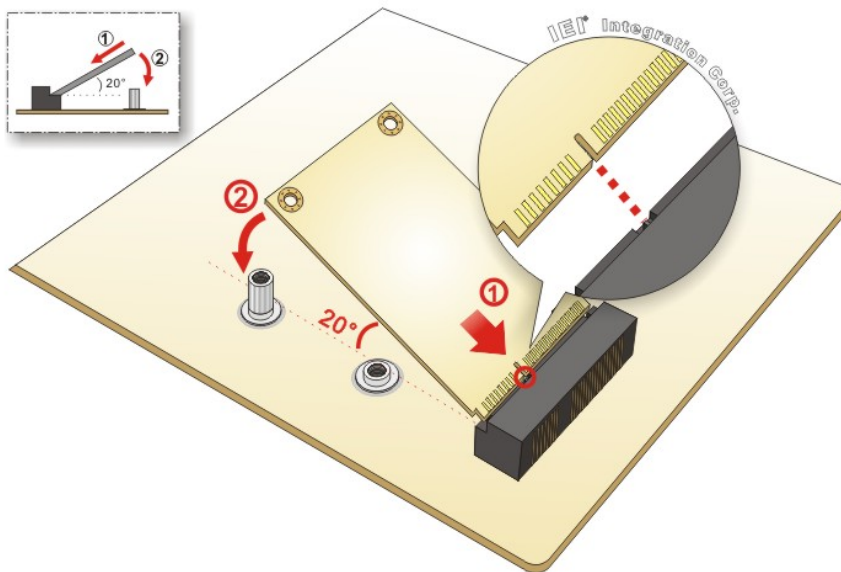

Figure 4-3: Inserting the Full-size PCIe Mini Card into the Slot at an Angle

eKINO-BT Mini-ITX SBC

Step 4: **Secure the full-size PCIe Mini card.** Secure the full-size PCIe Mini card with the retention screws previously removed (**Figure 4-4**).

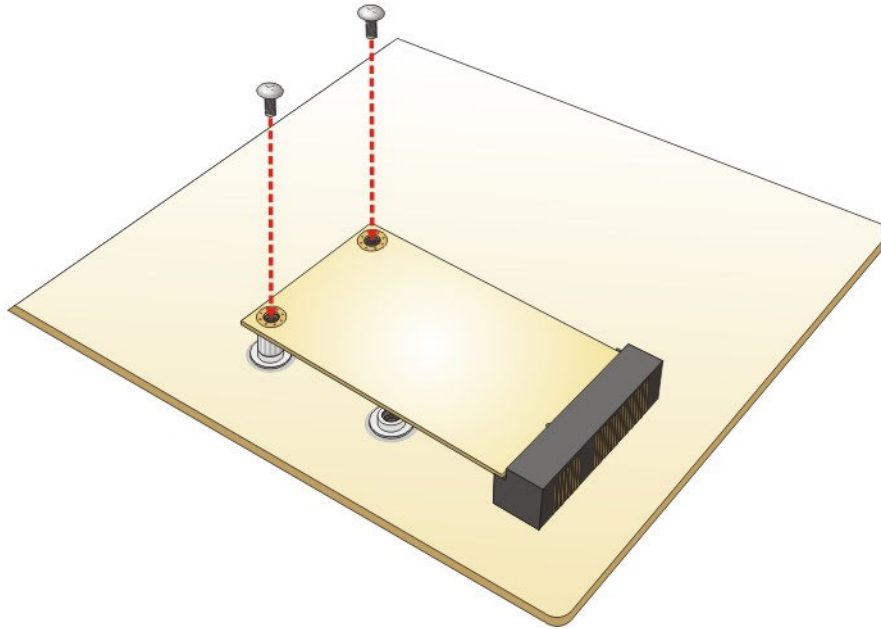

Figure 4-4: Securing the Full-size PCIe Mini Card

4.5 Half-size PCIe Mini Card Installation

The PCIe Mini card slot allows installation of either a full-size or half-size PCIe Mini card. To install a half-size PCIe Mini card, please follow the steps below.

Step 1: **Locate the PCIe Mini card slot.** See **Figure 3-20**.

Step 2: **Remove the retention screw.** Remove the retention screw as shown in **Figure 4-5**.

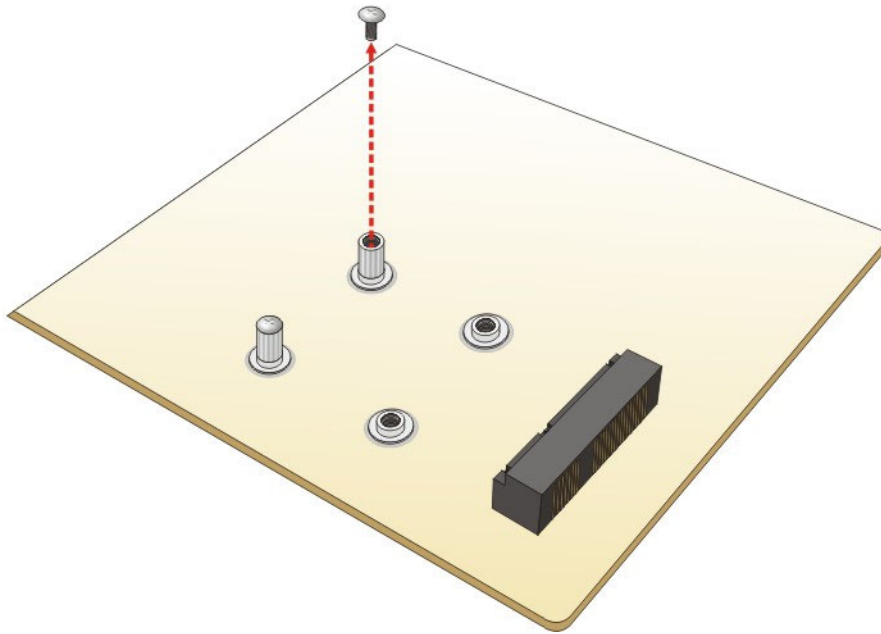

Figure 4-5: Removing the Retention Screw

Step 3: Remove the standoff. Unscrew and remove the standoff secured on the motherboard as shown in **Figure 4-6**.

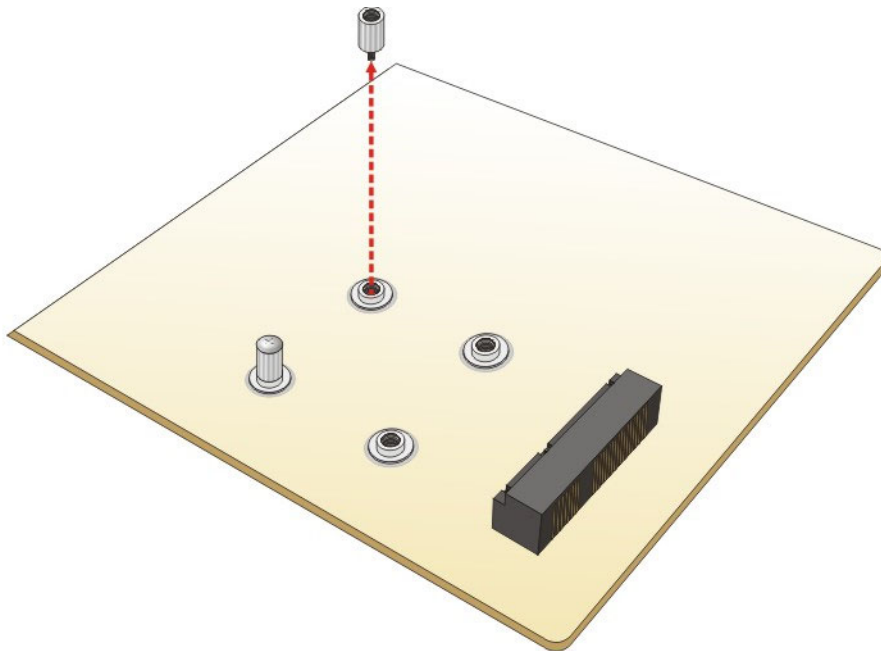

Figure 4-6: Removing the Standoff

eKINO-BT Mini-ITX SBC

Step 4: Install the standoff to the screw hole for the half-size PCIe Mini card. Install the previously removed standoff to the screw hole for the half-size PCIe Mini card (Figure 4-7).

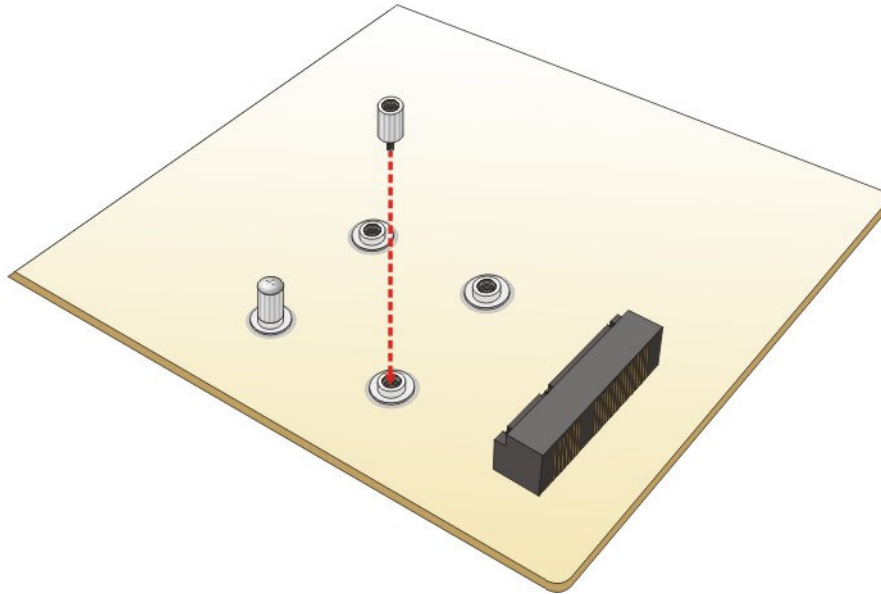

Figure 4-7: Installing the Standoff

Step 5: Insert into the socket at an angle. Line up the notch on the card with the notch on the slot. Slide the PCIe Mini card into the slot at an angle of about 20° (Figure 4-8).

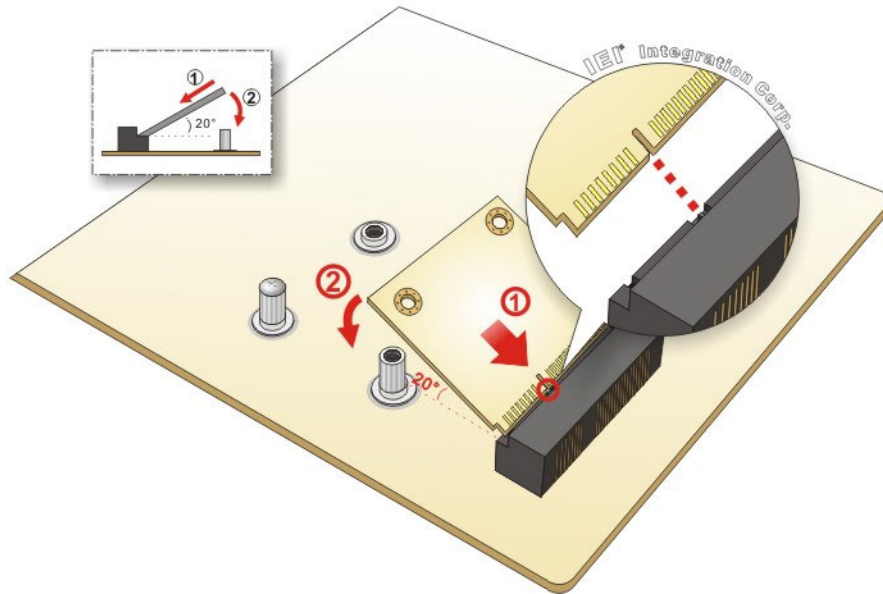

Figure 4-8: Inserting the Half-size PCIe Mini Card into the Slot at an Angle

Step 6: Secure the half-size PCIe Mini card. Secure the half-size PCIe Mini card with the retention screw previously removed (**Figure 4-9**).

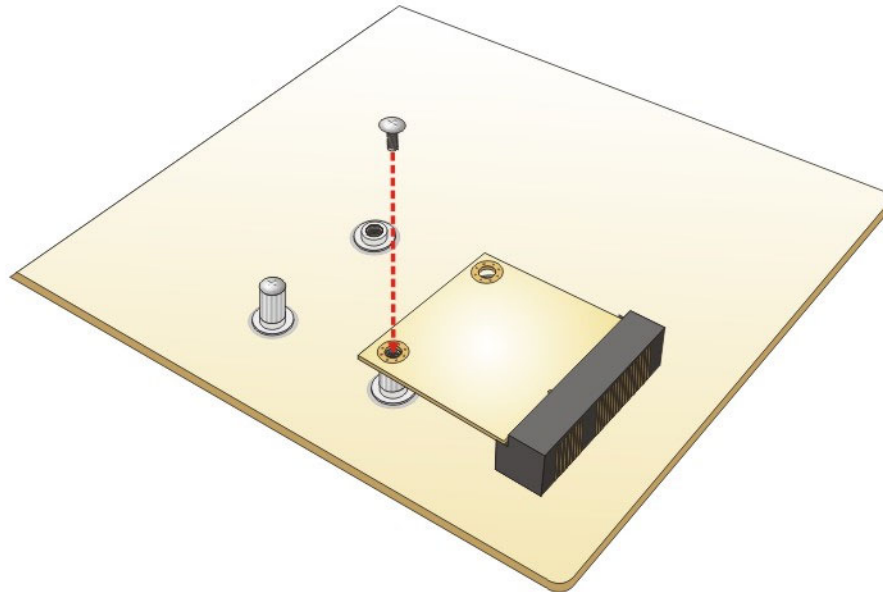

Figure 4-9: Securing the Half-size PCIe Mini Card

eKINO-BT Mini-ITX SBC

4.6 UPS Installation

To install the UPS, connect the AUPS battery to the motherboard and connect the motherboard to the 9 V ~ 26 V power supply.



NOTE:

A battery icon will be shown on the Windows notification area when the AUPS battery is installed to the system.

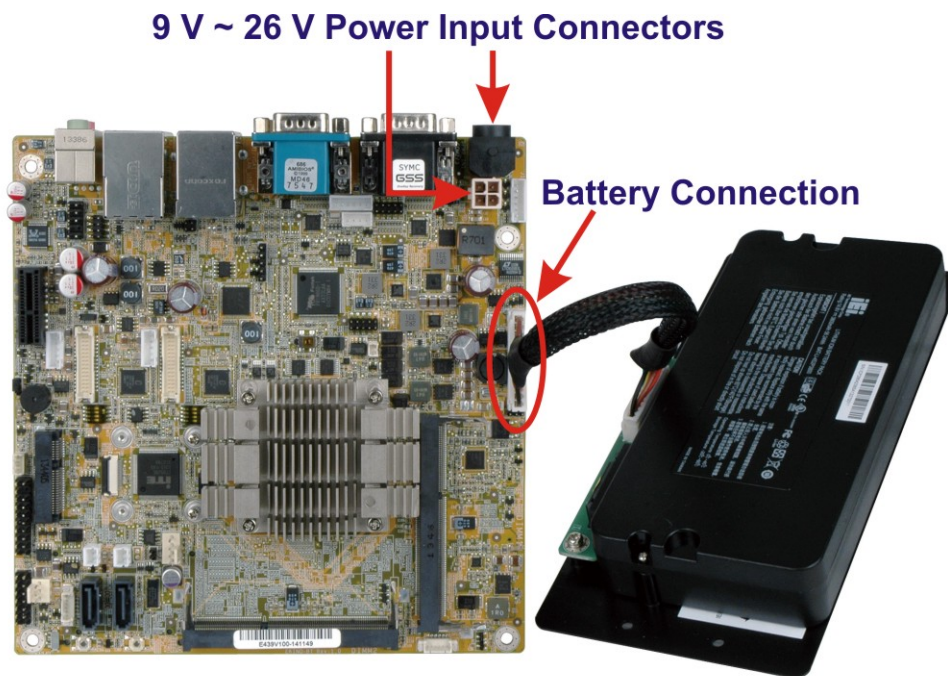

Figure 4-10: UPS Installation

4.7 System Configuration

The system configuration is controlled by buttons/jumpers/switches, and should be performed before installation.

4.7.1 AT/ATX Power Mode Selection

The AT and ATX power mode selection is made through the AT/ATX power mode switch which is shown in **Figure 4-11**.

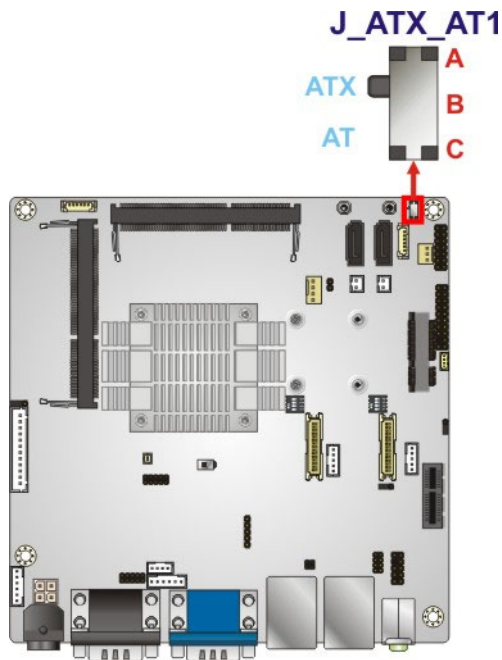

Figure 4-11: AT/ATX Power Mode Switch Location

Setting	Description
A-B	ATX power mode (default)
B-C	AT power mode

Table 4-1: AT/ATX Power Mode Switch Settings

4.7.2 Battery Enable/Disable

Jumper Label:	JP3
Jumper Type:	2-pin header
Jumper Settings:	See Table 4-6
Jumper Location:	See Figure 4-17

eKINO-BT Mini-ITX SBC

When this jumper is closed, the system will use the battery when needed; when open, the system will not use the battery.

Setting	Description
Closed	Enable battery (Default)
Open	Disable battery

Table 4-2: Battery Enable/Disable Jumper Settings

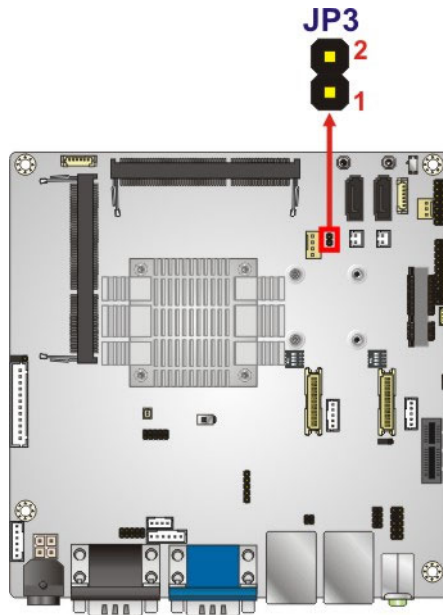

Figure 4-12: Battery Enable/Disable Jumper Location

4.7.3 Clear CMOS Button

To reset the BIOS, remove the on-board battery and press the clear CMOS button for three seconds or more. The clear CMOS button location is shown in **Figure 4-13**.

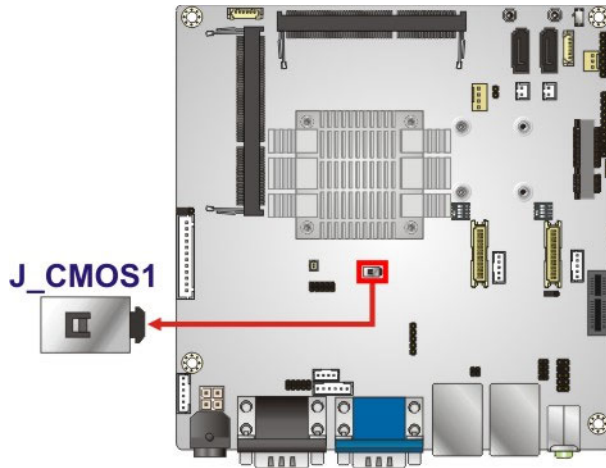

Figure 4-13: Clear CMOS Button Location

4.7.4 LVDS Panel Type Selection

- Jumper Label:** SW1, SW2
- Jumper Type:** DIP switch
- Jumper Settings:** See **Table 4-3**
- Jumper Location:** See **Figure 4-14**

Use the DIP switches to select the resolution of the LCD panel connected to the LVDS1 and LVDS2 connectors.



NOTE:

The **SW1** and **SW2** DIP switches must be set to the same settings.

eKINO-BT Mini-ITX SBC

* ON=0, OFF=1; Single=S, Dual=D

SW1 (4-3-2-1)	Description
0000	800x600 18-bit S (default)
0001	1024x768 18-bit S
0010	1024x768 24-bit S
0011	1280x768 18-bit S
0100	1280x800 18-bit S
0101	1280x960 18-bit S
0110	1280x1024 24-bit D
0111	1366x768 18-bit S
1000	1366x768 24-bit S
1001	1440x960 24-bit D
1010	1400x1050 24-bit D
1011	1600x900 24-bit D
1100	1680x1050 24-bit D
1101	1600x1200 24-bit D
1110	1920x1080 24-bit D
1111	1920x1200 24-bit D

Table 4-3: LVDS Panel Type Selection

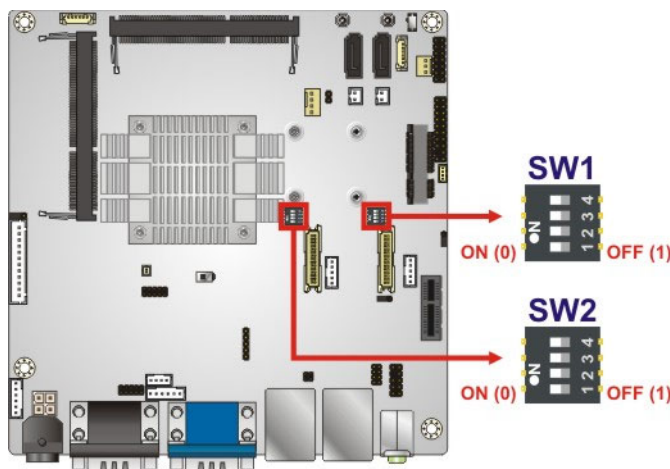

Figure 4-14: LVDS Panel Type Selection Switch Locations

4.7.5 LVDS1 Voltage Selection



WARNING:

Permanent damage to the screen and eKINO-BT may occur if the wrong voltage is selected with this jumper. Please refer to the user guide that came with the monitor to select the correct voltage.

- Jumper Label:** JP1
- Jumper Type:** 3-pin header
- Jumper Settings:** See Table 4-4
- Jumper Location:** See Figure 4-15

The LVDS1 voltage selection jumper allows setting the voltage provided to the monitor connected to the LVDS1 connector.

Setting	Description
Short 1-2	+3.3V LVDS (Default)
Short 2-3	+5V LVDS

Table 4-4: LVDS1 Voltage Selection Jumper Settings

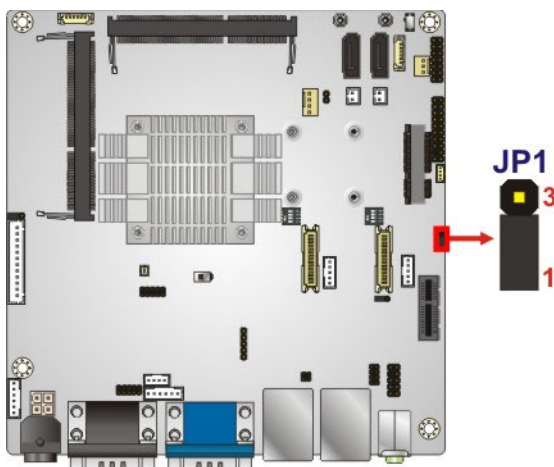

Figure 4-15: LVDS1 Voltage Selection Jumper Location

eKINO-BT Mini-ITX SBC

4.7.6 LVDS2 Voltage Selection



WARNING:

Permanent damage to the screen and eKINO-BT may occur if the wrong voltage is selected with this jumper. Please refer to the user guide that came with the monitor to select the correct voltage.

- Jumper Label:** JP2
- Jumper Type:** 3-pin header
- Jumper Settings:** See Table 4-5
- Jumper Location:** See Figure 4-16

The LVDS2 voltage selection jumper allows setting the voltage provided to the monitor connected to the LVDS2 connector.

Setting	Description
Short 1-2	+3.3V LVDS (Default)
Short 2-3	+5V LVDS

Table 4-5: LVDS2 Voltage Selection Jumper Settings

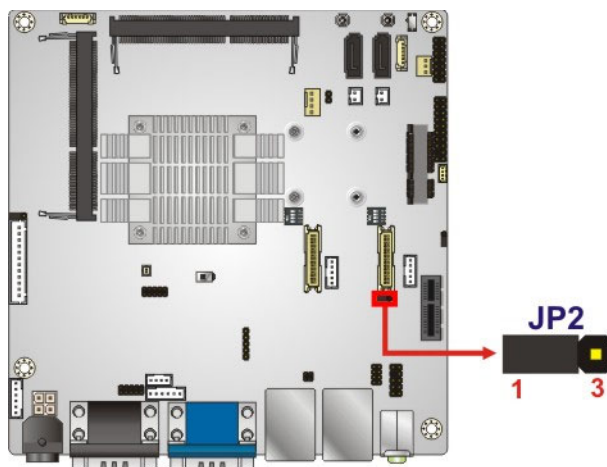

Figure 4-16: LVDS2 Voltage Selection Jumper Location

4.7.7 UPS/Battery Mode Selection

- Jumper Label:** J_UPS1
- Jumper Type:** 3-pin header
- Jumper Settings:** See Table 4-6
- Jumper Location:** See Figure 4-17

This jumper sets the system to run off the battery exclusively, or to use the battery as a UPS.

Setting	Description
Short 1-2	UPS mode (Default)
Short 2-3	Battery mode

Table 4-6: UPS/Battery Mode Selection Jumper Settings

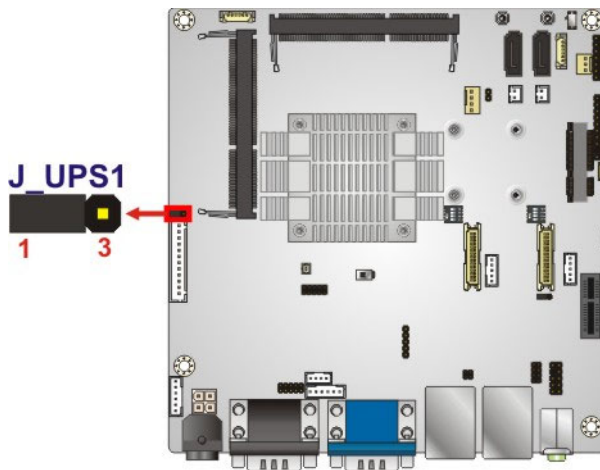

Figure 4-17: UPS/Battery Mode Selection Jumper Location

eKINO-BT Mini-ITX SBC

The power behavior of the UPS and battery modes might be different in the AT and ATX power modes. Refer to **Table 4-7** and **Table 4-8** for differences.

	Power Supply	UPS Mode	Battery Mode
Powering On	Battery only	The system can't be powered on.	The system powers on automatically.
	External DC only	The system powers on automatically.	
	Battery + External DC		
Powering Off	Battery only	N/A	
	External DC only	The system powers off automatically.	
	Battery + External DC		
DC Power Failure	Battery only	N/A	
	External DC only	The system powers off automatically.	
	Battery + External DC	The system is on until the battery is run out.	

Table 4-7: In AT Power Mode

	Power Supply	UPS Mode	Battery Mode
Powering On	Battery only	The system can't be powered on by pressing the power button.	Press the power button to power on the system.
	External DC only	Press the power button to power on the system.	
	Battery + External DC		
Powering Off	Battery only	Power off the system from OS or by pressing the power button. The system is powered off when the battery is run out.	
	External DC only	Power off the system from OS or by pressing the power button.	
	Battery + External DC		
DC Power Failure	Battery only	The system is on until the battery is run out.	
	External DC only	The system powers off automatically.	
	Battery + External DC	The system is on until the battery is run out.	

Table 4-8: In ATX Power Mode

4.8 Chassis Installation

4.8.1 Airflow



WARNING:

Airflow is critical for keeping components within recommended operating temperatures. The chassis should have fans and vents as necessary to keep things cool.

The eKINO-BT must be installed in a chassis with ventilation holes on the sides allowing airflow to travel through the heat sink surface. In a system with an individual power supply unit, the cooling fan of a power supply can also help generate airflow through the board surface.

4.8.2 Motherboard Installation

To install the eKINO-BT motherboard into the chassis please refer to the reference material that came with the chassis.

4.9 Internal Peripheral Device Connections

This section outlines the installation of peripheral devices to the onboard connectors.

4.9.1 SATA Drive Connection

The eKINO-BT is shipped with two SATA drive cables. To connect the SATA drive to the connector, please follow the steps below.

Step 1: **Locate the SATA connector and the SATA power connector.** The locations of the connectors are shown in **Chapter 3**.

Step 2: **Insert the cable connector.** Insert the cable connector into the on-board SATA drive connector and the SATA power connector. See **Figure 4-18**.

eKINO-BT Mini-ITX SBC

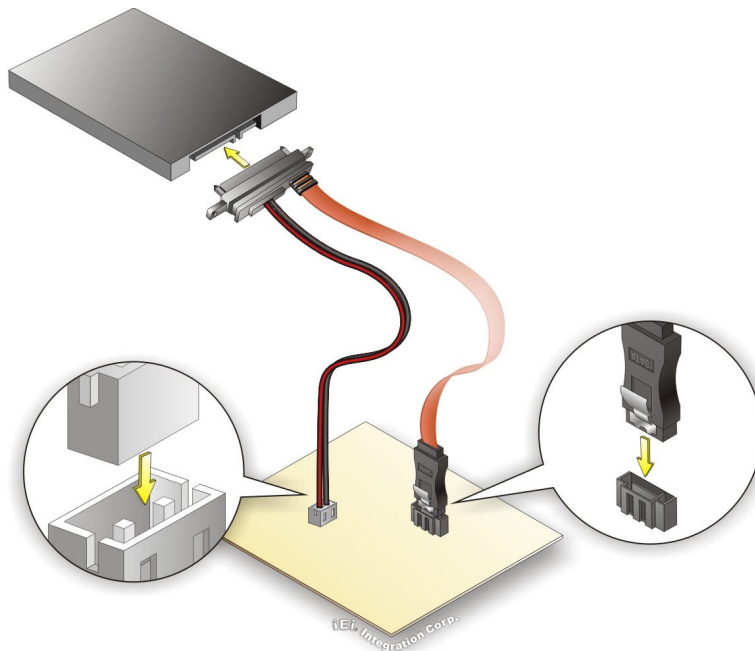

Figure 4-18: SATA Drive Cable Connection

Step 3: Connect the cable to the SATA disk. Connect the connector on the other end of the cable to the connector at the back of the SATA drive. See **Figure 4-18**.

Step 4: To remove the SATA cable from the SATA connector, press the clip on the connector at the end of the cable.

4.10 External Peripheral Interface Connection

Devices can be connected to the external connectors. To install external devices, follow the directions in the subsections below.

4.10.1 Audio Connector

The audio jacks on the external audio connector enable the eKINO-BT to be connected to a stereo sound setup. To install the audio devices, follow the steps below.

Step 1: Identify the audio plugs. The plugs on your home theater system or speakers may not match the colors on the rear panel. If audio plugs are plugged into the wrong jacks, sound quality will be very bad.

Step 2: Plug the audio plugs into the audio jacks. Plug the audio plugs into the audio jacks. If the plugs on your speakers are different, an adapter will need to be used to plug them into the audio jacks.

- **Line Out port (Lime):** Connects to a headphone or a speaker.
- **Microphone (Pink):** Connects to a microphone.

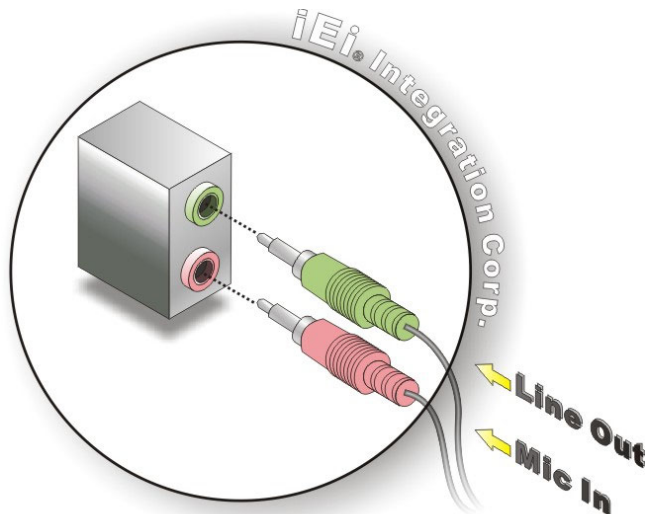

Figure 4-19: Audio Connector

Step 3: Check audio clarity. Check that the sound is coming through the right speakers by adjusting the balance front to rear and left to right.

4.10.2 LAN Connection

There are two external RJ-45 LAN connectors. The RJ-45 connectors enable connection to an external network. To connect a LAN cable with an RJ-45 connector, please follow the instructions below.

Step 1: Locate the RJ-45 connectors. The locations of the RJ-45 connectors are shown in Chapter 3.

Step 2: Align the connectors. Align the RJ-45 connector on the LAN cable with one of the RJ-45 connectors on the eKINO-BT. See Figure 4-20.

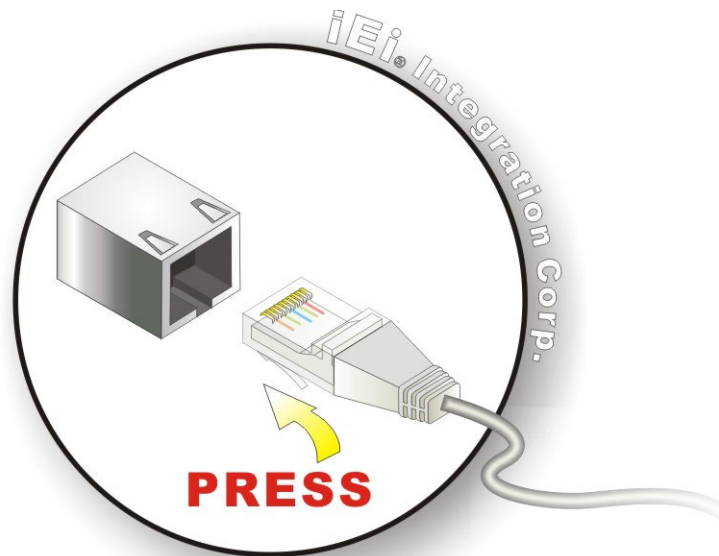

Figure 4-20: LAN Connection

Step 3: Insert the LAN cable RJ-45 connector. Once aligned, gently insert the LAN cable RJ-45 connector into the on-board RJ-45 connector.

4.10.3 Serial Device Connection

The eKINO-BT has three male DB-9 connectors on the external peripheral interface panel for three serial devices. Follow the steps below to connect a serial device to the eKINO-BT.

Step 1: Locate the DB-9 connector. The locations of the DB-9 connectors are shown in **Chapter 3**.

Step 2: Insert the serial connector. Insert the DB-9 connector of a serial device into the DB-9 connector on the external peripheral interface. See **Figure 4-21**.

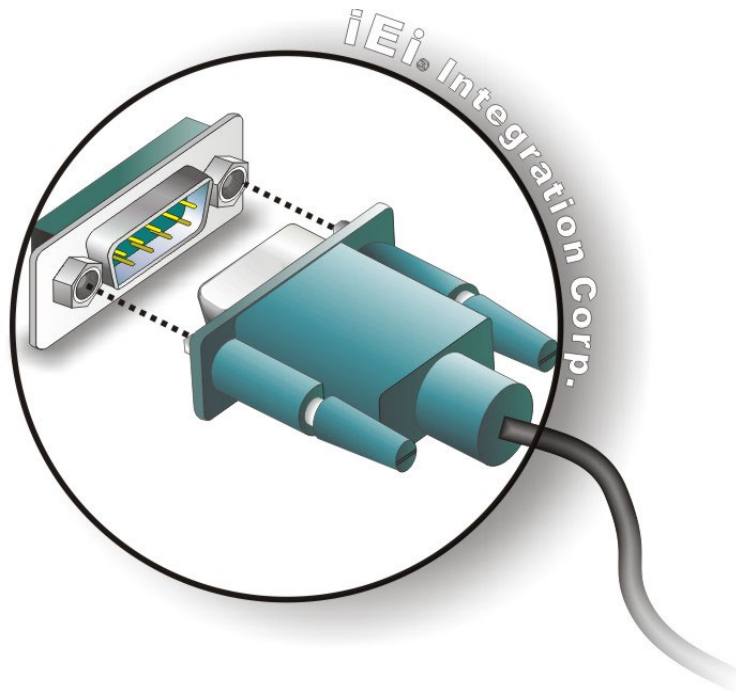

Figure 4-21: Serial Device Connector

Step 3: Secure the connector. Secure the serial device connector to the external interface by tightening the two retention screws on either side of the connector.

4.10.4 USB Connection

The external USB 2.0/3.0 connectors provide easier and quicker access to external USB devices. Follow the steps below to connect USB devices to the eKINO-BT.

Step 1: Locate the USB 2.0/3.0 connectors. The locations of the USB 2.0/3.0 connectors are shown in **Chapter 3**.

Step 2: Insert a USB 2.0/3.0 plug. Insert the USB 2.0/3.0 plug of a device into the USB 2.0/3.0 on the external peripheral interface. See **Figure 4-22**.

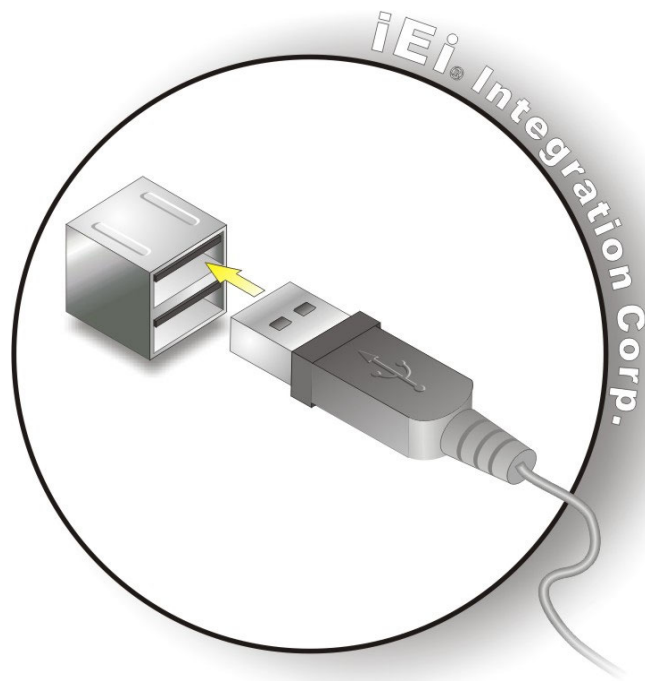

Figure 4-22: USB Connector

4.10.5 VGA Monitor Connection

The eKINO-BT has a single female DB-15 connector on the external peripheral interface panel. The DB-15 connector is connected to a CRT or VGA monitor. To connect a monitor to the eKINO-BT, please follow the instructions below.

- Step 1: Locate the female DB-15 connector.** The location of the female DB-15 connector is shown in **Chapter 3**.
- Step 2: Align the VGA connector.** Align the male DB-15 connector on the VGA screen cable with the female DB-15 connector on the external peripheral interface.
- Step 3: Insert the VGA connector** Once the connectors are properly aligned with the insert the male connector from the VGA screen into the female connector on the eKINO-BT. See **Figure 4-23**.

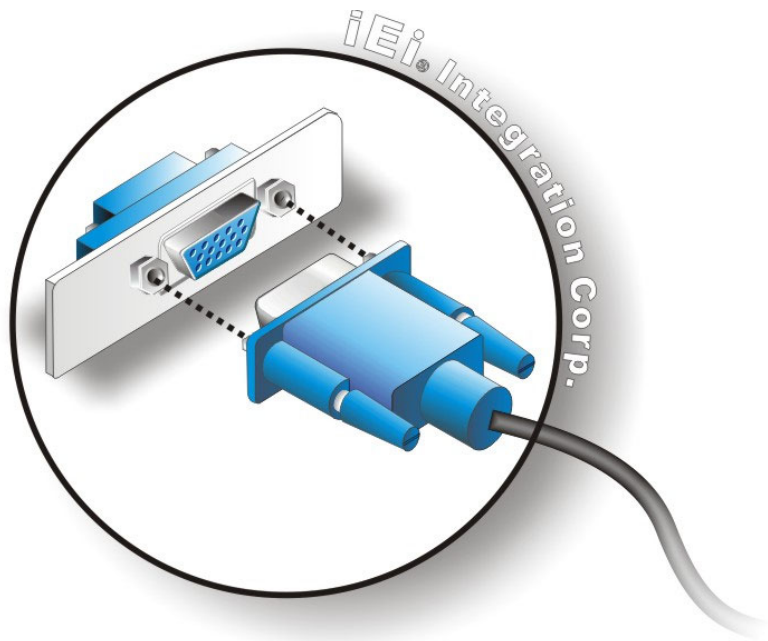

Figure 4-23: VGA Connector

Step 4: Secure the connector. Secure the DB-15 VGA connector from the VGA monitor to the external interface by tightening the two retention screws on either side of the connector.

Chapter

5

BIOS

5.1 Introduction

The BIOS is programmed onto the BIOS chip. The BIOS setup program allows changes to certain system settings. This chapter outlines the options that can be changed.



NOTE:

Some of the BIOS options may vary throughout the life cycle of the product and are subject to change without prior notice.

5.1.1 Starting Setup

The UEFI BIOS is activated when the computer is turned on. The setup program can be activated in one of two ways.

1. Press the **DEL** or **F2** key as soon as the system is turned on or
2. Press the **DEL** or **F2** key when the “**Press DEL or F2 to enter SETUP**” message appears on the screen.

If the message disappears before the **DEL** or **F2** key is pressed, restart the computer and try again.

5.1.2 Using Setup

Use the arrow keys to highlight items, press **ENTER** to select, use the PageUp and PageDown keys to change entries, press **F1** for help and press **ESC** to quit. Navigation keys are shown in the following table.

Key	Function
Up arrow	Move to previous item
Down arrow	Move to next item
Left arrow	Move to the item on the left hand side
Right arrow	Move to the item on the right hand side
+	Increase the numeric value or make changes
-	Decrease the numeric value or make changes

eKINO-BT Mini-ITX SBC

Key	Function
Page Up key	Move to the next page
Page Dn key	Move to the previous page
Esc key	Main Menu – Quit and not save changes into CMOS Status Page Setup Menu and Option Page Setup Menu -- Exit current page and return to Main Menu
F1	General help, only for Status Page Setup Menu and Option Page Setup Menu
F2	Load previous values
F3	Load optimized defaults
F4	Save changes and Exit BIOS

Table 5-1: BIOS Navigation Keys

5.1.3 Getting Help

When **F1** is pressed a small help window describing the appropriate keys to use and the possible selections for the highlighted item appears. To exit the Help Window press **Esc** or the **F1** key again.

5.1.4 Unable to Reboot after Configuration Changes

If the computer cannot boot after changes to the system configuration are made, CMOS defaults. Use the clear CMOS button described in **Chapter 4**.

5.1.5 BIOS Menu Bar

The **menu bar** on top of the BIOS screen has the following main items:

- Main – Changes the basic system configuration.
- Advanced – Changes the advanced system settings.
- Chipset – Changes the chipset settings.
- Security – Sets User and Supervisor Passwords.
- Boot – Changes the system boot configuration.
- Save & Exit – Selects exit options and loads default settings.

The following sections completely describe the configuration options found in the menu items at the top of the BIOS screen and listed above.

5.2 Main

The **Main** BIOS menu (**BIOS Menu 1**) appears when the **BIOS Setup** program is entered.

The **Main** menu gives an overview of the basic system information.

Aptio Setup Utility - Copyright (C) 2013 American Megatrends, Inc.					
Main	Advanced	Chipset	Security	Boot	Save & Exit
BIOS Information					Set the Date. Use Tab to switch between Date elements. ----- →←: Select Screen ↑↓: Select Item Enter: Select +/-: Change Opt. F1: General Help F2: Previous Values F3: Optimized Defaults F4: Save & Exit ESC: Exit
BIOS Vendor		American Megatrends			
Core Version		5.009			
Compliance		UEFI 2.3; PI 1.2			
Project Version		E439AI10.ROM			
Build Date and Time		04/30/2014 11:43:32			
iWDD Vendor		iEi			
iWDD Version		E439ER10.bin			
CPU Configuration					
Microcode Patch		321			
BayTrail SoC		B3 Stepping			
Memory Information					
Total Memory		4096 MB (LPDDR3)			
GOP Information					
Intel(R) GOP Driver		[N/A]			
TXE Information					
Sec RC Version		00.05.00.00			
TXE FW Version		01.00.02.1060			
System Date		[Tue 07/22/2014]			
System Time		[15:10:27]			
Access Level		Administrator			
Version 2.16.1242. Copyright (C) 2013 American Megatrends, Inc.					

BIOS Menu 1: Main

The Main menu has two user configurable fields:

➔ **System Date [xx/xx/xx]**

Use the **System Date** option to set the system date. Manually enter the day, month and year.

eKINO-BT Mini-ITX SBC

→ System Time [xx:xx:xx]

Use the **System Time** option to set the system time. Manually enter the hours, minutes and seconds.

5.3 Advanced

Use the **Advanced** menu (**BIOS Menu 2**) to configure the CPU and peripheral devices through the following sub-menus:



WARNING:

Setting the wrong values in the sections below may cause the system to malfunction. Make sure that the settings made are compatible with the hardware.

```

Aptio Setup Utility - Copyright (C) 2013 American Megatrends, Inc.
Main  Advanced  Chipset  Security  Boot  Save & Exit
-----
> ACPI Settings
> F81866 Super IO Configuration
> iWDD H/W Monitor
> RTC Wake Settings
> Serial Port Console Redirection
> CPU Configuration
> IDE Configuration
> Trusted Computing
> USB Configuration

System ACPI Parameters
-----
→←: Select Screen
↑↓: Select Item
Enter: Select
+/-: Change Opt.
F1: General Help
F2: Previous Values
F3: Optimized Defaults
F4: Save & Exit
ESC: Exit

Version 2.16.1242. Copyright (C) 2013 American Megatrends, Inc.
    
```

BIOS Menu 2: Advanced

5.3.1 ACPI Settings

The **ACPI Settings** menu (**BIOS Menu 3**) configures the Advanced Configuration and Power Interface (ACPI) options.

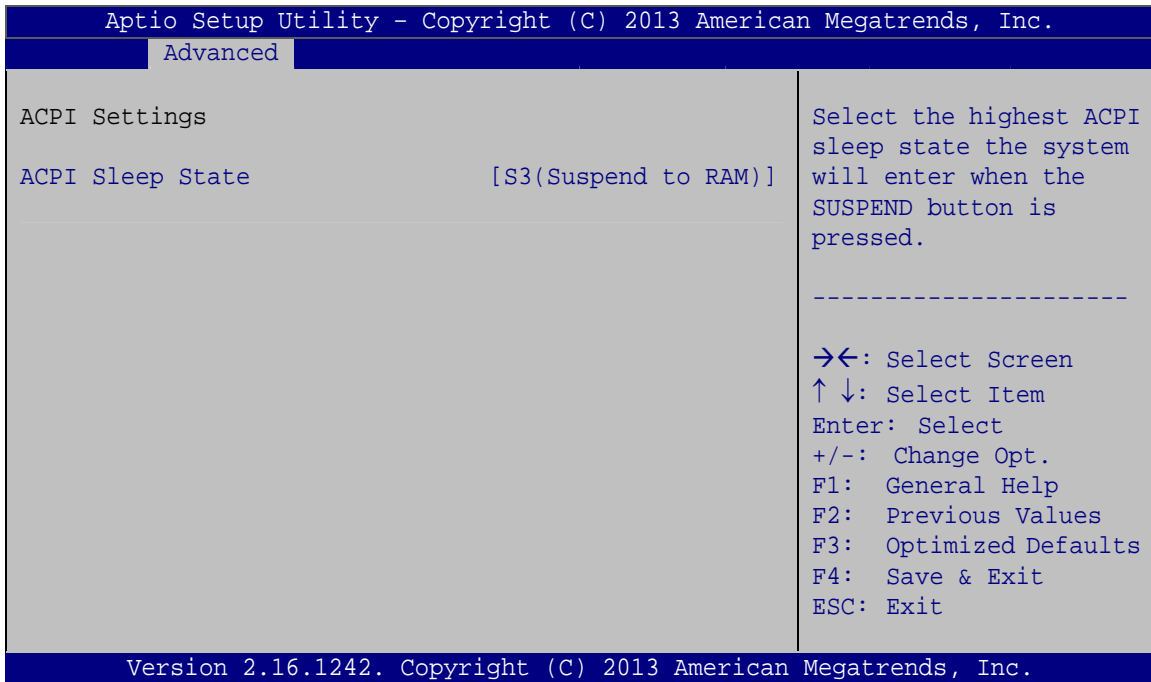

BIOS Menu 3: ACPI Settings

→ ACPI Sleep State [S3 (Suspend to RAM)]

Use the **ACPI Sleep State** option to specify the sleep state the system enters when it is not being used.

- **S3 (Suspend to RAM)** **DEFAULT** The caches are flushed and the CPU is powered off. Power to the RAM is maintained. The computer returns slower to a working state, but more power is saved.

eKINO-BT Mini-ITX SBC

5.3.2 F81866 Super IO Configuration

Use the **F81866 Super IO Configuration** menu (**BIOS Menu 4**) to set or change the configurations for the serial ports.

```

Aptio Setup Utility - Copyright (C) 2013 American Megatrends, Inc.
  Advanced
F81866 Super IO Configuration                               Set Parameters of Serial
                                                           Port 1 (COMA)
F81866 Super IO Chip                                     F81866
> Serial Port 1 Configuration
> Serial Port 2 Configuration
> Serial Port 3 Configuration
> Serial Port 4 Configuration
> Serial Port 5 Configuration
> IrDA Configuration
                                                           -----
                                                           →←: Select Screen
                                                           ↑ ↓: Select Item
                                                           Enter: Select
                                                           +/-: Change Opt.
                                                           F1: General Help
                                                           F2: Previous Values
                                                           F3: Optimized Defaults
                                                           F4: Save & Exit
                                                           ESC: Exit
Version 2.16.1242. Copyright (C) 2013 American Megatrends, Inc.

```

BIOS Menu 4: F81866 Super IO Configuration

5.3.2.1 Serial Port n Configuration

Use the **Serial Port n Configuration** menu (**BIOS Menu 5**) to configure the serial port n.

```

Aptio Setup Utility - Copyright (C) 2013 American Megatrends, Inc.
  Advanced
Serial Port n Configuration                               Enable or Disable Serial
                                                           Port (COM)
Serial Port                                             [Enabled]
Device Settings                                         IO=3F8h; IRQ=4
Change Settings                                         [Auto]
                                                           -----
                                                           →←: Select Screen
                                                           ↑ ↓: Select Item
                                                           Enter: Select
                                                           +/-: Change Opt.
                                                           F1: General Help
                                                           F2: Previous Values
                                                           F3: Optimized Defaults
                                                           F4: Save & Exit
                                                           ESC: Exit
Version 2.16.1242. Copyright (C) 2013 American Megatrends, Inc.

```

BIOS Menu 5: Serial Port n Configuration Menu

5.3.2.1.1 Serial Port 1 Configuration

➔ **Serial Port [Enabled]**

Use the **Serial Port** option to enable or disable the serial port.

- ➔ **Disabled** Disable the serial port
- ➔ **Enabled** **DEFAULT** Enable the serial port

➔ **Change Settings [Auto]**

Use the **Change Settings** option to change the serial port IO port address and interrupt address.

- ➔ **Auto** **DEFAULT** The serial port IO port address and interrupt address are automatically detected.
- ➔ **IO=3F8h;**
IRQ=4 Serial Port I/O port address is 3F8h and the interrupt address is IRQ4
- ➔ **IO=3F8h;**
IRQ=3, 4 Serial Port I/O port address is 3F8h and the interrupt address is IRQ3, 4
- ➔ **IO=2F8h;**
IRQ=3, 4 Serial Port I/O port address is 2F8h and the interrupt address is IRQ3, 4
- ➔ **IO=3E8h;**
IRQ=3, 4 Serial Port I/O port address is 3E8h and the interrupt address is IRQ3, 4
- ➔ **IO=2E8h;**
IRQ=3, 4 Serial Port I/O port address is 2E8h and the interrupt address is IRQ3, 4

5.3.2.1.2 Serial Port 2 Configuration

➔ **Serial Port [Enabled]**

Use the **Serial Port** option to enable or disable the serial port.

- ➔ **Disabled** Disable the serial port
- ➔ **Enabled** **DEFAULT** Enable the serial port

eKINO-BT Mini-ITX SBC

→ Change Settings [Auto]

Use the **Change Settings** option to change the serial port IO port address and interrupt address.

- **Auto** **DEFAULT** The serial port IO port address and interrupt address are automatically detected.
- **IO=2F8h;**
IRQ=3 Serial Port I/O port address is 2F8h and the interrupt address is IRQ3
- **IO=3F8h;**
IRQ=3, 4 Serial Port I/O port address is 3F8h and the interrupt address is IRQ3, 4
- **IO=2F8h;**
IRQ=3, 4 Serial Port I/O port address is 2F8h and the interrupt address is IRQ3, 4
- **IO=3E8h;**
IRQ=3, 4 Serial Port I/O port address is 3E8h and the interrupt address is IRQ3, 4
- **IO=2E8h;**
IRQ=3, 4 Serial Port I/O port address is 2E8h and the interrupt address is IRQ3, 4

5.3.2.1.3 Serial Port 3 Configuration

→ Serial Port [Enabled]

Use the **Serial Port** option to enable or disable the serial port.

- **Disabled** Disable the serial port
- **Enabled** **DEFAULT** Enable the serial port

→ Change Settings [Auto]

Use the **Change Settings** option to change the serial port IO port address and interrupt address.

- **Auto** **DEFAULT** The serial port IO port address and interrupt address are automatically detected.

- ➔ **IO=3E8h;**
IRQ=10 Serial Port I/O port address is 3E8h and the interrupt address is IRQ10
- ➔ **IO=3F8h;**
IRQ=10, 11 Serial Port I/O port address is 3F8h and the interrupt address is IRQ10, 11
- ➔ **IO=2F8h;**
IRQ=10, 11 Serial Port I/O port address is 2F8h and the interrupt address is IRQ10, 11
- ➔ **IO=3E8h;**
IRQ=10, 11 Serial Port I/O port address is 3E8h and the interrupt address is IRQ10, 11
- ➔ **IO=2E8h;**
IRQ=10, 11 Serial Port I/O port address is 2E8h and the interrupt address is IRQ10, 11
- ➔ **IO=2E0h;**
IRQ=10, 11 Serial Port I/O port address is 2E0h and the interrupt address is IRQ10, 11

5.3.2.1.4 Serial Port 4 Configuration

➔ **Serial Port [Enabled]**

Use the **Serial Port** option to enable or disable the serial port.

- ➔ **Disabled** Disable the serial port
- ➔ **Enabled DEFAULT** Enable the serial port

➔ **Change Settings [Auto]**

Use the **Change Settings** option to change the serial port IO port address and interrupt address.

- ➔ **Auto DEFAULT** The serial port IO port address and interrupt address are automatically detected.
- ➔ **IO=2E8h;**
IRQ=11 Serial Port I/O port address is 2E8h and the interrupt address is IRQ11
- ➔ **IO=3F8h;**
IRQ=10, 11 Serial Port I/O port address is 3F8h and the interrupt address is IRQ10, 11

eKINO-BT Mini-ITX SBC

- ➔ **IO=2F8h;**
IRQ=10, 11 Serial Port I/O port address is 2F8h and the interrupt address is IRQ10, 11
- ➔ **IO=3E8h;**
IRQ=10, 11 Serial Port I/O port address is 3E8h and the interrupt address is IRQ10, 11
- ➔ **IO=2E8h;**
IRQ=10, 11 Serial Port I/O port address is 2E8h and the interrupt address is IRQ10, 11
- ➔ **IO=2E0h;**
IRQ=10, 11 Serial Port I/O port address is 2E0h and the interrupt address is IRQ10, 11

5.3.2.1.5 Serial Port 5 Configuration

➔ Serial Port [Enabled]

Use the **Serial Port** option to enable or disable the serial port.

- ➔ **Disabled** Disable the serial port
- ➔ **Enabled** **DEFAULT** Enable the serial port

➔ Change Settings [Auto]

Use the **Change Settings** option to change the serial port IO port address and interrupt address.

- ➔ **Auto** **DEFAULT** The serial port IO port address and interrupt address are automatically detected.
- ➔ **IO=2D0h;**
IRQ=10 Serial Port I/O port address is 2D0h and the interrupt address is IRQ10
- ➔ **IO=3F8h;**
IRQ=10, 11 Serial Port I/O port address is 3F8h and the interrupt address is IRQ10, 11
- ➔ **IO=2F8h;**
IRQ=10, 11 Serial Port I/O port address is 2F8h and the interrupt address is IRQ10, 11
- ➔ **IO=3E8h;**
IRQ=10, 11 Serial Port I/O port address is 3E8h and the interrupt address is IRQ10, 11

- ➔ **IO=2E8h;** Serial Port I/O port address is 2E8h and the interrupt address is IRQ10, 11
IRQ=10, 11
- ➔ **IO=2D0h;** Serial Port I/O port address is 2D0h and the interrupt address is IRQ10, 11
IRQ=10, 11
- ➔ **IO=2E0h;** Serial Port I/O port address is 2E0h and the interrupt address is IRQ10, 11
IRQ=10, 11

5.3.2.1.6 IrDA Configuration

Use the **IrDA Configuration** menu (**BIOS Menu 6**) to configure the infrared port.

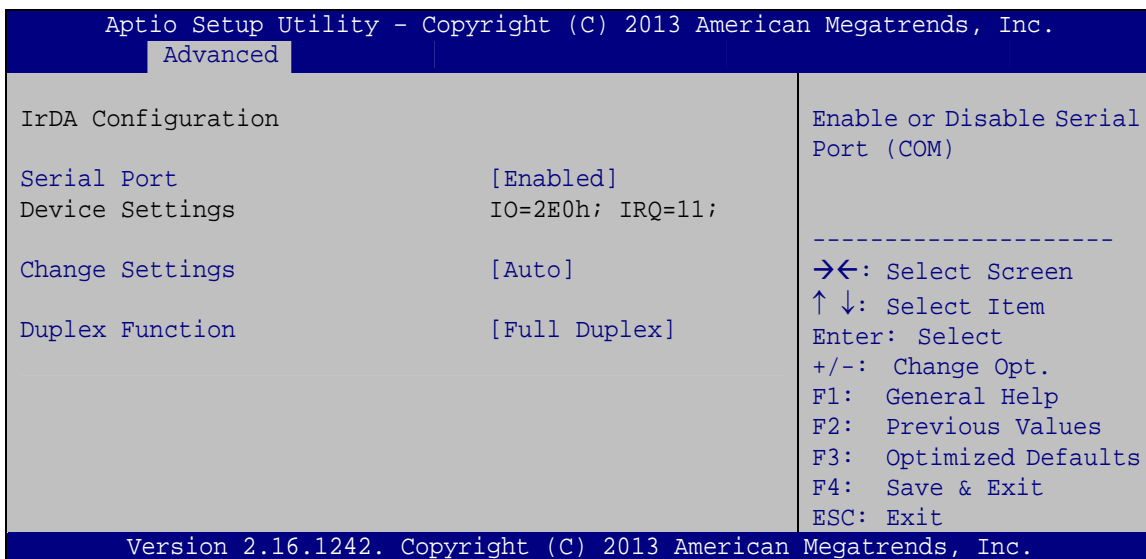

BIOS Menu 6: IrDA Configuration Menu

➔ **Serial Port [Enabled]**

Use the **Serial Port** option to enable or disable the IrDA function.

- ➔ **Disabled** Disable the IrDA function
- ➔ **Enabled DEFAULT** Enable the IrDA function

➔ **Change Settings [Auto]**

Use the **Change Settings** option to change the serial port IO address and interrupt address.

eKINO-BT Mini-ITX SBC

- | | | | |
|---|--------------------------------|----------------|---|
| ➔ | Auto | DEFAULT | The serial port IO port address and interrupt address are automatically detected. |
| ➔ | IO=2E0h;
IRQ=11 | | Serial Port I/O port address is 2E0h and the interrupt address is IRQ11 |
| ➔ | IO=3F8h;
IRQ=10, 11 | | Serial Port I/O port address is 3F8h and the interrupt address is IRQ10, 11 |
| ➔ | IO=2F8h;
IRQ=10, 11 | | Serial Port I/O port address is 2F8h and the interrupt address is IRQ10, 11 |
| ➔ | IO=3E8h;
IRQ=10, 11 | | Serial Port I/O port address is 3E8h and the interrupt address is IRQ10, 11 |
| ➔ | IO=2E8h;
IRQ=10, 11 | | Serial Port I/O port address is 2E8h and the interrupt address is IRQ10, 11 |
| ➔ | IO=2D0h;
IRQ=10, 11 | | Serial Port I/O port address is 2D0h and the interrupt address is IRQ10, 11 |
| ➔ | IO=2E0h;
IRQ=10, 11 | | Serial Port I/O port address is 2E0h and the interrupt address is IRQ10, 11 |

➔ Duplex Function [Full Duplex]

Use the **Duplex Function** option to select the IR data transmission mode.

- | | | | |
|---|--------------------|----------------|---|
| ➔ | Full Duplex | DEFAULT | The communication channels are used to send and receive the data in both directions at the same time. |
| ➔ | Half Duplex | | Transmission signals are sent in both directions, but one direction at a time so half duplex lines can alternatively send and receive data. |

5.3.3 iWDD H/W Monitor

The **iWDD H/W Monitor** menu (**BIOS Menu 7**) displays the system temperatures and voltages.

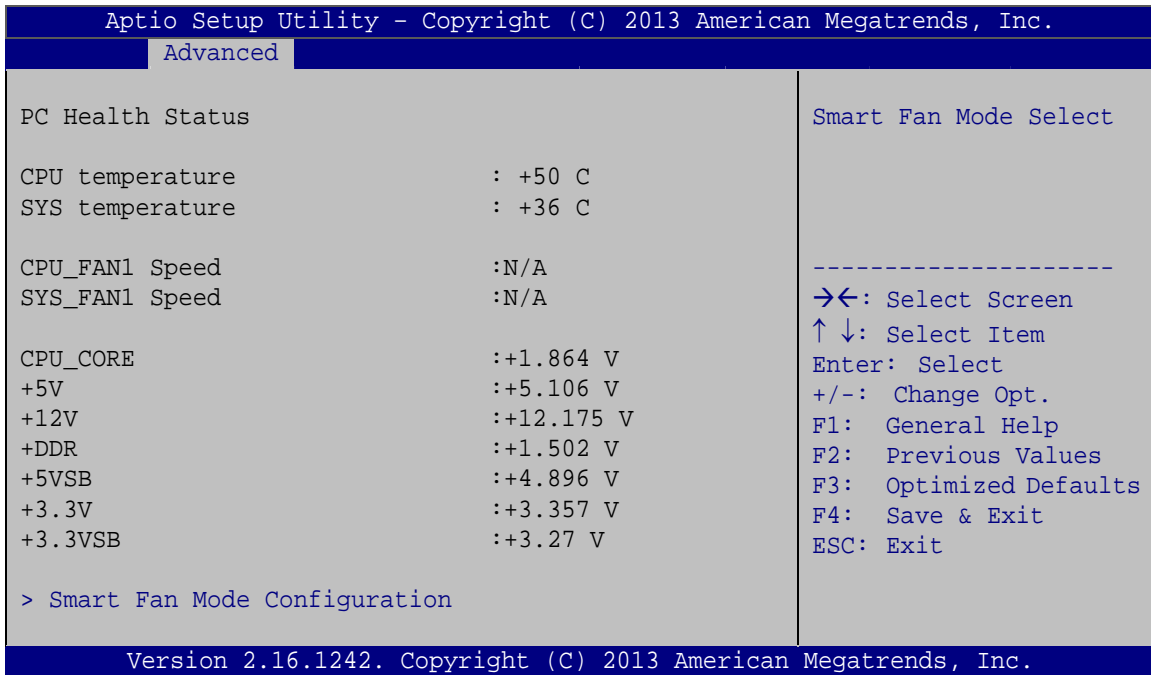

BIOS Menu 7: iWDD H/W Monitor

➔ PC Health Status

The following system parameters and values are shown. The system parameters that are monitored are:

- System Temperatures:
 - CPU Temperature
 - System Temperature
- Fan Speeds:
 - CPU Fan Speed
 - System Fan Speed
- Voltages:
 - CPU_CORE
 - +5V
 - +12V

eKINO-BT Mini-ITX SBC

- +DDR
- +5VSB
- +3.3V
- +3.3VSB

5.3.3.1 Smart Fan Mode Configuration

Use the **Smart Fan Mode Configuration** submenu (**BIOS Menu 8**) to configure smart fan temperature and speed settings.

```

Aptio Setup Utility - Copyright (C) 2013 American Megatrends, Inc.
Advanced
Smart Fan Mode Configuration
CPU_FAN1 Smart Fan Control      [Manual Mode]
Manual Mode                      70
SYS_FAN1 Smart Fan Control      [Auto Mode]
Auto mode fan start temperature  50
Auto mode fan off temperature    40
Auto mode fan start PWM          30
Auto mode fan slope PWM         1

Smart Fan Mode Select
-----
-><: Select Screen
↑ ↓: Select Item
EnterSelect
+ - Change Opt.
F1  General Help
F2  Previous Values
F3  Optimized Defaults
F4  Save & Exit
ESC Exit

Version 2.16.1242. Copyright (C) 2013 American Megatrends, Inc.
    
```

BIOS Menu 8: Smart Fan Mode Configuration

➔ CPU_FAN1 Smart Fan Control [Manual Mode]

Use the **CPU_FAN1 Smart Fan Control** option to configure the CPU Smart Fan.

- ➔ **Manual Mode** **DEFAULT** The fan spins at the speed set in Manual Mode settings.

➔ SYS_FAN1 Smart Fan Control [Auto Mode]

Use the **SYS_FAN1 Smart Fan Control** option to configure the System Smart Fan.

- ➔ **Manual Mode** The fan spins at the speed set in Manual Mode settings.
- ➔ **Auto Mode** **DEFAULT** The fan adjusts its speed using Auto Mode settings.

➔ **Auto mode fan start/off temperature**

Use the + or – key to change the **Auto mode fan start/off temperature** value. Enter a decimal number between 1 and 100.

➔ **Auto mode fan start PWM**

Use the + or – key to change the **Auto mode fan start PWM** value. Enter a decimal number between 1 and 100.

➔ **Auto mode fan slope PWM**

Use the + or – key to change the **Auto mode fan slope PWM** value. Enter a decimal number between 1 and 64.

5.3.4 RTC Wake Settings

The **RTC Wake Settings** menu (**BIOS Menu 9**) enables the system to wake at the specified time.

eKINO-BT Mini-ITX SBC

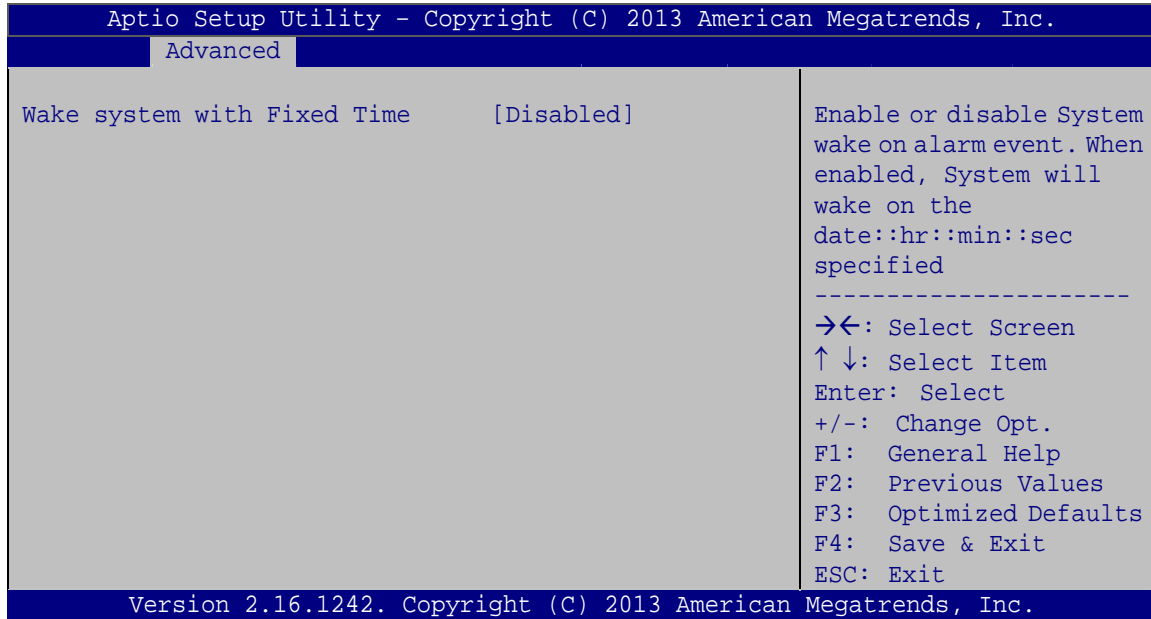

BIOS Menu 9: RTC Wake Settings

→ Wake system with Fixed Time [Disabled]

Use the **Wake system with Fixed Time** option to enable or disable the system wake on alarm event.

→ **Disabled** **DEFAULT** The real time clock (RTC) cannot generate a wake event

→ **Enabled** If selected, the **Wake up every day** option appears allowing you to enable to disable the system to wake every day at the specified time. Besides, the following options appear with values that can be selected:

Wake up every day

Wake up date

Wake up hour

Wake up minute

Wake up second

After setting the alarm, the computer turns itself on from a suspend state when the alarm goes off.

5.3.5 Serial Port Console Redirection

The **Serial Port Console Redirection** menu (**BIOS Menu 10**) allows the console redirection options to be configured. Console redirection allows users to maintain a system remotely by re-directing keyboard input and text output through the serial port.

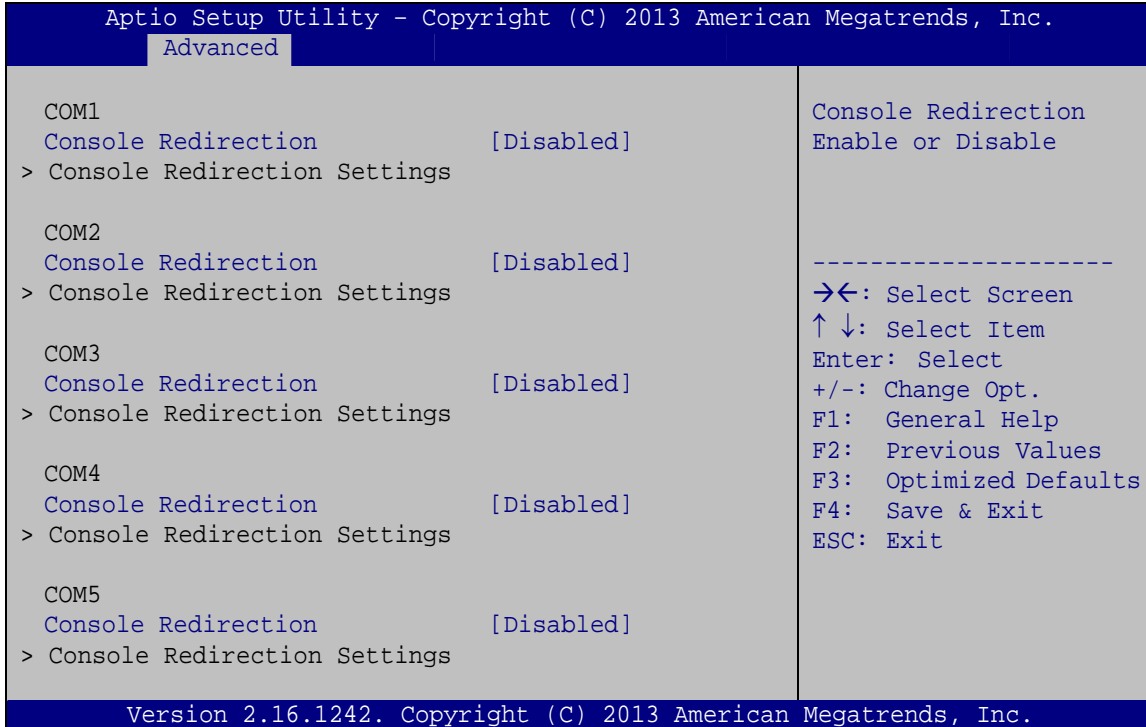

BIOS Menu 10: Serial Port Console Redirection

➔ **Console Redirection [Disabled]**

Use **Console Redirection** option to enable or disable the console redirection function.

- ➔ **Disabled** **DEFAULT** Disabled the console redirection function
- ➔ **Enabled** Enabled the console redirection function



NOTE:

The following options are available in the **Console Redirection Settings** submenu when the **Console Redirection** option is enabled.

eKINO-BT Mini-ITX SBC

→ Terminal Type [ANSI]

Use the **Terminal Type** option to specify the remote terminal type.

- **VT100** The target terminal type is VT100
- **VT100+** The target terminal type is VT100+
- **VT-UTF8** The target terminal type is VT-UTF8
- **ANSI** **DEFAULT** The target terminal type is ANSI

→ Bits per second [115200]

Use the **Bits per second** option to specify the serial port transmission speed. The speed must match the other side. Long or noisy lines may require lower speeds.

- **9600** Sets the serial port transmission speed at 9600.
- **19200** Sets the serial port transmission speed at 19200.
- **57600** Sets the serial port transmission speed at 57600.
- **115200** **DEFAULT** Sets the serial port transmission speed at 115200.

→ Data Bits [8]

Use the **Data Bits** option to specify the number of data bits.

- **7** Sets the data bits at 7.
- **8** **DEFAULT** Sets the data bits at 8.

→ Parity [None]

Use the **Parity** option to specify the parity bit that can be sent with the data bits for detecting the transmission errors.

- **None** **DEFAULT** No parity bit is sent with the data bits.
- **Even** The parity bit is 0 if the number of ones in the data bits is even.

eKINO-BT Mini-ITX SBC

The CPU Configuration menu (**BIOS Menu 11**) lists the following CPU details:

- CPU Signature: Lists the CPU signature value.
- Microcode Patch: Lists the microcode patch being used.
- Max CPU Speed: Lists the maximum CPU processing speed.
- Min CPU Speed: Lists the minimum CPU processing speed.
- Processor Cores: Lists the number of the processor core
- Intel HT Technology: Indicates if Intel HT Technology is supported by the CPU.
- Intel VT-x Technology: Indicates if Intel VT-x Technology is supported by the CPU.
- L1 Data Cache: Lists the amount of data storage space on the L1 cache.
- L1 Code Cache: Lists the amount of code storage space on the L1 cache.
- L2 Cache: Lists the amount of storage space on the L2 cache.
- L3 Cache: Lists the amount of storage space on the L3 cache.

➔ Intel Virtualization Technology [Enabled]

Use the **Intel Virtualization Technology** option to enable or disable virtualization on the system. When combined with third party software, Intel® Virtualization technology allows several OSs to run on the same system at the same time.

- | | | | |
|---|-----------------|----------------|---|
| ➔ | Disabled | | Disables Intel Virtualization Technology. |
| ➔ | Enabled | DEFAULT | Enables Intel Virtualization Technology. |

➔ EIST [Enabled]

Use the **EIST** option to enable or disable Enhanced Intel SpeedStep® Technology (EIST).

- | | | | |
|---|-----------------|----------------|--|
| ➔ | Disabled | | Disables Enhanced Intel SpeedStep® Technology. |
| ➔ | Enabled | DEFAULT | Enables Enhanced Intel SpeedStep® Technology. |

5.3.7 IDE Configuration

Use the **IDE Configuration** menu (**BIOS Menu 12**) to view the SATA devices installed in the system.

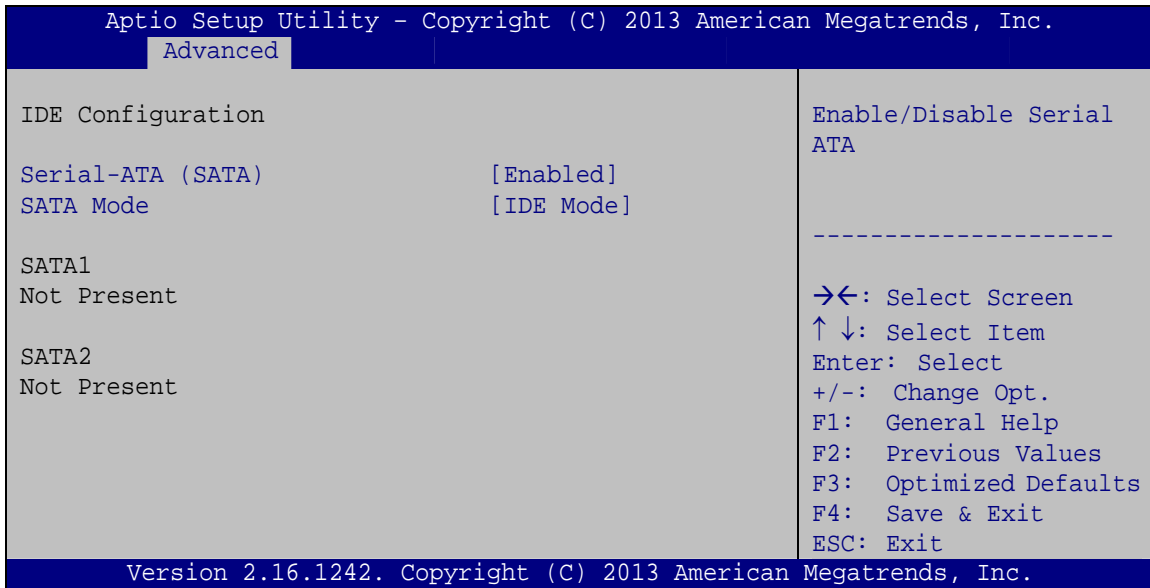

BIOS Menu 12: IDE Configuration

→ Serial-ATA (SATA) [Enabled]

Use the **Serial-ATA (SATA)** option to enable or disable the serial ATA controller.

- **Enabled** **DEFAULT** Enables the on-board SATA controller.
- **Disabled** Disables the on-board SATA controller.

→ SATA Mode Selection [IDE Mode]

Use the **SATA Mode Selection** option to configure SATA devices as normal IDE devices.

- **IDE Mode** **DEFAULT** Configures SATA devices as normal IDE device.
- **AHCI Mode** Configures SATA devices as AHCI device.

eKINO-BT Mini-ITX SBC

5.3.8 Trusted Computing

Use the **Trusted Computing** menu (**BIOS Menu 13**) to configure settings related to the Trusted Computing Group (TCG) Trusted Platform Module (TPM).

```

Aptio Setup Utility - Copyright (C) 2013 American Megatrends, Inc.
  Advanced
-----
Configuration
Security Device Support          [Disable]
Current Status Information
NO Security Device Found
-----
Enables or Disables BIOS
support for security
device. O.S. will not
show Security Device.
TCG EFI protocol and
INT1A interface will not
be available.

-----

-><: Select Screen
↑↓: Select Item
Enter: Select
+/-: Change Opt.
F1: General Help
F2: Previous Values
F3: Optimized Defaults
F4: Save & Exit
ESC: Exit

Version 2.16.1242. Copyright (C) 2013 American Megatrends, Inc.

```

BIOS Menu 13: Trusted Computing

➔ Security Device Support [Disable]

Use the **Security Device Support** option to configure support for the TPM.

- ➔ **Disable** DEFAULT TPM support is disabled.
- ➔ **Enable** TPM support is enabled.

5.3.9 USB Configuration

Use the **USB Configuration** menu (**BIOS Menu 14**) to read USB configuration information and configure the USB settings.

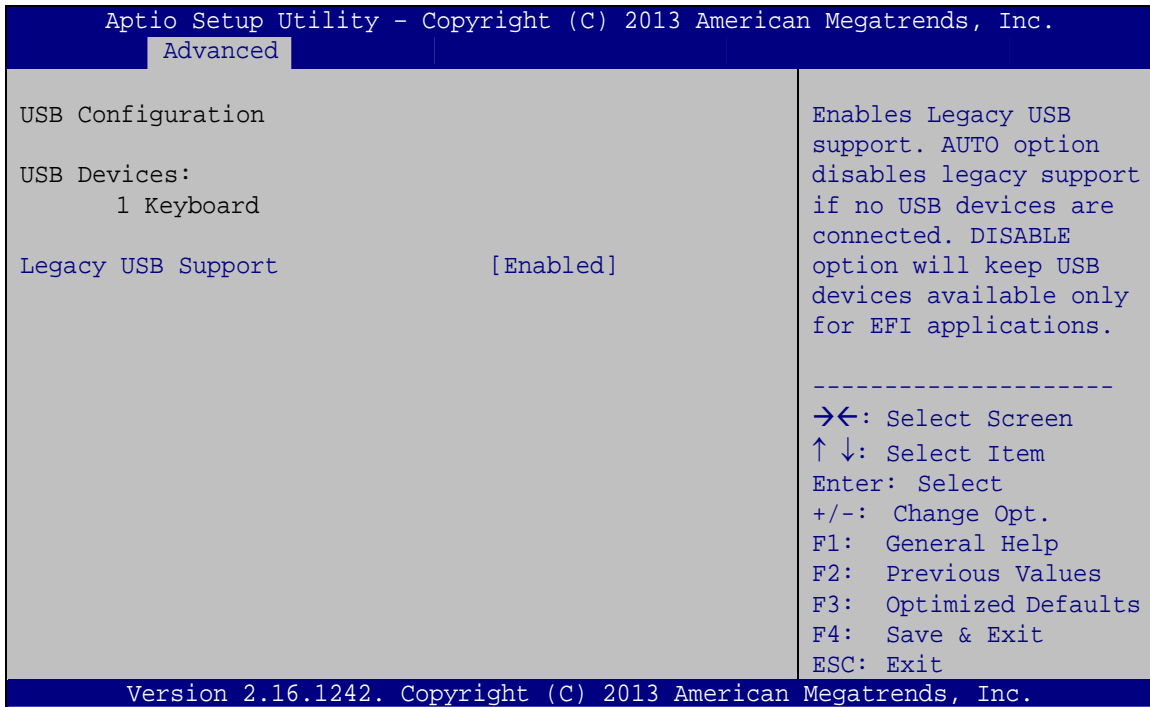

BIOS Menu 14: USB Configuration

➔ USB Devices

The **USB Devices** field lists the USB devices that are enabled on the system

➔ Legacy USB Support [Enabled]

Use the **Legacy USB Support** BIOS option to enable USB mouse and USB keyboard support.

Normally if this option is not enabled, any attached USB mouse or USB keyboard does not become available until a USB compatible operating system is fully booted with all USB drivers loaded. When this option is enabled, any attached USB mouse or USB keyboard can control the system even when there is no USB driver loaded onto the system.

eKINO-BT Mini-ITX SBC

- ➔ **Enabled** **DEFAULT** Legacy USB support enabled
- ➔ **Disabled** Legacy USB support disabled
- ➔ **Auto** Legacy USB support disabled if no USB devices are connected

5.4 Chipset

Use the **Chipset** menu (**BIOS Menu 15**) to access the Northbridge and Southbridge configuration menus.

```

Aptio Setup Utility - Copyright (C) 2013 American Megatrends, Inc.
Main   Advanced  Chipset  Security  Boot   Save & Exit
-----
> North Bridge
> South Bridge

North Bridge Parameters
-----
-><: Select Screen
↑ ↓: Select Item
Enter: Select
+/-: Change Opt.
F1: General Help
F2: Previous Values
F3: Optimized Defaults
F4: Save & Exit
ESC: Exit

Version 2.16.1242. Copyright (C) 2013 American Megatrends, Inc.
    
```

BIOS Menu 15: Chipset

5.4.1 North Bridge

Use the **North Bridge** menu (**BIOS Menu 16**) to configure the north bridge parameters.

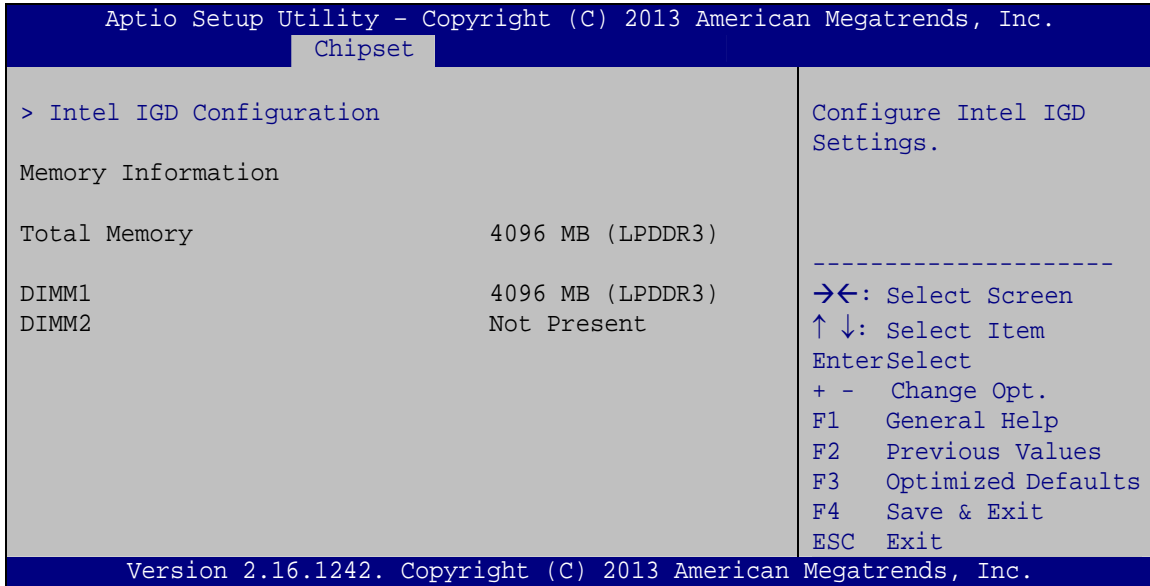

BIOS Menu 16: North Bridge

5.4.1.1 Intel IGD Configuration

Use the **Intel IGD Configuration** submenu (**BIOS Menu 17**) to configure the graphics settings.

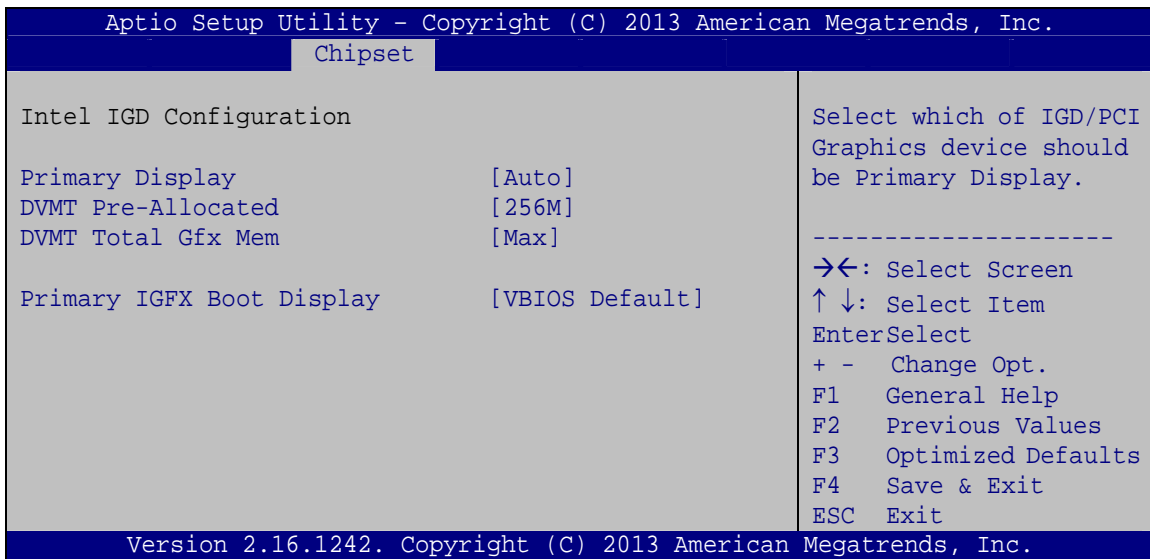

BIOS Menu 17: Intel IGD Configuration

eKINO-BT Mini-ITX SBC

→ Primary Display [Auto]

Use the **Primary Display** option to select the display device used by the system when it boots. Configuration options are listed below.

- Auto **DEFAULT**
- IGD
- PCI

→ DVMT Pre-Allocated [256M]

Use the **DVMT Pre-Allocated** option to specify the amount of system memory that can be used by the internal graphics device.

- 64M 64 MB of memory used by internal graphics device
- 128M 128 MB of memory used by internal graphics device
- 256M **DEFAULT** 256 MB of memory used by internal graphics device
- 512M 512 MB of memory used by internal graphics device

→ DVMT Total Gfx Mem [Max]

Use the **DVMT Total Gfx Mem** option to specify the maximum amount of memory that can be allocated as graphics memory. Configuration options are listed below.

- 128MB
- 256MB
- Max **Default**

→ Primary IGFX Boot Display [VBIOS Default]

Use the **Primary IGFX Boot Display** option to select the display device used by the system when it boots. Configuration options are listed below.

- VBIOS Default **DEFAULT**
- CRT
- LVDS
- LVDS2

5.4.2 Southbridge Configuration

Use the **South Bridge** menu (**BIOS Menu 18**) to configure the Southbridge parameters.

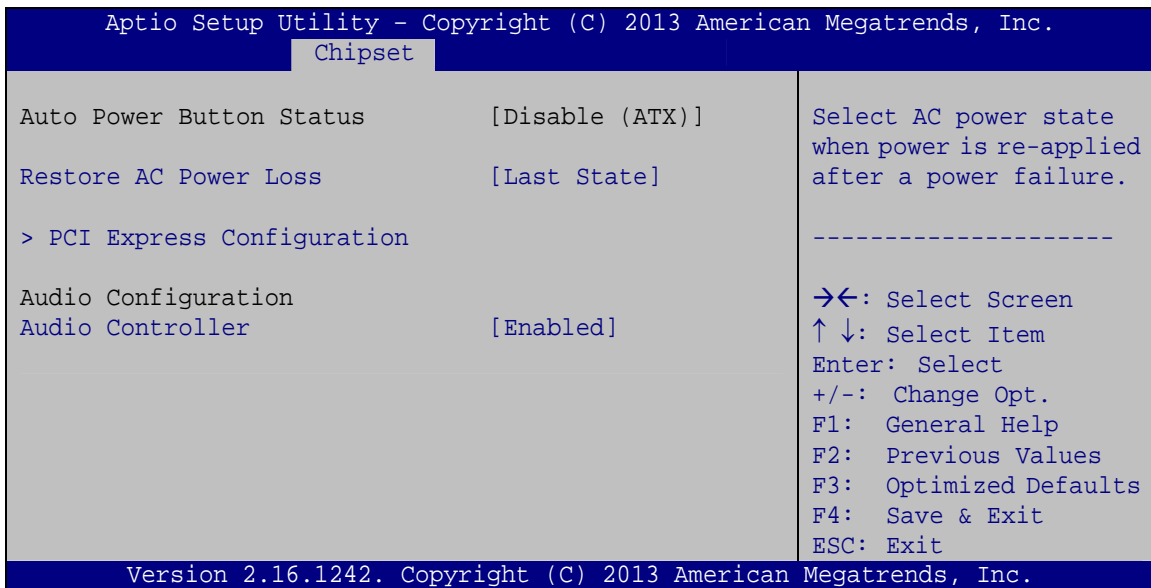

BIOS Menu 18: Southbridge Configuration

➔ Restore AC Power Loss [Last State]

Use the **Restore AC Power Loss** BIOS option to specify what state the system returns to if there is a sudden loss of power to the system.

- ➔ **Power Off** The system remains turned off
- ➔ **Power On** The system turns on
- ➔ **Last State** **DEFAULT** The system returns to its previous state. If it was on, it turns itself on. If it was off, it remains off.

eKINO-BT Mini-ITX SBC

➔ Audio Controller [Enabled]

Use the **Audio Controller** BIOS option to enable or disable the High Definition Audio controller.

➔ **Disabled** The High Definition Audio controller is disabled.

➔ **Enabled** **DEFAULT** The High Definition Audio controller is enabled.

5.4.2.1 PCI Express Configuration

Use the **PCI Express Configuration** menu (**BIOS Menu 19**) to configure the PCI Express slots.

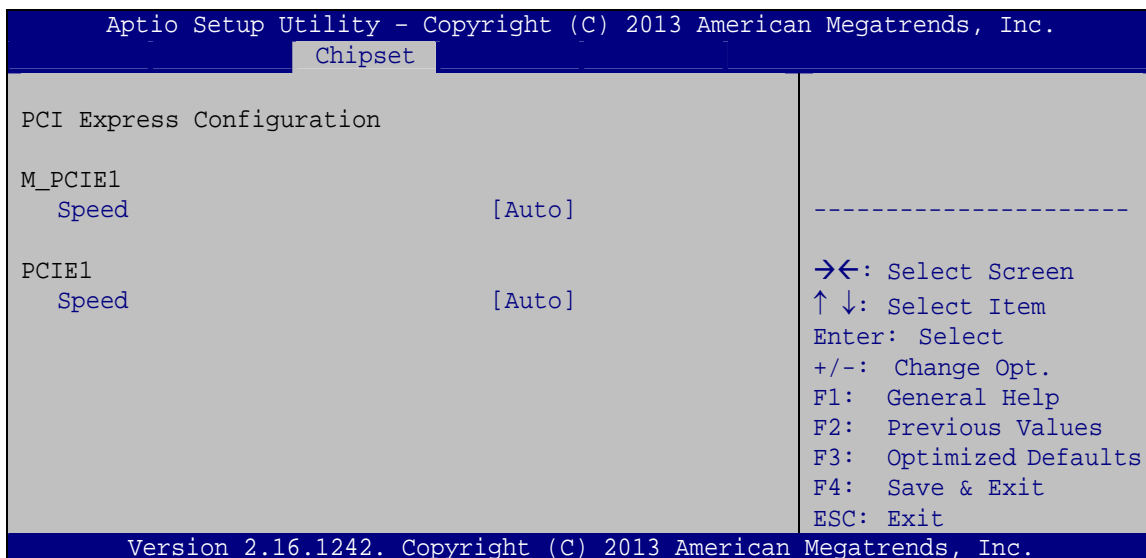

BIOS Menu 19: PCI Express Configuration

➔ Speed [Auto]

Use the **Speed** option to configure the PCIe Mini card and PCIe x1 slot speed.

- Auto **DEFAULT**
- Gen 2
- Gen 1

5.5 Security

Use the **Security** menu (**BIOS Menu 20**) to set system and user passwords.

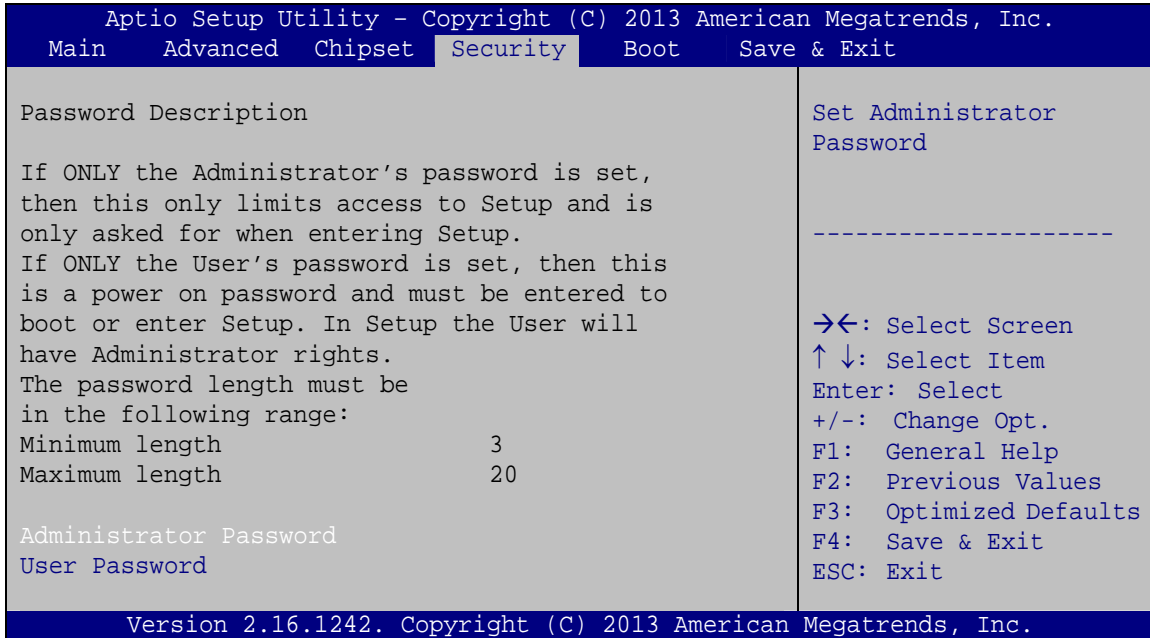

BIOS Menu 20: Security

➔ Administrator Password

Use the **Administrator Password** to set or change an administrator password.

➔ User Password

Use the **User Password** to set or change a user password.

eKINO-BT Mini-ITX SBC

5.6 Boot

Use the **Boot menu (BIOS Menu 21)** to configure system boot options.

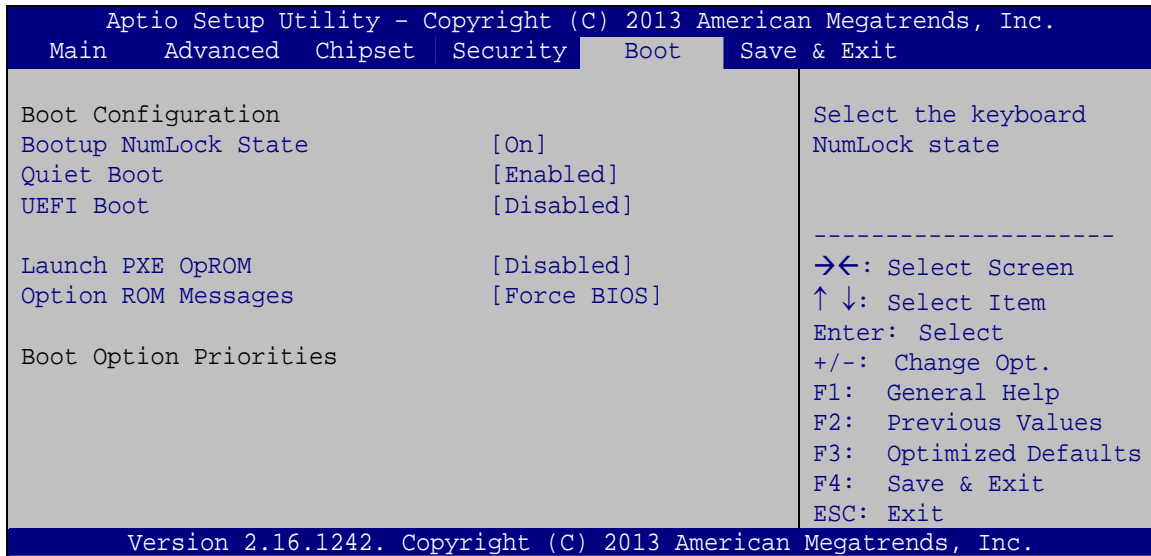

BIOS Menu 21: Boot

→ Bootup NumLock State [On]

Use the **Bootup NumLock State** BIOS option to specify if the number lock setting must be modified during boot up.

- **On** **DEFAULT** Allows the Number Lock on the keyboard to be enabled automatically when the computer system boots up. This allows the immediate use of the 10-key numeric keypad located on the right side of the keyboard. To confirm this, the Number Lock LED light on the keyboard is lit.

- **Off** Does not enable the keyboard Number Lock automatically. To use the 10-keys on the keyboard, press the Number Lock key located on the upper left-hand corner of the 10-key pad. The Number Lock LED on the keyboard lights up when the Number Lock is engaged.

➔ **Quiet Boot [Enabled]**

Use the **Quiet Boot** BIOS option to select the screen display when the system boots.

- ➔ **Disabled** Normal POST messages displayed
- ➔ **Enabled** **DEFAULT** OEM Logo displayed instead of POST messages

➔ **UEFI Boot [Disabled]**

Use the **UEFI Boot** BIOS option to allow the system to boot from the UEFI devices.

- ➔ **Disabled** **DEFAULT** Disables to boot from the UEFI devices.
- ➔ **Enabled** Enables to boot from the UEFI devices.

➔ **Launch PXE OpROM [Disabled]**

Use the **Launch PXE OpROM** option to enable or disable boot option for legacy network devices.

- ➔ **Disabled** **DEFAULT** Ignore all PXE Option ROMs
- ➔ **Enabled** Load PXE Option ROMs.

➔ **Option ROM Messages [Force BIOS]**

Use the **Option ROM Messages** option to set the Option ROM display mode.

- ➔ **Force BIOS** **DEFAULT** Sets display mode to force BIOS.
- ➔ **Keep Current** Sets display mode to current.

5.7 Save & Exit

Use the **Save & Exit** menu (**BIOS Menu 22**) to load default BIOS values, optimal failsafe values and to save configuration changes.

eKINO-BT Mini-ITX SBC

```

Aptio Setup Utility - Copyright (C) 2013 American Megatrends, Inc.
Main   Advanced  Chipset  Security  Boot   Save & Exit
-----
Save Changes and Reset
Discard Changes and Reset

Restore Defaults
Save as User Defaults
Restore User Defaults

Reset the system after
saving the changes.

-----
-><: Select Screen
↑↓: Select Item
Enter: Select
+/-: Change Opt.
F1:  General Help
F2:  Previous Values
F3:  Optimized Defaults
F4:  Save & Exit
ESC: Exit

Version 2.16.1242. Copyright (C) 2013 American Megatrends, Inc.

```

BIOS Menu 22: Save & Exit**→ Save Changes and Reset**

Use the **Save Changes and Reset** option to save the changes made to the BIOS options and reset the system.

→ Discard Changes and Reset

Use the **Discard Changes and Reset** option to exit the system without saving the changes made to the BIOS configuration setup program.

→ Restore Defaults

Use the **Restore Defaults** option to load the optimal default values for each of the parameters on the Setup menus. **F3 key can be used for this operation.**

→ Save as User Defaults

Use the **Save as User Defaults** option to save the changes done so far as user defaults.

→ Restore User Defaults

Use the **Restore User Defaults** option to restore the user defaults to all the setup options.

Chapter

6

Software Drivers

eKINO-BT Mini-ITX SBC

6.1 Available Software Drivers

**NOTE:**

The content of the CD may vary throughout the life cycle of the product and is subject to change without prior notice. Visit the IEI website or contact technical support for the latest updates.

The following drivers can be installed on the system:

- Chipset
- Graphics
- LAN
- Audio

Installation instructions are given below.

6.2 Software Installation

All the drivers for the eKINO-BT are on the CD that came with the system. To install the drivers, please follow the steps below.

Step 1: Insert the CD into a CD drive connected to the system.

**NOTE:**

If the installation program doesn't start automatically:
Click "Start->Computer->CD Drive->Autorun.exe"

Step 2: The driver main menu appears (**Figure 6-1**).

Step 3: Click **eKINO-BT**.



Figure 6-1: Driver CD Main Menu

Step 4: A new screen with a list of available drivers appears (**Figure 6-2**).



Figure 6-2: Available Drivers

Step 5: Install all of the necessary drivers in the menu.

6.3 Chipset Driver Installation

To install the chipset driver, please do the following.

Step 1: Access the driver list. (See **Section 6.2**)

Step 2: Click “**1-Bay Trail SOC**” and select the folder which corresponds to the operating system.



NOTE:

The remainder of this installation assumes Windows 7 as the operating system.

Step 3: Locate the setup file (infinst_autol_9.4.4.1006.exe) and double click on it.

Step 4: When the setup files are completely extracted, the **Welcome Screen** in **Figure 6-3** appears. Click **Next** to continue.



Figure 6-3: Chipset Driver Welcome Screen

Step 5: The **License Agreement** in **Figure 6-4** appears.

Step 6: Click **Yes** to accept the agreement and continue.



Figure 6-4: Chipset Driver License Agreement

Step 7: The **Read Me** file in **Figure 6-5** appears.

Step 8: Click **Next** to continue.

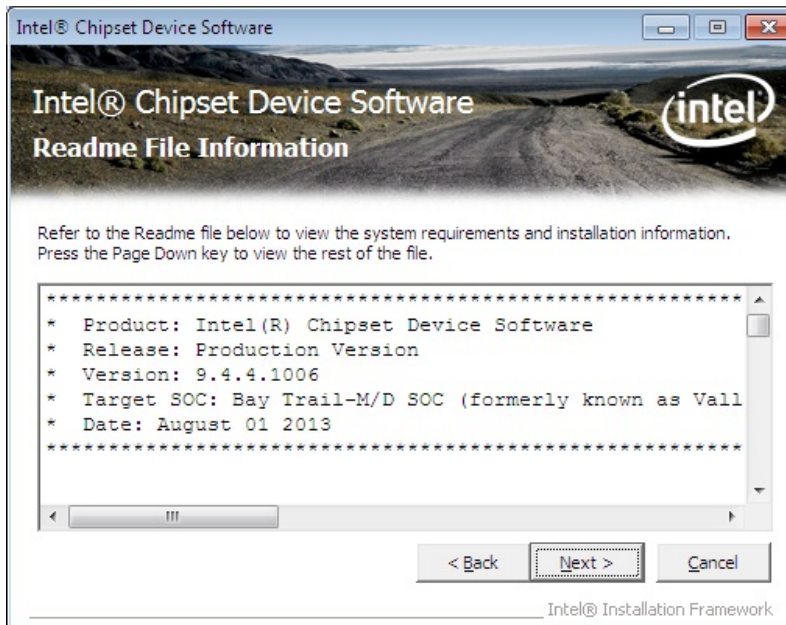

Figure 6-5: Chipset Driver Read Me File

eKINO-BT Mini-ITX SBC

Step 9: Setup Operations are performed as shown in Figure 6-6.

Step 10: Once the Setup Operations are complete, click **Next** to continue.

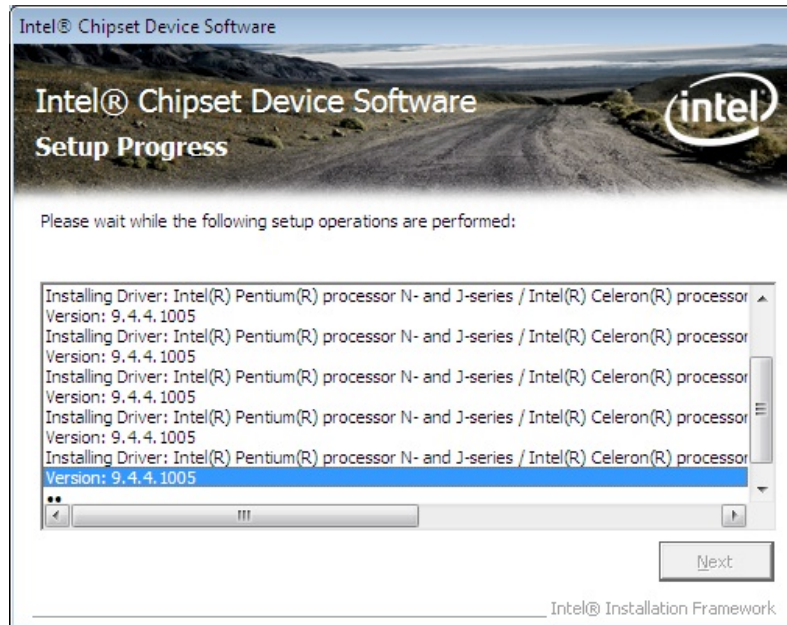

Figure 6-6: Chipset Driver Setup Operations

Step 11: The **Finish** screen in Figure 6-7 appears.

Step 12: Select “**Yes, I want to restart this computer now**” and click **Finish**.



Figure 6-7: Chipset Driver Installation Finish Screen

6.4 Graphics Driver Installation

To install the Graphics driver, please do the following.

Step 1: Access the driver list. (See **Section 6.2**)

Step 2: Click “1-Bay Trail SOC” and select the folder which corresponds to the operating system.



NOTE:

The remainder of this installation assumes Windows 7 as the operating system.

Step 3: Unzip the file called **INTEL_EMGD.WIN7_PC_VERSION_36_15_0_1064**, and then locate the setup file and double click on it to start the installation.

If a 64-bit operating system is installed, please unzip the

INTEL_EMGD.WIN7_BETA_VERSION_37_15_0_1055 file to install the graphics driver.

eKINO-BT Mini-ITX SBC

**NOTE:**

To install graphics driver on a 32-bit Windows 8 system, unzip **15.33.7.3366**.

To install graphics driver on a 64-bit Windows 8 system, unzip **15.33.7.64.336**.

Step 4: The **Welcome Screen** in **Figure 6-8** appears.

Step 5: Click **Next** to continue.

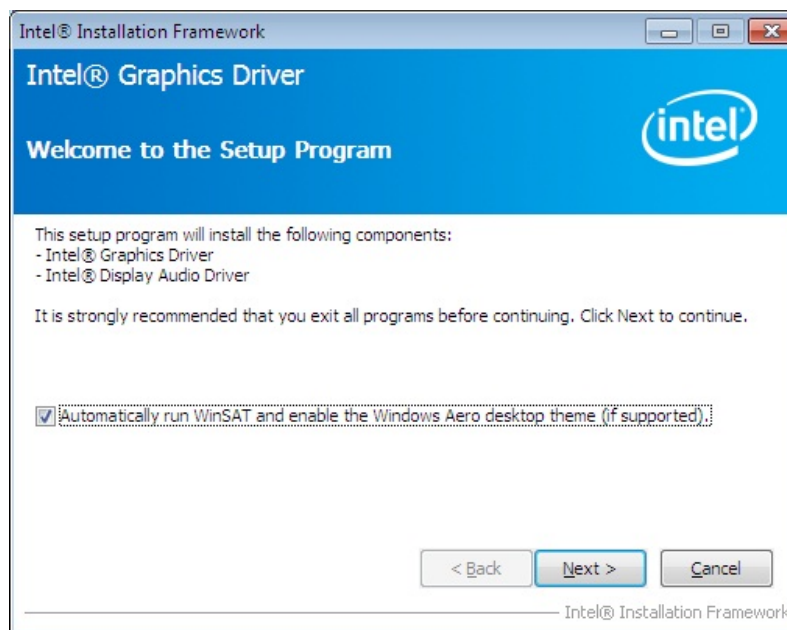

Figure 6-8: Graphics Driver Welcome Screen

Step 6: The **License Agreement** in **Figure 6-9** appears.

Step 7: Click **Yes** to accept the agreement and continue.

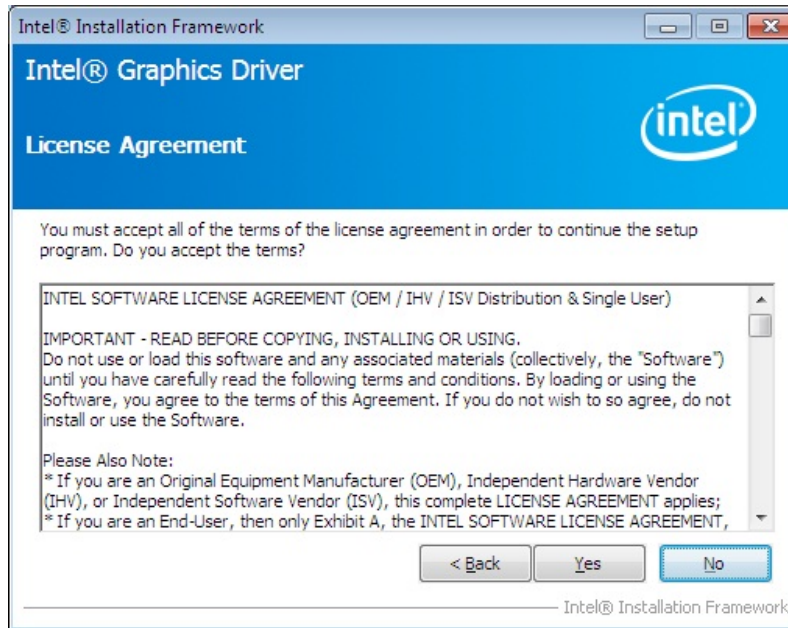

Figure 6-9: Graphics Driver License Agreement

Step 8: The Read Me file in **Figure 6-10** appears. Click **Next** to continue.

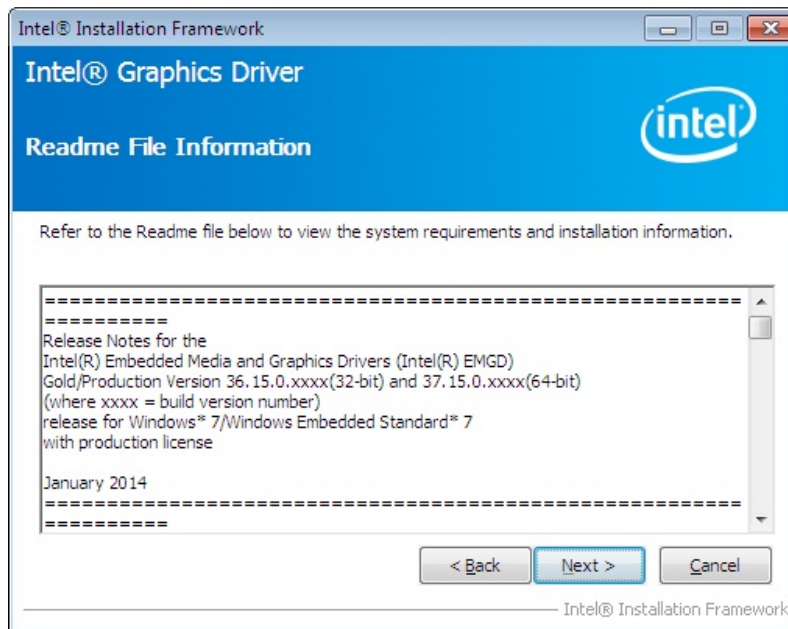

Figure 6-10: Graphics Driver Read Me File

Step 9: **Setup Operations** are performed as shown in **Figure 6-11**.

Step 10: Once the **Setup Operations** are complete, click **Next** to continue.

eKINO-BT Mini-ITX SBC

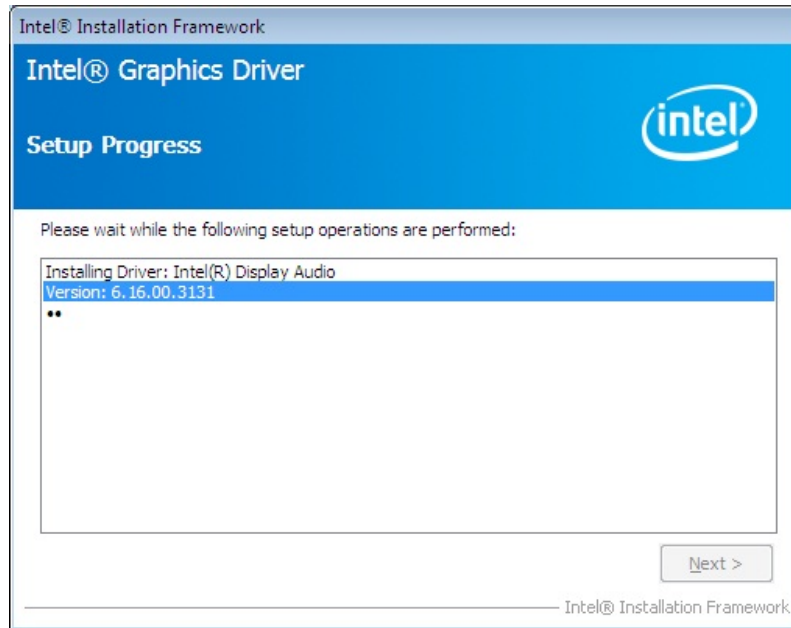

Figure 6-11: Graphics Driver Setup Operations

Step 11: The system starts installing the graphics driver.

Step 12: The **Finish** screen in **Figure 6-12** appears.

Step 13: Select **“Yes, I want to restart this computer now”** and click **Finish**.

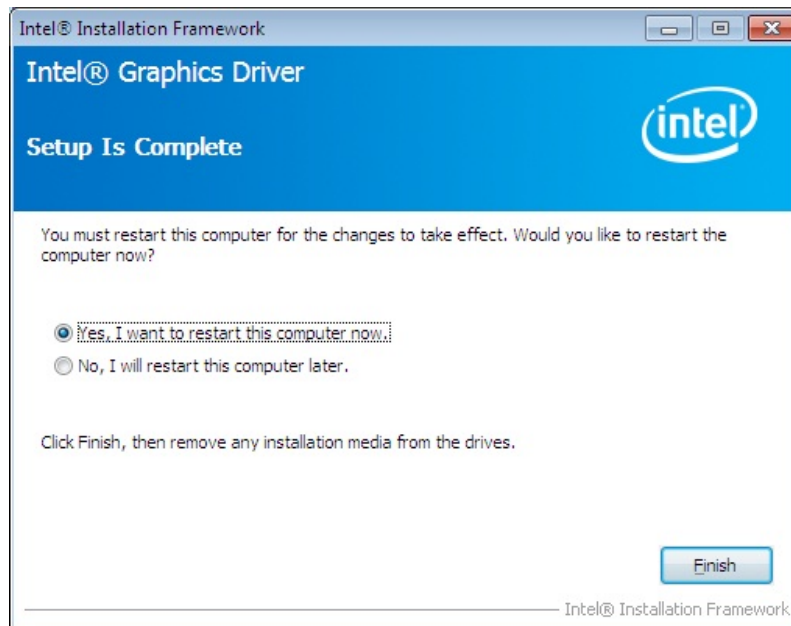

Figure 6-12: Graphics Driver Installation Finish Screen

6.5 LAN Driver Installation

To install the LAN driver, please do the following.

Step 1: Access the driver list. (See **Section 6.2**)

Step 2: Click **2-LAN**.

Step 3: Select the **Realtek** folder.

Step 4: Select the folder which corresponds to the operating system.

Step 5: Locate the setup file and double click on it.

Step 6: The **Welcome** screen in **Figure 6-13** appears.

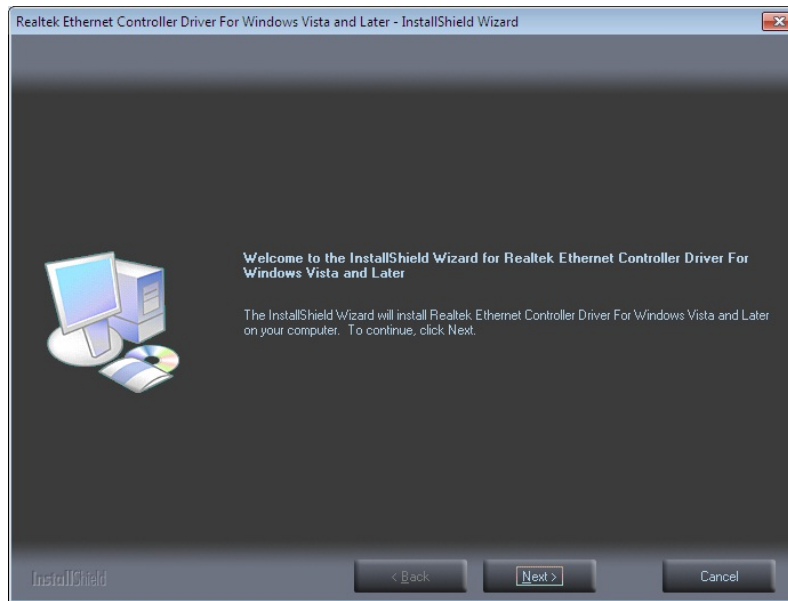

Figure 6-13: LAN Driver Welcome Screen

Step 7: Click **Next** to continue.

Step 8: The **Ready to Install the Program** screen in **Figure 6-14** appears.

Step 9: Click **Install** to proceed with the installation.

eKINO-BT Mini-ITX SBC

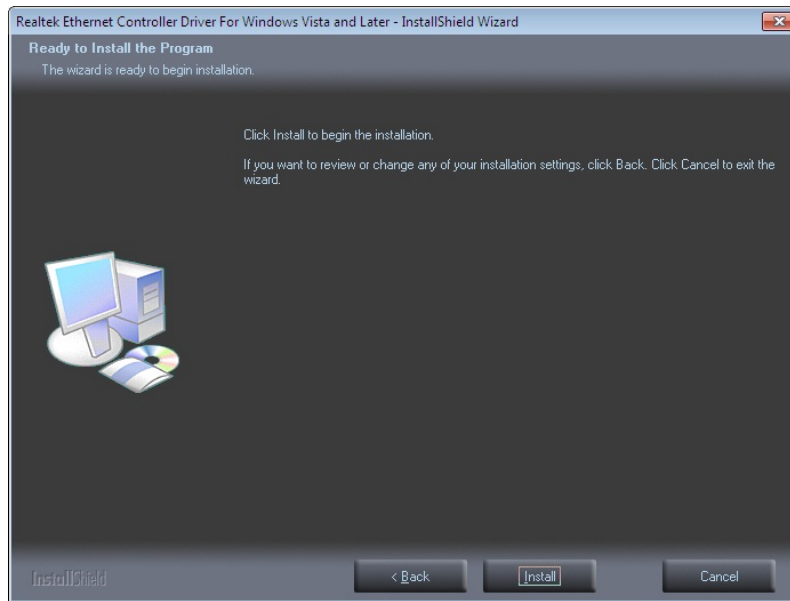

Figure 6-14: LAN Driver Installation

Step 10: The program begins to install.

Step 11: When the driver installation is complete, the screen in **Figure 6-15** appears.

Step 12: Click **Finish** to exit.

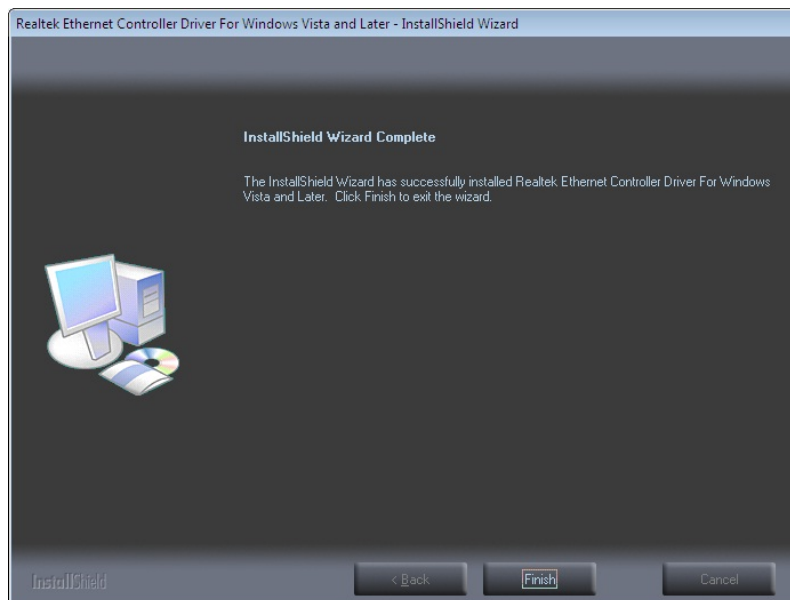

Figure 6-15: LAN Driver Installation Complete

6.6 Audio Driver Installation

To install the Audio driver, please do the following.

Step 1: Access the driver list. (See **Section 6.2**)

Step 2: Click **3-AUDIO**.

Step 3: Double click the setup file.

Step 4: The **InstallShield Wizard** is prepared to guide the user through the rest of the process.

Step 5: Once initialized, the **InstallShield Wizard** welcome screen appears (**Figure 6-16**).



Figure 6-16: Audio Driver Welcome Screen

Step 6: Click **Yes** to continue.

Step 7: The program begins to install. See **Figure 6-17**.

eKINO-BT Mini-ITX SBC

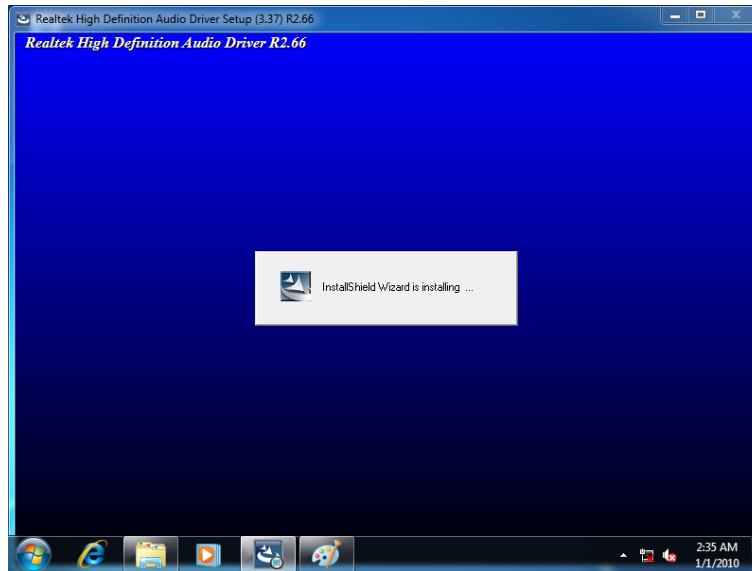

Figure 6-17: Audio Driver Installation

Step 8: When the driver installation is complete, the screen in **Figure 6-18** appears.



Figure 6-18: Audio Driver Installation Complete

Step 9: Select “Yes, I want to restart my computer now” and click **OK**.

Step 10: The system reboots.

Appendix

A

Regulatory Compliance

DECLARATION OF CONFORMITY



This equipment has been tested and found to comply with specifications for CE marking. If the user modifies and/or installs other devices in the equipment, the CE conformity declaration may no longer apply.

FCC WARNING



This equipment complies with Part 15 of the FCC Rules. Operation is subject to the following two conditions:

- This device may not cause harmful interference, and
- This device must accept any interference received, including interference that may cause undesired operation.

This equipment has been tested and found to comply with the limits for a Class A digital device, pursuant to part 15 of the FCC Rules. These limits are designed to provide reasonable protection against harmful interference when the equipment is operated in a commercial environment. This equipment generates, uses, and can radiate radio frequency energy and, if not installed and used in accordance with the instruction manual, may cause harmful interference to radio communications. Operation of this equipment in a residential area is likely to cause harmful interference in which case the user will be required to correct the interference at his own expense.

Appendix

B

Product Disposal

**CAUTION:**

Risk of explosion if battery is replaced by an incorrect type. Only certified engineers should replace the on-board battery.

Dispose of used batteries according to instructions and local regulations.

- Outside the European Union – If you wish to dispose of used electrical and electronic products outside the European Union, please contact your local authority so as to comply with the correct disposal method.
- Within the European Union – The device that produces less waste and is easier to recycle is classified as electronic device in terms of the European Directive 2012/19/EU (WEEE), and must not be disposed of as domestic garbage.

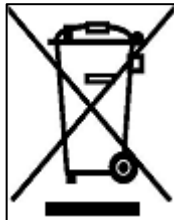

EU-wide legislation, as implemented in each Member State, requires that waste electrical and electronic products carrying the mark (left) must be disposed of separately from normal household waste. This includes monitors and electrical accessories, such as signal cables or power cords. When you need to dispose of your device, please follow the guidance of your local authority, or ask the shop where you purchased the product. The mark on electrical and electronic products only applies to the current European Union Member States.

Please follow the national guidelines for electrical and electronic product disposal.

Appendix

C

BIOS Options

eKINO-BT Mini-ITX SBC

Below is a list of BIOS configuration options in the BIOS chapter.

System Date [xx/xx/xx]	84
System Time [xx:xx:xx]	85
ACPI Sleep State [S3 (Suspend to RAM)]	86
Serial Port [Enabled]	88
Change Settings [Auto]	88
Serial Port [Enabled]	88
Change Settings [Auto]	89
Serial Port [Enabled]	89
Change Settings [Auto]	89
Serial Port [Enabled]	90
Change Settings [Auto]	90
Serial Port [Enabled]	91
Change Settings [Auto]	91
Serial Port [Enabled]	92
Change Settings [Auto]	92
Duplex Function [Full Duplex]	93
PC Health Status	94
CPU_FAN1 Smart Fan Control [Manual Mode]	95
SYS_FAN1 Smart Fan Control [Auto Mode]	95
Auto mode fan start/off temperature	96
Auto mode fan start PWM	96
Auto mode fan slope PWM	96
Wake system with Fixed Time [Disabled]	97
Console Redirection [Disabled]	98
Terminal Type [ANSI]	99
Bits per second [115200]	99
Data Bits [8]	99
Parity [None]	99
Stop Bits [1]	100
Intel Virtualization Technology [Enabled]	101
EIST [Enabled]	101
Serial-ATA (SATA) [Enabled]	102
SATA Mode Selection [IDE Mode]	102

Security Device Support [Disable]	103
USB Devices	104
Legacy USB Support [Enabled].....	104
Primary Display [Auto]	107
DVMT Pre-Allocated [256M]	107
DVMT Total Gfx Mem [Max].....	107
Primary IGFX Boot Display [VBIOS Default]	107
Restore AC Power Loss [Last State]	108
Audio Controller [Enabled]	109
Speed [Auto].....	109
Administrator Password	110
User Password	110
Bootup NumLock State [On].....	111
Quiet Boot [Enabled]	112
UEFI Boot [Disabled]	112
Launch PXE OpROM [Disabled]	112
Option ROM Messages [Force BIOS].....	112
Save Changes and Reset	113
Discard Changes and Reset	113
Restore Defaults	113
Save as User Defaults	113
Restore User Defaults	113

Appendix

D

Terminology

AC '97	Audio Codec 97 (AC'97) refers to a codec standard developed by Intel® in 1997.
ACPI	Advanced Configuration and Power Interface (ACPI) is an OS-directed configuration, power management, and thermal management interface.
AHCI	Advanced Host Controller Interface (AHCI) is a SATA Host controller register-level interface.
ATA	The Advanced Technology Attachment (ATA) interface connects storage devices including hard disks and CD-ROM drives to a computer.
ARMD	An ATAPI Removable Media Device (ARMD) is any ATAPI device that supports removable media, besides CD and DVD drives.
ASKIR	Amplitude Shift Keyed Infrared (ASKIR) is a form of modulation that represents a digital signal by varying the amplitude (“volume”) of the signal. A low amplitude signal represents a binary 0, while a high amplitude signal represents a binary 1.
BIOS	The Basic Input/Output System (BIOS) is firmware that is first run when the computer is turned on and can be configured by the end user
CODEC	The Compressor-Decompressor (CODEC) encodes and decodes digital audio data on the system.
CompactFlash®	CompactFlash® is a solid-state storage device. CompactFlash® devices use flash memory in a standard size enclosure. Type II is thicker than Type I, but a Type II slot can support both types.
CMOS	Complimentary metal-oxide-conductor is an integrated circuit used in chips like static RAM and microprocessors.
COM	COM refers to serial ports. Serial ports offer serial communication to expansion devices. The serial port on a personal computer is usually a male DB-9 connector.
DAC	The Digital-to-Analog Converter (DAC) converts digital signals to analog signals.
DDR	Double Data Rate refers to a data bus transferring data on both the rising and falling edges of the clock signal.

eKINO-BT Mini-ITX SBC

DMA	Direct Memory Access (DMA) enables some peripheral devices to bypass the system processor and communicate directly with the system memory.
DIMM	Dual Inline Memory Modules are a type of RAM that offer a 64-bit data bus and have separate electrical contacts on each side of the module.
DIO	The digital inputs and digital outputs are general control signals that control the on/off circuit of external devices or TTL devices. Data can be read or written to the selected address to enable the DIO functions.
EHCI	The Enhanced Host Controller Interface (EHCI) specification is a register-level interface description for USB 2.0 Host Controllers.
EIDE	Enhanced IDE (EIDE) is a newer IDE interface standard that has data transfer rates between 4.0 MBps and 16.6 MBps.
EIST	Enhanced Intel® SpeedStep Technology (EIST) allows users to modify the power consumption levels and processor performance through application software. The application software changes the bus-to-core frequency ratio and the processor core voltage.
FSB	The Front Side Bus (FSB) is the bi-directional communication channel between the processor and the Northbridge chipset.
GbE	Gigabit Ethernet (GbE) is an Ethernet version that transfers data at 1.0 Gbps and complies with the IEEE 802.3-2005 standard.
GPIO	General purpose input
HDD	Hard disk drive (HDD) is a type of magnetic, non-volatile computer storage device that stores digitally encoded data.
ICH	The Input/Output Control Hub (ICH) is an Intel® Southbridge chipset.
IrDA	Infrared Data Association (IrDA) specify infrared data transmission protocols used to enable electronic devices to wirelessly communicate with each other.
L1 Cache	The Level 1 Cache (L1 Cache) is a small memory cache built into the system processor.
L2 Cache	The Level 2 Cache (L2 Cache) is an external processor memory cache.

LCD	Liquid crystal display (LCD) is a flat, low-power display device that consists of two polarizing plates with a liquid crystal panel in between.
LVDS	Low-voltage differential signaling (LVDS) is a dual-wire, high-speed differential electrical signaling system commonly used to connect LCD displays to a computer.
POST	The Power-on Self Test (POST) is the pre-boot actions the system performs when the system is turned-on.
RAM	Random Access Memory (RAM) is volatile memory that loses data when power is lost. RAM has very fast data transfer rates compared to other storage like hard drives.
SATA	Serial ATA (SATA) is a serial communications bus designed for data transfers between storage devices and the computer chipsets.
S.M.A.R.T	Self Monitoring Analysis and Reporting Technology (S.M.A.R.T) refers to automatic status checking technology implemented on hard disk drives.
UART	Universal Asynchronous Receiver-transmitter (UART) is responsible for asynchronous communications on the system and manages the system's serial communication (COM) ports.
UHCI	The Universal Host Controller Interface (UHCI) specification is a register-level interface description for USB 1.1 Host Controllers.
USB	The Universal Serial Bus (USB) is an external bus standard for interfacing devices. USB 1.1 supports 12Mbps data transfer rates and USB 2.0 supports 480Mbps data transfer rates.
VGA	The Video Graphics Array (VGA) is a graphics display system developed by IBM.

Appendix

E

Digital I/O Interface

E.1 Introduction

The DIO connector on the eKINO-BT is interfaced to GPIO ports on the Super I/O chipset. The digital inputs and digital outputs are generally control signals that control the on/off circuit of external devices or TTL devices. Data can be read or written to the selected address to enable the DIO functions.



NOTE:

For further information, please refer to the datasheet for the Super I/O chipset.

The BIOS interrupt call **INT 15H** controls the digital I/O.

INT 15H:

AH – 6FH
<u>Sub-function:</u>
AL – 8 : Set the digital port as INPUT
AL : Digital I/O input value

eKINO-BT Mini-ITX SBC

E.2 Assembly Language Sample 1

```

MOV     AX, 6F08H      ;setting the digital port as input
INT     15H           ;

```

AL low byte = value

AH – 6FH
<u>Sub-function:</u>
AL – 9 : Set the digital port as OUTPUT
BL : Digital I/O input value

E.3 Assembly Language Sample 2

```

MOV     AX, 6F09H      ;setting the digital port as output
MOV     BL, 09H        ;digital value is 09H
INT     15H           ;

```

Digital Output is 1001b

Appendix

F

Hazardous Materials Disclosure

eKINO-BT Mini-ITX SBC

The details provided in this appendix are to ensure that the product is compliant with the Peoples Republic of China (China) RoHS standards. The table below acknowledges the presences of small quantities of certain materials in the product, and is applicable to China RoHS only.

A label will be placed on each product to indicate the estimated “Environmentally Friendly Use Period” (EFUP). This is an estimate of the number of years that these substances would “not leak out or undergo abrupt change.” This product may contain replaceable sub-assemblies/components which have a shorter EFUP such as batteries and lamps. These components will be separately marked.

Please refer to below table.

Part Name	Toxic or Hazardous Substances and Elements					
	Lead (Pb)	Mercury (Hg)	Cadmium (Cd)	Hexavalent Chromium (CR(VI))	Polybrominated Biphenyls (PBB)	Polybrominated Diphenyl Ethers (PBDE)
Housing	O	O	O	O	O	O
Display	O	O	O	O	O	O
Printed Circuit Board	O	O	O	O	O	O
Metal Fasteners	O	O	O	O	O	O
Cable Assembly	O	O	O	O	O	O
Fan Assembly	O	O	O	O	O	O
Power Supply Assemblies	O	O	O	O	O	O
Battery	O	O	O	O	O	O

O: This toxic or hazardous substance is contained in all of the homogeneous materials for the part is below the limit requirement in SJ/T11363-2006 (now replaced by GB/T 26572-2011).

X: This toxic or hazardous substance is contained in at least one of the homogeneous materials for this part is above the limit requirement in SJ/T11363-2006 (now replaced by GB/T 26572-2011).

此附件旨在确保本产品符合中国 RoHS 标准。以下表格标示此产品中某有毒物质的含量符合中国 RoHS 标准规定的限量要求。

本产品上会附有“环境友好使用期限”的标签，此期限是估算这些物质“不会有泄漏或突变”的年限。本产品可能包含有较短的环境友好使用期限的可替换元件，像是电池或灯管，这些元件将会单独标示出来。

部件名称	有毒有害物质或元素					
	铅 (Pb)	汞 (Hg)	镉 (Cd)	六价铬 (CR(VI))	多溴联苯 (PBB)	多溴二苯 醚 (PBDE)
壳体	○	○	○	○	○	○
显示	○	○	○	○	○	○
印刷电路板	○	○	○	○	○	○
金属螺帽	○	○	○	○	○	○
电缆组装	○	○	○	○	○	○
风扇组装	○	○	○	○	○	○
电力供应组装	○	○	○	○	○	○
电池	○	○	○	○	○	○

○: 表示该有毒有害物质在该部件所有物质材料中的含量均在 SJ/T 11363-2006 (现由 GB/T 26572-2011 取代) 标准规定的限量要求以下。

X: 表示该有毒有害物质至少在该部件的某一均质材料中的含量超出 SJ/T 11363-2006 (现由 GB/T 26572-2011 取代) 标准规定的限量要求。