



MODEL:
FLEX-BX100-ULT5

**AI Box PC with 8th Gen. Intel® Core™ i5-8365UE CPU,
DDR4, HDMI, USB 3.2 Gen 2, Triple GbE,
RS-232/422/485, M.2 M-key/A-key, PoE, RoHS Compliant**

User Manual

Revision

Date	Version	Changes
January 14, 2021	1.00	Initial release



Safety Instructions

- en** Warning! Read the user manual before connecting the system to the power source.
- de** Vorsicht! Bitte lesen Sie die Bedienungsanleitung, bevor Sie das System an eine Stromquelle anschließen.
- fr** Attention! Avant de brancher le système à la source d'alimentation, consultez le mode d'emploi.
- it** Avvertenza! Consultare il manuale utente prima di collegare il sistema all'alimentatore.
- es** Atención! Lea atentamente este manual del usuario antes de operar la fuente de alimentación.
- zh** 警告！在將系統連接到電源之前，請仔細閱讀使用手冊。
- cn** 警告！在將系統連接到電源之前，請仔細閱讀使用手冊。
-

- en** Warning! To prevent the system from overheating, do not operate it in an area that exceeds the maximum operating temperature described in the user manual.
- de** Vorsicht! Um eine Überhitzung des Systems zu vermeiden, betreiben Sie es ausschließlich im zulässigen Betriebstemperaturbereich. Dieser ist in der Bedienungsanleitung vermerkt.
- fr** Attention! Pour éviter la surchauffe du système, ne l'utilisez pas dans une zone dont la température dépasse les limites décrits dans le mode d'emploi.
- it** Avvertenza! Per evitare che il sistema si surriscaldi, non utilizzarlo in aree che superino la temperatura massima d'esercizio descritta nel manuale utente.
- es** Atención! Para evitar el excesivo calentamiento del sistema, no opere en las condiciones de temperatura superior a lo recomendado en este manual del usuario.
- zh** 警告！為防止系統過熱，不要在使用手冊上記載的產品工作溫度範圍之外操作此系統。
- cn** 警告！為防止系統過熱，不要在使用手冊上記載的產品工作溫度範圍之外操作此系統。
-

-
- en** Warning! Ultimate disposal of this product should be handled according to all national laws and regulations.
 - de** Vorsicht! Die Entsorgung dieses Produkts sollte gemäß allen Bestimmungen und Gesetzen des Landes erfolgen.
 - fr** Attention! La mise au rebut ou le recyclage de ce produit sont généralement soumis aux lois et/ou directives de respect de l'environnement. Renseignez-vous auprès de l'organisme compétent.
 - it** Avvertenza! Lo smaltimento di questo prodotto deve essere eseguito secondo le leggi e i regolamenti locali.
 - es** Atención! La disposición final de residuos de este producto se debe cumplir con las normativas y leyes del país.
 - zh** 警告！本產品的廢棄處理應根據該國家的法律和規章進行。
 - cn** 警告！本产品的废弃处理应根据该国家的法律和规章进行。
-

Copyright

COPYRIGHT NOTICE

The information in this document is subject to change without prior notice in order to improve reliability, design and function and does not represent a commitment on the part of the manufacturer.

In no event will the manufacturer be liable for direct, indirect, special, incidental, or consequential damages arising out of the use or inability to use the product or documentation, even if advised of the possibility of such damages.

This document contains proprietary information protected by copyright. All rights are reserved. No part of this manual may be reproduced by any mechanical, electronic, or other means in any form without prior written permission of the manufacturer.

TRADEMARKS

All registered trademarks and product names mentioned herein are used for identification purposes only and may be trademarks and/or registered trademarks of their respective owners.

Manual Conventions



WARNING

Warnings appear where overlooked details may cause damage to the equipment or result in personal injury. Warnings should be taken seriously.



CAUTION

Cautionary messages should be heeded to help reduce the chance of losing data or damaging the product.



NOTE

These messages inform the reader of essential but non-critical information. These messages should be read carefully as any directions or instructions contained therein can help avoid making mistakes.

Table of Contents

1 INTRODUCTION.....	1
1.1 OVERVIEW.....	2
1.2 MODEL VARIATIONS.....	2
1.3 FEATURES.....	3
1.4 FRONT PANEL.....	3
1.5 REAR PANEL.....	4
1.6 TOP PANEL.....	4
1.7 BOTTOM PANEL.....	5
1.8 TECHNICAL SPECIFICATIONS.....	6
1.9 DIMENSIONS.....	8
2 UNPACKING.....	9
2.1 UNPACKING.....	10
2.2 PACKING LIST.....	10
2.3 OPTIONAL ITEMS.....	12
3 INSTALLATION.....	13
3.1 ANTI-STATIC PRECAUTIONS.....	14
3.2 INSTALLATION PRECAUTIONS.....	14
3.3 INSTALLATION PROCEDURE.....	15
3.4 HDD INSTALLATION.....	16
3.5 PoE PD MODULE INSTALLATION (OPTIONAL).....	18
3.6 M.2 SSD INSTALLATION (OPTIONAL).....	19
3.7 WIRELESS LAN MODULE INSTALLATION (OPTIONAL).....	22
3.8 MOUNTING THE SYSTEM.....	25
3.9 RS-232/422/485 SERIAL PORT (COM1) SELECTION.....	26
3.9.1 COM1 Pinouts.....	26
3.9.2 COM1 Pin 9 Selection.....	27
3.10 CLEAR CMOS.....	28
3.11 AT/ATX MODE SELECTION.....	28
3.12 POWER-ON PROCEDURE.....	29

3.12.1	<i>Installation Checklist</i>	29
3.12.2	<i>Power-on Procedure</i>	29
3.13	RESET THE SYSTEM	30
3.14	SOFTWARE INSTALLATION	30
3.14.1	<i>Driver Download</i>	31
4	BIOS	33
4.1	INTRODUCTION.....	34
4.1.1	<i>Starting Setup</i>	34
4.1.2	<i>Using Setup</i>	34
4.1.3	<i>Getting Help</i>	35
4.1.4	<i>BIOS Menu Bar</i>	35
4.2	MAIN.....	36
4.3	ADVANCED	37
4.3.1	<i>CPU Configuration</i>	38
4.3.2	<i>PCH-FW Configuration</i>	40
4.3.2.1	<i>PTT Configuration</i>	41
4.3.3	<i>Trusted Computing</i>	42
4.3.4	<i>ACPI Settings</i>	43
4.3.5	<i>RTC Wake Settings</i>	44
4.3.6	<i>iWDD H/W Monitor</i>	45
4.3.7	<i>F81866 Super IO Configuration</i>	46
4.3.7.1	<i>Serial Port n Configuration</i>	47
4.3.8	<i>Serial Port Console Redirection</i>	48
4.3.8.1	<i>Legacy Console Redirection Settings</i>	49
4.3.8.2	<i>Console Redirection Settings</i>	50
4.3.9	<i>USB Configuration</i>	52
4.3.10	<i>CSM Configuration</i>	53
4.3.11	<i>NVMe Configuration</i>	54
4.3.12	<i>IEI Feature</i>	55
4.4	CHIPSET	56
4.4.1	<i>System Agent (SA) Configuration</i>	56
4.4.1.1	<i>Memory Configuration</i>	57
4.4.1.2	<i>Graphics Configuration</i>	58
4.4.2	<i>PCH-IO Configuration</i>	59

FLEX-BX100-ULT5

4.4.2.1 PCI Express Configuration	61
4.4.2.2 SATA And RST Configuration.....	62
4.5 SECURITY.....	64
4.6 BOOT.....	65
4.7 SAVE & EXIT	67
5 TROUBLESHOOTING AND MAINTENANCE	68
5.1 SYSTEM MAINTENANCE OVERVIEW	69
5.2 SYSTEM TROUBLESHOOTING.....	69
5.2.1 <i>The System Doesn't Turn On</i>	69
5.2.2 <i>The System Doesn't Boot Up</i>	70
5.2.3 <i>More Troubleshooting</i>	70
5.3 COMPONENT REPLACEMENT	71
6 INTERFACE CONNECTORS	72
6.1 PERIPHERAL INTERFACE CONNECTORS.....	73
6.2 INTERNAL PERIPHERAL CONNECTORS	74
6.2.1 <i>Battery Connector (BAT1)</i>	74
6.2.2 <i>Digital I/O Connector (DIO1)</i>	75
6.2.3 <i>Inverter Connector (INVERTER1)</i>	75
6.2.4 <i>LVDS Connector (LVDS1)</i>	75
6.2.5 <i>M.2 A-Key Slot (M2_A1)</i>	76
6.2.6 <i>M.2 M-key Slot (M2_M2)</i>	77
6.2.7 <i>Power Button Connector (PWR_BTN2)</i>	79
6.2.8 <i>SATA Connector (SATA1)</i>	79
6.2.9 <i>SMBus Connector (SMB1)</i>	80
6.2.10 <i>SPI Flash Connector (JSPI1)</i>	80
6.2.11 <i>USB Connector (TOUCH_USB1)</i>	80
6.2.12 <i>USB Connector (EXT_USB1)</i>	81
6.3 EXTERNAL INTERFACE PANEL CONNECTORS	81
6.3.1 <i>Ethernet Connectors (LAN1, J1, J2)</i>	82
6.3.2 <i>HDMI Connector (HDMI1)</i>	82
6.3.3 <i>Power Connector (PWR3)</i>	83
6.3.4 <i>RS-232/422/485 DB-9 Serial Port (COM1)</i>	83
6.3.5 <i>RS-232 RJ-45 Serial Port (COM2)</i>	83

6.3.6 USB 3.2 Gen 2 Connectors (USB_CON1, USB_CON2)	84
6.4 JUMPERS.....	84
6.4.1 Flash Descriptor Security Override Jumper.....	84
A REGULATORY COMPLIANCE	86
B SAFETY PRECAUTIONS	91
B.1 SAFETY PRECAUTIONS.....	92
B.1.1 General Safety Precautions	92
B.1.2 Anti-static Precautions	93
B.1.3 Product Disposal	94
B.2 MAINTENANCE AND CLEANING PRECAUTIONS	95
B.2.1 Maintenance and Cleaning.....	95
B.2.2 Cleaning Tools.....	95
C BIOS MENU OPTIONS.....	97
C.1 BIOS CONFIGURATION OPTIONS	98
D WATCHDOG TIMER	100
E ERROR BEEP CODE.....	103
E.1 PEI BEEP CODES.....	104
E.2 DXE BEEP CODES	104
F HAZARDOUS MATERIALS DISCLOSURE.....	105
F.1 RoHS II DIRECTIVE (2015/863/EU)	106
F.2 CHINA RoHS.....	107

List of Figures

Figure 1-1: FLEX-BX100-ULT5 Series Box PC.....	2
Figure 1-2: Front Panel	3
Figure 1-3: Rear Panel.....	4
Figure 1-4: Top Panel	4
Figure 1-5: Bottom Panel	5
Figure 1-6: Dimensions with Mounting Brackets (mm)	8
Figure 3-1: HDD Cover Retention Screws	16
Figure 3-2: HDD Bracket Retention Screws	16
Figure 3-3: HDD Retention Screws	17
Figure 3-4: HDD Installation	17
Figure 3-5: PoE Card Cover Retention Screws	18
Figure 3-6: PoE Module Slot Location.....	18
Figure 3-7: Rear Cover Retention Screws.....	19
Figure 3-8: M.2 Slot Location	20
Figure 3-9: Removing the M.2 Module Retention Screw	20
Figure 3-10: Inserting the M.2 Module into the Slot at an Angle	21
Figure 3-11: Securing the M.2 Module.....	21
Figure 3-12: Knockouts on Rear Panel for Wireless Antennas	22
Figure 3-13: M.2 A-key Slot Location.....	22
Figure 3-14: Inserting the WLAN Module	23
Figure 3-15: Securing the WLAN Module	23
Figure 3-16: Connecting RF Cables.....	24
Figure 3-17: Securing SMA Connector and External Antenna Installation	24
Figure 3-18: Mounting Bracket Retention Screws	25
Figure 3-19: Mounting Bracket Retention Screws	25
Figure 3-20: COM1 Pin 9 Setting Jumper Location.....	27
Figure 3-21: Clear CMOS Button Location.....	28
Figure 3-22: AT/ATX Switch Location.....	28
Figure 3-23: Power Button.....	29
Figure 3-24: Reset Button Location.....	30
Figure 3-25: IEI Resource Download Center.....	30

Figure 6-1: Main Board Layout Diagram73

List of Tables

Table 1-1: Model Variations	2
Table 1-2: Technical Specifications.....	7
Table 2-1: Package List.....	11
Table 2-2: Optional Items.....	12
Table 3-1: RS-232/422/485 Serial Port (COM1) Pinouts	26
Table 3-2: COM1 Pin 9 Setting Jumper Settings (JP5)	27
Table 4-1: BIOS Navigation Keys	35
Table 6-1: Peripheral Interface Connectors	74
Table 6-2: Battery Connector (BAT1) Pinouts	74
Table 6-3: Digital I/O Connector (DIO1) Pinouts.....	75
Table 6-4: Inverter Connector (INVERTER1) Pinouts.....	75
Table 6-5: LVDS Connector (LVDS1) Pinouts.....	76
Table 6-6: M.2 A-Key Slot (M2_A1) Pinouts	77
Table 6-7: M.2 M-key Slot (M2_M2) Pinouts	79
Table 6-8: Power Button Connector (PWR_BTN2) Pinouts.....	79
Table 6-9: SATA Connector (SATA1) Pinouts	79
Table 6-10: SMBus Connector (SMB1) Pinouts.....	80
Table 6-11: SPI Flash Connector (JSPI1) Pinouts	80
Table 6-12: USB Connector (TOUCH_USB1) Pinouts.....	80
Table 6-13: USB Connector (EXT_USB1) Pinouts.....	81
Table 6-14: External Connectors.....	81
Table 6-15: Ethernet Connectors (LAN1, J1, J2) Pinouts	82
Table 6-16: Ethernet Connector LEDs.....	82
Table 6-17: HDMI Connector (HDMI1) Pinouts.....	82
Table 6-18: Power Connector (PWR3) Pinouts.....	83
Table 6-19: RS-232/422/485 DB-9 Serial Port (COM1) Pinouts.....	83
Table 6-20: RS-232 RJ-45 Serial Port (COM2) Pinouts.....	83
Table 6-21: USB 3.2 Gen 2 Connectors (USB_CON1, USB_CON2) Pinouts.....	84
Table 6-22: Jumpers	84
Table 6-23: Flash Descriptor Security Override Jumper Settings.....	85

List of BIOS Menus

BIOS Menu 1: Main	36
BIOS Menu 2: Advanced	37
BIOS Menu 3: CPU Configuration	38
BIOS Menu 4: PCH-FW Configuration	40
BIOS Menu 5: PTT Configuration.....	41
BIOS Menu 6: Trusted Computing	42
BIOS Menu 7: ACPI Settings	43
BIOS Menu 8: RTC Wake Settings	44
BIOS Menu 9: iWDD H/W Monitor	45
BIOS Menu 10: F81866 Super IO Configuration	46
BIOS Menu 11: Serial Port n Configuration	47
BIOS Menu 12: Serial Port Console Redirection	48
BIOS Menu 13: Legacy Console Redirection Settings	49
BIOS Menu 14: Console Redirection Settings.....	50
BIOS Menu 15: USB Configuration	52
BIOS Menu 16: CSM Configuration.....	53
BIOS Menu 17: NVMe Configuration.....	54
BIOS Menu 18: IEI Feature	55
BIOS Menu 19: Chipset	56
BIOS Menu 20: System Agent (SA) Configuration	56
BIOS Menu 21: Memory Configuration.....	57
BIOS Menu 22: Graphics Configuration	58
BIOS Menu 23: PCH-IO Configuration	59
BIOS Menu 24: PCI Express Configuration	61
BIOS Menu 25: SATA and RST Configuration	62
BIOS Menu 26: Security	64
BIOS Menu 27: Boot	65
BIOS Menu 28: Save & Exit.....	67

Chapter

1

Introduction

1.1 Overview



Figure 1-1: FLEX-BX100-ULT5 Series Box PC

The FLEX-BX100-ULT5 box PC is powered by 8th Generation Intel® Core™ i5-8365UE / Celeron® 4305UE Processor which is a System-on-Chip (SoC) that ensures optimal memory, graphics, and peripheral I/O support. The system comes with 4.0 GB of DDR4 SO-DIMM memory ensuring smooth data throughputs with reduced bottlenecks and fast system access.

One RS-232/422/485 serial port, one RS-232 serial port and four external USB 3.2 Gen 2 ports ensure simplified connectivity to a variety of external peripheral devices. Three RJ-45 Ethernet connectors provide the system with smooth connection to an external LAN. Moreover, two of the Ethernet connectors are capable to support PoE by installing the optional PoE module.

1.2 Model Variations

The model variations of the FLEX-BX100-ULT5 series are listed below.

	Processor
FLEX-BX100-ULT5-i5/4G	Intel® Core™ i5-8365UE CPU
FLEX-BX100-ULT5-C/4G	Intel® Celeron® 4305UE CPU

Table 1-1: Model Variations

FLEX-BX100-ULT5

1.3 Features

The FLEX-BX100-ULT5 has the following features

- 8th generation Intel® Core™ i5-8365UE / Celeron® 4305UE processor
- Preinstalled with 4 GB of DDR4 memory (system max. 32 GB)
- Three PCIe GbE RJ-45 connectors (two with PoE support)
- Four USB 3.2 Gen 2 (10Gb/s) ports
- One RS-232/422/485 serial port and one RS-232 serial port by D-sub 9 connectors; support Auto Flow Control (AFC) via RS-485
- Supports one 2.5" SATA 6Gb/s HDD/SSD
- 12 V DC power input
- RoHS compliant design

1.4 Front Panel

An overview of the front panel is shown below.

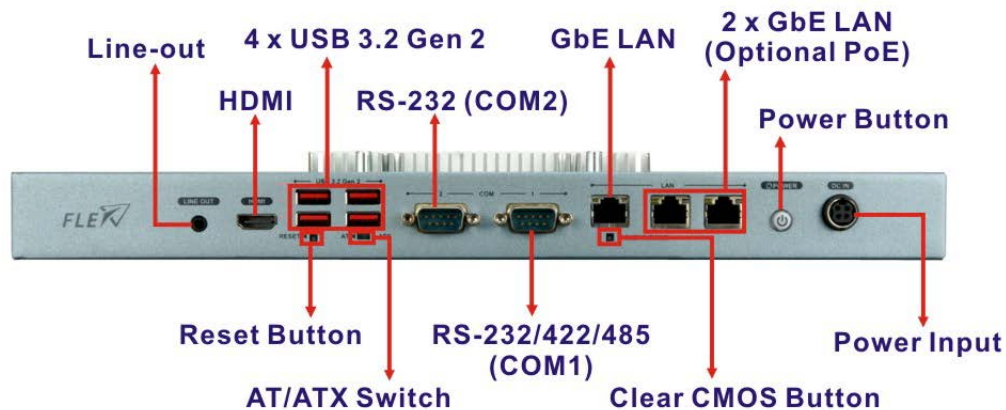

Figure 1-2: Front Panel

1.5 Rear Panel

The rear panel of the FLEX-BX100-ULT5 has two knockout holes for the installation of the optional Wi-Fi antenna (**Figure 1-3**).



Figure 1-3: Rear Panel

1.6 Top Panel

The top panel has retention screw holes that support VESA mounting. The top panel also provides access to the internal HDD/SSD bay and the PoE card slots.



Figure 1-4: Top Panel

FLEX-BX100-ULT5

1.7 Bottom Panel

The bottom surface of the FLEX-BX100-ULT5 contains four retention screw holes for installing two side mounting brackets.

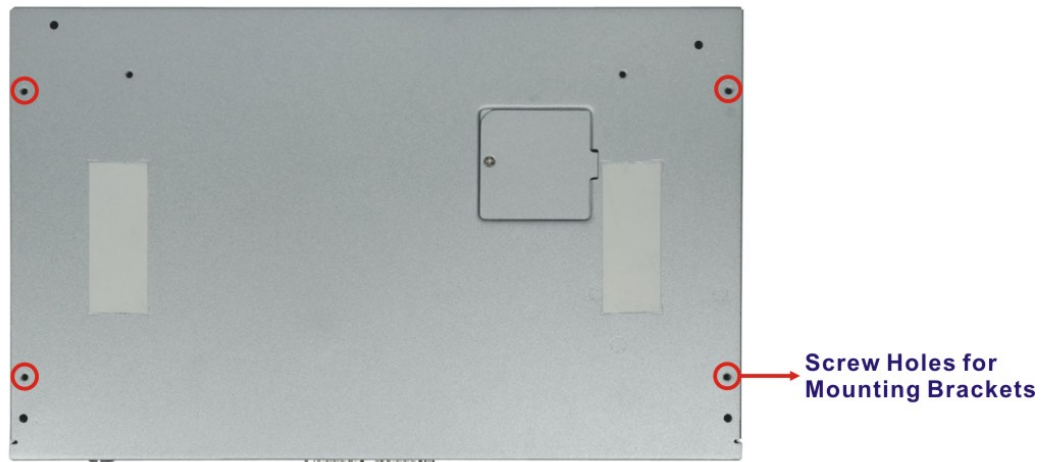

Figure 1-5: Bottom Panel

1.8 Technical Specifications

The specifications for the FLEX-BX100-ULT5 box PCs are listed below.

	FLEX-BX100-ULT5
CPU	8th Generation Intel® Core™ i5-8365UE CPU (6M cache, up to 4.2 GHz) 8th Generation Intel® Celeron® 4305UE CPU (2M cache, 2.0 GHz)
BIOS	AMI UEFI BIOS
Memory	Two 260-pin 2400 MHz dual-channel DDR4 SO-DIMM slots (system max. 32 GB) One slot is preinstalled with a 4 GB memory module
Graphics Engine	Intel® HD Graphics Gen 9 Engines with 16 low-power execution units, supports 4K codec decode
Display Output	1 x HDMI (external) 1 x LVDS (internal)
Ethernet	Intel® I219 PHY (LAN1) Intel® I211 PCIe GbE controller (LAN2 & LAN3)
Super I/O	Fintek F81866
Storage	1 x 2.5" SATA 6Gb/s HDD/SSD bay 1 x M.2 M-key (2280, PCIe 3.0 x4), support NVMe SSD
LAN	2 x PoE GbE LAN* (RJ-45) 1 x GbE LAN (RJ-45)
COM	1 x RS-232/422/485 (DB-9, COM1) 1 x RS-232 (DB-9, COM2)
USB	4 x USB 3.2 Gen 2 (10Gb/s) Type-A
Audio	Realtek ALC888 HD codec 1 x Line-out
Expansion	1 x M.2 A-key (2230, PCIe x2 / USB 2.0 / I ² C)
Fan	Fanless

FLEX-BX100-ULT5

Buttons and Indicators	<ul style="list-style-type: none"> 1 x Power button with LED indicator 1 x Reset button 1 x AT/ATX mode switch 1 x Clear CMOS button
Power Requirement	<ul style="list-style-type: none"> 12 V DC PoE IEEE802.3af/at/bt (optional, redundancy, power load-sharing) Support AT/ATX mode
Chassis Construction	Sheet metal
Mounting	Wall mount
Color	Pantone 296 C
Dimensions (LxDxH)	356.5 mm x 222 mm x 44 mm
Net Weight	2.8 kg
Watchdog Timer	Software programmable, support 1~255 sec. system reset
Vibration	5~17Hz, 0.1 double amplitude displacement 17~640Hz 1.5G acceleration peak to peak
Shock	10G acceleration part to part (11ms)
Operating Temperature	-10°C ~ 60°C (with air flow)
Storage Temperature	-20°C ~ 70°C
Operating Humidity	10% ~95%, non-condensing
<p>*An IEI PoE module must be installed before start using the box PC as a PoE powered device (PD). Refer to Section 3.5 for the installation instruction of the optional PoE module.</p>	

Table 1-2: Technical Specifications

1.9 Dimensions

The dimensions of the FLEX-BX100-ULT5 are listed below and shown in **Figure 1-6**.

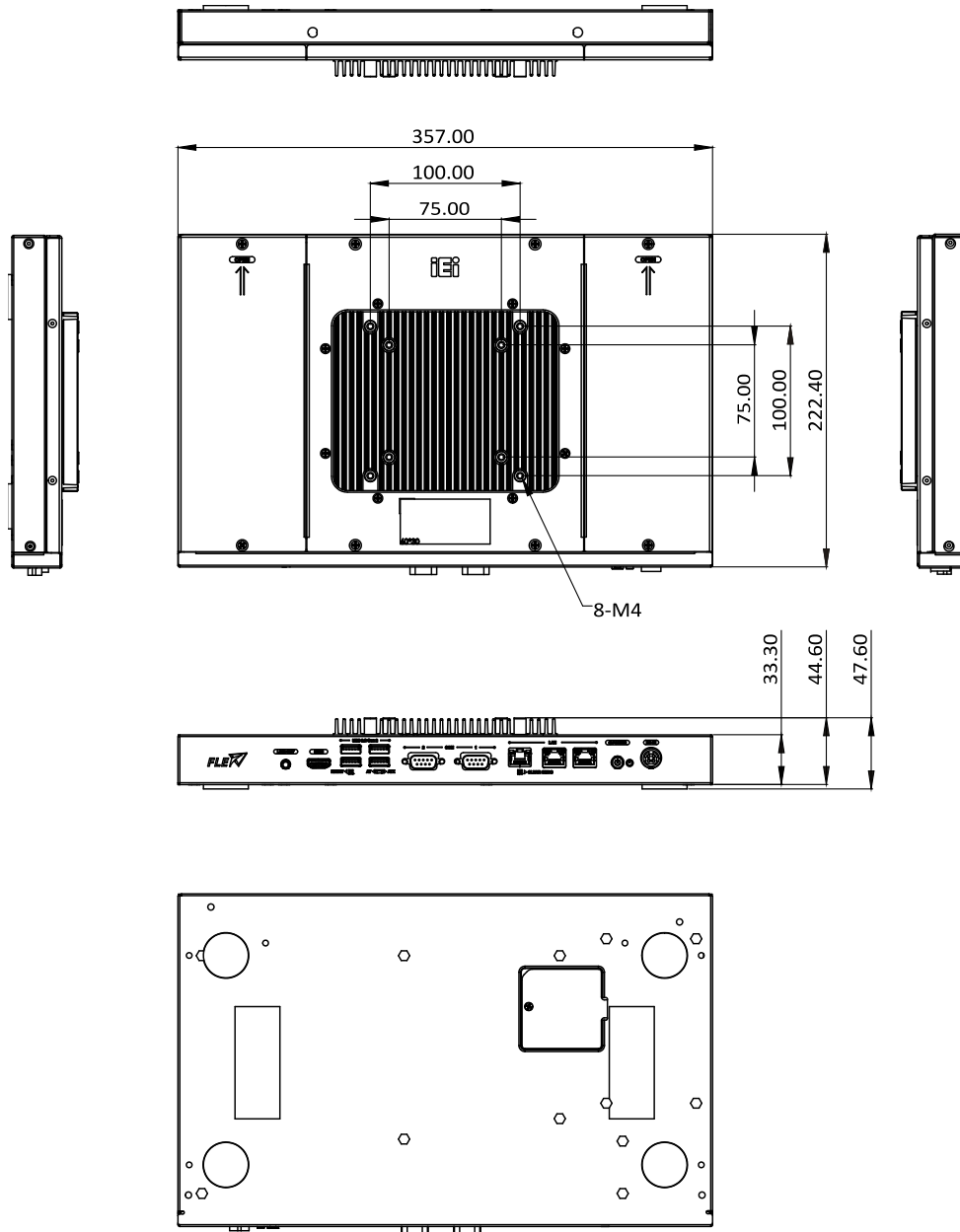

Figure 1-6: Dimensions with Mounting Brackets (mm)

Chapter

2

Unpacking

2.1 Unpacking

To unpack the box PC, follow the steps below:

- Step 1:** Use box cutters, a knife or a sharp pair of scissors that seals the top side of the external (second) box.
- Step 2:** Open the external (second) box.
- Step 3:** Use box cutters, a knife or a sharp pair of scissors that seals the top side of the internal (first) box.
- Step 4:** Lift the system out of the boxes.
- Step 5:** Remove both polystyrene ends, one from each side.
- Step 6:** Make sure all the components listed in the packing list are present.



2.2 Packing List



NOTE:

If any of the components listed in the checklist below are missing, do not proceed with the installation. Contact the IEI reseller or vendor the FLEX-BX100-ULT5 was purchased from or contact an IEI sales representative directly by sending an email to sales@ieiworld.com.

The FLEX-BX100-ULT5 box PC is shipped with the following components:

Quantity	Item	Image
1	FLEX-BX100-ULT5 box PC	
1	Power cord	

FLEX-BX100-ULT5







1	96 W power adapter	
2	Wall mount bracket	
4	Screws (M4*8) for VESA mounting	
4	Screws (M4*6) for mounting brackets	
4	Screws (M3*4) for HDD installation	
4	Backup screws (M4*4) for top panel installation	
4	Foot pad	

Table 2-1: Package List

2.3 Optional Items

The following are optional component(s) which may be separately purchased:

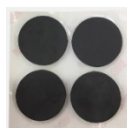

<p>IEEE802.3af/at PoE PD module (P/N: GPOE-PD-AT01-R10)</p>	
<p>IEEE802.3af/at/bt PoE PD module (P/N: GPOE-PD-BT01-R10)</p>	
<p>Wi-Fi kit (2T2R, 802.11ac/a/b/g/n and BT V4.1, NGFF 2230 Type A-E) (P/N: EMB-WIFI-KIT02E-R10)</p>	

Table 2-2: Optional Items

Chapter

3

Installation

3.1 Anti-static Precautions

**WARNING:**

Failure to take ESD precautions during the maintenance of the FLEX-BX100-ULT5 may result in permanent damage to the FLEX-BX100-ULT5 and severe injury to the user.

Electrostatic discharge (ESD) can cause serious damage to electronic components, including the WAFER series motherboard and the power module. (Dry climates are especially susceptible to ESD.) It is therefore critical that whenever the FLEX-BX100-ULT5 is opened and any electrical component handled, the following anti-static precautions are strictly adhered to.

- **Wear an anti-static wristband:** Wearing a simple anti-static wristband can help to prevent ESD from damaging the board.
- **Self-grounding:** Before handling the board, touch any grounded conducting material. During the time the board is handled, frequently touch any conducting materials that are connected to the ground.
- **Use an anti-static pad:** When configuring the FLEX-BX100-ULT5, place it on an anti-static pad. This reduces the possibility of ESD damaging the FLEX-BX100-ULT5.

3.2 Installation Precautions

During installation, be aware of the precautions below:

- **Read the user manual:** The user manual provides a complete description of the FLEX-BX100-ULT5, installation instructions and configuration options.
- **DANGER! Disconnect Power:** Power to the FLEX-BX100-ULT5 must be disconnected during the installation process. Failing to disconnect the power may cause severe injury to the body and/or damage to the system.
- **Qualified Personnel:** The FLEX-BX100-ULT5 must be installed and operated only by trained and qualified personnel. Maintenance, upgrades, or repairs

FLEX-BX100-ULT5

may only be carried out by qualified personnel who are familiar with the associated dangers. Never open the equipment. For safety reasons, the equipment should be opened only by qualified skilled person.

- **Air Circulation:** Make sure there is sufficient air circulation when installing the FLEX-BX100-ULT5. The FLEX-BX100-ULT5's cooling vents must not be obstructed by any objects. Blocking the vents can cause overheating of the FLEX-BX100-ULT5. Leave at least 5 cm of clearance around the FLEX-BX100-ULT5 to prevent overheating.
- **Grounding:** The FLEX-BX100-ULT5 should be properly grounded. The voltage feeds must not be overloaded. Adjust the cabling and provide external overcharge protection per the electrical values indicated on the label attached to the back of the FLEX-BX100-ULT5.

3.3 Installation Procedure

To properly install the FLEX-BX100-ULT5, the following steps must be followed. Detailed descriptions of these instructions are listed in the sections that follow.

- Step 1:** Unpacking the FLEX-BX100-ULT5 box PC
- Step 2:** Install HDD
- Step 3:** Install PoE card (optional)
- Step 4:** Install M.2 SSD (optional)
- Step 5:** Install wireless LAN module and antenna (optional)
- Step 6:** Convert to panel PC (optional)
- Step 7:** Mount the FLEX-BX100-ULT5
- Step 8:** Connect the peripheral devices
- Step 9:** Power the system up

3.4 HDD Installation

To install the HDD into the system, please follow the steps below:

Step 1: Remove the HDD cover retention screws located on the left side of the top panel.

Slide the cover upwards to remove it.



Figure 3-1: HDD Cover Retention Screws

Step 2: Remove the four HDD bracket retention screws and lift the HDD bracket off the box PC.



Figure 3-2: HDD Bracket Retention Screws

FLEX-BX100-ULT5

Step 3: Attach the HDD brackets to the HDD. To do this, align the four retention screw holes in the both sides of the HDD bracket with the retention screw holes on the sides of the HDD. Insert four retention screws into the HDD bracket (Figure 3-3).



Figure 3-3: HDD Retention Screws

Step 4: Connect the SATA cable to the rear of HDD from the motherboard.

Step 5: Install the HDD into the FLEX-BX100-ULT5 by aligning the retention screw holes in the HDD brackets with the retention screw holes on the chassis. Insert the four retention screws.



Figure 3-4: HDD Installation

Step 6: Reinstall the HDD cover.

3.5 PoE PD Module Installation (Optional)

An IEI PoE module must be installed before start using the FLEX-BX100-ULT5 as a PoE powered device (PD). To install the optional PoE module, follow the steps below.

Step 1: Remove the PoE card cover retention screws located on the right side of the top panel. Slide the cover upwards to remove it.



Figure 3-5: PoE Card Cover Retention Screws

Step 2: Refer to the following diagram to locate the PoE module slot for installing the PoE module you purchased.

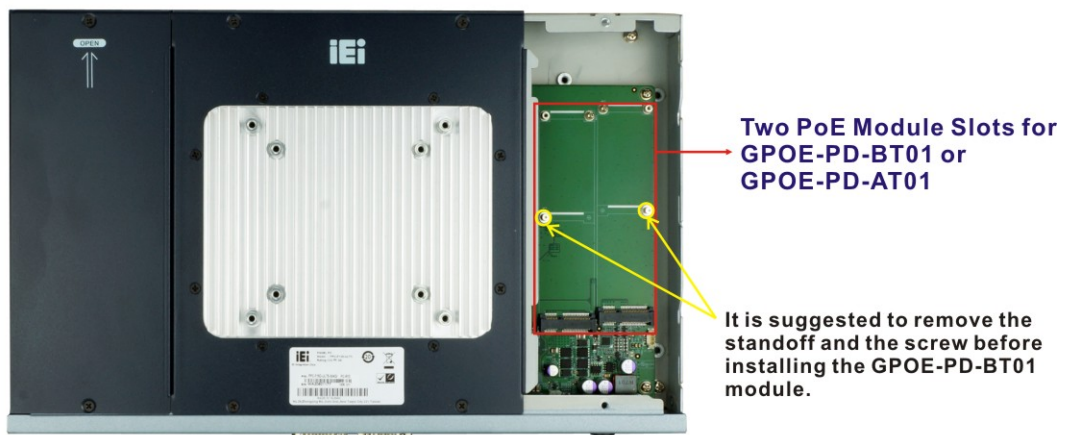

Figure 3-6: PoE Module Slot Location

Step 3: Remove the on-board PoE card retention screw.

FLEX-BX100-ULT5

- Step 4:** Line up the notch on the PoE module with the notch on the connector. Slide the PoE module into the socket at an angle of about 20°.
- Step 5:** Push the other end of the PoE module down and secure the module with the retention screw previously removed.
- Step 6:** Re-install the PoE card cover.

3.6 M.2 SSD Installation (Optional)

The M.2 M-key slot allows installation of M.2 2280 cards. To install an M.2 card, please follow the steps below.

- Step 1:** Remove the eight retention screws from the top panel. Slide the two side covers upwards to remove them. And then, lift the center cover off the system. **NOTE:** A thermal pad is attached under the center of the center cover. Thus, more strength is required when lifting the center cover.



Figure 3-7: Rear Cover Retention Screws

- Step 2:** Locate the M.2 slot as shown in Figure 3-8.

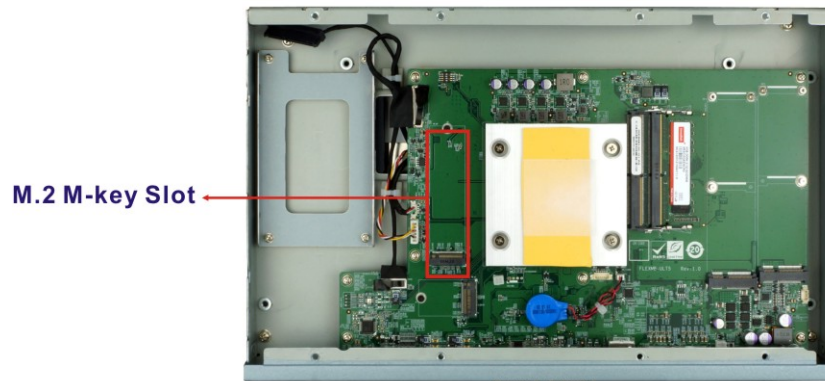

Figure 3-8: M.2 Slot Location

Step 3: Remove the on-board retention screw as shown in Figure 3-9.

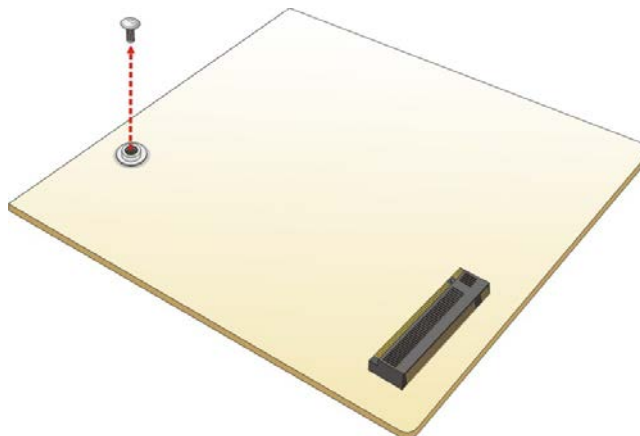

Figure 3-9: Removing the M.2 Module Retention Screw

Step 4: Line up the notch on the module with the notch on the slot. Slide the M.2 module into the socket at an angle of about 20° (**Figure 3-10**).

FLEX-BX100-ULT5

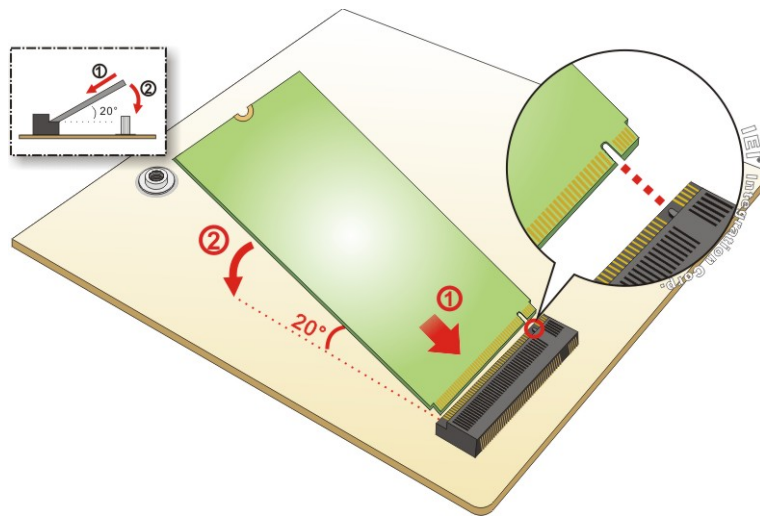

Figure 3-10: Inserting the M.2 Module into the Slot at an Angle

Step 5: Push the M.2 module down and secure it with the previously removed retention screw (**Figure 3-11**).

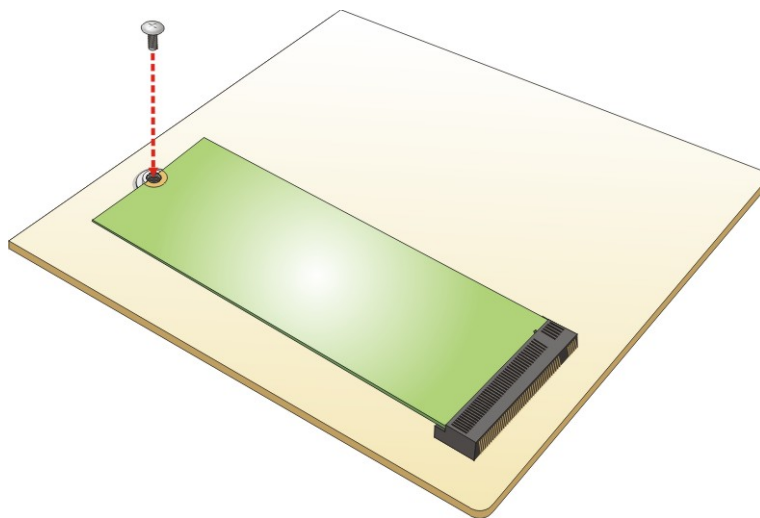

Figure 3-11: Securing the M.2 Module

Step 6: Re-install the rear covers and secure them with the eight retention screws previously removed.

3.7 Wireless LAN Module Installation (Optional)

To install the optional wireless LAN (WLAN) module, please follow the steps below.

Step 1: Remove the eight retention screws from the top panel. Slide the two side covers upwards to remove them. And then, lift the center cover off the system. See **Figure 3-7**. **NOTE:** A thermal pad is attached under the center of the center cover. Thus, more strength is required when lifting the center cover.

Step 2: Remove the two knockouts for antenna installation. The two knockouts are located on the rear panel of the FLEX-BX100-ULT5 (**Figure 3-12**).



Figure 3-12: Knockouts on Rear Panel for Wireless Antennas

Step 3: Locate the M.2 A-key slot (Figure 3-13).

Step 4: Remove the on-board M.2 slot retention screw.

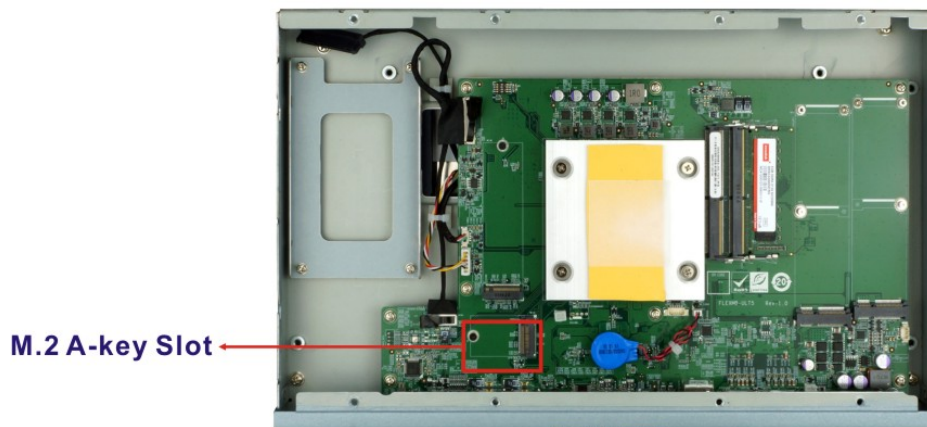

Figure 3-13: M.2 A-key Slot Location

FLEX-BX100-ULT5

Step 5: Line up the notch on the WLAN module with the notch on the slot. Slide the WLAN module into the slot at an angle of about 20° (**Figure 3-14**).

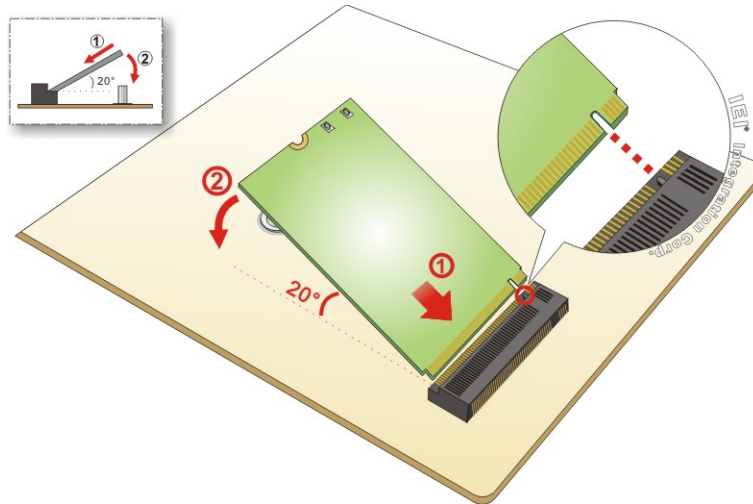

Figure 3-14: Inserting the WLAN Module

Step 6: Secure the WLAN module with the screw previously removed (**Figure 3-16**).

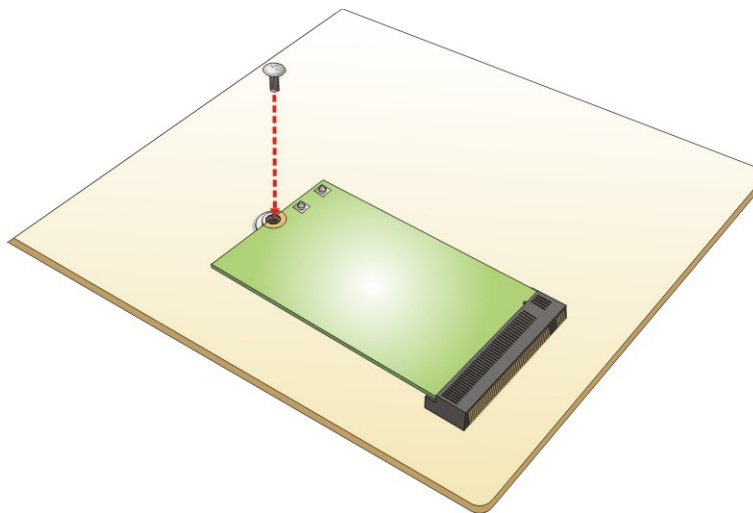

Figure 3-15: Securing the WLAN Module

Step 7: Connect the two RF cables to the antenna connectors on the WLAN module (Figure 3-16).

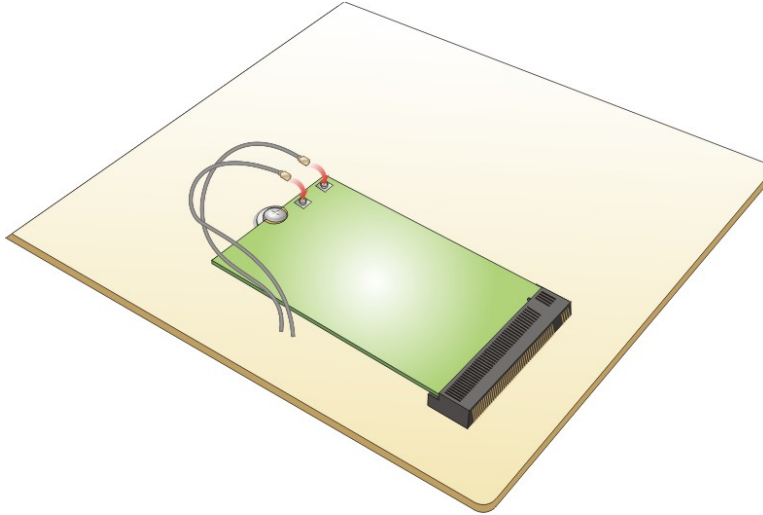

Figure 3-16: Connecting RF Cables

Step 8: Remove the nut and washer from the SMA connector at the other end of the RF cable.

Step 9: Insert the SMA connector to the antenna connector holes on the rear panel.

Step 10: Secure the SMA connector by inserting the washer and tightening it with nut.

Step 11: Install the external antenna.

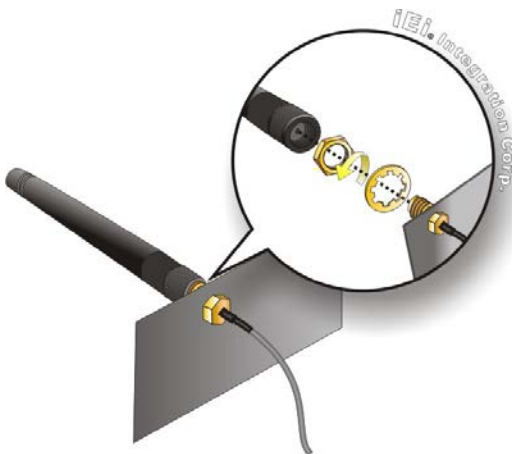

Figure 3-17: Securing SMA Connector and External Antenna Installation

FLEX-BX100-ULT5

3.8 Mounting the System

To mount only the box PC onto a wall or some other surface using the two mounting brackets, please follow the steps below.

Step 1: Turn the box PC over.

Step 2: Align the two retention screw holes in each bracket with the retention screw holes on the sides of the bottom surface.

Step 3: Secure the brackets to the system by inserting two retention screws (M4*6) into each bracket (**Figure 3-18**).

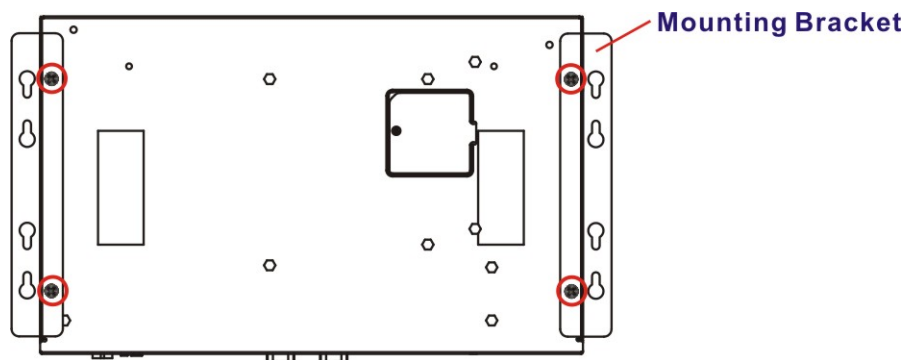

Figure 3-18: Mounting Bracket Retention Screws

Step 4: Drill holes in the intended installation surface according to the bracket dimensions listed below.

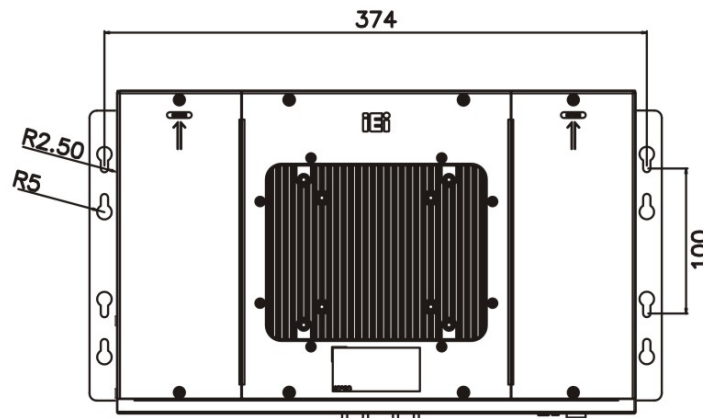

Figure 3-19: Mounting Bracket Retention Screws

Step 5: Align the mounting holes in the sides of the mounting brackets with the predrilled holes in the mounting surface.

Step 6: Insert retention screws into each bracket to secure the system to the wall.

3.9 RS-232/422/485 Serial Port (COM1) Selection

The front panel of the FLEX-BX100-ULT5 has one D-sub 9 male connectors for RS-232/422/485 connection. The serial communication mode selection can be made through the BIOS options (see **Section 4.3.7.1.1**).

3.9.1 COM1 Pinouts

The pinouts of COM1 external serial port are detailed below.

PIN NO.	RS-232	RS-422	RS-485
1	DCD	TXD422-	TXD485-
2	RXD	TXD422+	TXD485+
3	TXD	RXD422+	--
4	DTR	RXD422-	--
5	GND	--	--
6	DSR	--	--
7	RTS	--	--
8	CTS	--	--
9	RI	--	--

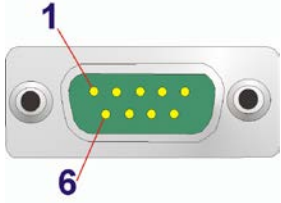

Table 3-1: RS-232/422/485 Serial Port (COM1) Pinouts

FLEX-BX100-ULT5

3.9.2 COM1 Pin 9 Selection

Pin 9 on the COM1 DB-9 connector can be set as the ring (RI) signal, +5 V or +12 V. The jumper selection options are shown in **Table 3-2**.

JP5	Description
Short 1-2	COM1 RI Pin use +12 V
Short 3-4	COM1 RI Pin use RI (Default)
Short 5-6	COM1 RI Pin use +5 V

Table 3-2: COM1 Pin 9 Setting Jumper Settings (JP5)

The COM1 Pin 9 Setting jumper location is shown in **Figure 3-20** below.

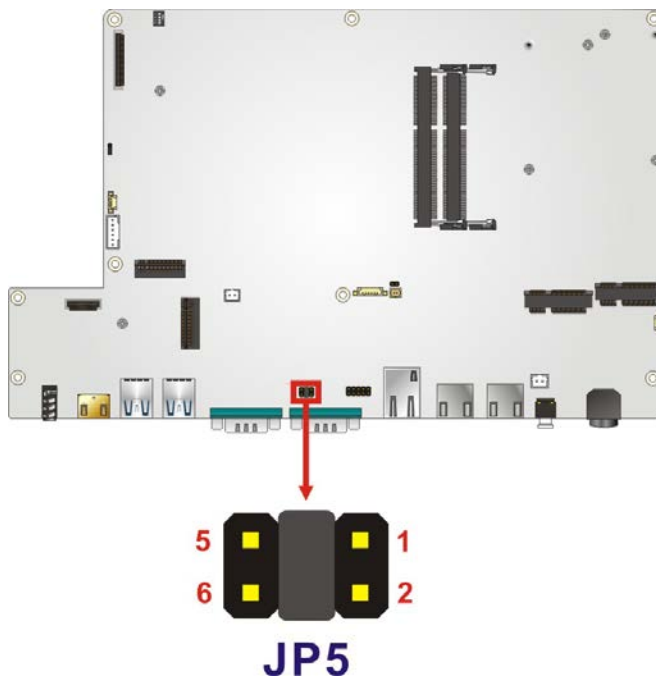

Figure 3-20: COM1 Pin 9 Setting Jumper Location

3.10 Clear CMOS

If the FLEX-BX100-ULT5 fails to boot due to improper BIOS settings, the clear CMOS jumper clears the CMOS data and resets the system BIOS information. To do this, push the clear CMOS button for three seconds, then restart the system. The clear CMOS button location is shown in **Figure 3-21**.



Figure 3-21: Clear CMOS Button Location

3.11 AT/ATX Mode Selection

AT or ATX power mode can be used on the FLEX-BX100-ULT5. The selection is made through an AT/ATX switch located on the front panel (**Figure 3-22**).

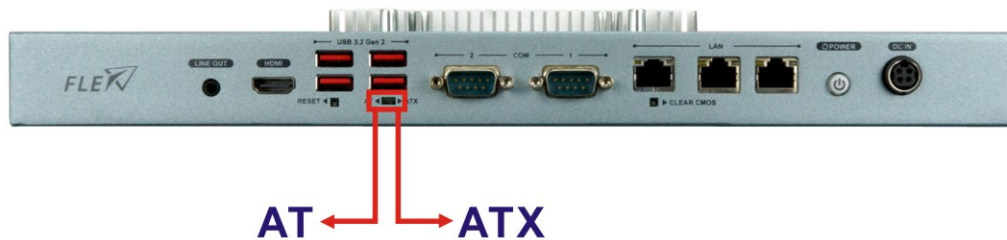

Figure 3-22: AT/ATX Switch Location

FLEX-BX100-ULT5

3.12 Power-On Procedure

3.12.1 Installation Checklist

**WARNING:**

Make sure a power supply with the correct input voltage is being fed into the system. Incorrect voltages applied to the system may cause damage to the internal electronic components and may also cause injury to the user.

To power on the box PC please make sure of the following:

- The top covers are installed
- All peripheral devices are connected
- The power cables are plugged in
- The system is securely mounted

3.12.2 Power-on Procedure

To power-on the FLEX-BX100-ULT5 please follow the steps below:

Step 1: Connect the power source to the power inlet on the front panel. **Ensure to connect the power cord to a socket-outlet with earthing connection.**

Step 2: Press the power button on the front panel until the LED lights on in blue to power up the system (**Figure 3-23**).

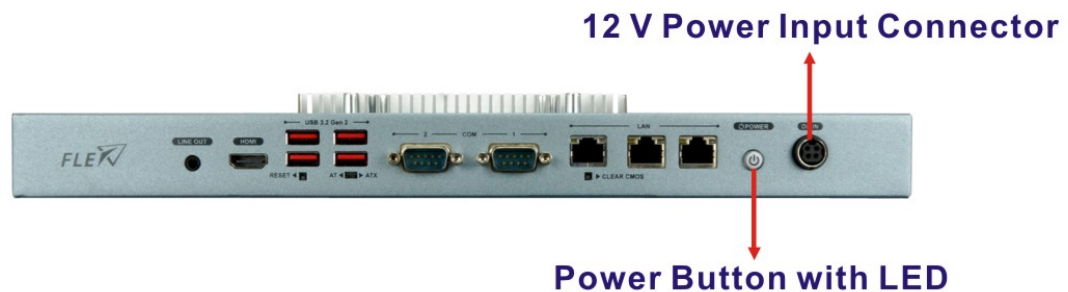

Figure 3-23: Power Button

3.13 Reset the System

The reset button enables user to reboot the system when the system is on. The reset button location is shown in **Figure 3-24**. Press the reset button to reboot the system.



Figure 3-24: Reset Button Location

3.14 Software Installation

All the drivers for the FLEX-BX100-ULT5 are available on IEI Resource Download Center (<https://download.ieiworld.com>). Type FLEX-BX100-ULT5 and press Enter to find all the relevant software, utilities, and documentation.

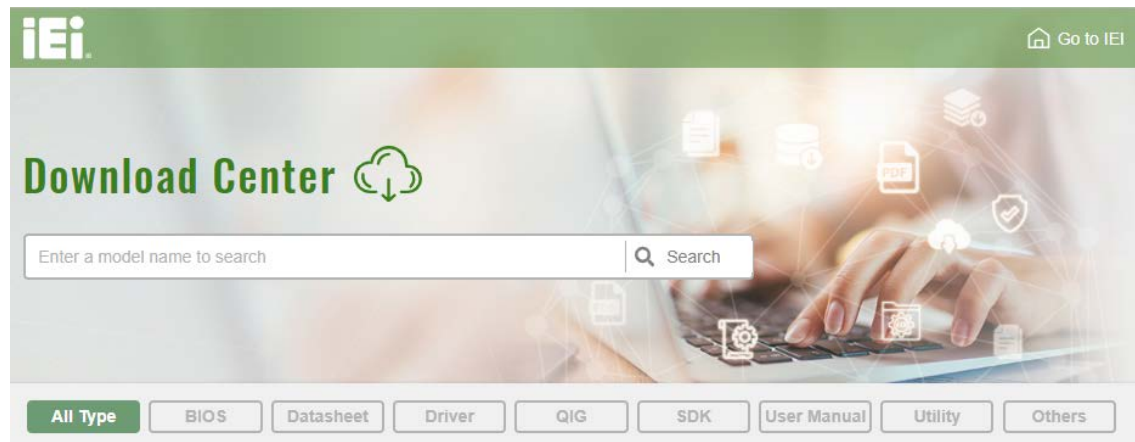

Figure 3-25: IEI Resource Download Center

FLEX-BX100-ULT5

3.14.1 Driver Download

To download drivers from IEI Resource Download Center, follow the steps below.

Step 1: Go to <https://download.ieiworld.com>. Type FLEX-BX100-ULT5 and press Enter.

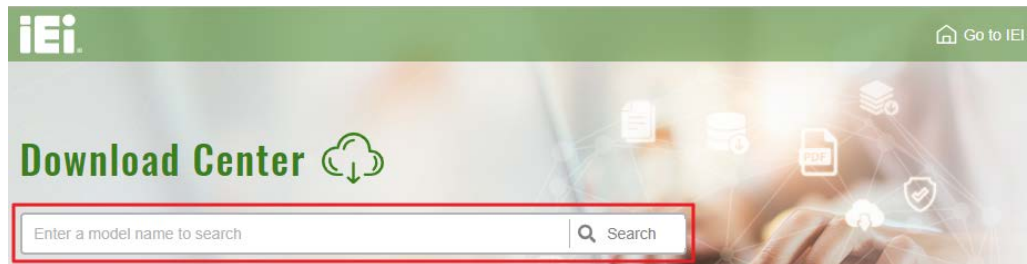

Step 2: All product-related software, utilities, and documentation will be listed. You can choose **Driver** to filter the result.

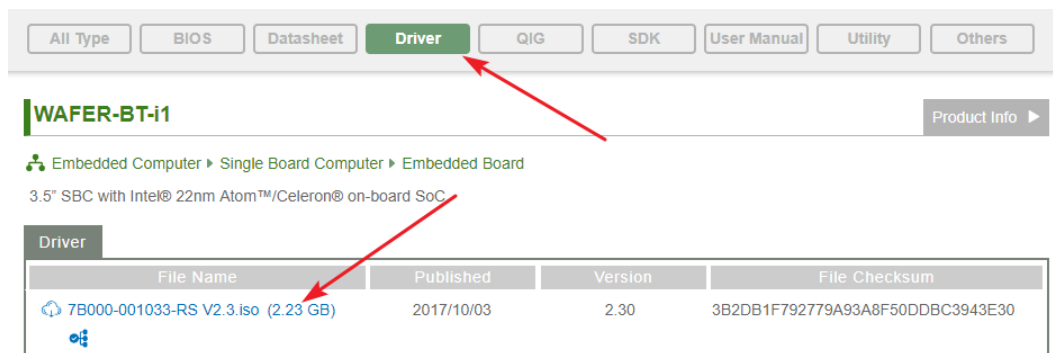

Step 3: Click the driver file name on the page and you will be prompted with the following window. You can download the entire ISO file (❶), or click the small arrow to find an individual driver and click the file name to download (❷).

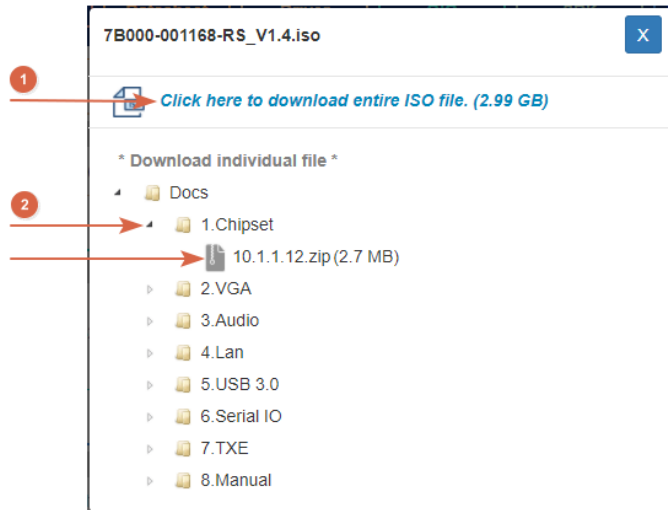

NOTE:

To install software from the downloaded ISO image file in Windows 8, 8.1 or 10, double-click the ISO file to mount it as a virtual drive to view its content.

Chapter

4

BIOS

4.1 Introduction

The BIOS is programmed onto the BIOS chip. The BIOS setup program allows changes to certain system settings. This chapter outlines the options that can be changed.



NOTE:

Some of the BIOS options may vary throughout the life cycle of the product and are subject to change without prior notice.

4.1.1 Starting Setup

The UEFI BIOS is activated when the computer is turned on. The setup program can be activated in one of two ways.

1. Press the **DELETE** key as soon as the system is turned on or
2. Press the **DELETE** key when the “**Press Delete to enter SETUP**” message appears on the screen.

If the message disappears before the **DELETE** key is pressed, restart the computer and try again.

4.1.2 Using Setup

Use the arrow keys to highlight items, press **ENTER** to select, use the PageUp and PageDown keys to change entries, press **F1** for help and press **ESC** to quit. Navigation keys are shown in.

Key	Function
Up arrow	Move to the item above
Down arrow	Move to the item below
Left arrow	Move to the item on the left hand side
Right arrow	Move to the item on the right hand side
+	Increase the numeric value or make changes

FLEX-BX100-ULT5

Key	Function
-	Decrease the numeric value or make changes
Page up	Move to the next page
Page down	Move to the previous page
Esc	Main Menu – Quit and do not save changes into CMOS Status Page Setup Menu and Option Page Setup Menu -- Exit current page and return to Main Menu
F1 key	General help, only for Status Page Setup Menu and Option Page Setup Menu
F2 key	Load previous values
F3 key	Load optimized defaults
F4 key	Save changes and Exit BIOS

Table 4-1: BIOS Navigation Keys

4.1.3 Getting Help

When **F1** is pressed a small help window describing the appropriate keys to use and the possible selections for the highlighted item appears. To exit the Help Window press **Esc** or the **F1** key again.

4.1.4 BIOS Menu Bar

The **menu bar** on top of the BIOS screen has the following main items:

- Main – Changes the basic system configuration.
- Advanced – Changes the advanced system settings.
- Chipset – Changes the chipset settings.
- Security – Sets User and Supervisor Passwords.
- Boot – Changes the system boot configuration.
- Save & Exit – Selects exit options and loads default settings

The following sections completely describe the configuration options found in the menu items at the top of the BIOS screen and listed above.

4.2 Main

The **Main** BIOS menu (**BIOS Menu 1**) appears when the **BIOS Setup** program is entered.

Aptio Setup Utility - Copyright (C) 2020 American Megatrends, Inc.			
Main	Advanced	Chipset Security Boot Save & Exit	
BIOS Information			
BIOS Vendor	American Megatrends	Set the Date. Use Tab to switch between Data elements.	
Core Version	5.13		
Compliancy	UEFI 2.7; PI 1.6		
Project Version	Z659AR11.ROM		
Build Date and Time	06/09/2020 11:19:50		
iWDD Vendor	iEi		
iWDD Version	Z659ER10.bin		
Processor Information			
Name	WhiskeyLake ULT	----- ←→: Select Screen ↑ ↓: Select Item Enter>Select +/-: Change Opt. F1: General Help F2: Previous Values F3: Optimized Defaults F4: Save & Exit ESC: Exit	
Type	Intel(R) Core(TM) i5-8365UE CPU @ 1.60GHz		
Speed	1800 MHz		
ID	0x806EC		
Stepping	V0		
Number of Processors	4Core(s) / 8Thread(s)		
Microcode Revision	CA		
GT Info	GT2 (0x3EA0)		
IGFX VBIOS Version	1017		
Memory RC Version	0.7.1.95		
Total Memory	4096 MB		
Memory Frequency	2133 MHz		
PCH Information			
Name	CNL PCH-LP		
PCH SKU	(U) Premium SKU		
Stepping	D0		
ME FW Version	12.0.47.1524		
ME Firmware SKU	Consumer SKU		
Access Level	Administrator		
System Date	[Fri 01/01/2010]		
System Time	[00:18:35]		
Version 2.20.1271. Copyright (C) 2020 American Megatrends, Inc.			

BIOS Menu 1: Main

The System Overview field also has two user configurable fields:

FLEX-BX100-ULT5

→ System Date [xx/xx/xx]

Use the **System Date** option to set the system date. Manually enter the day, month and year.

→ System Time [xx:xx:xx]

Use the **System Time** option to set the system time. Manually enter the hours, minutes and seconds.

4.3 Advanced

Use the **Advanced** menu (**BIOS Menu 2**) to configure the CPU and peripheral devices through the following sub-menus:



WARNING!

Setting the wrong values in the sections below may cause the system to malfunction. Make sure that the settings made are compatible with the hardware.

```

Aptio Setup Utility - Copyright (C) 2020 American Megatrends, Inc.
Main  Advanced  Chipset  Security  Boot  Save & Exit
-----
> CPU Configuration          CPU Configuration
> PCH-FW Configuration      Parameters.
> Trusted Computing
> ACPI Settings
> RTC Wake Settings
> iWDD H/W Monitor
> F81866 Super IO Configuration
> Serial Port Console Redirection
> USB Configuration
> CSM Configuration
> NVMe Configuration
> iEi Feature

-----
<->: Select Screen
↑ ↓: Select Item
Enter>Select
F1  General Help
F2  Previous Values
F3  Optimized Defaults
F4  Save
ESC Exit

Version 2.20.1271. Copyright (C) 2020 American Megatrends, Inc.
    
```

BIOS Menu 2: Advanced

4.3.1 CPU Configuration

Use the **CPU Configuration** menu (**BIOS Menu 3**) to view detailed CPU specifications and configure the CPU.

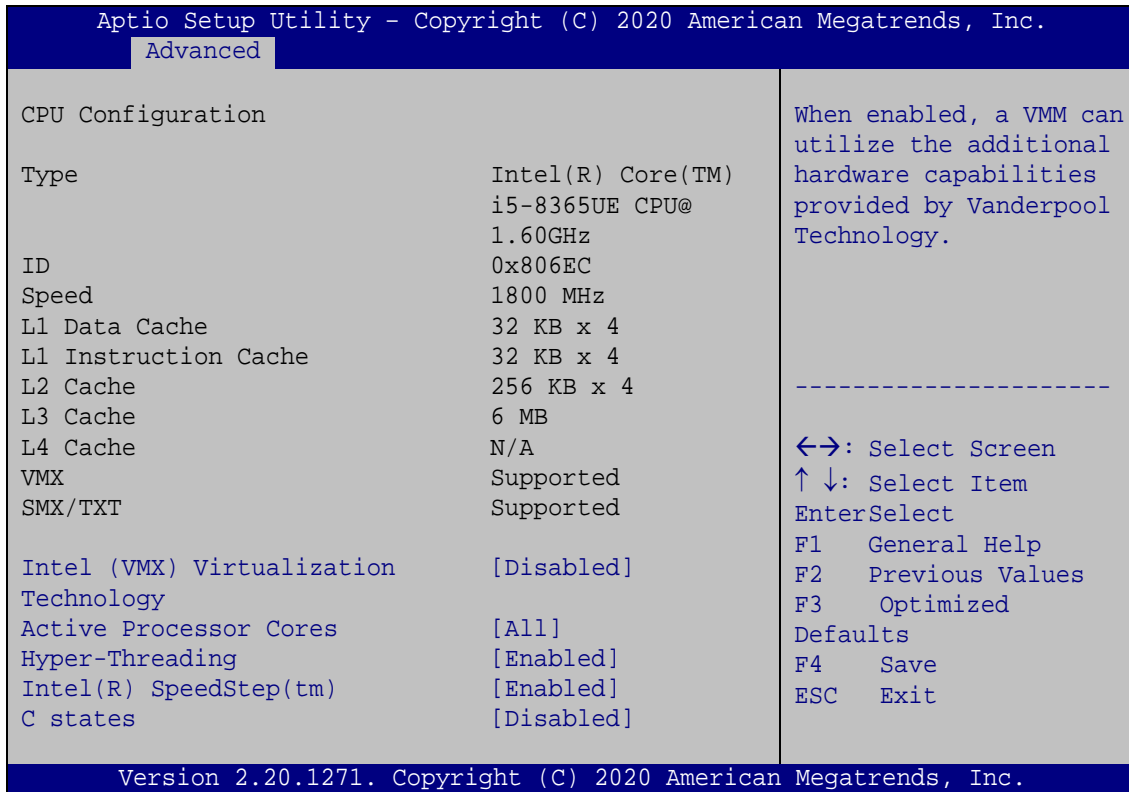

BIOS Menu 3: CPU Configuration

→ Intel® (VMX) Virtualization Technology [Disabled]

Use the **Intel® (VMX) Virtualization Technology** option to enable or disable virtualization on the system. When combined with third party software, Intel® Virtualization technology allows several OSs to run on the same system at the same time.

- **Disabled** **DEFAULT** Disables Intel® Virtualization Technology.
- **Enabled** Enables Intel® Virtualization Technology.

FLEX-BX100-ULT5

→ Active Processor Cores [All]

Use the **Active Processor Cores** BIOS option to enable numbers of cores in the processor package.

- **All** **DEFAULT** Enable all cores in the processor package.
- **1** Enable one core in the processor package.
- **2** Enable two cores in the processor package.
- **3** Enable three cores in the processor package.

→ Hyper-threading [Enabled]

Use the **Hyper-threading** BIOS option to enable or disable the Intel Hyper-Threading Technology.

- **Disabled** Disables the Intel Hyper-Threading Technology.
- **Enabled** **DEFAULT** Enables the Intel Hyper-Threading Technology.

→ Intel® SpeedStep™ [Enabled]

Use the **Intel® SpeedStep™** option to enable or disable the Intel® SpeedStep Technology.

- **Disabled** Disables the Intel® SpeedStep Technology.
- **Enabled** **DEFAULT** Enables the Intel® SpeedStep Technology.

→ C State [Disabled]

Use the **C State** option to enable or disable CPU C state.

- **Disabled** **DEFAULT** Disables CPU C state.
- **Enabled** Enables CPU C state.

4.3.2 PCH-FW Configuration

The **PCH-FW Configuration** menu (**BIOS Menu 4**) allows Intel® Active Management Technology (AMT) options to be configured.

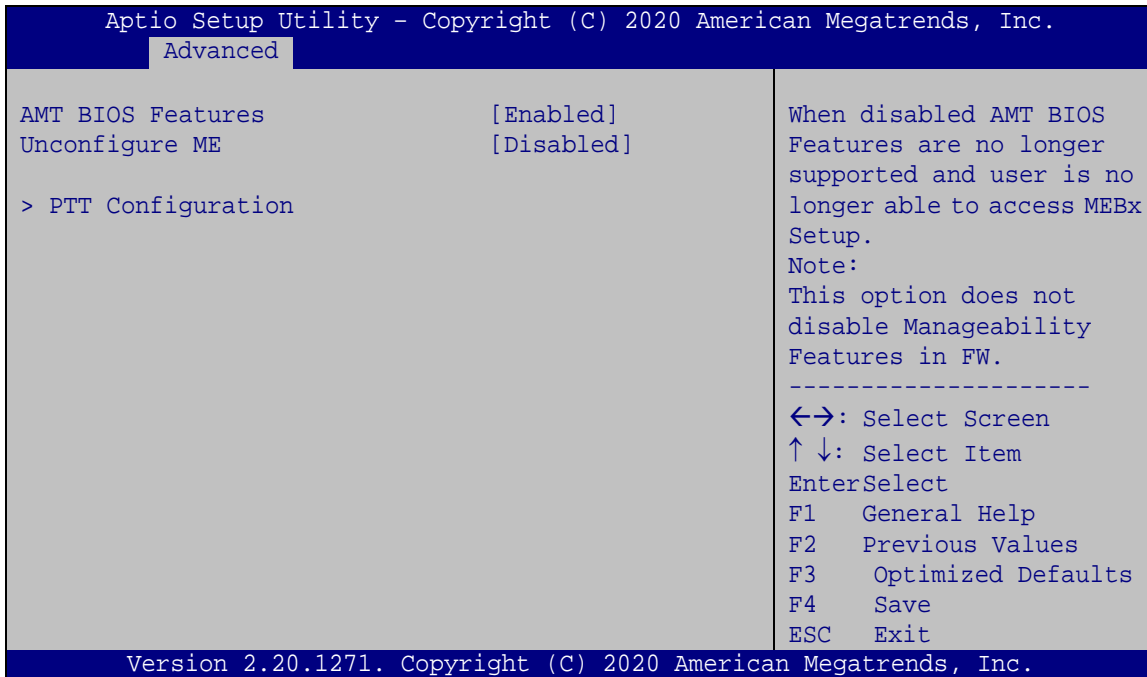

BIOS Menu 4: PCH-FW Configuration

➔ AMT BIOS Features [Enabled]

Use **AMT BIOS Features** option to enable or disable the Intel® AMT function.

- ➔ **Disabled** Intel® AMT is disabled
- ➔ **Enabled** **DEFAULT** Intel® AMT is enabled

➔ Unconfigure ME [Disabled]

Use the **Unconfigure ME** option to perform ME unconfigure without password operation.

- ➔ **Disabled** **DEFAULT** Not perform ME unconfigure
- ➔ **Enabled** To perform ME unconfigure

FLEX-BX100-ULT5

4.3.2.1 PTT Configuration

Use the **PTT Configuration** menu (**BIOS Menu 6**) to configure settings related to the Trusted Platform Module (TPM).

```

Aptio Setup Utility - Copyright (C) 2020 American Megatrends, Inc.
  Advanced
PTT Capability / State          1 / 0
TPM Device Selection           [dTPM (If supported)]
Select TPM device: PTT or
dTPM. PTT- Enables PTT in
SkuMgr dTPM 1.2 -
Disables PTT in SkuMgr
Warning! PTT/dTPM will
be disabled and all data
saved on it will be lost.

-----
<->: Select Screen
↑ ↓: Select Item
EnterSelect
F1   General Help
F2   Previous Values
F3   Optimized
Defaults
F4   Save
ESC  Exit

Version 2.20.1271. Copyright (C) 2020 American Megatrends, Inc.
  
```

BIOS Menu 5: PTT Configuration

→ TPM Device Selection [dTPM (If supported)]

Use the **TPM Device Selection** option to configure support for the TPM.

- **dTPM** (If **DEFAULT** Disable PTT in SkuMgr.
supported)
- **PTT** Enable PTT in SkuMgr

4.3.3 Trusted Computing

Use the **Trusted Computing** menu (**BIOS Menu 6**) to configure settings related to the Trusted Computing Group (TCG) Trusted Platform Module (TPM).

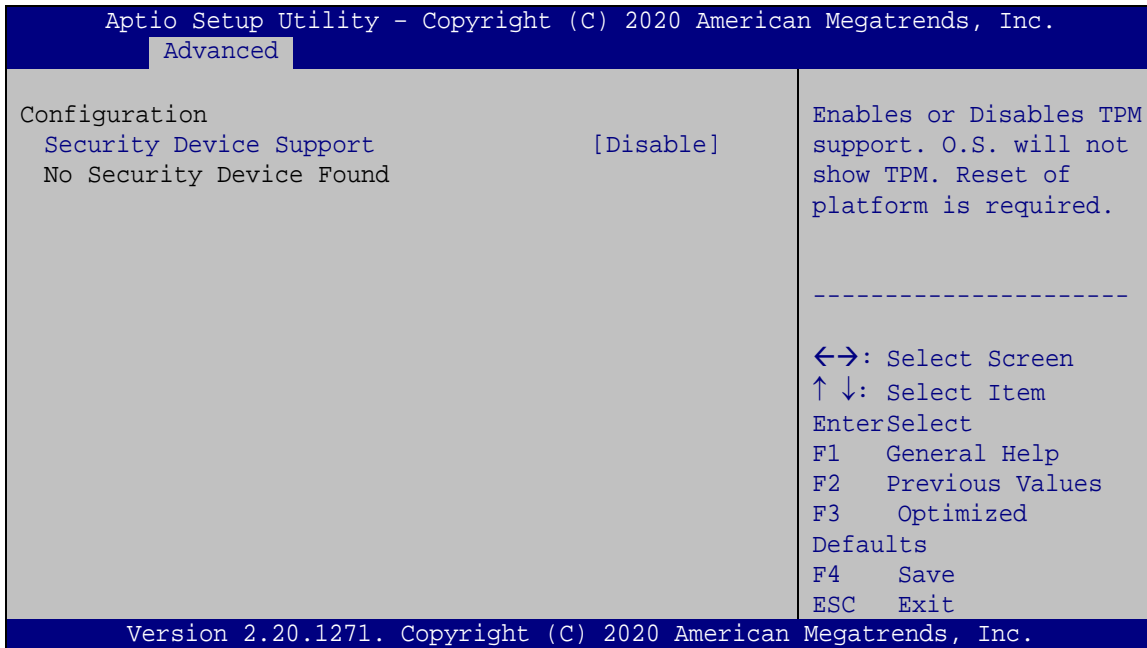

BIOS Menu 6: Trusted Computing

→ Security Device Support [Disable]

Use the **Security Device Support** option to configure support for the TPM.

- **Disable** **DEFAULT** TPM support is disabled.
- **Enable** TPM support is enabled.

FLEX-BX100-ULT5

4.3.4 ACPI Settings

The **ACPI Settings** menu (**BIOS Menu 7**) configures the Advanced Configuration and Power Interface (ACPI) options.

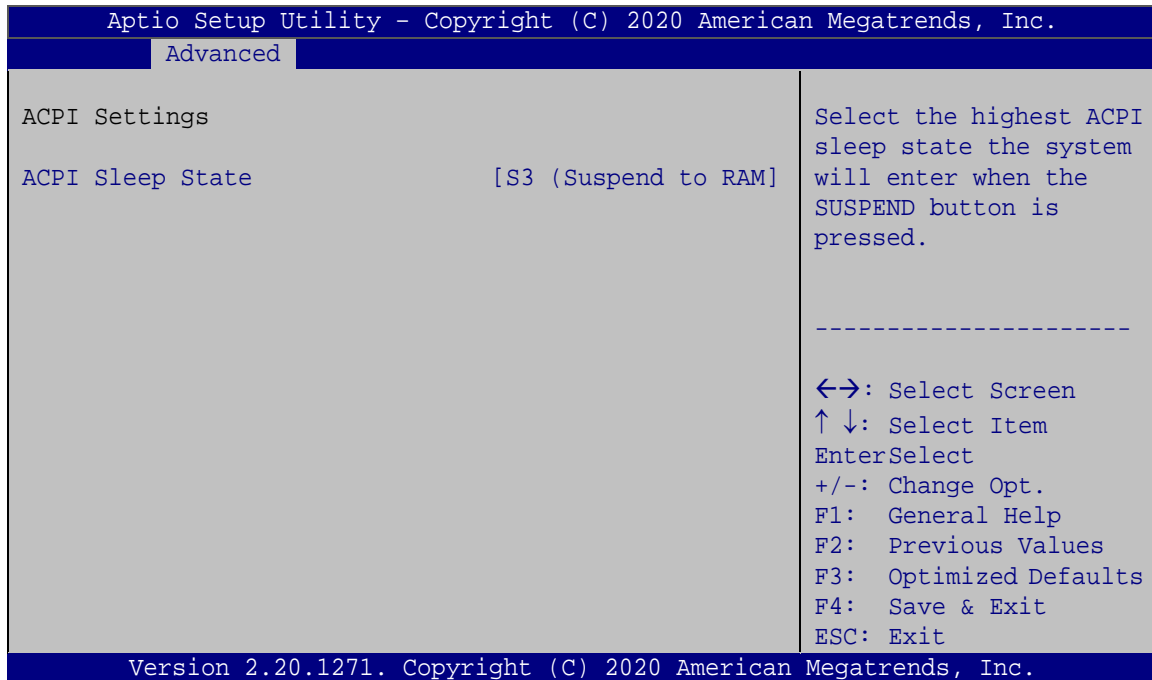

BIOS Menu 7: ACPI Settings

→ **ACPI Sleep State [S3 (Suspend to RAM)]**

Use the **ACPI Sleep State** option to specify the sleep state the system enters when it is not being used.

- **S3 (Suspend to DEFAULT RAM)** The caches are flushed and the CPU is powered off. Power to the RAM is maintained. The computer returns slower to a working state, but more power is saved.

4.3.5 RTC Wake Settings

The **RTC Wake Settings** menu (**BIOS Menu 8**) configures RTC wake event.

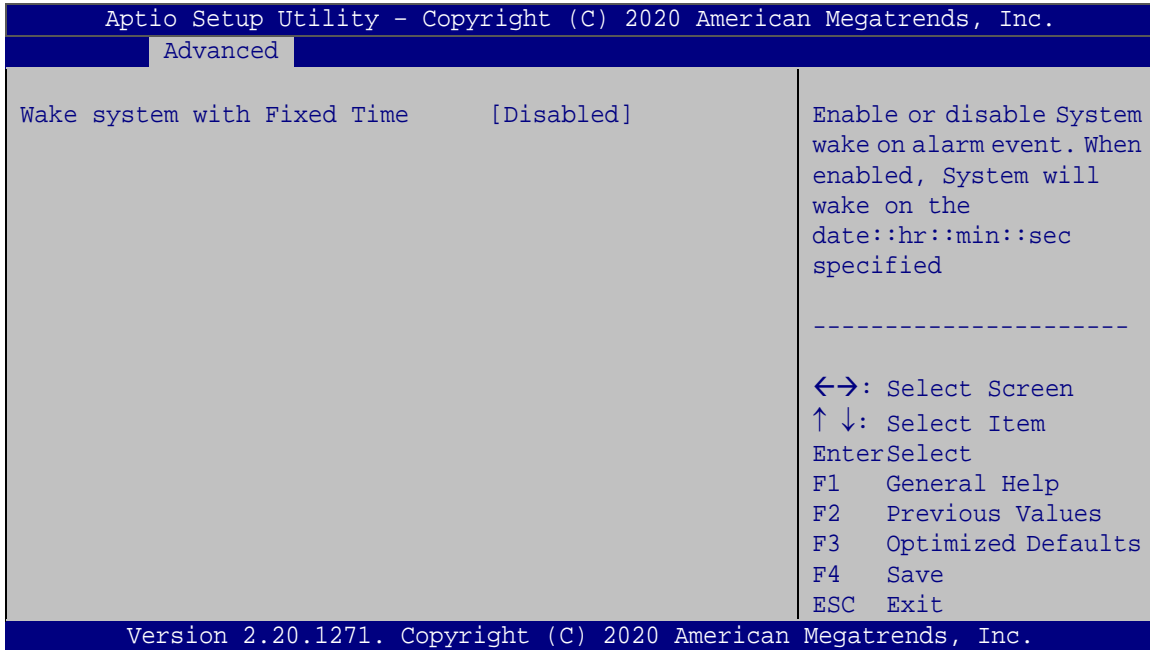

BIOS Menu 8: RTC Wake Settings

→ Wake system with Fixed Time [Disabled]

Use the **Wake system with Fixed Time** option to enable or disable the system wake on alarm event.

- **Disabled** **DEFAULT** The real time clock (RTC) cannot generate a wake event

- **Enabled** If selected, the **Wake up every day** option appears allowing you to enable to disable the system to wake every day at the specified time. Besides, the following options appear with values that can be selected:
 - Wake up date
 - Wake up hour
 - Wake up minute

FLEX-BX100-ULT5

Wake up second

After setting the alarm, the computer turns itself on from a suspend state when the alarm goes off.

4.3.6 iWDD H/W Monitor

The **iWDD H/W Monitor** menu (**BIOS Menu 9**) contains the fan configuration submenus and displays operating temperature, fan speeds and system voltages.

```

Aptio Setup Utility - Copyright (C) 2020 American Megatrends, Inc.
-----
Advanced
-----
PC Health Status
CPU temperature           :+43 °C
System temperature       :+37 °C

+VCCCORE                 :+0.736 V
+VDDQ                    :+1.219 V
+V3.3S                   :+3.398 V
+V3.3A                   :+3.398 V
+V1.05A                  :+1.043 V
+VCCSA                   :+0.739 V

-----
<->: Select Screen
↑ ↓: Select Item
Enter>Select
+ - Change Opt.
F1  General Help
F2  Previous Values
F3  Optimized Defaults
F4  Save & Exit
ESC Exit
-----
Version 2.20.1271. Copyright (C) 2020 American Megatrends, Inc.
    
```

BIOS Menu 9: iWDD H/W Monitor

→ PC Health Status

The following system parameters and values are shown. The system parameters that are monitored are:

- System Temperatures:
 - CPU Temperature
 - System temperature
- Voltages
 - +VCCCORE
 - +VDDQ
 - +V3.3S

- +V3.3A
- +V1.05A
- +VCCSA

4.3.7 F81866 Super IO Configuration

Use the **F81866 Super IO Configuration** menu (**BIOS Menu 10**) to set or change the configurations for the serial ports.

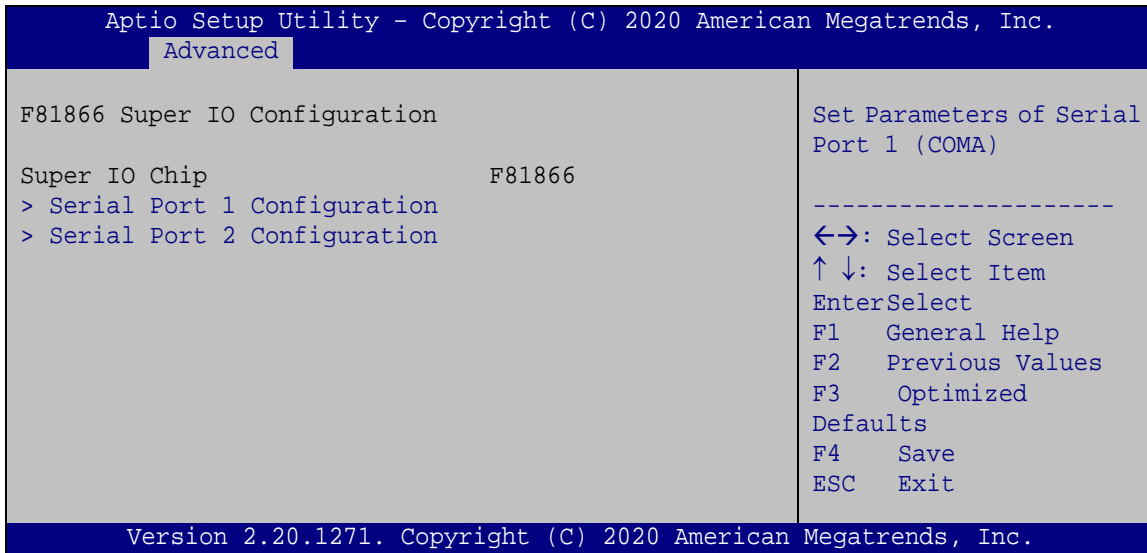

BIOS Menu 10: F81866 Super IO Configuration

FLEX-BX100-ULT5

4.3.7.1 Serial Port n Configuration

Use the **Serial Port n Configuration** menu (**BIOS Menu 11**) to configure the serial port n.

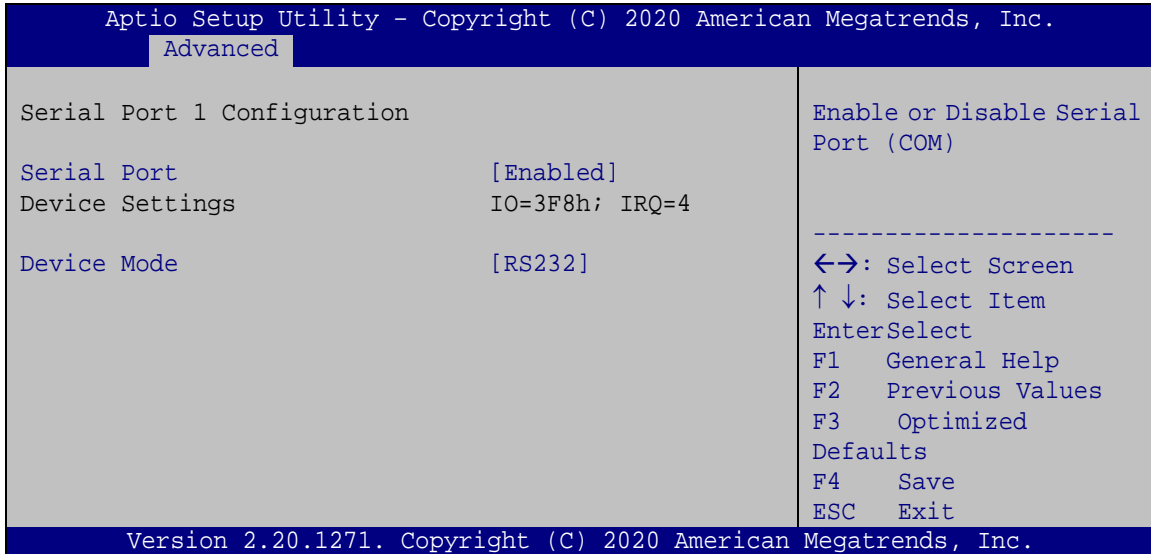

BIOS Menu 11: Serial Port n Configuration

4.3.7.1.1 Serial Port 1 Configuration

→ Serial Port [Enabled]

Use the **Serial Port** option to enable or disable the serial port.

- **Disabled** Disable the serial port
- **Enabled** **DEFAULT** Enable the serial port

→ Device Mode [RS232]

Use the **Device Mode** option to select the Serial Port 1 signaling mode.

- **RS422** Serial Port 1 signaling mode is RS-422
- **RS232** **DEFAULT** Serial Port 1 signaling mode is RS-232
- **RS485** Serial Port 1 signaling mode is RS-485

4.3.7.1.2 Serial Port 2 Configuration

➔ **Serial Port [Enabled]**

Use the **Serial Port** option to enable or disable the serial port.

- ➔ **Disabled** Disable the serial port
- ➔ **Enabled** **DEFAULT** Enable the serial port

4.3.8 Serial Port Console Redirection

The **Serial Port Console Redirection** menu (**BIOS Menu 12**) allows the console redirection options to be configured. Console redirection allows users to maintain a system remotely by re-directing keyboard input and text output through the serial port.

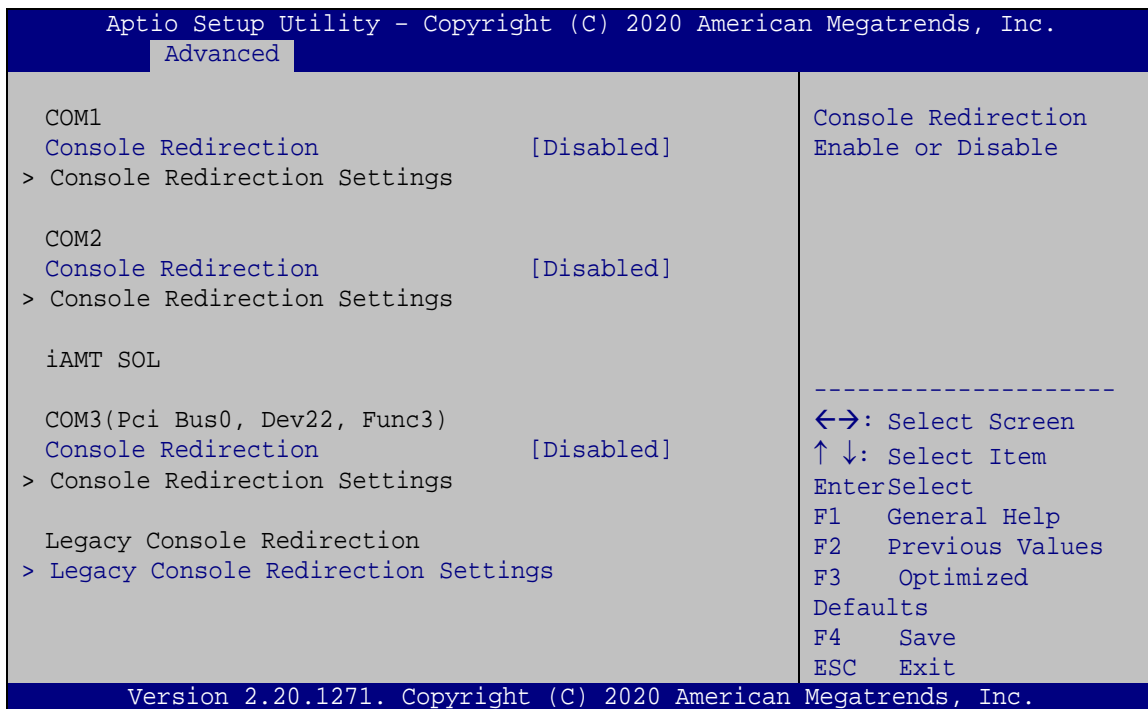

BIOS Menu 12: Serial Port Console Redirection

FLEX-BX100-ULT5

→ Console Redirection [Disabled]

Use **Console Redirection** option to enable or disable the console redirection function.

- **Disabled** **DEFAULT** Disabled the console redirection function
- **Enabled** Enabled the console redirection function

4.3.8.1 Legacy Console Redirection Settings

The **Legacy Console Redirection Settings** menu (**BIOS Menu 13**) allows the legacy console redirection options to be configured.

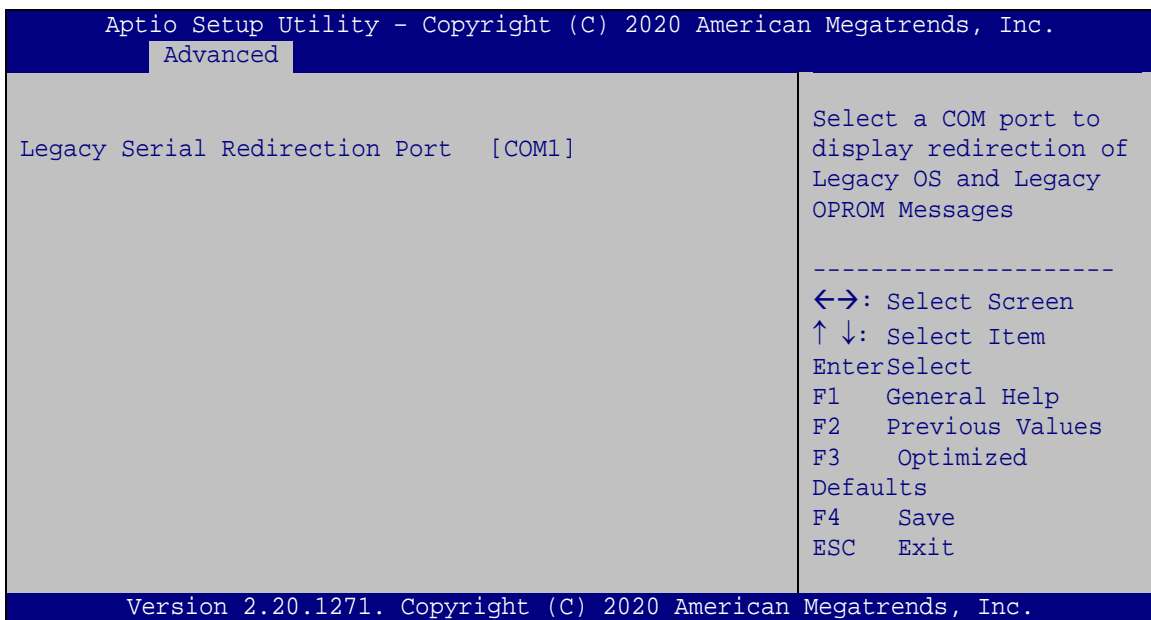

BIOS Menu 13: Legacy Console Redirection Settings

→ Legacy Serial Redirection Port [COM1]

Use the **Legacy Serial Redirection Port** option to specify a COM port to display redirection of legacy OS and legacy OPRM messages. The options include:

- COM1 **DEFAULT**
- COM2
- COM3 (Pci Bus0, Dev22, Func3)

4.3.8.2 Console Redirection Settings

The **Console Redirection Settings** menu (**BIOS Menu 14**) allows the console redirection options to be configured. The option is active when **Console Redirection** option is enabled.

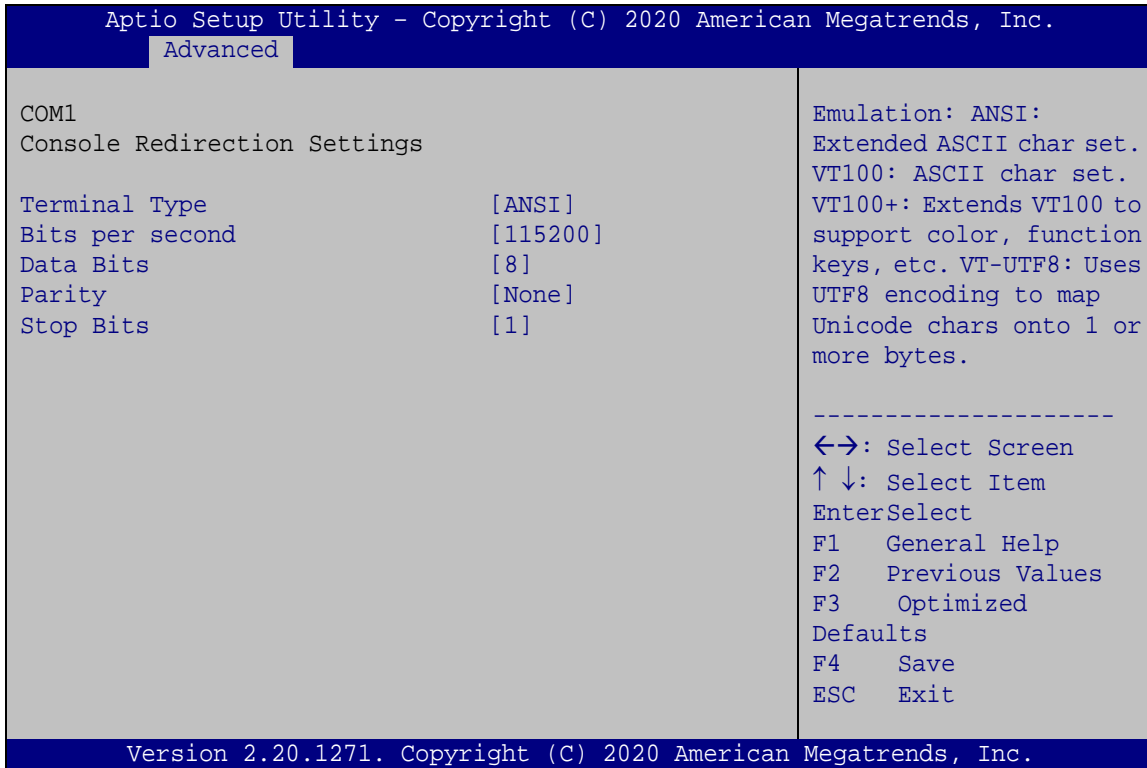

BIOS Menu 14: Console Redirection Settings

→ Terminal Type [ANSI]

Use the **Terminal Type** option to specify the remote terminal type.

- **VT100** The target terminal type is VT100
- **VT100+** The target terminal type is VT100+
- **VT-UTF8** The target terminal type is VT-UTF8
- **ANSI** **DEFAULT** The target terminal type is ANSI

FLEX-BX100-ULT5**→ Bits per second [115200]**

Use the **Bits per second** option to specify the serial port transmission speed. The speed must match the other side. Long or noisy lines may require lower speeds.

- | | | | |
|---|---------------|----------------|--|
| → | 9600 | | Sets the serial port transmission speed at 9600. |
| → | 19200 | | Sets the serial port transmission speed at 19200. |
| → | 57600 | | Sets the serial port transmission speed at 57600. |
| → | 115200 | DEFAULT | Sets the serial port transmission speed at 115200. |

→ Data Bits [8]

Use the **Data Bits** option to specify the number of data bits.

- | | | | |
|---|----------|----------------|--------------------------|
| → | 7 | | Sets the data bits at 7. |
| → | 8 | DEFAULT | Sets the data bits at 8. |

→ Parity [None]

Use the **Parity** option to specify the parity bit that can be sent with the data bits for detecting the transmission errors.

- | | | | |
|---|--------------|----------------|---|
| → | None | DEFAULT | No parity bit is sent with the data bits. |
| → | Even | | The parity bit is 0 if the number of ones in the data bits is even. |
| → | Odd | | The parity bit is 0 if the number of ones in the data bits is odd. |
| → | Mark | | The parity bit is always 1. This option does not provide error detection. |
| → | Space | | The parity bit is always 0. This option does not provide error detection. |

➔ **Stop Bits [1]**

Use the **Stop Bits** option to specify the number of stop bits used to indicate the end of a serial data packet. Communication with slow devices may require more than 1 stop bit.

- ➔ **1** **DEFAULT** Sets the number of stop bits at 1.
- ➔ **2** Sets the number of stop bits at 2.

4.3.9 USB Configuration

Use the **USB Configuration** menu (**BIOS Menu 15**) to read USB configuration information and configure the USB settings.

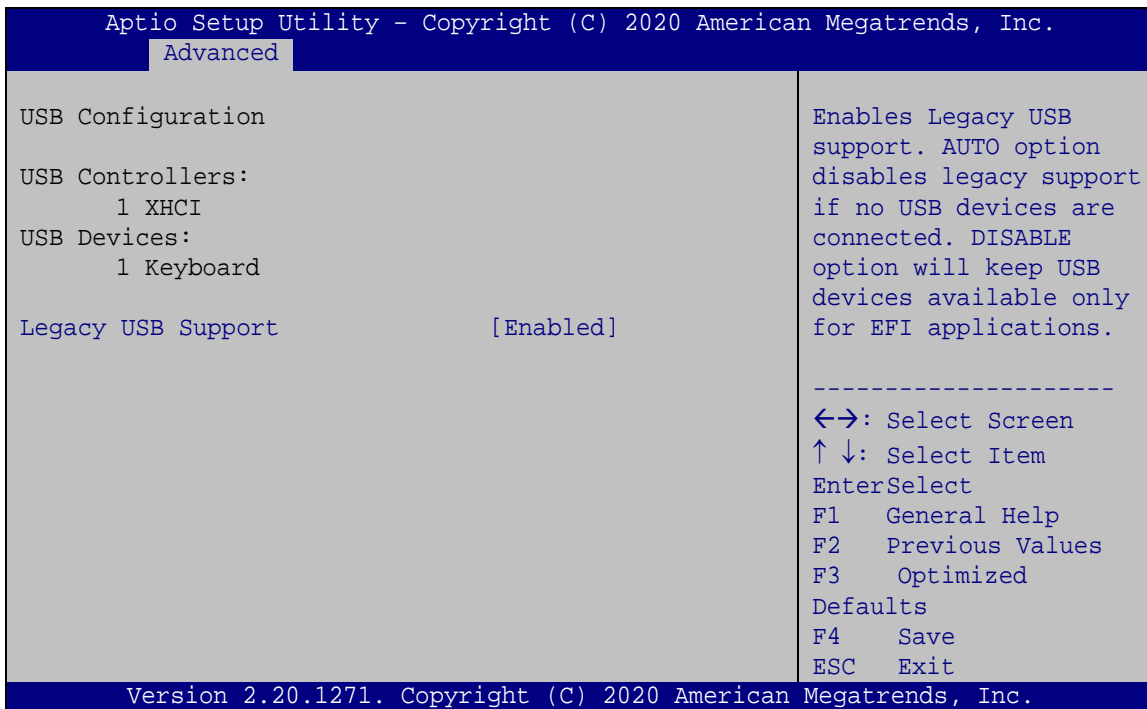

BIOS Menu 15: USB Configuration

➔ **USB Devices**

The **USB Devices Enabled** field lists the USB devices that are enabled on the system

FLEX-BX100-ULT5

→ Legacy USB Support [Enabled]

Use the **Legacy USB Support** BIOS option to enable USB mouse and USB keyboard support. Normally if this option is not enabled, any attached USB mouse or USB keyboard does not become available until a USB compatible operating system is fully booted with all USB drivers loaded. When this option is enabled, any attached USB mouse or USB keyboard can control the system even when there is no USB driver loaded onto the system.

- **Enabled** **DEFAULT** Legacy USB support enabled
- **Disabled** Legacy USB support disabled
- **Auto** Legacy USB support disabled if no USB devices are connected

4.3.10 CSM Configuration

Use the **CSM Configuration** menu (**BIOS Menu 16**) to configure Compatibility Support Module (CSM).

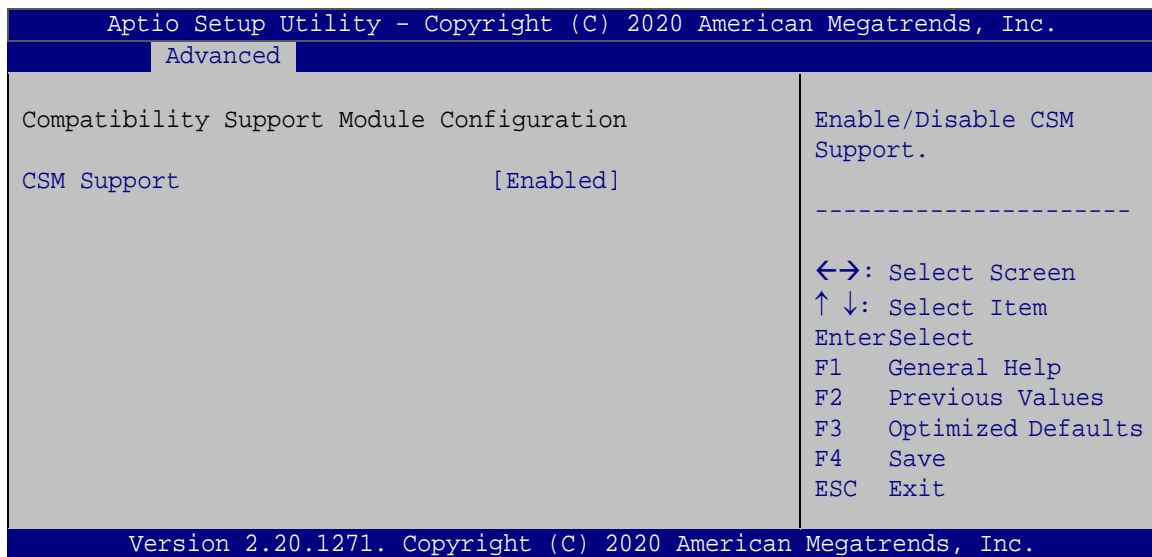

BIOS Menu 16: CSM Configuration

➔ **CSM Support [Enabled]**

Use the **CSM Support** BIOS option to enable or disable CSM support.

- ➔ **Disabled** CSM support disabled
- ➔ **Enabled DEFAULT** CSM support enabled

4.3.11 NVMe Configuration

Use the **NVMe Configuration (BIOS Menu 17)** menu to display the NVMe controller and device information.

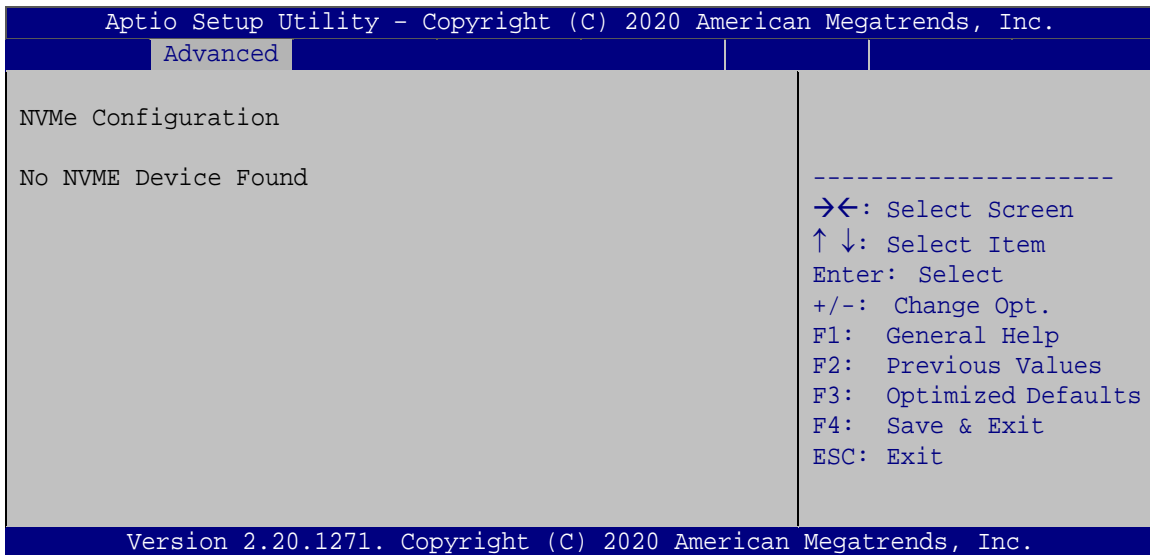

BIOS Menu 17: NVMe Configuration

FLEX-BX100-ULT5

4.3.12 IEI Feature

Use the **IEI Feature** menu (**BIOS Menu 18**) to configure One Key Recovery function.

```

Aptio Setup Utility - Copyright (C) 2020 American Megatrends, Inc.
-----
Advanced
-----
iEi Feature
Auto Recovery Function          [Disabled]
                                Auto Recovery Function
                                Reboot and recover
                                system automatically
                                within 10 min, when OS
                                crashes. Please install
                                Auto Recovery API
                                service before enabling
                                this function
                                -----
                                ←→: Select Screen
                                ↑↓: Select Item
                                Enter>Select
                                F1   General Help
                                F2   Previous Values
                                F3   Optimized Defaults
                                F4   Save
                                ESC  Exit
-----
Version 2.20.1271. Copyright (C) 2020 American Megatrends, Inc.

```

BIOS Menu 18: IEI Feature

→ Auto Recovery Function [Disabled]

Use the **Auto Recovery Function** BIOS option to enable or disable the auto recovery function of the IEI One Key Recovery.

- **Disabled** **DEFAULT** Auto recovery function disabled
- **Enabled** Auto recovery function enabled

4.4 Chipset

Use the **Chipset** menu (**BIOS Menu 19**) to configure the system chipset.

```

Aptio Setup Utility - Copyright (C) 2020 American Megatrends, Inc.
Main   Advanced  Chipset  Security  Boot   Save & Exit

> System Agent (SA) Configuration
> PCH-IO Configuration

System Agent (SA)
Parameters

-----
<->: Select Screen
↑↓: Select Item
Enter>Select
+ - Change Opt.
F1  General Help
F2  Previous Values
F3  Optimized Defaults
F4  Save & Exit
ESC Exit

Version 2.20.1271. Copyright (C) 2020 American Megatrends, Inc.
    
```

BIOS Menu 19: Chipset

4.4.1 System Agent (SA) Configuration

Use the **System Agent (SA) Configuration** menu (**BIOS Menu 20**) to configure the System Agent (SA) parameters.

```

Aptio Setup Utility - Copyright (C) 2020 American Megatrends, Inc.
Chipset

System Agent (SA) Configuration
VT-d                               Supported

> Memory Configuration
> Graphics Configuration

VT-d                               [Disabled]

Memory Configuration
Parameters

-----
<->: Select Screen
↑↓: Select Item
Enter>Select
+ - Change Opt.
F1  General Help
F2  Previous Values
F3  Optimized Defaults
F4  Save & Exit
ESC Exit

Version 2.20.1271. Copyright (C) 2020 American Megatrends, Inc.
    
```

BIOS Menu 20: System Agent (SA) Configuration

FLEX-BX100-ULT5

→ VT-d [Disabled]

Use the **VT-d** option to enable or disable VT-d support.

- **Disabled** **DEFAULT** Disable VT-d support.
- **Enabled** Enable VT-d support.

4.4.1.1 Memory Configuration

Use the **Memory Configuration** submenu (**BIOS Menu 21**) to display the memory information.

```

Aptio Setup Utility - Copyright (C) 2020 American Megatrends, Inc.
  Chipset
-----
Memory Configuration
Memory Frequency          2133 MHz
DIMM1                     Not Populated / Disabled
DIMM2                     Populated & Enabled
  Size                    4096 MB (DDR4)
-----
←→: Select Screen
↑ ↓: Select Item
EnterSelect
+ - Change Opt.
F1  General Help
F2  Previous Values
F3  Optimized Defaults
F4  Save & Exit
ESC Exit
Version 2.20.1271. Copyright (C) 2020 American Megatrends, Inc.
    
```

BIOS Menu 21: Memory Configuration

4.4.1.2 Graphics Configuration

Use the **Graphics Configuration** menu (**BIOS Menu 22**) to configure the graphics settings.

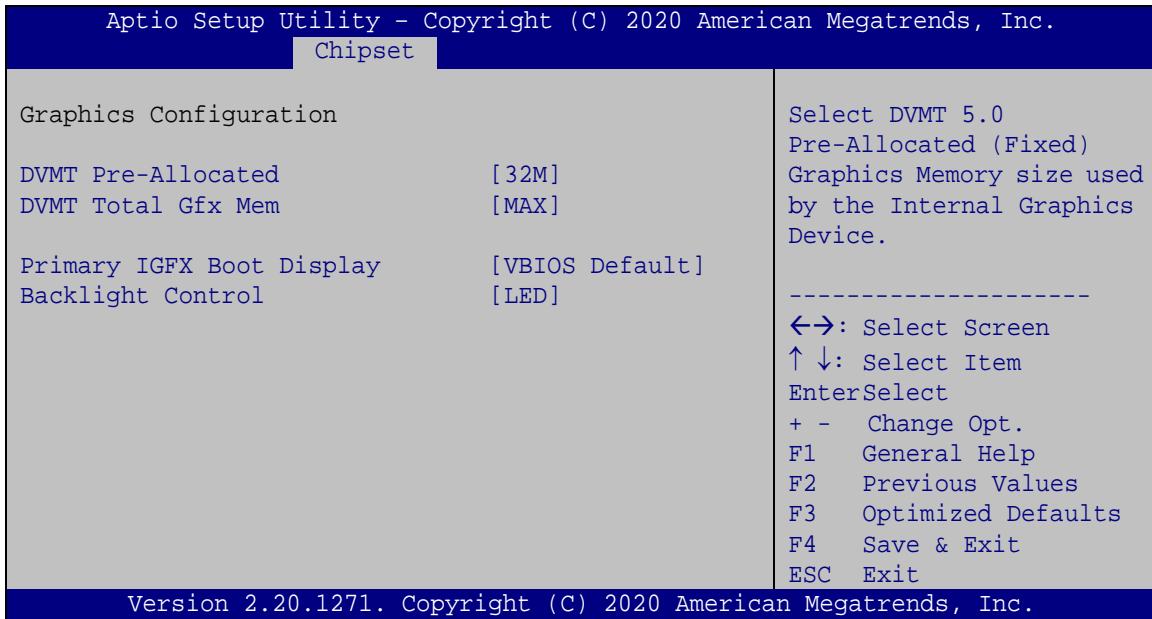

BIOS Menu 22: Graphics Configuration

→ DVMT Pre-Allocated [32M]

Use the **DVMT Pre-Allocated** option to set the amount of system memory allocated to the integrated graphics processor when the system boots. The system memory allocated can then only be used as graphics memory, and is no longer available to applications or the operating system. Configuration options are listed below:

- 32M **DEFAULT**
- 64M

→ DVMT Total Gfx Mem [MAX]

Use the **DVMT Total Gfx Mem** option to select DVMT 5.0 total graphic memory size used by the internal graphics device. The following options are available:

- 128M
- 256M

FLEX-BX100-ULT5

- MAX DEFAULT

→ Primary IGFX Boot Display [VBIOS Default]

Use the **Primary IGFX Boot Display** option to select the display device used by the system when it boots.

- VBIOS Default **DEFAULT**
- HDMI
- LVDS

→ Backlight Control [LED]

Use the **Backlight Control** option to specify the backlight control mode. Configuration options are listed below.

- LED **DEFAULT**

4.4.2 PCH-IO Configuration

Use the **PCH-IO Configuration** menu (**BIOS Menu 23**) to configure the PCH-IO chipset.

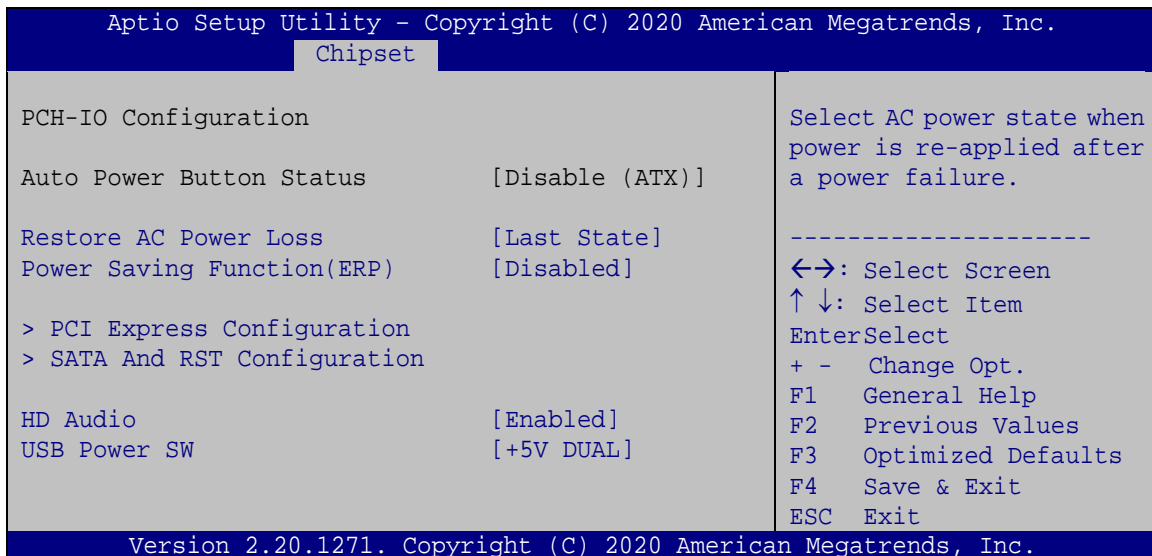

BIOS Menu 23: PCH-IO Configuration

→ Restore AC Power Loss [Last State]

Use the **Restore AC Power** BIOS option to specify what state the system returns to if there is a sudden loss of power to the system.

- **Power Off** The system remains turned off
- **Power On** The system turns on
- **Last State** **DEFAULT** The system returns to its previous state. If it was on, it turns itself on. If it was off, it remains off.

→ Power Saving Function(ERP) [Disabled]

Use the **Power Saving Function(ERP)** BIOS option to enable or disable the power saving function.

- **Disabled** **DEFAULT** Power saving function is disabled.
- **Enabled** Power saving function is enabled. It will reduce power consumption when the system is off.

→ HD Audio [Enabled]

Use the **HD Audio** BIOS option to enable or disable the High Definition Audio controller.

- **Disabled** The High Definition Audio controller is disabled.
- **Enabled** **DEFAULT** The High Definition Audio controller is enabled.

→ USB Power SW [+5V DUAL]

Use the **USB Power SW** BIOS option to configure whether to provide power to the external USB connectors when the system is in S3/S4 sleep state. This option is valid only when the above **Power Saving Function (ERP)** BIOS option is disabled.

- **+5V** **DEFAULT** Power is provided to the USB connectors when the system is in S3/S4 sleep state
- **+5V** Power is not provided to the USB connectors when the system is in S3/S4 sleep state

➔ **Detect Non-Compliance Device [Disabled]**

Use the **Detect Non-Compliance Device** option to enable or disable detecting if a non-compliance PCI Express device is connected to the PCI Express slot.

- ➔ **Disabled** **DEFAULT** Disables to detect if a non-compliance PCI Express device is connected to the PCI Express slot.
- ➔ **Enabled** Enables to detect if a non-compliance PCI Express device is connected to the PCI Express slot.

4.4.2.2 SATA And RST Configuration

Use the **SATA And RST Configuration** menu (**BIOS Menu 25**) to change and/or set the configuration of the SATA devices installed in the system.

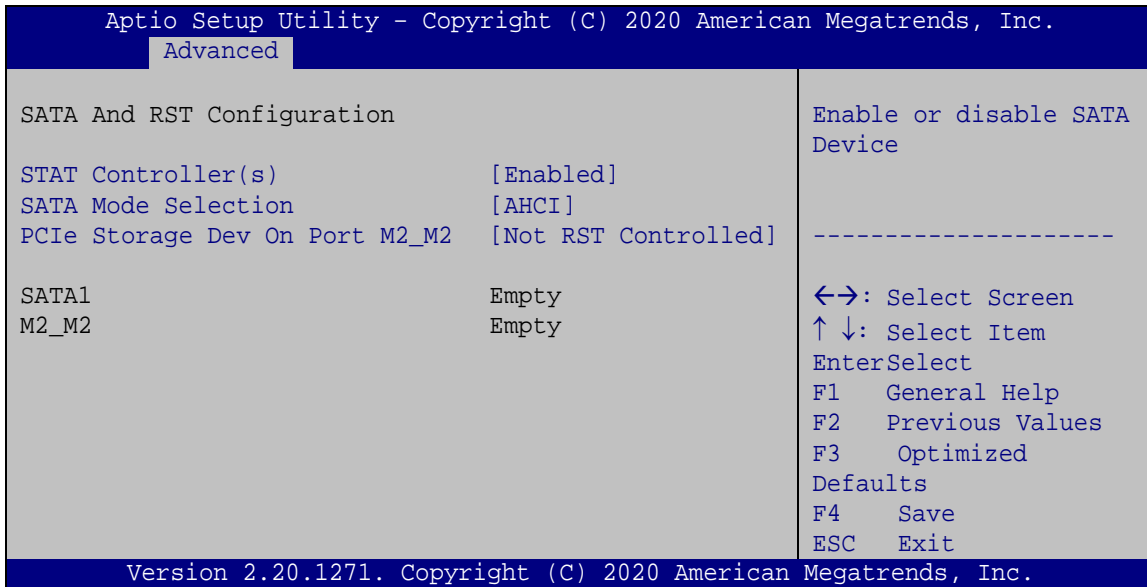

BIOS Menu 25: SATA and RST Configuration

➔ **STAT Controller(s) [Enabled]**

Use the **STAT Controller(s)** option to enable or disable the SATA device.

- ➔ **Enabled** **DEFAULT** Enables the SATA device.
- ➔ **Disabled** Disables the SATA device.

FLEX-BX100-ULT5

→ SATA Mode Selection [AHCI]

Use the **SATA Mode Selection** option to configure how the SATA controller(s) operate.

- **AHCI** **DEFAULT** Configures SATA devices as AHCI device.
- **Intel RST** Configures SATA devices as RAID device.
Premium
with Intel
Optane
System
Acceleration



NOTE:

Before accessing the RAID configuration utility, ensure to set the **Option ROM Messages** BIOS option in the **Boot** menu to **Force BIOS**. This is to allow the “Press <CTRL+I> to enter Configuration Utility.....” message to appear during POST. Press Ctrl+I when prompted to enter the RAID configuration utility.

→ PCIe Storage Dev On Port M2_M2 [Not RST Controlled]

Use the **PCIe Storage Dev On Port M2_M2** option to enable or disable RST PCIe storage remapping for the M.2 M-key slot (M2_M2).

- **RST** Enable RST PCIe storage remapping.
Controlled
- **Not RST** **DEFAULT** Disable RST PCIe storage remapping.
Controlled

4.5 Security

Use the **Security** menu (**BIOS Menu 26**) to set system and user passwords.

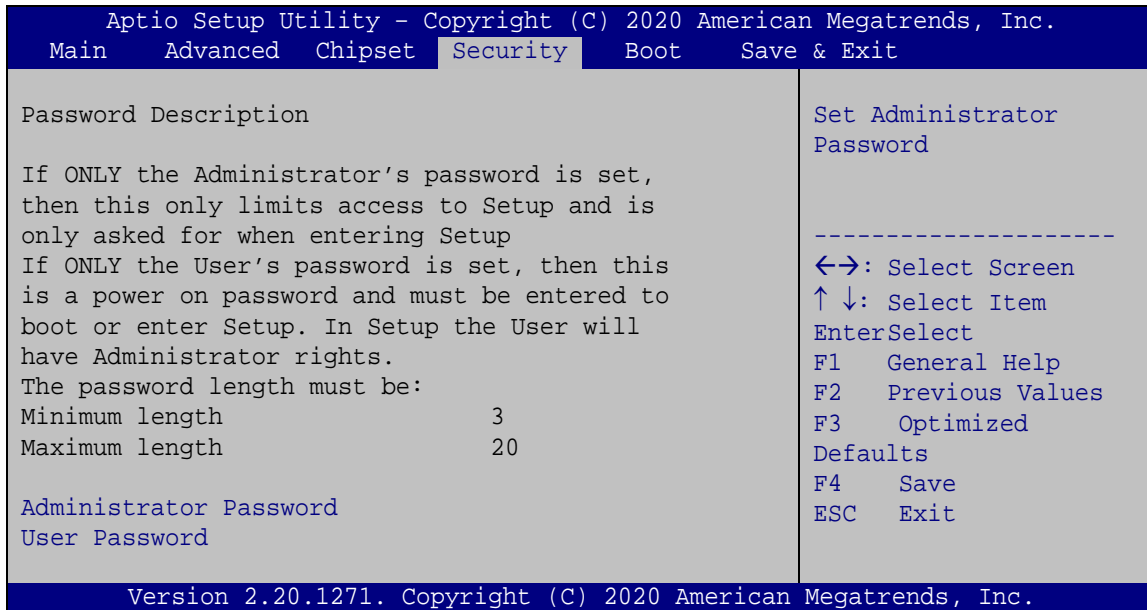

BIOS Menu 26: Security

➔ Administrator Password

Use the **Administrator Password** to set or change a administrator password.

➔ User Password

Use the **User Password** to set or change a user password.

FLEX-BX100-ULT5

4.6 Boot

Use the **Boot** menu (**BIOS Menu 27**) to configure system boot options.

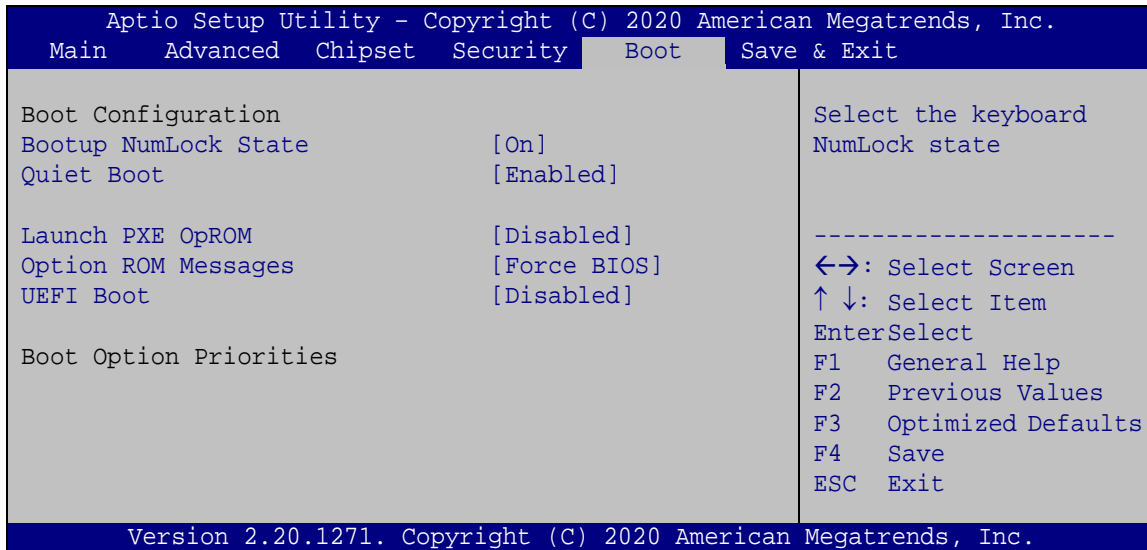

BIOS Menu 27: Boot

→ Bootup NumLock State [On]

Use the **Bootup NumLock State** BIOS option to specify if the number lock setting must be modified during boot up.

→ **On** **DEFAULT** Allows the Number Lock on the keyboard to be enabled automatically when the computer system boots up. This allows the immediate use of the 10-key numeric keypad located on the right side of the keyboard. To confirm this, the Number Lock LED light on the keyboard is lit.

→ **Off** Does not enable the keyboard Number Lock automatically. To use the 10-keys on the keyboard, press the Number Lock key located on the upper left-hand corner of the 10-key pad. The Number Lock LED on the keyboard lights up when the Number Lock is engaged.

→ Quiet Boot [Enabled]

Use the **Quiet Boot** BIOS option to select the screen display when the system boots.

- **Disabled** Normal POST messages displayed
- **Enabled** **DEFAULT** OEM Logo displayed instead of POST messages

→ Launch PXE OpROM [Disabled]

Use the **Launch PXE OpROM** option to enable or disable boot option for legacy network devices.

- **Disabled** **DEFAULT** Ignore all PXE Option ROMs
- **Enabled** Load PXE Option ROMs.

→ Option ROM Messages [Force BIOS]

Use the **Option ROM Messages** option to set the Option ROM display mode.

- **Force BIOS** **DEFAULT** Sets display mode to force BIOS.
- **Keep Current** Sets display mode to current.

→ UEFI Boot [Disabled]

Use the **UEFI Boot** option to enable or disable to boot from the UEFI devices.

- **Enabled** Boot from UEFI devices is enabled.
- **Disabled** **DEFAULT** Boot from UEFI devices is disabled.

→ Boot Option Priority

Use the **Boot Option Priority** function to set the system boot sequence from the available devices. The drive sequence also depends on the boot sequence in the individual device section.

FLEX-BX100-ULT5

4.7 Save & Exit

Use the **Save & Exit** menu (**BIOS Menu 28**) to load default BIOS values, optimal failsafe values and to save configuration changes.

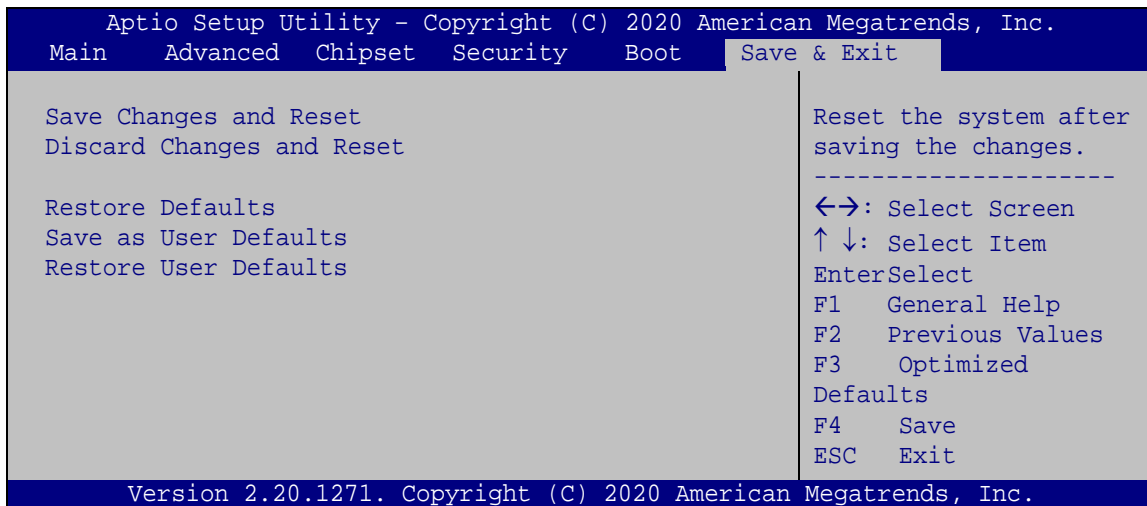
**BIOS Menu 28: Save & Exit**→ **Save Changes and Reset**

Use the **Save Changes and Reset** option to save the changes made to the BIOS options and to exit the BIOS configuration setup program.

→ **Discard Changes and Reset**

Use the **Discard Changes and Reset** option to exit the system without saving the changes made to the BIOS configuration setup program.

→ **Restore Defaults**

Use the **Restore Defaults** option to load the optimal default values for each of the parameters on the Setup menus. **F3 key can be used for this operation.**

→ **Save as User Defaults**

Use the **Save as User Defaults** option to save the changes done so far as user defaults.

→ **Restore User Defaults**

Use the **Restore User Defaults** option to restore the user defaults to all the setup options.

Chapter

5

Troubleshooting and Maintenance

FLEX-BX100-ULT5



WARNING:

Take Anti-Static precautions whenever maintenance is being carried out on the system components. Failure to take anti-static precautions can cause permanent system damage. For more details on anti-static precautions, please refer to **Section 3.1**.

5.1 System Maintenance Overview



NOTE:

When doing maintenance operations on the system, please follow the instructions in this chapter. Failure to follow these instructions may lead to personal injury and system damage.

To preserve the working integrity of the FLEX-BX100-ULT5 box PC, the system must be properly maintained. If box PC components need replacement, the proper maintenance procedures must be followed to ensure the system can continue to operate normally.

5.2 System Troubleshooting

This section provides some simple troubleshooting suggestions.

5.2.1 The System Doesn't Turn On

If after turning the system on, there is no power (indicated by the power LED on the front panel not turning on) please do the following:

- Step 1:** Check that the power cable connector is properly connected to the system front panel.
- Step 2:** Check that the power cable connector is properly plugged into the power source.
- Step 3:** Make sure the power button is turned on.

Step 4: Plug the system into a monitor and check to see if anything appears on the screen. If the boot-up screen appears it means the power LED has failed. To fix this problem, contact an IEI sales representative directly.

5.2.2 The System Doesn't Boot Up

If the system doesn't boot up please do the following:

Step 1: Check the power is turned on. See Section 5.2.1 above.

Step 2: Make sure the SO-DIMM modules are properly installed.

5.2.3 More Troubleshooting

Nothing appears on the monitor after booting up the system: Make sure the monitor is properly connected to the system and the monitor is connected to a power supply and turned on.



WARNING!

If all troubleshooting measures have been taken and the system still fails to start, contact the IEI reseller or vendor you purchased the FLEX-BX100-ULT5 from or contact an IEI sales representative directly. To contact an IEI sales representative, please send an email to sales@ieiworld.com.

FLEX-BX100-ULT5

5.3 Component Replacement



WARNING!

Users are not advised to attempt to repair or replace any internal or external components of the FLEX-BX100-ULT5 box PC. If any other components fail or need replacement, contact the IEI reseller or vendor you purchased the FLEX-BX100-ULT5 from or contact an IEI sales representative directly. To contact an IEI sales representative, please send an email to sales@ieiworld.com.

Chapter

6

Interface Connectors

FLEX-BX100-ULT5

6.1 Peripheral Interface Connectors

The FLEX-BX100-ULT5 box PC motherboard comes with a number of peripheral interface connectors and configuration jumpers. The connector locations are shown in **Figure 6-1**. The Pin 1 locations of the on-board connectors are also indicated in the diagram below. The connector pinouts for these connectors are listed in the following sections.

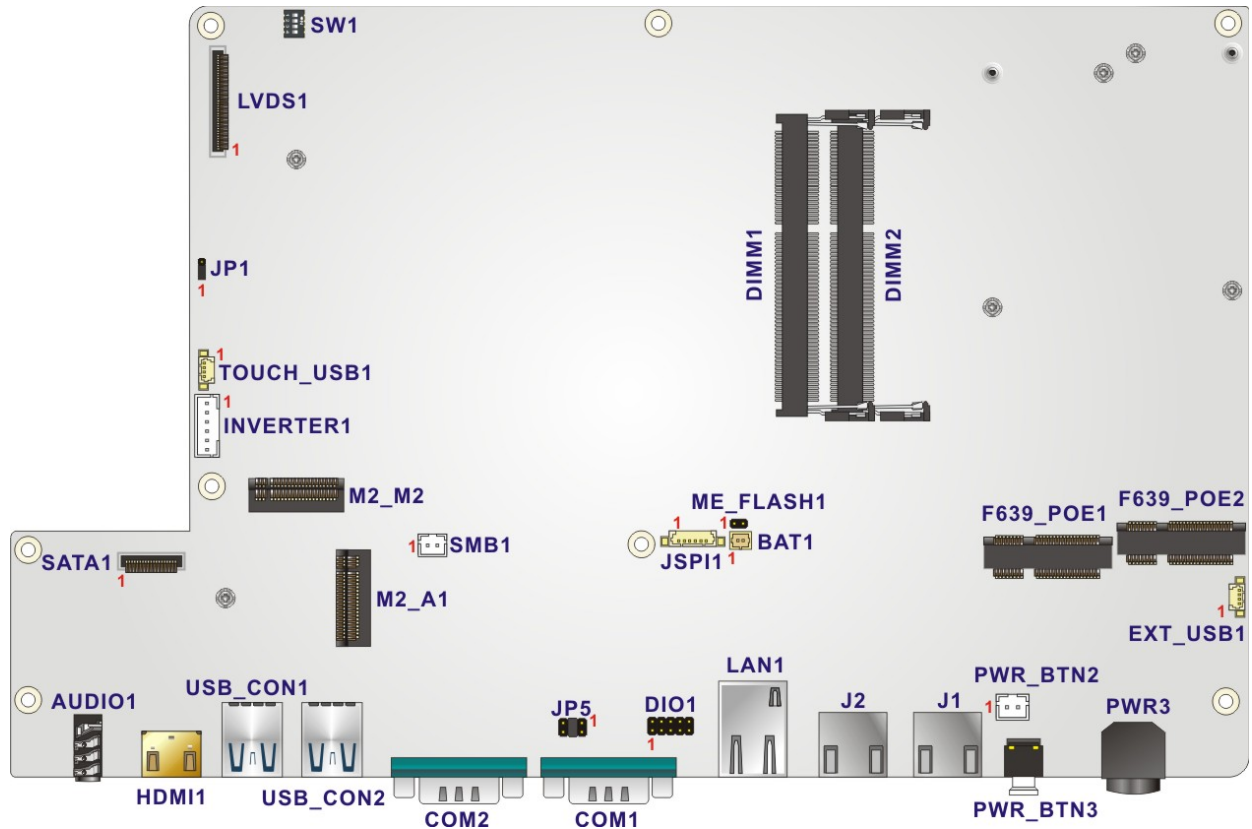

Figure 6-1: Main Board Layout Diagram

6.2 Internal Peripheral Connectors

Internal peripheral connectors are found on the motherboard and are only accessible when the motherboard is outside of the chassis. The table below shows a list of the peripheral interface connectors on the motherboard. Pinouts of these connectors can be found in the following sections.

Connector	Type	Label
Battery connector	2-pin wafer	BAT1
Digital I/O connector	10-pin header	DIO1
IEI PoE module slots	Full-size/Half-size PCIe Mini slot	F639_POE1, F639_POE2
Inverter connector	6-pin wafer	INVERTER1
LVDS connector	40-pin connector	LVDS1
M.2 slot (support WLAN module)	A-key slot	M2_A1
M.2 slot (support SSD)	M-key slot	M2_M2
Power button connector	2-pin wafer	PWR_BTN2
SATA connector	20-pin connector	SATA1
SMBus connector	2-pin wafer	SMB1
SPI Flash connector	6-pin wafer	JSPI1
USB connectors	4-pin wafer	TOUCH_USB1 EXT_USB1

Table 6-1: Peripheral Interface Connectors

6.2.1 Battery Connector (BAT1)

PIN NO.	DESCRIPTION
1	VBATT
2	GND

Table 6-2: Battery Connector (BAT1) Pinouts

FLEX-BX100-ULT5

6.2.2 Digital I/O Connector (DIO1)

PIN NO.	DESCRIPTION	PIN NO.	DESCRIPTION
1	GND	2	+5V
3	DOUT3	4	DOUT2
5	DOUT1	6	DOUT0
7	DIN3	8	DIN2
9	DIN1	10	DINO

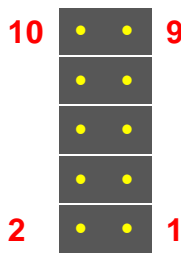

Table 6-3: Digital I/O Connector (DIO1) Pinouts

6.2.3 Inverter Connector (INVERTER1)

PIN NO.	DESCRIPTION
1	+12V
2	+12V
3	ENABKL
4	BRIGHTNESS
5	GND
6	GND

Table 6-4: Inverter Connector (INVERTER1) Pinouts

6.2.4 LVDS Connector (LVDS1)

PIN NO.	DESCRIPTION	PIN NO.	DESCRIPTION
1	+VCC_LCD	2	+VCC_LCD
3	+VCC_LCD	4	+VCC_LCD
5	+VCC_LCD	6	NC
7	LVDS_RESETB	8	GND
9	GND	10	GND
11	GND	12	
13	CLK2M_L	14	GND
15	A7P_L	16	A7M_L

17	GND	18	A6P_L
19	A6M_L	20	GND
21	A5P_L	22	A5M_L
23	GND	24	A4P_L
25	A4M_L	26	GND
27	A3P_L	28	A3M_L
29	GND	30	CLK1P_L
31	CLK1M_L	32	GND
33	A2P_L	34	A2M_L
35	GND	36	A1M_L
37	A1P_L	38	GND
39	A0M_L	40	A0P_L

Table 6-5: LVDS Connector (LVDS1) Pinouts

6.2.5 M.2 A-Key Slot (M2_A1)

PIN NO.	DESCRIPTION	PIN NO.	DESCRIPTION
1	GND	2	+V3.3A
3	USB+	4	+V3.3A
5	USB-	6	NC
7	GND	8	Module Key
9	Module Key	10	Module Key
11	Module Key	12	Module Key
13	Module Key	14	Module Key
15	Module Key	16	NC
17	NC	18	GND
19	NC	20	NC
21	NC	22	NC
23	GND	24	GND
25	NC	26	NC
27	NC	28	NC
29	GND	30	GND

FLEX-BX100-ULT5

31	NC	32	NC
33	GND	34	NC
35	PCIE_TX+	36	GND
37	PCIE_TX-	38	NC
39	GND	40	NC
41	PCIE_RX+	42	NC
43	PCIE_RX-	44	NC
45	GND	46	NC
47	CLK_PCIE+	48	NC
49	CLK_PCIE-	50	NC
51	GND	52	BUF_PLT_RST#
53	NC	54	BT_DISABLE
55	PCIE_WAKE#	56	WIFI_DISABLE
57	GND	58	SMB_DATA
59	NC	60	SMB_CLK
61	NC	62	NC
63	GND	64	NC
65	NC	66	NC
67	NC	68	NC
69	GND	70	NC
71	NC	72	+V3.3A
73	NC	74	+V3.3A
75	GND		

Table 6-6: M.2 A-Key Slot (M2_A1) Pinouts

6.2.6 M.2 M-key Slot (M2_M2)

PIN NO.	DESCRIPTION	PIN NO.	DESCRIPTION
1	GND	2	+3.3VA
3	GND	4	+3.3VA
5	PCIE_RX-	6	N/C
7	PCIE_RX+	8	N/C

9	GND	10	+3.3VA
11	PCIE_TX-	12	+3.3VA
13	PCIE_TX+	14	+3.3VA
15	GND	16	+3.3VA
17	PCIE_RX-	18	+3.3VA
19	PCIE_RX+	20	N/C
21	GND	22	N/C
23	PCIE_TX-	24	N/C
25	PCIE_TX+	26	N/C
27	GND	28	N/C
29	PCIE_RX-	30	N/C
31	PCIE_RX+	32	N/C
33	GND	34	N/C
35	PCIE_TX-	36	N/C
37	PCIE_TX+	38	SATA_SLP
39	GND	40	N/C
41	PCIE_RX+	42	N/C
43	PCIE_RX-	44	N/C
45	GND	46	N/C
47	PCIE_TX-	48	N/C
49	PCIE_TX+	50	PCIE_RST#
51	GND	52	PCIEx4_CLKREQ
53	CLK_PCIE_M2_M-	54	LAN_WAKE#
55	CLK_PCIE_M2_M+	56	N/C
57	GND	58	N/C
59	N/C	60	N/C
61	N/C	62	N/C
63	N/C	64	N/C
65	N/C	66	N/C
67	N/C	68	N/C
69	M2_IFDET	70	+3.3VA
71	GND	72	+3.3VA
73	GND	74	+3.3VA

FLEX-BX100-ULT5

75	GND		
----	-----	--	--

Table 6-7: M.2 M-key Slot (M2_M2) Pinouts

6.2.7 Power Button Connector (PWR_BTN2)

PIN NO.	DESCRIPTION
1	PW_BN
2	GND

Table 6-8: Power Button Connector (PWR_BTN2) Pinouts

6.2.8 SATA Connector (SATA1)

PIN NO.	DESCRIPTION	PIN NO.	DESCRIPTION
1	GND	11	+V5S
2	GND	12	NC
3	GND	13	NC
4	GND	14	GND
5	GND	15	SATA_RX+
6	NC	16	SATA_RX-
7	+V5S	17	GND
8	+V5S	18	SATA_TX-
9	+V5S	19	SATA_TX+
10	+V5S	20	GND

Table 6-9: SATA Connector (SATA1) Pinouts

6.2.9 SMBus Connector (SMB1)

PIN NO.	DESCRIPTION
1	SMBCLK
2	SMBDATA

Table 6-10: SMBus Connector (SMB1) Pinouts

6.2.10 SPI Flash Connector (JSPI1)

PIN NO.	DESCRIPTION
1	+V3.3M_SPI_CON
2	SPI_CS#0_CN
3	SPI_SO_SW
4	SPI_CLK_SW
5	SPI_SI_SW
6	GND

Table 6-11: SPI Flash Connector (JSPI1) Pinouts

6.2.11 USB Connector (TOUCH_USB1)

PIN NO.	DESCRIPTION
1	+V5A
2	USB_DATA7-
3	USB_DATA7+
4	GND

Table 6-12: USB Connector (TOUCH_USB1) Pinouts

FLEX-BX100-ULT5

6.2.12 USB Connector (EXT_USB1)

PIN NO.	DESCRIPTION
1	+V5A
2	USB_DATA4-
3	USB_DATA4+
4	GND

Table 6-13: USB Connector (EXT_USB1) Pinouts

6.3 External Interface Panel Connectors

The table below lists the external connectors on the AFL3MB-ULT5 motherboard. Pinouts of these connectors can be found in the following sections.

Connector	Type	Label
Audio line-out connector	Audio jack	AUDIO1
Ethernet connector	RJ-45	LAN1
Ethernet connector with PoE	RJ-45	J1, J2
HDMI connector	HDMI connector	HDMI1
Power connector	Power jack	PWR3
RS-232 serial port	D-sub 9	COM2
RS-232/422/485 serial port	D-sub 9	COM1
USB 3.2 Gen 2 connectors	USB 3.2 Gen 2 port	USB_CON1 USB_CON2

Table 6-14: External Connectors

6.3.1 Ethernet Connectors (LAN1, J1, J2)

PIN NO.	DESCRIPTION	PIN NO.	DESCRIPTION
1	MDIA0+	5	MDIA2-
2	MDIA0-	6	MDIA1-
3	MDIA1+	7	MDIA3+
4	MDIA2+	8	MDIA3-

LED A **LED B**

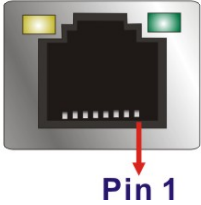

Pin 1

Table 6-15: Ethernet Connectors (LAN1, J1, J2) Pinouts

LED	Description	LED	Description
A	on: linked blinking: data is being sent/received	B	off: 10 Mb/s green: 100 Mb/s orange: 1000 Mb/s

Table 6-16: Ethernet Connector LEDs

6.3.2 HDMI Connector (HDMI1)

PIN NO.	DESCRIPTION	PIN NO.	DESCRIPTION
1	HDMI_DATA2+	11	GND
2	GND	12	HDMI_CLK#
3	HDMI_DATA2#-	13	N/C
4	HDMI_DATA1+	14	N/C
5	GND	15	HDMI_SCL
6	HDMI_DATA1#-	16	HDMI_SDA
7	HDMI_DATA0+	17	GND
8	GND	18	+5VCC
9	HDMI_DATA0#-	19	HDMI_HPD
10	HDMI_CLK+		

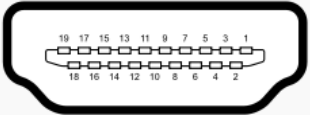

Table 6-17: HDMI Connector (HDMI1) Pinouts

FLEX-BX100-ULT5

6.3.3 Power Connector (PWR3)

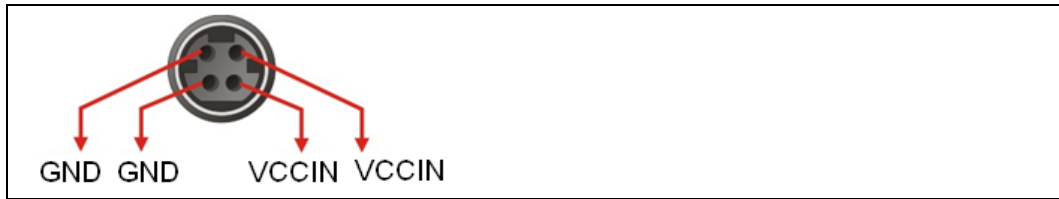

Table 6-18: Power Connector (PWR3) Pinouts

6.3.4 RS-232/422/485 DB-9 Serial Port (COM1)

Pin	RS-232	RS-422	RS-485
1	DCD1	TXD422-	TXD485-
2	SIN1	TXD422+	TXD485+
3	SOUT1	RXD422+	
4	DTR1	RXD422-	
5	GND		
6	DSR1		
7	RTS1		
8	CTS1		
9	RI1		

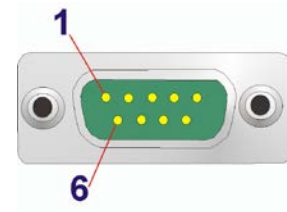

Table 6-19: RS-232/422/485 DB-9 Serial Port (COM1) Pinouts

6.3.5 RS-232 RJ-45 Serial Port (COM2)

PIN NO.	DESCRIPTION	PIN NO.	DESCRIPTION
1	DCD2	6	DSR2
2	SIN2	7	RTS2
3	SOUT2	8	CTS2
4	RTS2	9	RI2
5	GND		

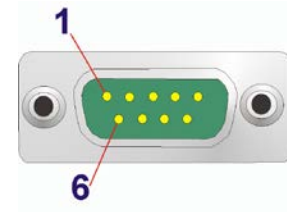

Table 6-20: RS-232 RJ-45 Serial Port (COM2) Pinouts

6.3.6 USB 3.2 Gen 2 Connectors (USB_CON1, USB_CON2)

PIN NO.	DESCRIPTION	PIN NO.	DESCRIPTION
1	USB_VCC	2	USB2_D0-
3	USB2_D0-	4	GND
5	USB3_RXD0-	6	USB3_RXD0+
7	GND	8	USB3_TXD0-
9	USB3_TXD0+	10	USB_VCC
11	USB2_D1-	12	USB2_D1+
13	GND	14	USB3_RXD1-
15	USB3_RXD1+	16	GND
17	USB3_TXD1-	18	USB3_TXD1+

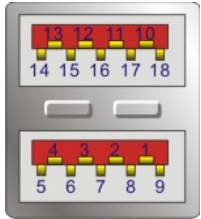

Table 6-21: USB 3.2 Gen 2 Connectors (USB_CON1, USB_CON2) Pinouts

6.4 Jumpers

The following table shows a list of jumpers on the FLEX-BX100-ULT5 motherboard.

Jumper Name	Type	Label
Flash Descriptor Security Override	2-pin header	ME_FLASH1
LVDS panel resolution selection	DIP switch	SW1
Panel voltage selection	3-pin header	JP1

Table 6-22: Jumpers

6.4.1 Flash Descriptor Security Override Jumper

The Flash Descriptor Security Override jumper (ME_FLASH1) allows to enable or disable the ME firmware update. Refer to Table 6-23 for the jumper settings.

FLEX-BX100-ULT5

Setting	Description
Open	Disabled (default)
Short	Enabled

Table 6-23: Flash Descriptor Security Override Jumper Settings

To update the ME firmware, please follow the steps below.

- Step 1:** Before turning on the system power, short the Flash Descriptor Security Override jumper.
- Step 2:** Update the BIOS and ME firmware, and then turn off the system power.
- Step 3:** Remove the metal clip on the Flash Descriptor Security Override jumper.
- Step 4:** Restart the system. The system will reboot 2 ~ 3 times to complete the ME firmware update.

Appendix

A

Regulatory Compliance

DECLARATION OF CONFORMITY

This equipment is in conformity with the following EU directives:

- EMC Directive (2014/30/EU)
- Low-Voltage Directive (2014/35/EU)
- RoHS II Directive (2011/65/EU, 2015/863/EU)

If the user modifies and/or install other devices in the equipment, the CE conformity declaration may no longer apply.

If this equipment has telecommunications functionality, it also complies with the requirements of the Radio Equipment Directive 2014/53/EU.

English

IEI Integration Corp declares that this equipment is in compliance with the essential requirements and other relevant provisions of Directive 2014/53/EU.

Български [Bulgarian]

IEI Integration Corp. декларира, че този оборудване е в съответствие със съществените изисквания и другите приложими правила на Директива 2014/53/EU

Česky [Czech]

IEI Integration Corp tímto prohlašuje, že tento zařizení je ve shodě se základními požadavky a dalšími příslušnými ustanoveními směrnice 2014/53/EU.

Dansk [Danish]

IEI Integration Corp erklærer herved, at følgende udstyr overholder de væsentlige krav og øvrige relevante krav i direktiv 2014/53/EU.

Deutsch [German]

IEI Integration Corp, erklärt dieses Gerät entspricht den grundlegenden Anforderungen und den weiteren entsprechenden Vorgaben der Richtlinie 2014/53/EU.

Eesti [Estonian]

IEI Integration Corp deklareerib seadme seadme vastavust direktiivi 2014/53/EÜ põhinõuetele ja nimetatud direktiivist tulenevatele teistele asjakohastele sätetele.

Español [Spanish]

IEI Integration Corp declara que el equipo cumple con los requisitos esenciales y cualesquiera otras disposiciones aplicables o exigibles de la Directiva 2014/53/EU.

Ελληνική [Greek]

IEI Integration Corp ΔΗΛΩΝΕΙ ΟΤΙ ΕΞΟΠΛΙΣΜΟΣ ΣΥΜΜΟΡΦΩΝΕΤΑΙ ΠΡΟΣ ΤΙΣ ΟΥΣΙΩΔΕΙΣ ΑΠΑΙΤΗΣΕΙΣ ΚΑΙ ΤΙΣ ΛΟΙΠΕΣ ΣΧΕΤΙΚΕΣ ΔΙΑΤΑΞΕΙΣ ΤΗΣ ΟΔΗΓΙΑΣ 2014/53/EU

Français [French]

IEI Integration Corp déclare que l'appareil est conforme aux exigences essentielles et aux autres dispositions pertinentes de la directive 2014/53/EU.

Italiano [Italian]

IEI Integration Corp dichiara che questo apparecchio è conforme ai requisiti essenziali ed alle altre disposizioni pertinenti stabilite dalla direttiva 2014/53/EU.

Latviski [Latvian]

IEI Integration Corp deklarē, ka iekārta atbilst būtiskajām prasībām un citiem ar to saistītajiem noteikumiem Direktīvas 2014/53/EU.

Lietuvių [Lithuanian]

IEI Integration Corp deklaruoja, kad šis įranga atitinka esminius reikalavimus ir kitas 2014/53/EU Direktyvos nuostatas.

Nederlands [Dutch]

IEI Integration Corp dat het toestel toestel in overeenstemming is met de essentiële eisen en de andere relevante bepalingen van richtlijn 2014/53/EU.

Malti [Maltese]

IEI Integration Corp jiddikjara li dan prodott jikkonforma mal-ħtiġijiet essenzjali u ma provvedimenti oħrajn relevanti li hemm fid-Dirrettiva 2014/53/EU.

Magyar [Hungarian]

IEI Integration Corp nyilatkozom, hogy a berendezés megfelel a vonatkozó alapvető követelményeknek és az 2014/53/EU irányelv egyéb előírásainak.

Polski [Polish]

IEI Integration Corp oświadcza, że wyrobu jest zgodny z zasadniczymi wymogami oraz pozostałym stosownymi postanowieniami Dyrektywy 2014/53/EU.

Português [Portuguese]

IEI Integration Corp declara que este equipamento está conforme com os requisitos essenciais e outras disposições da Directiva 2014/53/EU.

FLEX-BX100-ULT5

Româna [Romanian]

IEI Integration Corp declară că acest echipament este în conformitate cu cerințele esențiale și cu celelalte prevederi relevante ale Directivei 2014/53/EU.

Slovensko [Slovenian]

IEI Integration Corp izjavlja, da je ta opreme v skladu z bistvenimi zahtevami in ostalimi relevantnimi določili direktive 2014/53/EU.

Slovensky [Slovak]

IEI Integration Corp týmto vyhlasuje, že zariadenia spĺňa základné požiadavky a všetky príslušné ustanovenia Smernice 2014/53/EU.

Suomi [Finnish]

IEI Integration Corp vakuuttaa täten että laitteet on direktiivin 2014/53/EU oleellisten vaatimusten ja sitä koskevien direktiivin muiden ehtojen mukainen.

Svenska [Swedish]

IEI Integration Corp förklarar att denna utrustningstyp står i överensstämmelse med de väsentliga egenskapskrav och övriga relevanta bestämmelser som framgår av direktiv 2014/53/EU.

FCC WARNING

This equipment complies with Part 15 of the FCC Rules. Operation is subject to the following two conditions:

- This device may not cause harmful interference, and
- This device must accept any interference received, including interference that may cause undesired operation.

This equipment has been tested and found to comply with the limits for a Class A digital device, pursuant to part 15 of the FCC Rules. These limits are designed to provide reasonable protection against harmful interference when the equipment is operated in a commercial environment. This equipment generates, uses, and can radiate radio frequency energy and, if not installed and used in accordance with the instruction manual, may cause harmful interference to radio communications. Operation of this equipment in a residential area is likely to cause harmful interference in which case the user will be required to correct the interference at his own expense.

Any changes or modifications not expressly approved by the party responsible for compliance could void the user's authority to operate the equipment.

This equipment complies with FCC radiation exposure limits set forth for an uncontrolled environment. This equipment should be installed and operated with a minimum distance of 20cm between the radiator & your body.

Appendix

B

Safety Precautions

**WARNING:**

The precautions outlined in this chapter should be strictly followed. Failure to follow these precautions may result in permanent damage to the FLEX-BX100-ULT5.

B.1 Safety Precautions

Please follow the safety precautions outlined in the sections that follow:

B.1.1 General Safety Precautions

Please ensure the following safety precautions are adhered to at all times.

- ***Follow the electrostatic precautions*** outlined below whenever the device is opened.
- ***Make sure the power is turned off and the power cord is disconnected*** whenever the FLEX-BX100-ULT5 is being installed, moved or modified.
- ***To prevent the risk of electric shock, make sure power cord is unplugged from wall socket.*** To fully disengage the power to the unit, please disconnect the power cord from the power outlet. Refer servicing to qualified service personnel. The power outlet shall be readily available and accessible.
- ***Do not apply voltage levels that exceed the specified voltage range.*** Doing so may cause fire and/or an electrical shock. Use a power cord that matches the voltage of the power outlet, which has been approved and complies with the safety standard of your particular country.
- ***Electric shocks can occur*** if the FLEX-BX100-ULT5 chassis is opened when it is running. To avoid risk of electric shock, this device must only be connected to a supply mains with protective earth.
- ***Do not drop or insert any objects*** into the ventilation openings of the FLEX-BX100-ULT5.

FLEX-BX100-ULT5

- ***If considerable amounts of dust, water, or fluids enter the device***, turn off the power supply immediately, unplug the power cord, and contact the FLEX-BX100-ULT5 vendor.
- ***This equipment is not suitable for use in locations where children are likely to be present.***
- **DO NOT:**
 - Drop the device against a hard surface.
 - In a site where the ambient temperature exceeds the rated temperature

B.1.2 Anti-static Precautions



WARNING:

Failure to take ESD precautions during the installation of the FLEX-BX100-ULT5 may result in permanent damage to the FLEX-BX100-ULT5 and severe injury to the user.

Electrostatic discharge (ESD) can cause serious damage to electronic components, including the FLEX-BX100-ULT5. Dry climates are especially susceptible to ESD. It is therefore critical that whenever the FLEX-BX100-ULT5 is opened and any of the electrical components are handled, the following anti-static precautions are strictly adhered to.

- ***Wear an anti-static wristband:*** Wearing a simple anti-static wristband can help to prevent ESD from damaging any electrical component.
- ***Self-grounding:*** Before handling any electrical component, touch any grounded conducting material. During the time the electrical component is handled, frequently touch any conducting materials that are connected to the ground.
- ***Use an anti-static pad:*** When configuring or working with an electrical component, place it on an anti-static pad. This reduces the possibility of ESD damage.
- ***Only handle the edges of the electrical component:*** When handling the electrical component, hold the electrical component by its edges.

B.1.3 Product Disposal

**CAUTION:**

Risk of explosion if the battery is replaced by an incorrect type;

Replacement of a battery with an incorrect type that can defeat a safeguard (for example, in the case of some lithium battery types);

Disposal of a battery into fire or a hot oven, or mechanically crushing or cutting of a battery, that can result in an explosion;

Leaving a battery in an extremely high temperature surrounding environment that can result in an explosion or the leakage of flammable liquid or gas;

A battery subjected to extremely low air pressure that may result in an explosion or the leakage of flammable liquid or gas.

Dispose of used batteries according to instructions and local regulations.

- Outside the European Union—If you wish to dispose of used electrical and electronic products outside the European Union, please contact your local authority so as to comply with the correct disposal method.
- Within the European Union—The device that produces less waste and is easier to recycle is classified as electronic device in terms of the European Directive 2012/19/EU (WEEE), and must not be disposed of as domestic garbage.

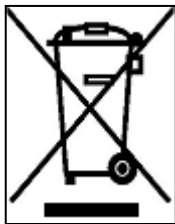

EU-wide legislation, as implemented in each Member State, requires that waste electrical and electronic products carrying the mark (left) must be disposed of separately from normal household waste. This includes monitors and electrical accessories, such as signal cables or power cords. When you need to dispose of your display products, please follow

the guidance of your local authority, or ask the shop where you purchased the product. The mark on electrical and electronic products only applies to the current European Union Member States.

Please follow the national guidelines for electrical and electronic product disposal.

FLEX-BX100-ULT5

B.2 Maintenance and Cleaning Precautions

When maintaining or cleaning the FLEX-BX100-ULT5, please follow the guidelines below.



WARNING:

- For safety reasons, turn-off the power and unplug the box PC before cleaning.
 - If you dropped any material or liquid such as water onto the box PC when cleaning, unplug the power cable immediately and contact your dealer or the nearest service center. Always make sure your hands are dry when unplugging the power cable.
-

B.2.1 Maintenance and Cleaning

Prior to cleaning any part or component of the FLEX-BX100-ULT5, please read the details below.

- Never spray or squirt liquids directly onto any other components. To clean the box PC, gently wipe it with a piece of soft dry cloth or a slightly moistened cloth.
- The interior of the device does not require cleaning. Keep fluids away from the device interior.
- Be cautious of all small removable components when vacuuming the device.
- Never drop any objects or liquids through the openings of the device.
- Be cautious of any possible allergic reactions to solvents or chemicals used when cleaning the device.
- Avoid eating, drinking and smoking within vicinity of the device.

B.2.2 Cleaning Tools

Some components in the FLEX-BX100-ULT5 may only be cleaned using a product specifically designed for the purpose. In such case, the product will be explicitly mentioned in the cleaning tips. Below is a list of items to use when cleaning the FLEX-BX100-ULT5.

- **Cloth**— Although paper towels or tissues can be used, a soft, clean piece of cloth is recommended when cleaning the device.

- **Water or rubbing alcohol**—A cloth moistened with water or rubbing alcohol can be used to clean the device.
- **Using solvents**—The use of solvents is not recommended when cleaning the device as they may damage the plastic parts.
- **Vacuum cleaner**—Using a vacuum specifically designed for computers is one of the best methods of cleaning the device. Dust and dirt can restrict the airflow in the device and cause its circuitry to corrode.
- **Cotton swabs**—Cotton swabs moistened with rubbing alcohol or water are excellent tools for wiping hard to reach areas.
- **Foam swabs**—Whenever possible, it is best to use lint free swabs such as foam swabs for cleaning.

Appendix

C

BIOS Menu Options

C.1 BIOS Configuration Options

Below is a list of BIOS configuration options described in **Chapter 4**.

<input type="checkbox"/>	System Date [xx/xx/xx]	37
<input type="checkbox"/>	System Time [xx:xx:xx]	37
<input type="checkbox"/>	Intel® (VMX) Virtualization Technology [Disabled]	38
<input type="checkbox"/>	Active Processor Cores [All]	39
<input type="checkbox"/>	Hyper-threading [Enabled].....	39
<input type="checkbox"/>	Intel® SpeedStep™ [Enabled]	39
<input type="checkbox"/>	C State [Disabled]	39
<input type="checkbox"/>	AMT BIOS Features [Enabled].....	40
<input type="checkbox"/>	Unconfigure ME [Disabled]	40
<input type="checkbox"/>	TPM Device Selection [dTPM (If supported)]	41
<input type="checkbox"/>	Security Device Support [Disable].....	42
<input type="checkbox"/>	ACPI Sleep State [S3 (Suspend to RAM)].....	43
<input type="checkbox"/>	Wake system with Fixed Time [Disabled].....	44
<input type="checkbox"/>	PC Health Status	45
<input type="checkbox"/>	Serial Port [Enabled].....	47
<input type="checkbox"/>	Device Mode [RS232].....	47
<input type="checkbox"/>	Serial Port [Enabled].....	48
<input type="checkbox"/>	Console Redirection [Disabled]	49
<input type="checkbox"/>	Legacy Serial Redirection Port [COM1].....	49
<input type="checkbox"/>	Terminal Type [ANSI].....	50
<input type="checkbox"/>	Bits per second [115200].....	51
<input type="checkbox"/>	Data Bits [8]	51
<input type="checkbox"/>	Parity [None].....	51
<input type="checkbox"/>	Stop Bits [1]	52
<input type="checkbox"/>	USB Devices	52
<input type="checkbox"/>	Legacy USB Support [Enabled].....	53
<input type="checkbox"/>	CSM Support [Enabled].....	54
<input type="checkbox"/>	Auto Recovery Function [Disabled].....	55
<input type="checkbox"/>	VT-d [Disabled].....	57
<input type="checkbox"/>	DVMT Pre-Allocated [32M]	58
<input type="checkbox"/>	DVMT Total Gfx Mem [MAX].....	58

FLEX-BX100-ULT5

<input type="checkbox"/>	Primary IGFX Boot Display [VBIOS Default]	59
<input type="checkbox"/>	Backlight Control [LED]	59
<input type="checkbox"/>	Restore AC Power Loss [Last State]	60
<input type="checkbox"/>	Power Saving Function(ERP) [Disabled].....	60
<input type="checkbox"/>	HD Audio [Enabled]	60
<input type="checkbox"/>	USB Power SW [+5V DUAL].....	60
<input type="checkbox"/>	M2_A1 / M2_M2 [Enabled].....	61
<input type="checkbox"/>	PCIe Speed [Auto].....	61
<input type="checkbox"/>	Detect Non-Compliance Device [Disabled]	62
<input type="checkbox"/>	STAT Controller(s) [Enabled].....	62
<input type="checkbox"/>	SATA Mode Selection [AHCI].....	63
<input type="checkbox"/>	PCIe Storage Dev On Port M2_M2 [Not RST Controlled].....	63
<input type="checkbox"/>	Administrator Password	64
<input type="checkbox"/>	User Password	64
<input type="checkbox"/>	Bootup NumLock State [On].....	65
<input type="checkbox"/>	Quiet Boot [Enabled]	66
<input type="checkbox"/>	Launch PXE OpROM [Disabled]	66
<input type="checkbox"/>	Option ROM Messages [Force BIOS].....	66
<input type="checkbox"/>	UEFI Boot [Disabled]	66
<input type="checkbox"/>	Boot Option Priority.....	66
<input type="checkbox"/>	Save Changes and Reset	67
<input type="checkbox"/>	Discard Changes and Reset	67
<input type="checkbox"/>	Restore Defaults	67
<input type="checkbox"/>	Save as User Defaults	67
<input type="checkbox"/>	Restore User Defaults	67

Appendix

D

Watchdog Timer

**NOTE:**

The following discussion applies to DOS environment. IEI support is contacted or the IEI website visited for specific drivers for more sophisticated operating systems, e.g., Windows and Linux.

The Watchdog Timer is provided to ensure that standalone systems can always recover from catastrophic conditions that cause the CPU to crash. This condition may have occurred by external EMI or a software bug. When the CPU stops working correctly, Watchdog Timer either performs a hardware reset (cold boot) or a Non-Maskable Interrupt (NMI) to bring the system back to a known state.

A BIOS function call (INT 15H) is used to control the Watchdog Timer:

INT 15H:

AH – 6FH Sub-function:	
AL – 2:	Sets the Watchdog Timer's period.
BL:	Time-out value (Its unit-second is dependent on the item "Watchdog Timer unit select" in CMOS setup).

Table D-1: AH-6FH Sub-function

Call sub-function 2 to set the time-out period of Watchdog Timer first. If the time-out value is not zero, the Watchdog Timer starts counting down. While the timer value reaches zero, the system resets. To ensure that this reset condition does not occur, calling sub-function 2 must periodically refresh the Watchdog Timer. However, the Watchdog timer is disabled if the time-out value is set to zero.

A tolerance of at least 10% must be maintained to avoid unknown routines within the operating system (DOS), such as disk I/O that can be very time-consuming.

**NOTE:**

When exiting a program it is necessary to disable the Watchdog Timer, otherwise the system resets.

Example program:

```
; INITIAL TIMER PERIOD COUNTER
;
W_LOOP:

    MOV     AX, 6F02H      ;setting the time-out value
    MOV     BL, 30        ;time-out value is 48 seconds
    INT     15H

;
; ADD THE APPLICATION PROGRAM HERE
;

    CMP     EXIT_AP, 1    ;is the application over?
    JNE     W_LOOP       ;No, restart the application

    MOV     AX, 6F02H    ;disable Watchdog Timer
    MOV     BL, 0        ;
    INT     15H

;
; EXIT ;
```

Appendix

E

Error Beep Code

E.1 PEI Beep Codes

Number of Beeps	Description
1	Memory not Installed
1	Memory was installed twice (InstallPeiMemory routine in PEI Core called twice)
2	Recovery started
3	DXE IPL was not found
3	DXE Core Firmware Volume was not found
4	Recovery failed
4	S3 Resume failed
7	Reset PPI is not available

E.2 DXE Beep Codes

Number of Beeps	Description
1	Invalid password
4	Some of the Architectural Protocols are not available
5	No Console Output Devices are found
5	No Console Input Devices are found
6	Flash update is failed
7	Reset protocol is not available
8	Platform PCI resource requirements cannot be met



NOTE:

If you have any question, please contact IEI for further assistance.

Appendix

F

Hazardous Materials Disclosure

F.1 RoHS II Directive (2015/863/EU)

The details provided in this appendix are to ensure that the product is compliant with the RoHS II Directive (2015/863/EU). The table below acknowledges the presences of small quantities of certain substances in the product, and is applicable to RoHS II Directive (2015/863/EU).

Please refer to the following table.

Part Name	Toxic or Hazardous Substances and Elements									
	Lead (Pb)	Mercury (Hg)	Cadmium (Cd)	Hexavalent Chromium (CR(VI))	Polybrominated Biphenyls (PBB)	Polybrominated Diphenyl Ethers (PBDE)	Bis(2-ethylhexyl) phthalate (DEHP)	Butyl benzyl phthalate (BBP)	Dibutyl phthalate (DBP)	Diisobutyl phthalate (DIBP)
Housing	O	O	O	O	O	O	O	O	O	O
Printed Circuit Board	O	O	O	O	O	O	O	O	O	O
Metal Fasteners	O	O	O	O	O	O	O	O	O	O
Cable Assembly	O	O	O	O	O	O	O	O	O	O
Fan Assembly	O	O	O	O	O	O	O	O	O	O
Power Supply Assemblies	O	O	O	O	O	O	O	O	O	O
Battery	O	O	O	O	O	O	O	O	O	O
<p>O: This toxic or hazardous substance is contained in all of the homogeneous materials for the part is below the limit requirement in Directive (EU) 2015/863.</p> <p>X: This toxic or hazardous substance is contained in at least one of the homogeneous materials for this part is above the limit requirement in Directive (EU) 2015/863.</p>										

FLEX-BX100-ULT5

F.2 China RoHS

此附件旨在确保本产品符合中国 RoHS 标准。以下表格标示此产品中某有毒物质的含量符合中国 RoHS 标准规定的限量要求。

本产品上会附有“环境友好使用期限”的标签，此期限是估算这些物质“不会有泄漏或突变”的年限。本产品可能包含有较短的环境友好使用期限的可替换元件，像是电池或灯管，这些元件将会单独标示出来。

部件名称	有毒有害物质或元素					
	铅 (Pb)	汞 (Hg)	镉 (Cd)	六价铬 (CR(VI))	多溴联苯 (PBB)	多溴二苯醚 (PBDE)
壳体	○	○	○	○	○	○
印刷电路板	○	○	○	○	○	○
金属螺帽	○	○	○	○	○	○
电缆组装	○	○	○	○	○	○
风扇组装	○	○	○	○	○	○
电力供应组装	○	○	○	○	○	○
电池	○	○	○	○	○	○

○: 表示该有毒有害物质在该部件所有物质材料中的含量均在 SJ/T11364-2014 與 GB/T26572-2011 标准规定的限量要求以下。

X: 表示该有毒有害物质至少在该部件的某一均质材料中的含量超出 SJ/T11364-2014 與 GB/T26572-2011 标准规定的限量要求。