

## FPK-03

A set of Panel Mounting Kit is composed of a clamp and screw

### Features

Panel Mounting Kit

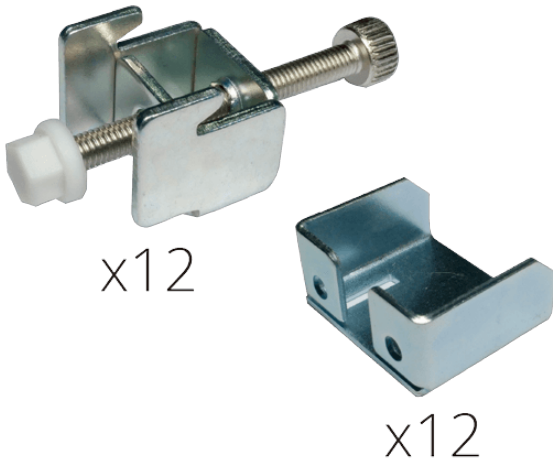

### Specifications

|              |                              |
|--------------|------------------------------|
| Dimensions   |                              |
| Dimensions   | 222 x 432 x 252 mm           |
| Material     |                              |
| Material     | SPCC                         |
| Weight       |                              |
| Weight       | 3.12 Kg                      |
| Key Features |                              |
| Key Features | 12 mounting kits for DM-F24A |

### Ordering Information

|            |  |
|------------|--|
| FPK-03-R10 | DM-F24A panel mount kit, silver color, R10 |
|------------|--|