

MODEL:
IMBA-C2360-i2

ATX Motherboard Supports 6th Generation LGA1151 Intel® Xeon® E3-1200 v5 Series, Core™ i3, Pentium® or Celeron® CPU, Intel® C236 Chipset, DDR4, HDMI 2.0, DVI-D, VGA, Dual Intel® PCIe GbE, SATA 6Gb/s, USB 3.0, HD Audio, IPMI 2.0 and RoHS

User Manual

Revision

Date	Version	Changes
October 24, 2016	1.01	Modified the display output spec of the DVI-D, HDMI and iDP connectors (page 7)
July 21, 2016	1.00	Initial release

Copyright

COPYRIGHT NOTICE

The information in this document is subject to change without prior notice in order to improve reliability, design and function and does not represent a commitment on the part of the manufacturer.

In no event will the manufacturer be liable for direct, indirect, special, incidental, or consequential damages arising out of the use or inability to use the product or documentation, even if advised of the possibility of such damages.

This document contains proprietary information protected by copyright. All rights are reserved. No part of this manual may be reproduced by any mechanical, electronic, or other means in any form without prior written permission of the manufacturer.

TRADEMARKS

All registered trademarks and product names mentioned herein are used for identification purposes only and may be trademarks and/or registered trademarks of their respective owners.

Manual Conventions



WARNING

Warnings appear where overlooked details may cause damage to the equipment or result in personal injury. Warnings should be taken seriously.



CAUTION

Cautionary messages should be heeded to help reduce the chance of losing data or damaging the product.



NOTE

These messages inform the reader of essential but non-critical information. These messages should be read carefully as any directions or instructions contained therein can help avoid making mistakes.



HOT SURFACE

This symbol indicates a hot surface that should not be touched without taking care.

Table of Contents

1 INTRODUCTION.....	1
1.1 INTRODUCTION.....	2
1.2 FEATURES.....	3
1.3 CONNECTORS	4
1.4 DIMENSIONS.....	5
1.5 DATA FLOW	6
1.6 TECHNICAL SPECIFICATIONS	7
2 PACKING LIST.....	10
2.1 ANTI-STATIC PRECAUTIONS	11
2.2 UNPACKING PRECAUTIONS.....	11
2.3 PACKING LIST.....	12
2.4 OPTIONAL ITEMS	13
3 CONNECTORS	16
3.1 PERIPHERAL INTERFACE CONNECTORS.....	17
3.1.1 IMBA-C2360-i2 Layout	17
3.1.2 Peripheral Interface Connectors	18
3.1.3 External Interface Panel Connectors.....	19
3.2 INTERNAL PERIPHERAL CONNECTORS	20
3.2.1 +12V ATX Power Connector	20
3.2.2 Additional Power Connector	21
3.2.3 ATX Power Connector	21
3.2.4 Battery Connector.....	23
3.2.5 Chassis Intrusion Connector.....	24
3.2.6 DDR4 DIMM Slots.....	25
3.2.7 Digital I/O Connector.....	26
3.2.8 EC Debug Connector.....	27
3.2.9 Fan Connector (CPU).....	28
3.2.10 Fan Connectors (System).....	29

3.2.11 Front Panel Audio Connector	30
3.2.12 Front Panel Connector	31
3.2.13 I ² C Connector	32
3.2.14 Internal DisplayPort Connector	33
3.2.15 iRIS Module Slot	34
3.2.16 Keyboard and Mouse Connector	35
3.2.17 LAN LED Connectors	36
3.2.18 Parallel Port Connector	37
3.2.19 PCI Slots	38
3.2.20 PCIe x4 Slots.....	38
3.2.21 PCIe x8 Slots.....	39
3.2.22 PCIe Mini Slot.....	40
3.2.23 Power Button	41
3.2.24 SATA 6Gb/s Drive Connector	42
3.2.25 Serial Port Connectors, RS-232.....	43
3.2.26 Serial Port Connectors, RS-232/422/485	44
3.2.27 SMBus Connector	46
3.2.28 SPI Flash Connector.....	47
3.2.29 SPI Flash Connector, EC	48
3.2.30 TPM Connector.....	49
3.2.31 USB 2.0 Connectors.....	50
3.2.32 USB 3.0 Connector	51
3.3 EXTERNAL PERIPHERAL INTERFACE CONNECTOR PANEL	52
3.3.1 Audio Connector	52
3.3.2 Ethernet and USB 3.0 Connectors	53
3.3.3 HDMI Connector	54
3.3.4 Keyboard/Mouse and USB 2.0 Connectors	55
3.3.5 VGA and DVI-D Connectors.....	56
4 INSTALLATION	58
4.1 ANTI-STATIC PRECAUTIONS	59
4.2 INSTALLATION CONSIDERATIONS.....	59
4.3 SOCKET LGA1151 CPU INSTALLATION	61
4.4 SOCKET LGA1151 COOLING KIT INSTALLATION	64
4.5 DIMM INSTALLATION	66

IMBA-C2360-i2 ATX Motherboard

4.6 IRIS MODULE INSTALLATION	67
4.7 FULL-SIZE PCIe MINI CARD INSTALLATION	68
4.8 HALF-SIZE PCIe MINI CARD INSTALLATION.....	70
4.9 USB 3.0 EXPANSION CARD INSTALLATION.....	71
4.10 PCIe MINI AND mSATA EXPANSION CARD INSTALLATION.....	72
4.11 SYSTEM CONFIGURATION	74
4.11.1 AT/ATX Power Mode Setting.....	74
4.11.2 Clearing CMOS.....	75
4.11.3 Switching BIOS	76
4.11.4 Flexible I/O Configuration.....	77
4.11.5 Flash Descriptor Security Override Jumper.....	78
4.11.6 mSATA Setup	79
4.11.7 USB Power Selection	80
4.12 INTERNAL PERIPHERAL DEVICE CONNECTIONS.....	80
4.12.1 SATA Drive Connection	80
4.13 ADDING USB 3.0 DRIVERS TO A WINDOWS 7 INSTALLATION IMAGE	82
4.14 INTEL® AMT SETUP PROCEDURE	84
4.15 IPMI SETUP PROCEDURE	85
4.15.1 Managed System Hardware Setup	85
4.15.2 Using the IEI iMAN Web GUI.....	85
5 BIOS.....	88
5.1 INTRODUCTION.....	89
5.1.1 Starting Setup.....	89
5.1.2 Using Setup	89
5.1.3 Getting Help.....	90
5.1.4 Unable to Reboot after Configuration Changes	90
5.1.5 BIOS Menu Bar.....	91
5.2 MAIN.....	91
5.3 ADVANCED.....	93
5.3.1 Trusted Computing.....	94
5.3.2 ACPI Settings	95
5.3.3 AMT Configuration	96
5.3.4 Super IO Configuration	97
5.3.4.1 Serial Port n Configuration	98

5.3.4.2 Serial Port 1 Configuration	98
5.3.4.3 Serial Port 2 Configuration	99
5.3.4.4 Serial Port 3 Configuration	100
5.3.4.5 Parallel Port Configuration	104
5.3.5 <i>iWDD H/W Monitor</i>	106
5.3.5.1 Smart Fan Mode Configuration	107
5.3.6 <i>RTC Wake Settings</i>	108
5.3.7 <i>Serial Port Console Redirection</i>	110
5.3.7.1 Legacy Console Redirection Settings	113
5.3.8 <i>CPU Configuration</i>	114
5.3.9 <i>SATA Configuration</i>	116
5.3.10 <i>NVMe Configuration</i>	117
5.3.11 <i>USB Configuration</i>	118
5.3.12 <i>iEi Feature</i>	119
5.4 CHIPSET	120
5.4.1 <i>System Agent (SA) Configuration</i>	121
5.4.1.1 Graphics Configuration.....	122
5.4.1.2 PEG Port Configuration.....	123
5.4.1.3 Memory Configuration	124
5.4.2 <i>PCH-IO Configuration</i>	125
5.4.2.1 PCI Express Configuration	126
5.4.2.2 HD Audio Configuration.....	130
5.5 SECURITY	131
5.6 BOOT.....	132
5.7 SAVE & EXIT	134
5.8 SERVER MGMT	135
5.8.1 <i>System Event Log</i>	135
5.8.2 <i>BMC Network Configuration</i>	137
6 SOFTWARE DRIVERS	139
6.1 AVAILABLE SOFTWARE DRIVERS	140
6.2 SOFTWARE INSTALLATION	140
A REGULATORY COMPLIANCE	142
B PRODUCT DISPOSAL	144

IMBA-C2360-i2 ATX Motherboard

C BIOS OPTIONS	146
D TERMINOLOGY	150
E DIGITAL I/O INTERFACE	154
E.1 INTRODUCTION	155
E.2 ASSEMBLY LANGUAGE SAMPLE 1	156
E.3 ASSEMBLY LANGUAGE SAMPLE 2	156
F WATCHDOG TIMER	157
G INTEL® MATRIX STORAGE MANAGER	160
G.1 INTRODUCTION	161
<i>G.1.1 Precautions</i>	161
G.2 FEATURES AND BENEFITS	162
G.3 ACCESSING THE INTEL® MATRIX STORAGE MANAGER	162
G.4 INSTALLING THE OPERATING SYSTEM TO THE RAID ARRAY	163
H HAZARDOUS MATERIALS DISCLOSURE	164

List of Figures

Figure 1-1: IMBA-C2360-i2	2
Figure 1-2: Connectors	4
Figure 1-3: IMBA-C2360-i2 Dimensions (mm).....	5
Figure 1-4: Data Flow Diagram.....	6
Figure 3-1: Peripheral Interface Connectors	17
Figure 3-2: +12V ATX Power Connector Pinout Location	20
Figure 3-3: Additional Power Connector Location.....	21
Figure 3-4: ATX Power Connector Location	22
Figure 3-5: Battery Connector Location.....	23
Figure 3-6: Chassis Intrusion Connector Location.....	24
Figure 3-7: DDR4 DIMM Slot Locations	25
Figure 3-8: Digital I/O Connector Location	26
Figure 3-9: EC Debug Connector Location	27
Figure 3-10: CPU Fan Connector Location	28
Figure 3-11: System Fan Connector Locations.....	29
Figure 3-12: Front Panel Audio Connector Location	30
Figure 3-13: Front Panel Connector Location	31
Figure 3-14: I ² C Connector Location	32
Figure 3-15: Internal DisplayPort Connector Location	33
Figure 3-16: iRIS Module Slot Location.....	34
Figure 3-17: Keyboard and Mouse Connector Location.....	35
Figure 3-18: LAN LED Connector Locations	36
Figure 3-19: Parallel Port Connector Location	37
Figure 3-20: PCI Slot Locations	38
Figure 3-21: PCIe x4 Slot Locations	39
Figure 3-22: PCIe x8 Slot Locations	39
Figure 3-23: PCIe Mini Slot Location	40
Figure 3-24: Power Button Location.....	42
Figure 3-25: SATA 6Gb/s Drive Connector Locations	43
Figure 3-26: RS-232 Serial Port Connector Location.....	44

IMBA-C2360-i2 ATX Motherboard

Figure 3-27: RS-232/422/485 Connector Location	45
Figure 3-28: SMBus Connector Location	46
Figure 3-29: SPI Flash Connector Location	47
Figure 3-30: SPI EC Flash Connector Location	48
Figure 3-31: TPM Connector Location.....	49
Figure 3-32: USB 2.0 Connector Pinout Locations	50
Figure 3-33: USB 3.0 Connector Location	51
Figure 3-34: External Peripheral Interface Connector	52
Figure 3-35: Audio Connector	53
Figure 3-36: VGA Connector	57
Figure 4-1: Disengage the CPU Socket Load Lever.....	61
Figure 4-2: Remove Protective Cover.....	62
Figure 4-3: Insert the Socket LGA1151 CPU.....	63
Figure 4-4: Close the Socket LGA1151	63
Figure 4-5: Cooling Kit Support Bracket.....	65
Figure 4-6: DIMM Installation.....	66
Figure 4-7: iRIS Module Installation.....	67
Figure 4-8: Removing the Retention Screw	68
Figure 4-9: Inserting the Full-size PCIe Mini Card into the Slot at an Angle	69
Figure 4-10: Securing the Full-size PCIe Mini Card	69
Figure 4-11: Installing the Standoff	70
Figure 4-12: Inserting the Half-size PCIe Mini Card into the Slot at an Angle.....	71
Figure 4-13: Securing the Half-size PCIe Mini Card	71
Figure 4-14: PCIEX4_2 Slot and USB Header Locations	72
Figure 4-15: PCIEX4_3 Slot Location.....	73
Figure 4-16: AT/ATX Power Mode Switch Location	74
Figure 4-17: Clear CMOS Button and Header Locations	75
Figure 4-18: BIOS1/BIOS2 Switch Location.....	76
Figure 4-19: Flash Descriptor Security Override Jumper Location	78
Figure 4-20: mSATA Setup Jumper Location	79
Figure 4-21: SATA Drive Cable Connection.....	81
Figure 4-22: SATA Power Drive Connection.....	82
Figure 4-23: Windows 7 USB 3.0 Creator Utility.....	83
Figure 4-24: Update Process is Complete	84
Figure 4-25: IEI iMAN Web Address.....	86

Figure 4-26: IEI iMAN Web GUI.....87
Figure 6-1: Introduction Screen 141
Figure 6-2: Available Drivers 141

List of Tables

Table 1-1: IMBA-C2360-i2 Specifications	9
Table 2-1: Packing List.....	13
Table 2-2: Optional Items	15
Table 3-1: Peripheral Interface Connectors	19
Table 3-2: Rear Panel Connectors	20
Table 3-3: +12V ATX Power Connector Pinouts	20
Table 3-4: Additional Power Connector Pinouts	21
Table 3-5: ATX Power Connector Pinouts	22
Table 3-6: Chassis Intrusion Connector Pinouts	24
Table 3-7: Digital I/O Connector Pinouts.....	26
Table 3-8: EC Debug Connector Pinouts	27
Table 3-9: CPU Fan Connector Pinouts.....	28
Table 3-10: System Fan (SYS_FAN1) Connector Pinouts	29
Table 3-11: System Fan (SYS_FAN2) Connector Pinouts	29
Table 3-12: Front Panel Audio Connector Pinouts	30
Table 3-13: Front Panel Connector Pinouts.....	31
Table 3-14: I ² C Connector Pinouts.....	32
Table 3-15: Internal DisplayPort Connector Pinouts	33
Table 3-16: Keyboard and Mouse Connector Pinouts	35
Table 3-17: LAN1 LED Connector (LED_LAN1) Pinouts.....	36
Table 3-18: LAN2 LED Connector (LED_LAN2) Pinouts.....	36
Table 3-19: Parallel Port Connector Pinouts	38
Table 3-20: PCIe Mini Slot Pinouts.....	41
Table 3-21: SATA 6Gb/s Drive Connector Pinouts.....	43
Table 3-22: RS-232 Serial Port Connector Pinouts	44
Table 3-23: RS-232/422/485 Connector Pinouts	45
Table 3-24: DB-9 RS-232/422/485 Pinouts	45
Table 3-25: SMBus Connector Pinouts	46
Table 3-26: SPI Flash Connector Pinouts	47
Table 3-27: SPI EC Flash Connector Pinouts	48

Table 3-28: TPM Connector Pinouts	49
Table 3-29: USB 2.0 Connector Pinouts	50
Table 3-30: USB 3.0 Connector Pinouts	51
Table 3-31: USB 3.0 Port Pinouts	53
Table 3-32: LAN Pinouts	54
Table 3-33: HDMI Connector Pinouts	54
Table 3-34: USB 2.0 Port Pinouts	55
Table 3-35: PS/2 Connector Pinouts	55
Table 3-36: DVI-D Connector Pinouts	56
Table 3-37: VGA Connector Pinouts	57
Table 4-1: AT/ATX Power Mode Switch Settings	74
Table 4-2: BIOS1/BIOS2 Switch Settings	76
Table 4-3: Flexible I/O Configuration	77
Table 4-4: Flash Descriptor Security Override Jumper Settings	78
Table 4-5: mSATA Setup Jumper Settings	79
Table 4-6: BIOS Options and Configured USB Ports	80
Table 4-7: USB Power Source Setup	80
Table 5-1: BIOS Navigation Keys	90
Table 5-2: BIOS Options and Configured USB Ports	126
Table 5-3: BIOS Options with Correspondent I/O Configuration	126

BIOS Menus

BIOS Menu 1: Main	92
BIOS Menu 2: Advanced	93
BIOS Menu 3: Trusted Computing	94
BIOS Menu 4: ACPI Configuration	95
BIOS Menu 5: AMT Configuration	96
BIOS Menu 6: Super IO Configuration	97
BIOS Menu 7: Serial Port n Configuration Menu	98
BIOS Menu 8: Parallel Port Configuration Menu	104
BIOS Menu 9: iWDD H/W Monitor	106
BIOS Menu 10: Smart Fan Mode Configuration	107
BIOS Menu 11: RTC Wake Settings	108
BIOS Menu 12: Serial Port Console Redirection	110
BIOS Menu 13: Legacy Console Redirection Settings	113
BIOS Menu 14: CPU Configuration	114
BIOS Menu 15: SATA Configuration	116
BIOS Menu 16: NVMe Configuration	117
BIOS Menu 17: USB Configuration	118
BIOS Menu 18: iEi Feature	119
BIOS Menu 19: Chipset	120
BIOS Menu 20: System Agent (SA) Configuration	121
BIOS Menu 21: Graphics Configuration	122
BIOS Menu 22: PEG Port Configuration	123
BIOS Menu 23: Memory Configuration	124
BIOS Menu 24: PCH-IO Configuration	125
BIOS Menu 25: PCI Express Configuration (For BIOS1)	127
BIOS Menu 26: PCI Express Configuration (For BIOS2)	128
BIOS Menu 27: PCIEX1_1 Slot and PCIEX4_1 Slot Configuration Menu	129
BIOS Menu 28: HD Audio Configuration	130
BIOS Menu 29: Security	131
BIOS Menu 30: Boot	132

BIOS Menu 31: Save & Exit.....	134
BIOS Menu 32: Server Mgmt	135
BIOS Menu 33: System Event Log	135
BIOS Menu 34: System Event Log	137

Chapter

1

Introduction

1.1 Introduction

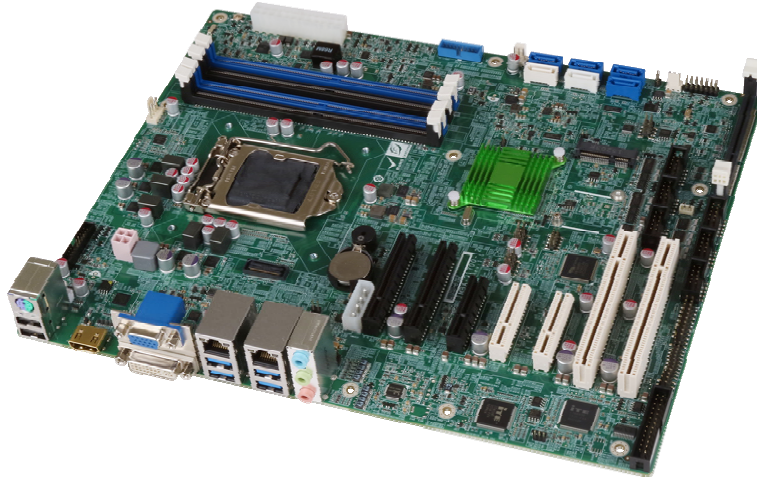

Figure 1-1: IMBA-C2360-i2

The IMBA-C2360-i2 is an ATX motherboard. It accepts a Socket LGA1151 Intel® Xeon® E3-1200 v5 Series, Core™ i3, Pentium® or Celeron® processor and supports four 288-pin 2133 MHz dual-channel DDR4 DIMM modules up to 64 GB. The integrated Intel® C236 chipset supports six SATA 6Gb/s drives. Moreover, the IMBA-C2360-i2 includes HDMI 2.0, DVI-D and VGA interfaces for triple independent display.

The IMBA-C2360-i2 features Intelligent Platform Management Interface (IPMI) that helps lower the overall costs of server management by enabling users to maximize IT resource, save time and manage multiple systems. The IMBA-C2360-i2 supports IPMI 2.0 via the optional iRIS-2400 module.

The IMBA-C2360-i2 provides two GbE interfaces through the Intel® I219LM (with Intel® AMT 11.0 support) and the Intel® I210 PCIe controllers. Expansion and I/O include two PCI slots, two PCIe x8 slots, three PCIe x4 slots, one PCIe Mini slot with mSATA support, four USB 3.0 and two USB 2.0 on the rear panel, four USB 2.0 via internal pin headers, two USB 3.0 via internal box header and six COM ports.

IMBA-C2360-i2 ATX Motherboard

1.2 Features

Some of the IMBA-C2360-i2 motherboard features are listed below:

- ATX form factor
- 6th generation LGA1151 Intel® Xeon® E3-1200 v5 Series, Core™ i3, Pentium® or Celeron® processor supported
- Intel® C236 chipset
- Four 288-pin 2133 MHz dual-channel ECC/non-ECC unbuffered DDR4 DIMMs support up to 64 GB
- Two Intel® PCIe GbE connectors (LAN1 with Intel® AMT 11.0 support)
- Supports PCI Express Generation 3.0
- Triple independent display by HDMI 2.0, DVI-D and VGA interfaces
- Supports IPMI 2.0 via iRIS-2400 module
- Six SATA 6Gb/s connectors support RAID 0, 1, 5, 10
- Four USB 3.0 ports on the rear panel
- One PCIe Mini card slot with mSATA support
- Two PCIe x8 slots
- Three PCIe x4 slots
- Two PCI slots
- Six serial ports
- The optional expansion cards provide more choices to meet user's demand
- TPM V1.2 hardware security function supported by TPM module
- High Definition Audio
- RoHS compliant

1.3 Connectors

The connectors on the IMBA-C2360-i2 are shown in the figure below.

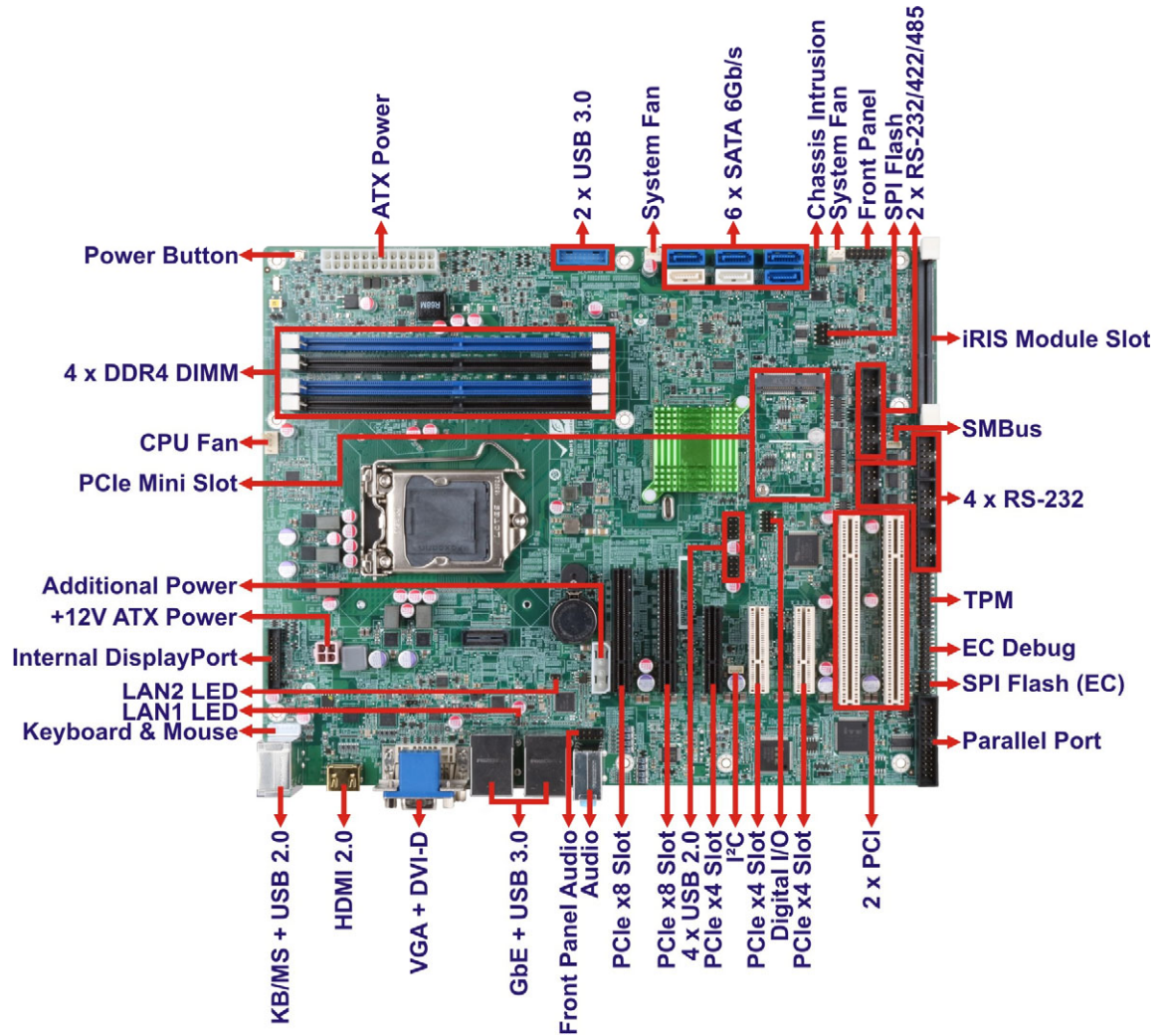

Figure 1-2: Connectors

IMBA-C2360-i2 ATX Motherboard

1.4 Dimensions

The main dimensions of the IMBA-C2360-i2 are shown in the diagram below.

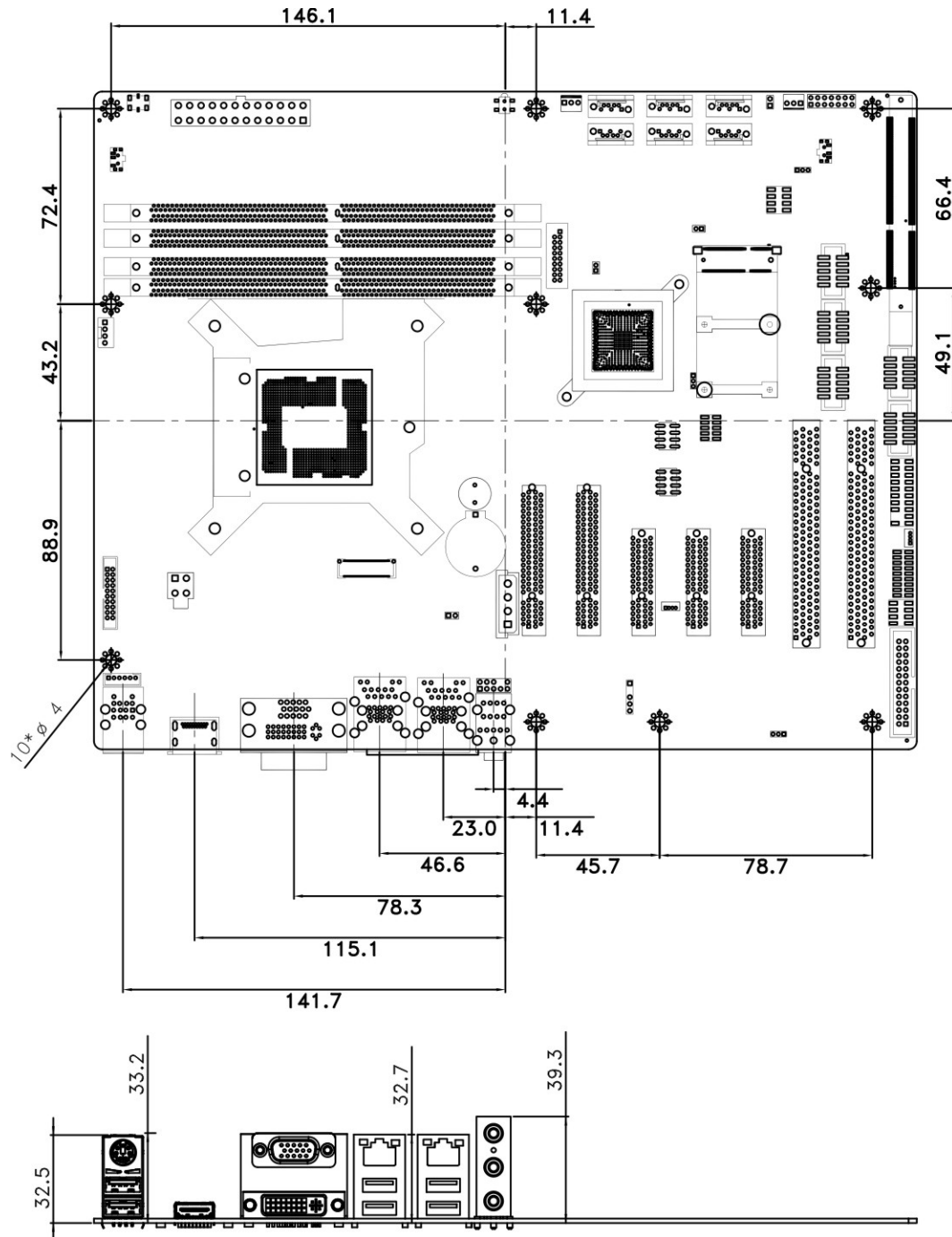

Figure 1-3: IMBA-C2360-i2 Dimensions (mm)

1.5 Data Flow

Figure 1-4 shows the data flow between the system chipset, the CPU and other components installed on the motherboard.

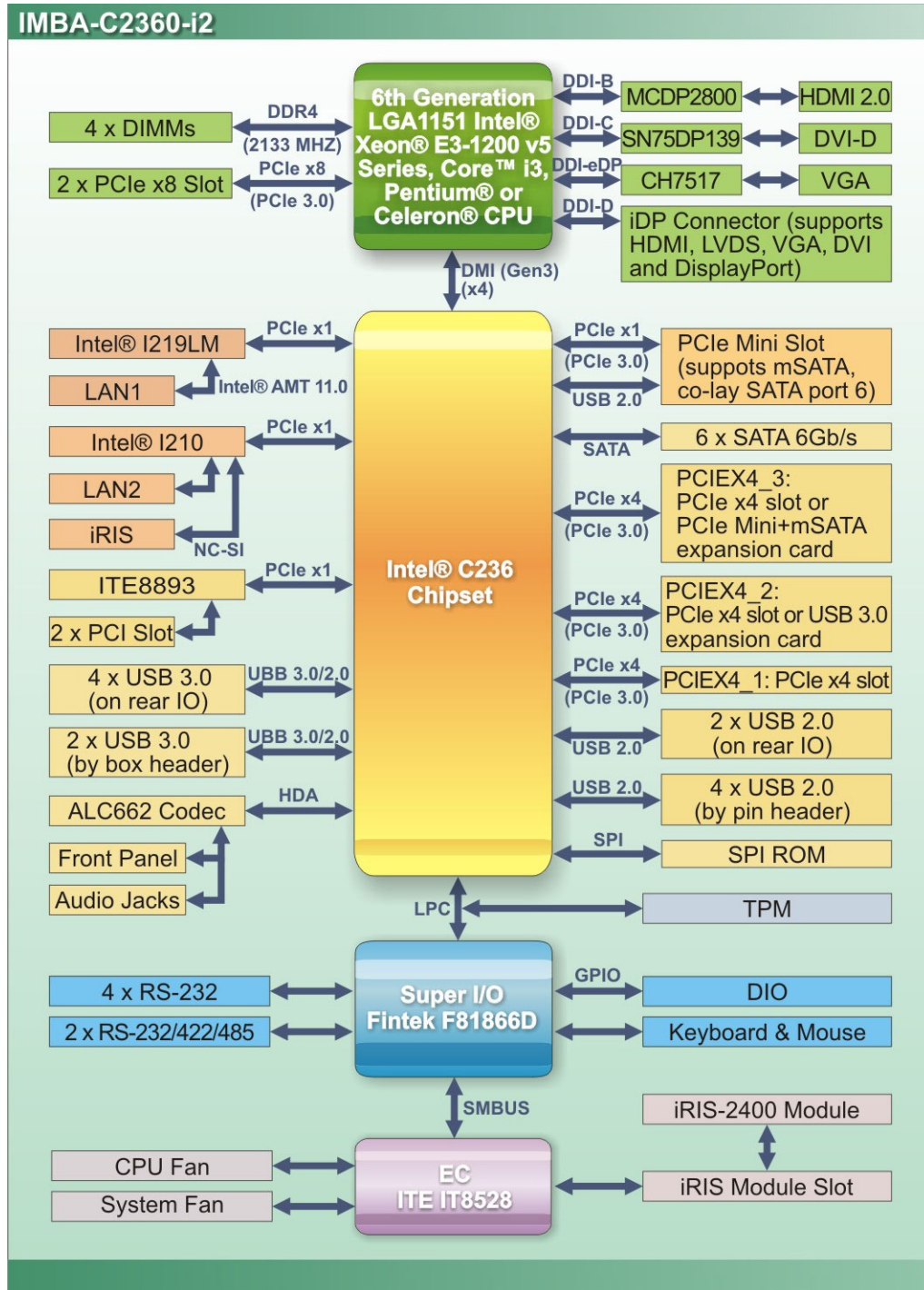

Figure 1-4: Data Flow Diagram

IMBA-C2360-i2 ATX Motherboard

1.6 Technical Specifications

The IMBA-C2360-i2 technical specifications are listed below.

Specification/Model	IMBA-C2360-i2
Form Factor	ATX
CPU Supported	6th generation LGA1151 Intel® Xeon® E3-1200 v5 Series, Core™ i3, Pentium® or Celeron® CPU
Chipset	Intel® C236
Memory	Four 288-pin 2133 MHz dual-channel ECC/non-ECC unbuffered DDR4 SDRAM DIMMs supported (system max. 64 GB)
Graphics Engine	Intel® HD Graphics Gen9 engine with 16 low-power execution units, supporting DirectX 11/12, OpenGL 4.3/4.4, OpenCL 2.x, and ES 2.0
Display Output	Triple independent display One VGA (up to 1920x1200@60 Hz) One DVI-D (up to 1920x1200@60 Hz) One HDMI 2.0 (up to 3840x2160@60 Hz) One iDP interface for HDMI, LVDS, VGA, DVI and DisplayPort (up to 1920x1200@60 Hz)
Ethernet Controllers	LAN1: Intel® I219LM PCIe GbE controller with Intel® AMT 11.0 support (LAN1_USB1) LAN2: Intel® I210 PCIe GbE controller (LAN2_USB2)
Audio	Realtek ALC662 HD Audio codec supports 5.1 channels
BIOS	UEFI BIOS
Super I/O Controller	Fintek F81866D
Watchdog Timer	Software programmable supports 1~255 sec. system reset

Expansions	<p>One full-size/half-size PCIe Mini card slot (supports mSATA, co-lay SATA port 6)</p> <p>Two PCI slots</p> <p>Two PCIe x8 slots (Gen3)</p> <p>Three PCIe x4 slots (Gen3)</p>
I/O Interface Connectors	
Audio Connectors	<p>Line-in, line-out and mic-in audio jacks on rear panel</p> <p>One internal front panel audio connector (10-pin header)</p>
Chassis Intrusion	One 2-pin header
Digital I/O	8-bit digital I/O
Ethernet	Two RJ-45 GbE ports
Fan	<p>One 4-pin CPU smart fan connector</p> <p>One 3-pin system smart fan connector (SYS_FAN1)</p> <p>One 3-pin system fan connector</p>
Front Panel	One 14-pin header (power LED, HDD LED, IPMI LED, speaker, power button, reset button)
I²C	One 4-pin wafer connector
IPMI 2.0	One iRIS-2400 module slot
Keyboard and Mouse	<p>One PS/2 keyboard/mouse connector</p> <p>One internal keyboard and mouse connector (6-pin wafer)</p>
LAN LED	Two 2-pin headers for LAN1 LED and LAN2 LED
Parallel Port	One parallel port via internal 26-pin box header
Serial ATA	Six SATA 6Gb/s connectors (support RAID 0, 1, 5, 10)
Serial Ports	<p>Four RS-232 via internal box header</p> <p>Two RS-232/422/485 via internal box header</p>
SMBus	One 4-pin wafer connector
TPM	One via 20-pin header

IMBA-C2360-i2 ATX Motherboard

USB Ports	<p>Four USB 3.0 ports on rear panel</p> <p>Two USB 2.0 ports on rear panel</p> <p>Four USB 2.0 ports via internal pin header</p> <p>Two USB 3.0 ports via internal box header</p> <p>* The Windows® 7 installation media does not include native driver support for USB 3.0. In order to use the USB keyboard or mouse connected to a USB 3.0 port during OS installation, the user has to update the Windows® 7 installation image so that it contains USB 3.0 drivers. Please refer to Section 4.13 for detailed installation procedures.</p>
Environmental and Power Specifications	
Power Supply	AT/ATX power supply
Power Consumption	3.3V@1.51A, 5V@3.31A, 12V@9.02A, 5VSB@3.7A (3.6 GHz Intel® Xeon® E3-1275 v5 CPU with four 8 GB 2133 MHz DDR4 memory)
Operating Temperature	-20°C ~ 60°C
Storage Temperature	-30°C ~ 70°C
Operating Humidity	5% ~ 95% (non-condensing)
Physical Specifications	
Dimensions	244 mm x 305 mm
Weight (GW/NW)	1200 g/700 g

Table 1-1: IMBA-C2360-i2 Specifications

Chapter

2

Packing List

IMBA-C2360-i2 ATX Motherboard

2.1 Anti-static Precautions



WARNING!

Static electricity can destroy certain electronics. Make sure to follow the ESD precautions to prevent damage to the product, and injury to the user.

Make sure to adhere to the following guidelines:

- **Wear an anti-static wristband:** Wearing an anti-static wristband can prevent electrostatic discharge.
- **Self-grounding:** Touch a grounded conductor every few minutes to discharge any excess static buildup.
- **Use an anti-static pad:** When configuring any circuit board, place it on an anti-static mat.
- **Only handle the edges of the PCB:** Don't touch the surface of the motherboard. Hold the motherboard by the edges when handling.

2.2 Unpacking Precautions

When the IMBA-C2360-i2 is unpacked, please do the following:

- Follow the anti-static guidelines above.
- Make sure the packing box is facing upwards when opening.
- Make sure all the packing list items are present.







2.3 Packing List

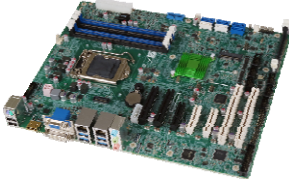

NOTE:

If any of the components listed in the checklist below are missing, do not proceed with the installation. Contact the IEI reseller or vendor the IMBA-C2360-i2 was purchased from or contact an IEI sales representative directly by sending an email to sales@ieiworld.com.

The IMBA-C2360-i2 is shipped with the following components:

Quantity	Item and Part Number	Image
1	IMBA-C2360-i2 single board computer	
2	SATA cable	
1	Standoff and screw (for half-size PCIe Mini card)	
1	I/O shielding	
1	Utility CD	
1	One Key Recovery CD	

IMBA-C2360-i2 ATX Motherboard





Quantity	Item and Part Number	Image
1	Quick installation guide	

Table 2-1: Packing List

2.4 Optional Items

The following are optional components which may be separately purchased:

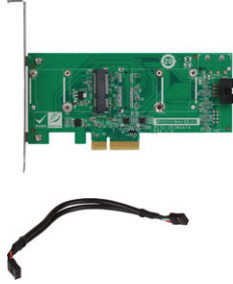
Item and Part Number	Image
iRIS-2400 module, IPMI 2.0 adapter card with AST2400 BMC chip for DDR3 SO-DIMM socket interface (P/N: iRIS-2400-R10)	
PCIe Mini and mSATA expansion card (1 x PCIe Mini, 2 x mSATA expansion) with one USB cable (P/N: PCIES-2PIMSATA-R10, 32001-020300-100-RS)	
USB 3.0 expansion card with two USB cables (P/N: PCIES-USB3-R10, 32001-020300-100-RS)	
LPT cable (P/N: 19800-000049-RS)	

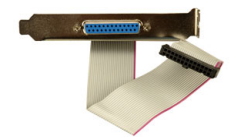
Item and Part Number	Image
PS/2 KB/MS Y-cable with bracket (P/N: 19800-000075-RS)	
Dual-port USB cable with bracket (P/N: 19800-003100-300-RS)	
USB 3.0 cable with bracket, 457 mm (P/N: 19800-010500-200-RS)	
SATA power cable (P/N: 32102-000100-200-RS)	
Serial port cable, P=2.54, 230 mm (P/N: 32205-000702-100-RS)	
High-performance LGA1155/LGA1156 cooler kit (1U chassis compatible, 73W) (P/N: CF-1156A-RS-R11)	
LGA1155/LGA1156 cooler kit (1U chassis compatible, 45W) (P/N: CF-1156C-RS)	
LGA1155/LGA1156 cooler kit (1U chassis compatible, 65W) (P/N: CF-1156D-RS)	
High-performance LGA1155/LGA1156 cooler kit (95W) (P/N: CF-1156E-R11)	

IMBA-C2360-i2 ATX Motherboard





Item and Part Number	Image
DisplayPort to DisplayPort converter board (for IEI iDP connector) (P/N: DP-DP-R10)	
DisplayPort to DVI-D converter board (for IEI iDP connector) (P/N: DP-DVI-R10)	
DisplayPort to HDMI converter board (for IEI iDP connector) (P/N: DP-HDMI-R10)	
DisplayPort to LVDS converter board (for IEI iDP connector) (P/N: DP-LVDS-R10)	
DisplayPort to VGA converter board (for IEI iDP connector) (P/N: DP-VGA-R10)	
20-pin Infineon TPM module, software management tool, firmware v3.17 (P/N: TPM-IN01-R11)	

Table 2-2: Optional Items

Chapter

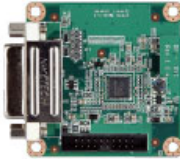
3

Connectors

IMBA-C2360-i2 ATX Motherboard

3.1 Peripheral Interface Connectors

This chapter details all the peripheral interface connectors.

3.1.1 IMBA-C2360-i2 Layout

The figures below show all the peripheral interface connectors.

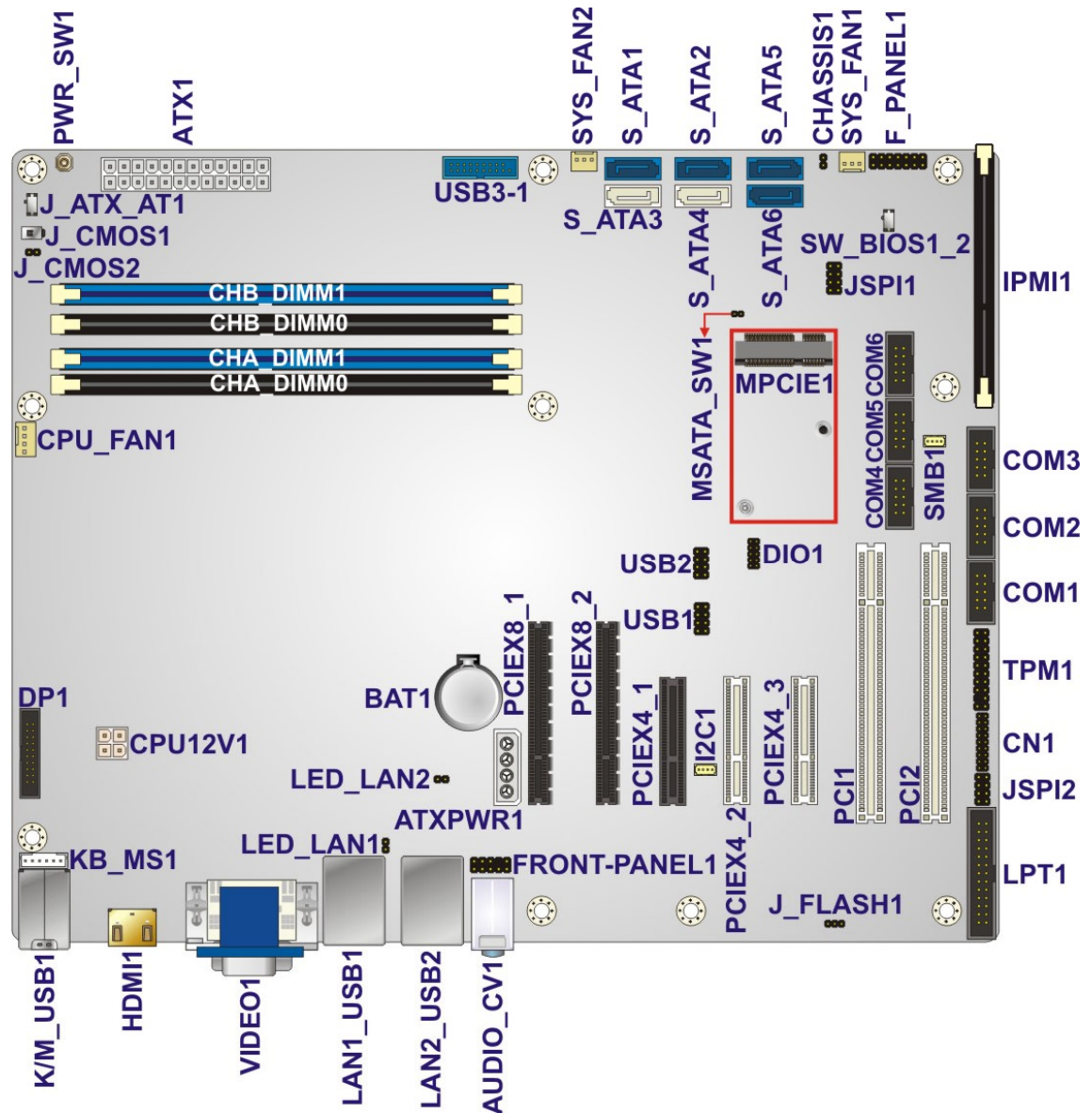

Figure 3-1: Peripheral Interface Connectors

3.1.2 Peripheral Interface Connectors

The table below lists all the connectors on the board.

Connector	Type	Label
+12V ATX power connector	4-pin Molex power connector	CPU12V1
Additional power connector	4-pin connector	ATXPWR1
ATX power connector	24-pin connector	ATX1
Battery connector	Battery holder	BAT1
Chassis intrusion connector	2-pin header	CHASSIS1
DDR4 DIMM sockets	288-pin socket	CHA_DIMM0, CHA_DIMM1, CHB_DIMM0, CHB_DIMM1
Digital I/O connector	10-pin header	DIO1
EC debug connector	18-pin header	CN1
Fan connector (CPU)	4-pin wafer	CPU_FAN1
Fan connectors (system)	3-pin wafer	SYS_FAN1, SYS_FAN2
Front panel audio connector	10-pin header	FRONT-PANEL1
Front panel connector	14-pin header	F_PANEL1
I ² C connector	4-pin wafer	I2C1
Internal DisplayPort connector	20-pin box header	DP1
iRIS module slot	iRIS module slot	IPMI1
Keyboard and mouse connector	6-pin wafer	KB_MS1
LAN1 LED connector	2-pin header	LED_LAN1
LAN2 LED connector	2-pin header	LED_LAN2
PCIe Mini slot	PCIe Mini slot	MPCIE1
Parallel port connector	26-pin box header	LPT1

IMBA-C2360-i2 ATX Motherboard

Connector	Type	Label
PCI slots	PCI slot	PCI1, PCI2
PCIe x4 slots	PCIe x4 slot	PCIEX4_1, PCIEX4_2, PCIEX4_3
PCIe x8 slots	PCIe x8 slot	PCIEX8_1, PCIEX8_2
Power button	Push button	PWR_SW1
SATA 6Gb/s drive connectors	7-pin SATA connector	S_ATA1, S_ATA2, S_ATA3, S_ATA4, S_ATA5, S_ATA6
Serial ports, RS-232	10-pin box header	COM1, COM2, COM3, COM4
Serial ports, RS-232/422/485	10-pin box header	COM5, COM6
SMBus connector	4-pin wafer	SMB1
SPI flash connector	8-pin header	JSPI1
SPI flash connector, EC	8-pin header	JSPI2
TPM connector	20-pin header	TPM1
USB 2.0 connectors	8-pin header	USB1, USB2
USB 3.0 connector	19-pin box header	USB3-1

Table 3-1: Peripheral Interface Connectors

3.1.3 External Interface Panel Connectors

The table below lists the connectors on the external I/O panel.

Connector	Type	Label
Audio connector	Audio jacks	AUDIO_CV1
Ethernet and USB 3.0 ports	RJ-45, USB 3.0	LAN1_USB1, LAN2_USB2
Keyboard/mouse and USB 2.0 ports	PS/2, USB 2.0	K/M_USB1

Connector	Type	Label
VGA and DVI-D connectors	15-pin female, 24-pin female	VIDEO1
HDMI 2.0 connector	HDMI 2.0	HDMI1

Table 3-2: Rear Panel Connectors

3.2 Internal Peripheral Connectors

The section describes all of the connectors on the IMBA-C2360-i2.

3.2.1 +12V ATX Power Connector

- CN Label:** CPU12V1
- CN Type:** 4-pin Molex power connector, p=4.2 mm
- CN Location:** See **Figure 3-2**
- CN Pinouts:** See **Table 3-3**

This connector provides power to the CPU.

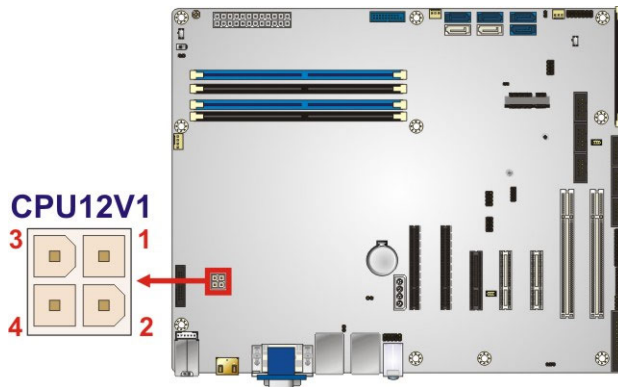

Figure 3-2: +12V ATX Power Connector Pinout Location

Pin	Description	Pin	Description
1	GND	2	GND
3	+12V	4	+12V

Table 3-3: +12V ATX Power Connector Pinouts

IMBA-C2360-i2 ATX Motherboard

3.2.2 Additional Power Connector

- CN Label:** ATXPWR1
CN Type: 4-pin connector, p=5.08 mm
CN Location: See **Figure 3-3**
CN Pinouts: See **Table 3-4**

The additional power connector provides extra +12V and +5V power to the system.

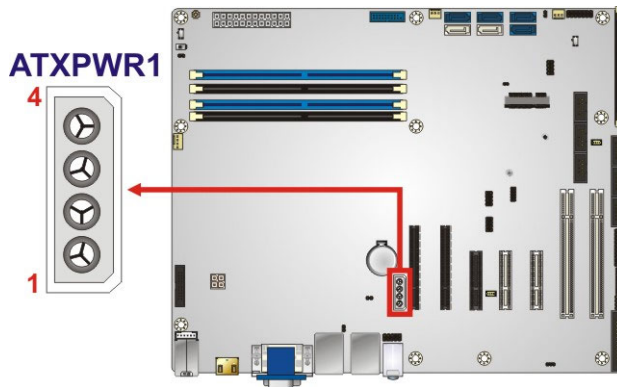

Figure 3-3: Additional Power Connector Location

Pin	Description
1	+12V
2	GND
3	GND
4	VCC

Table 3-4: Additional Power Connector Pinouts

3.2.3 ATX Power Connector

- CN Label:** ATX1
CN Type: 24-pin connector, p=4.2 mm
CN Location: See **Figure 3-4**
CN Pinouts: See **Table 3-5**

The ATX power connector connects to an ATX power supply.

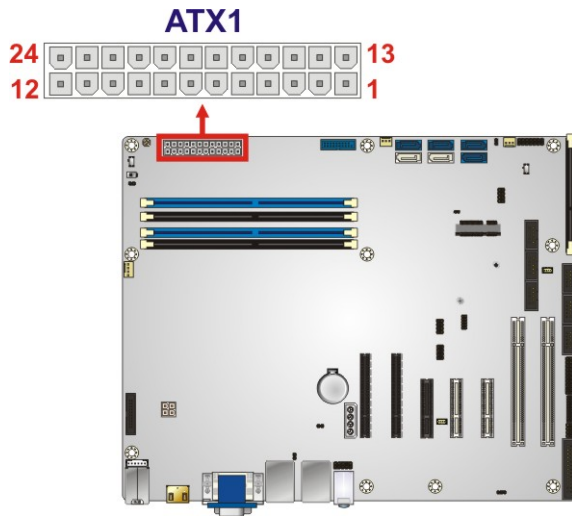

Figure 3-4: ATX Power Connector Location

Pin	Description	Pin	Description
1	+3.3V	13	+3.3V
2	+3.3V	14	-12V
3	GND	15	GND
4	+5V	16	PS_ON
5	GND	17	GND
6	+5V	18	GND
7	GND	19	GND
8	Power good	20	-5V
9	5VSB	21	+5V
10	+12V	22	+5V
11	+12V	23	+5V
12	+3.3V	24	GND

Table 3-5: ATX Power Connector Pinouts

IMBA-C2360-i2 ATX Motherboard

3.2.4 Battery Connector



CAUTION:

Risk of explosion if battery is replaced by an incorrect type. Only certified engineers should replace the on-board battery.

Dispose of used batteries according to instructions and local regulations.

CN Label:	BAT1
CN Type:	Battery holder
CN Location:	See Figure 3-5

A system battery is placed in the battery holder. The battery provides power to the system clock to retain the time when power is turned off.

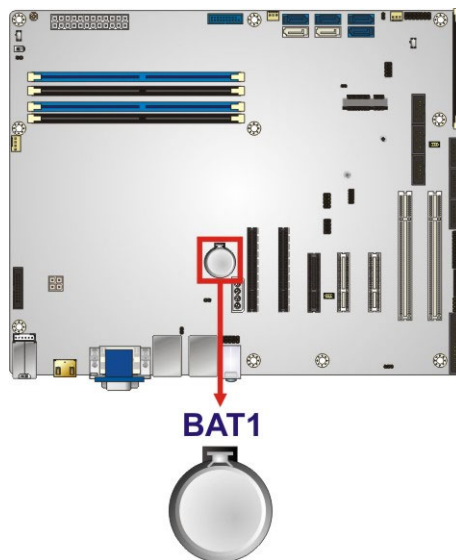

Figure 3-5: Battery Connector Location

3.2.5 Chassis Intrusion Connector

- CN Label:** CHASSIS1
- CN Type:** 2-pin header, p=2.54 mm
- CN Location:** See **Figure 3-6**
- CN Pinouts:** See **Table 3-6**

The chassis intrusion connector is for a chassis intrusion detection sensor or switch that detects if a chassis component is removed or replaced.

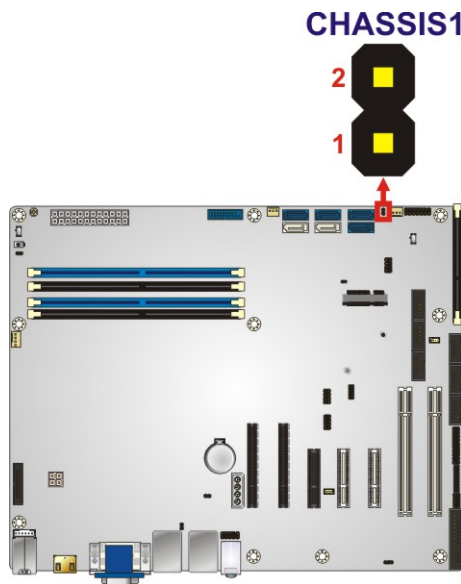

Figure 3-6: Chassis Intrusion Connector Location

Pin	Description
1	+3.3VSB
2	CHASSIS OPEN

Table 3-6: Chassis Intrusion Connector Pinouts

IMBA-C2360-i2 ATX Motherboard

3.2.6 DDR4 DIMM Slots

CN Label: CHA_DIMM0, CHA_DIMM1, CHB_DIMM0, CHB_DIMM1

CN Type: DDR4 DIMM slot

CN Location: See **Figure 3-7**

The DIMM slots are for DDR4 DIMM memory modules.

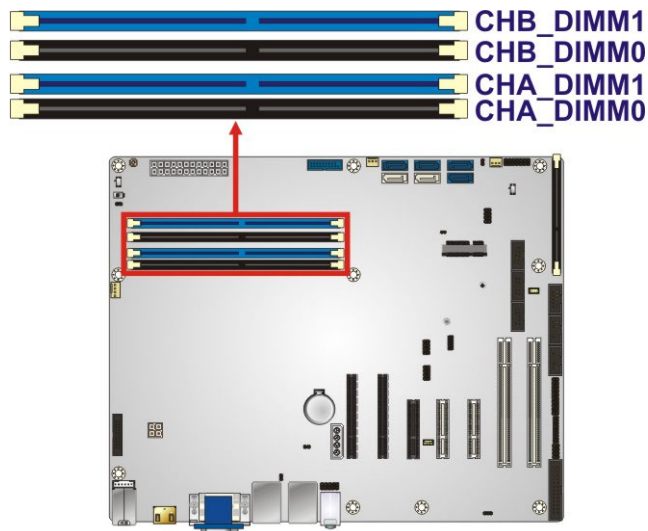

Figure 3-7: DDR4 DIMM Slot Locations

3.2.7 Digital I/O Connector

- CN Label:** DIO1
- CN Type:** 10-pin header, p=2 mm
- CN Location:** See **Figure 3-8**
- CN Pinouts:** See **Table 3-7**

The digital I/O connector provides programmable input and output for external devices.

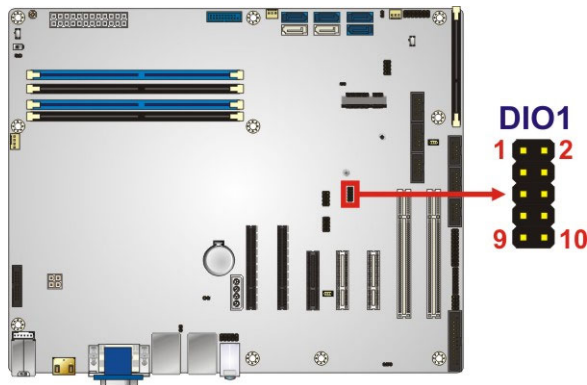

Figure 3-8: Digital I/O Connector Location

Pin	Description	Pin	Description
1	GND	2	VCC
3	Output 3	4	Output 2
5	Output 1	6	Output 0
7	Input 3	8	Input 2
9	Input 1	10	Input 0

Table 3-7: Digital I/O Connector Pinouts

IMBA-C2360-i2 ATX Motherboard

3.2.8 EC Debug Connector

- CN Label:** CN1
- CN Type:** 18-pin header, p=2 mm
- CN Location:** See **Figure 3-9**
- CN Pinouts:** See **Table 3-8**

The EC debug connector is used for EC debug.

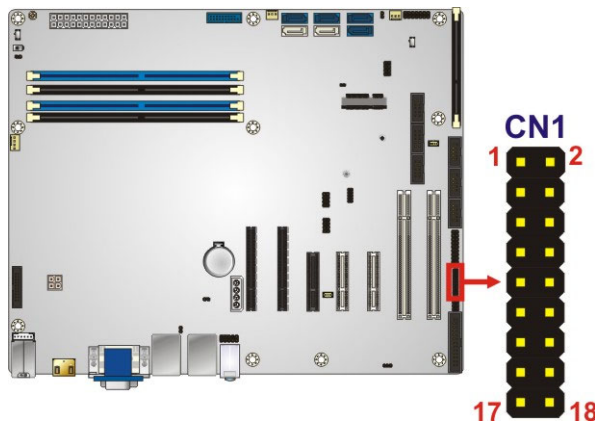

Figure 3-9: EC Debug Connector Location

Pin	Description	Pin	Description
1	EC_EPP_STB#	2	EC_EPP_AFD#
3	EC_EPP_PDO	4	NC
5	EC_EPP_PD1	6	EC_EPP_INIT#
7	EC_EPP_PD2	8	EC_EPP_SLIN#
9	EC_EPP_PD3	10	GND
11	EC_EPP_PD4	12	NC
13	EC_EPP_PD5	14	EC_EPP_BUSY
15	EC_EPP_PD6	16	EC_EPP_KSI5
17	EC_EPP_PD7	18	EC_EPP_KSI4

Table 3-8: EC Debug Connector Pinouts

3.2.9 Fan Connector (CPU)

- CN Label:** CPU_FAN1
- CN Type:** 4-pin wafer, p=2.54 mm
- CN Location:** See **Figure 3-10**
- CN Pinouts:** See **Table 3-9**

The fan connector attaches to a CPU cooling fan.

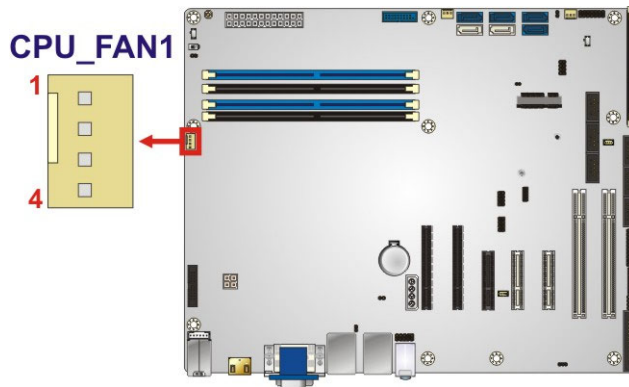

Figure 3-10: CPU Fan Connector Location

Pin	Description
1	GND
2	+12V
3	FANIO
4	PWM

Table 3-9: CPU Fan Connector Pinouts

IMBA-C2360-i2 ATX Motherboard

3.2.10 Fan Connectors (System)

- CN Label:** SYS_FAN1, SYS_FAN2
- CN Type:** 3-pin wafer, p=2.54 mm
- CN Location:** See Figure 3-11
- CN Pinouts:** See Table 3-10 and Table 3-11

Each fan connector attaches to a system cooling fan. The SYS_FAN1 provides smart fan function.

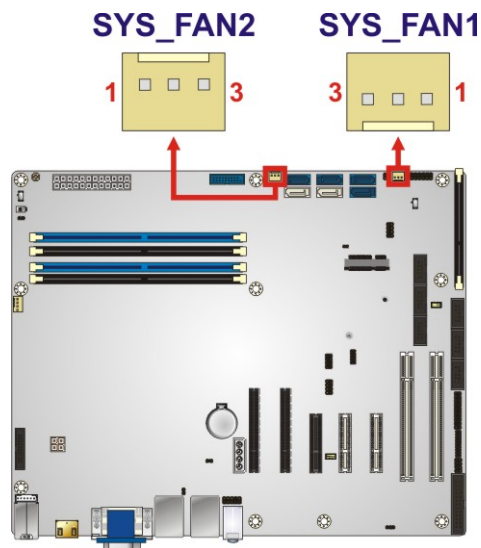

Figure 3-11: System Fan Connector Locations

Pin	Description
1	FANIO
2	PWM
3	GND

Table 3-10: System Fan (SYS_FAN1) Connector Pinouts

Pin	Description
1	NC
2	+12V
3	GND

Table 3-11: System Fan (SYS_FAN2) Connector Pinouts

3.2.11 Front Panel Audio Connector

- CN Label:** FRONT-PANEL1
- CN Type:** 10-pin header, p=2.54 mm
- CN Location:** See **Figure 3-12**
- CN Pinouts:** See **Table 3-12**

This connector connects to speakers, a microphone and an audio input.

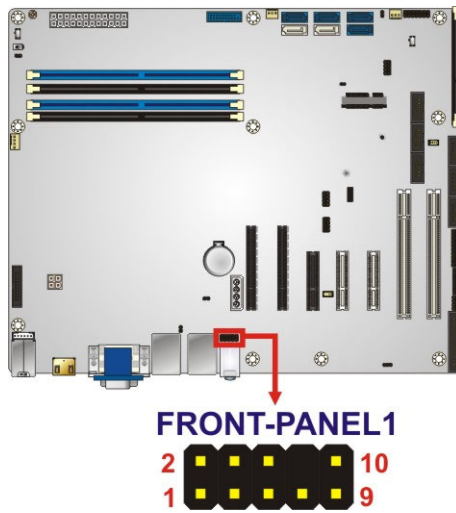

Figure 3-12: Front Panel Audio Connector Location

Pin	Description	Pin	Description
1	MIC2-L	2	GND
3	MIC2-R	4	Presence#
5	LINE2-R	6	MIC2-JD
7	FRONT-IO	8	NC
9	LINE2-L	10	LINE2-JD

Table 3-12: Front Panel Audio Connector Pinouts

IMBA-C2360-i2 ATX Motherboard

3.2.12 Front Panel Connector

- CN Label:** F_PANEL1
- CN Type:** 14-pin header, p=2.54 mm
- CN Location:** See **Figure 3-13**
- CN Pinouts:** See **Table 3-13**

The front panel connector connects to the indicator LEDs and buttons on the computer's front panel.

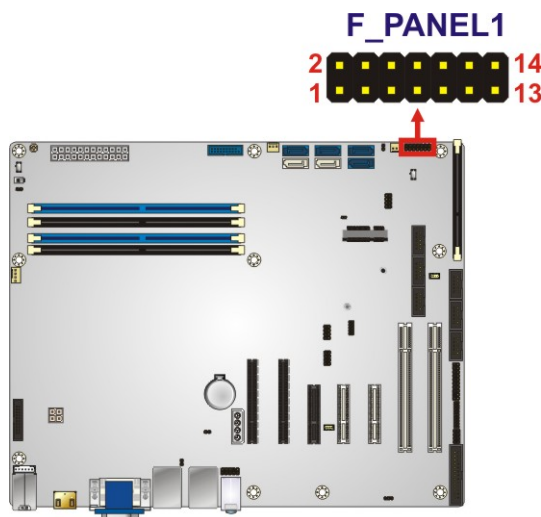

Figure 3-13: Front Panel Connector Location

Function	Pin	Description	Function	Pin	Description
Power/QTS LED	1	PWR_LED+ / QTS_LED+	Speaker	2	SPKR+
	3	NC		IPMI LED	4
	5	PWR_LED- / QTS_LED-	6		IPMI ID_LED-
Power Button	7	PWR_BTN+	Speaker	8	SPKR-
	9	PWR_BTN-		10	NC
HDD LED	11	HDD_LED+	Reset	12	RESET+
	13	HDD_LED-		14	RESET-

Table 3-13: Front Panel Connector Pinouts

3.2.13 I²C Connector

- CN Label:** I2C1
- CN Type:** 4-pin wafer, p=1.25 mm
- CN Location:** See **Figure 3-14**
- CN Pinouts:** See **Table 3-14**

The I²C connector is used to connect I²C-bus devices to the mainboard.

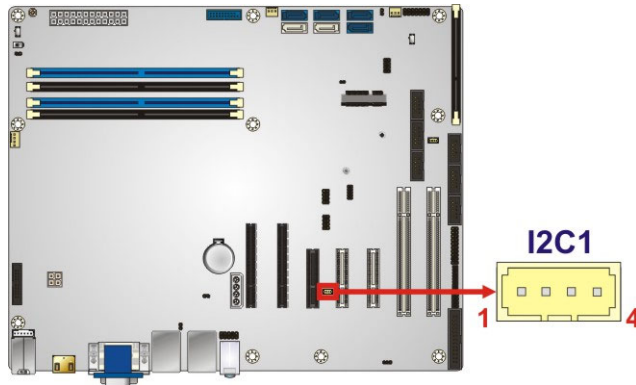

Figure 3-14: I²C Connector Location

Pin	Description
1	GND
2	I2C_DAT
3	I2C_CLK
4	+5V

Table 3-14: I²C Connector Pinouts

IMBA-C2360-i2 ATX Motherboard

3.2.14 Internal DisplayPort Connector

- CN Label:** DP1
- CN Type:** 20-pin box header, p=2 mm
- CN Location:** See **Figure 3-15**
- CN Pinouts:** See **Table 3-15**

The DisplayPort connector supports HDMI, LVDS, VGA, DVI and DisplayPort graphics interfaces.

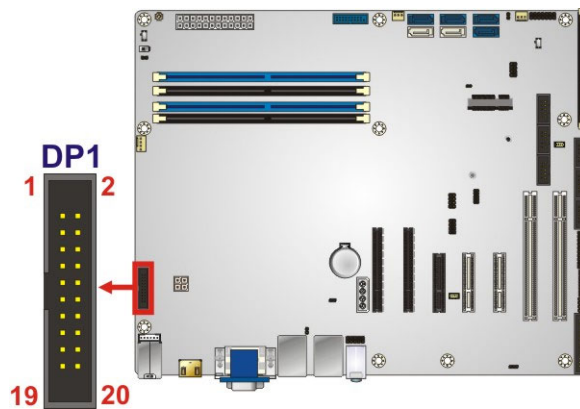

Figure 3-15: Internal DisplayPort Connector Location

Pin	Description	Pin	Description
1	HPD	11	LANE3N
2	AUXP	12	GND
3	GND	13	GND
4	AUXN	14	LANE0P
5	AUX_CTRL_DET_D	15	LANE1P
6	GND	16	LANE0N
7	GND	17	LANE1N
8	LANE2P	18	+3.3V
9	LANE3P	19	+5V
10	LANE2N	20	N/A

Table 3-15: Internal DisplayPort Connector Pinouts

3.2.15 iRIS Module Slot

- CN Label:** IPMI1
CN Type: iRIS module slot
CN Location: See **Figure 3-16**

The iRIS module slot allows installation of the iRIS-2400 module.

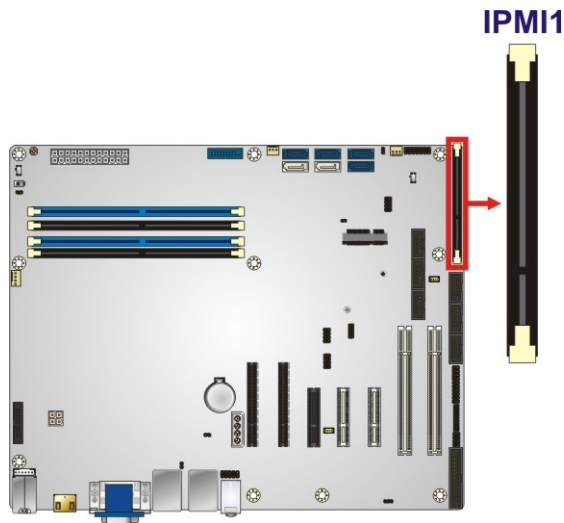

Figure 3-16: iRIS Module Slot Location



WARNING:

The iRIS module slot is designed to install the iRIS-2400 module only. DO NOT install other modules into the iRIS module slot. Doing so may cause damage to the IMBA-C2360-i2.

IMBA-C2360-i2 ATX Motherboard

3.2.16 Keyboard and Mouse Connector

- CN Label:** KB_MS1
- CN Type:** 6-pin wafer, p=2 mm
- CN Location:** See **Figure 3-17**
- CN Pinouts:** See **Table 3-16**

The keyboard and mouse connector connects to a PS/2 Y-cable that can be connected to a PS/2 keyboard and mouse.

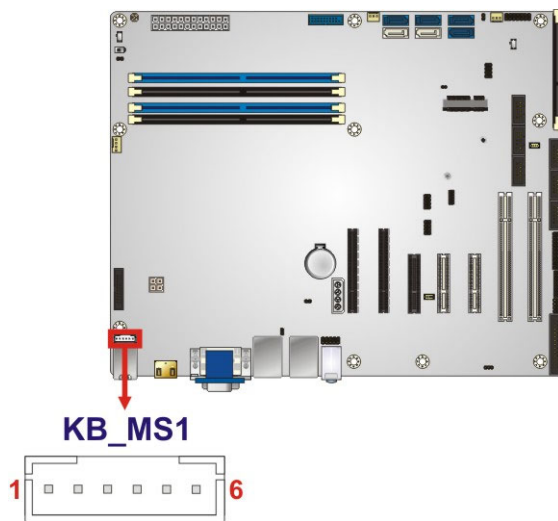

Figure 3-17: Keyboard and Mouse Connector Location

Pin	Description
1	VCC
2	Mouse Data
3	Mouse Clock
4	Keyboard Data
5	Keyboard Clock
6	GND

Table 3-16: Keyboard and Mouse Connector Pinouts

3.2.17 LAN LED Connectors

- CN Label:** LED_LAN1, LED_LAN2
- CN Type:** 2-pin header, p=2.54 mm
- CN Location:** See **Figure 3-18**
- CN Pinouts:** See **Table 3-17** and **Table 3-18**

The LAN LED connectors are used to connect to the LAN LED indicators on the chassis to indicate users the link activities of the two LAN ports.

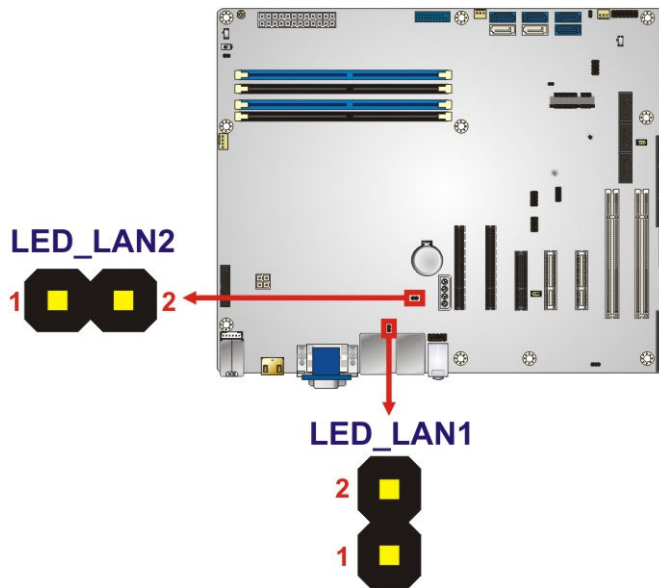

Figure 3-18: LAN LED Connector Locations

Pin	Description
1	+3.3V
2	LAN1_LED_LINK#_ACT

Table 3-17: LAN1 LED Connector (LED_LAN1) Pinouts

Pin	Description
1	+3.3V
2	LAN2_LED_LINK#_ACT

Table 3-18: LAN2 LED Connector (LED_LAN2) Pinouts

IMBA-C2360-i2 ATX Motherboard

3.2.18 Parallel Port Connector

- CN Label:** LPT1
- CN Type:** 26-pin box header, p=2.54 mm
- CN Location:** See **Figure 3-19**
- CN Pinouts:** See **Table 3-19**

The parallel port connector connects to a parallel port connector interface or some other parallel port device such as a printer.

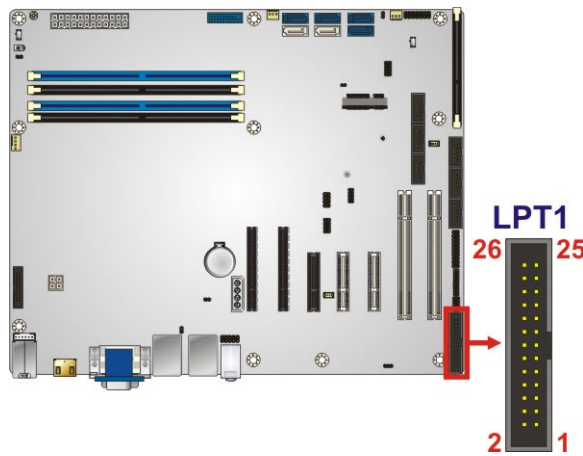

Figure 3-19: Parallel Port Connector Location

Pin	Description	Pin	Description
1	RSTROBE#	2	SIO_AFD#
3	RPD0	4	SIO_ERR#
5	RPD1	6	SIO_INIT#
7	RPD2	8	SIO_SLIN#
9	RPD3	10	GND
11	RPD4	12	GND
13	RPD5	14	GND
15	RPD6	16	GND
17	RPD7	18	GND
19	SIO_ACK#	20	GND
21	SIO_BUSY	22	GND

23	SIO_PE	24	GND
25	SIO_SLCT	26	N/C

Table 3-19: Parallel Port Connector Pinouts

3.2.19 PCI Slots

- CN Label:** PCI1, PCI2
- CN Type:** PCI Slot
- CN Location:** See **Figure 3-20**

The PCI slot enables a PCI expansion module to be connected to the board.

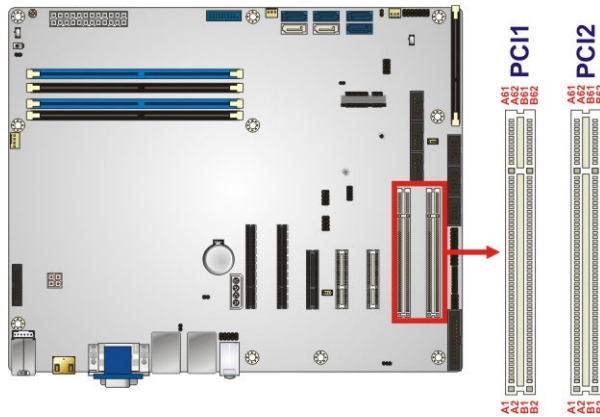

Figure 3-20: PCI Slot Locations

3.2.20 PCIe x4 Slots

- CN Label:** PCIEX4_1, PCIEX4_2, PCIEX4_3
- CN Type:** PCIe x4 slot
- CN Location:** See **Figure 3-21**



NOTE:

To configure the PCIEX4_2 and PCIEX4_3 slot function, please refer to **Sections 4.11.4** and **5.4.2.1** for detailed information.

IMBA-C2360-i2 ATX Motherboard

The PCIe x4 expansion card slots are for PCIe x4 expansion cards.

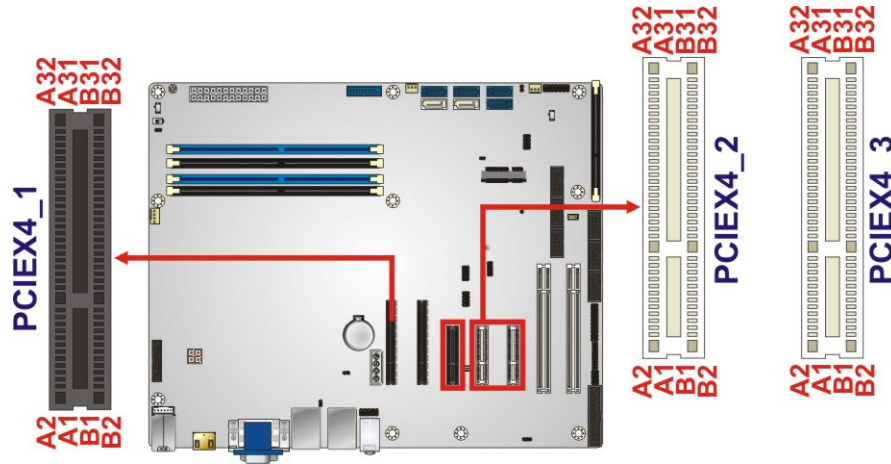

Figure 3-21: PCIe x4 Slot Locations

3.2.21 PCIe x8 Slots

CN Label: PCIEX8_1, PCIEX8_2

CN Type: PCIe x8 slot

CN Location: See **Figure 3-22**

The PCIe x8 expansion card slots are for PCIe x8 expansion cards.

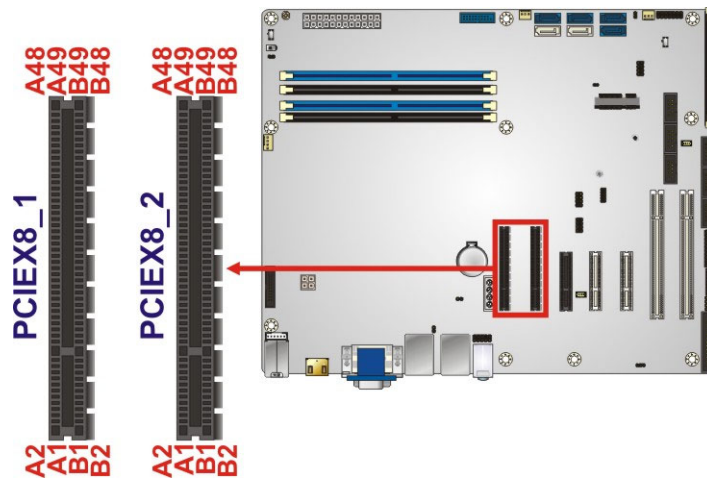

Figure 3-22: PCIe x8 Slot Locations

3.2.22 PCIe Mini Slot

- CN Label:** MPCIE1
- CN Type:** PCIe Mini slot
- CN Location:** See **Figure 3-23**
- CN Pinouts:** See **Table 3-20**

The PCIe Mini slot is for installing a full-size/half-size PCIe Mini expansion card, including an mSATA card.



NOTE:

If the user shorts the mSATA setup jumper (MSATA_SW1) to force the system to enable mSATA device or an mSATA device is detected, the **S_ATA6** connector will be disabled. Please refer to **Section 4.11.6** for detailed information.

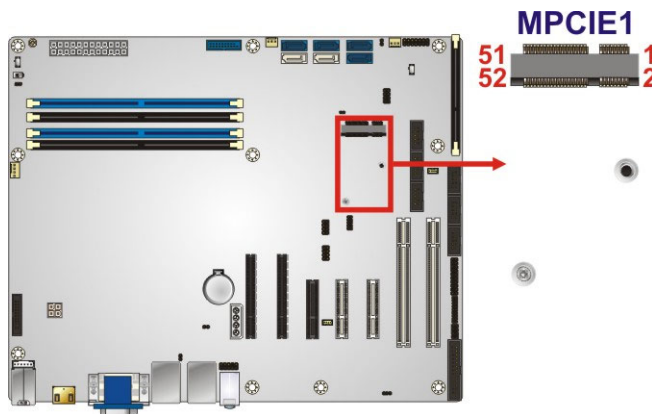

Figure 3-23: PCIe Mini Slot Location

Pin	Description	Pin	Description
1	PCIE_WAKE#	2	+3.3V
3	N/C	4	GND
5	N/C	6	1.5V
7	N/C	8	N/C

IMBA-C2360-i2 ATX Motherboard

Pin	Description	Pin	Description
9	GND	10	N/C
11	MSATA_CLK#	12	N/C
13	MSATA_CLK	14	N/C
15	GND	16	N/C
17	PLTRST_N	18	GND
19	N/C	20	+3.3V
21	GND	22	PLTRST_N
23	SATA_RX-/PCIE_RX-	24	+3.3V
25	SATA_RX+/PCIE_RX+	26	GND
27	GND	28	1.5V
29	GND	30	SMB_CLK
31	SATA_TX-/PCIE_TX-	32	SMB_DATA
33	SATA_TX+/PCIE_TX+	34	GND
35	GND	36	USB_DATA-
37	GND	38	USB_DATA+
39	+3.3V	40	GND
41	+3.3V	42	N/C
43	+3.3V	44	N/C
45	CLINK_CLK	46	N/C
47	CLINK_DATA	48	1.5V
49	CLINK_RST#	50	GND
51	MSATA_DET	52	+3.3V

Table 3-20: PCIe Mini Slot Pinouts

3.2.23 Power Button

- CN Label:** PWR_SW1
- CN Type:** Push button
- CN Location:** See **Figure 3-24**

The on-board power button controls system power.

PWR_SW1

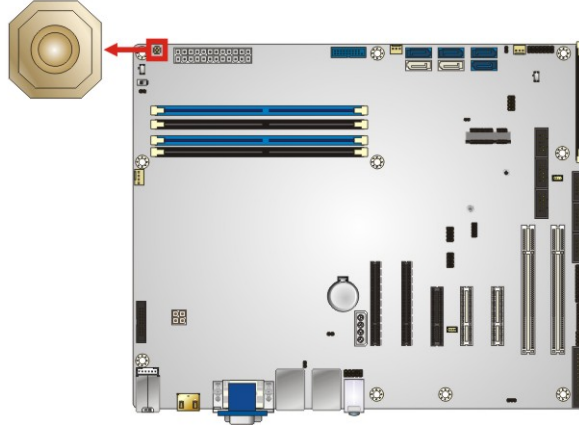

Figure 3-24: Power Button Location

3.2.24 SATA 6Gb/s Drive Connector

CN Label: S_ATA1, S_ATA2, S_ATA3, S_ATA4, S_ATA5, S_ATA6

CN Type: 7-pin SATA drive connector

CN Location: See **Figure 3-25**

CN Pinouts: See **Table 3-21**

The SATA drive connectors can be connected to SATA drives and support up to 6Gb/s data transfer rate.



NOTE:

If the user shorts the mSATA setup jumper (MSATA_SW1) to force the system to enable mSATA device or an mSATA device is detected, the **S_ATA6** connector will be disabled. Please refer to **Section 4.11.6** for detailed information.

If the **PCIEX4_3** slot is installed with a PCIe x4 expansion card or the optional PCIe Mini and mSATA expansion card, the **S_ATA3** and **S_ATA4** connectors will be disabled. Please refer to **Section 4.11.4** for detailed information.

IMBA-C2360-i2 ATX Motherboard

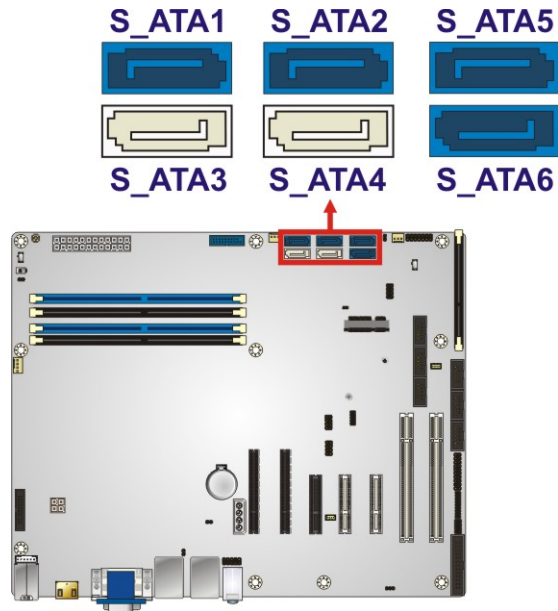

Figure 3-25: SATA 6Gb/s Drive Connector Locations

Pin	Description
1	GND
2	SATA_TX+
3	SATA_TX-
4	GND
5	SATA_RX-
6	SATA RX+
7	GND

Table 3-21: SATA 6Gb/s Drive Connector Pinouts

3.2.25 Serial Port Connectors, RS-232

- CN Label:** COM1,COM2,COM3,COM4
- CN Type:** 10-pin box header, p=2.54 mm
- CN Location:** See Figure 3-26
- CN Pinouts:** See Table 3-22

Each of these connectors provides RS-232 connections.

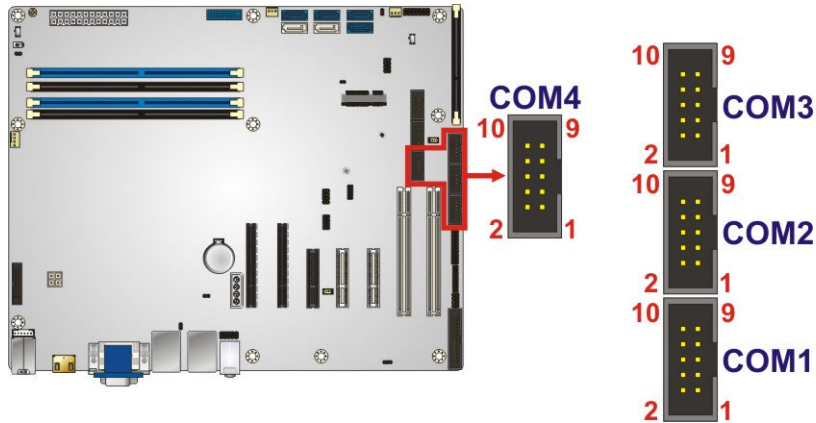

Figure 3-26: RS-232 Serial Port Connector Location

Pin	Description	Pin	Description
1	DCD	2	DSR
3	RXD	4	RTS
5	TXD	6	CTS
7	DTR	8	RI
9	GND	10	GND

Table 3-22: RS-232 Serial Port Connector Pinouts

3.2.26 Serial Port Connectors, RS-232/422/485

- CN Label:** COM5, COM6
- CN Type:** 10-pin box header, p=2.54 mm
- CN Location:** See **Figure 3-27**
- CN Pinouts:** See **Table 3-23**

Each of these connectors provides RS-232, RS-422 or RS-485 communications.

IMBA-C2360-i2 ATX Motherboard



NOTE:

The communication protocol of the serial ports is set through the BIOS menu in “Advanced → Super IO Configuration → Serial Port 5/6 Configuration”. Use the **Transfer Mode** BIOS option to configure the correspondent serial ports (refer to **Sections 5.3.4.4.2** and **5.3.4.4.3** for detailed information).

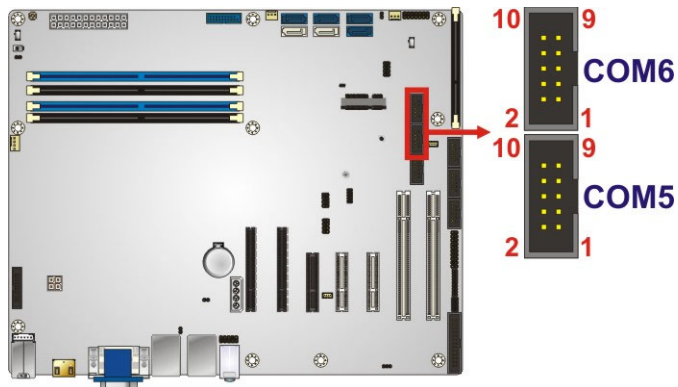

Figure 3-27: RS-232/422/485 Connector Location

Pin	Description	Pin	Description
1	DCD	2	DSR
3	RXD	4	RTS
5	TXD	6	CTS
7	DTR	8	RI
9	GND	10	GND

Table 3-23: RS-232/422/485 Connector Pinouts

Use the optional RS-232/422/485 cable to connect to a serial device. The pinouts of the DB-9 connector are listed below.

RS-232 Pinouts	RS-422 Pinouts	RS-485 Pinouts

Table 3-24: DB-9 RS-232/422/485 Pinouts

3.2.27 SMBus Connector

- CN Label:** SMB1
- CN Type:** 4-pin wafer, p=1.25 mm
- CN Location:** See **Figure 3-28**
- CN Pinouts:** See **Table 3-25**

The SMBus (System Management Bus) connector provides low-speed system management communications.

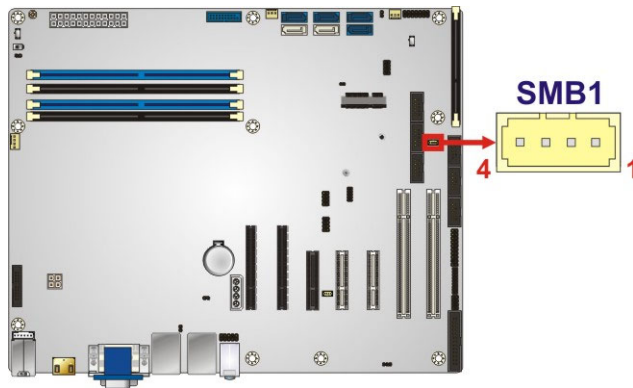

Figure 3-28: SMBus Connector Location

Pin	Description
1	GND
2	SMB_DATA
3	SMB_CLK
4	+5V

Table 3-25: SMBus Connector Pinouts

IMBA-C2360-i2 ATX Motherboard

3.2.28 SPI Flash Connector

- CN Label:** JSPI1
- CN Type:** 8-pin header, p=2.54 mm
- CN Location:** See **Figure 3-29**
- CN Pinouts:** See **Table 3-26**

The SPI flash connector is used to flash the SPI ROM.

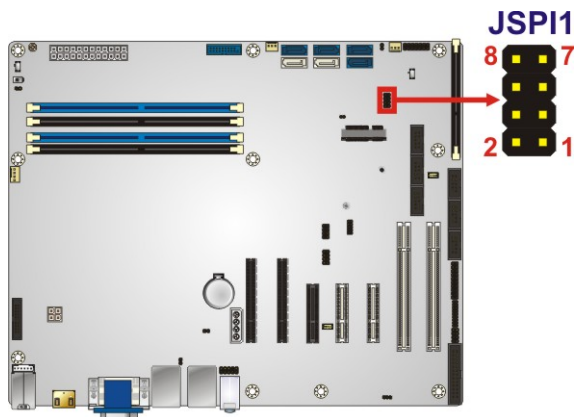

Figure 3-29: SPI Flash Connector Location

Pin	Description	Pin	Description
1	+3.3V	2	GND
3	SPI_CS	4	SPI_CLK
5	SPI_SO	6	SPI_SI
7	NC	8	NC

Table 3-26: SPI Flash Connector Pinouts

3.2.29 SPI Flash Connector, EC

- CN Label:** JSPI2
- CN Type:** 8-pin header, p=2.54 mm
- CN Location:** See **Figure 3-30**
- CN Pinouts:** See **Table 3-27**

The SPI flash connector is used to flash the EC ROM.

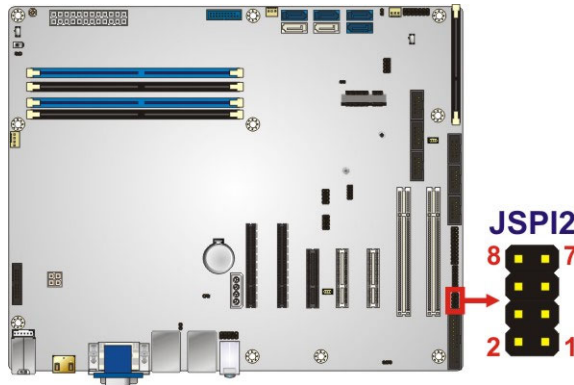

Figure 3-30: SPI EC Flash Connector Location

Pin	Description	Pin	Description
1	+3.3V	2	GND
3	SPI_CS	4	SPI_CLK
5	SPI_SO	6	SPI_SI
7	NC	8	NC

Table 3-27: SPI EC Flash Connector Pinouts

IMBA-C2360-i2 ATX Motherboard

3.2.30 TPM Connector

- CN Label:** TPM1
- CN Type:** 20-pin header, p=2.54 mm
- CN Location:** See **Figure 3-31**
- CN Pinouts:** See **Table 3-28**

The TPM connector connects to a TPM module.

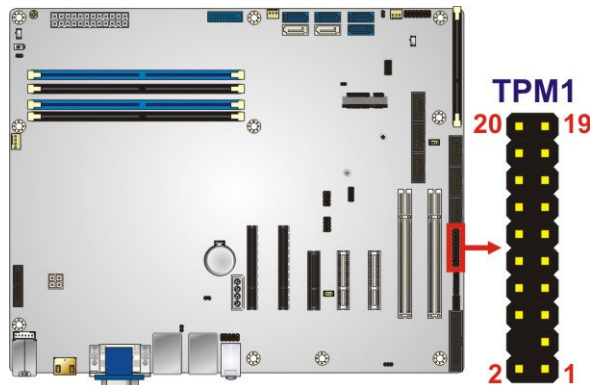

Figure 3-31: TPM Connector Location

Pin	Description	Pin	Description
1	LCLK	2	GND
3	LFRAME#	4	KEY
5	LRERST#	6	+5V
7	LAD3	8	LAD2
9	+3.3V	10	LAD1
11	LAD0	12	GND
13	SCL	14	SDA
15	SB3V	16	SERIRQ
17	GND	18	GLKRUN#
19	LPCPD#	20	LDRO#

Table 3-28: TPM Connector Pinouts

3.2.31 USB 2.0 Connectors

- CN Label:** USB1, USB2
- CN Type:** 8-pin header, p=2.54 mm
- CN Location:** See **Figure 3-32**
- CN Pinouts:** See **Table 3-29**

The USB 2.0 connectors connect to USB 2.0 devices. Each pin header provides two USB 2.0 ports.

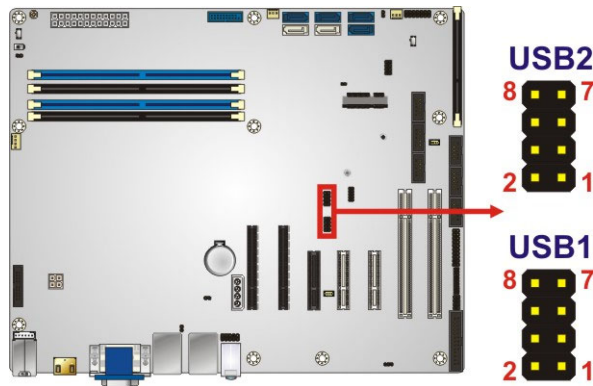

Figure 3-32: USB 2.0 Connector Pinout Locations

Pin	Description	Pin	Description
1	VCC	2	GND
3	USB_DATA-	4	USB_DATA+
5	USB_DATA+	6	USB_DATA-
7	GND	8	VCC

Table 3-29: USB 2.0 Connector Pinouts

IMBA-C2360-i2 ATX Motherboard

3.2.32 USB 3.0 Connector

- CN Label:** USB3-1
- CN Type:** 19-pin box header, p=2 mm
- CN Location:** See **Figure 3-33**
- CN Pinouts:** See **Table 3-30**

The USB 3.0 connector connects to USB 3.0 devices. This connector provides two USB 3.0 ports.

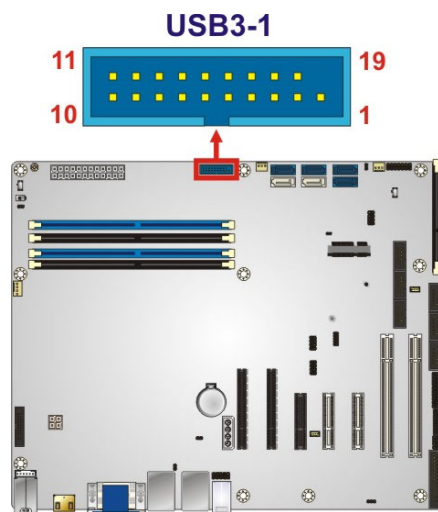

Figure 3-33: USB 3.0 Connector Location

Pin	Description	Pin	Description
1	VCC	11	USB_DATA+
2	USB3_RX-	12	USB_DATA-
3	USB3_RX+	13	GND
4	GND	14	USB3_TX+
5	USB3_TX-	15	USB3_TX-
6	USB3_TX+	16	GND
7	GND	17	USB3_RX+
8	USB_DATA-	18	USB3_RX-
9	USB_DATA+	19	VCC
10	NC		

Table 3-30: USB 3.0 Connector Pinouts

3.3 External Peripheral Interface Connector Panel

The figure below shows the external peripheral interface connector (EPIC) panel. The EPIC panel consists of the following:

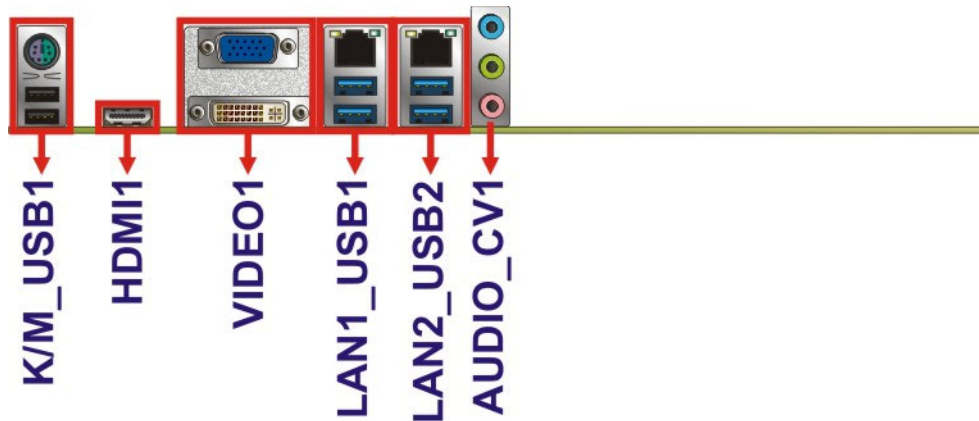

Figure 3-34: External Peripheral Interface Connector

3.3.1 Audio Connector

CN Label:	AUDIO_CV1
CN Type:	Audio jack
CN Location:	See Figure 3-34

The audio jacks connect to external audio devices.

- **Line In port (Light Blue):** Connects a CD-ROM, DVD player, or other audio devices.
- **Line Out port (Lime):** Connects to a headphone or a speaker. With multi-channel configurations, this port can also connect to front speakers.
- **Microphone (Pink):** Connects a microphone.

IMBA-C2360-i2 ATX Motherboard

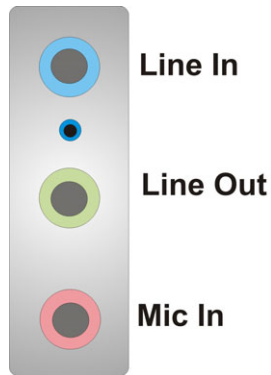

Figure 3-35: Audio Connector

3.3.2 Ethernet and USB 3.0 Connectors

CN Label: LAN1_USB1, LAN2_USB2

CN Type: RJ-45, USB 3.0

CN Location: See Figure 3-34

CN Pinouts: See Table 3-31 and Table 3-32

There are four external USB 3.0 connectors on the IMBA-C2360-i2.

Pin	Description	Pin	Description
1	VCC	10	VCC
2	USB_DATA-	11	USB_DATA-
3	USB_DATA+	12	USB_DATA+
4	GND	13	GND
5	USB3_RX-	14	USB3_RX-
6	USB3_RX+	15	USB3_RX+
7	GND	16	GND
8	USB3_TX-	17	USB3_TX-
9	USB3_TX+	18	USB3_TX+

Table 3-31: USB 3.0 Port Pinouts

Each LAN connector connects to a local network

Pin	Description	Pin	Description
20	LAN1_MDI0P	24	LAN1_MDI2P
21	LAN1_MDI0N	25	LAN1_MDI2N
22	LAN1_MDI1P	26	LAN1_MDI3P
23	LAN1_MDI1N	27	LAN1_MDI3N

Table 3-32: LAN Pinouts

3.3.3 HDMI Connector

- CN Label:** HDMI1
- CN Type:** HDMI 2.0 connector
- CN Location:** See **Figure 3-34**
- CN Pinouts:** See **Table 3-33**

The HDMI connector connects to a display device with HDMI interface.

Pin	Description	Pin	Description
1	HDMI_DATA2	13	NC
2	GND	14	NC
3	HDMI_DATA2#	15	HDMI_SCL
4	HDMI_DATA1	16	HDMI_SDA
5	GND	17	GND
6	HDMI_DATA1#	18	+5V
7	HDMI_DATA0	19	HDMI_HPD
8	GND	20	HDMI_GND
9	HDMI_DATA0#	21	HDMI_GND
10	HDMI_CLK	22	HDMI_GND
11	GND	23	HDMI_GND
12	HDMI_CLK#		

Table 3-33: HDMI Connector Pinouts

IMBA-C2360-i2 ATX Motherboard

3.3.4 Keyboard/Mouse and USB 2.0 Connectors

- CN Label:** K/M_USB1
- CN Type:** PS/2, USB 2.0
- CN Location:** See **Figure 3-34**
- CN Pinouts:** See **Table 3-34** and **Table 3-35**

The USB 2.0 connector can be connected to a USB 2.0/1.1 device.

Pin	Description	Pin	Description
1	VCC	5	VCC
2	USB_DATA-	6	USB_DATA-
3	USB_DATA+	7	USB_DATA+
4	GND	8	GND

Table 3-34: USB 2.0 Port Pinouts

The PS/2 port is for connecting a PS/2 mouse or keyboard.

Pin	Description
9	GND
10	Keyboard Data
11	Mouse Data
12	VCC
13	Keyboard Clock
14	Mouse Clock

Table 3-35: PS/2 Connector Pinouts

3.3.5 VGA and DVI-D Connectors

- CN Label:** VIDEO1
- CN Type:** 15-pin VGA and 24-pin DVI-D
- CN Location:** See **Figure 3-34**
- CN Pinouts:** See **Table 3-36** and **Table 3-37**

The DVI connector connects to a monitor that supports DVI video input.

Pin	Description	Pin	Description
1	DVI_DATA2#	2	DVI_DATA2
3	GND	4	NC
5	NC	6	DDC CLK
7	DDC DATA	8	VS
9	DVI_DATA1#	10	DVI_DATA1
11	GND	12	NC
13	NC	14	+5V
15	Hot Plug Detect	16	HPDET
17	DVI_DATA0#	18	DVI_DATA0
19	GND	20	NC
21	NC	22	NC
23	DVI_CLK	24	DVI_CLK#

Table 3-36: DVI-D Connector Pinouts

The 15-pin VGA connector connects to a monitor that accepts a standard VGA input.



NOTE:

The user has to connect the VGA connector to the monitor before system booting as the VGA output function is supported via the eDP to VGA converter.

IMBA-C2360-i2 ATX Motherboard

Pin	Description	Pin	Description
1	RED	2	GREEN
3	BLUE	4	NC
5	GND	6	HOT PLUG DETECT
7	GND	8	GND
9	VCC	10	GND
11	NC	12	DCCDA
13	HSYNC	14	VSYNC
15	DDCCLK		

Table 3-37: VGA Connector Pinouts

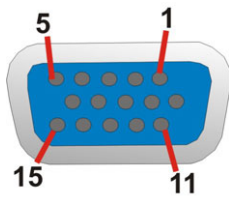

Figure 3-36: VGA Connector

Chapter

4

Installation

IMBA-C2360-i2 ATX Motherboard

4.1 Anti-static Precautions



WARNING:

Failure to take ESD precautions during the installation of the IMBA-C2360-i2 may result in permanent damage to the IMBA-C2360-i2 and severe injury to the user.

Electrostatic discharge (ESD) can cause serious damage to electronic components, including the IMBA-C2360-i2. Dry climates are especially susceptible to ESD. It is therefore critical that whenever the IMBA-C2360-i2 or any other electrical component is handled, the following anti-static precautions are strictly adhered to.

- **Wear an anti-static wristband:** - Wearing a simple anti-static wristband can help to prevent ESD from damaging the board.
- **Self-grounding:** - Before handling the board touch any grounded conducting material. During the time the board is handled, frequently touch any conducting materials that are connected to the ground.
- **Use an anti-static pad:** When configuring the IMBA-C2360-i2, place it on an anti-static pad. This reduces the possibility of ESD damaging the IMBA-C2360-i2.
- **Only handle the edges of the PCB:-:** When handling the PCB, hold the PCB by the edges.

4.2 Installation Considerations



NOTE:

The following installation notices and installation considerations should be read and understood before installation. All installation notices must be strictly adhered to. Failing to adhere to these precautions may lead to severe damage and injury to the person performing the installation.

**WARNING:**

The installation instructions described in this manual should be carefully followed in order to prevent damage to the components and injury to the user.

Before and during the installation please **DO** the following:

- Read the user manual:
 - The user manual provides a complete description of the IMBA-C2360-i2 installation instructions and configuration options.
- Wear an electrostatic discharge cuff (ESD):
 - Electronic components are easily damaged by ESD. Wearing an ESD cuff removes ESD from the body and helps prevent ESD damage.
- Place the IMBA-C2360-i2 on an anti-static pad:
 - When installing or configuring the motherboard, place it on an anti-static pad. This helps to prevent potential ESD damage.
- Turn all power to the IMBA-C2360-i2 off:
 - When working with the IMBA-C2360-i2, make sure that it is disconnected from all power supplies and that no electricity is being fed into the system.

Before and during the installation of the IMBA-C2360-i2, **DO NOT:**

- Remove any of the stickers on the PCB board. These stickers are required for warranty validation.
- Use the product before verifying all the cables and power connectors are properly connected.
- Allow screws to come in contact with the PCB circuit, connector pins, or its components.

4.3 Socket LGA1151 CPU Installation

**WARNING:**

CPUs are expensive and sensitive components. When installing the CPU please be careful not to damage it in anyway. Make sure the CPU is installed properly and ensure the correct cooling kit is properly installed.

DO NOT touch the pins at the bottom of the CPU. When handling the CPU, only hold it on the sides.

To install the CPU, follow the steps below.

Step 1: **Disengage the load lever** by pressing the lever down and slightly outward to clear the retention tab. Fully open the lever. See **Figure 4-1**.

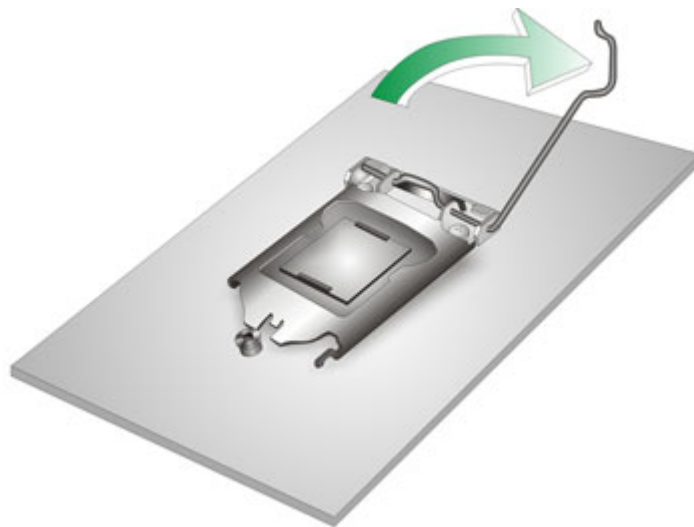

Figure 4-1: Disengage the CPU Socket Load Lever

Step 2: **Open the socket and remove the protective cover.** The black protective cover can be removed by pulling up on the tab labeled "Remove". See **Figure 4-2**.

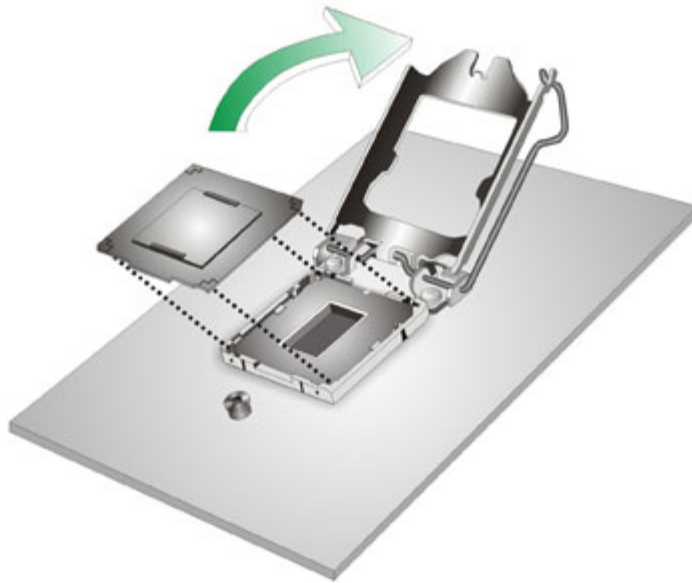

Figure 4-2: Remove Protective Cover

- Step 3: Inspect the CPU socket.** Make sure there are no bent pins and make sure the socket contacts are free of foreign material. If any debris is found, remove it with compressed air.
- Step 4: Orientate the CPU properly.** The contact array should be facing the CPU socket.



WARNING:

DO NOT touch the pins at the bottom of the CPU. When handling the CPU, only hold it on the sides.

- Step 5: Correctly position the CPU.** Match the Pin 1 mark with the cut edge on the CPU socket.
- Step 6: Align the CPU pins.** Locate pin 1 and the two orientation notches on the CPU. Carefully match the two orientation notches on the CPU with the socket alignment keys.

IMBA-C2360-i2 ATX Motherboard

Step 7: Insert the CPU. Gently insert the CPU into the socket. If the CPU pins are properly aligned, the CPU should slide into the CPU socket smoothly. See **Figure 4-3**.

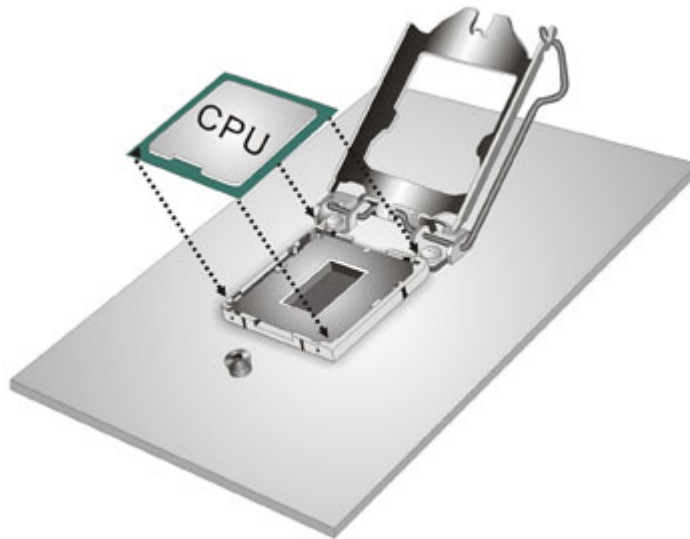

Figure 4-3: Insert the Socket LGA1151 CPU

Step 8: Close the CPU socket. Close the load plate and pull the load lever back a little to have the load plate be able to secure to the knob. Engage the load lever by pushing it back to its original position (**Figure 4-4**). There will be some resistance, but will not require extreme pressure.

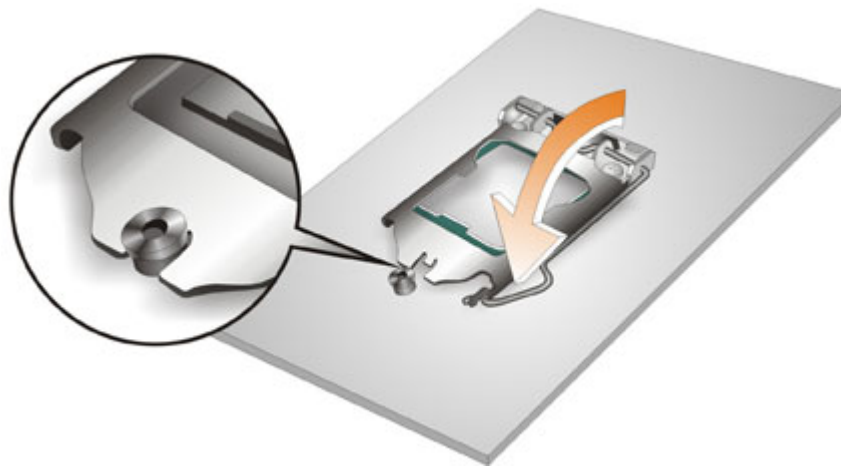

Figure 4-4: Close the Socket LGA1151

Step 9: Connect the 12 V power to the board. Connect the 12 V power from the power supply to the board.

4.4 Socket LGA1151 Cooling Kit Installation



WARNING:

DO NOT attempt to install a push-pin cooling fan.

The pre-installed support bracket prevents the board from bending and is **ONLY** compatible with captive screw type cooling fans.

The cooling kit can be bought from IEI. The cooling kit has a heat sink and fan.



WARNING:

Do not wipe off (accidentally or otherwise) the pre-sprayed layer of thermal paste on the bottom of the heat sink. The thermal paste between the CPU and the heat sink is important for optimum heat dissipation.

To install the cooling kit, follow the instructions below.

Step 1: A cooling kit bracket is pre-installed on the rear of the motherboard. See **Figure 4-5**.

IMBA-C2360-i2 ATX Motherboard

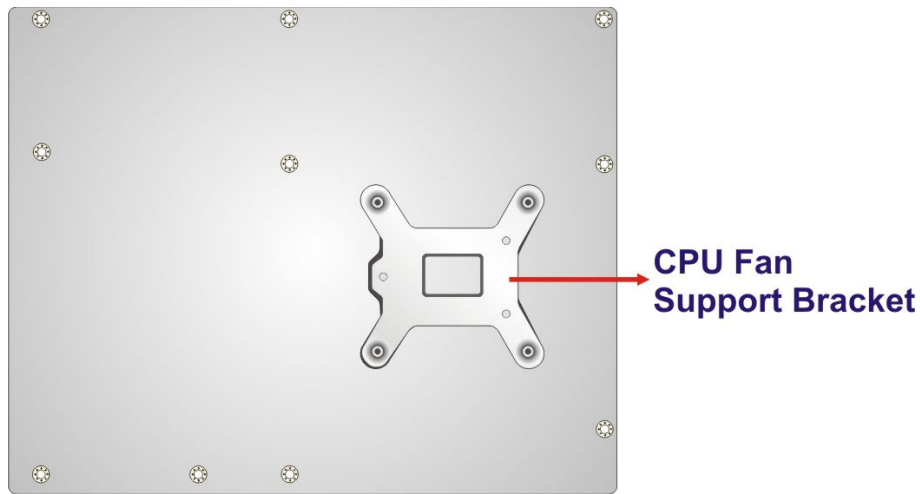

Figure 4-5: Cooling Kit Support Bracket

- Step 2:** Place the cooling kit onto the socket LGA1151 CPU. Make sure the CPU cable can be properly routed when the cooling kit is installed.
- Step 3:** Mount the cooling kit. Gently place the cooling kit on top of the CPU. Make sure the four threaded screws on the corners of the cooling kit properly pass through the holes of the cooling kit bracket.
- Step 4:** Tighten the screws. Use a screwdriver to tighten the four screws. In a diagonal pattern, tighten each screw a few turns then move to the next one, until they are all secured. Do not overtighten the screws.
- Step 5:** Connect the fan cable. Connect the cooling kit fan cable to the CPU fan connector on the IMBA-C2360-i2. Carefully route the cable and avoid heat generating chips and fan blades.

4.5 DIMM Installation

To install a DIMM, please follow the steps below and refer to **Figure 4-6**.

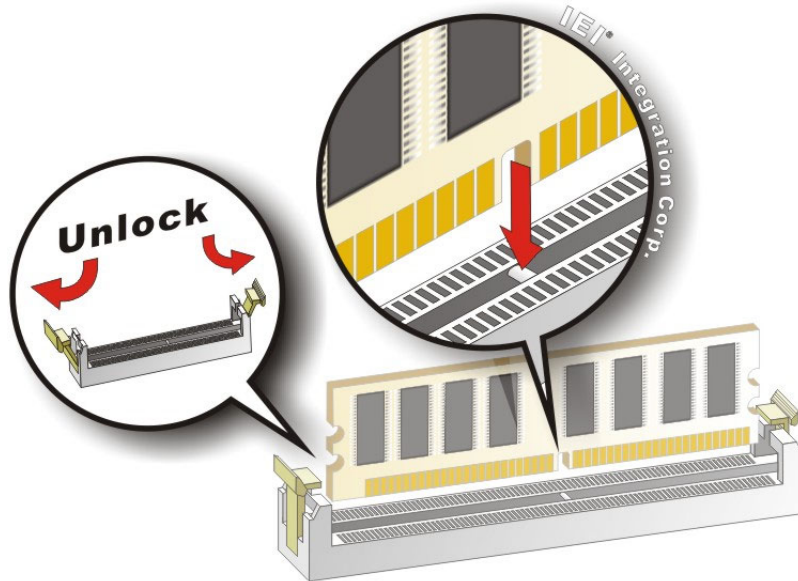

Figure 4-6: DIMM Installation

- Step 1: Open the DIMM socket handles.** Open the two handles outwards as far as they can. See **Figure 4-6**.
- Step 2: Align the DIMM with the socket.** Align the DIMM so the notch on the memory lines up with the notch on the memory socket. See **Figure 4-6**.
- Step 3: Insert the DIMM.** Once aligned, press down until the DIMM is properly seated. Clip the two handles into place. See **Figure 4-6**.
- Step 4: Removing a DIMM.** To remove a DIMM, push both handles outward. The memory module is ejected by a mechanism in the socket.

IMBA-C2360-i2 ATX Motherboard

4.6 iRIS Module Installation

**WARNING:**

The iRIS module slot is designed to install the iRIS-2400 module only. DO NOT install other modules into the iRIS module slot. Doing so may cause damage to the IMBA-C2360-i2.

To install the iRIS-2400 module, please follow the steps below and refer to **Figure 4-7**.

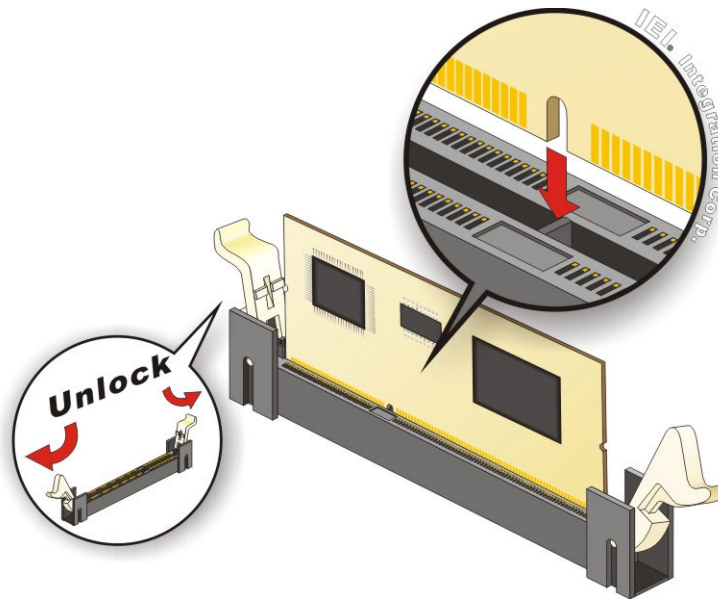

Figure 4-7: iRIS Module Installation

- Step 1:** Locate the iRIS module slot. See **Figure 3-16**.
- Step 2:** **Open the socket handles.** Open the two handles outwards as far as they can. See **Figure 4-7**.
- Step 3:** **Align the iRIS-2400 module with the socket.** Align the iRIS-2400 module so the notch on the module lines up with the notch on the socket. See **Figure 4-7**.
- Step 4:** **Insert the iRIS-2400 module.** Once aligned, press down until the iRIS-2400 module is properly seated. Clip the two handles into place. See **Figure 4-7**.

Step 5: Removing the iRIS-2400 module. To remove the iRIS-2400 module, push both handles outward. The module is ejected by a mechanism in the socket.

**NOTE:**

After installing the iRIS-2400 module, use **LAN2_USB2** port to establish a network connection. Please refer to **Section 4.15** for IPMI setup procedures.

4.7 Full-size PCIe Mini Card Installation

The PCIe Mini card slot allows installation of either a full-size or half-size PCIe Mini card. To install a full-size PCIe Mini card, please follow the steps below.

Step 1: Locate the PCIe Mini card slot. See Chapter 3.

Step 2: Remove the retention screw. Remove the retention screw as shown in Figure 4-8.

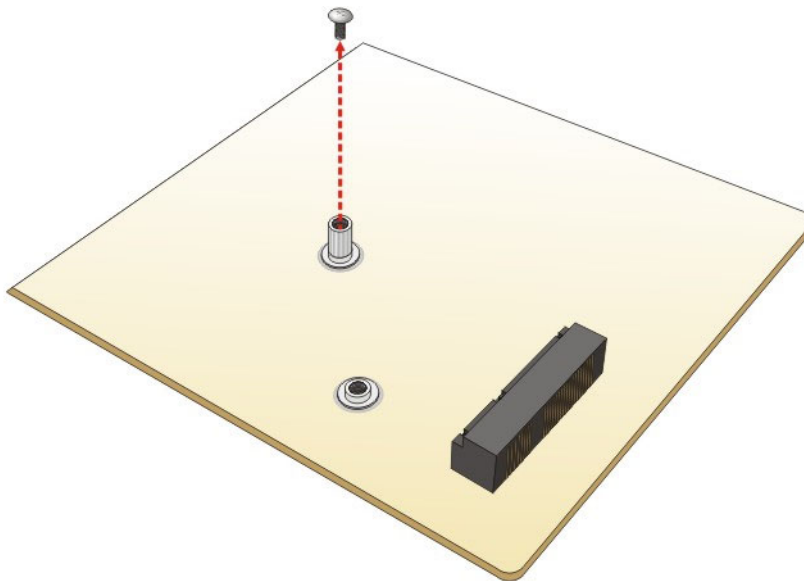

Figure 4-8: Removing the Retention Screw

IMBA-C2360-i2 ATX Motherboard

- Step 3:** Insert into the socket at an angle. Line up the notch on the card with the notch on the slot. Slide the PCIe Mini card into the socket at an angle of about 20° (Figure 4-9).

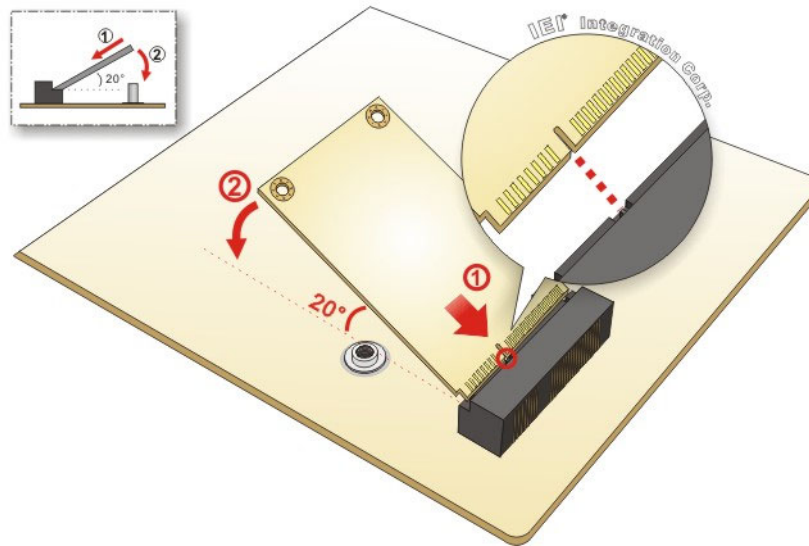

Figure 4-9: Inserting the Full-size PCIe Mini Card into the Slot at an Angle

- Step 4:** Secure the full-size PCIe Mini card. Secure the full-size PCIe Mini card with the retention screw previously removed (Figure 4-10).

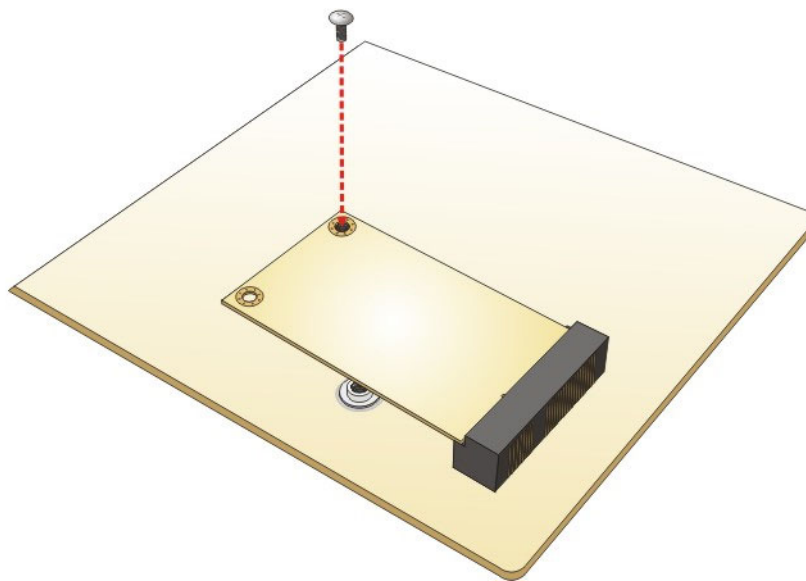

Figure 4-10: Securing the Full-size PCIe Mini Card

4.8 Half-size PCIe Mini Card Installation

The PCIe Mini card slot allows installation of either a full-size or half-size PCIe Mini card. To install a half-size PCIe Mini card, please follow the steps below.

Step 1: Locate the PCIe Mini card slot. See Chapter 3.

Step 2: Install the standoff to the screw hole for the half-size PCIe Mini card. Install the supplied standoff to the screw hole for the half-size PCIe Mini card (Figure 4-11).

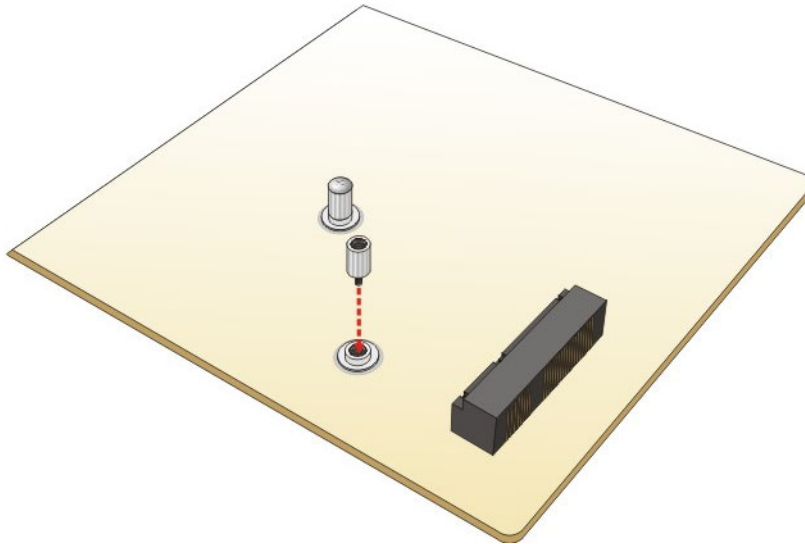

Figure 4-11: Installing the Standoff

Step 3: Insert into the socket at an angle. Line up the notch on the card with the notch on the slot. Slide the PCIe Mini card into the slot at an angle of about 20° (Figure 4-12).

IMBA-C2360-i2 ATX Motherboard

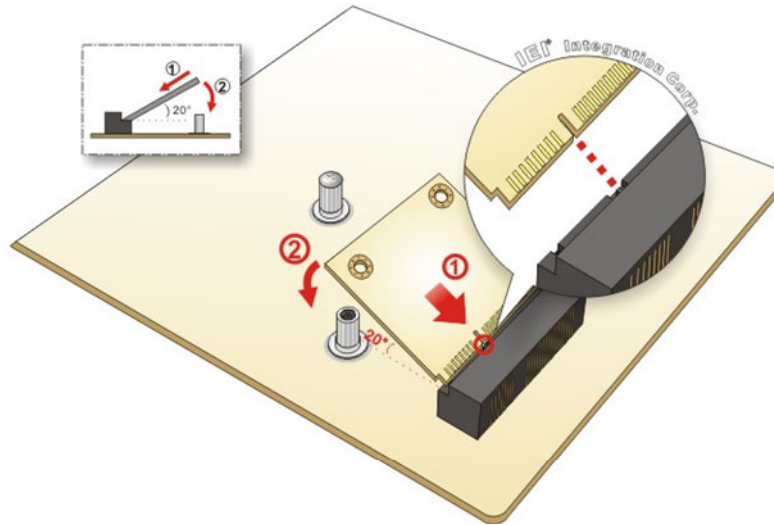

Figure 4-12: Inserting the Half-size PCIe Mini Card into the Slot at an Angle

Step 4: Secure the half-size PCIe Mini card. Secure the half-size PCIe Mini card with the supplied retention screw (Figure 4-13).

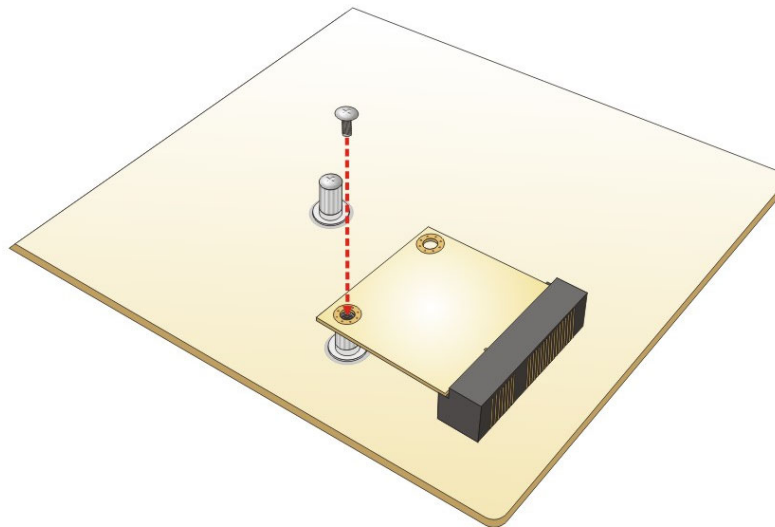

Figure 4-13: Securing the Half-size PCIe Mini Card

4.9 USB 3.0 Expansion Card Installation

IEI provides an optional USB 3.0 expansion card that allows four additional USB 3.0/2.0 devices to be connected to the motherboard. To install the expansion card, please follow the steps below.

Step 1: Install the expansion card to the **PCIEX4_2** slot on the motherboard. Align and insert the PCIe edge connector on the bottom of the expansion card to the **PCIEX4_2** slot (**Figure 4-14**) on the IMBA-C2360-i2. Then, push down gently on the expansion card to make sure it is firmly inserted into the **PCIEX4_2** slot.

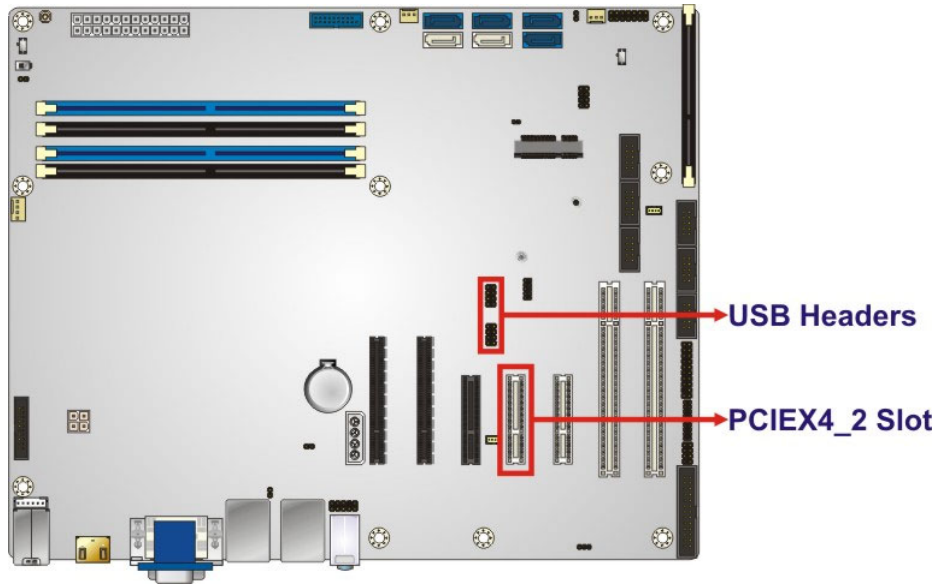

Figure 4-14: PCIEX4_2 Slot and USB Header Locations

Step 2: Connect the included USB cables to the expansion card and motherboard. Connect the two included USB cables to the USB headers (USB1 and USB2) on the expansion card and motherboard (**Figure 4-14**).

Step 3: Load the BIOS2 settings. To use the expansion card, the user has to apply the BIOS2 settings to the motherboard. Please refer to **Section 4.11.3** for details on how to switch to BIOS2 settings.

4.10 PCIe Mini and mSATA Expansion Card Installation

IEI provides an optional PCIe Mini and mSATA expansion card that allows additional PCIe Mini and mSATA cards to be installed to the motherboard. To install the expansion card, please follow the steps below.

IMBA-C2360-i2 ATX Motherboard

Step 1: Install the expansion card to the **PCIEX4_3** slot on the motherboard. Align and insert the PCIe edge connector on the bottom of the expansion card to the **PCIEX4_3** slot (**Figure 4-15**) on the IMBA-C2360-i2. Then, push down gently on the expansion card to make sure it is firmly inserted into the **PCIEX4_3** slot.

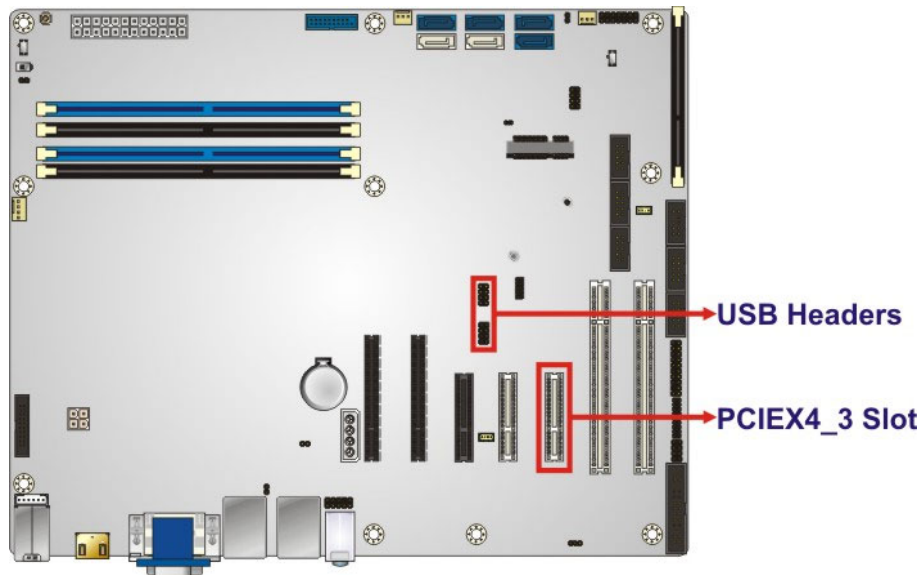

Figure 4-15: PCIEX4_3 Slot Location

Step 2: **Configure the BIOS settings.** To use the expansion card, the user has to apply the BIOS2 settings to the motherboard and configure the BIOS settings through the BIOS menu in “Chipset → PCH-IO Configuration → PCI Express Configuration”. Please refer to **Section 4.11.3** for details on how to switch to BIOS2 settings and **Section 5.4.2.1** for details on how to configure BIOS settings.



NOTE:

If a PCIe Mini card that requires USB 2.0 signal (such as a PCIe Mini to USB 2.0 adapter card) is installed on this expansion card, the included USB cable has to be connected to the USB headers on the expansion card and motherboard. However, the IMBA-C2360-i2 has only two on-board USB 2.0 headers. The user has to choose either to install the USB 3.0 expansion card or the PCIe Mini and mSATA expansion card.

4.11 System Configuration

The system configuration is controlled by jumpers, buttons, switches and BIOS options. The system configuration must be performed before installation.

4.11.1 AT/ATX Power Mode Setting

The AT and ATX power mode selection is made through the AT/ATX power mode switch which is shown in **Figure 4-16**.

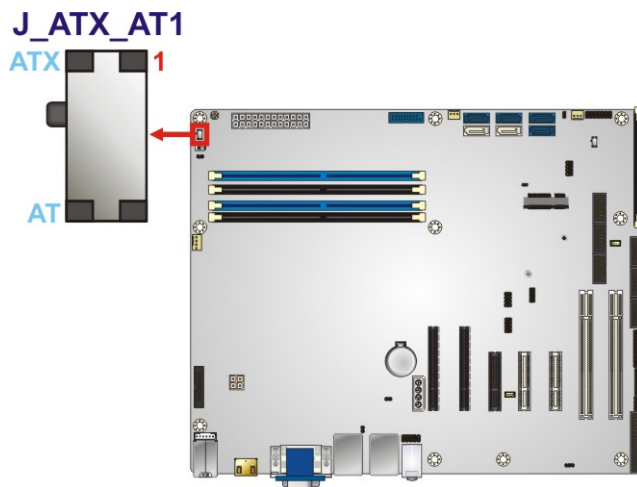

Figure 4-16: AT/ATX Power Mode Switch Location

Setting	Description
1-2	ATX power mode (default)
2-3	AT power mode

Table 4-1: AT/ATX Power Mode Switch Settings

IMBA-C2360-i2 ATX Motherboard

4.11.2 Clearing CMOS

To reset the BIOS, remove the on-board battery and press the **J_CMOS1** button for three seconds or more. In addition, the **J_CMOS2** header provides an additional clear CMOS button that can be connected to the chassis, allowing users to clear CMOS without opening the system chassis. The clear CMOS button and header locations are shown in **Figure 4-17**.



NOTE:

After switching the BIOS1 to BIOS2 or BIOS2 to BIOS1, the user has to clear the CMOS settings. Please refer to **Section 4.11.3** for how to switch BIOS settings.

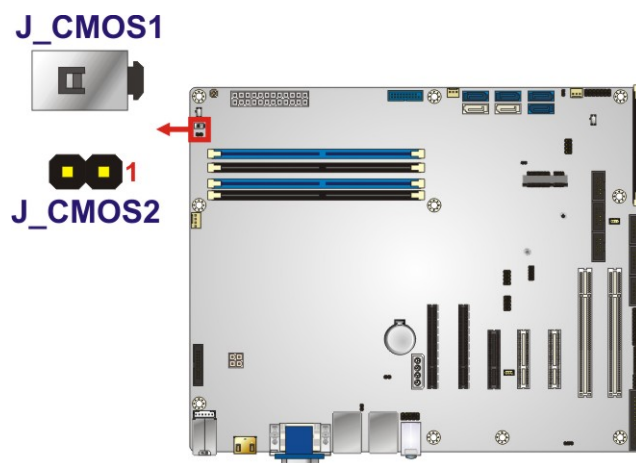

Figure 4-17: Clear CMOS Button and Header Locations

4.11.3 Switching BIOS

The IMBA-C2360-i2 equips with dual BIOS to support flexible I/O configuration. To switch BIOS1 to BIOS2 or BIOS2 to BIOS1 successfully, please follow the steps below and refer to **Figure 4-18** and **Table 4-2** for the BIOS switch location and settings.

- Step 1:** Unplug the system power cord.
- Step 2:** Switch BIOS1 to BIOS2 or BIOS2 to BIOS1 by moving the BIOS switch to BIOS1 or BIOS2 position as shown in **Figure 4-18**.
- Step 3:** Remove the on-board battery, and then reinstall it.
- Step 4:** Clear CMOS by pressing the clear CMOS button for three seconds or more.
- Step 5:** Perform the system booting.



NOTE:

The user can check which BIOS is being used from the **BIOS Number** item in the **Main BIOS menu (BIOS Menu 1)**.

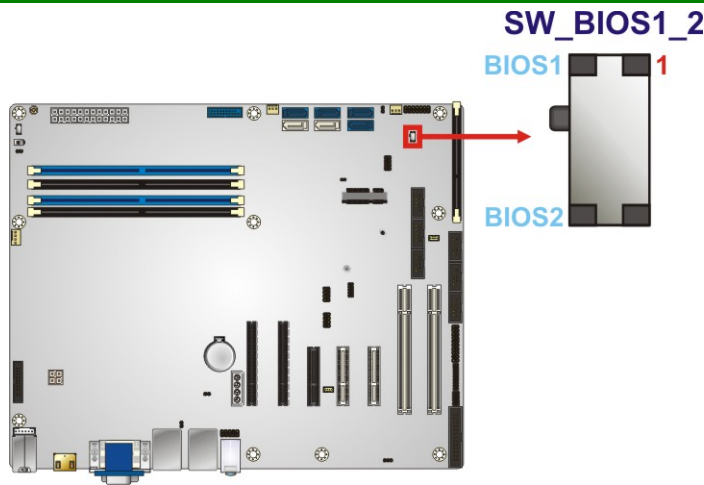

Figure 4-18: BIOS1/BIOS2 Switch Location

Setting	Description
1-2	BIOS1 (default)
2-3	BIOS2

Table 4-2: BIOS1/BIOS2 Switch Settings

IMBA-C2360-i2 ATX Motherboard

4.11.4 Flexible I/O Configuration

The optional USB 3.0 and PCIe Mini and mSATA expansion cards provide more expansion options to meet user's demand. However, the **S_ATA3** and **S_ATA4** connectors will be disabled when the **PCIEX4_3** slot is installed with the optional PCIe Mini and mSATA expansion card or a PCIe x4 expansion card. Besides, for using the optional expansion cards, the user has to apply the BIOS2 settings to the motherboard (refer to **Section 4.11.3**) and set the correct BIOS settings through the BIOS menu in "Chipset → PCH-IO Configuration → PCI Express Configuration.

The following table lists the BIOS options with correspondent I/O configuration.

BIOS	S_ATA3 and S_ATA4 Connectors		PCIEX4_2 Slot	PCIEX4_3 Slot
	S_ATA3	S_ATA4		
BIOS1 (a) (default)	S_ATA3	S_ATA4	PCIe x4 slot	x
BIOS1 (b)	x	x	PCIe x4 slot	PCIe x4 slot
BIOS2 (c)	S_ATA3	S_ATA4	USB 3.0 expansion card	PCIe x2 slot
BIOS2 (d)	x	x	USB 3.0 expansion card	PCIe Mini and mSATA expansion card

Table 4-3: Flexible I/O Configuration

Please refer to **Section 5.4.2.1** for BIOS setup.

4.11.5 Flash Descriptor Security Override Jumper

The flash descriptor security override jumper (J_FLASH1) allows to enable or disable the ME firmware update. Refer to **Table 4-4** and **Figure 4-19** for the jumper location and settings.

Setting	Description
Short 1-2	Disabled (default)
Short 2-3	Enabled

Table 4-4: Flash Descriptor Security Override Jumper Settings

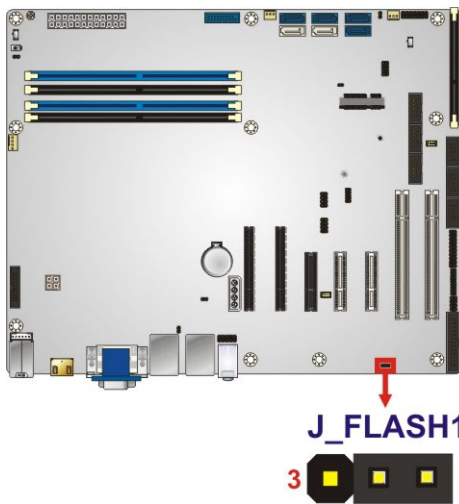

Figure 4-19: Flash Descriptor Security Override Jumper Location

To update the ME firmware, please follow the steps below.

- Step 1:** Before turning on the system power, short pin 2-3 of the flash descriptor security override jumper.
- Step 2:** Update the BIOS and ME firmware, and then turn off the system power.
- Step 3:** Remove the metal clip on the flash descriptor security override jumper or return to its default setting (short pin 1-2).
- Step 4:** Restart the system. The system will reboot 2 ~ 3 times to complete the ME firmware update.

IMBA-C2360-i2 ATX Motherboard

4.11.6 mSATA Setup

The mSATA setup jumper specifies whether to automatically detect the mSATA device installed in the PCIe Mini slot (MPCIE1). If the user shorts the mSATA setup jumper to force the system to enable mSATA device, the **S_ATA6** connector will be disabled.

Setting	Description
Open	Automatically detect mSATA device (default)
Short 1-2	Force to enable mSATA device (The S_ATA6 connector will be disabled)

Table 4-5: mSATA Setup Jumper Settings

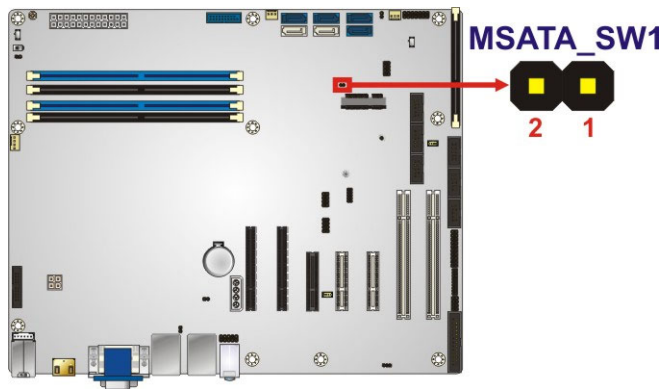

Figure 4-20: mSATA Setup Jumper Location

4.11.7 USB Power Selection

The USB power selection is made through the BIOS menu in “Chipset → PCH-IO Configuration”. Use the **USB Power SW1** and the **USB Power SW2** BIOS options to configure the correspondent USB ports (see **Table 4-6**) and refer to **Table 4-7** to select the USB power source.

BIOS Options	Configured USB Ports
USB Power SW1	K/M_USB1 (external USB 2.0 ports) LAN1_USB1 (external USB 3.0 ports) LAN2_USB2 (external USB 3.0 ports)
USB Power SW2	USB1 (internal USB 2.0 ports) USB2 (internal USB 2.0 ports) USB3-1 (internal USB 3.0 ports)

Table 4-6: BIOS Options and Configured USB Ports

Options	Description
+5V DUAL	+5V dual (default)
+5V	+5V

Table 4-7: USB Power Source Setup

Please refer to **Section 5.4.2** for BIOS setup.

4.12 Internal Peripheral Device Connections

This section outlines the installation of peripheral devices to the onboard connectors.

4.12.1 SATA Drive Connection

The IMBA-C2360-i2 is shipped with two SATA drive cables. To connect the SATA drives to the connectors, please follow the steps below.

Step 1: Locate the connectors. The locations of the SATA drive connectors are shown in **Chapter 3**.

Step 2: Insert the cable connector. Insert the cable connector into the on-board SATA drive connector until it clips into place. See **Figure 4-21**.

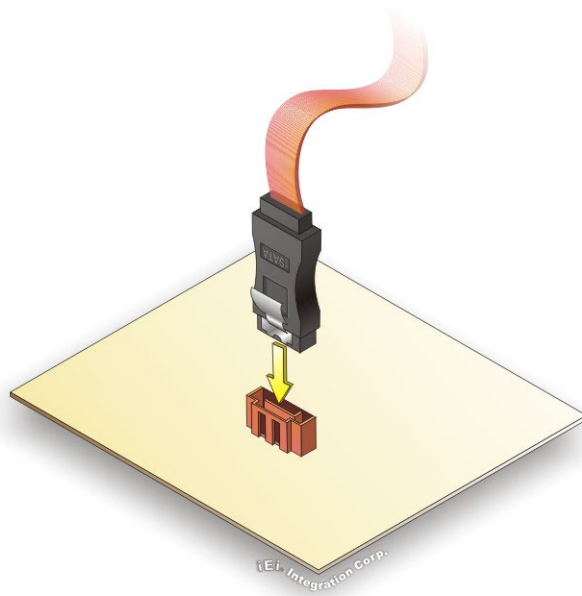

Figure 4-21: SATA Drive Cable Connection

- Step 3:** Connect the cable to the SATA disk. Connect the connector on the other end of the cable to the connector at the back of the SATA drive. See **Figure 4-22**.
- Step 4:** Connect the SATA power cable. Connect the SATA power connector to the back of the SATA drive. See **Figure 4-22**.

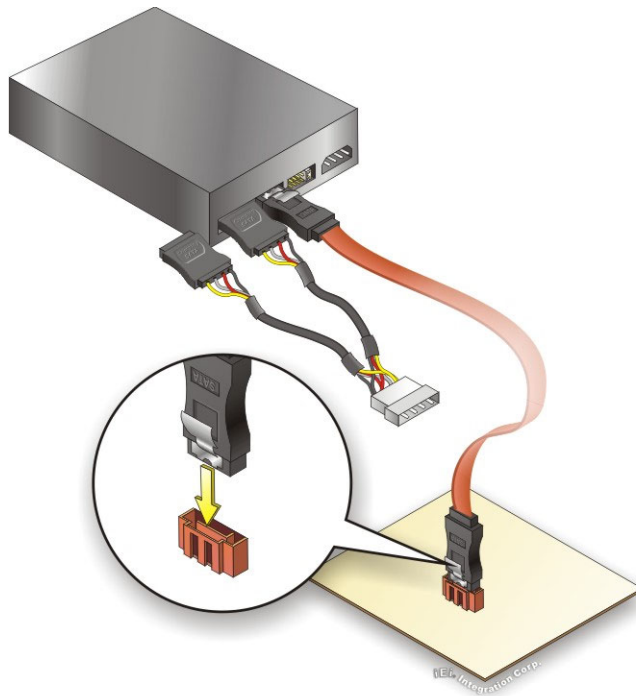

Figure 4-22: SATA Power Drive Connection

The SATA power cable can be bought from IEI. See Optional Items in Section 2.4.

4.13 Adding USB 3.0 Drivers to a Windows 7 Installation Image

The Windows 7 installation media does not include native driver support for USB 3.0. In order to use the USB keyboard or mouse connected to a USB 3.0 port during OS installation, the user has to update the Windows 7 installation image so that it contains USB 3.0 drivers. Please follow the instructions below to complete the task.

Step 1: Prepare a USB flash drive installer.

On a working computer, use your Windows 7 DVD or ISO image to create a bootable USB flash drive.

Step 2: Download the Windows 7 USB 3.0 Creator Utility from:

<https://downloadcenter.intel.com/download/25476/Windows-7-USB-3-0-Creator-Utility>.

Step 3: Extract the downloaded file to a temporary folder on a computer where the user has logged in as the administrator.

IMBA-C2360-i2 ATX Motherboard

**NOTE:**

The OS version of the computer can be Windows 7, Windows 8.1 or Windows 10.

Step 4: Connect the USB drive containing the Windows 7 installation image to the computer.

Step 5: Right click on **Installer_Creator.exe** from the extracted files and select **Run as administrator**.

Step 6: The Windows 7 USB 3.0 Creator Utility screen appears (**Figure 4-23**). Click  to browse to the root of the USB drive containing the Windows 7 image.

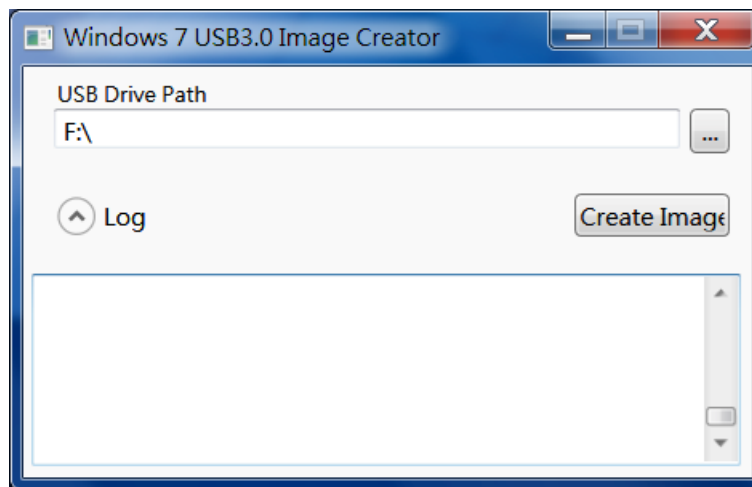

Figure 4-23: Windows 7 USB 3.0 Creator Utility

Step 7: Click **Create Image** to start the update process.

Step 8: Wait for the process to finish. It may take up to 15 minutes.

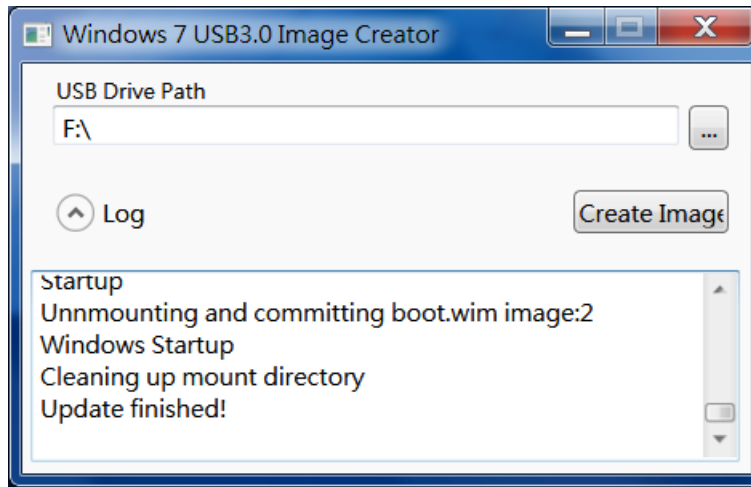

Figure 4-24: Update Process is Complete

Step 9: Now the user can proceed with the Windows 7 installation using the updated installer.

4.14 Intel® AMT Setup Procedure

The IMBA-C2360-i2 is featured with the Intel® Active Management Technology (AMT). To enable the Intel® AMT function, follow the steps below.

- Step 1:** Make sure at least one of the memory sockets is installed with a DDR4 DIMM.
- Step 2:** Connect an Ethernet cable to the RJ-45 connector labeled **LAN1_USB1**.
- Step 3:** The AMI BIOS options regarding the Intel® ME or Intel® AMT must be enabled.
- Step 4:** Properly install the Intel® Management Engine Components drivers from the iAMT Driver & Utility directory in the driver CD.
- Step 5:** Configure the Intel® Management Engine BIOS extension (MEBx). To get into the Intel® MEBx settings, press <Ctrl+P> after a single beep during boot-up process. Enter the Intel® current ME password as it requires (the Intel® default password is **admin**).

IMBA-C2360-i2 ATX Motherboard



NOTE:

To change the password, enter a new password following the strong password rule (containing at least one upper case letter, one lower case letter, one digit and one special character, and be at least eight characters).

4.15 IPMI Setup Procedure

The IMBA-C2360-i2 features Intelligent Platform Management Interface (IPMI) that helps lower the overall costs of server management by enabling users to maximize IT resources, save time and manage multiple systems. The IMBA-C2360-i2 supports IPMI 2.0 through the optional iRIS-2400 module. Follow the steps below to setup IPMI.

4.15.1 Managed System Hardware Setup

The hardware configuration of the managed system (IMBA-C2360-i2) is described below.

Step 1: Install an iRIS-2400 module to the IPMI module socket (refer to **Section 4.6**).

Step 2: Make sure at least one DDR4 DIMM is installed in one of the DIMM sockets. If multiple DIMMs are installed, all of the DIMMs must be same size, same speed and same brand to get the best performance.

Step 3: Connect an Ethernet cable to the RJ-45 connector labeled **LAN2_USB2** (**Figure 3-34**).

4.15.2 Using the IEI iMAN Web GUI

To manage a client system from a remote console using IEI iMAN Web GUI, follow the steps below.

Step 1: Obtain the IP address of the managed system. It is recommended to use the IPMI Tool on the managed system to obtain the IP address. To use IPMI Tool to obtain IP address, follow the steps below:

- a. Copy the **Ipmitool.exe** file to a bootable USB flash drive.
- b. Insert the USB flash drive to the IMBA-C2360-i2
- c. The IMBA-C2360-i2 boots from the USB flash drive
- d. Enter the following command: **ipmitool 20 30 02 01 03 00 00**
(there is a space between each two-digit number)
- e. A serial of number shows. The last four two-digit hexadecimal numbers are the IP address. Convert the hexadecimal numbers to decimal numbers.

Step 2: On the remote management console, open a web browser. Enter the managed system IP address in the web browser (**Figure 4-25**).

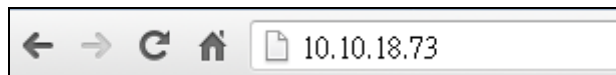

Figure 4-25: IEI iMAN Web Address

- Step 3:** The login page appears in the web browser.
- Step 4:** Enter the user name and password to login the system. The default login username and password are:
- Username: **admin**
 - Password: **admin**
- Step 5:** Press the login button to login the system.
- Step 6:** The IEI iMAN Web Interface appears.

IMBA-C2360-i2 ATX Motherboard

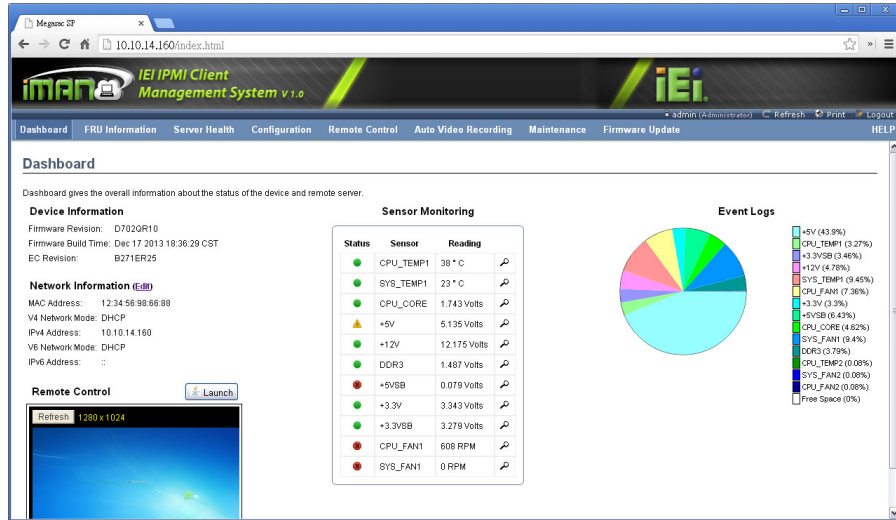

Figure 4-26: IEI iMAN Web GUI



NOTE:

To understand how to use the IEI iMAN Web GUI, please refer to the iRIS-2400 Web GUI user manual in the utility CD came with the IMBA-C2360-i2. The user manual describes each function in detail.

Chapter

5

BIOS

IMBA-C2360-i2 ATX Motherboard

5.1 Introduction

The BIOS is programmed onto the BIOS chip. The BIOS setup program allows changes to certain system settings. This chapter outlines the options that can be changed.



NOTE:

Some of the BIOS options may vary throughout the life cycle of the product and are subject to change without prior notice.

5.1.1 Starting Setup

The UEFI BIOS is activated when the computer is turned on. The setup program can be activated in one of two ways.

1. Press the **DEL** or **F2** key as soon as the system is turned on or
2. Press the **DEL** or **F2** key when the “**Press DEL or F2 to enter SETUP**” message appears on the screen.

If the message disappears before the **DEL** or **F2** key is pressed, restart the computer and try again.

5.1.2 Using Setup

Use the arrow keys to highlight items, press **ENTER** to select, use the PageUp and PageDown keys to change entries, press **F1** for help and press **ESC** to quit. Navigation keys are shown in **Table 5-1**.

Key	Function
Up arrow	Move to previous item
Down arrow	Move to next item
Left arrow	Move to the item on the left hand side
Right arrow	Move to the item on the right hand side
+	Increase the numeric value or make changes

Key	Function
-	Decrease the numeric value or make changes
Page Up	Move to the previous page
Page Dn	Move to the next page
Esc	Main Menu – Quit and not save changes into CMOS Status Page Setup Menu and Option Page Setup Menu -- Exit current page and return to Main Menu
F1	General help, only for Status Page Setup Menu and Option Page Setup Menu
F2	Load previous values
F3	Load optimized defaults
F4	Save changes and Exit BIOS

Table 5-1: BIOS Navigation Keys

5.1.3 Getting Help

When **F1** is pressed a small help window describing the appropriate keys to use and the possible selections for the highlighted item appears. To exit the Help Window, press the **Esc** key.

5.1.4 Unable to Reboot after Configuration Changes

If the computer cannot boot after changes to the system configuration is made, CMOS defaults. Use the clear CMOS button described in Chapter 4.

IMBA-C2360-i2 ATX Motherboard

5.1.5 BIOS Menu Bar

The **menu bar** on top of the BIOS screen has the following main items:

- Main – Changes the basic system configuration.
- Advanced – Changes the advanced system settings.
- Chipset – Changes the chipset settings.
- Security – Sets User and Supervisor Passwords.
- Boot – Changes the system boot configuration.
- Save & Exit – Selects exit options and loads default settings
- Server Mgmt – Configures system event log and BMC network parameters

The following sections completely describe the configuration options found in the menu items at the top of the BIOS screen and listed above.

5.2 Main

The **Main** BIOS menu (**BIOS Menu 1**) appears when the **BIOS Setup** program is entered.

The **Main** menu gives an overview of the basic system information.

Aptio Setup Utility - Copyright (C) 2016 American Megatrends, Inc.

Main | Advanced | Chipset | Security | Boot | Save & Exit | Server Mgmt

BIOS Information		Set the Date. Use Tab to switch between Date elements.
BIOS Vendor	American Megatrends	
Core Version	5.11	
Compliance	UEFI 2.4; PI 1.3	
Project Version	B400AR10.ROM	
Build Date and Time	04/27/2016 16:20:22	
BIOS Number	BIOS No.1	
iWDD Vendor	iEi	
iWDD Version	B400ER10.bin	
IPMI Module	N/A	
Processor Information		
Name	SkyLake DT	
Brand String	Intel(R) Xeon(R) E3-1268L v5 CPU @ 2.40GHz	----- →←: Select Screen ↑↓: Select Item Enter: Select +/-: Change Opt. F1: General Help F2: Previous Values F3: Optimized Defaults F4: Save & Exit ESC: Exit
Frequency	2400 MHz	
Processor ID	506E3	
Stepping	R0/S0/N0	
Number of Processors	4Core(s) / 8Thread(s)	
Microcode Revision	7C	
GT Info	GT2	
IGFX VBIOS Version	1032	
Memory RC Version	1.8.0.1	
Total Memory	4096 MB	
Memory Frequency	2133 MHz	
PCH Information		
Name	SKL PCH-H	
PCH SKU	Server SKU Intel C236	
Stepping	31/D1	
LAN PHY Revision	B2	
ME FW Version	11.0.0.1205	
ME Firmware SKU	Corporate SKU	
SPI Clock Frequency		
DOFR Support	Unsupported	
Read Status Clock Frequency	17 MHz	
Write Status Clock Frequency	48 MHz	
Fast Read Status Clock Frequency	48 MHz	
Access Level	Administrator	
System Date	[Thu 05/19/2016]	
System Time	[15:10:27]	

Version 2.17.1255. Copyright (C) 2016 American Megatrends, Inc.

BIOS Menu 1: Main

IMBA-C2360-i2 ATX Motherboard

The **Main** menu has two user configurable fields:

→ **System Date [xx/xx/xx]**

Use the **System Date** option to set the system date. Manually enter the day, month and year.

→ **System Time [xx:xx:xx]**

Use the **System Time** option to set the system time. Manually enter the hours, minutes and seconds.

5.3 Advanced

Use the **Advanced** menu (**BIOS Menu 2**) to configure the CPU and peripheral devices through the following sub-menus:



WARNING!

Setting the wrong values in the sections below may cause the system to malfunction. Make sure that the settings made are compatible with the hardware.

```

Aptio Setup Utility - Copyright (C) 2016 American Megatrends, Inc.
Main  Advanced  Chipset  Security  Boot  Save & Exit  Server Mgmt
-----
> Trusted Computing
> ACPI Settings
> AMT Configuration
> Super IO Configuration
> iWDD H/M Monitor
> RTC Wake Settings
> Serial Port Console Redirection
> CPU Configuration
> SATA Configuration
> NVMe Configuration
> USB Configuration
> iEi Feature

Trusted Computing
Settings

-----
→←: Select Screen
↑↓: Select Item
Enter: Select
+/-: Change Opt.
F1: General Help
F2: Previous Values
F3: Optimized Defaults
F4: Save & Exit
ESC: Exit

Version 2.17.1255. Copyright (C) 2016 American Megatrends, Inc.
    
```

BIOS Menu 2: Advanced

5.3.1 Trusted Computing

Use the **Trusted Computing** menu (**BIOS Menu 3**) to configure settings related to the Trusted Computing Group (TCG) Trusted Platform Module (TPM).

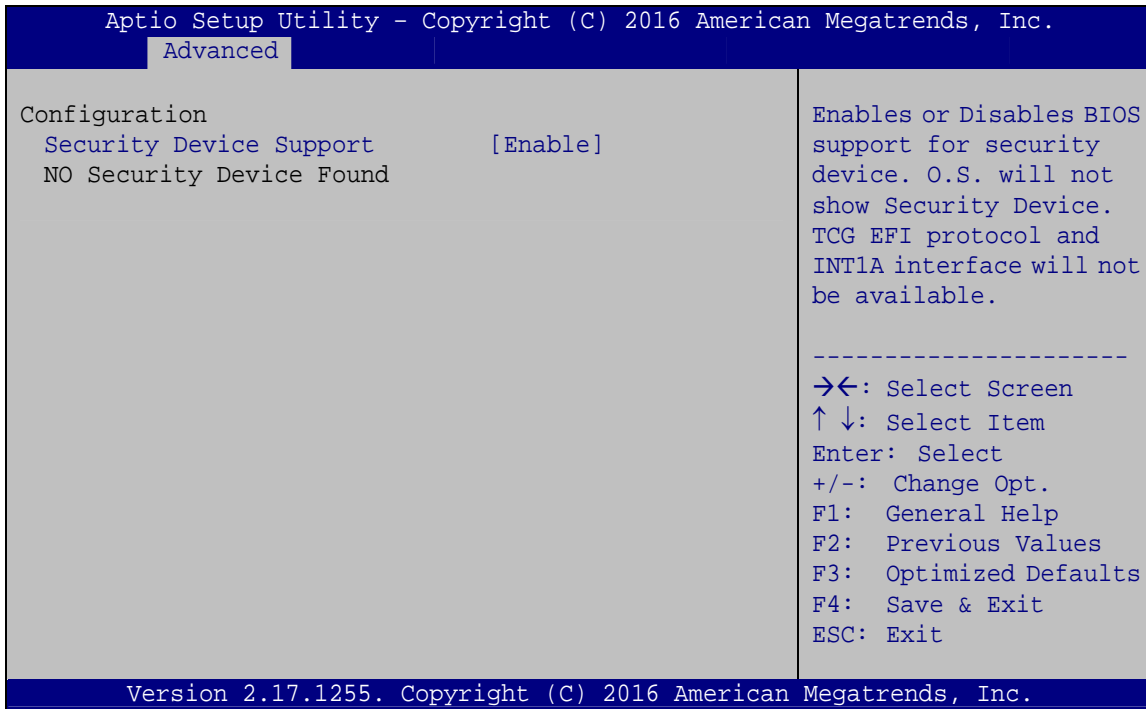

BIOS Menu 3: Trusted Computing

→ Security Device Support [Enable]

Use the **Security Device Support** option to configure support for the TPM.

- **Disable** TPM support is disabled.
- **Enable** **DEFAULT** TPM support is enabled.

IMBA-C2360-i2 ATX Motherboard

5.3.2 ACPI Settings

The **ACPI Settings** menu (**BIOS Menu 4**) configures the Advanced Configuration and Power Interface (ACPI) options.

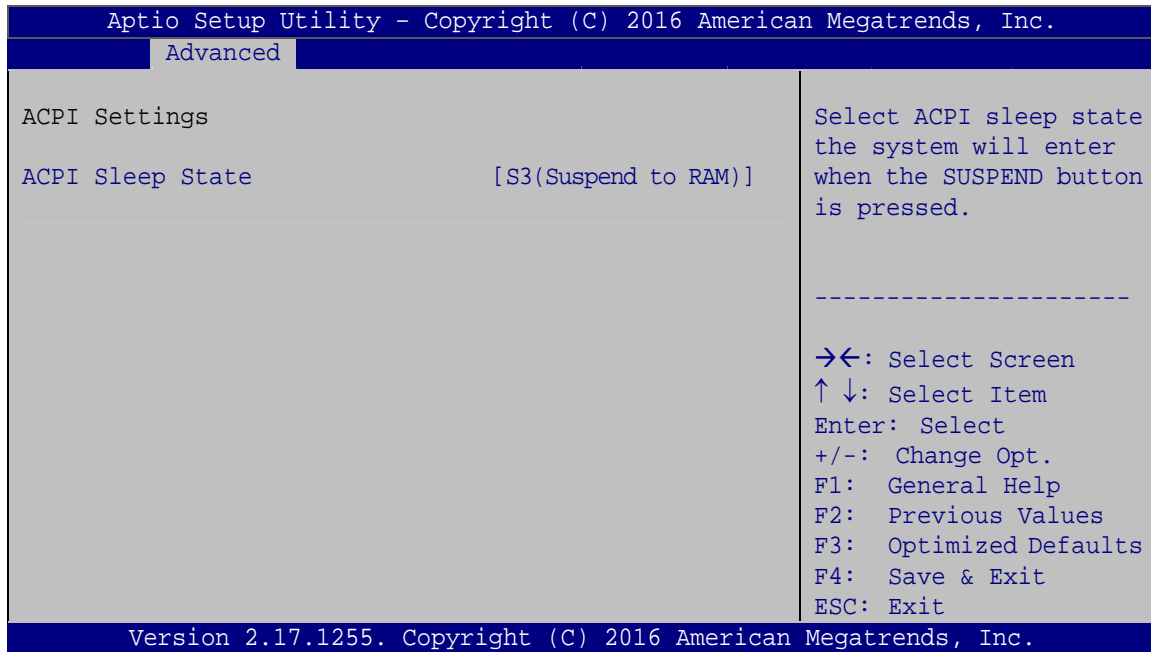

BIOS Menu 4: ACPI Configuration

→ ACPI Sleep State [S3 (Suspend to RAM)]

Use the **ACPI Sleep State** option to specify the sleep state the system enters when it is not being used.

- **S3 (Suspend to RAM)** **DEFAULT** The caches are flushed and the CPU is powered off. Power to the RAM is maintained. The computer returns slower to a working state, but more power is saved.

5.3.3 AMT Configuration

The **AMT Configuration** menu (**BIOS Menu 5**) allows the Intel® AMT options to be configured.

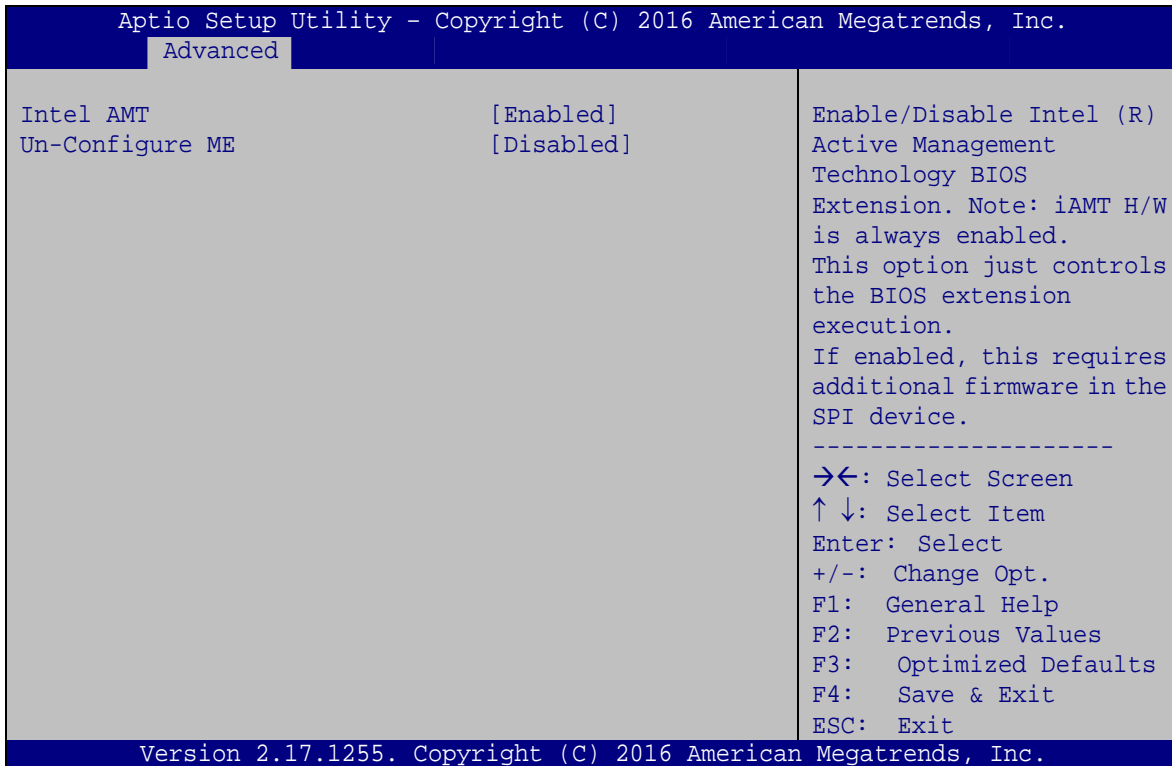

BIOS Menu 5: AMT Configuration

→ Intel AMT [Enabled]

Use **Intel AMT** option to enable or disable the Intel® AMT function.

- **Disabled** Intel® AMT is disabled
- **Enabled** **DEFAULT** Intel® AMT is enabled

→ Un-Configure ME [Disabled]

Use the **Un-Configure ME** option to perform ME unconfigure without password operation.

- **Disabled** **DEFAULT** Not perform ME unconfigure
- **Enabled** To perform ME unconfigure

IMBA-C2360-i2 ATX Motherboard

5.3.4 Super IO Configuration

Use the **Super IO Configuration** menu (**BIOS Menu 6**) to set or change the configurations for the parallel ports and serial ports.

```

Aptio Setup Utility - Copyright (C) 2016 American Megatrends, Inc.
  Advanced
-----
Super IO Configuration
Super IO Chip                F81866
> Serial Port 1 Configuration
> Serial Port 2 Configuration
> Serial Port 3 Configuration
> Serial Port 4 Configuration
> Serial Port 5 Configuration
> Serial Port 6 Configuration
> Parallel Port Configuration

Case Open Beep                [Disabled]

Set Parameters of Serial
Port 1 (COMA)
-----
-><: Select Screen
↑↓: Select Item
Enter: Select
+/-: Change Opt.
F1: General Help
F2: Previous Values
F3: Optimized Defaults
F4: Save & Exit
ESC: Exit

Version 2.17.1255. Copyright (C) 2016 American Megatrends, Inc.
  
```

BIOS Menu 6: Super IO Configuration

→ Case Open Beep [Disabled]

Use the **Case Open Beep** option to enable or disable the case open beep function.

- **Disabled** **DEFAULT** Disable the case open beep function
- **Enabled** Enable the case open beep function

5.3.4.1 Serial Port n Configuration

Use the **Serial Port n Configuration** menu (**BIOS Menu 7**) to configure the serial port n.

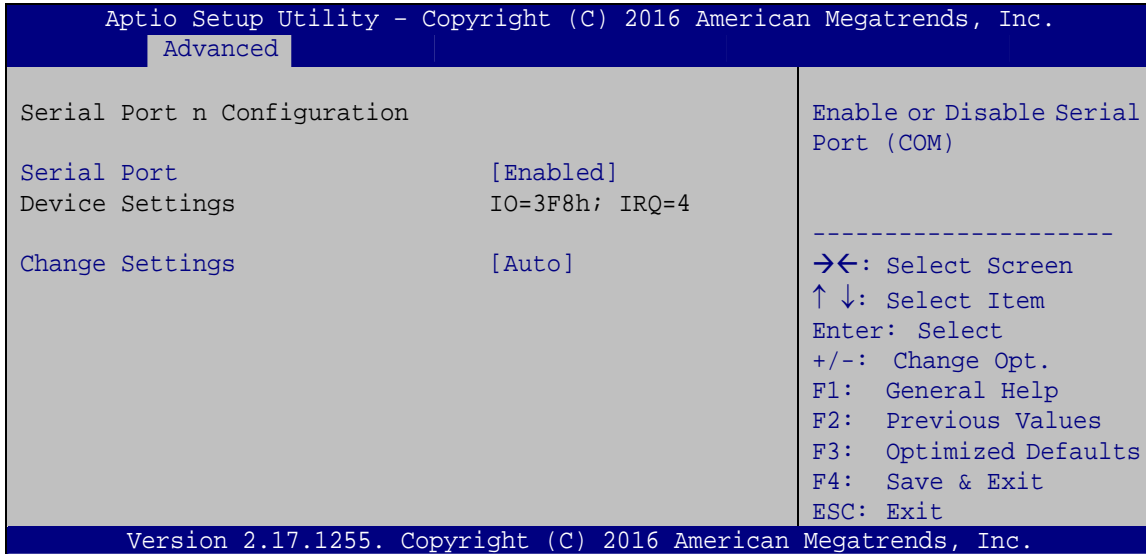

BIOS Menu 7: Serial Port n Configuration Menu

5.3.4.2 Serial Port 1 Configuration

→ Serial Port [Enabled]

Use the **Serial Port** option to enable or disable the serial port.

- **Disabled** Disable the serial port
- **Enabled DEFAULT** Enable the serial port

→ Change Settings [Auto]

Use the **Change Settings** option to change the serial port IO port address and interrupt address.

- **Auto DEFAULT** The serial port IO port address and interrupt address are automatically detected.
- **IO=3F8h; Serial Port I/O port address is 3F8h and the interrupt
IRQ=4 address is IRQ4**

IMBA-C2360-i2 ATX Motherboard

- **IO=3F8h;**
IRQ=3, 4, 11 Serial Port I/O port address is 3F8h and the interrupt address is IRQ3, 4, 11
- **IO=2F8h;**
IRQ=3, 4, 11 Serial Port I/O port address is 2F8h and the interrupt address is IRQ3, 4, 11
- **IO=3E8h;**
IRQ=3, 4, 11 Serial Port I/O port address is 3E8h and the interrupt address is IRQ3, 4, 11
- **IO=2E8h;**
IRQ=3, 4, 11 Serial Port I/O port address is 2E8h and the interrupt address is IRQ3, 4, 11
- **IO=2D0h;**
IRQ=3, 4, 11 Serial Port I/O port address is 2D0h and the interrupt address is IRQ3, 4, 11
- **IO=2E0h;**
IRQ=3, 4, 11 Serial Port I/O port address is 2E0h and the interrupt address is IRQ3, 4, 11

5.3.4.3 Serial Port 2 Configuration

→ Serial Port [Enabled]

Use the **Serial Port** option to enable or disable the serial port.

- **Disabled** Disable the serial port
- **Enabled** **DEFAULT** Enable the serial port

→ Change Settings [Auto]

Use the **Change Settings** option to change the serial port IO port address and interrupt address.

- **Auto** **DEFAULT** The serial port IO port address and interrupt address are automatically detected.
- **IO=2F8h;**
IRQ=3 Serial Port I/O port address is 2F8h and the interrupt address is IRQ3

- **IO=3F8h;**
IRQ=3, 4, 11 Serial Port I/O port address is 3F8h and the interrupt address is IRQ3, 4, 11
- **IO=2F8h;**
IRQ=3, 4, 11 Serial Port I/O port address is 2F8h and the interrupt address is IRQ3, 4, 11
- **IO=3E8h;**
IRQ=3, 4, 11 Serial Port I/O port address is 3E8h and the interrupt address is IRQ3, 4, 11
- **IO=2E8h;**
IRQ=3, 4, 11 Serial Port I/O port address is 2E8h and the interrupt address is IRQ3, 4, 11
- **IO=2D0h;**
IRQ=3, 4, 11 Serial Port I/O port address is 2D0h and the interrupt address is IRQ3, 4, 11
- **IO=2E0h;**
IRQ=3, 4, 11 Serial Port I/O port address is 2E0h and the interrupt address is IRQ3, 4, 11

5.3.4.4 Serial Port 3 Configuration

→ Serial Port [Enabled]

Use the **Serial Port** option to enable or disable the serial port.

- **Disabled** Disable the serial port
- **Enabled** **DEFAULT** Enable the serial port

→ Change Settings [Auto]

Use the **Change Settings** option to change the serial port IO port address and interrupt address.

- **Auto** **DEFAULT** The serial port IO port address and interrupt address are automatically detected.
- **IO=3E8h;**
IRQ=11 Serial Port I/O port address is 3E8h and the interrupt address is IRQ11
- **IO=3F8h;**
IRQ=3, 4, 11 Serial Port I/O port address is 3F8h and the interrupt address is IRQ3, 4, 11

IMBA-C2360-i2 ATX Motherboard

- **IO=2F8h;**
IRQ=3, 4, 11 Serial Port I/O port address is 2F8h and the interrupt address is IRQ3, 4, 11
- **IO=3E8h;**
IRQ=3, 4, 11 Serial Port I/O port address is 3E8h and the interrupt address is IRQ3, 4, 11
- **IO=2E8h;**
IRQ=3, 4, 11 Serial Port I/O port address is 2E8h and the interrupt address is IRQ3, 4, 11
- **IO=2D0h;**
IRQ=3, 4, 11 Serial Port I/O port address is 2D0h and the interrupt address is IRQ3, 4, 11
- **IO=2E0h;**
IRQ=3, 4, 11 Serial Port I/O port address is 2E0h and the interrupt address is IRQ3, 4, 11

5.3.4.4.1 Serial Port 4 Configuration

→ Serial Port [Enabled]

Use the **Serial Port** option to enable or disable the serial port.

- **Disabled** Disable the serial port
- **Enabled** **DEFAULT** Enable the serial port

→ Change Settings [Auto]

Use the **Change Settings** option to change the serial port IO port address and interrupt address.

- **Auto** **DEFAULT** The serial port IO port address and interrupt address are automatically detected.
- **IO=2E8h;**
IRQ=11 Serial Port I/O port address is 2E8h and the interrupt address is IRQ11
- **IO=3F8h;**
IRQ=3, 4, 11 Serial Port I/O port address is 3F8h and the interrupt address is IRQ3, 4, 11
- **IO=2F8h;**
IRQ=3, 4, 11 Serial Port I/O port address is 2F8h and the interrupt address is IRQ3, 4, 11

- **IO=3E8h;**
IRQ=3, 4, 11 Serial Port I/O port address is 3E8h and the interrupt address is IRQ3, 4, 11
- **IO=2E8h;**
IRQ=3, 4, 11 Serial Port I/O port address is 2E8h and the interrupt address is IRQ3, 4, 11
- **IO=2D0h;**
IRQ=3, 4, 11 Serial Port I/O port address is 2D0h and the interrupt address is IRQ3, 4, 11
- **IO=2E0h;**
IRQ=3, 4, 11 Serial Port I/O port address is 2E0h and the interrupt address is IRQ3, 4, 11

5.3.4.4.2 Serial Port 5 Configuration

→ Serial Port [Enabled]

Use the **Serial Port** option to enable or disable the serial port.

- **Disabled** Disable the serial port
- **Enabled** **DEFAULT** Enable the serial port

→ Change Settings [Auto]

Use the **Change Settings** option to change the serial port IO port address and interrupt address.

- **Auto** **DEFAULT** The serial port IO port address and interrupt address are automatically detected.
- **IO=2D0h;**
IRQ=11 Serial Port I/O port address is 2D0h and the interrupt address is IRQ11
- **IO=3F8h;**
IRQ=3, 4, 11 Serial Port I/O port address is 3F8h and the interrupt address is IRQ3, 4, 11
- **IO=2F8h;**
IRQ=3, 4, 11 Serial Port I/O port address is 2F8h and the interrupt address is IRQ3, 4, 11
- **IO=3E8h;**
IRQ=3, 4, 11 Serial Port I/O port address is 3E8h and the interrupt address is IRQ3, 4, 11

IMBA-C2360-i2 ATX Motherboard

- **IO=2E8h;**
IRQ=3, 4, 11 Serial Port I/O port address is 2E8h and the interrupt address is IRQ3, 4, 11
- **IO=2D0h;**
IRQ=3, 4, 11 Serial Port I/O port address is 2D0h and the interrupt address is IRQ3, 4, 11
- **IO=2E0h;**
IRQ=3, 4, 11 Serial Port I/O port address is 2E0h and the interrupt address is IRQ3, 4, 11

→ Transfer Mode [RS232]

The serial port 5 allows setting the data transfer mode to RS-232, RS-422 or RS-485.

5.3.4.4.3 Serial Port 6 Configuration

→ Serial Port [Enabled]

Use the **Serial Port** option to enable or disable the serial port.

- **Disabled** Disable the serial port
- **Enabled** **DEFAULT** Enable the serial port

→ Change Settings [Auto]

Use the **Change Settings** option to change the serial port IO port address and interrupt address.

- **Auto** **DEFAULT** The serial port IO port address and interrupt address are automatically detected.
- **IO=2E0h;**
IRQ=11 Serial Port I/O port address is 2E0h and the interrupt address is IRQ11
- **IO=3F8h;**
IRQ=3, 4, 11 Serial Port I/O port address is 3F8h and the interrupt address is IRQ3, 4, 11
- **IO=2F8h;**
IRQ=3, 4, 11 Serial Port I/O port address is 2F8h and the interrupt address is IRQ3, 4, 11
- **IO=3E8h;**
IRQ=3, 4, 11 Serial Port I/O port address is 3E8h and the interrupt address is IRQ3, 4, 11

- ➔ **IO=2E8h;** Serial Port I/O port address is 2E8h and the interrupt address is IRQ3, 4, 11
 IRQ=3, 4, 11
- ➔ **IO=2D0h;** Serial Port I/O port address is 2D0h and the interrupt address is IRQ3, 4, 11
 IRQ=3, 4, 11
- ➔ **IO=2E0h;** Serial Port I/O port address is 2E0h and the interrupt address is IRQ3, 4, 11
 IRQ=3, 4, 11

➔ Transfer Mode [RS232]

The serial port 6 allows setting the data transfer mode to RS-232, RS-422 or RS-485.

5.3.4.5 Parallel Port Configuration

Use the **Parallel Port Configuration** menu (**BIOS Menu 8**) to configure the parallel port.

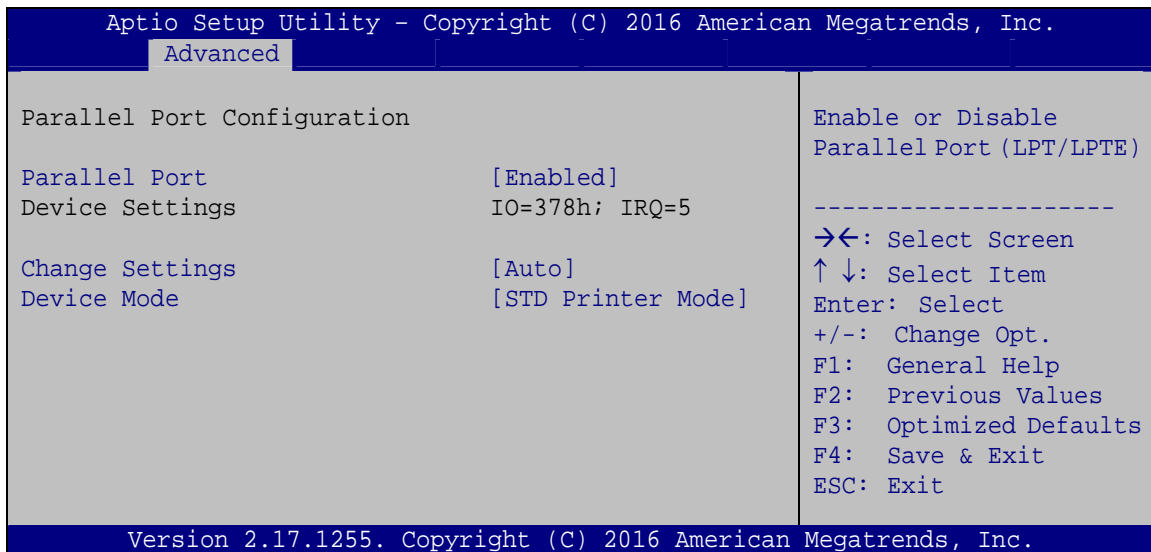

BIOS Menu 8: Parallel Port Configuration Menu

➔ Parallel Port [Enabled]

Use the **Parallel Port** option to enable or disable the parallel port.

- ➔ **Disabled** Disable the parallel port
- ➔ **Enabled** **DEFAULT** Enable the parallel port

IMBA-C2360-i2 ATX Motherboard

→ Change Settings [Auto]

Use the **Change Settings** option to change the parallel port IO port address and interrupt address.

- | | | | |
|---|--|----------------|---|
| → | Auto | DEFAULT | The parallel port IO port address and interrupt address are automatically detected. |
| → | IO=378h;
IRQ=5 | | Parallel Port I/O port address is 378h and the interrupt address is IRQ5 |
| → | IO=378h;
IRQ=5, 6, 7,
9, 10, 11, 12 | | Parallel Port I/O port address is 378h and the interrupt address is IRQ5, 6, 7, 9, 10, 11, 12 |
| → | IO=278h;
IRQ=5, 6, 7,
9, 10, 11, 12 | | Parallel Port I/O port address is 278h and the interrupt address is IRQ5, 6, 7, 9, 10, 11, 12 |
| → | IO=3BCh;
IRQ=5, 6, 7,
9, 10, 11, 12 | | Parallel Port I/O port address is 3BCh and the interrupt address is IRQ5, 6, 7, 9, 10, 11, 12 |
| → | IO=378h | | Parallel Port I/O port address is 378h |
| → | IO=278h | | Parallel Port I/O port address is 278h |
| → | IO=3BCh | | Parallel Port I/O port address is 3BCh |

→ Device Mode [STD Printer Mode]

Use the **Device Mode** option to select the mode the parallel port operates in. Configuration options are listed below.

- | | | |
|---|----------------------|----------------|
| ▪ | STD Printer Mode | Default |
| ▪ | SPP Mode | |
| ▪ | EPP-1.9 and SPP Mode | |
| ▪ | EPP-1.7 and SPP Mode | |
| ▪ | ECP Mode | |
| ▪ | ECP and EPP 1.9 Mode | |
| ▪ | ECP and EPP 1.7 Mode | |

5.3.5 iWDD H/W Monitor

The **iWDD H/W Monitor** menu (**BIOS Menu 9**) contains the fan configuration submenu, and displays the system temperature and CPU fan speed.

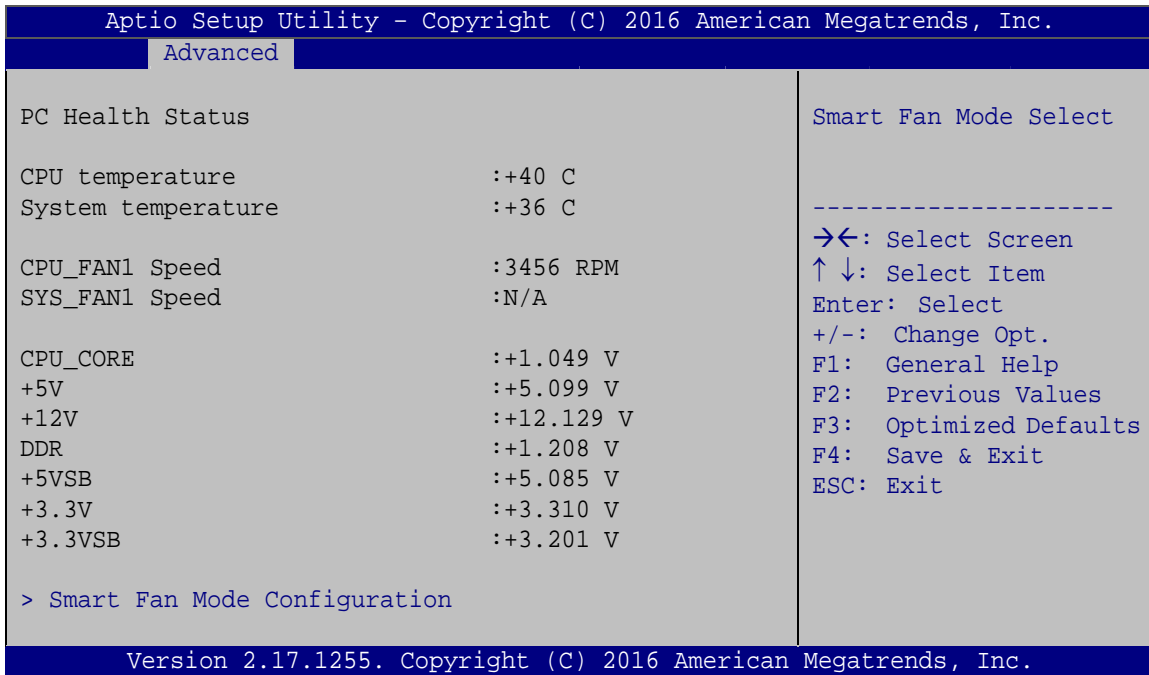

BIOS Menu 9: iWDD H/W Monitor

→ PC Health Status

The following system parameters and values are shown. The system parameters that are monitored are:

- System Temperatures:
 - CPU Temperature
 - System Temperature
- Fan Speeds:
 - CPU Fan Speed
 - System Fan 1 Speed
- Voltages:
 - CPU_CORE
 - +5V

IMBA-C2360-i2 ATX Motherboard

- +12V
- DDR
- +5VSB
- +3.3V
- +3.3VSB

5.3.5.1 Smart Fan Mode Configuration

Use the **Smart Fan Mode Configuration** submenu (**BIOS Menu 10**) to configure the CPU/system fan temperature and speed settings.

```

Aptio Setup Utility - Copyright (C) 2016 American Megatrends, Inc.
-----
Advanced
-----
Smart Fan Mode Configuration
CPU_FAN1 Smart Fan Control      [Auto Mode]
Auto mode fan start temperature 50
Auto mode fan off temperature  40
Auto mode fan start PWM        30
Auto mode fan slope PWM        1
SYS_FAN1 Smart Fan Control      [Auto Mode]
Auto mode fan start temperature 50
Auto mode fan off temperature  40
Auto mode fan start PWM        30
Auto mode fan slope PWM        1

Smart Fan Mode Select
-----
-><: Select Screen
↑↓: Select Item
Enter: Select
+/-: Change Opt.
F1: General Help
F2: Previous Values
F3: Optimized Defaults
F4: Save & Exit
ESC: Exit

Version 2.17.1255. Copyright (C) 2016 American Megatrends, Inc.
    
```

BIOS Menu 10: Smart Fan Mode Configuration

→ CPU_FAN1 Smart Fan Control/SYS_FAN1 Smart Fan Control [Auto Mode]

Use the **CPU_FAN1 Smart Fan Control/SYS_FAN1 Smart Fan Control** option to configure the CPU/System Smart Fan.

- **Auto Mode** **DEFAULT** The fan adjusts its speed using Auto Mode settings.
- **Manual Mode** The fan spins at the speed set in Manual Mode settings.

→ **Auto mode fan start/off temperature**

Use the + or – key to change the **Auto mode fan start/off temperature** value. Enter a decimal number between 1 and 100.

→ **Auto mode fan start PWM**

Use the + or – key to change the **Auto mode fan start PWM** value. Enter a decimal number between 1 and 100.

→ **Auto mode fan slope PWM**

Use the + or – key to change the **Auto mode fan slope PWM** value. Enter a decimal number between 1 and 64.

5.3.6 RTC Wake Settings

The **RTC Wake Settings** menu (**BIOS Menu 11**) enables the system to wake at the specified time.

```

Aptio Setup Utility - Copyright (C) 2016 American Megatrends, Inc.
  Advanced
Wake system with Fixed Time      [Disabled]
                                     Enable or disable System
                                     wake on alarm event. When
                                     enabled, System will
                                     wake on the
                                     date::hr::min::sec
                                     specified
-----
->←: Select Screen
↑↓: Select Item
Enter: Select
+/-: Change Opt.
F1: General Help
F2: Previous Values
F3: Optimized Defaults
F4: Save & Exit
ESC: Exit

Version 2.17.1255. Copyright (C) 2016 American Megatrends, Inc.
    
```

BIOS Menu 11: RTC Wake Settings

IMBA-C2360-i2 ATX Motherboard

→ Wake system with Fixed Time [Disabled]

Use the **Wake system with Fixed Time** option to enable or disable the system wake on alarm event.

→ **Disabled** **DEFAULT** The real time clock (RTC) cannot generate a wake event

→ **Enabled** If selected, the **Wake up every day** option appears allowing you to enable to disable the system to wake every day at the specified time. Besides, the following options appear with values that can be selected:

Wake up date

Wake up hour

Wake up minute

Wake up second

After setting the alarm, the computer turns itself on from a suspend state when the alarm goes off.

5.3.7 Serial Port Console Redirection

The **Serial Port Console Redirection** menu (**BIOS Menu 12**) allows the console redirection options to be configured. Console redirection allows users to maintain a system remotely by re-directing keyboard input and text output through the serial port.

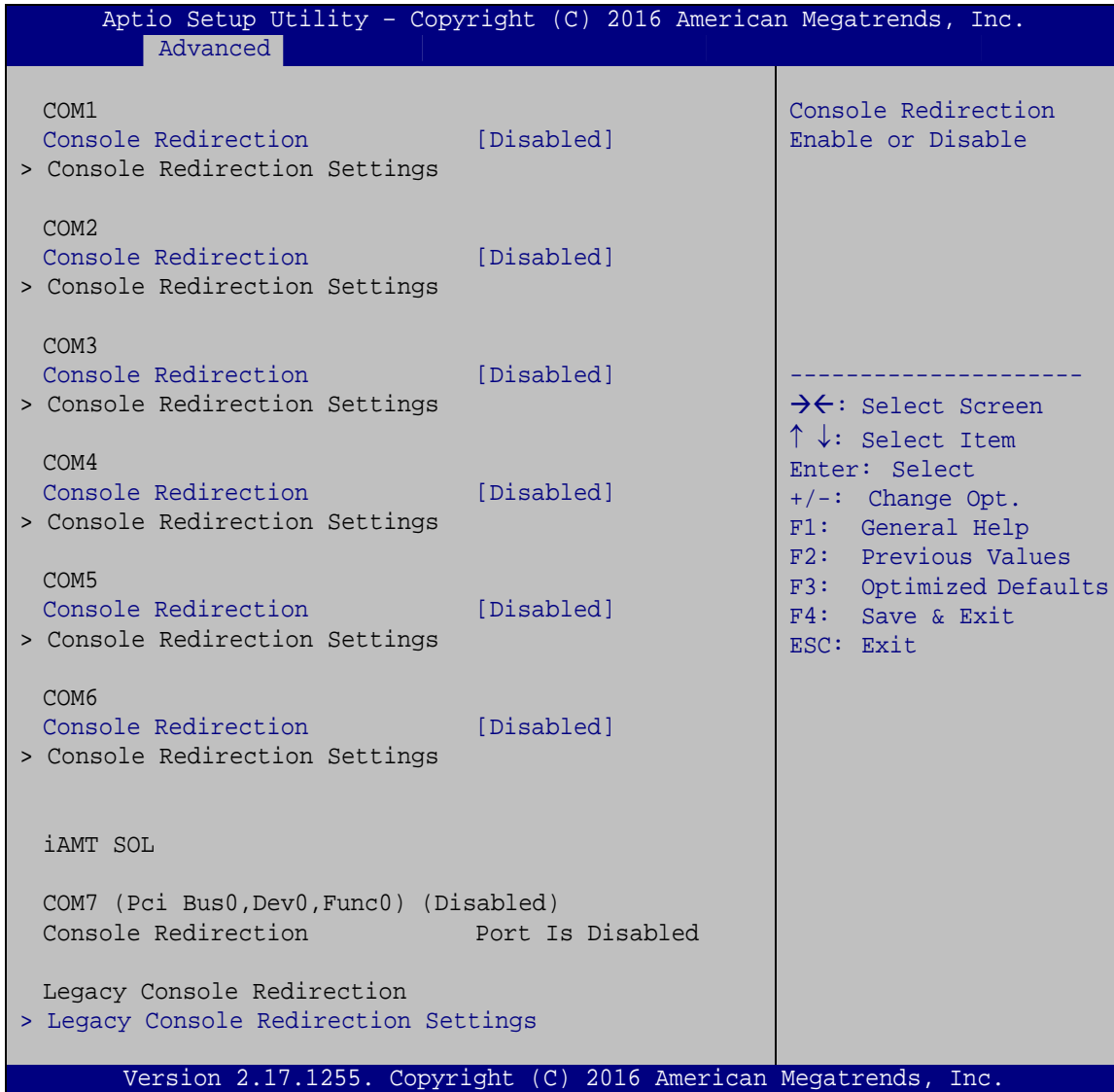

BIOS Menu 12: Serial Port Console Redirection

→ Console Redirection [Disabled]

Use **Console Redirection** option to enable or disable the console redirection function.

IMBA-C2360-i2 ATX Motherboard

- ➔ **Disabled** **DEFAULT** Disabled the console redirection function
- ➔ **Enabled** Enabled the console redirection function

The following options are available in the **Console Redirection Settings** submenu when the **Console Redirection** option is enabled.

➔ **Terminal Type [ANSI]**

Use the **Terminal Type** option to specify the remote terminal type.

- ➔ **VT100** The target terminal type is VT100
- ➔ **VT100+** The target terminal type is VT100+
- ➔ **VT-UTF8** The target terminal type is VT-UTF8
- ➔ **ANSI** **DEFAULT** The target terminal type is ANSI

➔ **Bits per second [115200]**

Use the **Bits per second** option to specify the serial port transmission speed. The speed must match the other side. Long or noisy lines may require lower speeds.

- ➔ **9600** Sets the serial port transmission speed at 9600.
- ➔ **19200** Sets the serial port transmission speed at 19200.
- ➔ **57600** Sets the serial port transmission speed at 57600.
- ➔ **115200** **DEFAULT** Sets the serial port transmission speed at 115200.

➔ **Data Bits [8]**

Use the **Data Bits** option to specify the number of data bits.

- ➔ **7** Sets the data bits at 7.
- ➔ **8** **DEFAULT** Sets the data bits at 8.

→ Parity [None]

Use the **Parity** option to specify the parity bit that can be sent with the data bits for detecting the transmission errors.

- | | | |
|----------------|----------------|---|
| → None | DEFAULT | No parity bit is sent with the data bits. |
| → Even | | The parity bit is 0 if the number of ones in the data bits is even. |
| → Odd | | The parity bit is 0 if the number of ones in the data bits is odd. |
| → Mark | | The parity bit is always 1. This option does not provide error detection. |
| → Space | | The parity bit is always 0. This option does not provide error detection. |

→ Stop Bits [1]

Use the **Stop Bits** option to specify the number of stop bits used to indicate the end of a serial data packet. Communication with slow devices may require more than 1 stop bit.

- | | | |
|------------|----------------|------------------------------------|
| → 1 | DEFAULT | Sets the number of stop bits at 1. |
| → 2 | | Sets the number of stop bits at 2. |

IMBA-C2360-i2 ATX Motherboard

5.3.7.1 Legacy Console Redirection Settings

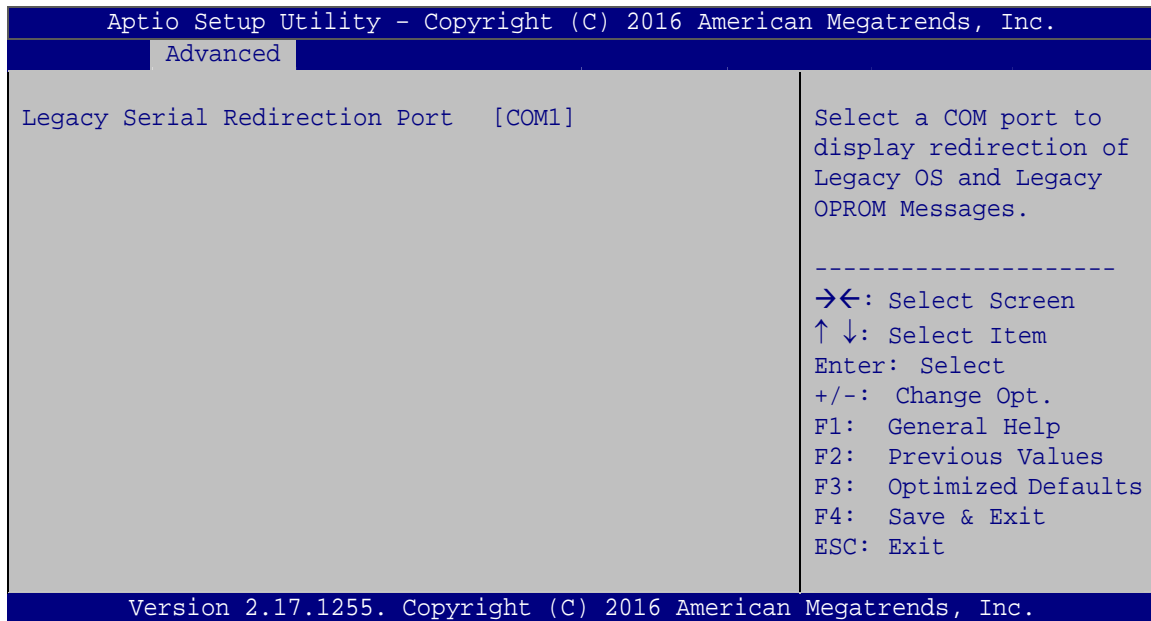

BIOS Menu 13: Legacy Console Redirection Settings

→ Legacy Serial Redirection Port [COM1]

Use the **Legacy Serial Redirection Port** option to select a COM port to display redirection of legacy OS and legacy OPRM messages. Configuration options are listed below.

- COM1 **Default**
- COM2
- COM3
- COM4
- COM5
- COM6
- COM7 (Pci Bus0,Dev0,Func0) (Disabled)

5.3.8 CPU Configuration

Use the **CPU Configuration** menu (**BIOS Menu 14**) to view detailed CPU specifications or enable the Intel Virtualization Technology.

```

Aptio Setup Utility - Copyright (C) 2016 American Megatrends, Inc.
  Advanced
CPU Configuration
Intel(R) Xeon(R) E3-1268L v5 CPU @ 2.40GHz
CPU Signature          506E3
Microcode Patch       7C
Max CPU Speed         2400 MHz
Min CPU Speed         800 MHz
CPU Speed             2400 MHz
Processor Cores       4
Hyper Threading Technology Supported
Intel VT-x Technology Supported
Intel SMX Technology  Supported
64-bit                Supported
EIST Technology       Supported

L1 Data Cache        32 kB x 4
L1 Code Cache        32 kB x 4
L2 Cache             256 kB x 4
L3 Cache             8 MB

Hyper-threading      [Enabled]
Active Processor Cores [All]
Intel Virtualization Technology [Disabled]
Intel(R) SpeedStep(tm) [Enabled]

-----
-><: Select Screen
↑↓: Select Item
Enter: Select
+/-: Change Opt.
F1: General Help
F2: Previous Values
F3: Optimized Defaults
F4: Save & Exit
ESC: Exit

Version 2.17.1255. Copyright (C) 2016 American Megatrends, Inc.
  
```

BIOS Menu 14: CPU Configuration

→ Hyper-threading [Enabled]

Use the **Hyper-threading** BIOS option to enable or disable the Intel Hyper-Threading Technology.

- **Disabled** Disables the Intel Hyper-Threading Technology.
- **Enabled** **DEFAULT** Enables the Intel Hyper-Threading Technology.

IMBA-C2360-i2 ATX Motherboard

→ Active Processor Cores [All]

Use the **Active Processor Cores** BIOS option to enable numbers of cores in the processor package.

- **All** **DEFAULT** Enable all cores in the processor package.
- **1** Enable one core in the processor package.

→ Intel Virtualization Technology [Disabled]

Use the **Intel Virtualization Technology** option to enable or disable virtualization on the system. When combined with third party software, Intel® Virtualization technology allows several OSs to run on the same system at the same time.

- **Disabled** **DEFAULT** Disables Intel Virtualization Technology.
- **Enabled** Enables Intel Virtualization Technology.

→ Intel(R) SpeedStep(tm) [Enabled]

Use the **Intel(R) SpeedStep(tm)** option to enable or disable the Intel® SpeedStep Technology which allows more than two frequency ranges to be supported.

- **Disabled** Disables Intel® SpeedStep Technology
- **Enabled** **DEFAULT** Enables Intel® SpeedStep Technology

5.3.9 SATA Configuration

Use the **SATA Configuration** menu (**BIOS Menu 15**) to change and/or set the configuration of the SATA devices installed in the system.

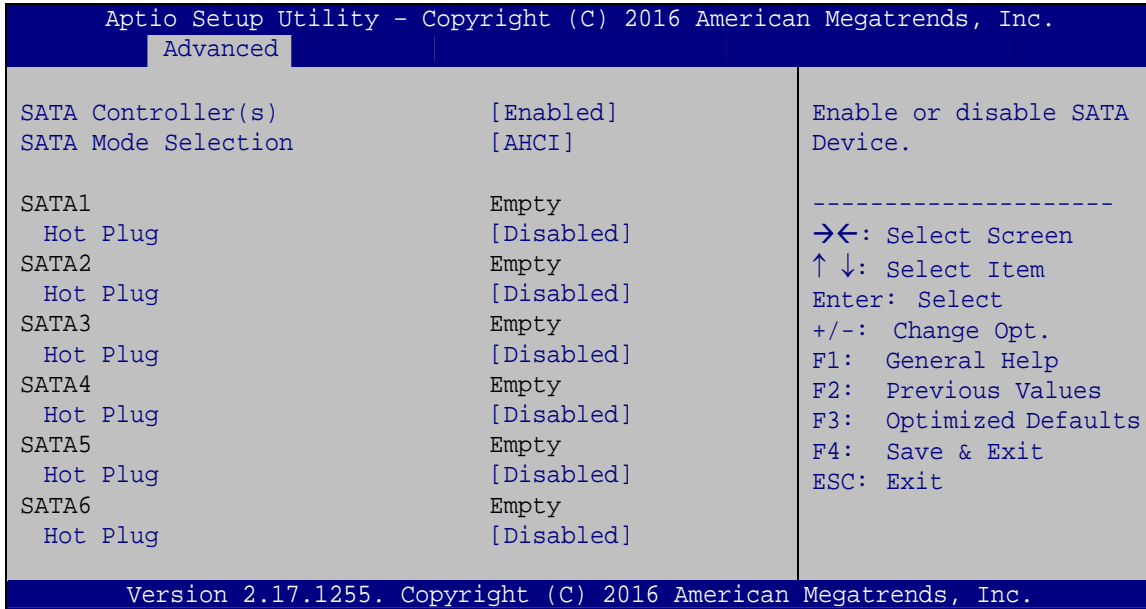

BIOS Menu 15: SATA Configuration

→ SATA Controller(s) [Enabled]

Use the **SATA Controller(s)** option to configure the SATA controller(s).

- **Enabled** **DEFAULT** Enables the on-board SATA controller(s).
- **Disabled** Disables the on-board SATA controller(s).

→ SATA Mode Selection [AHCI]

Use the **SATA Mode Selection** option to determine how the SATA devices operate.

- **AHCI** **DEFAULT** Configures SATA devices as AHCI device.
- **RAID** Configures SATA devices as RAID device.

IMBA-C2360-i2 ATX Motherboard

→ Hot Plug [Disabled]

Use the **Hot Plug** option to designate the correspondent SATA port as hot-pluggable.

- **Disabled** **DEFAULT** Disables the hot-pluggable function of the SATA port.
- **Enabled** Designates the SATA port as hot-pluggable.

5.3.10 NVMe Configuration

Use the **NVMe Configuration (BIOS Menu 16)** menu to display the NVMe controller and device information.

```

Aptio Setup Utility - Copyright (C) 2016 American Megatrends, Inc.
-----
Advanced
-----
NVMe controller and Drive information
No NVMe Device Found

-----
→←: Select Screen
↑↓: Select Item
Enter: Select
+/-: Change Opt.
F1: General Help
F2: Previous Values
F3: Optimized Defaults
F4: Save & Exit
ESC: Exit
-----
Version 2.17.1255. Copyright (C) 2016 American Megatrends, Inc.
    
```

BIOS Menu 16: NVMe Configuration

5.3.11 USB Configuration

Use the **USB Configuration** menu (**BIOS Menu 17**) to read USB configuration information and configure the USB settings.

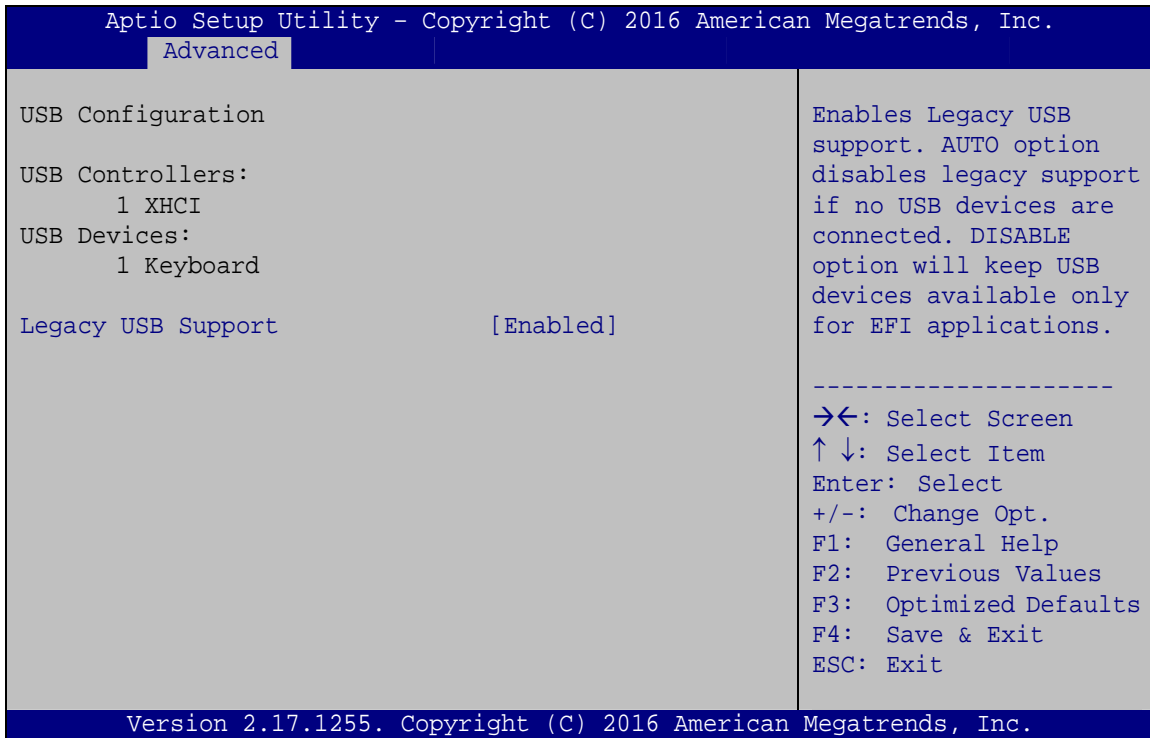

BIOS Menu 17: USB Configuration

➔ Legacy USB Support [Enabled]

Use the **Legacy USB Support** BIOS option to enable USB mouse and USB keyboard support. Normally if this option is not enabled, any attached USB mouse or USB keyboard does not become available until a USB compatible operating system is fully booted with all USB drivers loaded. When this option is enabled, any attached USB mouse or USB keyboard can control the system even when there is no USB driver loaded onto the system.

- ➔ **Enabled** **DEFAULT** Legacy USB support enabled
- ➔ **Disabled** Legacy USB support disabled
- ➔ **Auto** Legacy USB support disabled if no USB devices are connected

IMBA-C2360-i2 ATX Motherboard

5.3.12 iEi Feature

Use the **iEi Feature** menu (**BIOS Menu 18**) to configure One Key Recovery function.

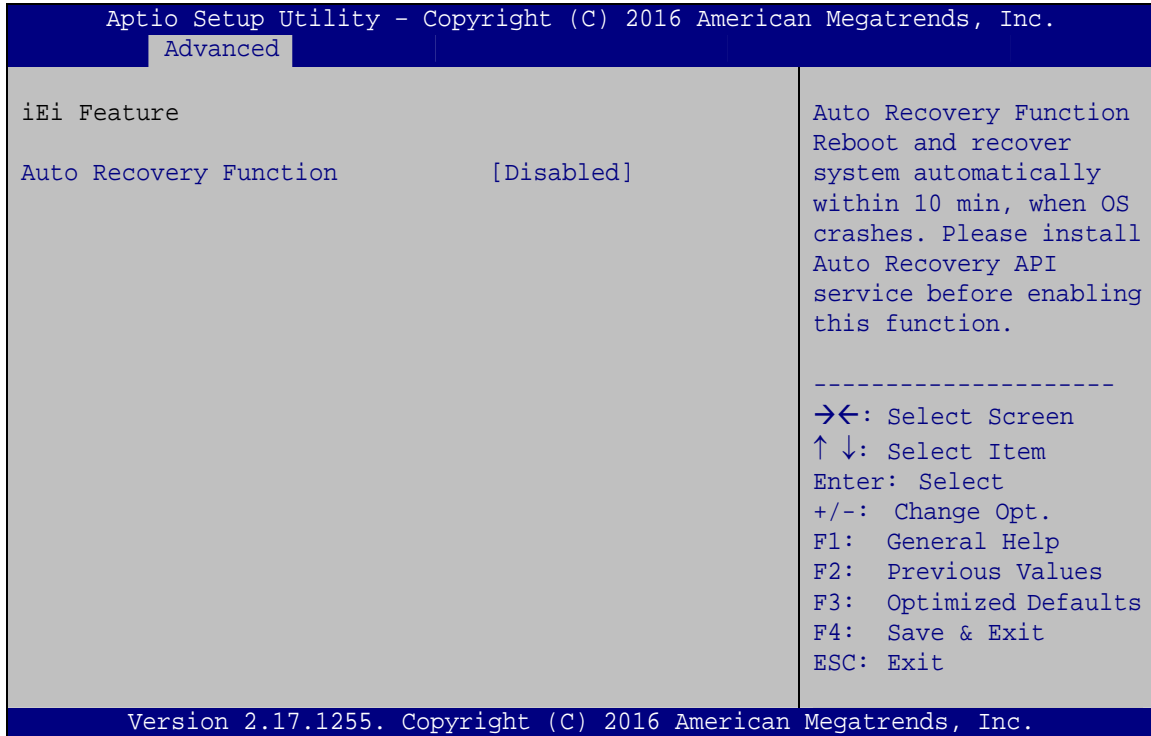

BIOS Menu 18: iEi Feature

→ Auto Recovery Function [Disabled]

Use the **Auto Recovery Function** BIOS option to enable or disable the auto recovery function of the IEI One Key Recovery.

- **Disabled** **DEFAULT** Auto recovery function disabled
- **Enabled** Auto recovery function enabled

5.4 Chipset

Use the **Chipset** menu (**BIOS Menu 19**) to access the PCH IO and System Agent (SA) configuration menus.



WARNING!

Setting the wrong values for the Chipset BIOS selections in the Chipset BIOS menu may cause the system to malfunction.

```
Aptio Setup Utility - Copyright (C) 2016 American Megatrends, Inc.
Main   Advanced  Chipset  Security  Boot   Save & Exit  Server Mgmt
-----
> System Agent (SA) Configuration      System Agent (SA)
> PCH-IO Configuration                Parameters
-----
-><: Select Screen
↑↓: Select Item
Enter: Select
+/-: Change Opt.
F1: General Help
F2: Previous Values
F3: Optimized Defaults
F4: Save & Exit
ESC: Exit

Version 2.17.1255. Copyright (C) 2016 American Megatrends, Inc.
```

BIOS Menu 19: Chipset

IMBA-C2360-i2 ATX Motherboard

5.4.1 System Agent (SA) Configuration

Use the **System Agent (SA) Configuration** menu (**BIOS Menu 20**) to configure the System Agent (SA) parameters.

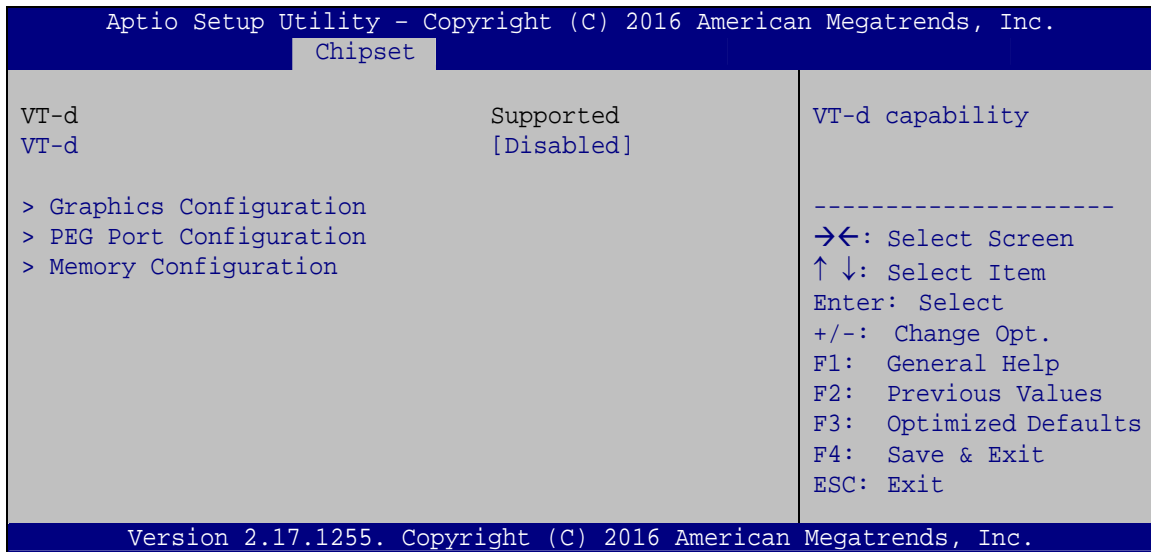

BIOS Menu 20: System Agent (SA) Configuration

→ VT-d [Disabled]

Use the **VT-d** option to enable or disable VT-d capability.

- **Disabled** **DEFAULT** Disables VT-d capability.
- **Enabled** Enables VT-d capability.

5.4.1.1 Graphics Configuration

Use the **Graphics Configuration (BIOS Menu 21)** menu to configure the video device connected to the system.

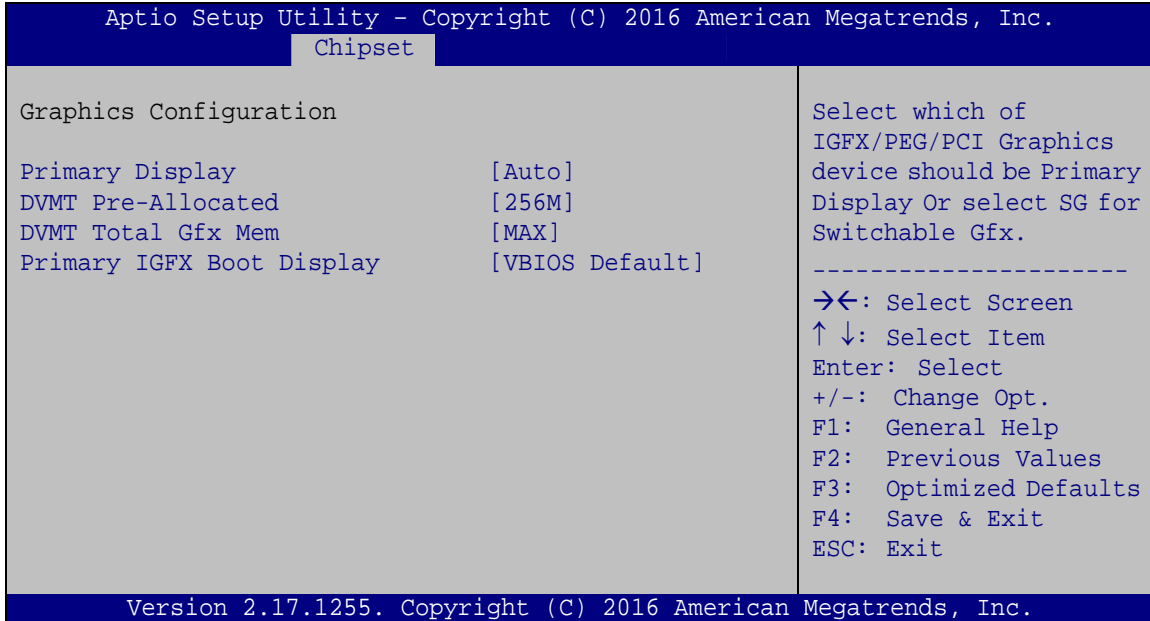

BIOS Menu 21: Graphics Configuration

→ Primary Display [Auto]

Use the **Primary Display** option to select the primary graphics controller the system uses.

The following options are available:

- Auto **Default**
- IGFX
- PEG
- PCIE
- SG

→ DVMT Pre-Allocated [256M]

Use the **DVMT Pre-Allocated** option to set the amount of system memory allocated to the integrated graphics processor when the system boots. The system memory allocated can then only be used as graphics memory, and is no longer available to applications or the operating system. Configuration options are listed below:

- 32M
- 64M

IMBA-C2360-i2 ATX Motherboard

- 128M
- 256M **Default**
- 512M

→ DVMT Total Gfx Mem [MAX]

Use the **DVMT Total Gfx Mem** option to select DVMT5.0 total graphic memory size used by the internal graphic device. The following options are available:

- 128M
- 256M
- MAX **Default**

→ Primary IGFX Boot Display [VBIOS Default]

Use the **Primary IGFX Boot Display** option to select the display device used by the system when it boots. Configuration options are listed below.

- VBIOS Default **DEFAULT**
- HDMI 2.0
- CRT
- IDP
- DVI

5.4.1.2 PEG Port Configuration

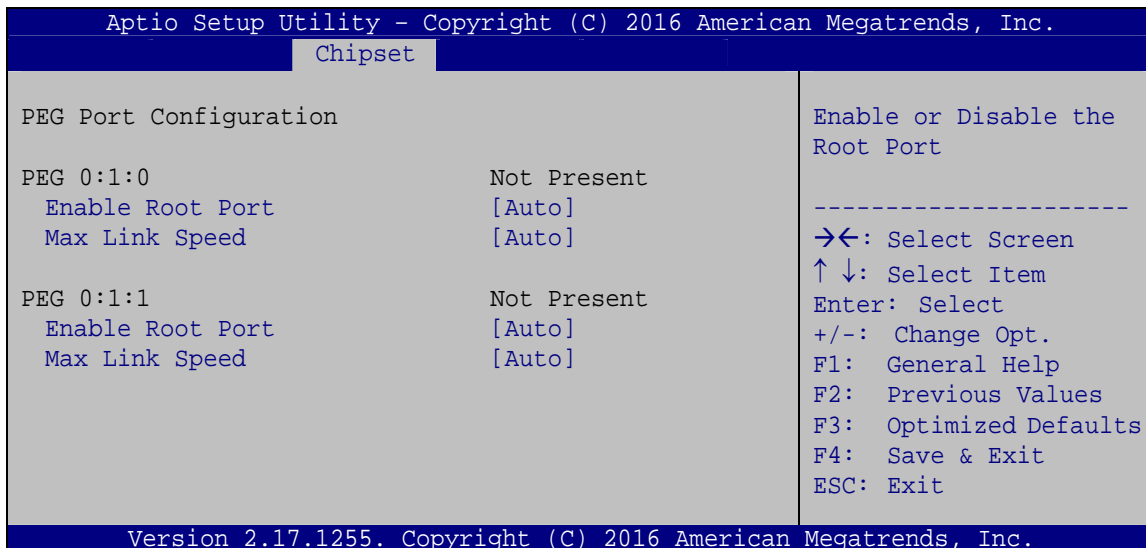

BIOS Menu 22: PEG Port Configuration

→ Enable Root Port [Auto]

Use the **Enable Root Port** option to enable or disable the PCI Express (PEG) controller.

- **Disabled** Disables the PCI Express (PEG) controller.
- **Enabled** Enables the PCI Express (PEG) controller.
- **Auto** **DEFAULT** The PCI Express (PEG) controller is disabled if no PCI Express devices are connected.

→ Max Link Speed [Auto]

Use the **Max Link Speed** option to select the maximum link speed of the PCI Express slot.

The following options are available:

- Auto **Default**
- Gen1
- Gen2
- Gen3

5.4.1.3 Memory Configuration

Use the **Memory Configuration** submenu (**BIOS Menu 23**) to view memory information.

```

Aptio Setup Utility - Copyright (C) 2016 American Megatrends, Inc.
Chipset
Memory Configuration
Total Memory          4096 MB
DIMM#0                Not Present
DIMM#1                Not Present
DIMM#2                Not Present
DIMM#3                4096 MB
-----
→←: Select Screen
↑↓: Select Item
Enter: Select
+/-: Change Opt.
F1: General Help
F2: Previous Values
F3: Optimized Defaults
F4: Save & Exit
ESC: Exit
Version 2.17.1255. Copyright (C) 2016 American Megatrends, Inc.
    
```

BIOS Menu 23: Memory Configuration

IMBA-C2360-i2 ATX Motherboard

5.4.2 PCH-IO Configuration

Use the **PCH-IO Configuration** menu (**BIOS Menu 24**) to configure the PCH parameters.

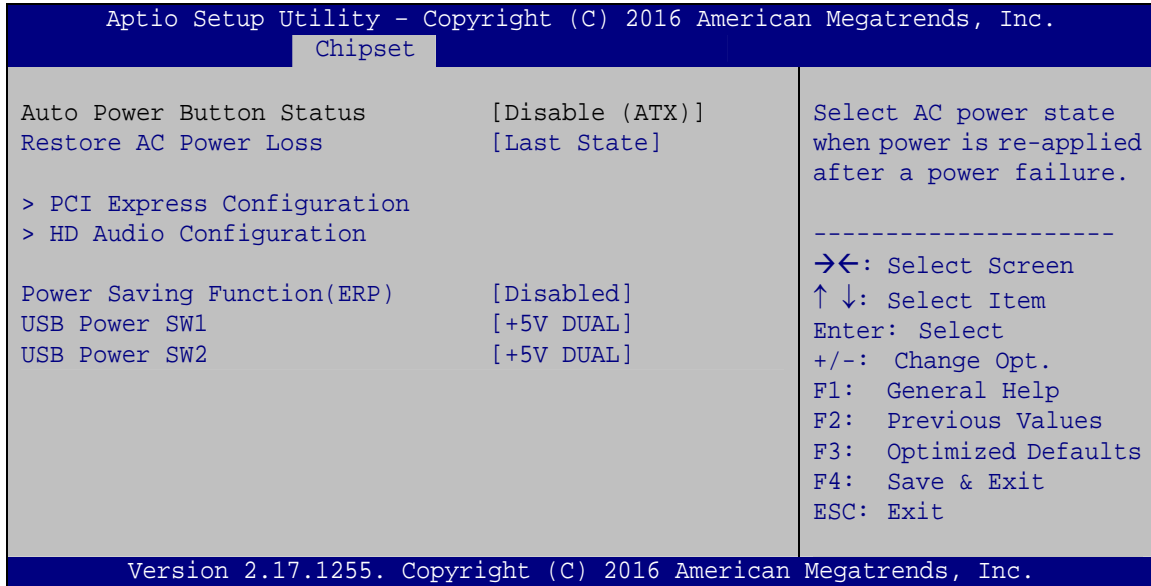

BIOS Menu 24: PCH-IO Configuration

→ Restore AC Power Loss [Last State]

Use the **Restore AC Power Loss** BIOS option to specify what state the system returns to if there is a sudden loss of power to the system.

- **Power Off** The system remains turned off
- **Power On** The system turns on
- **Last State** **DEFAULT** The system returns to its previous state. If it was on, it turns itself on. If it was off, it remains off.

→ Power Saving Function(ERP) [Disabled]

Use the **Power Saving Function(ERP)** BIOS option to enable or disable the power saving function.

- **Disabled** **DEFAULT** Power saving function is disabled.
- **Enabled** Power saving function is enabled. It will reduce power consumption when the system is off.

→ USB Power SW1 [+5V DUAL]

Use the **USB Power SW1** BIOS option to configure the USB power source for the corresponding USB connectors (**Table 5-2**).

- **+5V** Sets the USB power source to +5V
- **+5V DUAL** **DEFAULT** Sets the USB power source to +5V dual

→ USB Power SW2 [+5V DUAL]

Use the **USB Power SW2** BIOS option to configure the USB power source for the corresponding USB connectors (**Table 5-2**).

- **+5V** Sets the USB power source to +5V
- **+5V DUAL** **DEFAULT** Sets the USB power source to +5V dual

BIOS Options	Configured USB Ports
USB Power SW1	K/M_USB1 (external USB 2.0 ports) LAN1_USB1 (external USB 3.0 ports) LAN2_USB2 (external USB 3.0 ports)
USB Power SW2	USB1 (internal USB 2.0 ports) USB2 (internal USB 2.0 ports) USB3-1 (internal USB 3.0 ports)

Table 5-2: BIOS Options and Configured USB Ports

5.4.2.1 PCI Express Configuration

The BIOS options of the **PCIEX4_3 Slot Mode** item vary by BIOS (BIOS1 or BIOS2). The following table lists the BIOS options with correspondent I/O configuration.

BIOS Options	S_ATA3 and S_ATA4 Connectors		PCIEX4_2 Slot	PCIEX4_3 Slot
BIOS1 (a)	S_ATA3	S_ATA4	PCIe x4 slot	x
BIOS1 (b)	x	x	PCIe x4 slot	PCIe x4 slot
BIOS2 (c)	S_ATA3	S_ATA4	USB 3.0 expansion card	PCIe x2 slot
BIOS2 (d)	x	x	USB 3.0 expansion card	PCIe Mini and mSATA expansion card

Table 5-3: BIOS Options with Correspondent I/O Configuration

IMBA-C2360-i2 ATX Motherboard

This section will show various BIOS menus and options for different BIOS (BIOS1 or BIOS2).

For BIOS1:

```

Aptio Setup Utility - Copyright (C) 2016 American Megatrends, Inc.
Chipset
-----
PCI Express Configuration
(BIOS No.1)
PCIEX4_1 Slot Mode      PCIe 1x4 Slot
PCIEX4_2 Slot Mode      PCIe 1x4 Slot
PCIEX4_3 Slot Mode      [(a)PCIEX4_3 Slot: N/A
                        (SATA Port 3,4:
                        Enabled)]

> PCIEX4_1 Slot
> PCIEX4_2 Slot
> MPCIE1 Slot

Select PCIEX4_3 slot
function.
Enable/Disable PCIEX4_3
Slot or SATA Port 3/4.
-----
-><: Select Screen
↑↓: Select Item
Enter: Select
+/-: Change Opt.
F1: General Help
F2: Previous Values
F3: Optimized Defaults
F4: Save & Exit
ESC: Exit

Version 2.17.1255. Copyright (C) 2016 American Megatrends, Inc.

```

BIOS Menu 25: PCI Express Configuration (For BIOS1)

→ PCIEX4_3 Slot Mode [(a)PCIEX4_3 Slot: N/A (SATA Port 3,4: Enabled)]

Use the **PCIEX4_3 Slot Mode** BIOS option to select the PCIEX4_3 slot function.

- **(a)PCIEX4_3 Slot: DEFAULT N/A (SATA Port 3,4: Enabled)** The PCIEX4_3 slot is disabled, and the S_ATA3 and S_ATA4 connectors are enabled.
- **(b)PCIEX4_3 Slot: 1x4 Slot (SATA Port 3,4: N/A)** The PCIEX4_3 slot is set as a PCIe x4 slot, and the S_ATA3 and S_ATA4 connectors are disabled.

For BIOS2:

```

Aptio Setup Utility - Copyright (C) 2016 American Megatrends, Inc.
Chipset
-----
PCI Express Configuration
(BIOS No.2)
PCIEX4_1 Slot Mode      PCIe 1x4 Slot
PCIEX4_2 Slot Mode      USB 3.0(Use F347 Card)
PCIEX4_3 Slot Mode      [(c)PCIEX4_3 Slot: 1x2
                          Slot (SATA Port 3,4:
                          Enabled)]
-----
> PCIEX4_1 Slot
> PCIEX4_3 Slot
> MPCIE1 Slot

Select PCIEX4_3 slot
function.
Enable/Disable PCIEX4_3
Slot or SATA Port 3/4.
-----
-><: Select Screen
↑↓: Select Item
Enter: Select
+/-: Change Opt.
F1:  General Help
F2:  Previous Values
F3:  Optimized Defaults
F4:  Save & Exit
ESC: Exit

Version 2.17.1255. Copyright (C) 2016 American Megatrends, Inc.

```

BIOS Menu 26: PCI Express Configuration (For BIOS2)

➔ PCIEX4_3 Slot Mode [(c)PCIEX4_3 Slot: 1x2 Slot (SATA Port 3,4: Enabled)]

Use the **PCIEX4_3 Slot Mode** BIOS option to select the PCIEX4_3 slot function.

- ➔ **(c)PCIEX4_3 Slot: DEFAULT 1x2 Slot (SATA Port 3,4: Enabled)** The PCIEX4_3 slot is set as a PCIe x2 slot, and the S_ATA3 and S_ATA4 connectors are enabled.
- ➔ **(d)PCIEX4_3 Slot: 1x1 Slot + mSATA 3,4 (Use F348 Card)** The PCIEX4_3 slot is installed with the optional PCIe Mini and mSATA expansion card, and the S_ATA3 and S_ATA4 connectors are disabled.



NOTE:

To use the PCIe Mini and mSATA expansion card, this BIOS item must be set to **(d)PCIEX4_3 Slot: 1x1 Slot + mSATA 3,4 (Use F348 Card)**.

IMBA-C2360-i2 ATX Motherboard

5.4.2.1.1 PCIEX4_1 Slot, PCIEX4_2 Slot, PCIEX4_3 Slot and MPCIE1 Slot

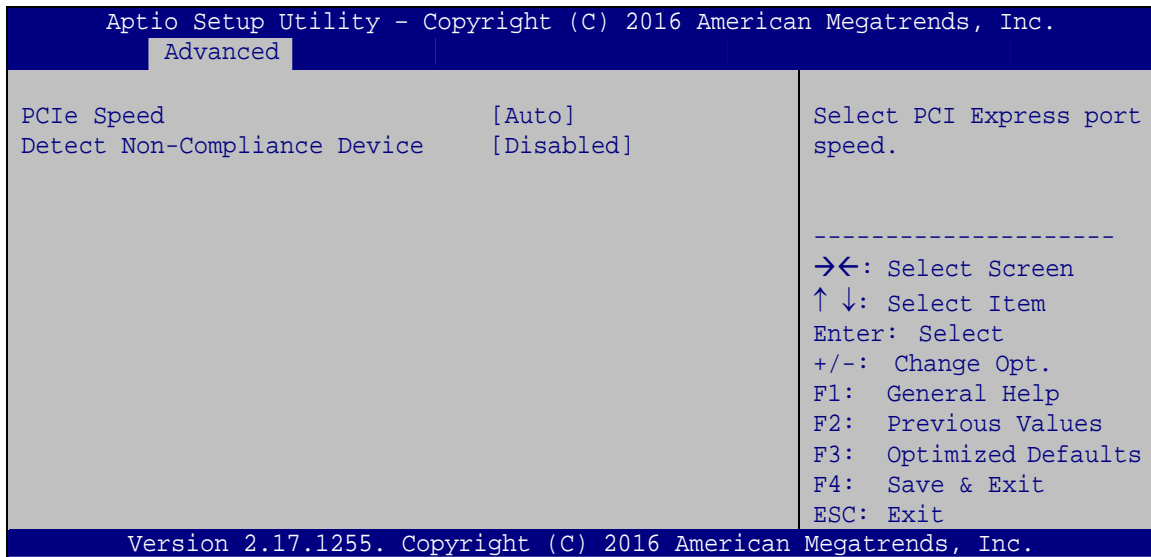

BIOS Menu 27: PCIEX1_1 Slot and PCIEX4_1 Slot Configuration Menu

→ PCIe Speed [Auto]

Use this option to select the support type of the PCI Express slots. The following options are available:

- Auto **Default**
- Gen1
- Gen2
- Gen3

→ Detect Non-Compliance Device [Disabled]

Use the **Detect Non-Compliance Device** option to enable or disable detecting if a non-compliance PCI Express device is connected to the PCI Express slot.

→ **Disabled** **DEFAULT** Disables to detect if a non-compliance PCI Express device is connected to the PCI Express slot.

→ **Enabled** Enables to detect if a non-compliance PCI Express device is connected to the PCI Express slot.

5.4.2.2 HD Audio Configuration

Use the **HD Audio Configuration** menu (**BIOS Menu 26**) to configure the PCH Azalia settings.

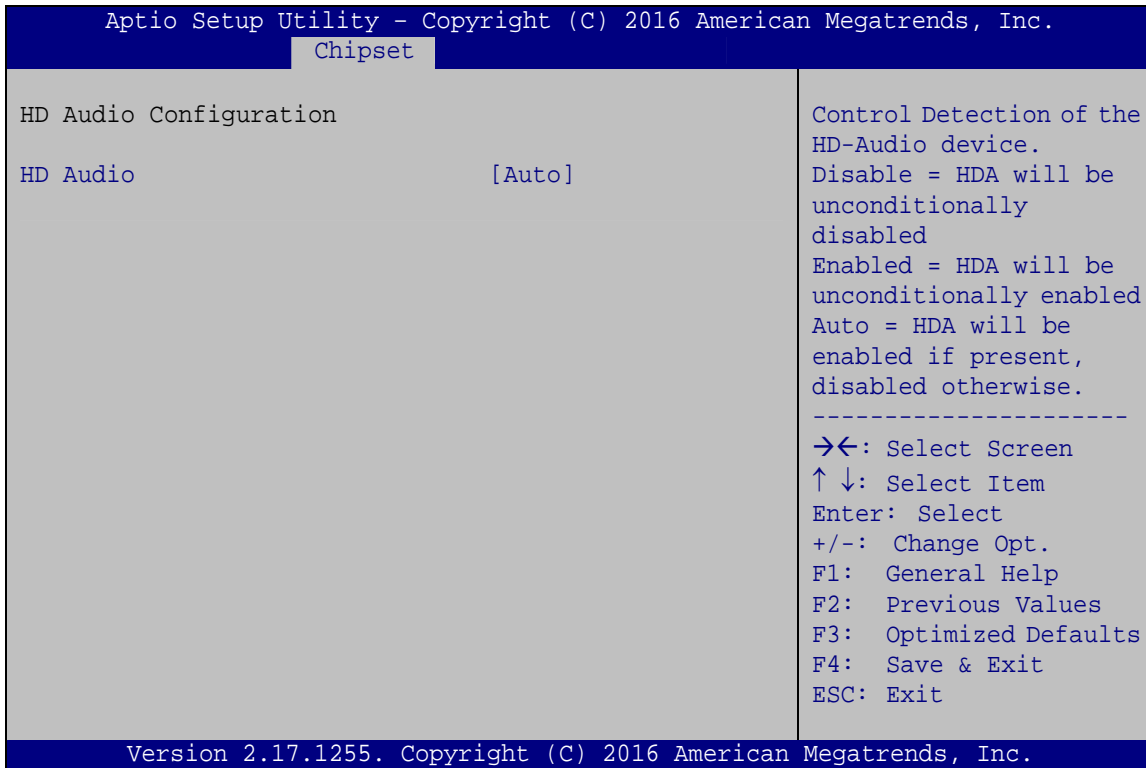

BIOS Menu 28: HD Audio Configuration

→ HD Audio [Auto]

Use the **HD Audio** option to enable or disable the High Definition Audio controller.

- **Disabled** The onboard High Definition Audio controller is disabled.
- **Enabled** The onboard High Definition Audio controller is enabled.
- **Auto** **DEFAULT** The onboard High Definition Audio controller automatically detected and enabled

IMBA-C2360-i2 ATX Motherboard

5.5 Security

Use the **Security** menu (**BIOS Menu 29**) to set system and user passwords.

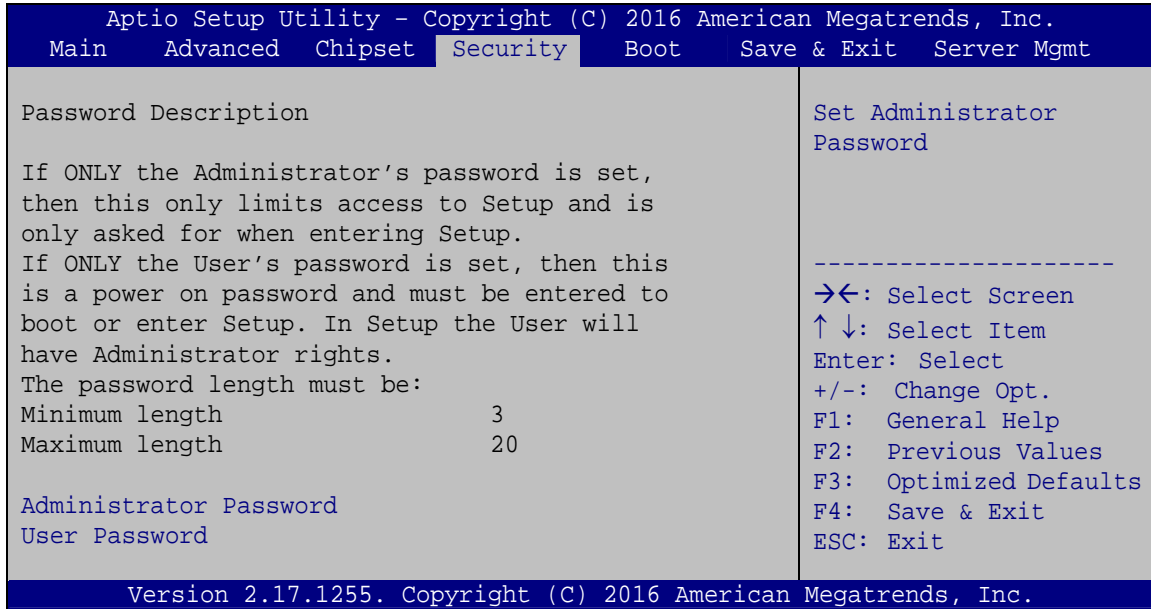

BIOS Menu 29: Security

→ Administrator Password

Use the **Administrator Password** to set or change a administrator password.

→ User Password

Use the **User Password** to set or change a user password.

5.6 Boot

Use the **Boot** menu (**BIOS Menu 30**) to configure system boot options.

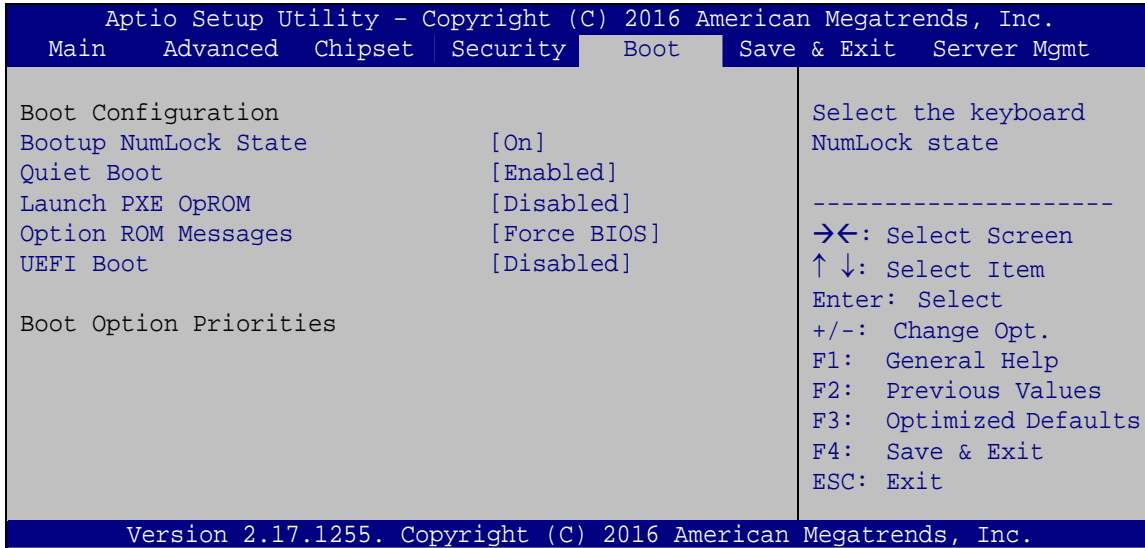

BIOS Menu 30: Boot

→ Bootup NumLock State [On]

Use the **Bootup NumLock State** BIOS option to specify if the number lock setting must be modified during boot up.

- **On** **DEFAULT** Allows the Number Lock on the keyboard to be enabled automatically when the computer system boots up. This allows the immediate use of the 10-key numeric keypad located on the right side of the keyboard. To confirm this, the Number Lock LED light on the keyboard is lit.
- **Off** Does not enable the keyboard Number Lock automatically. To use the 10-keys on the keyboard, press the Number Lock key located on the upper left-hand corner of the 10-key pad. The Number Lock LED on the keyboard lights up when the Number Lock is engaged.

IMBA-C2360-i2 ATX Motherboard

→ Quiet Boot [Enabled]

Use the **Quiet Boot** BIOS option to select the screen display when the system boots.

- **Disabled** Normal POST messages displayed
- **Enabled** **DEFAULT** OEM Logo displayed instead of POST messages

→ Launch PXE OpROM [Disabled]

Use the **Launch PXE OpROM** option to enable or disable boot option for legacy network devices.

- **Disabled** **DEFAULT** Ignore all PXE Option ROMs
- **Enabled** Load PXE Option ROMs.

→ Option ROM Messages [Force BIOS]

Use the **Option ROM Messages** option to set the Option ROM display mode.

- **Force BIOS** **DEFAULT** Sets display mode to force BIOS.
- **Keep Current** Sets display mode to current.

→ UEFI Boot [Disabled]

Use the **UEFI Boot** option to enable or disable to boot from the UEFI devices.

- **Enabled** Boot from UEFI devices is enabled.
- **Disabled** **DEFAULT** Boot from UEFI devices is disabled.

5.7 Save & Exit

Use the **Safe & Exit** menu (**BIOS Menu 31**) to load default BIOS values, optimal failsafe values and to save configuration changes.

```

Aptio Setup Utility - Copyright (C) 2016 American Megatrends, Inc.
Main   Advanced  Chipset  Security  Boot   Save & Exit  Server Mgmt
-----
Save Changes and Reset
Discard Changes and Reset

Restore Defaults
Save as User Defaults
Restore User Defaults

Exit the system after
saving the changes.

-----
-><: Select Screen
↑↓: Select Item
Enter: Select
+/-: Change Opt.
F1: General Help
F2: Previous Values
F3: Optimized Defaults
F4: Save & Exit
ESC: Exit

Version 2.17.1255. Copyright (C) 2016 American Megatrends, Inc.

```

BIOS Menu 31: Save & Exit

→ Save Changes and Reset

Use the **Save Changes and Reset** option to save the changes made to the BIOS options and reset the system.

→ Discard Changes and Reset

Use the **Discard Changes and Reset** option to exit the system without saving the changes made to the BIOS configuration setup program.

→ Restore Defaults

Use the **Restore Defaults** option to load the optimal default values for each of the parameters on the Setup menus. **F3 key can be used for this operation.**

→ Save as User Defaults

Use the **Save as User Defaults** option to save the changes done so far as user defaults.

→ Restore User Defaults

Use the **Restore User Defaults** option to restore the user defaults to all the setup options.

IMBA-C2360-i2 ATX Motherboard

5.8 Server Mgmt

Use the **Server Mgmt** menu (**BIOS Menu 32**) to configure system event log and BMC network parameters.

```

Aptio Setup Utility - Copyright (C) 2016 American Megatrends, Inc.
Main   Advanced  Chipset  Security  Boot   Save & Exit  Server Mgmt
-----
BMC Self Test Status          FAILED
BMC Firmware Revision        Unknown
> System Event Log
> BMC network configuration

Press <Enter> to change
the SEL event log
configuration.
-----
-><: Select Screen
↑↓: Select Item
Enter: Select
+/-: Change Opt.
F1: General Help
F2: Previous Values
F3: Optimized Defaults
F4: Save & Exit
ESC: Exit

Version 2.17.1255. Copyright (C) 2016 American Megatrends, Inc.
  
```

BIOS Menu 32: Server Mgmt

5.8.1 System Event Log

Use the **System Event Log** menu (**BIOS Menu 33**) to configure system event log options.

```

Aptio Setup Utility - Copyright (C) 2016 American Megatrends, Inc.
-----
Enabling/Disabling Options
SEL Components                [Enabled]

Erasing Settings
Erase SEL                     [No]
When SEL is Full              [Do Nothing]

NOTE: All values changed here do not take effect
      until computer is restarted.

Change this to enable or
disable all features of
System Event Logging
during boot.
-----
-><: Select Screen
↑↓: Select Item
Enter: Select
+/-: Change Opt.
F1: General Help
F2: Previous Values
F3: Optimized Defaults
F4: Save & Exit
ESC: Exit

Version 2.17.1255. Copyright (C) 2016 American Megatrends, Inc.
  
```

BIOS Menu 33: System Event Log

→ SEL Components [Enabled]

Use the **SEL Components** option to enable or disable all features of System Event Log during boot.

- Disabled** System Event Log features disabled.
- Enabled** **DEFAULT** System Event Log features enabled.

→ Erase SEL [No]

Use the **Erase SEL** option to select an option for erasing SEL (system event log).

- No** **DEFAULT** Do not erase SEL
- Yes,**
On next reset Erase SEL on next reset
- Yes,**
On every reset Erase SEL on every reset

→ When SEL is Full [Do Nothing]

Use the **When SEL is Full** option to select an option for reaction to a full SEL.

- Do Nothing** **DEFAULT** Do nothing when SEL is full
- Erase**
Immediately Erase SEL immediately when SEL is full

IMBA-C2360-i2 ATX Motherboard

5.8.2 BMC Network Configuration

Use the **BMC Network Configuration** menu (**BIOS Menu 34**) to configure BMC network parameters.

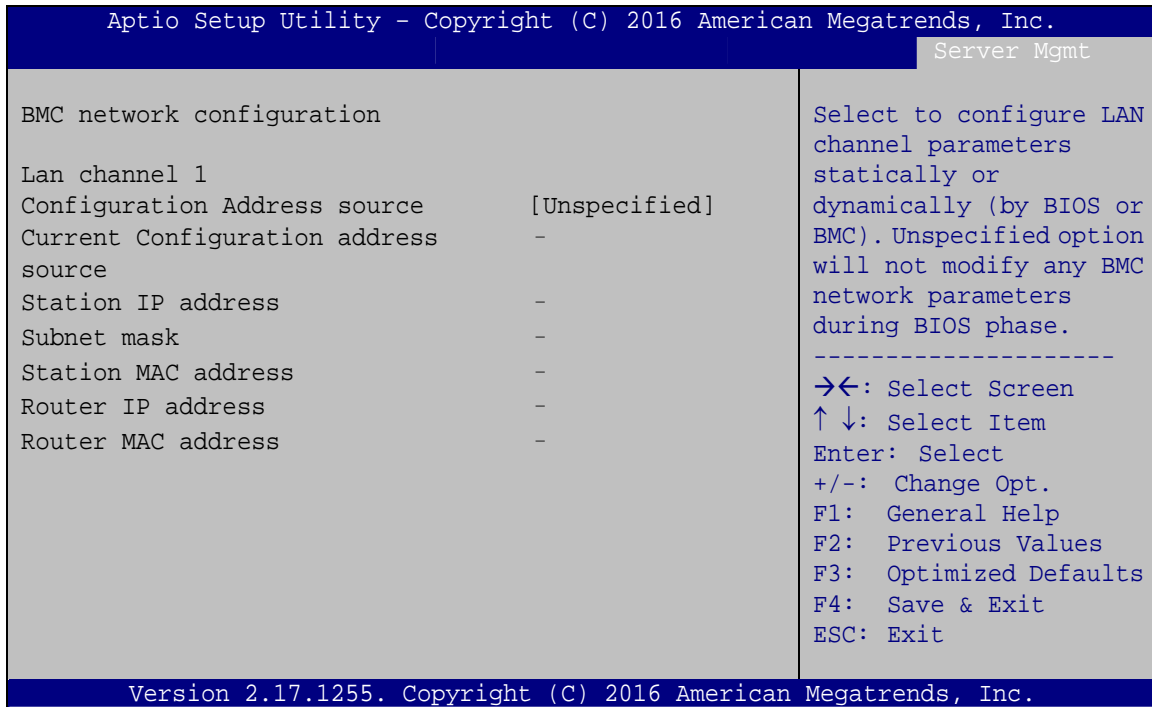

BIOS Menu 34: System Event Log

→ Configuration Address source [Unspecified]

Use the **Configuration Address source** to configure LAN channel parameters statically or dynamically (by BIOS or BMC).

- **Unspecified** **DEFAULT** BMC network parameters will not be modified during BIOS phase.

- **Static** Select to modify the following BMC network parameters:
 - Station IP address
 - Subnet mask
 - Station MAC address
 - Router IP address
 - Router MAC address

IMBA-C2360-i2 ATX Motherboard

→ **DynamicBmcDhcp**

Select to configure LAN channel parameters dynamically by BMC

→ **DynamicBmcNonDhcp**

Select to configure LAN channel parameters dynamically by BIOS

Chapter

6

Software Drivers

6.1 Available Software Drivers



NOTE:

The content of the CD may vary throughout the life cycle of the product and is subject to change without prior notice. Visit the IEI website or contact technical support for the latest updates.

The following drivers can be installed on the system:

- Chipset
- VGA
- LAN
- Audio
- ME (Intel® AMT)
- USB 3.0 (Windows 7 OS only)
- Kernel-Mode Driver Framework (Windows 7 OS only)
- Intel® Serial IO (Windows 8.1/10 64-bit OS only)

6.2 Software Installation

All the drivers for the IMBA-C2360-i2 are on the CD that came with the system. To install the drivers, please follow the steps below.

Step 1: Insert the CD into a CD drive connected to the system.



NOTE:

If the installation program doesn't start automatically:
Click "Start->My Computer->CD Drive->autorun.exe"

Step 2: The driver main menu appears (**Figure 6-1**).

IMBA-C2360-i2 ATX Motherboard

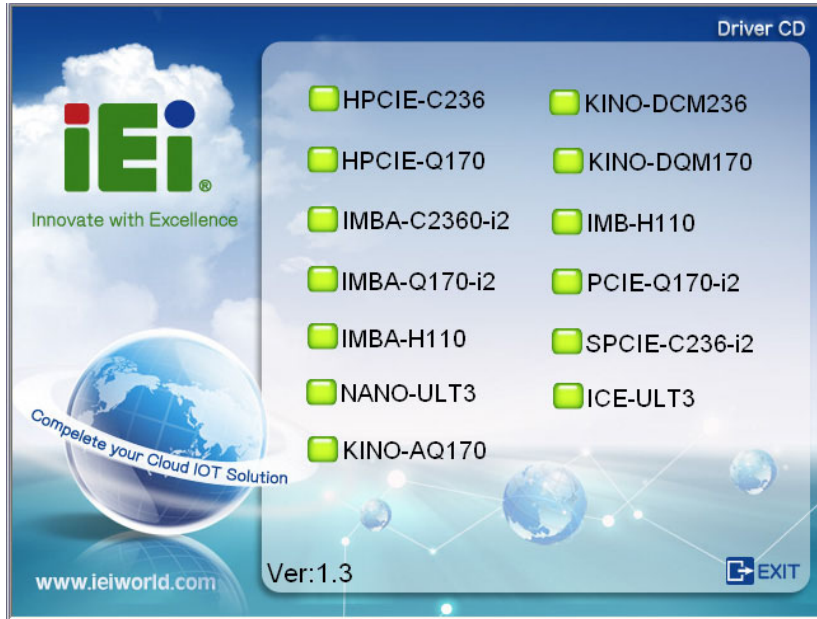

Figure 6-1: Introduction Screen

Step 3: Click IMBA-C2360-i2.

Step 4: A new screen with a list of available drivers appears (**Figure 6-2**).



Figure 6-2: Available Drivers

Step 5: Install all of the necessary drivers in this menu.

Appendix

A

Regulatory Compliance

DECLARATION OF CONFORMITY



This equipment has been tested and found to comply with specifications for CE marking. If the user modifies and/or installs other devices in the equipment, the CE conformity declaration may no longer apply.

FCC WARNING



This equipment complies with Part 15 of the FCC Rules. Operation is subject to the following two conditions:

- This device may not cause harmful interference, and
- This device must accept any interference received, including interference that may cause undesired operation.

This equipment has been tested and found to comply with the limits for a Class A digital device, pursuant to part 15 of the FCC Rules. These limits are designed to provide reasonable protection against harmful interference when the equipment is operated in a commercial environment. This equipment generates, uses, and can radiate radio frequency energy and, if not installed and used in accordance with the instruction manual, may cause harmful interference to radio communications. Operation of this equipment in a residential area is likely to cause harmful interference in which case the user will be required to correct the interference at his own expense.

Appendix

B

Product Disposal

**CAUTION:**

Risk of explosion if battery is replaced by an incorrect type. Only certified engineers should replace the on-board battery.

Dispose of used batteries according to instructions and local regulations.

- Outside the European Union – If you wish to dispose of used electrical and electronic products outside the European Union, please contact your local authority so as to comply with the correct disposal method.
- Within the European Union – The device that produces less waste and is easier to recycle is classified as electronic device in terms of the European Directive 2012/19/EU (WEEE), and must not be disposed of as domestic garbage.

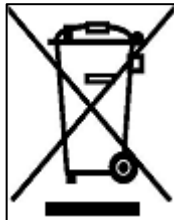

EU-wide legislation, as implemented in each Member State, requires that waste electrical and electronic products carrying the mark (left) must be disposed of separately from normal household waste. This includes monitors and electrical accessories, such as signal cables or power cords. When you need to dispose of your device, please follow the guidance of your local authority, or ask the shop where you purchased the product. The mark on electrical and electronic products only applies to the current European Union Member States.

Please follow the national guidelines for electrical and electronic product disposal.

Appendix

C

BIOS Options

IMBA-C2360-i2 ATX Motherboard

Below is a list of BIOS configuration options in the BIOS chapter.

System Date [xx/xx/xx]	93
System Time [xx:xx:xx]	93
Security Device Support [Enable]	94
ACPI Sleep State [S3 (Suspend to RAM)]	95
Intel AMT [Enabled]	96
Un-Configure ME [Disabled]	96
Case Open Beep [Disabled]	97
Serial Port [Enabled]	98
Change Settings [Auto]	98
Serial Port [Enabled]	99
Change Settings [Auto]	99
Serial Port [Enabled]	100
Change Settings [Auto]	100
Serial Port [Enabled]	101
Change Settings [Auto]	101
Serial Port [Enabled]	102
Change Settings [Auto]	102
Transfer Mode [RS232]	103
Serial Port [Enabled]	103
Change Settings [Auto]	103
Transfer Mode [RS232]	104
Parallel Port [Enabled]	104
Change Settings [Auto]	105
Device Mode [STD Printer Mode]	105
PC Health Status	106
CPU_FAN1 Smart Fan Control/SYS_FAN1 Smart Fan Control [Auto Mode]	107
Auto mode fan start/off temperature	108
Auto mode fan start PWM	108
Auto mode fan slope PWM	108
Wake system with Fixed Time [Disabled]	109
Console Redirection [Disabled]	110
Terminal Type [ANSI]	111
Bits per second [115200]	111

Data Bits [8]	111
Parity [None].....	112
Stop Bits [1].....	112
Legacy Serial Redirection Port [COM1].....	113
Hyper-threading [Enabled].....	114
Active Processor Cores [All]	115
Intel Virtualization Technology [Disabled]	115
Intel(R) SpeedStep(tm) [Enabled].....	115
SATA Controller(s) [Enabled]	116
SATA Mode Selection [AHCI].....	116
Hot Plug [Disabled].....	117
Legacy USB Support [Enabled].....	118
Auto Recovery Function [Disabled].....	119
VT-d [Disabled].....	121
Primary Display [Auto]	122
DVMT Pre-Allocated [256M]	122
DVMT Total Gfx Mem [MAX].....	123
Primary IGFX Boot Display [VBIOS Default]	123
Enable Root Port [Auto]	124
Max Link Speed [Auto]	124
Restore AC Power Loss [Last State]	125
Power Saving Function(ERP) [Disabled].....	125
USB Power SW1 [+5V DUAL].....	126
USB Power SW2 [+5V DUAL].....	126
PCIEX4_3 Slot Mode [(a)PCIEX4_3 Slot: N/A (SATA Port 3,4: Enabled)]	127
PCIEX4_3 Slot Mode [(c)PCIEX4_3 Slot: 1x2 Slot (SATA Port 3,4: Enabled)]	128
PCIe Speed [Auto].....	129
Detect Non-Compliance Device [Disabled]	129
HD Audio [Auto].....	130
Administrator Password	131
User Password	131
Bootup NumLock State [On].....	132
Quiet Boot [Enabled]	133
Launch PXE OpROM [Disabled].....	133
Option ROM Messages [Force BIOS].....	133

IMBA-C2360-i2 ATX Motherboard

UEFI Boot [Disabled]	133
Save Changes and Reset	134
Discard Changes and Reset	134
Restore Defaults	134
Save as User Defaults	134
Restore User Defaults	134
SEL Components [Enabled].....	136
Erase SEL [No]	136
When SEL is Full [Do Nothing].....	136
Configuration Address source [Unspecified]	137

Appendix

D

Terminology

IMBA-C2360-i2 ATX Motherboard

AC '97	Audio Codec 97 (AC'97) refers to a codec standard developed by Intel® in 1997.
ACPI	Advanced Configuration and Power Interface (ACPI) is an OS-directed configuration, power management, and thermal management interface.
AHCI	Advanced Host Controller Interface (AHCI) is a SATA Host controller register-level interface.
ATA	The Advanced Technology Attachment (ATA) interface connects storage devices including hard disks and CD-ROM drives to a computer.
ARMD	An ATAPI Removable Media Device (ARMD) is any ATAPI device that supports removable media, besides CD and DVD drives.
ASKIR	Amplitude Shift Keyed Infrared (ASKIR) is a form of modulation that represents a digital signal by varying the amplitude (“volume”) of the signal. A low amplitude signal represents a binary 0, while a high amplitude signal represents a binary 1.
BIOS	The Basic Input/Output System (BIOS) is firmware that is first run when the computer is turned on and can be configured by the end user
CODEC	The Compressor-Decompressor (CODEC) encodes and decodes digital audio data on the system.
CMOS	Complimentary metal-oxide-conductor is an integrated circuit used in chips like static RAM and microprocessors.
COM	COM refers to serial ports. Serial ports offer serial communication to expansion devices. The serial port on a personal computer is usually a male DB-9 connector.
DAC	The Digital-to-Analog Converter (DAC) converts digital signals to analog signals.
DDR	Double Data Rate refers to a data bus transferring data on both the rising and falling edges of the clock signal.
DMA	Direct Memory Access (DMA) enables some peripheral devices to bypass the system processor and communicate directly with the system memory.

DIMM	Dual Inline Memory Modules are a type of RAM that offer a 64-bit data bus and have separate electrical contacts on each side of the module.
DIO	The digital inputs and digital outputs are general control signals that control the on/off circuit of external devices or TTL devices. Data can be read or written to the selected address to enable the DIO functions.
EHCI	The Enhanced Host Controller Interface (EHCI) specification is a register-level interface description for USB 2.0 Host Controllers.
EIDE	Enhanced IDE (EIDE) is a newer IDE interface standard that has data transfer rates between 4.0 MBps and 16.6 MBps.
EIST	Enhanced Intel® SpeedStep Technology (EIST) allows users to modify the power consumption levels and processor performance through application software. The application software changes the bus-to-core frequency ratio and the processor core voltage.
FSB	The Front Side Bus (FSB) is the bi-directional communication channel between the processor and the Northbridge chipset.
GbE	Gigabit Ethernet (GbE) is an Ethernet version that transfers data at 1.0 Gbps and complies with the IEEE 802.3-2005 standard.
GPIO	General purpose input
HDD	Hard disk drive (HDD) is a type of magnetic, non-volatile computer storage device that stores digitally encoded data.
ICH	The Input/Output Control Hub (ICH) is an Intel® Southbridge chipset.
IrDA	Infrared Data Association (IrDA) specify infrared data transmission protocols used to enable electronic devices to wirelessly communicate with each other.
L1 Cache	The Level 1 Cache (L1 Cache) is a small memory cache built into the system processor.
L2 Cache	The Level 2 Cache (L2 Cache) is an external processor memory cache.
LCD	Liquid crystal display (LCD) is a flat, low-power display device that consists of two polarizing plates with a liquid crystal panel in between.

IMBA-C2360-i2 ATX Motherboard

LVDS	Low-voltage differential signaling (LVDS) is a dual-wire, high-speed differential electrical signaling system commonly used to connect LCD displays to a computer.
POST	The Power-on Self Test (POST) is the pre-boot actions the system performs when the system is turned-on.
RAM	Random Access Memory (RAM) is volatile memory that loses data when power is lost. RAM has very fast data transfer rates compared to other storage like hard drives.
SATA	Serial ATA (SATA) is a serial communications bus designed for data transfers between storage devices and the computer chipsets. The SATA bus has transfer speeds up to 1.5 Gbps and the SATA II bus has data transfer speeds of up to 3.0 Gbps.
S.M.A.R.T	Self Monitoring Analysis and Reporting Technology (S.M.A.R.T) refers to automatic status checking technology implemented on hard disk drives.
UART	Universal Asynchronous Receiver-transmitter (UART) is responsible for asynchronous communications on the system and manages the system's serial communication (COM) ports.
UHCI	The Universal Host Controller Interface (UHCI) specification is a register-level interface description for USB 1.1 Host Controllers.
USB	The Universal Serial Bus (USB) is an external bus standard for interfacing devices. USB 1.1 supports 12Mbps data transfer rates and USB 2.0 supports 480Mbps data transfer rates.
VGA	The Video Graphics Array (VGA) is a graphics display system developed by IBM.

Appendix

E

Digital I/O Interface

IMBA-C2360-i2 ATX Motherboard

E.1 Introduction

The DIO connector on the IMBA-C2360-i2 is interfaced to GPIO ports on the Super I/O chipset. The digital inputs and digital outputs are generally control signals that control the on/off circuit of external devices or TTL devices. Data can be read or written to the selected address to enable the DIO functions.



NOTE:

For further information, please refer to the datasheet for the Super I/O chipset.

The BIOS interrupt call **INT 15H** controls the digital I/O.

INT 15H:

AH – 6FH	
<u>Sub-function:</u>	
AL – 8	: Set the digital port as INPUT
AL	: Digital I/O input value

E.2 Assembly Language Sample 1

```
MOV     AX, 6F08H      ;setting the digital port as input
INT     15H           ;
```

AL low byte = value

AH – 6FH
<u>Sub-function:</u>
AL – 9 : Set the digital port as OUTPUT
BL : Digital I/O input value

E.3 Assembly Language Sample 2

```
MOV     AX, 6F09H      ;setting the digital port as output
MOV     BL, 09H        ;digital value is 09H
INT     15H           ;
```

Digital Output is 1001b

Appendix

F

Watchdog Timer



NOTE:

The following discussion applies to DOS environment. Contact IEI support or visit the IEI website for specific drivers for other operating systems.

The Watchdog Timer is provided to ensure that standalone systems can always recover from catastrophic conditions that cause the CPU to crash. This condition may have occurred by external EMIs or a software bug. When the CPU stops working correctly, Watchdog Timer either performs a hardware reset (cold boot) or a Non-Maskable Interrupt (NMI) to bring the system back to a known state.

A BIOS function call (INT 15H) is used to control the Watchdog Timer.

INT 15H:

AH – 6FH Sub-function:	
AL – 2:	Sets the Watchdog Timer’s period.
BL:	Time-out value (Its unit-second is dependent on the item “Watchdog Timer unit select” in CMOS setup).

Table F-1: AH-6FH Sub-function

Call sub-function 2 to set the time-out period of Watchdog Timer first. If the time-out value is not zero, the Watchdog Timer starts counting down. When the timer value reaches zero, the system resets. To ensure that this reset condition does not occur, calling sub-function 2 must periodically refresh the Watchdog Timer. However, the watchdog timer is disabled if the time-out value is set to zero.

A tolerance of at least 10% must be maintained to avoid unknown routines within the operating system (DOS), such as disk I/O that can be very time-consuming.

IMBA-C2360-i2 ATX Motherboard

**NOTE:**

When exiting a program it is necessary to disable the Watchdog Timer, otherwise the system resets.

EXAMPLE PROGRAM:

; INITIAL TIMER PERIOD COUNTER

;

W_LOOP:

;

```

MOV     AX, 6F02H      ;setting the time-out value
MOV     BL, 30         ;time-out value is 48 seconds
INT     15H

```

;

; ADD THE APPLICATION PROGRAM HERE

;

```

CMP     EXIT_AP, 1     ;is the application over?
JNE     W_LOOP         ;No, restart the application

```

```

MOV     AX, 6F02H      ;disable Watchdog Timer
MOV     BL, 0          ;
INT     15H

```

;

; EXIT ;

Appendix

G

Intel® Matrix Storage Manager

IMBA-C2360-i2 ATX Motherboard

G.1 Introduction

The IMBA-C2360-i2 can provide data protection for serial ATA (SATA) disks via the Intel® Matrix Storage Manager using one of three fault-tolerant RAID levels: RAID 1, 5 or 10. When using two hard drives, matrix RAID allows RAID 0 and RAID 1 functions to be combined, where critical files can be stored on RAID 1, and RAID 0 can be used for non-critical items such as software. RAID 5 and RAID 0 can be combined to provide higher performance, capacity, and fault tolerance.



CAUTION!

A configured RAID volume (which may consist of multiple hard drives) appears to an operating system as a contingent storage space. The operating system will not be able to distinguish the physical disk drives contained in a RAID configuration.

G.1.1 Precautions

One key benefit a RAID configuration brings is that a single hard drive can fail within a RAID array without damaging data. With RAID1 array, a failed drive can be replaced and the RAID configuration restored.



WARNING!

Irrecoverable data loss occurs if a working drive is removed when trying to remove a failed drive. It is strongly recommended to mark the physical connections of all SATA disk drives. Drive locations can be identified by attaching stickers to the drive bays. If a drive member of a RAID array should fail, the failed drive can then be correctly identified.

**CAUTION!**

Do not accidentally disconnect the SATA drive cables. Carefully route the cables within the chassis to avoid system down time.

G.2 Features and Benefits

- Supports RAID levels 0, 1, 5 and 10
- Supports connectivity to two or more disk drives

G.3 Accessing the Intel® Matrix Storage Manager

To access the Intel® Matrix Storage Manager, please follow the steps below.

Step 1: Connect SATA drives to the system. Connect two or more SATA drives to the system. Make sure the drives have the same capacity, are the same type and have the same speed.

**NOTE:**

Make sure the SATA drives are EXACTLY the same when they are configured in a RAID configuration. If they are not the same size, disk drive capacity is sacrificed and overall performance affected.

Step 2: Enable SATA drives in BIOS. Start the computer and access the BIOS setup program. Enable RAID support for all SATA devices. Refer to the applicable BIOS configuration section in this user manual.

Step 3: Configure “Option ROM Messages” BIOS option to Force BIOS. This is to allow the “Press <CTRL+I> to enter Configuration Utility.....” message to appear during the POST. Refer to the applicable BIOS configuration section in this user manual.

IMBA-C2360-i2 ATX Motherboard

- Step 4: Save and Exit BIOS.** After the SATA support option is enabled, save and exit the BIOS.
- Step 5: Reboot the system.** Reboot the system after saving and exiting the BIOS.
- Step 6: Press Ctrl+I. during the system boot process.** Press Ctrl+I when prompted to enter the RAID configuration software.
- Step 7: Configure the RAID settings.** Use the Intel® Matrix Storage Manager to configure the RAID array. Brief descriptions of configuration options are given below.

G.4 Installing the Operating System to the RAID Array

To install the operating system to the RAID array some extra steps are necessary during the installation process.

- Step 1: Prepare a RAID driver floppy disk on another computer.** If installing on the RAID array a RAID driver floppy disk must be made. The RAID driver floppy disk utility is on the CD in the “8-RST” folder. The floppy disk will be formatted and the drivers installed.
- Step 2: Restart the system with a floppy drive attached.** Attach a normal floppy drive or USB floppy drive to the system.
- Step 3: Press F6 when prompted.** During the installation process, Windows OS prompts the user to press F6 to install the RAID drivers. Press F6 and choose from the drivers on the floppy disk.
- Step 4: Install the OS.** Continue with OS installation as usual.

Appendix

H

Hazardous Materials Disclosure

IMBA-C2360-i2 ATX Motherboard

The details provided in this appendix are to ensure that the product is compliant with the Peoples Republic of China (China) RoHS standards. The table below acknowledges the presences of small quantities of certain materials in the product, and is applicable to China RoHS only.

A label will be placed on each product to indicate the estimated “Environmentally Friendly Use Period” (EFUP). This is an estimate of the number of years that these substances would “not leak out or undergo abrupt change.” This product may contain replaceable sub-assemblies/components which have a shorter EFUP such as batteries and lamps. These components will be separately marked.

Please refer to the below table.

Part Name	Toxic or Hazardous Substances and Elements					
	Lead (Pb)	Mercury (Hg)	Cadmium (Cd)	Hexavalent Chromium (CR(VI))	Polybrominated Biphenyls (PBB)	Polybrominated Diphenyl Ethers (PBDE)
Housing	O	O	O	O	O	O
Display	O	O	O	O	O	O
Printed Circuit Board	O	O	O	O	O	O
Metal Fasteners	O	O	O	O	O	O
Cable Assembly	O	O	O	O	O	O
Fan Assembly	O	O	O	O	O	O
Power Supply Assemblies	O	O	O	O	O	O
Battery	O	O	O	O	O	O

O: This toxic or hazardous substance is contained in all of the homogeneous materials for the part is below the limit requirement in SJ/T11363-2006 (now replaced by GB/T 26572-2011).

X: This toxic or hazardous substance is contained in at least one of the homogeneous materials for this part is above the limit requirement in SJ/T11363-2006 (now replaced by GB/T 26572-2011).

此附件旨在确保本产品符合中国 RoHS 标准。以下表格标示此产品中某有毒物质的含量符合中国 RoHS 标准规定的限量要求。

本产品上会附有“环境友好使用期限”的标签，此期限是估算这些物质“不会有泄漏或突变”的年限。本产品可能包含有较短的环境友好使用期限的可替换元件，像是电池或灯管，这些元件将会单独标示出来。

部件名称	有毒有害物质或元素					
	铅 (Pb)	汞 (Hg)	镉 (Cd)	六价铬 (CR(VI))	多溴联苯 (PBB)	多溴二苯 醚 (PBDE)
壳体	○	○	○	○	○	○
显示	○	○	○	○	○	○
印刷电路板	○	○	○	○	○	○
金属螺帽	○	○	○	○	○	○
电缆组装	○	○	○	○	○	○
风扇组装	○	○	○	○	○	○
电力供应组装	○	○	○	○	○	○
电池	○	○	○	○	○	○

○: 表示该有毒有害物质在该部件所有物质材料中的含量均在 SJ/T 11363-2006 (现由 GB/T 26572-2011 取代) 标准规定的限量要求以下。

X: 表示该有毒有害物质至少在该部件的某一均质材料中的含量超出 SJ/T 11363-2006 (现由 GB/T 26572-2011 取代) 标准规定的限量要求。