



IEI Technology Corp.



MODEL:

PICOe-HM650

Half-size PCIe CPU Card with Socket G2 32nm Intel® Core™ i7/i5/i3 CPU and Intel® HM65 Chipset, DDR3, VGA, USB 2.0, Dual PCIe GbE, SATA 6Gb/s, HD Audio, RoHS Compliant

User Manual

Rev. 1.00 – 10 February, 2012



Revision

Date	Version	Changes
10 February, 2012	1.00	Initial release

Copyright

COPYRIGHT NOTICE

The information in this document is subject to change without prior notice in order to improve reliability, design and function and does not represent a commitment on the part of the manufacturer.

In no event will the manufacturer be liable for direct, indirect, special, incidental, or consequential damages arising out of the use or inability to use the product or documentation, even if advised of the possibility of such damages.

This document contains proprietary information protected by copyright. All rights are reserved. No part of this manual may be reproduced by any mechanical, electronic, or other means in any form without prior written permission of the manufacturer.

TRADEMARKS

All registered trademarks and product names mentioned herein are used for identification purposes only and may be trademarks and/or registered trademarks of their respective owners.

Table of Contents

1 INTRODUCTION.....	1
1.1 INTRODUCTION.....	2
1.2 CONNECTORS	3
1.3 DIMENSIONS.....	4
1.4 DATA FLOW	5
1.5 TECHNICAL SPECIFICATIONS	6
2 UNPACKING	8
2.1 ANTI-STATIC PRECAUTIONS	9
2.2 UNPACKING PRECAUTIONS.....	9
2.3 UNPACKING CHECKLIST	10
2.3.1 <i>Package Contents</i>	10
2.3.2 <i>Optional Items</i>	11
3 CONNECTORS	13
3.1 PERIPHERAL INTERFACE CONNECTORS.....	14
3.1.1 <i>PICOe-HM650 Layout</i>	14
3.1.2 <i>Peripheral Interface Connectors</i>	14
3.1.3 <i>External Interface Panel Connectors</i>	16
3.2 INTERNAL PERIPHERAL CONNECTORS	16
3.2.1 <i>ATX Power Supply Enable Connector</i>	16
3.2.2 <i>Audio Connector</i>	17
3.2.3 <i>Battery Connector</i>	18
3.2.4 <i>CPU 12 V Power Connector</i>	19
3.2.5 <i>Digital Input/Output (DIO) Connector</i>	20
3.2.6 <i>EC Debug Connector</i>	21
3.2.7 <i>Fan Connector (CPU)</i>	22
3.2.8 <i>Fan Connector (System)</i>	23
3.2.9 <i>Front Panel Connector</i>	24
3.2.10 <i>I2C Connector</i>	25
3.2.11 <i>Infrared Interface Connector</i>	26

PIC0e-HM650 Half-size PCIe CPU Card

3.2.12	<i>LVDS Backlight Inverter Connector</i>	27
3.2.13	<i>Keyboard/Mouse Connector</i>	28
3.2.14	<i>LVDS LCD Connector</i>	29
3.2.15	<i>Parallel Port Connector</i>	31
3.2.16	<i>SATA 6Gb/s Connector</i>	32
3.2.17	<i>SATA 3Gb/s Connector</i>	33
3.2.18	<i>Serial Port Connectors (COM 1 and COM 2)</i>	34
3.2.19	<i>Serial Port Connector (COM3)</i>	35
3.2.20	<i>SMBus Connector</i>	36
3.2.21	<i>SPI Flash Connector (BIOS)</i>	37
3.2.22	<i>SPI Flash Connector (EC)</i>	38
3.2.23	<i>TPM Connector</i>	38
3.2.24	<i>USB Connectors (Internal)</i>	39
3.3	EXTERNAL PERIPHERAL INTERFACE CONNECTOR PANEL	40
3.3.1	<i>LAN Connectors</i>	41
3.3.2	<i>USB Connectors</i>	42
3.3.3	<i>VGA Connector</i>	42
4	INSTALLATION	44
4.1	ANTI-STATIC PRECAUTIONS	45
4.2	INSTALLATION CONSIDERATIONS	46
4.3	CPU AND MEMORY INSTALLATION	47
4.3.1	<i>Socket G2 CPU Installation</i>	47
4.3.2	<i>Socket G2 Cooling Kit Installation</i>	49
4.3.3	<i>SO-DIMM Installation</i>	52
4.4	JUMPER SETTINGS	54
4.4.1	<i>AT/ATX Power Mode Select Jumper</i>	54
4.4.2	<i>Clear CMOS Jumper</i>	55
4.4.3	<i>LVDS Voltage Selection Jumper</i>	57
4.4.4	<i>LVDS Panel Resolution Selection Jumper</i>	58
4.4.5	<i>PCIe Status Select Jumper</i>	59
4.4.6	<i>TPM Setting Jumper</i>	60
4.4.7	<i>Flash Descriptor Security Override Jumper</i>	61
4.5	CHASSIS INSTALLATION	62
4.5.1	<i>Airflow</i>	62

4.5.2 Backplane Installation	62
4.5.3 CPU Card Installation	62
4.6 INTERNAL PERIPHERAL DEVICE CONNECTIONS	63
4.6.1 Dual RS-232 Cable with Slot Bracket	63
4.6.2 SATA Drive Connection	64
4.6.3 USB Cable (Dual Port) with Slot Bracket	65
4.7 EXTERNAL PERIPHERAL INTERFACE CONNECTION	66
4.7.1 LAN Connection	67
4.7.2 USB Connection	67
4.7.3 VGA Monitor Connection	68
4.8 SOFTWARE INSTALLATION	69
5 BIOS SCREENS.....	71
5.1 INTRODUCTION.....	72
5.1.1 Starting Setup.....	72
5.1.2 Using Setup	72
5.1.3 Getting Help.....	73
5.1.4 Unable to Reboot After Configuration Changes.....	73
5.1.5 BIOS Menu Bar.....	73
5.2 MAIN.....	74
5.3 ADVANCED	75
5.3.1 ACPI Settings	75
5.3.2 Trusted Computing	76
5.3.3 CPU Configuration.....	77
5.3.4 SATA Configuration	79
5.3.5 USB Configuration.....	80
5.3.6 Super IO Configuration	81
5.3.6.1 Serial Port n Configuration	81
5.3.6.2 Parallel Port Configuration	85
5.3.7 H/W Monitor	86
5.3.7.1 FAN 1 Configuration	88
5.3.7.2 FAN 2 Configuration	88
5.3.8 Serial Port Console Redirection	90
5.3.9 IEI Feature.....	91
5.4 CHIPSET	91

PIC0e-HM650 Half-size PCIe CPU Card

5.4.1 Northbridge Configuration	93
5.4.1.1 Graphics Configuration.....	94
5.4.2 Southbridge Configuration	96
5.5 BOOT.....	97
5.6 SECURITY.....	99
5.7 EXIT	100
A BIOS OPTIONS	102
B ONE KEY RECOVERY	105
B.1 ONE KEY RECOVERY INTRODUCTION	106
B.1.1 System Requirement.....	107
B.1.2 Supported Operating System.....	108
B.2 SETUP PROCEDURE FOR WINDOWS	109
B.2.1 Hardware and BIOS Setup	110
B.2.2 Create Partitions	110
B.2.3 Install Operating System, Drivers and Applications.....	114
B.2.4 Building the Recovery Partition	115
B.2.5 Create Factory Default Image.....	117
B.3 AUTO RECOVERY SETUP PROCEDURE	122
B.4 SETUP PROCEDURE FOR LINUX	127
B.5 RECOVERY TOOL FUNCTIONS	130
B.5.1 Factory Restore	132
B.5.2 Backup System.....	133
B.5.3 Restore Your Last Backup.....	134
B.5.4 Manual.....	135
B.6 RESTORE SYSTEMS FROM A LINUX SERVER THROUGH LAN	136
B.6.1 Configure DHCP Server Settings	137
B.6.2 Configure TFTP Settings	138
B.6.3 Configure One Key Recovery Server Settings	139
B.6.4 Start the DHCP, TFTP and HTTP	140
B.6.5 Create Shared Directory.....	140
B.6.6 Setup a Client System for Auto Recovery	141
B.7 OTHER INFORMATION	144
B.7.1 Using AHCI Mode or ALi M5283 / VIA VT6421A Controller.....	144
B.7.2 System Memory Requirement	146

C TERMINOLOGY	147
D DIGITAL I/O INTERFACE.....	151
D.1 INTRODUCTION.....	152
D.2 DIO CONNECTOR PINOUTS	152
D.3 ASSEMBLY LANGUAGE SAMPLES.....	153
<i>D.3.1 Enable the DIO Input Function</i>	<i>153</i>
<i>D.3.2 Enable the DIO Output Function.....</i>	<i>153</i>
E WATCHDOG TIMER.....	154
F HAZARDOUS MATERIALS DISCLOSURE.....	157
F.1 HAZARDOUS MATERIALS DISCLOSURE TABLE FOR IPB PRODUCTS CERTIFIED AS ROHS COMPLIANT UNDER 2002/95/EC WITHOUT MERCURY	158

List of Figures

Figure 1-1: PIC0e-HM650 Half-size CPU Card.....	2
Figure 1-2: Connectors	3
Figure 1-3: PIC0e-HM650 Dimensions (mm)	4
Figure 1-4: Data Flow Block Diagram.....	5
Figure 3-1: Connector and Jumper Locations.....	14
Figure 3-2: ATX Power Supply Enable Connector Location	17
Figure 3-3: Audio Connector Location	18
Figure 3-4: Battery Connector Location.....	19
Figure 3-5: CPU Power Connector Location.....	20
Figure 3-6: DIO Connector Location.....	21
Figure 3-7: EC Debug Connector Location	22
Figure 3-8: CPU Fan Connector Location	23
Figure 3-9: System Fan Connector Location.....	24
Figure 3-10: Front Panel Connector Location	25
Figure 3-11: I2C Connector Location.....	26
Figure 3-12: Infrared Connector Location.....	27
Figure 3-13: Backlight Inverter Connector Location.....	28
Figure 3-14: Keyboard/Mouse Connector Location	29
Figure 3-15: LVDS Connector Location.....	30
Figure 3-16: Parallel Port Connector Location	31
Figure 3-17: SATA Drive Connector Locations	32
Figure 3-18: SATA Drive Connector Locations	33
Figure 3-19: COM Connector Locations.....	34
Figure 3-20: Serial Port Connector Location	35
Figure 3-21: SMBus Connector Location	36
Figure 3-22: SPI Flash Connector Location.....	37
Figure 3-23: SPI Flash Connector Location.....	38
Figure 3-24: TPM Connector Location.....	39
Figure 3-25: USB Connector Locations.....	40
Figure 3-26: PIC0e-HM650 External Peripheral Interface Connector	41

Figure 3-27: RJ-45 Ethernet Connector.....	41
Figure 3-28: VGA Connector	43
Figure 4-1: Unlocked Retention Screw.....	48
Figure 4-2: Lock CPU Socket Retention Screw	49
Figure 4-3: Cooling Kit.....	49
Figure 4-4: Install Support Bracket.....	50
Figure 4-5: Align the Cooling Kit.....	51
Figure 4-6: Secure the Cooling Kit.....	52
Figure 4-7: SO-DIMM Installation	53
Figure 4-8: AT/ATX Power Mode Jumper Location.....	55
Figure 4-9: Clear CMOS Jumper	56
Figure 4-10: LVDS Voltage Selection Jumper Location	57
Figure 4-11: LVDS Screen Resolution Jumper Locations.....	59
Figure 4-12: PCIe Status Select Jumper Pinout Locations	60
Figure 4-13: TPM Setting Jumper Location	60
Figure 4-14: Flash Descriptor Security Override Jumper Location	61
Figure 4-15: Dual RS-232 Cable Installation	63
Figure 4-16: SATA Drive Cable Connection.....	64
Figure 4-17: SATA Power Drive Connection.....	65
Figure 4-18: Dual USB Cable Connection	66
Figure 4-19: LAN Connection	67
Figure 4-20: USB Connector.....	68
Figure 4-21: VGA Connector	69
Figure 4-22: Introduction Screen	70
Figure 4-23: Available Drivers	70
Figure B-1: IEI One Key Recovery Tool Menu	106
Figure B-2: Launching the Recovery Tool	111
Figure B-3: Recovery Tool Setup Menu	111
Figure B-4: Command Prompt	112
Figure B-5: Partition Creation Commands.....	113
Figure B-6: Launching the Recovery Tool	115
Figure B-7: Manual Recovery Environment for Windows	115
Figure B-8: Building the Recovery Partition.....	116
Figure B-9: Press Any Key to Continue	116
Figure B-10: Press F3 to Boot into Recovery Mode.....	117

PIC0e-HM650 Half-size PCIe CPU Card

Figure B-11: Recovery Tool Menu	117
Figure B-12: About Symantec Ghost Window	118
Figure B-13: Symantec Ghost Path	118
Figure B-14: Select a Local Source Drive	119
Figure B-15: Select a Source Partition from Basic Drive	119
Figure B-16: File Name to Copy Image to	120
Figure B-17: Compress Image.....	120
Figure B-18: Image Creation Confirmation	121
Figure B-19: Image Creation Complete	121
Figure B-20: Image Creation Complete	121
Figure B-21: Press Any Key to Continue	122
Figure B-22: Auto Recovery Utility	123
Figure B-23: Disable Automatically Restart.....	123
Figure B-24: Launching the Recovery Tool	124
Figure B-25: Auto Recovery Environment for Windows	124
Figure B-26: Building the Auto Recovery Partition.....	125
Figure B-27: Factory Default Image Confirmation	125
Figure B-28: Image Creation Complete	126
Figure B-29: Press any key to continue	126
Figure B-30: Partitions for Linux.....	128
Figure B-31: Manual Recovery Environment for Linux	129
Figure B-32: Access menu.lst in Linux (Text Mode).....	129
Figure B-33: Recovery Tool Menu	130
Figure B-34: Recovery Tool Main Menu	131
Figure B-35: Restore Factory Default.....	132
Figure B-36: Recovery Complete Window	132
Figure B-37: Backup System.....	133
Figure B-38: System Backup Complete Window	133
Figure B-39: Restore Backup	134
Figure B-40: Restore System Backup Complete Window	134
Figure B-41: Symantec Ghost Window	135
Figure B-42: Disable Automatically Restart.....	142

List of Tables

Table 1-1: Technical Specifications.....	7
Table 3-1: Peripheral Interface Connectors.....	15
Table 3-2: Rear Panel Connectors.....	16
Table 3-3: ATX Power Supply Enable Connector Pinouts.....	17
Table 3-4: Audio Connector Pinouts.....	18
Table 3-5: Battery Connector Pinouts.....	19
Table 3-6: CPU Power Connector Pinouts.....	20
Table 3-7: DIO Connector Connector Pinouts.....	21
Table 3-8: EC Debug Connector Pinouts.....	22
Table 3-9: CPU Fan Connector Pinouts.....	23
Table 3-10: System Fan Connector Pinouts.....	24
Table 3-11: Front Panel Connector Pinouts.....	25
Table 3-12: I2C Connector Pinouts.....	26
Table 3-13: Infrared Connector Pinouts.....	27
Table 3-14: Backlight Inverter Connector Pinouts.....	28
Table 3-15: Keyboard/Mouse Connector Pinouts.....	29
Table 3-16: LVDS Connector Pinouts.....	30
Table 3-17: Parallel Port Connector Pinouts.....	32
Table 3-18: SATA Drive Connector Pinouts.....	33
Table 3-19: SATA Drive Connector Pinouts.....	34
Table 3-20: COM Connector Pinouts.....	34
Table 3-21: Serial Port Connector Pinouts.....	35
Table 3-22: DB-9 RS-422/485 Pinouts.....	36
Table 3-23: SMBus Connector Pinouts.....	37
Table 3-24: SPI Flash Connector.....	37
Table 3-25: SPI Flash Connector.....	38
Table 3-26: TPM Connector Pinouts.....	39
Table 3-27: USB Port Connector Pinouts.....	40
Table 3-28: LAN Pinouts.....	41
Table 3-29: RJ-45 Ethernet Connector LEDs.....	42

PIC0e-HM650 Half-size PCIe CPU Card

Table 3-30: USB Port Pinouts.....	42
Table 3-31: VGA Connector Pinouts.....	43
Table 4-1: Jumpers	54
Table 4-2: AT/ATX Power Mode Jumper Settings	55
Table 4-3: Clear CMOS Jumper Settings.....	56
Table 4-4: LVDS Voltage Selection Jumper Settings.....	57
Table 4-5: LVDS Screen Resolution Jumper Settings	58
Table 4-6: PCIe Status Select Jumper Settings.....	59
Table 4-7: TPM Setting Jumper Settings.....	60
Table 4-8: Flash Descriptor Security Override Jumper Settings.....	61
Table 5-1: BIOS Navigation Keys	73

BIOS Menus

BIOS Menu 1: Main	74
BIOS Menu 2: Advanced	75
BIOS Menu 3: ACPI Configuration	76
BIOS Menu 4: TPM Configuration	77
BIOS Menu 5: CPU Configuration	78
BIOS Menu 6: SATA Configuration	79
BIOS Menu 7: USB Configuration	80
BIOS Menu 8: Super IO Configuration.....	81
BIOS Menu 9: Serial Port n Configuration Menu	81
BIOS Menu 10: Parallel Port Configuration Menu	85
BIOS Menu 11: H/W Monitor	87
BIOS Menu 12: FAN 1 Configuration	88
BIOS Menu 13: FAN 2 Configuration	89
BIOS Menu 14: Serial Port Console Redirection	90
BIOS Menu 15: IEI Feature	91
BIOS Menu 16: Chipset	92
BIOS Menu 17:Northbridge Chipset Configuration.....	93
BIOS Menu 18:Graphics Configuration	94
BIOS Menu 19: Southbridge Chipset Configuration	96
BIOS Menu 20: Boot	97
BIOS Menu 21: Security	99
BIOS Menu 22:Exit.....	100
BIOS Menu 23: IEI Feature	127

Chapter

1

Introduction

1.1 Introduction



Figure 1-1: PICOe-HM650 Half-size CPU Card

The PICOe-HM650 half-size PCIe CPU card is an embedded Socket G2 Intel® Core™ processor i3, i5 or i7 platform. The PICOe-HM650 supports two 204-pin 1066/1333 MHz DDR3 SDRAM SO-DIMMs (system max. 16.0 GB). The board includes one VGA connector, and supports a dual-display configuration.

The PICOe-HM650 also comes with two Gigabit Ethernet (GbE) connectors, two SATA 6Gb/s connector, two SATA 3Gb/s connector and eight USB 2.0 connector. Serial device connectivity is provided by two internal RS-232 connectors and one internal RS-422/485 connector.

The PICOe-HM650 supports an optional Trusted Platform Module (TPM) to provide a trusted and secure base for various applications.

PICOe-HM650 Half-size PCIe CPU Card

1.2 Connectors

The connectors on the PICOe-HM650 are shown in the figure below.

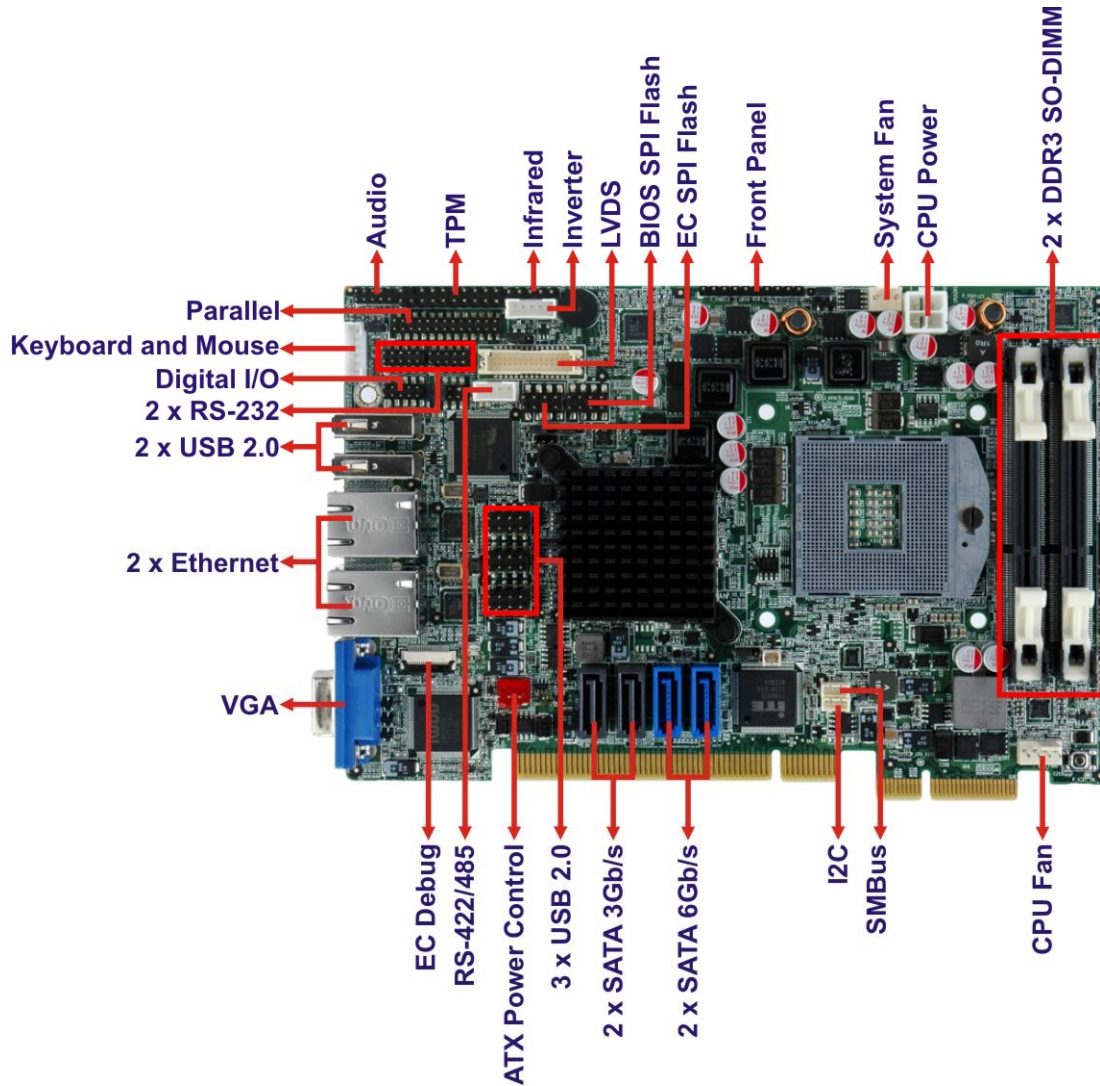

Figure 1-2: Connectors

1.3 Dimensions

The dimensions of the board are listed below:

- Length: 185 mm
- Width: 122 mm

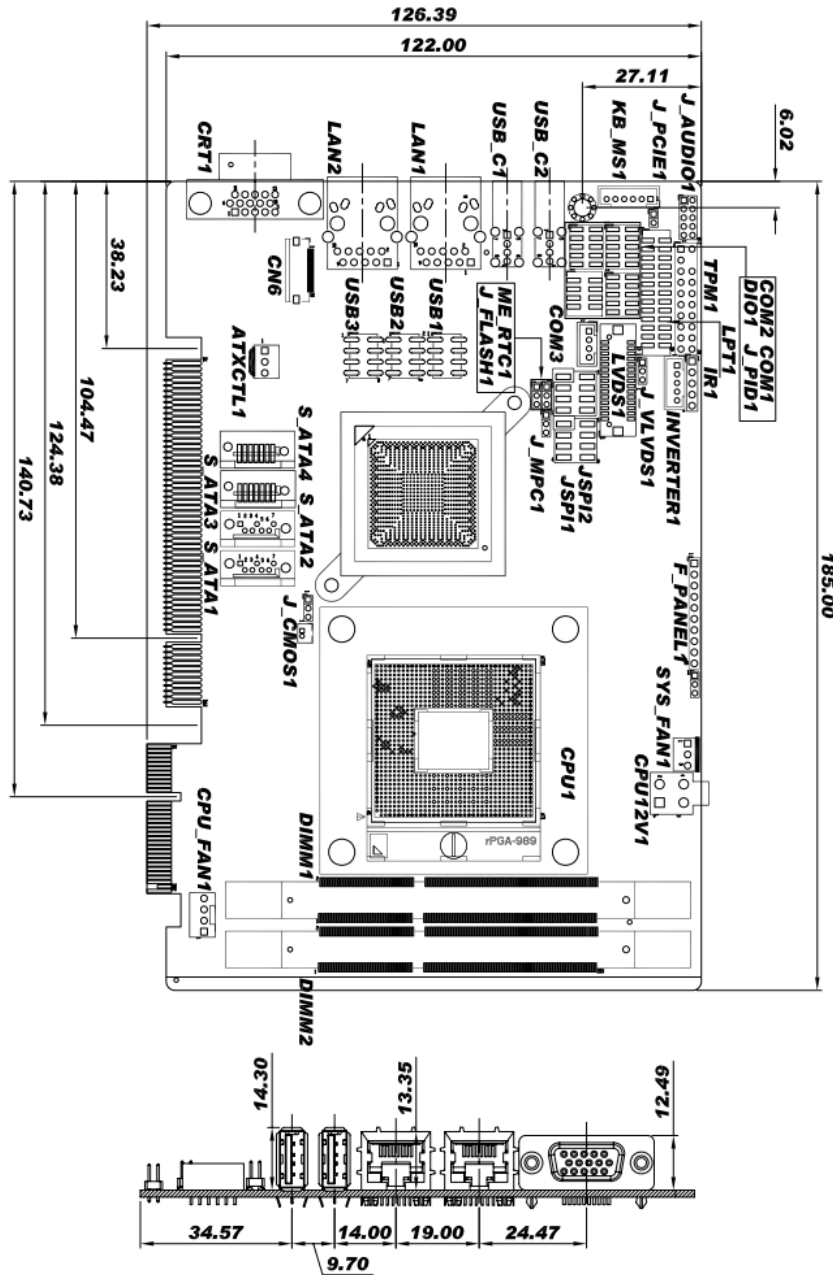

Figure 1-3: PIC0e-HM650 Dimensions (mm)

PIC0e-HM650 Half-size PCIe CPU Card

1.4 Data Flow

Figure 1-4 shows the data flow between the two on-board chipsets and other components installed on the motherboard and described in the following sections of this chapter.

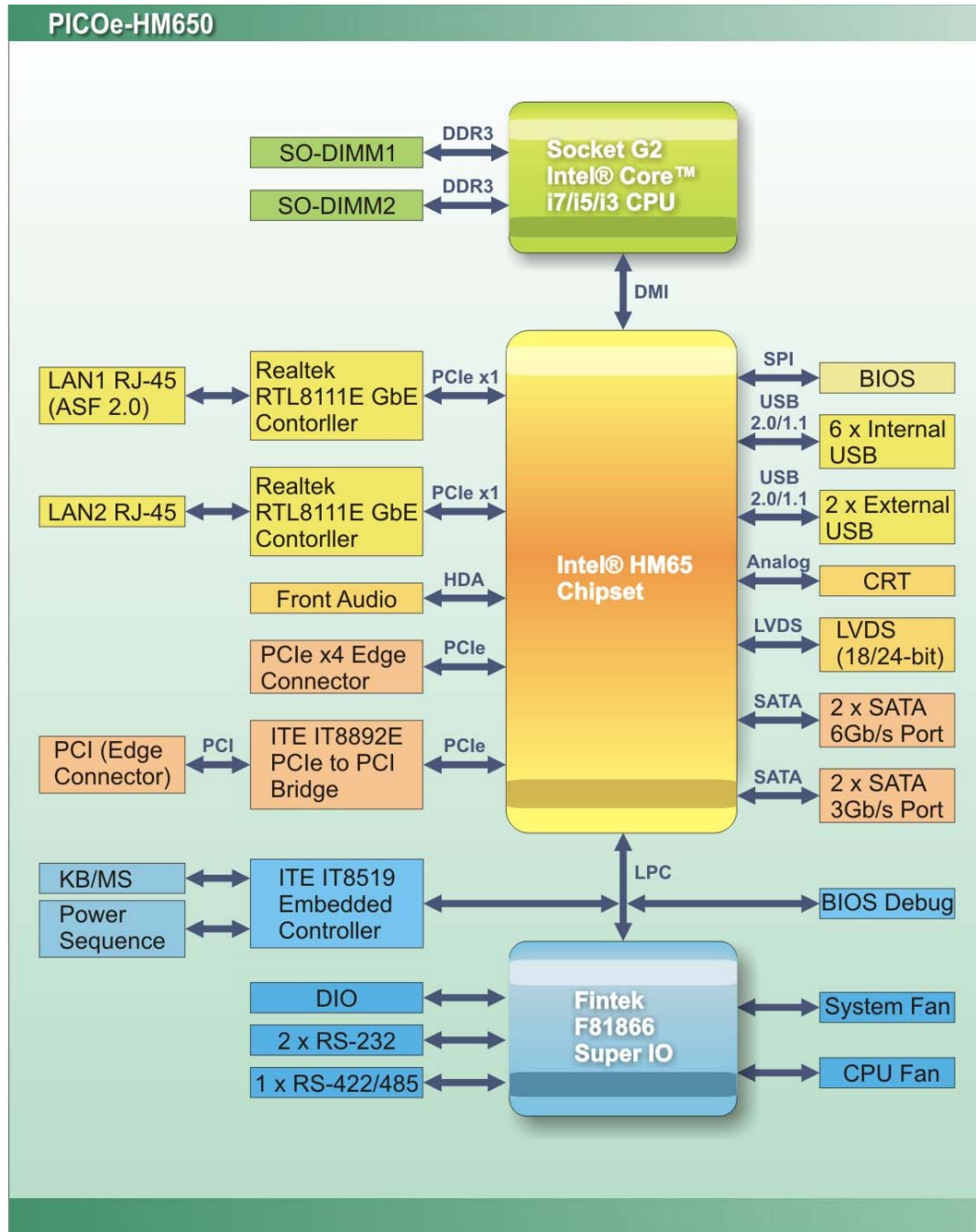

Figure 1-4: Data Flow Block Diagram

1.5 Technical Specifications

PIC0e-HM650 technical specifications are listed in table below.

Specification	PIC0e-HM650
Form Factor	Half-size PCIe CPU Card
CPU Socket	Socket G2
CPU Options	Intel® Core™ i7/i5/i3 quad-core/dual-core processor Intel® Celeron® processor
System Chipset	Intel® HM65
Graphics Engine	Intel® HD Graphics Gen 6 support for DX10.1 and OpenGL 3.0 Full MPEG2, VC1, AVC Decode
Memory	Two 204-pin SO-DIMM sockets support two 1333/1066 MHz DDR3 SDRAM SO-DIMM (system max. 16 GB)
Ethernet Controller	Two Realtek RTL8111E PCIe GbE controllers (LAN1 with ASF2.0 support)
BIOS	UEFI BIOS
Super I/O	Fintek F81866
Embedded Controller	ITE IT8519E
PCIe to PCI Bridge Controller	ITE IT8892E
Digital I/O	8-bit digital I/O (4-bit input, 4-bit output)
Watchdog Timer	Software programmable supports 1~255 sec. system reset
Expansion	
PCI	PCI signal via golden finger
PCIe	Four PCIe x1 via golden finger
I/O Interface Connectors	
Display	One VGA port (VGA integrated in Intel® HM65) 18/24-bit dual-channel LVDS
Ethernet	Two RJ-45 GbE ports
Audio	Supports 7.1 channel HD audio via optional IEI AC-KIT-888HD kit

PIC0e-HM650 Half-size PCIe CPU Card

Specification	PIC0e-HM650
Serial Ports	Two RS-232 serial ports via internal 10-pin header One RS-422/485 serial ports via internal 4-pin wafer
USB 2.0 ports	Two external USB ports Six USB ports via internal pin headers
Parallel Port	One 26-pin header
Infrared	One 5-pin header
Keyboard/Mouse	One keyboard and mouse connector via internal 6-pin header
SMBus	One 4-pin wafer connector
I²C	One 4-pin wafer connector
Fan	One 4-pin wafer smart fan connector One 3-pin wafer system fan connector
TPM	One 20-pin header supports optional Infineon TPM module
Storage	
Serial ATA	Two SATA 6Gb/s ports Two SATA 3Gb/s ports
Environmental and Power Specifications	
Power Supply	5 V / 12 V, AT/ATX power support
Power Consumption	5V@3.99A, 12V@0.43A, Vcore_12V@3.80A, 5VSB@0.06A (2.7GHz Intel® Core™ i7-2620M with two 2GB 1333MHz DDR3 memory)
Operating Temperature	-10°C~60°C
Storage Temperature	-20°C~70°C
Humidity	5% ~ 95% (non-condensing)
Physical Specifications	
Dimensions	185 mm x 122 mm
Weight GW/NW	1000g/260g

Table 1-1: Technical Specifications

Chapter

2

Unpacking

PIC0e-HM650 Half-size PCIe CPU Card

2.1 Anti-static Precautions



WARNING!

Static electricity can destroy certain electronics. Make sure to follow the ESD precautions to prevent damage to the product, and injury to the user.

Make sure to adhere to the following guidelines:

- ***Wear an anti-static wristband:*** Wearing an anti-static wristband can prevent electrostatic discharge.
- ***Self-grounding:*** Touch a grounded conductor every few minutes to discharge any excess static buildup.
- ***Use an anti-static pad:*** When configuring any circuit board, place it on an anti-static mat.
- ***Only handle the edges of the PCB:*** Don't touch the surface of the motherboard. Hold the motherboard by the edges when handling.

2.2 Unpacking Precautions

When the PIC0e-HM650 is unpacked, please do the following:

- Follow the antistatic guidelines above.
- Make sure the packing box is facing upwards when opening.
- Make sure all the packing list items are present.

2.3 Unpacking Checklist







NOTE:



If any of the components listed in the checklist below are missing, do not proceed with the installation. Contact the IEI reseller or vendor the PIC0e-HM650 was purchased from or contact an IEI sales representative directly by sending an email to sales@iei.com.tw.

2.3.1 Package Contents

The PIC0e-HM650 is shipped with the following components:





Quantity	Item and Part Number	Image
1	PIC0e-HM650 CPU card	
2	SATA cable (P/N: 32000-062800-RS)	
1	Dual RS-232 cable (P/N: 19800-000051-RS)	
1	Dual USB cable (w bracket) (P/N: CB-USB02-RS)	
1	Mini jumper pack	





PIC0e-HM650 Half-size PCIe CPU Card

1	Utility CD	
1	One Key Recovery CD	
1	Quick Installation Guide	

2.3.2 Optional Items

The PIC0e-HM650 is shipped with the following components:

Item and Part Number	Image
SATA power cable (P/N: 32102-000100-200-RS)	
RS-422/485 cable, 200 mm (P/N: 32200-074800-RS)	
KB/MS cable (with bracket) (P/N: 19800-000075-RS)	
LPT cable (wo bracket) (P/N: 32200-015100-RS)	
SATA to IDE/CompactFlash® converter board (P/N: SAIDE-KIT01-R10)	

<p>7.1 Channel HD Audio kit with Realtek ALC888 (P/N: AC-KIT-888HD-R10)</p>	
<p>Infineon TPM module (P/N: TPM-IN01-R11)</p>	
<p>CPU cooler (P/N: CF-989A-RS-R12)</p>	
<p>CPU cooler (P/N: CF-989B-RS)</p>	

Chapter

3

Connectors

3.1 Peripheral Interface Connectors

Section 3.1.1 shows peripheral interface connector locations. Section 3.2 lists all the peripheral interface connectors seen in Section 3.1.1.

3.1.1 PICOe-HM650 Layout

Figure 3-1 shows the on-board peripheral connectors, rear panel peripheral connectors and on-board jumpers.

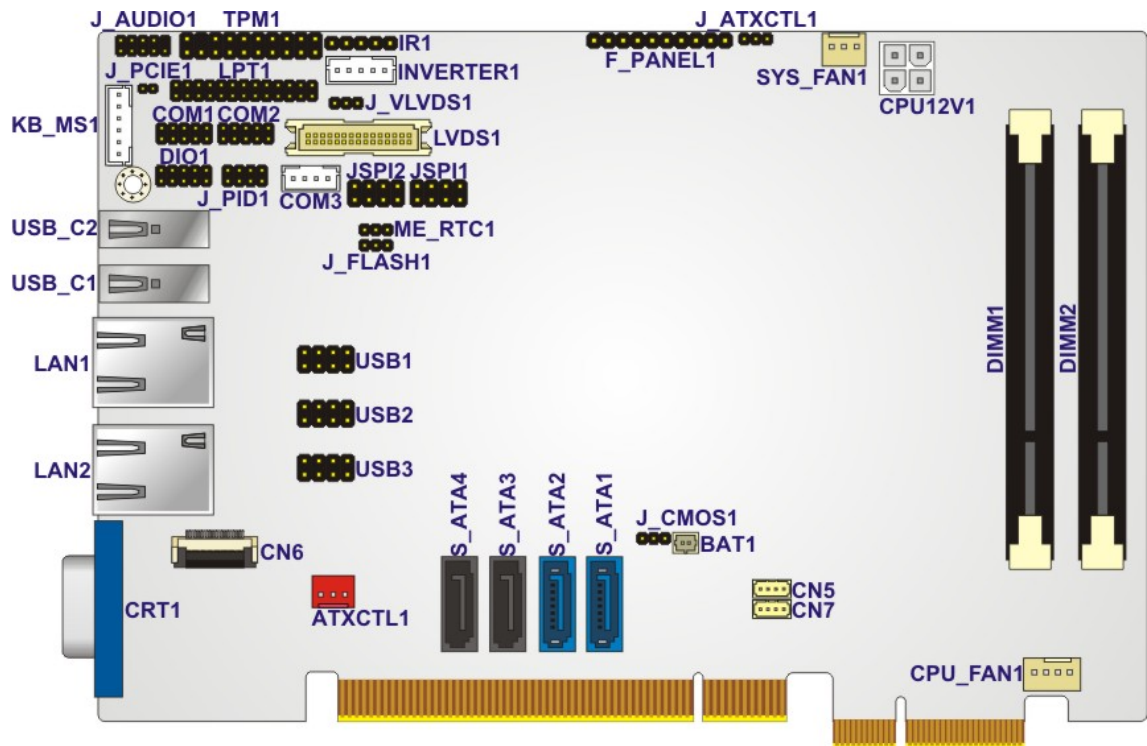

Figure 3-1: Connector and Jumper Locations

3.1.2 Peripheral Interface Connectors

Table 3-1 shows a list of the peripheral interface connectors on the PICOe-HM650. Detailed descriptions of these connectors can be found below.

Connector	Type	Label
ATX power control connector	3-pin wafer	ATXCTL1
Audio connector	9-pin header	J_AUDIO1

PIC0e-HM650 Half-size PCIe CPU Card

Connector	Type	Label
Battery connector	2-pin wafer	BAT1
CPU power connector	4-pin connector	CPU12V1
DDR3 SO-DIMM	204-pin SO-DIMM	DIMM1, DIMM2
Digital input/output (DIO) connector	10-pin header	DIO1
EC debug connector	20-pin FPC connector	CN6
Fan connector (CPU)	4-pin wafer	CPU_FAN1
Fan connector (system)	4-pin wafer	SYS_FAN1
Front panel connector	10-pin header	F_PANEL1
I ² C connector	4-pin wafer	CN7
Infrared connector	5-pin header	IR1
Inverter connector	5-pin wafer	INVERTER1
Keyboard and mouse connector	6-pin wafer	KB_MS1
LVDS connector	30-pin crimp	LVDS1
Parallel port connector	26-pin header	LPT1
SATA 6Gb/s connector	7-pin SATA	S_ATA1, S_ATA2
SATA 3Gb/s connector	7-pin SATA	S_ATA3, S_ATA4
Serial port connectors (RS-232)	10-pin header	COM1, COM2
Serial port connector (RS-422/485)	4-pin header	COM3
SMBus connector	4-pin wafer	CN5
SPI flash connector (BIOS)	8-pin header	JSPI1
SPI flash connector (EC)	8-pin header	JSPI2
TPM connector	20-pin header	TPM1
USB 2.0 connector	8-pin header	USB1, USB2, USB3

Table 3-1: Peripheral Interface Connectors

3.1.3 External Interface Panel Connectors

Table 3-2 lists the rear panel connectors on the PIC0e-HM650. Detailed descriptions of these connectors can be found in **Section 3.3** on **page 40**.

Connector	Type	Label
Ethernet connector	RJ-45	LAN1, LAN2
USB 2.0 port	USB port	USB_C1, USB_C2
VGA port connector	15-pin female	CRT1

Table 3-2: Rear Panel Connectors

3.2 Internal Peripheral Connectors

Internal peripheral connectors are found on the CPU card and are only accessible when the CPU card is outside of the chassis. This section has complete descriptions of all the internal, peripheral connectors on the PIC0e-HM650.

3.2.1 ATX Power Supply Enable Connector

- CN Label:** ATXCTL1
- CN Type:** 3-pin wafer (1x3)
- CN Location:** See **Figure 3-2**
- CN Pinouts:** See **Table 3-3**

The ATX power supply enable connector enables the PIC0e-HM650 to be connected to an ATX power supply. In default mode, the PIC0e-HM650 can only use an AT power supply. To enable an ATX power supply the AT Power Select jumper must also be configured. Please refer to **Section 4.4.1** for more details.

PICOe-HM650 Half-size PCIe CPU Card

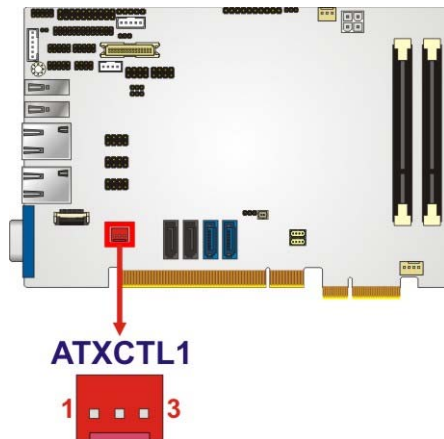

Figure 3-2: ATX Power Supply Enable Connector Location

Pin	Description
1	GND
2	PS-ON
3	+5 Standby

Table 3-3: ATX Power Supply Enable Connector Pinouts

3.2.2 Audio Connector

- CN Label:** J_AUDIO1
- CN Type:** 9-pin header (2x5)
- CN Location:** See Figure 3-3
- CN Pinouts:** See Table 3-4

The 9-pin audio connector is connected to external audio devices including speakers and microphones for the input and output of audio signals to and from the system.

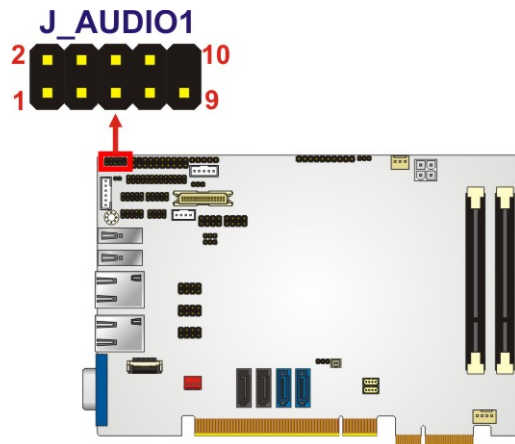
Figure 3-3: Audio Connector Location

Pin	Description	Pin	Description
1	HDA_SYNC	2	HDA_BITCLK
3	HDA_SDOUT	4	SB_SPKR
5	HDA_SDINO	6	HDA_RST#
7	+5V	8	GND
9	+12V	10	GND

Table 3-4: Audio Connector Pinouts

3.2.3 Battery Connector

- CN Label:** **BAT1**
- CN Type:** 2-pin wafer (1x2)
- CN Location:** See **Figure 3-4**
- CN Pinouts:** See **Table 3-5**

This is connected to the system battery. The battery provides power to the system clock to retain the time when power is turned off.

PICOe-HM650 Half-size PCIe CPU Card

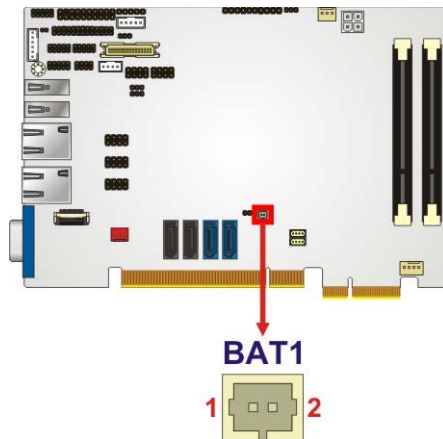

Figure 3-4: Battery Connector Location

Pin	Description
1	Battery+
2	Ground

Table 3-5: Battery Connector Pinouts

3.2.4 CPU 12 V Power Connector

- CN Label:** CPU12V1
- CN Type:** 4-pin connector (2x2)
- CN Location:** See **Figure 3-5**
- CN Pinouts:** See **Table 3-6**

This connector accepts 12 V of power for the processor.

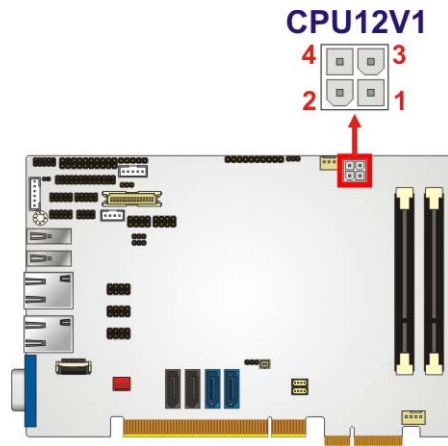
Figure 3-5: CPU Power Connector Location

Pin	Description	Pin	Description
1	GND	2	GND
3	+12 V	4	+12 V

Table 3-6: CPU Power Connector Pinouts

3.2.5 Digital Input/Output (DIO) Connector

- CN Label:** DIO1
- CN Type:** 10-pin header (2x5)
- CN Location:** See **Figure 3-6**
- CN Pinouts:** See **Table 3-7**

The digital input/output connector is managed through a Super I/O chip. The DIO connector pins are user programmable.

PIC0e-HM650 Half-size PCIe CPU Card

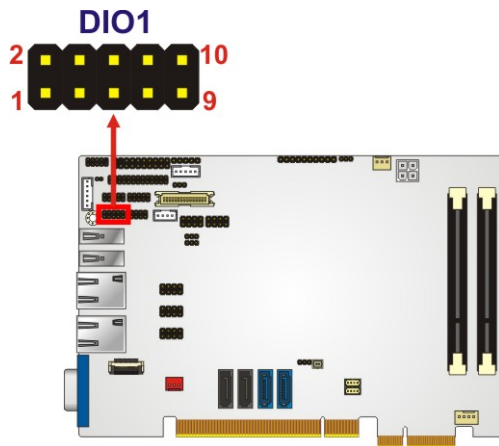

Figure 3-6: DIO Connector Location

Pin	Description	Pin	Description
1	GND	2	+5V
3	Output 3	4	Output 2
5	Output 1	6	Output 0
7	Input 3	8	Input 2
9	Input 1	10	Input 0

Table 3-7: DIO Connector Connector Pinouts

3.2.6 EC Debug Connector

- CN Label:** CN6
- CN Type:** 20-pin FPC connector (1x20)
- CN Location:** See **Figure 3-7**
- CN Pinouts:** See **Table 3-8**

The EC debug connector connects to a debug card for Embedded Controller (EC) debug.

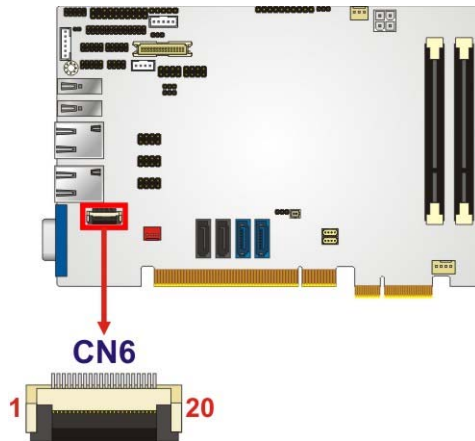

Figure 3-7: EC Debug Connector Location

Pin	Description	Pin	Description
1	EC_EPP_STB#	11	EC_EPP_BUSY
2	EC_EPP_PD0	12	EC_EPP_KSI5
3	EC_EPP_PD1	13	EC_EPP_KSI4
4	EC_EPP_PD2	14	EC_EPP_AFD#
5	EC_EPP_PD3	15	NC
6	EC_EPP_PD4	16	EC_EPP_INIT#
7	EC_EPP_PD5	17	EC_EPP_SLIN#
8	EC_EPP_PD6	18	GND
9	EC_EPP_PD7	19	GND
10	NC	20	GND

Table 3-8: EC Debug Connector Pinouts

3.2.7 Fan Connector (CPU)

- CN Label:** CPU_FAN1
- CN Type:** 4-pin wafer (1x4)
- CN Location:** See **Figure 3-8**
- CN Pinouts:** See **Table 3-9**

PIC0e-HM650 Half-size PCIe CPU Card

The cooling fan connector provides a 12V, 500mA current to the cooling fan. The connector has a "rotation" pin to get rotation signals from fans and notify the system so the system BIOS can recognize the fan speed. Please note that only specified fans can issue the rotation signals.

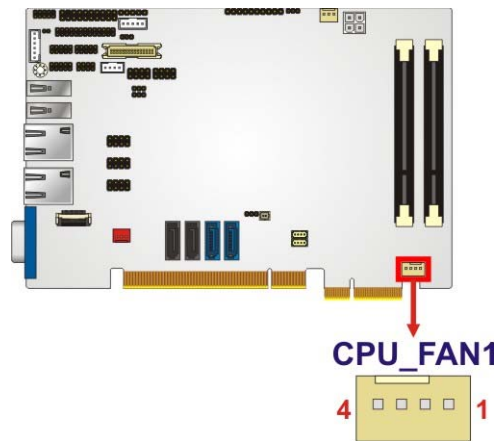

Figure 3-8: CPU Fan Connector Location

Pin	Description
1	GND
2	+12V
3	Rotation Signal
4	Control

Table 3-9: CPU Fan Connector Pinouts

3.2.8 Fan Connector (System)

- CN Label:** SYS_FAN1
- CN Type:** 3-pin wafer (1x3)
- CN Location:** See **Figure 3-9**
- CN Pinouts:** See **Table 3-10**

The cooling fan connector provides a 12V, 500mA current to the cooling fan. The connector has a "rotation" pin to get rotation signals from fans and notify the system so the system BIOS can recognize the fan speed. Please note that only specified fans can issue the rotation signals.

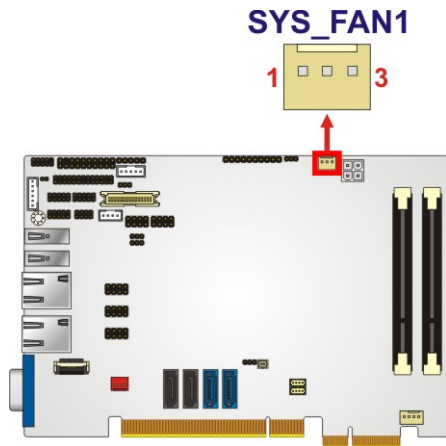
Figure 3-9: System Fan Connector Location

Pin	Description
1	Rotation Signal
2	+12V
3	GND

Table 3-10: System Fan Connector Pinouts

3.2.9 Front Panel Connector

- CN Label:** F_PANEL1
- CN Type:** 10-pin header (1x10)
- CN Location:** See **Figure 3-10**
- CN Pinouts:** See **Table 3-11**

The front panel connector connects to external switches and indicators to monitor and controls the CPU card. These indicators and switches include:

- HDD LED
- Power button
- Power LED
- Reset

PICOe-HM650 Half-size PCIe CPU Card

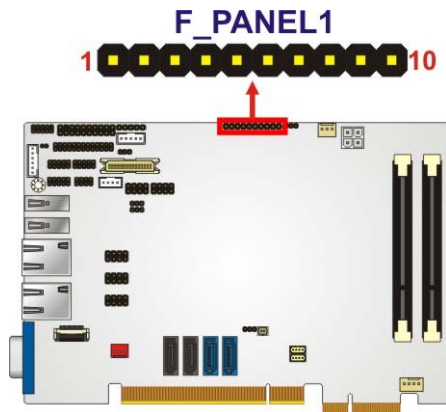

Figure 3-10: Front Panel Connector Location

FUNCTION	PIN	DESCRIPTION	FUNCTION	PIN	DESCRIPTION
	1	N/A	Power LED	6	PWR_LED+
Power Button	2	GND		7	PWR_LED+
	3	PWR_BTN-		8	GND
HDD LED	4	IDE_LED_PWR	Reset	6	RESET-
	5	SATA_LED-		8	GND

Table 3-11: Front Panel Connector Pinouts

3.2.10 I2C Connector

- CN Label:** CN7
- CN Type:** 4-pin wafer (1x4)
- CN Location:** See **Figure 3-11**
- CN Pinouts:** See **Table 3-12**

The I2C connector is used to connect I²C-bus devices to the mainboard.

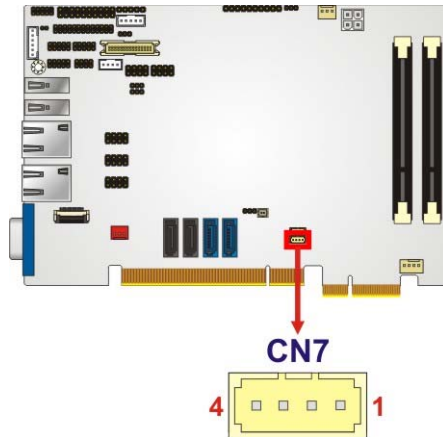
Figure 3-11: I2C Connector Location

Pin	Description
1	GND
2	PCH_GP38_PU
3	PCH_GP39_PU
4	+V5S

Table 3-12: I2C Connector Pinouts

3.2.11 Infrared Interface Connector

- CN Label:** IR1
- CN Type:** 5-pin header (1x5)
- CN Location:** See **Figure 3-12**
- CN Pinouts:** See **Table 3-13**

The infrared connector attaches to an infrared receiver for use with remote controls.

PICOe-HM650 Half-size PCIe CPU Card

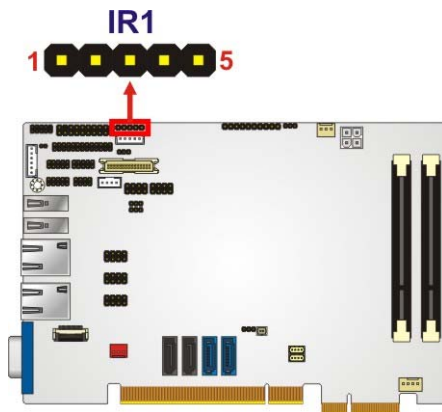

Figure 3-12: Infrared Connector Location

Pin	Description
1	VCC
2	NC
3	IR-RX
4	GND
5	IR-TX

Table 3-13: Infrared Connector Pinouts

3.2.12 LVDS Backlight Inverter Connector

CN Label:	INVERTER1
CN Type:	5-pin wafer (1x5)
CN Location:	See Figure 3-13
CN Pinouts:	See Table 3-14

The backlight inverter connector provides power to an LCD panel.

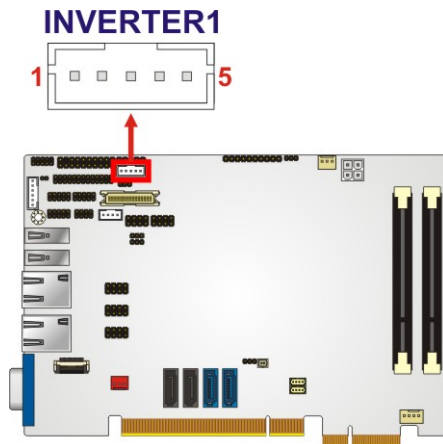
Figure 3-13: Backlight Inverter Connector Location

Pin	Description
1	BACKLIGHT ADJUST
2	GROUND
3	+12 V
4	GROUND
5	BACKLIGHT ENABLE

Table 3-14: Backlight Inverter Connector Pinouts

3.2.13 Keyboard/Mouse Connector

CN Label:	KB_MS1
CN Type:	6-pin wafer (1x6)
CN Location:	See Figure 3-14
CN Pinouts:	See Table 3-15

The keyboard and mouse connector can be connected to a standard PS/2 cable or PS/2 Y-cable to add keyboard and mouse functionality to the system.

PIC0e-HM650 Half-size PCIe CPU Card

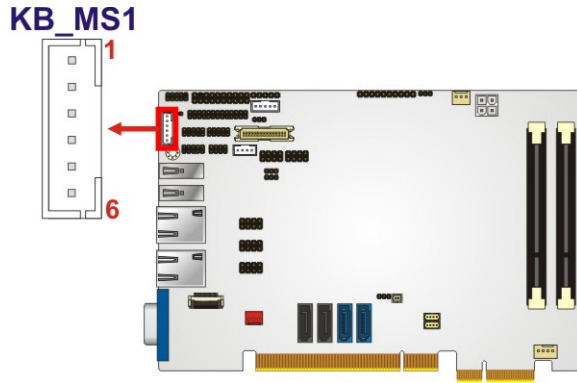

Figure 3-14: Keyboard/Mouse Connector Location

Pin	Description
1	VCC5_KBMS
2	MS DATA
3	MS CLK
4	KB DATA
5	KB CLK
6	GROUND

Table 3-15: Keyboard/Mouse Connector Pinouts

3.2.14 LVDS LCD Connector

- CN Label:** LVDS1
- CN Type:** 30-pin crimp (2x15)
- CN Location:** See **Figure 3-15**
- CN Pinouts:** See **Table 3-16**

The LVDS connector is for an LCD panel connected to the board.

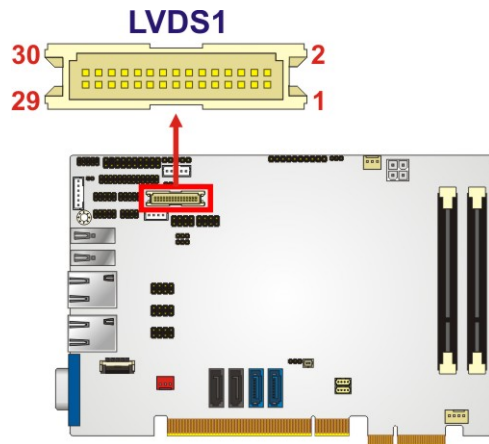

Figure 3-15: LVDS Connector Location

Pin	Description	Pin	Description
1	GND	2	GND
3	A_Y0	4	A_Y0#
5	A_Y1	6	A_Y1#
7	A_Y2	8	A_Y2#
9	A_CK	10	A_CK#
11	A_Y3	12	A_Y3#
13	GND	14	GND
15	B_Y0	16	B_Y0#
17	B_Y1	18	B_Y1#
19	B_Y2	20	B_Y2#
21	B_CK	22	B_CK#
23	B_Y3	24	B_Y3#
25	GND	26	GND
27	VCC/VCC3	28	VCC/VCC3
29	VCC/VCC3	30	VCC/VCC3

Table 3-16: LVDS Connector Pinouts

PIC0e-HM650 Half-size PCIe CPU Card

3.2.15 Parallel Port Connector

- CN Label:** LPT1
- CN Type:** 26-pin header (2x13)
- CN Location:** See **Figure 3-16**
- CN Pinouts:** See **Table 3-17**

The parallel port connector connects to a parallel port connector interface or some other parallel port device such as a printer.

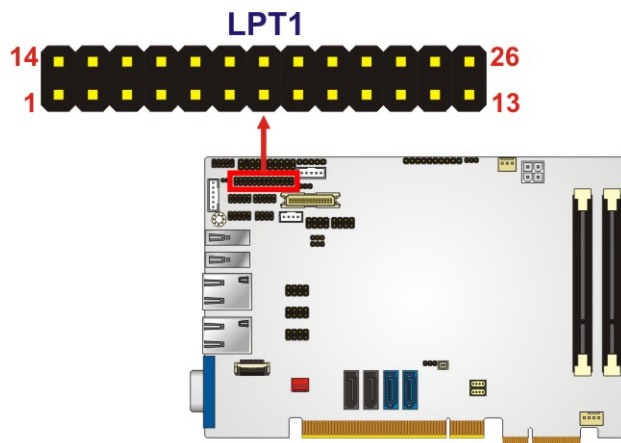

Figure 3-16: Parallel Port Connector Location

Pin	Description	Pin	Description
1	STROBE#	14	AUTO FORM FEED #
2	DATA0	15	ERROR#
3	DATA1	16	INITIALIZE#
4	DATA2	17	PRINTER SELECT LN#
5	DATA3	18	GND
6	DATA4	19	GND
7	DATA5	20	GND
8	DATA6	21	GND
9	DATA7	22	GND
10	ACKNOWLEDGE#	23	GND
11	BUSY	24	GND

Pin	Description	Pin	Description
12	PAPER EMPTY	25	GND
13	PRINTER SELECT	26	NC

Table 3-17: Parallel Port Connector Pinouts

3.2.16 SATA 6Gb/s Connector

- CN Label:** S_ATA1, S_ATA2
- CN Type:** 7-pin SATA drive connector
- CN Location:** See **Figure 3-17**
- CN Pinouts:** See **Table 3-18**

The SATA connectors connect to SATA hard drives or optical drives with data transfer speeds as high as 6Gb/s.

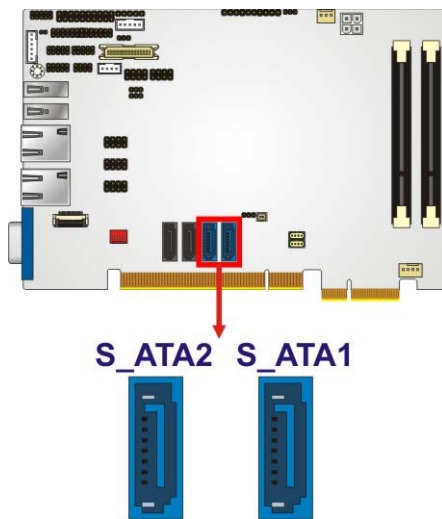
Figure 3-17: SATA Drive Connector Locations

Pin	Description
1	GND
2	TX+
3	TX-
4	GND
5	RX-

PIC0e-HM650 Half-size PCIe CPU Card

Pin	Description
6	RX+
7	GND

Table 3-18: SATA Drive Connector Pinouts

3.2.17 SATA 3Gb/s Connector

- CN Label:** S_ATA3, S_ATA4
- CN Type:** 7-pin SATA drive connector
- CN Location:** See **Figure 3-18**
- CN Pinouts:** See **Table 3-19**

The SATA connectors connect to SATA hard drives or optical drives with data transfer speeds as high as 3Gb/s.

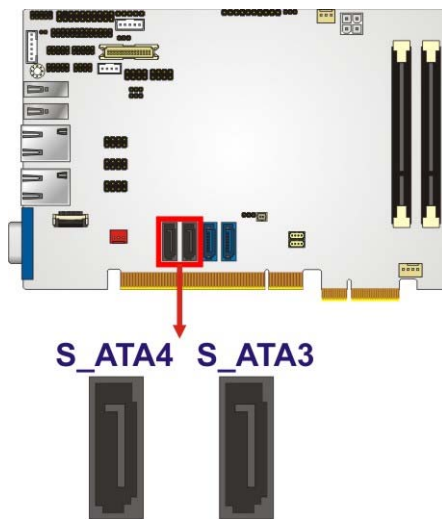

Figure 3-18: SATA Drive Connector Locations

Pin	Description
1	GND
2	TX+
3	TX-
4	GND
5	RX-
6	RX+

Pin	Description
7	GND

Table 3-19: SATA Drive Connector Pinouts

3.2.18 Serial Port Connectors (COM 1 and COM 2)

- CN Label:** COM1, COM2
- CN Type:** 10-pin header (2x5)
- CN Location:** See Figure 3-19
- CN Pinouts:** See Table 3-20

The 10-pin serial port connectors provide three RS-232 serial communications channels. The COM serial port connectors can be connected to external RS-232 serial port devices.

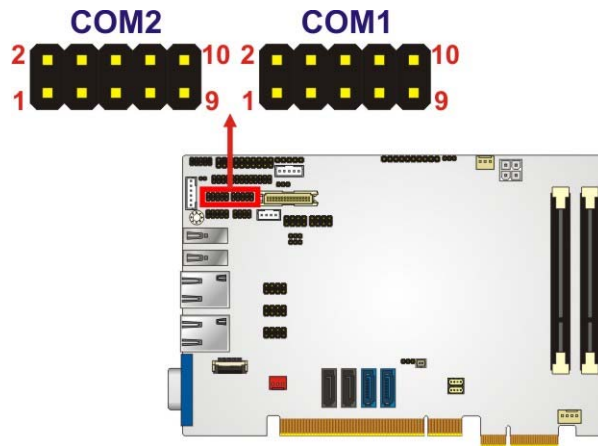

Figure 3-19: COM Connector Locations

Pin	Description	Pin	Description
1	-ND CD	6	-NCTS
2	-NDSR	7	-NDTR
3	NSIN	8	-XRI
4	-NRTS	9	GND
5	NSOUT	10	GND

Table 3-20: COM Connector Pinouts

PIC0e-HM650 Half-size PCIe CPU Card

3.2.19 Serial Port Connector (COM3)

CN Label:	COM3
CN Type:	4-pin header (1x4)
CN Location:	See Figure 3-20
CN Pinouts:	See Table 3-21



NOTE:

These pins are shared with those on the main serial port. Use either the pins on the main connector, or on this connector, but not both.

This connector provides RS-422 or RS-485 communications.

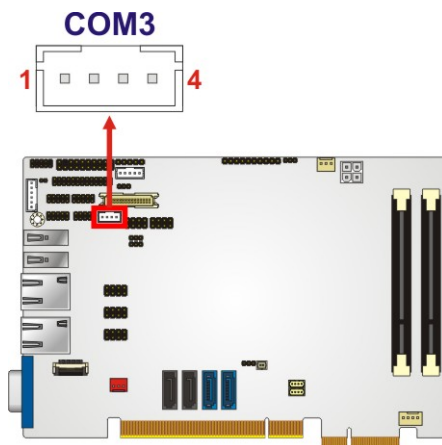

Figure 3-20: Serial Port Connector Location

Pin	Description
1	RXD485#
2	RXD485+
3	RXD485-
4	RXD485#

Table 3-21: Serial Port Connector Pinouts

Use the optional RS-422/485 cable to connect to a serial device. The pinouts of the DB-9 connector are listed below.

RS-422 Pinouts	RS-485 Pinouts
	

Table 3-22: DB-9 RS-422/485 Pinouts

3.2.20 SMBus Connector

- CN Label:** CN5
- CN Type:** 4-pin wafer (1x4)
- CN Location:** See **Figure 3-21**
- CN Pinouts:** See **Table 3-23**

The SMBus Connector provides a connection to a SMBus (System Management Bus) device.

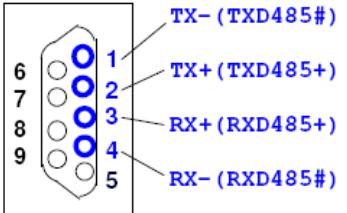
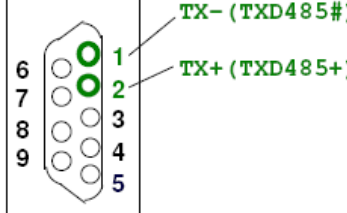
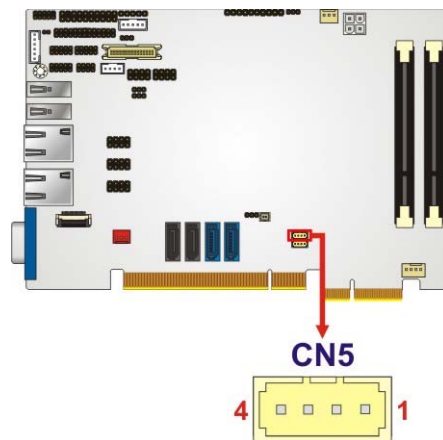

Figure 3-21: SMBus Connector Location

PIC0e-HM650 Half-size PCIe CPU Card

Pin	Description
1	GND
2	SMB_DATA
3	SMB_CLK
4	+V5S

Table 3-23: SMBus Connector Pinouts

3.2.21 SPI Flash Connector (BIOS)

- CN Label:** JSPI1
- CN Type:** 8-pin header (2x4)
- CN Location:** See **Figure 3-22**
- CN Pinouts:** See **Table 3-24**

The SPI Flash connector is used to flash the BIOS.

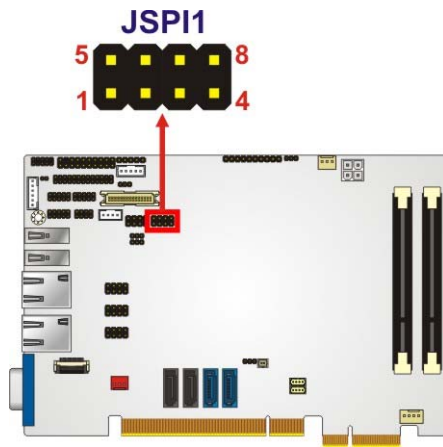

Figure 3-22: SPI Flash Connector Location

Pin	Description	Pin	Description
1	3.3V	2	GND
3	CS0	4	CLK
5	SO0	6	SI
7	N/C	8	N/C

Table 3-24: SPI Flash Connector

3.2.22 SPI Flash Connector (EC)

- CN Label:** JSPI2
- CN Type:** 8-pin header (2x4)
- CN Location:** See **Figure 3-22**
- CN Pinouts:** See **Table 3-24**

The SPI Flash connector is used to flash the Embedded Controller.

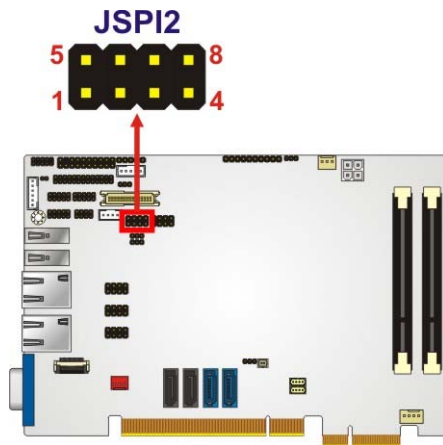

Figure 3-23: SPI Flash Connector Location

Pin	Description	Pin	Description
1	3.3V	2	GND
3	CS0	4	CLK
5	SO0	6	SI
7	N/C	8	N/C

Table 3-25: SPI Flash Connector

3.2.23 TPM Connector

- CN Label:** TPM1
- CN Type:** 20-pin header (2x10)
- CN Location:** See **Figure 3-24**
- CN Pinouts:** See **Table 3-26**

PIC0e-HM650 Half-size PCIe CPU Card

The Trusted Platform Module (TPM) connector secures the system on bootup.

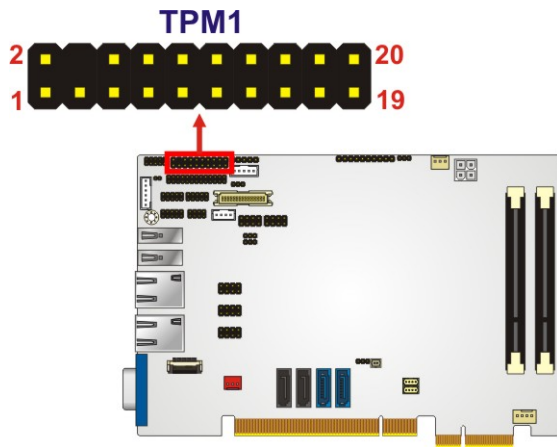

Figure 3-24: TPM Connector Location

Pin	Description	Pin	Description
1	CLK	2	GND
3	FRAME#	4	NC
5	RERST#	6	+5V
7	AD3	8	AD2
9	+3V	10	AD1
11	AD0	12	GND
13	SMB_CLK	14	SMB_DATA
15	SB3V	16	SERIRQ
17	GND	18	CLKRUN#
19	PM_SUS_STAT#	20	DRO#

Table 3-26: TPM Connector Pinouts

3.2.24 USB Connectors (Internal)

CN Label: USB1, USB2, USB3

CN Type: 8-pin header (2x4)

CN Location: See Figure 3-25

CN Pinouts: See Table 3-27

The internal USB connector provides connectivity to two USB 1.1 or two USB 2.0 ports. Each USB connector can support two USB devices. Additional external USB ports are found on the rear panel. The USB ports are used for I/O bus expansion.

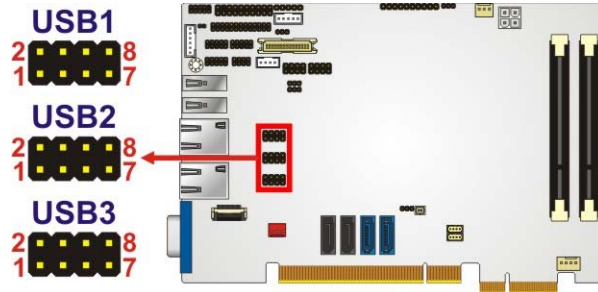

Figure 3-25: USB Connector Locations

Pin	Description	Pin	Description
1	VCC	2	GND
3	DATA-	4	DATA+
5	DATA+	6	DATA-
7	GND	8	VCC

Table 3-27: USB Port Connector Pinouts

3.3 External Peripheral Interface Connector Panel

Figure 3-26 shows the PIC0e-HM650 external peripheral interface connector (EPIC) panel. The PIC0e-HM650 EPIC panel consists of the following:

- 2 x RJ-45 LAN connectors
- 2 x USB connectors
- 1 x VGA connector

PIC0e-HM650 Half-size PCIe CPU Card

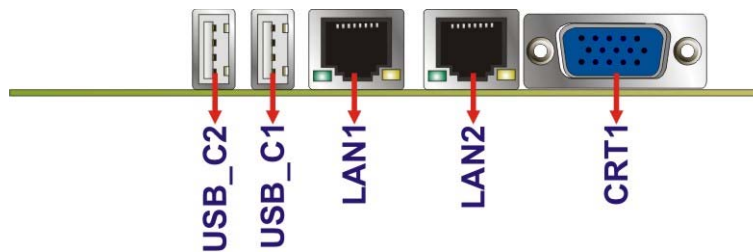

Figure 3-26: PIC0e-HM650 External Peripheral Interface Connector

3.3.1 LAN Connectors

CN Label:	LAN1 and LAN2
CN Type:	RJ-45
CN Location:	See Figure 3-26
CN Pinouts:	See Table 3-28

The PIC0e-HM650 is equipped with two built-in RJ-45 Ethernet controllers. The controllers can connect to the LAN through two RJ-45 LAN connectors. There are two LEDs on the connector indicating the status of LAN. The pin assignments are listed in the following table:

Pin	Description	Pin	Description
1	MDIA3-	5	MDIA1+
2	MDIA3+	6	MDIA2+
3	MDIA2-	7	MDIA0-
4	MDIA1-	8	MDIA0+

Table 3-28: LAN Pinouts

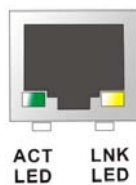

Figure 3-27: RJ-45 Ethernet Connector

The RJ-45 Ethernet connector has two status LEDs, one yellow (activity/link) and one green/orange (speed). The yellow LED indicates activity/link on the port and the green/orange LED indicates the connection speed. See **Table 3-29**.

ACT/LINK LED		SPEED LED	
STATUS	DESCRIPTION	STATUS	DESCRIPTION
OFF	No Link	OFF	10 Mbps connection
YELLOW	Link	GREEN	100 Mbps connection
BLINKING	Data activity	ORANGE	1000 Mbps connection

Table 3-29: RJ-45 Ethernet Connector LEDs

3.3.2 USB Connectors

CN Label: USB_C1, USB_C2

CN Type: USB port

CN Location: See **Figure 3-26**

CN Pinouts: See **Table 3-30**

The PIC0e-HM650 has two external USB 2.0 ports. The ports connect to both USB 2.0 and USB 1.1 devices.

Pin	Description
1	VCC
2	DATA-
3	DATA+
4	GND

Table 3-30: USB Port Pinouts

3.3.3 VGA Connector

CN Label: CRT1

CN Type: 15-pin Female

CN Location: See **Figure 3-26**

CN Pinouts: See **Figure 3-28** and **Table 3-31**

PIC0e-HM650 Half-size PCIe CPU Card

The PIC0e-HM650 has a single 15-pin female connector for connectivity to standard display devices.

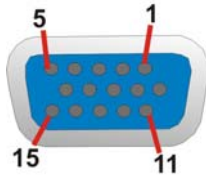

Figure 3-28: VGA Connector

Pin	Description	Pin	Description
1	RED	2	GREEN
3	BLUE	4	NC
5	GND	6	VCC
7	GND	8	GND
9	VCC	10	GND
11	NC	12	DDC DAT
13	HSYNC	14	VSYNC
15	DDCCLK		

Table 3-31: VGA Connector Pinouts

Chapter

4

Installation

PIC0e-HM650 Half-size PCIe CPU Card

4.1 Anti-static Precautions



WARNING:

Failure to take ESD precautions during the installation of the PIC0e-HM650 may result in permanent damage to the PIC0e-HM650 and severe injury to the user.

Electrostatic discharge (ESD) can cause serious damage to electronic components, including the PIC0e-HM650. Dry climates are especially susceptible to ESD. It is therefore critical that whenever the PIC0e-HM650 or any other electrical component is handled, the following anti-static precautions are strictly adhered to.

- ***Wear an anti-static wristband:*** Wearing a simple anti-static wristband can help to prevent ESD from damaging the board.
- ***Self-grounding:*** Before handling the board, touch any grounded conducting material. During the time the board is handled, frequently touch any conducting materials that are connected to the ground.
- ***Use an anti-static pad:*** When configuring the PIC0e-HM650, place it on an anti-static pad. This reduces the possibility of ESD damaging the PIC0e-HM650.
- ***Only handle the edges of the PCB:*** When handling the PCB, hold the PCB by the edges.

4.2 Installation Considerations



NOTE:

The following installation notices and installation considerations should be read and understood before the PICOe-HM650 is installed. All installation notices pertaining to the installation of the PICOe-HM650 should be strictly adhered to. Failing to adhere to these precautions may lead to severe damage of the PICOe-HM650 and injury to the person installing the CPU card.



WARNING:

The installation instructions described in this manual should be carefully followed in order to prevent damage to the PICOe-HM650, PICOe-HM650 components and injury to the user.

Before and during the installation please **DO** the following:

- **Read the user manual:**
 - The user manual provides a complete description of the PICOe-HM650 installation instructions and configuration options.
- **Wear an electrostatic discharge cuff (ESD):**
 - Electronic components are easily damaged by ESD. Wearing an ESD cuff removes ESD from the body and helps prevent ESD damage.
- **Place the PICOe-HM650 on an antistatic pad:**
 - When installing or configuring the motherboard, place it on an antistatic pad. This helps to prevent potential ESD damage.
- **Turn all power to the PICOe-HM650 off:**
 - When working with the PICOe-HM650, make sure that it is disconnected from all power supplies and that no electricity is being fed into the system.

PIC0e-HM650 Half-size PCIe CPU Card

Before and during the installation of the PIC0e-HM650 **DO NOT**:

- Remove any of the stickers on the PCB board. These stickers are required for warranty validation.
- Use the product before verifying all the cables and power connectors are properly connected.
- Allow screws to come in contact with the PCB circuit, connector pins, or its components.

4.3 CPU and Memory Installation



WARNING:

Do not run the CPU without a heatsink and fan. Without the heatsink and fan, the high temperatures can destroy the CPU and other components. CPUs marked as fanless don't need the fan, but still need adequate ventilation.

The CPU, CPU cooling kit and SO-DIMM are the most critical components of the PIC0e-HM650. If one of these component is not installed the PIC0e-HM650 cannot run.

4.3.1 Socket G2 CPU Installation



WARNING:

CPUs are expensive and sensitive components. When installing the CPU please be careful not to damage it in anyway. Make sure the CPU is installed properly and ensure the correct cooling kit is properly installed.

To install the CPU, follow the steps below.

**WARNING:**

DO NOT touch the pins at the bottom of the CPU. When handling the CPU, only hold it on the sides.

Step 1: **Unlock the CPU retention screw.** Make sure the retention lock is unlocked.

See Figure 4-1.

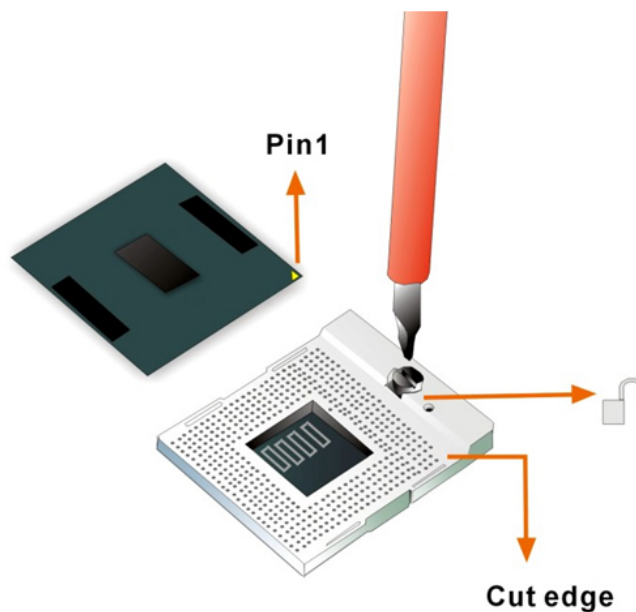

Figure 4-1: Unlocked Retention Screw

Step 2: **Inspect the CPU socket.** Make sure there are no bent pins on the CPU.

Remove any debris from the CPU socket using compressed air.

Step 3: **Correctly Orientate the CPU.** Make sure the pins are facing down.

Step 4: **Correctly position the CPU.** Match the Pin 1 mark on the CPU with the marked corner on the CPU socket. See Figure 4-1.

Step 5: **Align the CPU pins.** Carefully align the CPU pins with the holes in the CPU socket.

PIC0e-HM650 Half-size PCIe CPU Card

Step 6: Insert the CPU. Gently insert the CPU into the socket. If lined up correctly, the CPU will gently drop into the correct position.

Step 7: Lock the retention screw. Rotate the retention screw into the locked position.

See Figure 4-2.

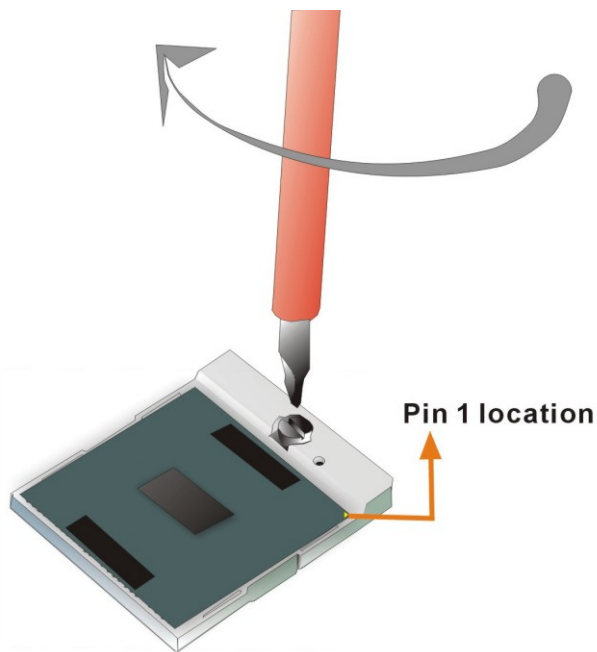

Figure 4-2: Lock CPU Socket Retention Screw

4.3.2 Socket G2 Cooling Kit Installation



Figure 4-3: Cooling Kit

The cooling kit consists of a heatsink and fan, and can be purchased separately.

**WARNING:**

Do not wipe off the thermal paste on the bottom of the heatsink. The thermal paste allows the maximum heat dissipation.

To install the cooling kit, please follow the steps below.

Step 1: Install the support bracket. Remove the tape from the support bracket. From the solder side of the board, align the support bracket to the holes on board and stick in place.

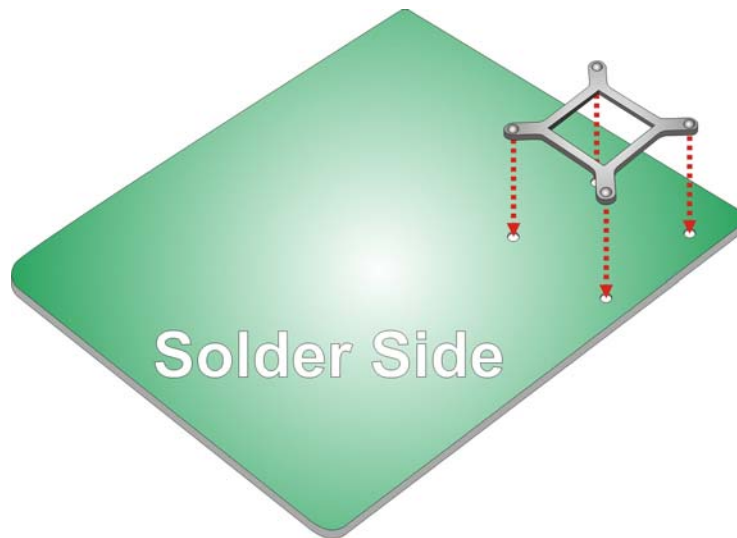

Figure 4-4: Install Support Bracket

- Step 2: Properly orient the cooling kit.** The CPU fan cable must not interfere with the fan or other moving parts. Make sure the cable can be routed away from the moving parts.
- Step 3: Properly align the cooling kit.** Line up the four screws with the screw holes on the support bracket below the board (**Figure 4-5**).

PICOe-HM650 Half-size PCIe CPU Card

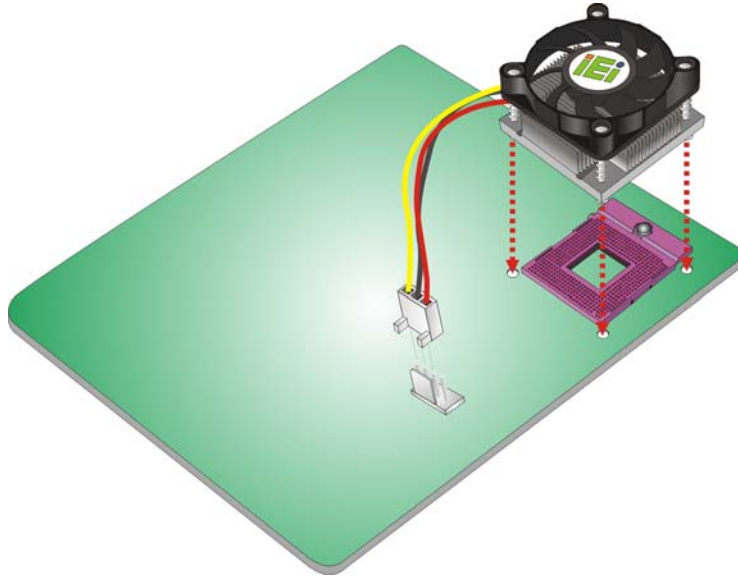

Figure 4-5: Align the Cooling Kit

- Step 4:** Place the cooling kit onto the CPU. Push down the fan with some pressure to secure the cooling kit with the support bracket. See **Figure 4-6**.
- Step 5:** Tighten the screws. Use a screwdriver to tighten the four screws. In a diagonal pattern, tighten each screw a few turns then move to the next one, until they are all secured. Do not overtighten the screws. See **Figure 4-6**.
- Step 6:** Connect the fan cable. Connect the cooling kit fan cable to the fan connector on the board. Carefully route the cable away from heat generating chips and fan blades.

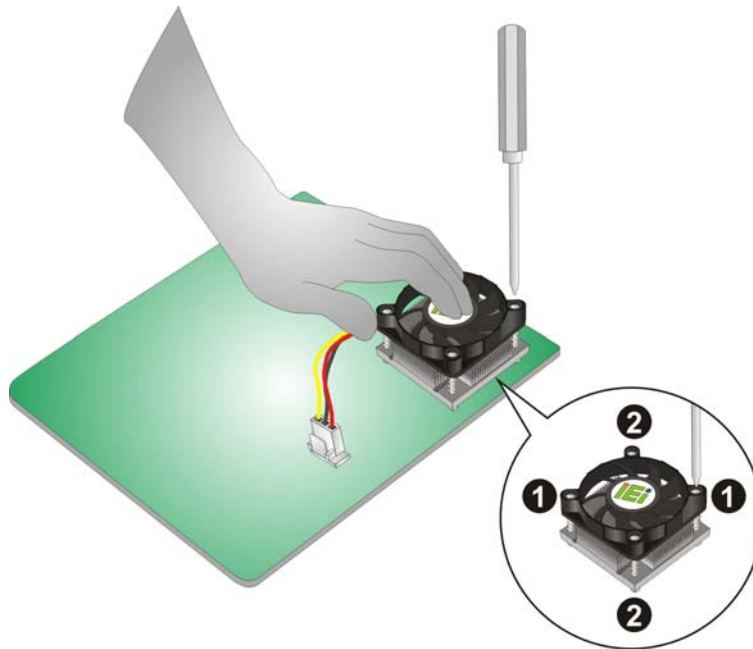

Figure 4-6: Secure the Cooling Kit

4.3.3 SO-DIMM Installation



WARNING:

Using incorrectly specified SO-DIMM may cause permanent damage to the PICOe-HM650. Please make sure the purchased SO-DIMM complies with the memory specifications of the PICOe-HM650. SO-DIMM specifications compliant with the PICOe-HM650 are listed in the specification table of Chapter 1.

To install a SO-DIMM, please follow the steps below and refer to **Figure 4-7**.

PICOe-HM650 Half-size PCIe CPU Card

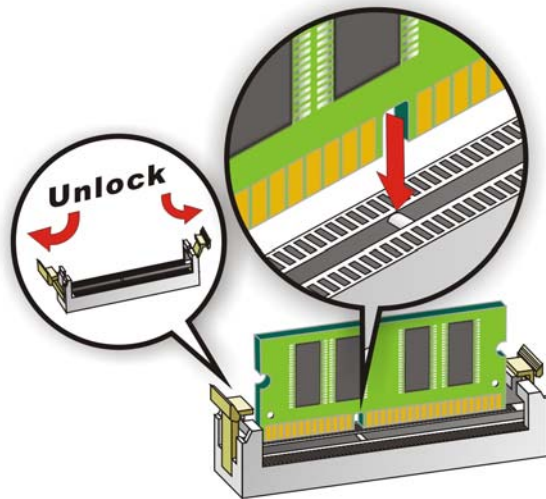

Figure 4-7: SO-DIMM Installation

- Step 1: Open the SO-DIMM socket handles.** Open the two handles outwards as far as they can. See **Figure 4-7**.
- Step 2: Align the SO-DIMM with the socket.** Align the DIMM so the notch on the memory lines up with the notch on the memory socket. See **Figure 4-7**.
- Step 3: Insert the SO-DIMM.** Once aligned, press down until the SO-DIMM is properly seated. Clip the two handles into place. See **Figure 4-7**.
- Step 4: Removing a SO-DIMM.** To remove a SO-DIMM, push both handles outward. The memory module is ejected by a mechanism in the socket.

4.4 Jumper Settings



NOTE:

A jumper is a metal bridge used to close an electrical circuit. It consists of two or three metal pins and a small metal clip (often protected by a plastic cover) that slides over the pins to connect them. To CLOSE/SHORT a jumper means connecting the pins of the jumper with the plastic clip and to OPEN a jumper means removing the plastic clip from a jumper.

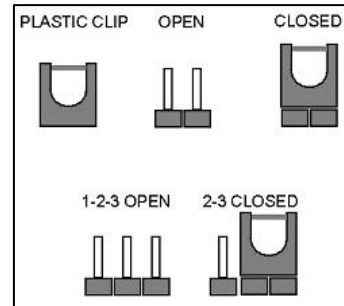

Before the PIC0e-HM650 is installed in the system, the jumpers must be set in accordance with the desired configuration. The jumpers on the PIC0e-HM650 are listed in **Table 4-1**.

Description	Label	Type
AT/ATX power mode select	J_ATXCTL1	3-pin header
Clear CMOS	J_CMOS1	3-pin header
LVDS voltage select	J_VLVDS1	3-pin header
LVDS panel resolution select	J_PID1	8-pin header
PCIe status select	J_PCIE1	2-pin header
TPM setting	ME_RTC1	3-pin header
Flash descriptor security override	J_FLASH1	3-pin header

Table 4-1: Jumpers

4.4.1 AT/ATX Power Mode Select Jumper

Jumper Label: J_ATXCTL1

Jumper Type: 3-pin header

PIC0e-HM650 Half-size PCIe CPU Card

- Jumper Settings:** See Table 4-2
- Jumper Location:** See Figure 4-8

The AT/ATX Power Select jumper specifies the systems power mode as AT or ATX.

Setting	Description
Short 1-2	Use ATX power (Default)
Short 2-3	Use AT power

Table 4-2: AT/ATX Power Mode Jumper Settings

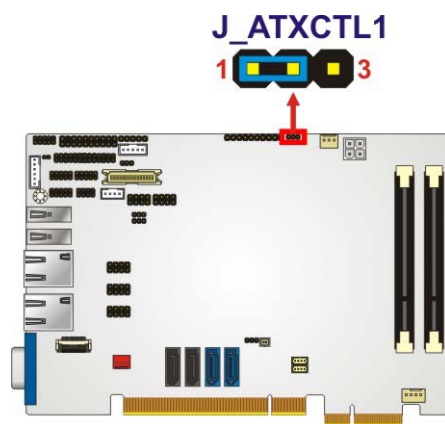

Figure 4-8: AT/ATX Power Mode Jumper Location

4.4.2 Clear CMOS Jumper

- Jumper Label:** J_CMOS1
- Jumper Type:** 3-pin header
- Jumper Settings:** See Table 4-3
- Jumper Location:** See Figure 4-9

If the PIC0e-HM650 fails to boot due to improper BIOS settings, the clear CMOS jumper clears the CMOS data and resets the system BIOS information. To do this, use the jumper cap to close pins 2 and 3 for a few seconds then reinstall the jumper clip back to pins 1 and 2.

If the “CMOS Settings Wrong” message is displayed during the boot up process, the fault may be corrected by pressing the F1 to enter the CMOS Setup menu. Do one of the following:

- Enter the correct CMOS setting
- Load Optimal Defaults
- Load Failsafe Defaults.

After having done one of the above, save the changes and exit the CMOS Setup menu.

The clear CMOS jumper settings are shown in **Table 4-3**.

Setting	Description
Short 1 - 2	Keep CMOS Setup (Default)
Short 2 - 3	Clear CMOS Setup

Table 4-3: Clear CMOS Jumper Settings

The location of the clear CMOS jumper is shown in **Figure 4-9** below.

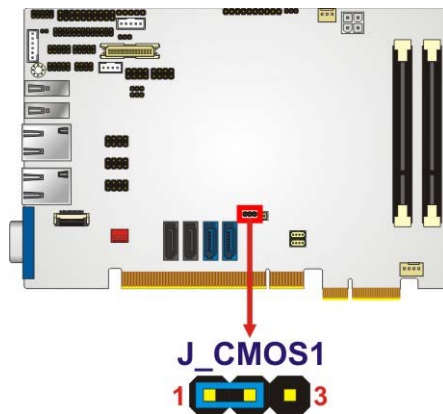

Figure 4-9: Clear CMOS Jumper

PIC0e-HM650 Half-size PCIe CPU Card

4.4.3 LVDS Voltage Selection Jumper



WARNING:

Incorrect voltages can destroy the LCD panel. Make sure to select a voltage that matches the voltage required by the LCD panel.

Jumper Label:	J_VLVDS1
Jumper Type:	3-pin header
Jumper Settings:	See Table 4-4
Jumper Location:	See Figure 4-10

The LCD voltage selection jumper sets the voltage of the power supplied to the LCD panel.

Setting	Description
Short 1-2	+3.3 V (Default)
Short 2-3	+5.0 V

Table 4-4: LVDS Voltage Selection Jumper Settings

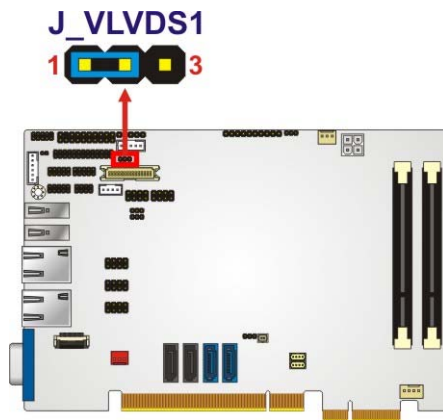

Figure 4-10: LVDS Voltage Selection Jumper Location

4.4.4 LVDS Panel Resolution Selection Jumper

- Jumper Label:** J_PID1
- Jumper Type:** 8-pin header
- Jumper Settings:** See **Table 4-5**
- Jumper Location:** See **Figure 4-11**

The **LVDS Panel Resolution Selection** jumper allows the LVDS screen voltage to be set. The **LVDS Panel Resolution Selection** jumper settings are shown in **Table 4-5**.

Pin	Description
Open	640 X 480 (18-bit)
1-2	800 X 600 (18-bit)
3-4	1024 X 768 (18-bit)
1-2 and 3-4	1024 X 768 (24-bit) Default
5-6	1280 X 800 (24-bit)
1-2 and 5-6	1280 X 1024 (48-bit)
3-4 and 5-6	1366 X 768 (24-bit)
1-2 and 3-4 and 5-6	1440 X 900 (48-bit)
7-8	1400 X 1050 (48-bit)
1-2 and 7-8	1600 X 900 (48-bit)
3-4 and 7-8	1600 X 1200 (48-bit)
1-2 and 3-4 and 7-8	1680 X 1050 (48-bit)
5-6 and 7-8	1920 X 1080 (48-bit)
1-2 and 5-6 and 7-8	1920 X 1200 (48-bit)
3-4 and 5-6 and 7-8	2048 X 1536 (48-bit)
Short all	LVDS Disabled

Table 4-5: LVDS Screen Resolution Jumper Settings

PIC0e-HM650 Half-size PCIe CPU Card

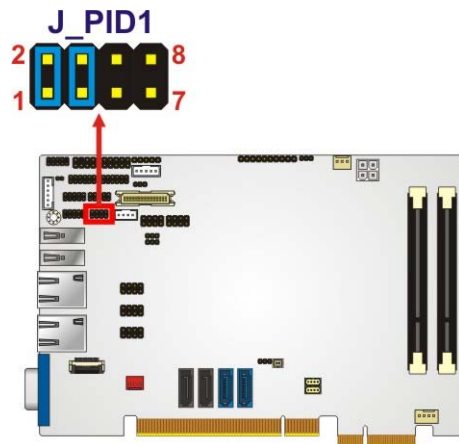

Figure 4-11: LVDS Screen Resolution Jumper Locations

4.4.5 PCIe Status Select Jumper

Jumper Label:	J_PCIE1
Jumper Type:	2-pin header
Jumper Settings:	See Table 4-6
Jumper Location:	See Figure 4-12

The **PCIe Status Select** jumper allows the PCIe status to be configured. The **PCIe Status Select** jumper settings are shown in Table 4-6.

Setting	Description
Open	One PCIe x4 *Customized BIOS version is needed to enable this function
Short	Four PCIe x1 (Default)

Table 4-6: PCIe Status Select Jumper Settings

The PCIe Status Select jumper location is shown in Figure 4-12.

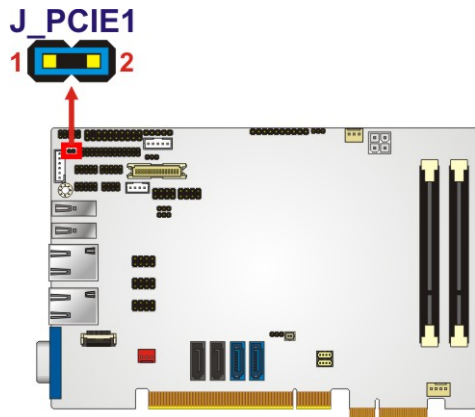

Figure 4-12: PCIe Status Select Jumper Pinout Locations

4.4.6 TPM Setting Jumper

- Jumper Label:** ME_RTC1
- Jumper Type:** 3-pin header
- Jumper Settings:** See Table 4-7
- Jumper Location:** See Figure 4-13

The TPM Setting jumper configures the TPM setting.

Setting	Description
Short 1-2	Save ME RTC registers (Default)
Short 2-3	Clear ME RTC registers

Table 4-7: TPM Setting Jumper Settings

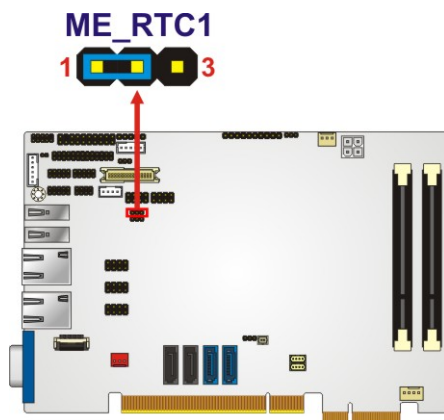

Figure 4-13: TPM Setting Jumper Location

PIC0e-HM650 Half-size PCIe CPU Card

4.4.7 Flash Descriptor Security Override Jumper

Jumper Label:	J_FLASH1
Jumper Type:	3-pin header
Jumper Settings:	See Table 4-8
Jumper Location:	See Figure 4-14

The Flash Descriptor Security Override jumper specifies whether to override the flash descriptor.

Setting	Description
Short 1-2	No override
Short 2-3	Override

Table 4-8: Flash Descriptor Security Override Jumper Settings

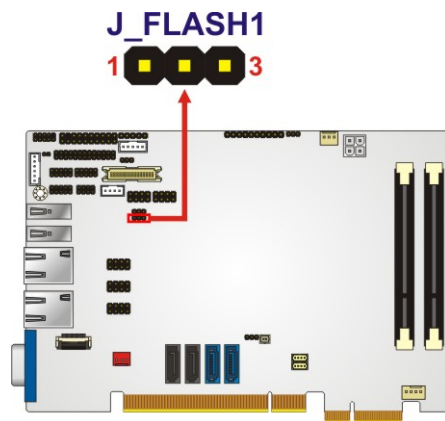

Figure 4-14: Flash Descriptor Security Override Jumper Location

4.5 Chassis Installation

4.5.1 Airflow



WARNING:

Airflow is critical to the cooling of the CPU and other onboard components. The chassis in which the PIC0e-HM650 must have air vents to allow cool air to move into the system and hot air to move out.

The PIC0e-HM650 must be installed in a chassis with ventilation holes on the sides allowing airflow to travel through the heat sink surface. In a system with an individual power supply unit, the cooling fan of a power supply can also help generate airflow through the board surface.

4.5.2 Backplane Installation

Before the PIC0e-HM650 can be installed into the chassis, a backplane must first be installed. Please refer to the installation instructions that came with the backplane and the chassis to see how to install the backplane into the chassis.



NOTE:

IEI has a wide range of backplanes available. Please contact your PIC0e-HM650 vendor, reseller or an IEI sales representative at sales@iei.com.tw or visit the IEI website (<http://www.ieworld.com.tw>) to find out more about the available chassis.

4.5.3 CPU Card Installation

To install the PIC0e-HM650 CPU card onto the backplane, carefully align the CPU card interface connectors with the corresponding socket on the backplane. To do this, please refer to the reference material that came with the backplane. Next, secure the CPU card to the chassis. To do this, please refer to the reference material that came with the chassis.

4.6 Internal Peripheral Device Connections

This section outlines the installation of peripheral devices to the onboard connectors.

4.6.1 Dual RS-232 Cable with Slot Bracket

The dual RS-232 cable slot connector consists of two connectors attached to two independent cables. Each cable is then attached to a D-sub 9 male connector that is mounted onto a slot. To install the dual RS-232 cable, please follow the steps below.

Step 1: Locate the connectors. The locations of the RS-232 connectors are shown in Chapter 3.

Step 2: Insert the cable connectors. Insert one connector into each serial port pin headers. See Figure 4-15.

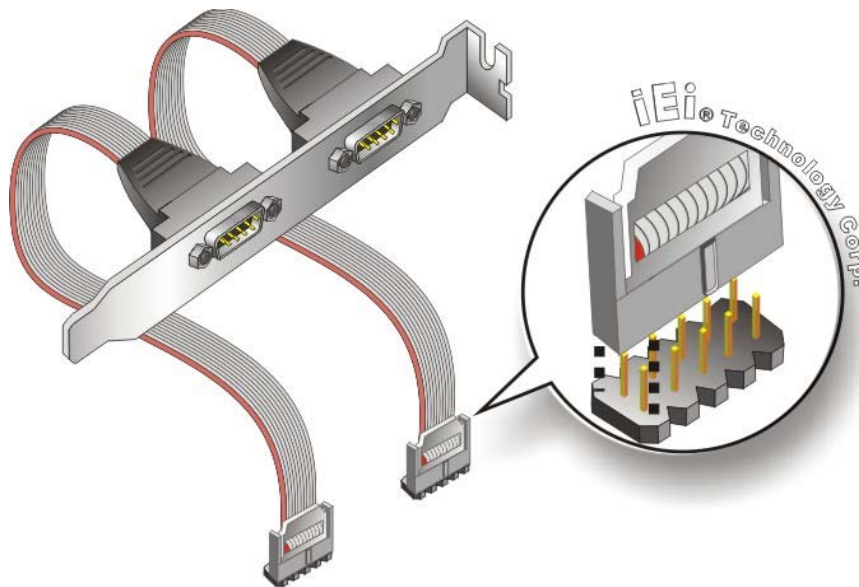

Figure 4-15: Dual RS-232 Cable Installation

Step 3: Secure the bracket. The dual RS-232 connector has two D-sub 9 male connectors secured on a bracket. To secure the bracket to the chassis please refer to the reference material that came with the chassis

4.6.2 SATA Drive Connection

The PICOe-HM650 is shipped with two SATA drive cables. To connect the SATA drives to the connectors, please follow the steps below.

Step 1: Locate the connectors. The locations of the SATA drive connectors are shown in **Chapter 3**.

Step 2: Insert the cable connector. Insert the cable connector into the on-board SATA drive connector until it clips into place. See **Figure 4-16**.

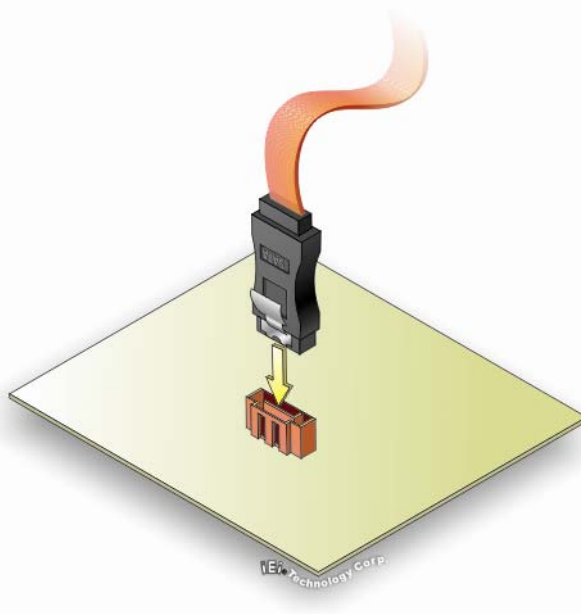

Figure 4-16: SATA Drive Cable Connection

Step 3: Connect the cable to the SATA disk. Connect the connector on the other end of the cable to the connector at the back of the SATA drive. See **Figure 4-17**.

Step 4: Connect the SATA power cable. Connect the SATA power connector to the back of the SATA drive. See **Figure 4-17**.

PIC0e-HM650 Half-size PCIe CPU Card

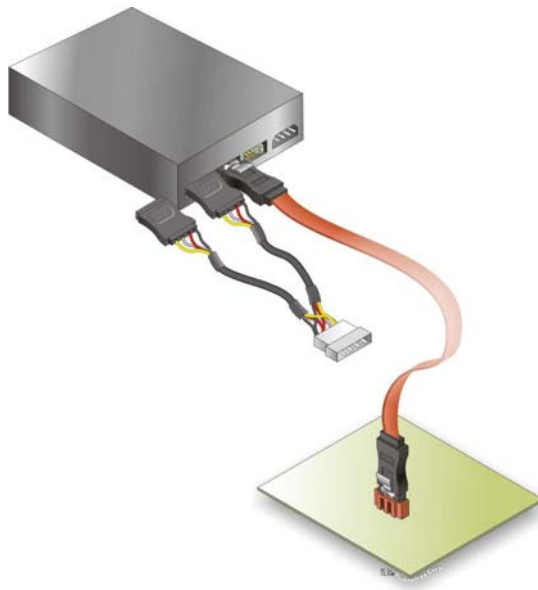

Figure 4-17: SATA Power Drive Connection

4.6.3 USB Cable (Dual Port) with Slot Bracket

The PIC0e-HM650 is shipped with a dual port USB 2.0 cable. To connect the USB cable connector, please follow the steps below.

Step 1: Locate the connectors. The locations of the USB connectors are shown in Chapter 3.



WARNING:

If the USB pins are not properly aligned, the USB device can burn out.

Step 2: Align the connectors. The cable has two connectors. Correctly align pin 1 on each cable connector with pin 1 on the PIC0e-HM650 USB connector.

Step 3: Insert the cable connectors Once the cable connectors are properly aligned with the USB connectors on the PIC0e-HM650, connect the cable connectors to the on-board connectors. See **Figure 4-18**.

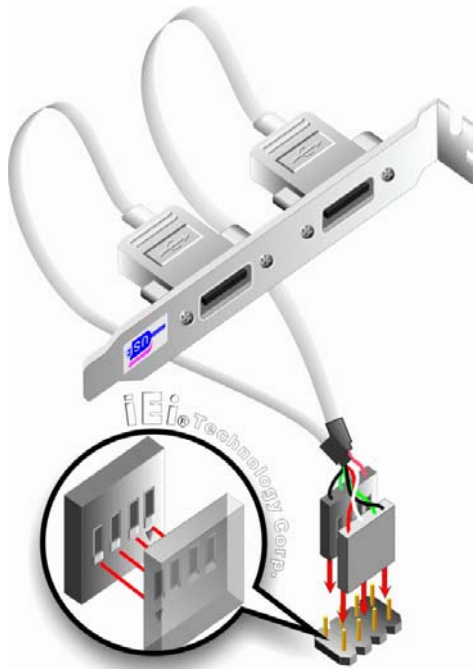

Figure 4-18: Dual USB Cable Connection

Step 4: Attach the bracket to the chassis. The USB 2.0 connectors are attached to a bracket. To secure the bracket to the chassis please refer to the installation instructions that came with the chassis.

4.7 External Peripheral Interface Connection

The following external peripheral devices can be connected to the external peripheral interface connectors.

- RJ-45 Ethernet cable connectors
- USB devices
- VGA monitors

To install these devices, connect the corresponding cable connector from the actual device to the corresponding PICOe-HM650 external peripheral interface connector making sure the pins are properly aligned.

PICOe-HM650 Half-size PCIe CPU Card

4.7.1 LAN Connection

There are two external RJ-45 LAN connectors. The RJ-45 connectors enable connection to an external network. To connect a LAN cable with an RJ-45 connector, please follow the instructions below.

Step 1: **Locate the RJ-45 connectors.** The locations of the USB connectors are shown in **Chapter 3**.

Step 2: **Align the connectors.** Align the RJ-45 connector on the LAN cable with one of the RJ-45 connectors on the PICOe-HM650. See **Figure 4-19**.

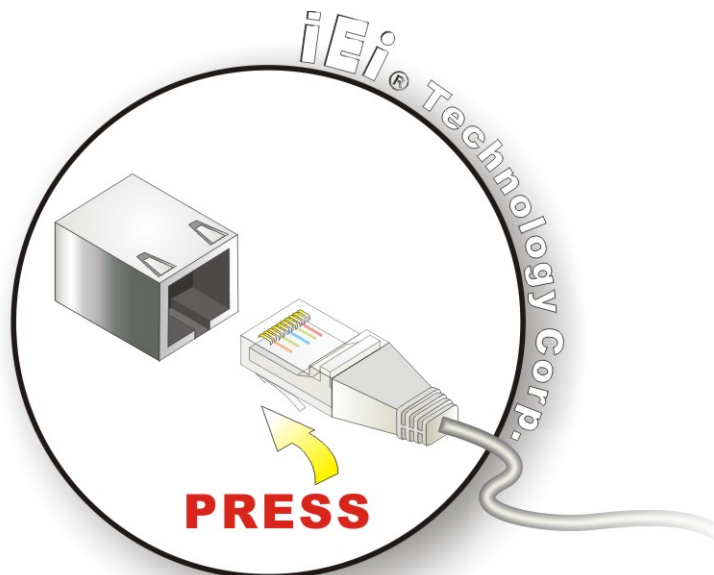

Figure 4-19: LAN Connection

Step 3: **Insert the LAN cable RJ-45 connector.** Once aligned, gently insert the LAN cable RJ-45 connector into the onboard RJ-45 connector.

4.7.2 USB Connection

The external USB Series "A" receptacle connector provides easier and quicker access to external USB devices. Follow the steps below to connect USB devices to the PICOe-HM650.

Step 1: **Locate the USB Series "A" receptacle connectors.** The location of the USB

Series "A" receptacle connectors are shown in **Chapter 3**.

- Step 2:** **Insert a USB Series "A" plug.** Insert the USB Series "A" plug of a device into the USB Series "A" receptacle on the external peripheral interface. See **Figure 4-20**.

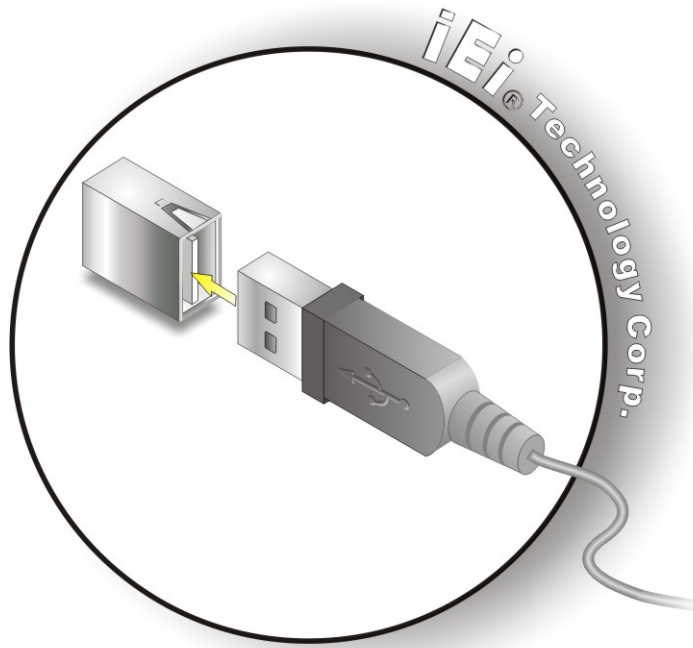

Figure 4-20: USB Connector

4.7.3 VGA Monitor Connection

The PICOe-HM650 has a single female DB-15 connector on the external peripheral interface panel. The DB-15 connector is connected to a CRT or VGA monitor. To connect a monitor to the PICOe-HM650, please follow the instructions below.

- Step 1:** **Locate the female DB-15 connector.** The location of the female DB-15 connector is shown in **Chapter 3**.
- Step 2:** **Align the VGA connector.** Align the male DB-15 connector on the VGA screen cable with the female DB-15 connector on the external peripheral interface.
- Step 3:** **Insert the VGA connector.** Once the connectors are properly aligned with the

PIC0e-HM650 Half-size PCIe CPU Card

insert the male connector from the VGA screen into the female connector on the PIC0e-HM650. See **Figure 4-21**.

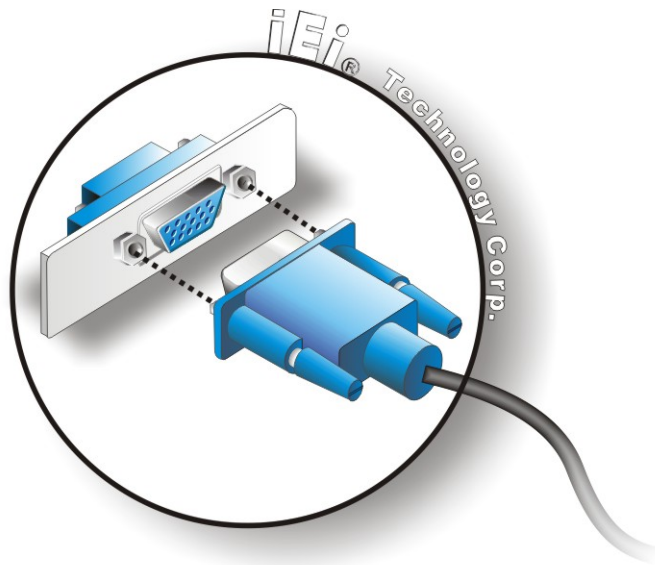

Figure 4-21: VGA Connector

Step 4: Secure the connector. Secure the DB-15 VGA connector from the VGA monitor to the external interface by tightening the two retention screws on either side of the connector.

4.8 Software Installation

All the drivers for the PIC0e-HM650 are on the CD that came with the system. To install the drivers, please follow the steps below.

Step 1: Insert the CD into a CD drive connected to the system.



NOTE:

If the installation program doesn't start automatically:
Click "Start->My Computer->CD Drive->autorun.exe"

Step 2: The driver main menu appears (**Figure 4-22**).

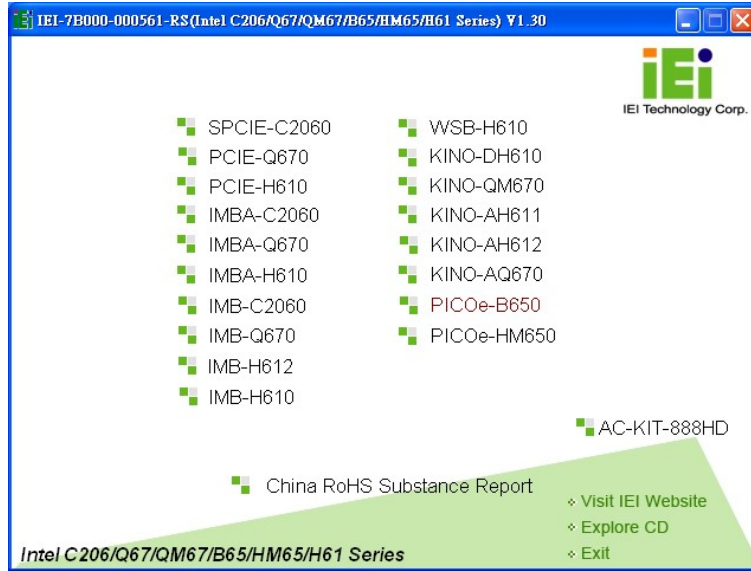

Figure 4-22: Introduction Screen

Step 3: Click **PICOe-HM650**.

Step 4: A new screen with a list of available drivers appears (**Figure 4-23**).

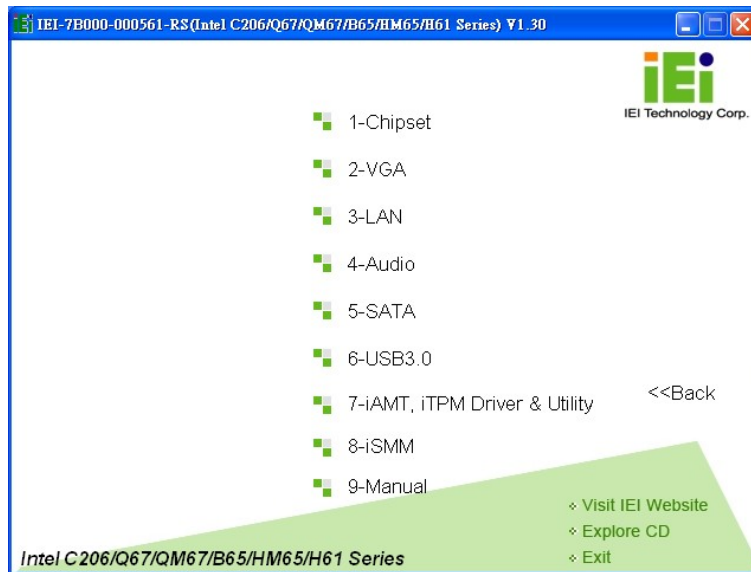

Figure 4-23: Available Drivers

Step 5: Install all of the necessary drivers in this menu.

Chapter

5

BIOS Screens

5.1 Introduction

The BIOS is programmed onto the BIOS chip. The BIOS setup program allows changes to certain system settings. This chapter outlines the options that can be changed.

5.1.1 Starting Setup

The AMI BIOS is activated when the computer is turned on. The setup program can be activated in one of two ways.

1. Press the **DELETE** or **F2** key as soon as the system is turned on or
2. Press the **DELETE** or **F2** key when the “**Press Del to enter SETUP**” message appears on the screen.

If the message disappears before the **DELETE** or **F2** key is pressed, restart the computer and try again.

5.1.2 Using Setup

Use the arrow keys to highlight items, press **ENTER** to select, use the PageUp and PageDown keys to change entries, press **F1** for help and press **ESC** to quit. Navigation keys are shown in.

Key	Function
Up arrow	Move to previous item
Down arrow	Move to next item
Left arrow	Move to the item on the left hand side
Right arrow	Move to the item on the right hand side
F1 key	General help, only for Status Page Setup Menu and Option Page Setup Menu
F2 key	Load previous values.
F3 key	Load optimized defaults

PIC0e-HM650 Half-size PCIe CPU Card

Key	Function
F4 key	Save all the CMOS changes
Esc key	Main Menu – Quit and not save changes into CMOS Status Page Setup Menu and Option Page Setup Menu -- Exit current page and return to Main Menu

Table 5-1: BIOS Navigation Keys

5.1.3 Getting Help

When **F1** is pressed a small help window describing the appropriate keys to use and the possible selections for the highlighted item appears. To exit the Help Window press **Esc** or the **F1** key again.

5.1.4 Unable to Reboot After Configuration Changes

If the computer cannot boot after changes to the system configuration is made, CMOS defaults. Use the jumper described in Chapter 4.

5.1.5 BIOS Menu Bar

The **menu bar** on top of the BIOS screen has the following main items:

- Main – Changes the basic system configuration.
- Advanced – Changes the advanced system settings.
- Chipset – Changes the chipset settings.
- Boot – Changes the system boot configuration.
- Security – Sets User and Supervisor Passwords.
- Save & Exit – Selects exit options and loads default settings

The following sections completely describe the configuration options found in the menu items at the top of the BIOS screen and listed above.

5.2 Main

The **Main** BIOS menu (**BIOS Menu 1**) appears when the **BIOS Setup** program is entered. The **Main** menu gives an overview of the basic system information.

```

Aptio Setup Utility - Copyright (C) 2011 American Megatrends, Inc.
Main  Advanced  Chipset  Boot  Security  Save & Exit

BIOS Information
BIOS Vendor                American Megatrends
Core Version               4.6.4.0 0.01
Compliancy                 UEFI 2.1
Project Version            B214AR10.ROM
Build Date and Time        01/02/2012 11:05:12

iWDD Vendor                ICP
iWDD Version               B214ER12.bin

System Date                [Tue 03/04/2011]
System Time                [15:10:27]

Access Level               Administrator

Set the Date. Use Tab to
switch between Data
elements.

-----
<->: Select Screen
^ v: Select Item
Enter>Select
+ - Change Opt.
F1  General Help
F2  Previous Values
F3  Optimized Defaults
F4  Save & Exit
ESC Exit

Version 2.11.1210. Copyright (C) 2011 American Megatrends, Inc.
  
```

BIOS Menu 1: Main

→ System Overview

The **BIOS Information** lists a brief summary of the BIOS. The fields in **BIOS Information** cannot be changed. The items shown in the system overview include:

- **BIOS Vendor:** Installed BIOS vendor
- **Core Version:** Current BIOS version
- **Project Version:** the board version
- **Build Date:** Date the current BIOS version was made

The System Overview field also has two user configurable fields:

→ System Date [xx/xx/xx]

Use the **System Date** option to set the system date. Manually enter the day, month and year.

PIC0e-HM650 Half-size PCIe CPU Card

→ System Time [xx:xx:xx]

Use the **System Time** option to set the system time. Manually enter the hours, minutes and seconds.

5.3 Advanced

Use the **Advanced** menu (**BIOS Menu 2**) to configure the CPU and peripheral devices through the following sub-menus:



WARNING!

Setting the wrong values in the sections below may cause the system to malfunction. Make sure that the settings made are compatible with the hardware.

```

Aptio Setup Utility - Copyright (C) 2011 American Megatrends, Inc.
Main  Advanced  Chipset  Boot  Security  Save & Exit
-----
> ACPI Settings
> Trusted Computing
> CPU Configuration
> SATA Configuration
> USB Configuration
> Super IO Configuration
> H/M Monitor
> Serial Port Console Redirection
> iEi Feature

System ACPI Parameters
-----
<=>: Select Screen
↑↓: Select Item
Enter>Select
+ - Change Opt.
F1 General Help
F2 Previous Values
F3 Optimized Defaults
F4 Save & Exit
ESC Exit

Version 2.11.1210. Copyright (C) 2011 American Megatrends, Inc.
    
```

BIOS Menu 2: Advanced

5.3.1 ACPI Settings

The **ACPI Settings** menu (**BIOS Menu 3**) configures the Advanced Configuration and Power Interface (ACPI) options.

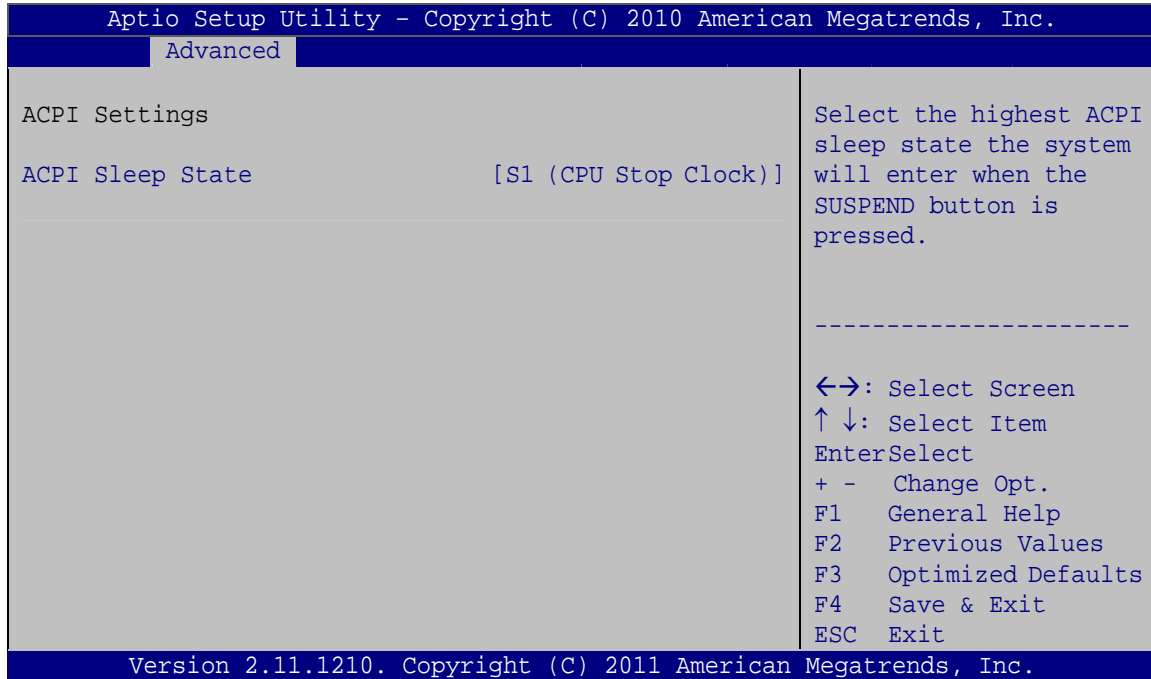
BIOS Menu 3: ACPI Configuration
→ ACPI Sleep State [S1 (CPU Stop Clock)]

Use the **ACPI Sleep State** option to specify the sleep state the system enters when it is not being used.

→ Suspend Disabled

→ S1 (CPU Stop Clock) **DEFAULT** The system enters S1(POS) sleep state. The system appears off. The CPU is stopped; RAM is refreshed; the system is running in a low power mode.

→ S3 (Suspend to RAM) The caches are flushed and the CPU is powered off. Power to the RAM is maintained. The computer returns slower to a working state, but more power is saved.

5.3.2 Trusted Computing

Use the **Trusted Computing** menu (**BIOS Menu 4**) to configure settings related to the Trusted Computing Group (TCG) Trusted Platform Module (TPM).

PICOe-HM650 Half-size PCIe CPU Card

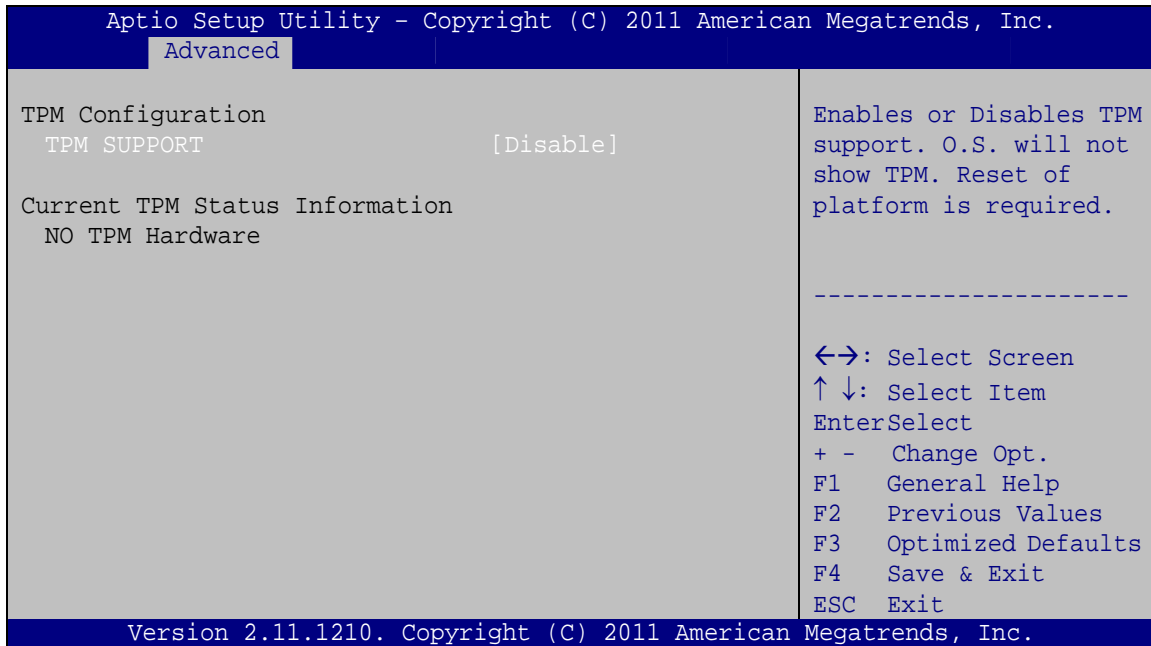

BIOS Menu 4: TPM Configuration

→ TPM Support [Disable]

Use the **TPM Support** option to configure support for the TPM.

- **Disable** **DEFAULT** TPM support is disabled.
- **Enable** TPM support is enabled.

5.3.3 CPU Configuration

Use the **CPU Configuration** menu (**BIOS Menu 5**) to enter the **CPU Information** submenu or enable Intel Virtualization Technology.

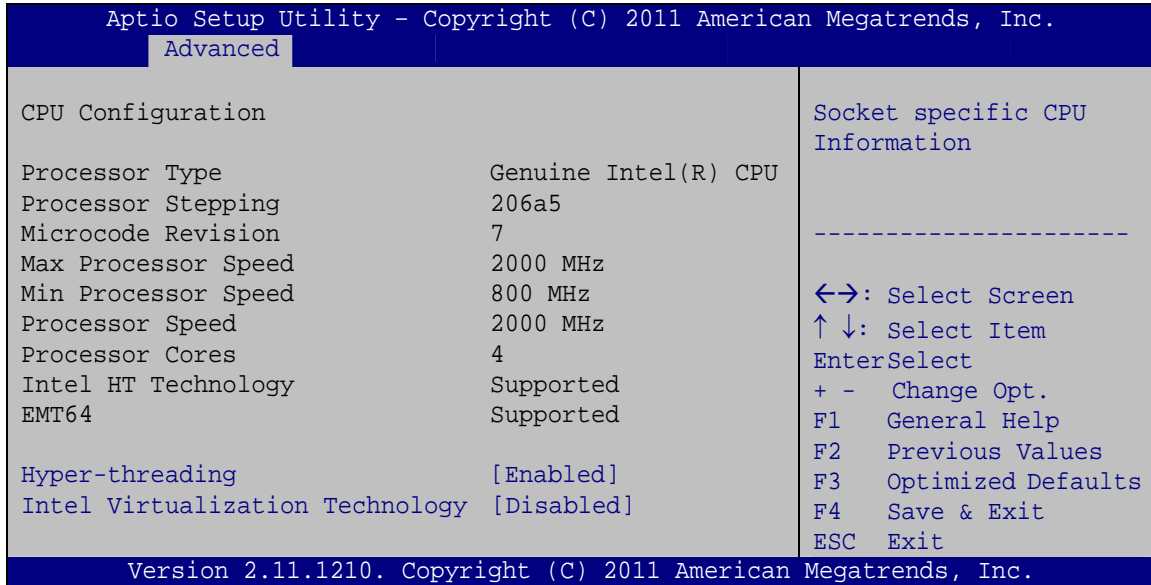

BIOS Menu 5: CPU Configuration

The CPU Configuration menu (**BIOS Menu 5**) lists the following CPU details:

- Processor Type: Lists the brand name of the CPU being used
- Processor Stepping: Lists the CPU processing stepping
- Microcode Revision: Lists the microcode revision being used.
- Max processor Speed: Lists the maximum CPU processing speed.
- Min processor Speed: Lists the minimum CPU processing speed.
- Processor Speed: Lists the CPU processing speed
- Processor Cores: Lists the number of the processor core
- Intel HT Technology: Indicates if Intel HT Technology is supported by the CPU.
- EMT64: Indicates if EM64T is supported by the CPU.

→ Hyper-threading [Enabled]

Use the **Hyper-threading** option to enable or disable the CPU hyper threading function.

- **Disabled** Disables the use of hyper threading technology
- **Enabled DEFAULT** Enables the use of hyper threading technology

PICOe-HM650 Half-size PCIe CPU Card

→ Intel Virtualization Technology [Disabled]

Use the **Intel Virtualization Technology** option to enable or disable virtualization on the system. When combined with third party software, Intel® Virtualization technology allows several OSs to run on the same system at the same time.

→ **Disabled** **DEFAULT** Disables Intel Virtualization
Technology.

→ **Enabled** Enables Intel Virtualization Technology.

5.3.4 SATA Configuration

Use the **SATA Configuration** menu (**BIOS Menu 6**) to change and/or set the configuration of the SATA devices installed in the system.

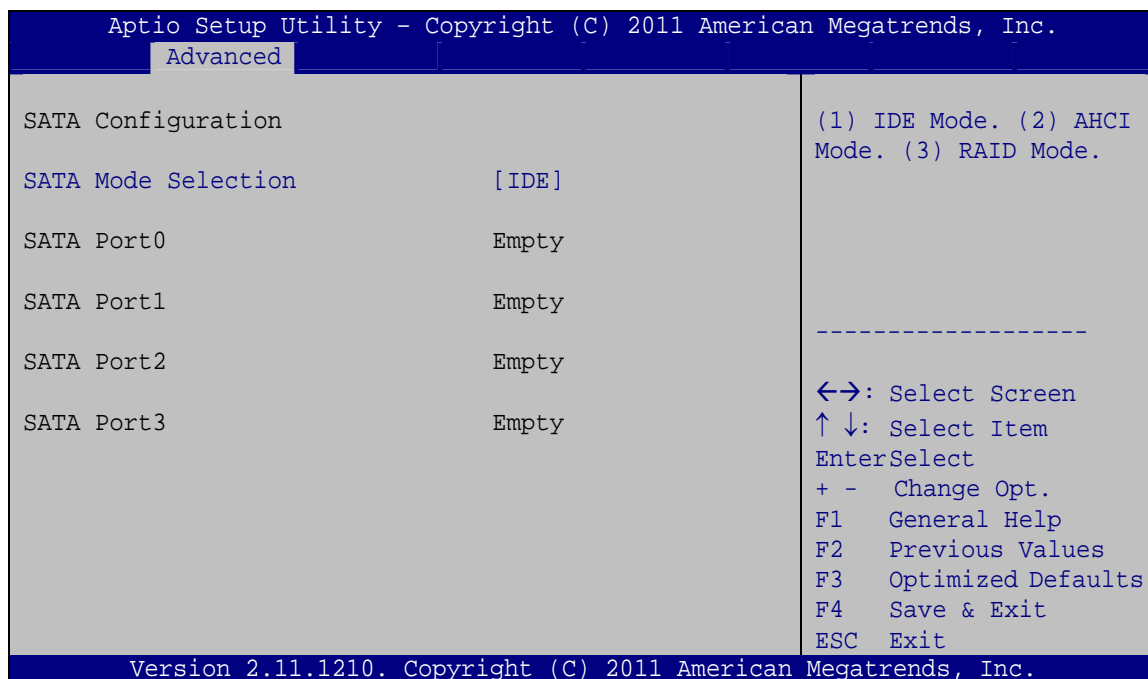

BIOS Menu 6: SATA Configuration

→ SATA Mode Selection [IDE]

Use the **SATA Mode Selection** option to configure SATA devices as normal IDE devices.

→ **IDE** **DEFAULT** Configures SATA devices as normal IDE device.

- ➔ **AHCI** Configures SATA devices as AHCI device.

5.3.5 USB Configuration

Use the **USB Configuration** menu (**BIOS Menu 7**) to read USB configuration information and configure the USB settings.

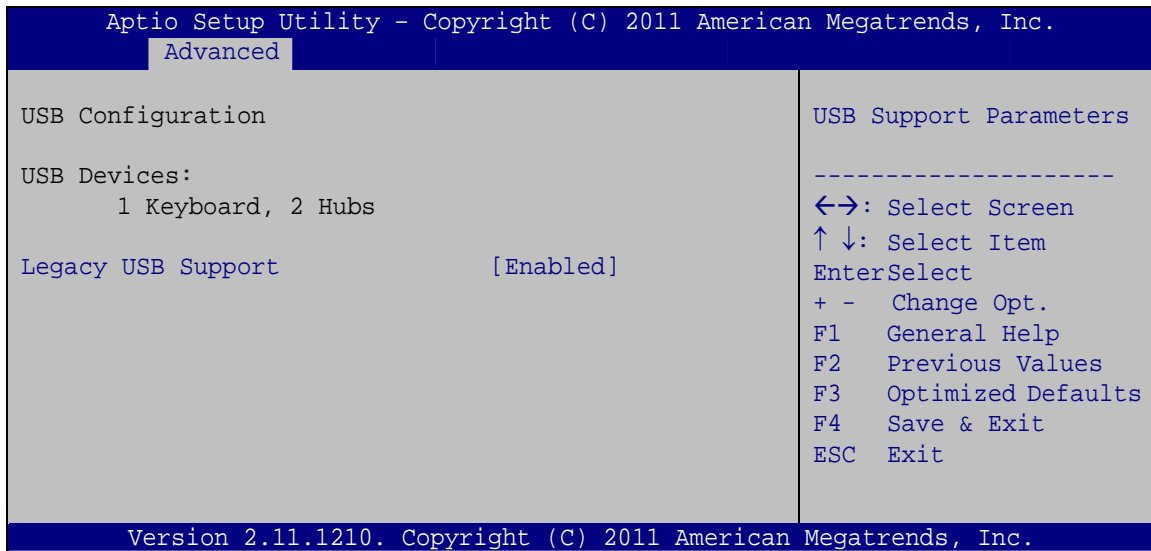

BIOS Menu 7: USB Configuration

➔ USB Devices

The **USB Devices Enabled** field lists the USB devices that are enabled on the system

➔ Legacy USB Support [Enabled]

Use the **Legacy USB Support** BIOS option to enable USB mouse and USB keyboard support. Normally if this option is not enabled, any attached USB mouse or USB keyboard does not become available until a USB compatible operating system is fully booted with all USB drivers loaded. When this option is enabled, any attached USB mouse or USB keyboard can control the system even when there is no USB driver loaded onto the system.

- ➔ **Enabled** **DEFAULT** Legacy USB support enabled
- ➔ **Disabled** Legacy USB support disabled

PIC0e-HM650 Half-size PCIe CPU Card

5.3.6 Super IO Configuration

Use the **Super IO Configuration** menu (**BIOS Menu 8**) to set or change the configurations for the FDD controllers, parallel ports and serial ports.

```

Aptio Setup Utility - Copyright (C) 2011 American Megatrends, Inc.
  Advanced
-----
Super IO Configuration                               Set Parameters of Serial
                                                    Port 0 (COMA)
                                                    -----
Super IO Chip                                     Fintek F81865
> Serial Port 0 Configuration
> Serial Port 1 Configuration
> Serial Port 2 Configuration
> Paralle Port Configuration
                                                    <->: Select Screen
                                                    ↑ ↓: Select Item
                                                    EnterSelect
                                                    + - Change Opt.
F1 General Help
F2 Previous Values
F3 Optimized Defaults
F4 Save & Exit
ESC Exit
Version 2.11.1210. Copyright (C) 2011 American Megatrends, Inc.

```

BIOS Menu 8: Super IO Configuration

5.3.6.1 Serial Port n Configuration

Use the **Serial Port n Configuration** menu (**BIOS Menu 9**) to configure the serial port n.

```

Aptio Setup Utility - Copyright (C) 2011 American Megatrends, Inc.
  Advanced
-----
Serial Port n Configuration                       Enable or Disable Serial
                                                    Port (COM)
                                                    -----
Serial Port                                     [Enabled]
Device Settings                               IO=3F8h; IRQ=4
Change Settings                               [Auto]
                                                    <->: Select Screen
                                                    ↑ ↓: Select Item
                                                    EnterSelect
                                                    = - Change Opt.
F1 General Help
F2 Previous Values
F3 Optimized Defaults
F4 Save & Exit
ESC Exit
Version 2.11.1210. Copyright (C) 2011 American Megatrends, Inc.

```

BIOS Menu 9: Serial Port n Configuration Menu

5.3.6.1.1 Serial Port 0 Configuration

→ Serial Port [Enabled]

Use the **Serial Port** option to enable or disable the serial port.

- **Disabled** Disable the serial port
- **Enabled** **DEFAULT** Enable the serial port

→ Change Settings [Auto]

Use the **Change Settings** option to change the serial port IO port address and interrupt address.

- **Auto** **DEFAULT** The serial port IO port address and interrupt address are automatically detected.
- **IO=3F8h;**
IRQ=4 Serial Port I/O port address is 3F8h and the interrupt address is IRQ4
- **IO=3F8h;**
IRQ=3, 4 Serial Port I/O port address is 3F8h and the interrupt address is IRQ3, 4
- **IO=2F8h;**
IRQ=3, 4 Serial Port I/O port address is 2F8h and the interrupt address is IRQ3, 4
- **IO=3E8h;**
IRQ=10, 11 Serial Port I/O port address is 3E8h and the interrupt address is IRQ10, 11
- **IO=2E8h;**
IRQ=10, 11 Serial Port I/O port address is 2E8h and the interrupt address is IRQ10, 11

5.3.6.1.2 Serial Port 1 Configuration

→ Serial Port [Enabled]

Use the **Serial Port** option to enable or disable the serial port.

- **Disabled** Disable the serial port

PIC0e-HM650 Half-size PCIe CPU Card

→ **Enabled** **DEFAULT** Enable the serial port

→ **Change Settings [Auto]**

Use the **Change Settings** option to change the serial port IO port address and interrupt address.

- **Auto** **DEFAULT** The serial port IO port address and interrupt address are automatically detected.
- **IO=2F8h;**
IRQ=3 Serial Port I/O port address is 2F8h and the interrupt address is IRQ3
- **IO=3F8h;**
IRQ=3, 4 Serial Port I/O port address is 3F8h and the interrupt address is IRQ3, 4
- **IO=2F8h;**
IRQ=3, 4 Serial Port I/O port address is 2F8h and the interrupt address is IRQ3, 4
- **IO=3E8h;**
IRQ=10, 11 Serial Port I/O port address is 3E8h and the interrupt address is IRQ10, 11
- **IO=2E8h;**
IRQ=10, 11 Serial Port I/O port address is 2E8h and the interrupt address is IRQ10, 11

5.3.6.1.3 Serial Port 2 Configuration

→ **Serial Port [Enabled]**

Use the **Serial Port** option to enable or disable the serial port.

- **Disabled** Disable the serial port
- **Enabled** **DEFAULT** Enable the serial port

→ **Change Settings [Auto]**

Use the **Change Settings** option to change the serial port IO port address and interrupt address.

- | | | | |
|---|--------------------------------|----------------|---|
| → | Auto | DEFAULT | The serial port IO port address and interrupt address are automatically detected. |
| → | IO=3E8h;
IRQ=10 | | Serial Port I/O port address is 3E8h and the interrupt address is IRQ10 |
| → | IO=3E8h;
IRQ=10, 11 | | Serial Port I/O port address is 3E8h and the interrupt address is IRQ10, 11 |
| → | IO=2E8h;
IRQ=10, 11 | | Serial Port I/O port address is 2E8h and the interrupt address is IRQ10, 11 |
| → | IO=2E0h;
IRQ=10, 11 | | Serial Port I/O port address is 2E0h and the interrupt address is IRQ10, 11 |
| → | IO=2D8h;
IRQ=10, 11 | | Serial Port I/O port address is 2D8h and the interrupt address is IRQ10, 11 |
| → | IO=2D0h;
IRQ=10, 11 | | Serial Port I/O port address is 2D0h and the interrupt address is IRQ10, 11 |
- **Device Mode [RS422/RS485]**
- Use the **Device Mode** option to select the Serial Port 2 signaling mode.
- | | | | |
|---|--------------------|----------------|---|
| → | RS422/RS485 | DEFAULT | Serial Port 2 signaling mode is RS-422/RS-485 |
|---|--------------------|----------------|---|

PIC0e-HM650 Half-size PCIe CPU Card

5.3.6.2 Parallel Port Configuration

Use the **Parallel Port Configuration** menu (**BIOS Menu 10**) to configure the serial port n.

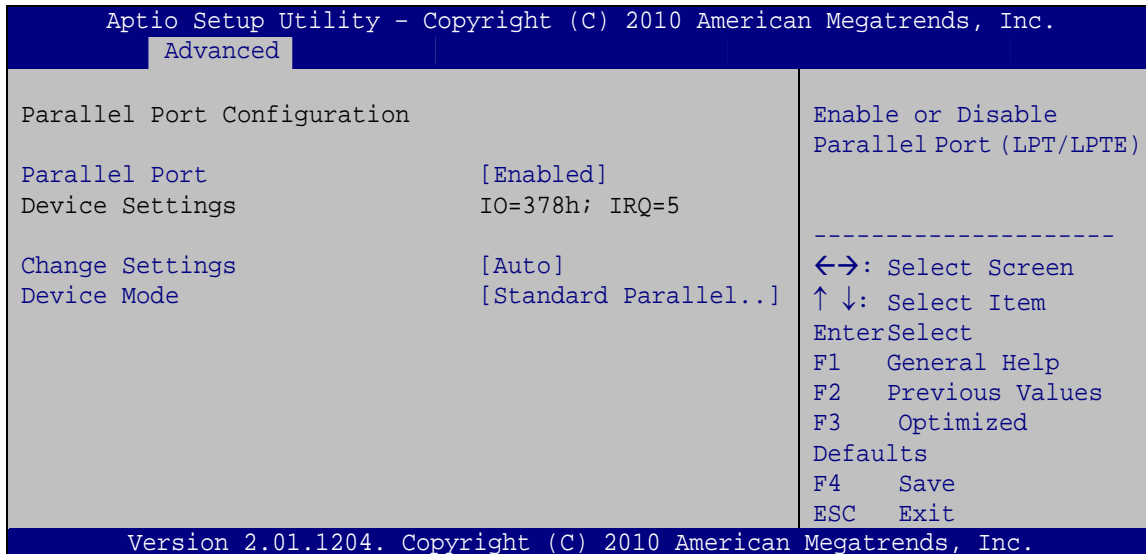

BIOS Menu 10: Parallel Port Configuration Menu

→ Parallel Port [Enabled]

Use the **Parallel Port** option to enable or disable the parallel port.

- **Disabled** Disable the parallel port
- **Enabled** **DEFAULT** Enable the parallel port

→ Change Settings [Auto]

Use the **Change Settings** option to change the parallel port IO port address and interrupt address.

- **Auto** **DEFAULT** The parallel port IO port address and interrupt address are automatically detected.
- **IO=378h;**
IRQ=5 Parallel Port I/O port address is 378h and the interrupt address is IRQ5

- IO=378h; Parallel Port I/O port address is 378h and the
IRQ=5, 6, 7, 10, interrupt address is IRQ5, 6, 7, 10, 11, 12
11, 12
- IO=278h; Parallel Port I/O port address is 278h and the
IRQ=5, 6, 7, 10, interrupt address is IRQ5, 6, 7, 10, 11, 12
11, 12
- IO=3BCh; Parallel Port I/O port address is 3BCh and the
IRQ=5, 6, 7, 10, interrupt address is IRQ5, 6, 7, 10, 11, 12
11, 12

→ **Device Mode [Standard Parallel Port Mode]**

Use the **Device Mode** option to select the mode the parallel port operates in. Configuration options are listed below.

- Standard Parallel Port Mode **Default**
- EPP Mode
- ECP Mode
- EPP Mode & ECP Mode
- Printer mode
- EPP 1.7 and SPP Mode
- ECP and EPP 1.7 Mode

5.3.7 H/W Monitor

The H/W Monitor menu (**BIOS Menu 11**) contains the fan configuration submenus and displays operating temperature, fan speeds and system voltages.

PICOe-HM650 Half-size PCIe CPU Card

```

Aptio Setup Utility - Copyright (C) 2011 American Megatrends, Inc.
Advanced
PC Health Status
CPU Temperature           :+81 C
Accuracy: 1. -5 ~ +10 degree around 100 degree.
                2. -10 ~ +15 degree around 50 degree.
SYS temperature          :+29 C
System FAN1 Speed        :4885 RPM
System FAN2 Speed        :N/A
VCC3V                     :+3.328 V
VCC_core                  :+1.016 V
+5V                       :+5.078 V
+12V                     :+12.232 V
+1.5V                    :+1.600 V
VSB3V                    :+3.328 V
VBAT                     :+3.328 V

> FAN 1 Configuration
> FAN 2 Configuration

Smart FAN Configuration
-----
<->: Select Screen
↑ ↓: Select Item
Enter>Select
+ - Change Opt.
F1  General Help
F2  Previous Values
F3  Optimized Defaults
F4  Save & Exit
ESC Exit

Version 2.11.1210. Copyright (C) 2011 American Megatrends, Inc.

```

BIOS Menu 11: H/W Monitor

→ PC Health Status

The following system parameters and values are shown. The system parameters that are monitored are:

- System Temperatures:
 - CPU Temperature
 - System Temperature
- Fan Speed:
 - System Fan1 Speed
 - System Fan2 Speed
- Voltages:
 - VCC3V
 - VCC_core
 - +5V
 - +12V
 - +1.5V
 - VSB3V
 - VBAT

5.3.7.1 FAN 1 Configuration

Use the **FAN 1 Configuration submenu (BIOS Menu 12)** to configure fan 1 temperature and speed settings.

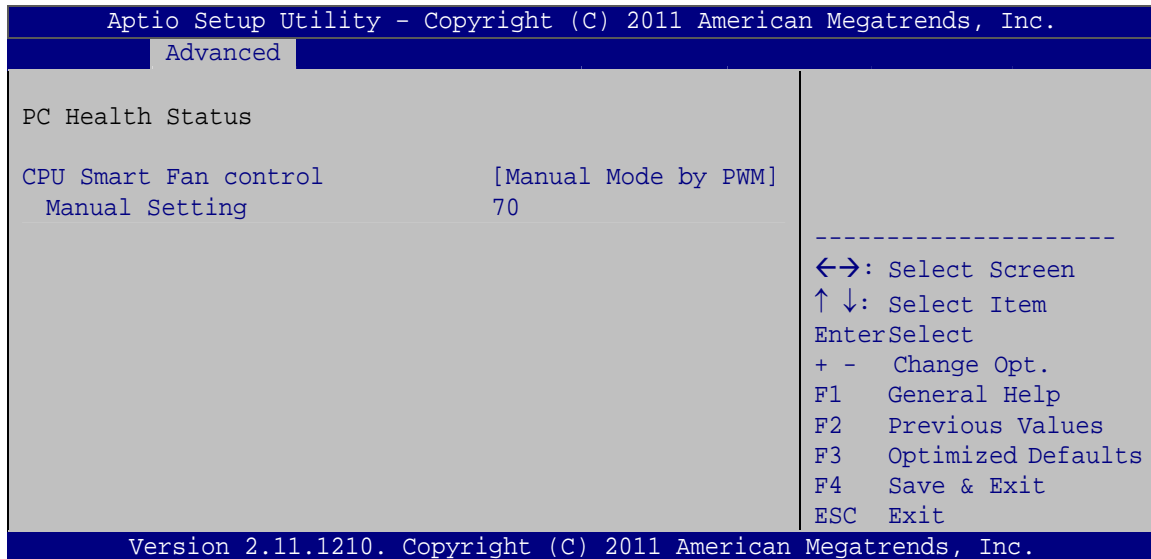

BIOS Menu 12: FAN 1 Configuration

→ CPU Smart Fan control [Manual Mode by RPM]

Use the **CPU Smart Fan control** option to configure the CPU Smart Fan.

- **Full Mode** Fan is on all the time
- **Manual Mode DEFAULT by PWM** The fan spins at the speed set in Manual by PWM settings
- **Auto Mode** The fan adjusts its speed using these settings:
 - Temp. Limit of OFF
 - Temp. Limit of Start
 - Fan Start PWM
 - Slope PWM

5.3.7.2 FAN 2 Configuration

Use the **FAN 2 Configuration submenu (BIOS Menu 13)** to configure fan 2 temperature and speed settings.

PIC0e-HM650 Half-size PCIe CPU Card

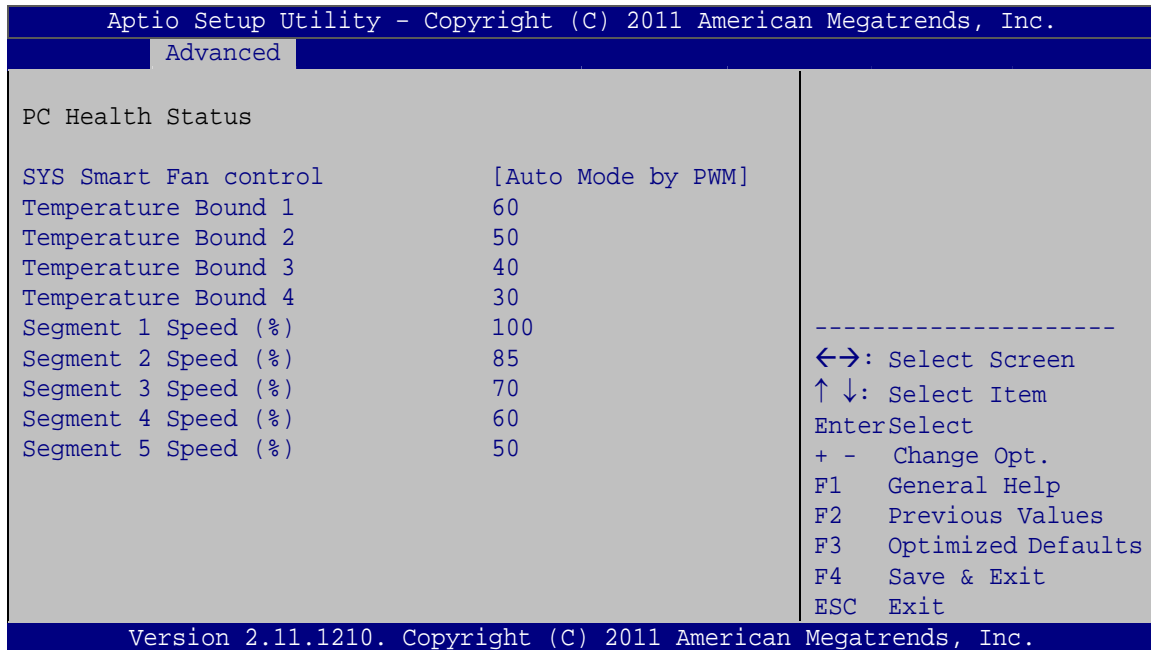

BIOS Menu 13: FAN 2 Configuration

→ SYS Smart Fan control [Auto Mode by PWM]

Use the **SYS Smart Fan control** option to configure the CPU Smart Fan.

- **Auto by RPM** The fan adjusts its speed using Auto by RPM settings
- **Auto Mode by DEFAULT** The fan adjusts its speed using Auto by PWM settings
PWM
- **Manual by** The fan spins at the speed set in Manual by RPM settings
RPM
- **Manual Mode** The fan spins at the speed set in Manual by PWM settings
by PWM

→ Temperature Bound n

Use the + or – key to change the fan **Temperature Bound n** value. Enter a decimal number between 0 and 127.

➔ **Segment n Speed (%)**

Use the + or – key to change the fan **Segment n Speed** value in percentage. Enter a decimal number between 0 and 100.

5.3.8 Serial Port Console Redirection

The **Serial Port Console Redirection** menu (**BIOS Menu 14**) allows the console redirection options to be configured. Console redirection allows users to maintain a system remotely by re-directing keyboard input and text output through the serial port.

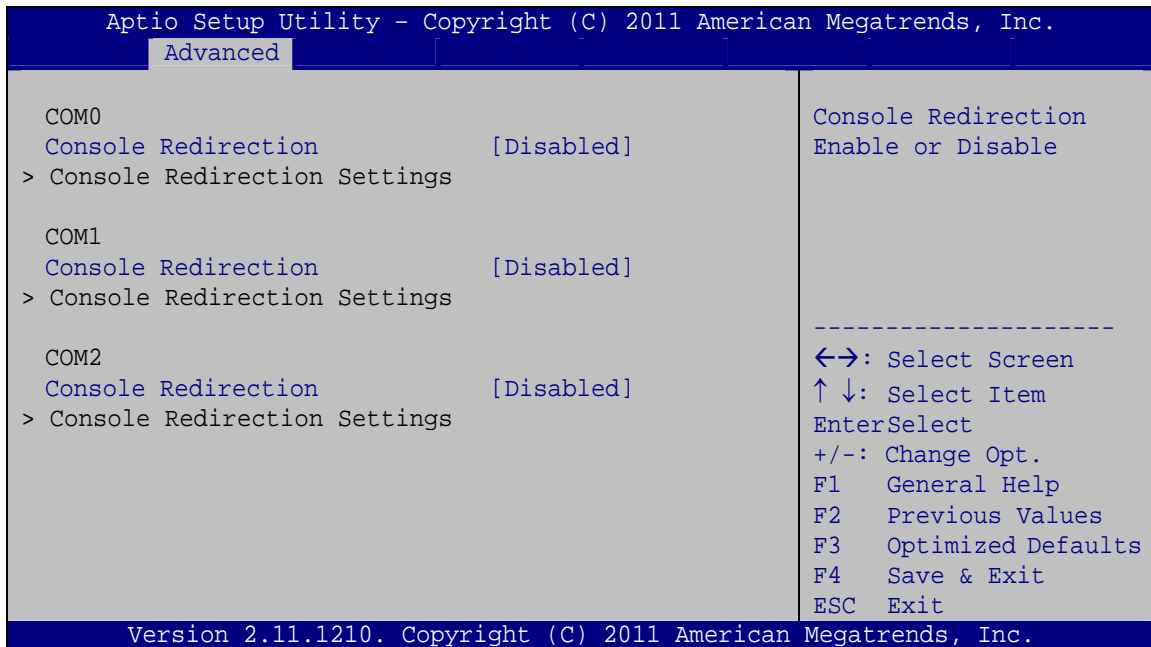

BIOS Menu 14: Serial Port Console Redirection

➔ **Console Redirection [Disabled]**

Use **Console Redirection** option to enable or disable the console redirection function.

- ➔ **Disabled** **DEFAULT** Disabled the console redirection function
- ➔ **Enabled** Enabled the console redirection function

PIC0e-HM650 Half-size PCIe CPU Card

5.3.9 IEI Feature

Use the **IEI Feature** menu (**BIOS Menu 15**) to configure One Key Recovery function.

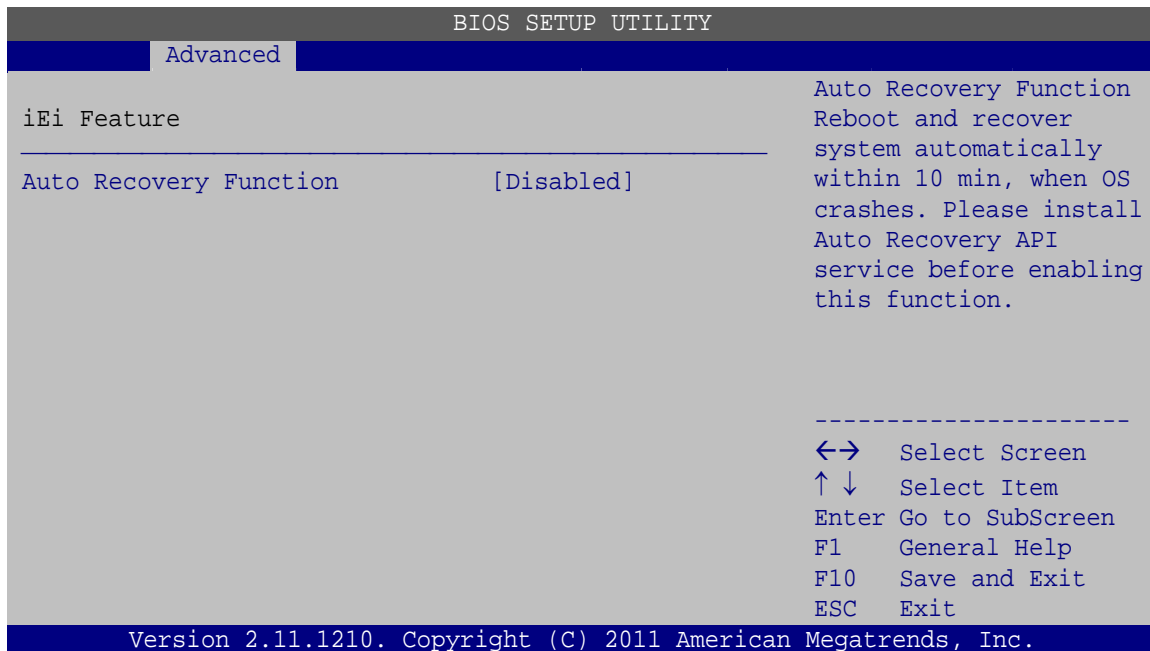

BIOS Menu 15: IEI Feature

➔ Auto Recovery Function [Disabled]

Use the **Auto Recovery Function** BIOS option to enable or disable the auto recovery function of the IEI One Key Recovery.

- ➔ **Disabled** **DEFAULT** Auto recovery function disabled
- ➔ **Enabled** Auto recovery function enabled

5.4 Chipset

Use the **Chipset** menu (**BIOS Menu 16**) to access the Northbridge, Southbridge, Integrated Graphics, and ME Subsystem configuration menus.

**WARNING!**

Setting the wrong values for the Chipset BIOS selections in the Chipset BIOS menu may cause the system to malfunction.

```
Aptio Setup Utility - Copyright (C) 2011 American Megatrends, Inc.
Main   Advanced  Chipset  Boot   Security  Save & Exit
-----
> NorthBridge Configuration
> SouthBridge Configuration

North Bridge Parameters
-----
<=>: Select Screen
↑↓: Select Item
EnterSelect
+ - Change Opt.
F1  General Help
F2  Previous Values
F3  Optimized Defaults
F4  Save & Exit
ESC Exit

Version 2.11.1210. Copyright (C) 2011 American Megatrends, Inc.
```

BIOS Menu 16: Chipset

PIC0e-HM650 Half-size PCIe CPU Card

5.4.1 Northbridge Configuration

Use the **Northbridge Chipset Configuration** menu (**BIOS Menu 17**) to configure the Northbridge chipset.

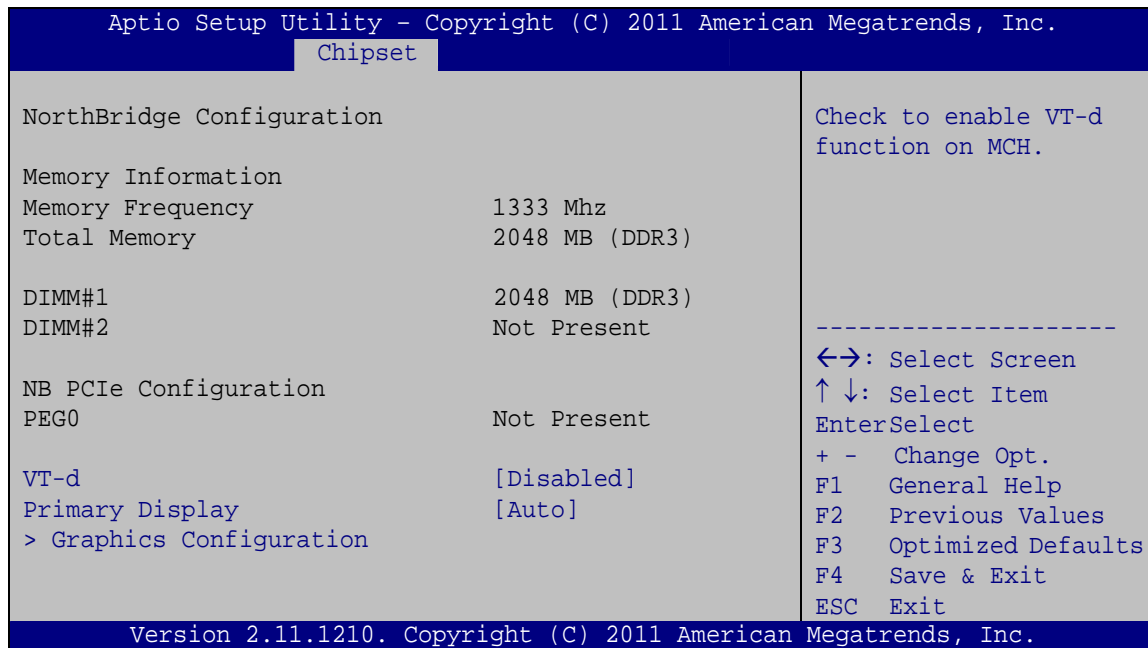

BIOS Menu 17:Northbridge Chipset Configuration

→ VT-d [Disabled]

Use the **VT-d** option to enable or disable VT-d support.

- **Disabled** **DEFAULT** Disables VT-d support.
- **Enabled** Enables VT-d support.

→ Primary Display [Auto]

Use the **Primary Display** option to select the primary display controller the system uses.

The following options are available:

- Auto **DEFAULT**
- IGFX
- PEG
- PCI

5.4.1.1 Graphics Configuration

Use the **Graphics Configuration** menu to configure the video device connected to the system.

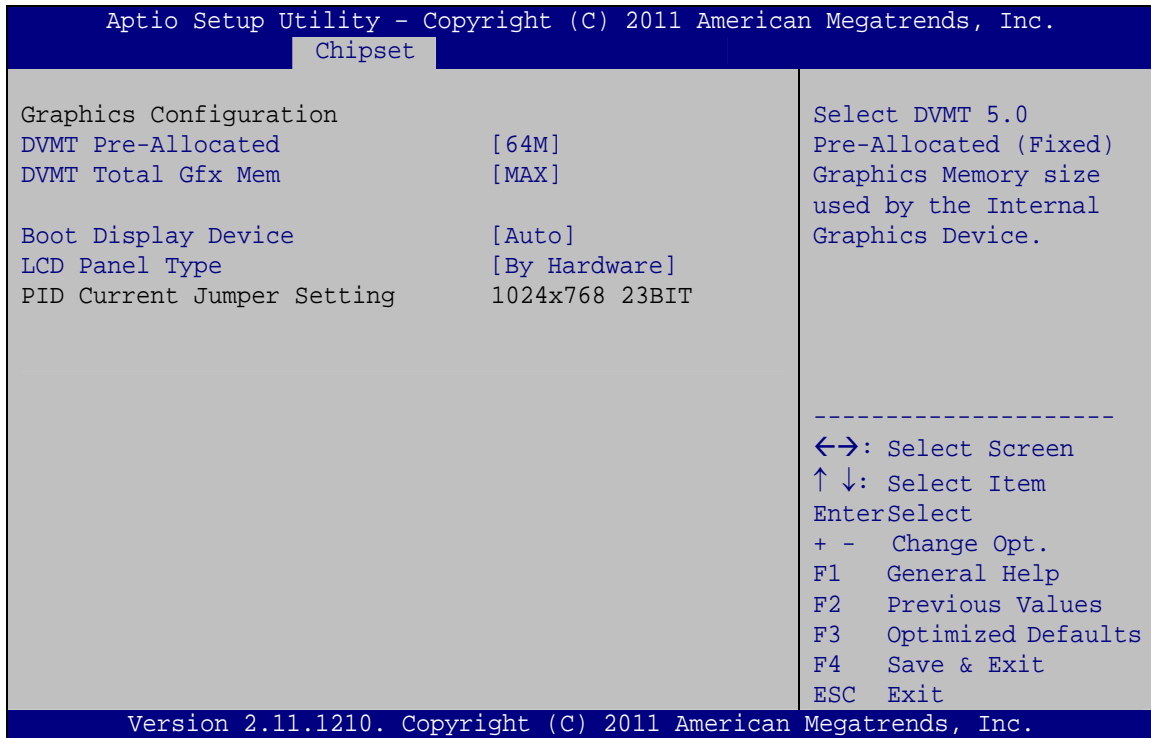

BIOS Menu 18:Graphics Configuration

→ DVMT Pre-Allocated [64MB]

Use the **DVMT Pre-Allocated** option to specify the amount of memory that can be allocated as graphics memory. Configuration options are listed below.

- 32M
- 64M **DEFAULT**
- 128M
- 256M
- 512M

PIC0e-HM650 Half-size PCIe CPU Card

→ DVMT Total Gfx Mem [MAX]

Use the **DVMT Total Gfx Mem** option to specify the total amount of memory that can be allocated as graphics memory. Configuration options are listed below.

- 128M
- 256M
- MAX **DEFAULT**

→ Boot Display Device

Use the **Boot Display Device** option to select the display device used by the system when it boots. Configuration options are listed below.

- Auto **DEFAULT**
- CRT
- LVDS

→ LCD Panel Type [By Hardware]

Use the **LCD Panel Type** option to select the type of flat panel connected to the system. Configuration options are listed below.

- By Hardware **DEFAULT**
- 640x480 18BIT
- 800x600 18BIT
- 1024x768 18BIT
- 1024x768 24BIT
- 1280x800 24BIT
- 1280x1024 48BIT
- 1366x768 24BIT
- 1440x900 48BIT
- 1400x1050 48BIT
- 1600x900 48BIT
- 1600x1200 48BIT
- 1680x1050 48BIT
- 1920x1080 48BIT
- 1920x1200 48BIT

- 2048x1536 48BIT

5.4.2 Southbridge Configuration

Use the **Southbridge Configuration** menu (**BIOS Menu 19**) to configure the Southbridge chipset.

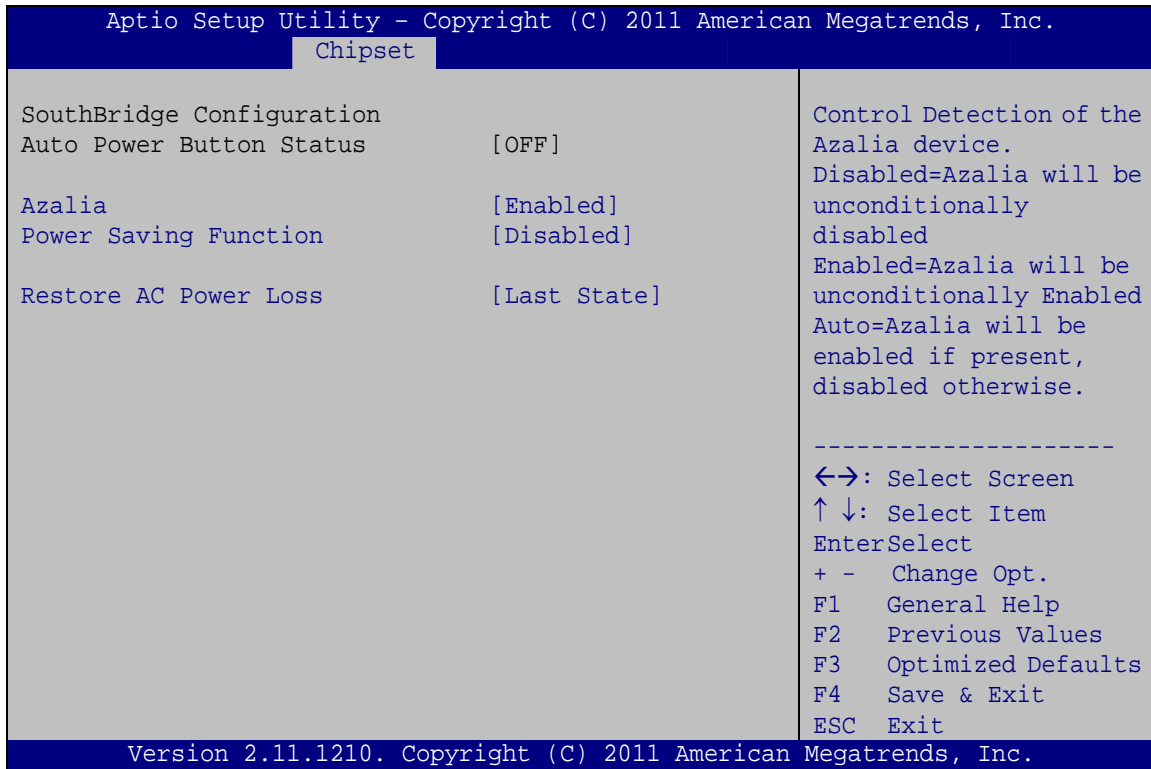

BIOS Menu 19: Southbridge Chipset Configuration

➔ Azalia [Enabled]

Use the **Azalia** option to enable or disable the High Definition Audio controller.

- ➔ **Disabled** The onboard High Definition Audio controller is disabled
- ➔ **Enabled DEFAULT** The onboard High Definition Audio controller is detected automatically and enabled

PIC0e-HM650 Half-size PCIe CPU Card

→ Power Saving Function [Disabled]

Use the **Power Saving Function** option to enable or disable the power saving function.

- **Disabled** **DEFAULT** The power saving function is disabled
- **Enabled** The power saving function is enabled

→ Restore on AC Power Loss [Last State]

Use the **Restore on AC Power Loss** BIOS option to specify what state the system returns to if there is a sudden loss of power to the system.

- **Power Off** The system remains turned off
- **Power On** The system turns on
- **Last State** **DEFAULT** The system returns to its previous state. If it was on, it turns itself on. If it was off, it remains off.

5.5 Boot

Use the **Boot** menu (**BIOS Menu 20**) to configure system boot options.

```

Aptio Setup Utility - Copyright (C) 2011 American Megatrends, Inc.
Main   Advanced  Chipset  Boot   Security  Save & Exit
-----
Boot Configuration
Bootup NumLock State      [On]
Quiet Boot                 [Enabled]
Launch PXE OpROM          [Disabled]
Option ROM Messages       [Keep Current]

Boot Option Priorities

-----
<->: Select Screen
↑ ↓: Select Item
Enter>Select
+ - Change Opt.
F1  General Help
F2  Previous Values
F3  Optimized Defaults
F4  Save & Exit
ESC Exit

Version 2.11.1210. Copyright (C) 2011 American Megatrends, Inc.

```

BIOS Menu 20: Boot

→ Bootup NumLock State [On]

Use the **Bootup NumLock State** BIOS option to specify if the number lock setting must be modified during boot up.

→ On **DEFAULT** Allows the Number Lock on the keyboard to be enabled automatically when the computer system boots up. This allows the immediate use of the 10-key numeric keypad located on the right side of the keyboard. To confirm this, the Number Lock LED light on the keyboard is lit.

→ Off Does not enable the keyboard Number Lock automatically. To use the 10-keys on the keyboard, press the Number Lock key located on the upper left-hand corner of the 10-key pad. The Number Lock LED on the keyboard lights up when the Number Lock is engaged.

→ Quiet Boot [Enabled]

Use the **Quiet Boot** BIOS option to select the screen display when the system boots.

→ Disabled Normal POST messages displayed

→ Enabled **DEFAULT** OEM Logo displayed instead of POST messages

→ Launch PXE OpROM [Disabled]

Use the **Launch PXE OpROM** option to enable or disable boot option for legacy network devices.

→ Disabled **DEFAULT** Ignore all PXE Option ROMs

→ Enabled Load PXE Option ROMs

PIC0e-HM650 Half-size PCIe CPU Card

→ Option ROM Messages [Keep Current]

Use the **Option ROM Messages** option to set the Option ROM display mode.

- **Force BIOS** Sets display mode to force BIOS.
- **Keep Current** **DEFAULT** Sets display mode to current.

5.6 Security

Use the **Security** menu (**BIOS Menu 21**) to set system and user passwords.

```

Aptio Setup Utility - Copyright (C) 2011 American Megatrends, Inc.
Main   Advanced  Chipset  Boot   Security  Save & Exit
-----
Password Description
If ONLY the Administrator's password is set,
then this only limits access to Setup and is
only asked for when entering Setup.
If ONLY the User's password is set, then this
is a power on password and must be entered to
boot or enter Setup. In Setup the User will
have Administrator rights.
The password must be 3 to 20 characters long.

Administrator Password
User Password

Set Setup Administrator
Password

-----
←→: Select Screen
↑ ↓: Select Item
Enter>Select
+ - Change Opt.
F1  General Help
F2  Previous Values
F3  Optimized Defaults
F4  Save & Exit
ESC Exit

Version 2.11.1210. Copyright (C) 2011 American Megatrends, Inc.

```

BIOS Menu 21: Security

→ Administrator Password

Use the **Administrator Password** to set or change a administrator password.

→ User Password

Use the **User Password** to set or change a user password.

5.7 Exit

Use the **Exit** menu (**BIOS Menu 22**) to load default BIOS values, optimal failsafe values and to save configuration changes.

```
Aptio Setup Utility - Copyright (C) 2011 American Megatrends, Inc.
Main   Advanced  Chipset  Boot   Security  Save & Exit
-----
Save Changes and Reset
Discard Changes and Reset

Restore Defaults
Save as User Defaults
Restore User Defaults

Exit the system after
saving the changes.

-----
<=>: Select Screen
↑ ↓: Select Item
Enter>Select
+ - Change Opt.
F1  General Help
F2  Previous Values
F3  Optimized Defaults
F4  Save & Exit
ESC Exit

Version 2.11.1210. Copyright (C) 2011 American Megatrends, Inc.
```

BIOS Menu 22:Exit

→ Save Changes and Reset

Use the **Save Changes and Reset** option to save the changes made to the BIOS options and reset the system.

→ Discard Changes and Reset

Use the **Discard Changes and Reset** option to exit the system without saving the changes made to the BIOS configuration setup program.

→ Restore Defaults

Use the **Restore Defaults** option to load the optimal default values for each of the parameters on the Setup menus. **F3 key can be used for this operation.**

PIC0e-HM650 Half-size PCIe CPU Card

→ Save as User Defaults

Use the **Save as User Defaults** option to save the changes done so far as user defaults.

→ Restore User Defaults

Use the **Restore User Defaults** option to restore the user defaults to all the setup options.

Appendix

A

BIOS Options

PIC0e-HM650 Half-size PCIe CPU Card

Below is a list of BIOS configuration options in the BIOS chapter.

System Overview	74
System Date [xx/xx/xx]	74
System Time [xx:xx:xx]	75
ACPI Sleep State [S1 (CPU Stop Clock)]	76
TPM Support [Disable]	77
Hyper-threading [Enabled]	78
Intel Virtualization Technology [Disabled]	79
SATA Mode Selection [IDE]	79
USB Devices	80
Legacy USB Support [Enabled]	80
Serial Port [Enabled]	82
Change Settings [Auto]	82
Serial Port [Enabled]	82
Change Settings [Auto]	83
Serial Port [Enabled]	83
Change Settings [Auto]	83
Device Mode [RS422/RS485]	84
Parallel Port [Enabled]	85
Change Settings [Auto]	85
Device Mode [Standard Parallel Port Mode]	86
PC Health Status	87
CPU Smart Fan control [Manual Mode by RPM]	88
SYS Smart Fan control [Auto Mode by PWM]	89
Temperature Bound n	89
Segment n Speed (%)	90
Console Redirection [Disabled]	90
Auto Recovery Function [Disabled]	91
VT-d [Disabled]	93
Primary Display [Auto]	93
DVMT Pre-Allocated [64MB]	94
DVMT Total Gfx Mem [MAX]	95
Boot Display Device	95
LCD Panel Type [By Hardware]	95

Azalia [Enabled]	96
Power Saving Function [Disabled].....	97
Restore on AC Power Loss [Last State]	97
Bootup NumLock State [On].....	98
Quiet Boot [Enabled]	98
Launch PXE OpROM [Disabled]	98
Option ROM Messages [Keep Current]	99
Administrator Password	99
User Password	99
Save Changes and Reset	100
Discard Changes and Reset	100
Restore Defaults	100
Save as User Defaults	101
Restore User Defaults	101

Appendix

B

One Key Recovery

B.1 One Key Recovery Introduction

The IEI one key recovery is an easy-to-use front end for the Norton Ghost system backup and recovery tool. This tool provides quick and easy shortcuts for creating a backup and reverting to that backup or reverting to the factory default settings.



NOTE:

The latest One Key Recovery software provides an auto recovery function that allows a system running Microsoft Windows OS to automatically restore from the factory default image after encountering a Blue Screen of Death (BSoD) or a hang for around 10 minutes. Please refer to Section B.3 for the detailed setup procedure.

The IEI One Key Recovery tool menu is shown below.

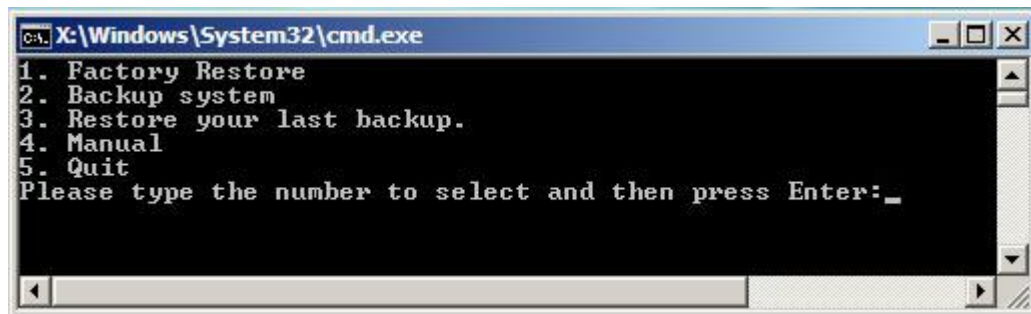

Figure B-1: IEI One Key Recovery Tool Menu

Prior to using the IEI One Key Recovery tool (as shown in **Figure B-1**) to backup or restore Windows system, five setup procedures are required.

1. Hardware and BIOS setup (see **Section B.2.1**)
2. Create partitions (see **Section B.2.2**)
3. Install operating system, drivers and system applications (see **Section B.2.3**)
4. Build the recovery partition (see **Section B.2.4**)
5. Create factory default image (see **Section B.2.5**)

PICOe-HM650 Half-size PCIe CPU Card

After completing the five initial setup procedures as described above, users can access the recovery tool by pressing <F3> while booting up the system. The detailed information of each function is described in **Section B.5**.



NOTE:

The initial setup procedures for Linux system are described in **Section B.3**.

B.1.1 System Requirement



NOTE:

The recovery CD can only be used with IEI products. The software will fail to run and a warning message will appear when used on non-IEI hardware.

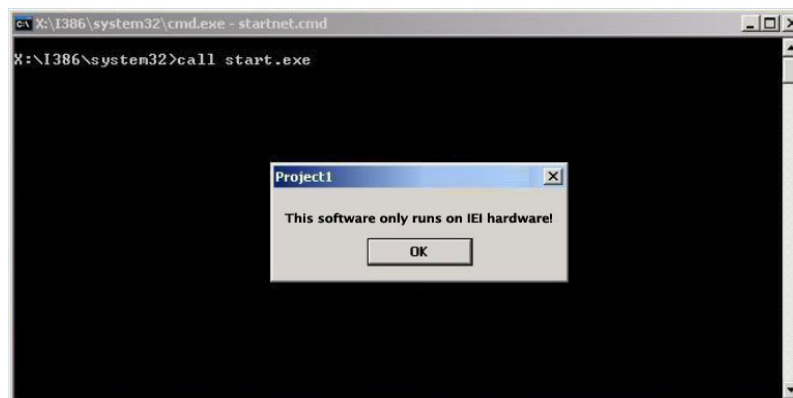

To create the system backup, the main storage device must be split into two partitions (three partitions for Linux). The first partition will be for the operating system, while the second partition will be invisible to the operating system and contain the backup made by the one key recovery software.

The partition created for recovery images must be big enough to contain both the factory default image and the user backup image. The size must be calculated before creating the

partitions. Please take the following table as a reference when calculating the size of the partition.

	OS	OS Image after Ghost	Compression Ratio
Windows® 7	7 GB	5 GB	70%
Windows® XPE	776 MB	560 MB	70%
Windows® CE 6.0	36 MB	28 MB	77%

**NOTE:**

Specialized tools are required to change the partition size if the operating system is already installed.

B.1.2 Supported Operating System

The recovery CD is compatible with both Microsoft Windows and Linux operating systems (OS). The supported OS versions are listed below.

- Microsoft Windows
 - Windows 2000
 - Windows XP (Service Pack 2 or 3 required)
 - Windows Vista
 - Windows 7
 - Windows CE 5.0
 - Windows CE 6.0
 - Windows XP Embedded
 - Windows Embedded Standard 7

**NOTE:**

The auto recovery function (described in Section B.3) and the restore through LAN function (described in Section B.6) are not supported in the Windows CE 5.0/6.0 operating system environment.

PIC0e-HM650 Half-size PCIe CPU Card

- Linux
 - Fedora Core 12 (Constantine)
 - Fedora Core 11 (Leonidas)
 - Fedora Core 10 (Cambridge)
 - Fedora Core 8 (Werewolf)
 - Fedora Core 7 (Moonshine)
 - RedHat RHEL-5.4
 - RedHat 9 (Ghirke)
 - Ubuntu 8.10 (Intrepid)
 - Ubuntu 7.10 (Gutsy)
 - Ubuntu 6.10 (Edgy)
 - Debian 5.0 (Lenny)
 - Debian 4.0 (Etch)
 - SuSe 11.2
 - SuSe 10.3



NOTE:

Installing unsupported OS versions may cause the recovery tool to fail.

B.2 Setup Procedure for Windows

Prior to using the recovery tool to backup or restore, a few setup procedures are required.

Step 1: Hardware and BIOS setup (see **Section B.2.1**)

Step 2: Create partitions (see **Section B.2.2**)

Step 3: Install operating system, drivers and system applications (see **Section B.2.3**)

Step 4: Build the recovery partition (see **Section B.2.4**) or build the auto recovery partition (see **Section B.3**)

Step 5: Create factory default image (see **Section B.2.5**)

The detailed descriptions are described in the following sections.

**NOTE:**

The setup procedures described below are for Microsoft Windows operating system users. For Linux, most of the setup procedures are the same except for several steps described in **Section B.3**.

B.2.1 Hardware and BIOS Setup

- Step 1:** Make sure the system is powered off and unplugged.
- Step 2:** Install a hard drive or SSD in the system. An unformatted and unpartitioned disk is recommended.
- Step 3:** Connect an optical disk drive to the system and insert the recovery CD.
- Step 4:** Turn on the system.
- Step 5:** Press the <DELETE> key as soon as the system is turned on to enter the BIOS.
- Step 6:** Select the connected optical disk drive as the 1st boot device. (**Boot** → **Boot Device Priority** → **1st Boot Device**).
- Step 7:** Save changes and restart the computer. Continue to the next section for instructions on partitioning the internal storage.

B.2.2 Create Partitions

To create the system backup, the main storage device must be split into two partitions (three partitions for Linux). The first partition will be for the operating system, while the second partition will be invisible to the operating system and contain the backup made by the one key recovery software.

- Step 1:** Put the recovery CD in the optical drive of the system.

PIC0e-HM650 Half-size PCIe CPU Card

Step 2: Boot the system from recovery CD. When prompted, press any key to boot from the recovery CD. It will take a while to launch the recovery tool. Please be patient!

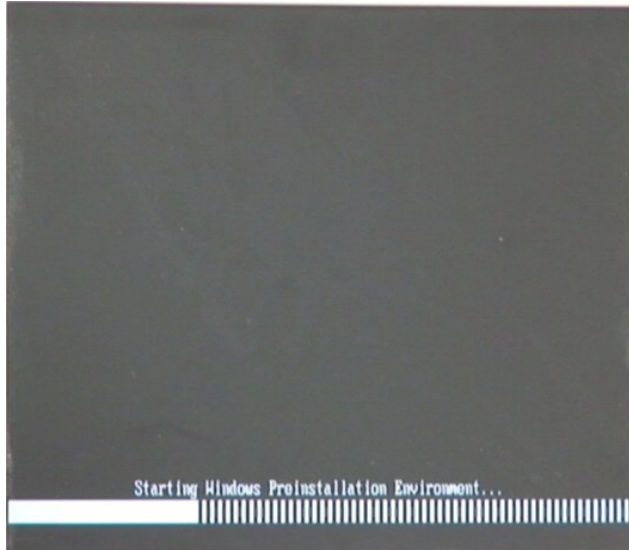

Figure B-2: Launching the Recovery Tool

Step 3: The recovery tool setup menu is shown as below.

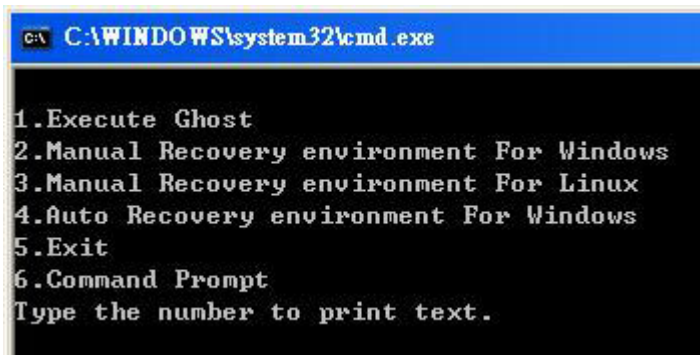
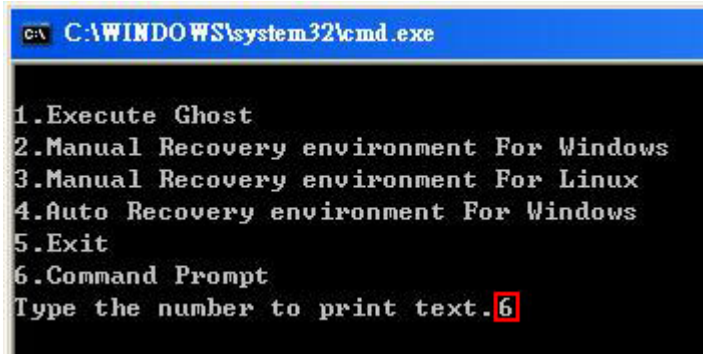

Figure B-3: Recovery Tool Setup Menu

Step 4: Press <6> then <Enter>.



```

C:\WINDOWS\system32\cmd.exe

1.Execute Ghost
2.Manual Recovery environment For Windows
3.Manual Recovery environment For Linux
4.Auto Recovery environment For Windows
5.Exit
6.Command Prompt
Type the number to print text.6
  
```

Figure B-4: Command Prompt

Step 5: The command prompt window appears. Type the following commands (marked in red) to create two partitions. One is for the OS installation; the other is for saving recovery files and images which will be an invisible partition. (Press <Enter> after entering each line below)

```

system32>diskpart
DISKPART>list vol
DISKPART>sel disk 0
DISKPART>create part pri size= ____
DISKPART>assign letter=N
DISKPART>create part pri size= ____
DISKPART>assign letter=F
DISKPART>exit
system32>format N: /fs:ntfs /q /y
system32>format F: /fs:ntfs /q /v:Recovery /y
system32>exit
  
```

PIC0e-HM650 Half-size PCIe CPU Card

```

X:\I386\SYSTEM32\CMD.EXE
X:\I386\SYSTEM32>diskpart → Starts the Microsoft disk partitioning tool.

Microsoft DiskPart version 5.2.3790.1830
Copyright (C) 1999-2001 Microsoft Corporation.
On computer: MININT-JUC

DISKPART> list vol → Show partition information

   Volume ###  Ltr  Label          Fs          Type          Size         Status       Info
   -----
   Volume 0          X  CD_ROM          CDFS        DUD-ROM       405 MB       Healthy      Boot
   Volume 1          D                FAT32        Removeable   3854 MB       Healthy

DISKPART> sel disk 0 → Select a disk

Disk 0 is now the selected disk.

DISKPART> create part pri size=2000 → Create partition 1 and assign a size.
                                       This partition is for OS installation.
DiskPart succeeded in creating the specified partition.

DISKPART> assign letter=N → Assign partition 1 a code name (N).
DiskPart successfully assigned the drive letter or mount point.

DISKPART> create part pri size=1800 → Create partition 2 and assign a size.
                                       This partition is for recovery images.
DiskPart succeeded in creating the specified partition.

DISKPART> assign letter=F → Assign partition 2 a code name (F).
DiskPart successfully assigned the drive letter or mount point.

DISKPART> exit → Exit diskpart

X:\I386\SYSTEM32>format n: /fs:ntfs /q /y → Format partition 1 (N) as NTFS format.
The type of the file system is RAW.
The new file system is NTFS.
QuickFormatting 2000M
Creating file system structures.
Format complete.
 2048254 KB total disk space.
 2035620 KB are available.

X:\I386\SYSTEM32>format f: /fs:ntfs /q /v:Recovery /y
The type of the file system is RAW.
The new file system is NTFS.
QuickFormatting 1804M
Creating file system structures.
Format complete.
 1847474 KB total disk space.
 1835860 KB are available.

X:\I386\SYSTEM32>exit → Exit Windows PE
  
```

Figure B-5: Partition Creation Commands

**NOTE:**

Use the following commands to check if the partitions were created successfully.

```
X:\I386\SYSTEM32>diskpart
Microsoft DiskPart version 5.2.3790.1830
Copyright (C) 1999-2001 Microsoft Corporation.
On computer: MININT-JUC

DISKPART> sel disk 0
Disk 0 is now the selected disk.

DISKPART> list part

   Partition ###   Type              Size              Offset
-----
   Partition 1     Primary            2000 MB           32 KB
   Partition 2     Primary            1804 MB          2000 MB

DISKPART> exit
```

Step 6: Press any key to exit the recovery tool and automatically reboot the system.

Please continue to the following procedure: Build the Recovery Partition.

B.2.3 Install Operating System, Drivers and Applications

Install the operating system onto the unlabelled partition. The partition labeled "Recovery" is for use by the system recovery tool and should not be used for installing the operating system or any applications.

**NOTE:**

The operating system installation program may offer to reformat the chosen partition. DO NOT format the partition again. The partition has already been formatted and is ready for installing the new operating system.

To install the operating system, insert the operating system installation CD into the optical drive. Restart the computer and follow the installation instructions.

PIC0e-HM650 Half-size PCIe CPU Card

B.2.4 Building the Recovery Partition

- Step 1:** Put the recover CD in the optical drive.
- Step 2:** Start the system.
- Step 3:** **Boot the system from the recovery CD.** When prompted, press any key to boot from the recovery CD. It will take a while to launch the recovery tool. Please be patient!

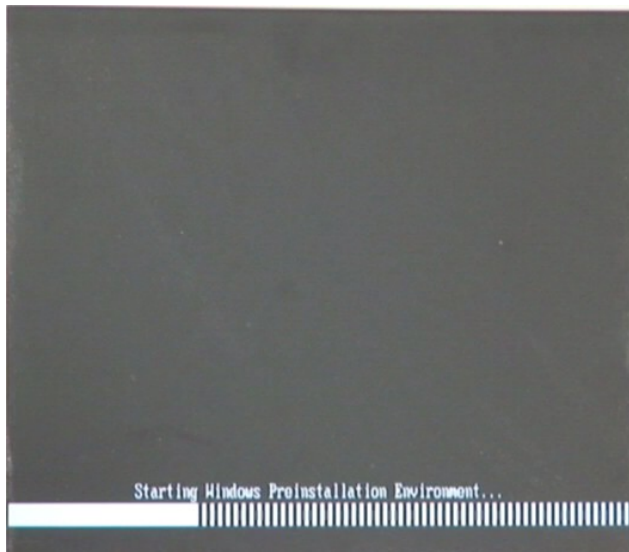

Figure B-6: Launching the Recovery Tool

- Step 4:** When the recovery tool setup menu appears, press <2> then <Enter>.

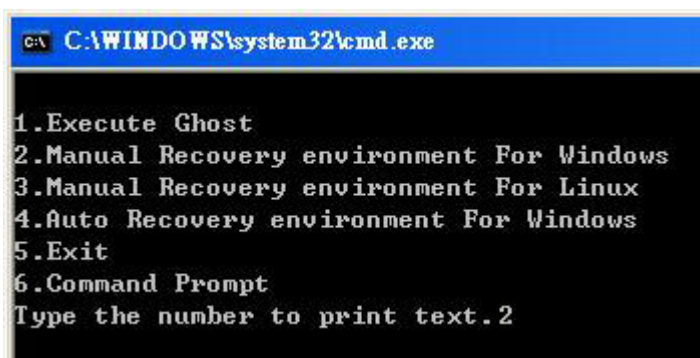

Figure B-7: Manual Recovery Environment for Windows

Step 5: The Symantec Ghost window appears and starts configuring the system to build a recovery partition. In this process the partition created for recovery files in **Section B.2.2** is hidden and the recovery tool is saved in this partition.

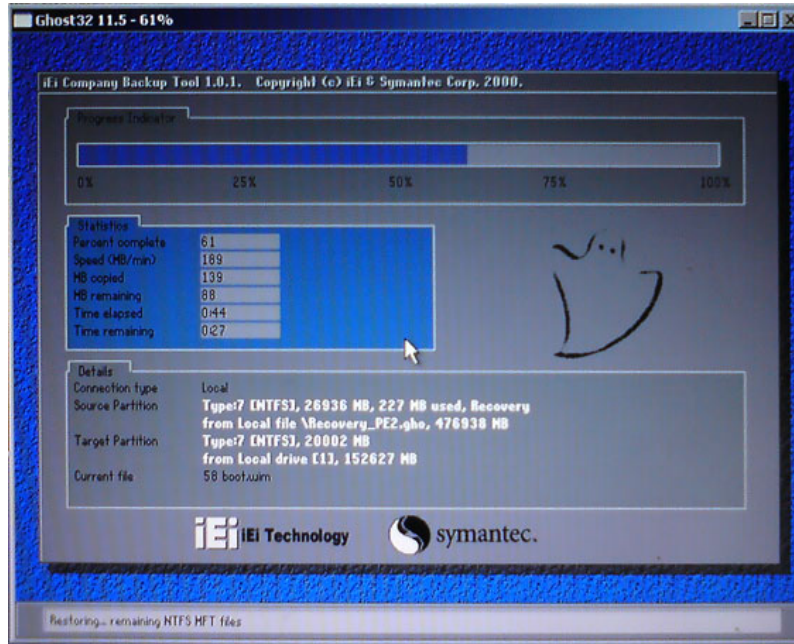

Figure B-8: Building the Recovery Partition

Step 6: After completing the system configuration, press any key in the following window to reboot the system.

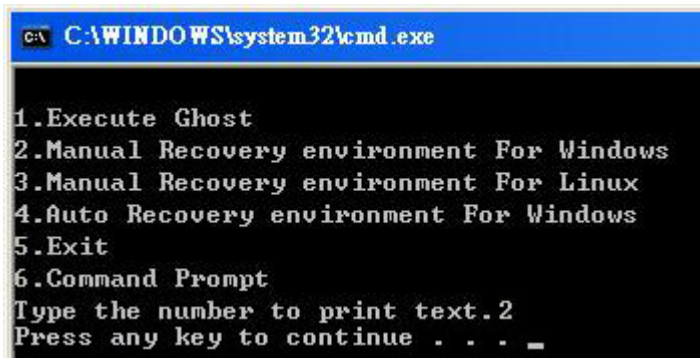

Figure B-9: Press Any Key to Continue

Step 7: Eject the recovery CD.

PIC0e-HM650 Half-size PCIe CPU Card

B.2.5 Create Factory Default Image



NOTE:

Before creating the factory default image, please configure the system to a factory default environment, including driver and application installations.

To create a factory default image, please follow the steps below.

Step 1: Turn on the system. When the following screen displays (**Figure B-10**), press the <F3> key to access the recovery tool. The message will display for 10 seconds, please press F3 before the system boots into the operating system.

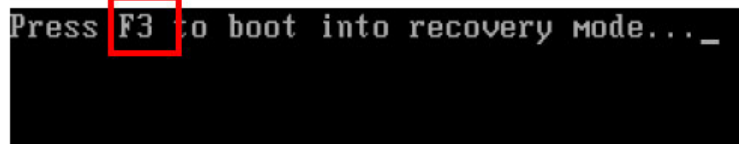

```
Press F3 to boot into recovery mode... _
```

Figure B-10: Press F3 to Boot into Recovery Mode

Step 2: The recovery tool menu appears. Type <4> and press <Enter>. (**Figure B-11**)

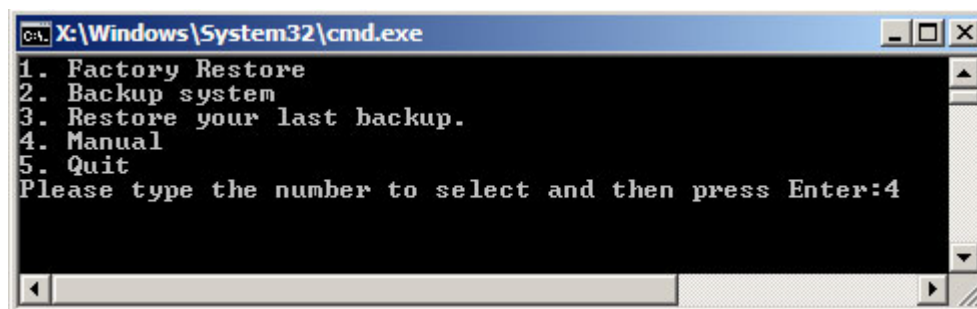

Figure B-11: Recovery Tool Menu

Step 3: The About Symantec Ghost window appears. Click **OK** button to continue.

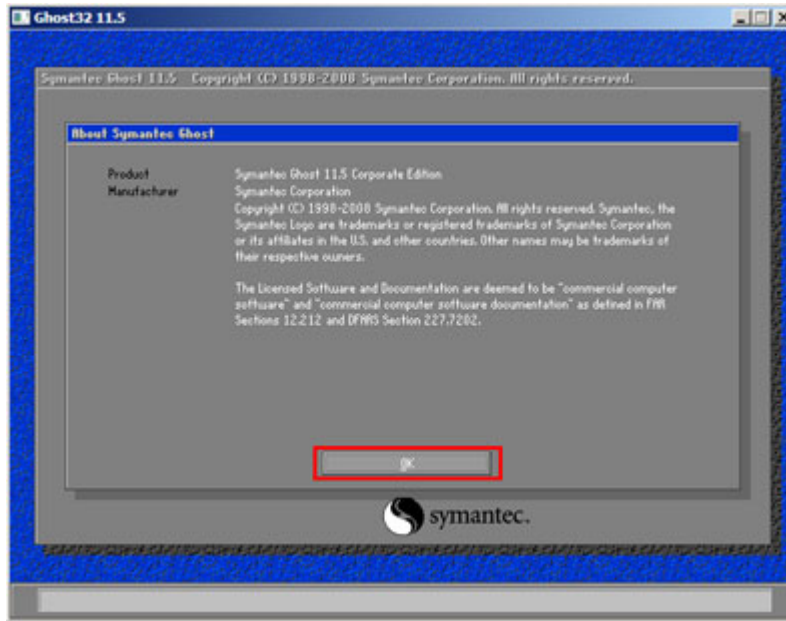

Figure B-12: About Symantec Ghost Window

Step 4: Use mouse to navigate to the option shown below (Figure B-13).

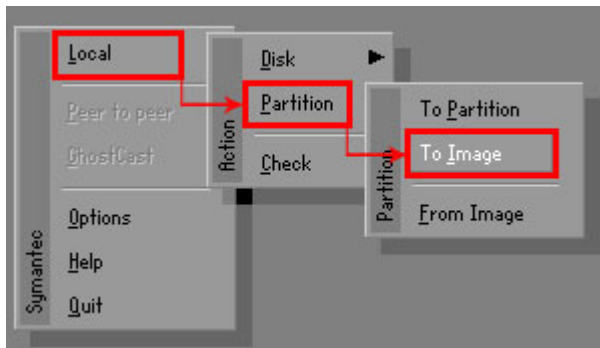

Figure B-13: Symantec Ghost Path

Step 5: Select the local source drive (Drive 1) as shown in Figure B-14. Then click OK.

PICOe-HM650 Half-size PCIe CPU Card

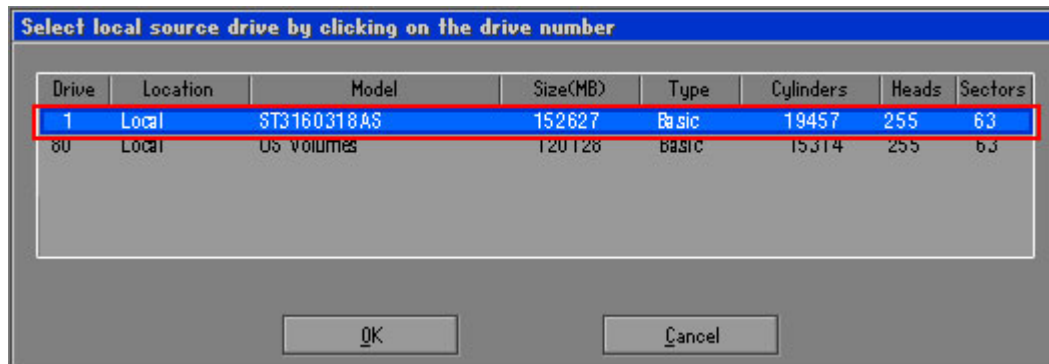

Figure B-14: Select a Local Source Drive

Step 6: Select a source partition (Part 1) from basic drive as shown in **Figure B-15**. Then click OK.

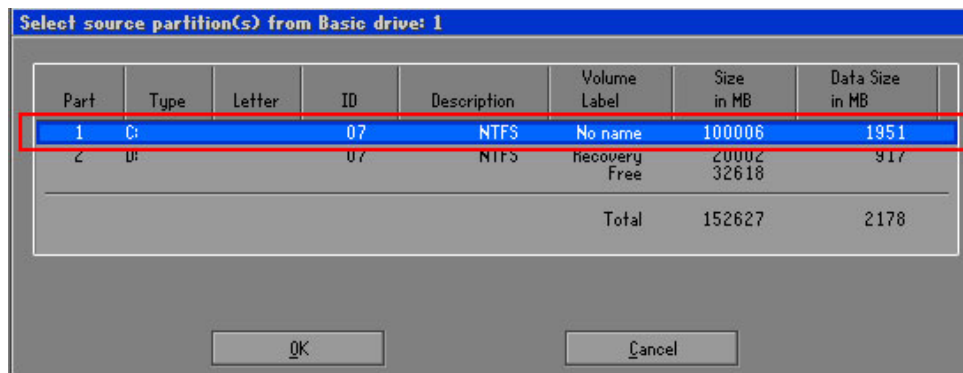

Figure B-15: Select a Source Partition from Basic Drive

Step 7: Select **1.2: [Recovery] NTFS drive** and enter a file name called **iei** (**Figure B-16**). Click **Save**. The factory default image will then be saved in the selected recovery drive and named **IEI.GHO**.



WARNING:

The file name of the factory default image must be **iei.GHO**.

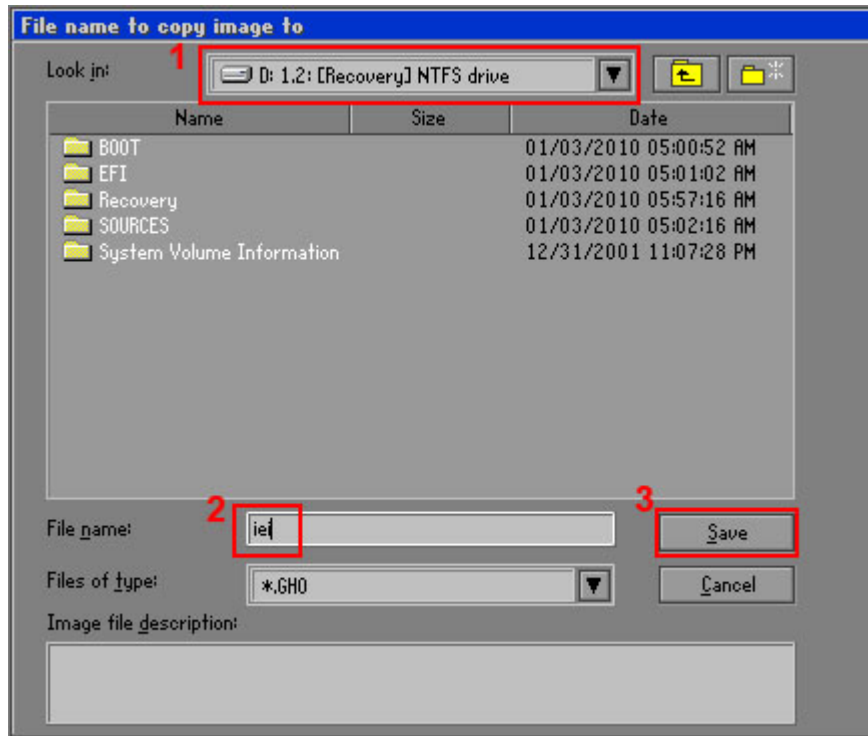

Figure B-16: File Name to Copy Image to

Step 8: When the Compress Image screen in **Figure B-17** prompts, click **High** to make the image file smaller.

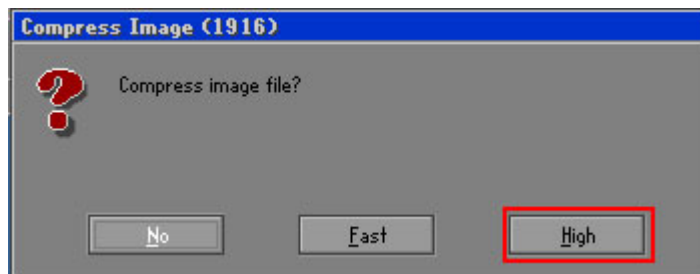

Figure B-17: Compress Image

PICOe-HM650 Half-size PCIe CPU Card

Step 9: The Proceed with partition image creation window appears, click **Yes** to continue.

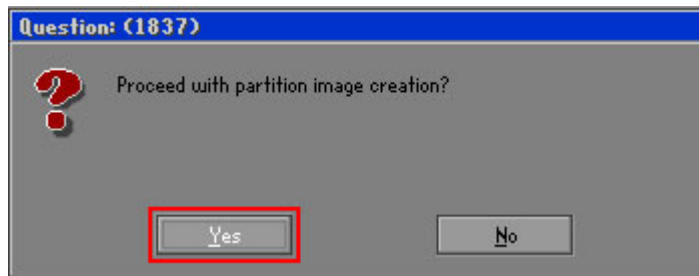

Figure B-18: Image Creation Confirmation

Step 10: The Symantec Ghost starts to create the factory default image (**Figure B-19**).

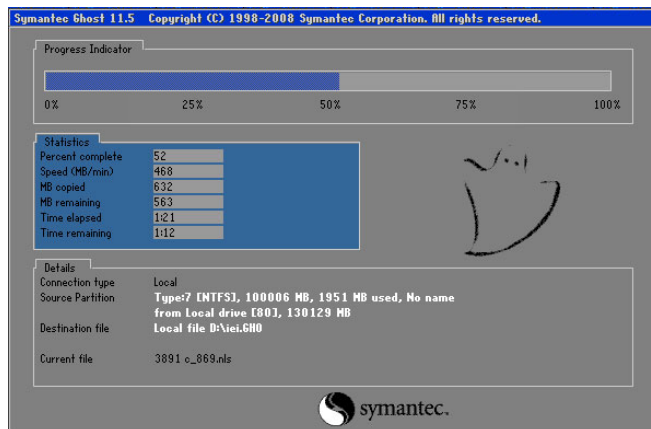

Figure B-19: Image Creation Complete

Step 11: When the image creation completes, a screen prompts as shown in **Figure B-20**.

Click **Continue** and close the Ghost window to exit the program.

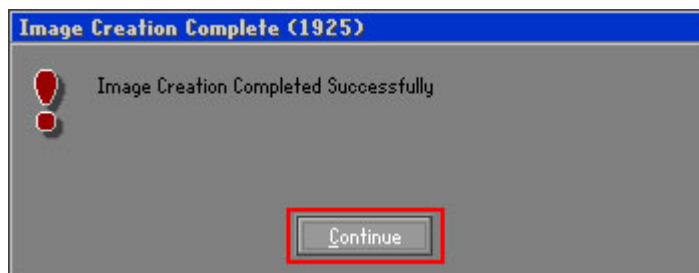
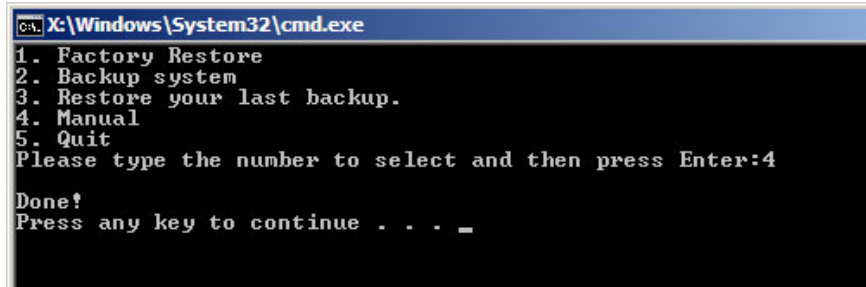

Figure B-20: Image Creation Complete

Step 12: The recovery tool main menu window is shown as below. Press any key to reboot the system.



```

C:\Windows\System32\cmd.exe
1. Factory Restore
2. Backup system
3. Restore your last backup.
4. Manual
5. Quit
Please type the number to select and then press Enter:4
Done!
Press any key to continue . . . _
  
```

Figure B-21: Press Any Key to Continue

B.3 Auto Recovery Setup Procedure

The auto recovery function allows a system to automatically restore from the factory default image after encountering a Blue Screen of Death (BSoD) or a hang for around 10 minutes. To use the auto recovery function, follow the steps described in the following sections.



CAUTION:

The auto recovery function can only run on a Microsoft Windows system with the following OS versions:

- Windows 2000
- Windows XP
- Windows Vista
- Windows 7
- Windows XP Embedded
- Windows Embedded Standard 7



CAUTION:

The setup procedure may include a step to create a factory default image. It is suggested to configure the system to a factory default environment before the configuration, including driver and application installations.

PIC0e-HM650 Half-size PCIe CPU Card

- Step 1:** Follow the steps described in **Section B.2.1 ~ Section B.2.3** to setup BIOS, create partitions and install operating system.
- Step 2:** Install the auto recovery utility into the system by double clicking the **Utility/AUTORECOVERY-SETUP.exe** in the One Key Recovery CD. This utility **MUST** be installed in the system, otherwise, the system will automatically restore from the factory default image every ten (10) minutes.



Figure B-22: Auto Recovery Utility

- Step 3:** **Disable the automatically restart function before creating the factory default image.** Go to: My Computer → Properties → Advanced. Click the Settings button of Startup and Recovery. Deselect “Automatically restart”. Click OK to save the settings and exit. (See Figure B-23)

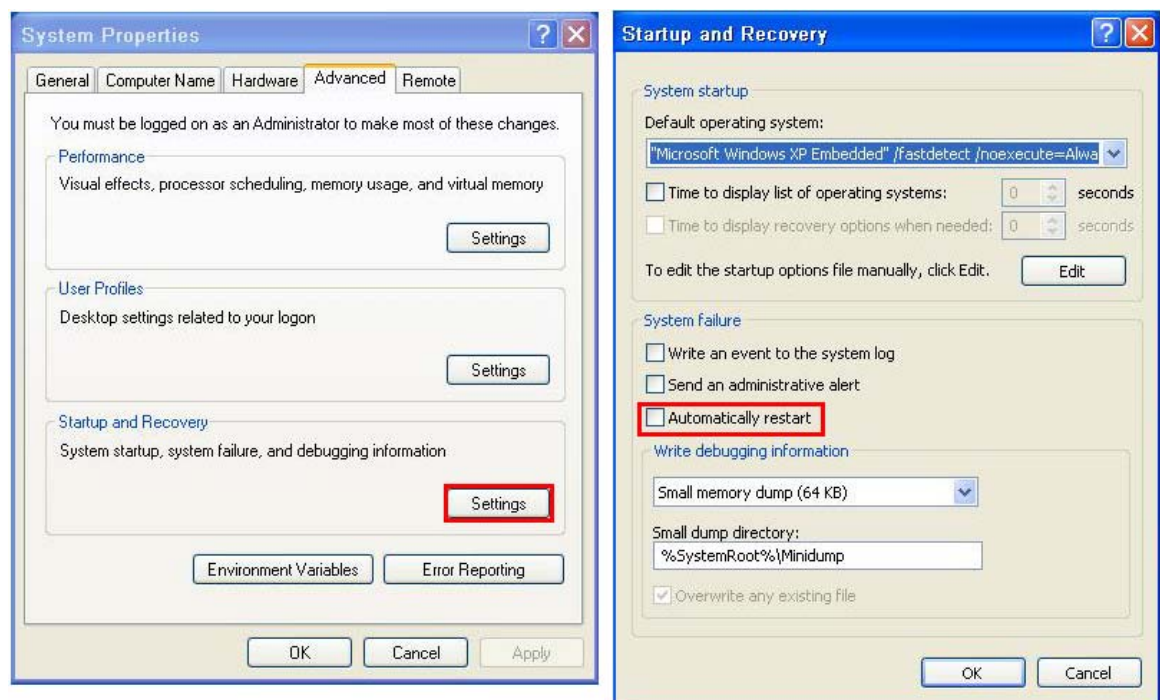

Figure B-23: Disable Automatically Restart

Step 4: Reboot the system from the recovery CD. When prompted, press any key to boot from the recovery CD. It will take a while to launch the recovery tool. Please be patient!

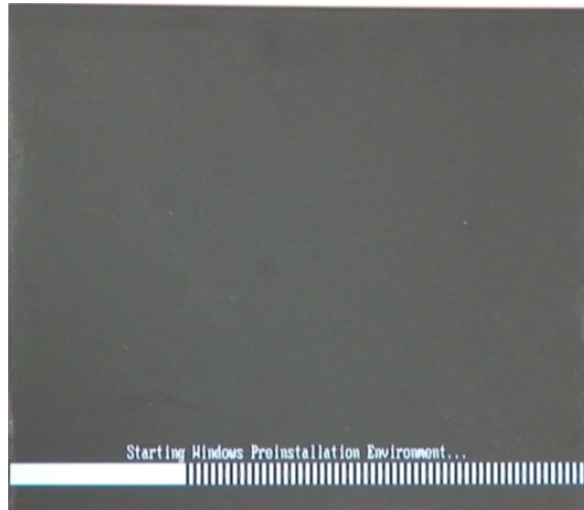

Figure B-24: Launching the Recovery Tool

Step 5: When the recovery tool setup menu appears, press <4> then <Enter>.

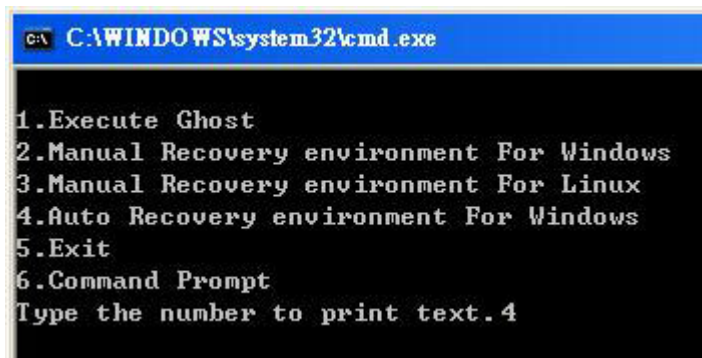

Figure B-25: Auto Recovery Environment for Windows

Step 6: The Symantec Ghost window appears and starts configuring the system to build an auto recovery partition. In this process the partition created for recovery files in **Section B.2.2** is hidden and the auto recovery tool is saved in this partition.

PICOe-HM650 Half-size PCIe CPU Card

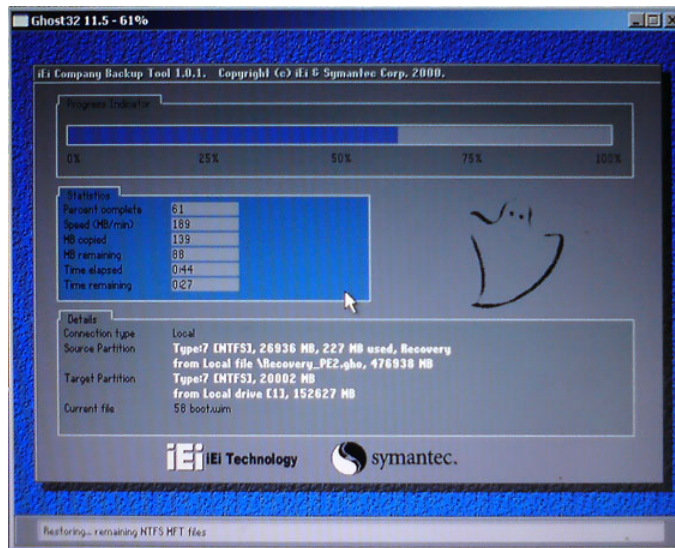

Figure B-26: Building the Auto Recovery Partition

Step 7: After completing the system configuration, the following message prompts to confirm whether to create a factory default image. Type **Y** to have the system create a factory default image automatically. Type **N** within 6 seconds to skip this process (The default option is YES). It is suggested to choose YES for this option.



Figure B-27: Factory Default Image Confirmation

Step 8: The Symantec Ghost starts to create the factory default image (**Figure B-28**).

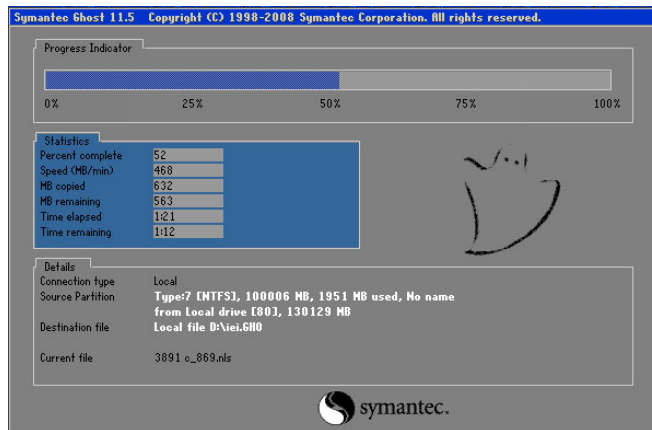

Figure B-28: Image Creation Complete

Step 9: After completing the system configuration, press any key in the following window to restart the system.

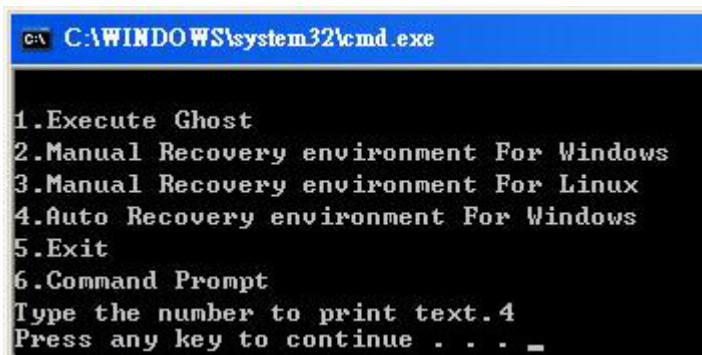

Figure B-29: Press any key to continue

Step 10: Eject the One Key Recovery CD and restart the system.

Step 11: Press the <DELETE> key as soon as the system is turned on to enter the BIOS.

Step 12: Enable the Auto Recovery Function option (**Advanced** → **iEi Feature** → **Auto Recovery Function**).

PIC0e-HM650 Half-size PCIe CPU Card

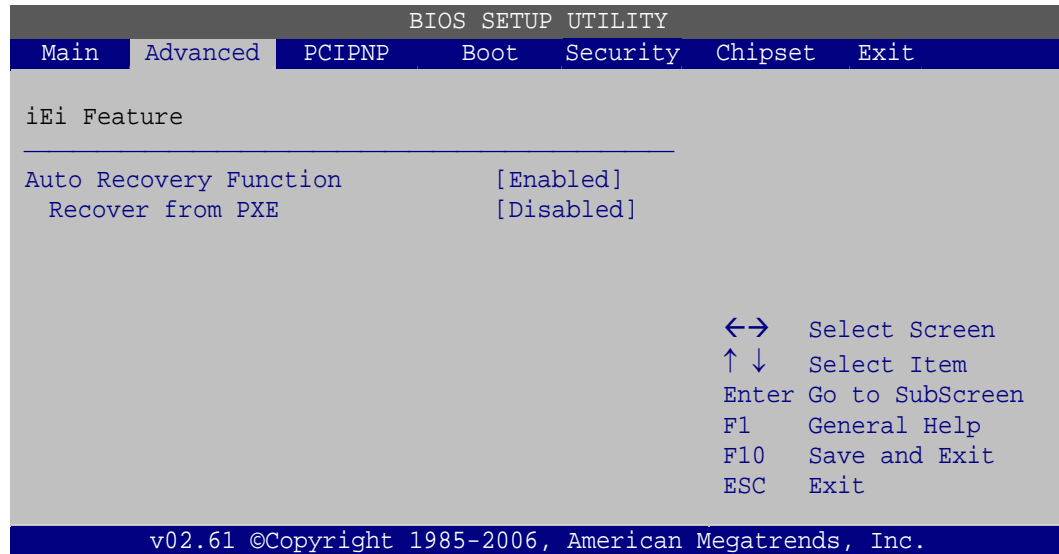

BIOS Menu 23: IEI Feature

Step 13: Save changes and restart the system. If the system encounters a Blue Screen of Death (BSoD) or a hang for around 10 minutes, it will automatically restore from the factory default image.

B.4 Setup Procedure for Linux

The initial setup procedure for Linux system is mostly the same with the procedure for Microsoft Windows. Please follow the steps below to setup recovery tool for Linux OS.

Step 1: Hardware and BIOS setup. Refer to **Section B.2.1**.

Step 2: Install Linux operating system. Make sure to install GRUB (v0.97 or earlier) MBR type and Ext3 partition type. Leave enough space on the hard drive to create the recover partition later.



NOTE:

If the Linux OS is not installed with GRUB (v0.97 or earlier) and Ext3, the Symantec Ghost may not function properly.

While installing Linux OS, please create two partitions:

- Partition 1: /
- Partition 2: SWAP

NOTE:

Please reserve enough space for partition 3 for saving recovery images.

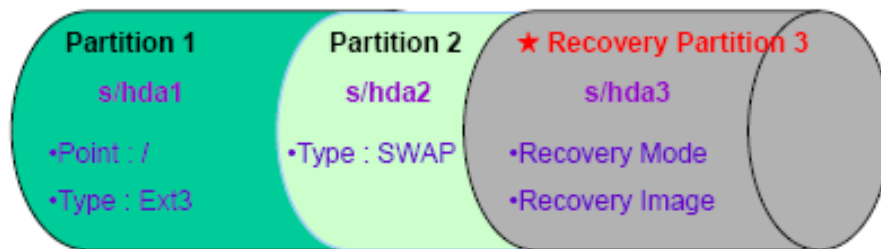

Figure B-30: Partitions for Linux

Step 3: Create a recovery partition. Insert the recovery CD into the optical disk drive.

Follow **Step 1 ~ Step 3** described in **Section B.2.2**. Then type the following commands (marked in red) to create a partition for recovery images.

```

system32>diskpart
DISKPART>list vol
DISKPART>sel disk 0
DISKPART>create part pri size= ____
DISKPART>assign letter=N
DISKPART>exit
system32>format N: /fs:ntfs /q /v:Recovery /y
system32>exit
  
```

Step 4: Build the recovery partition. Press any key to boot from the recovery CD. It will take a while to launch the recovery tool. Please be patient. When the recovery tool setup menu appears, type <3> and press <Enter> (**Figure B-31**). The Symantec Ghost window appears and starts configuring the system to build a

PIC0e-HM650 Half-size PCIe CPU Card

recovery partition. After completing the system configuration, press any key to reboot the system. Eject the recovery CD.

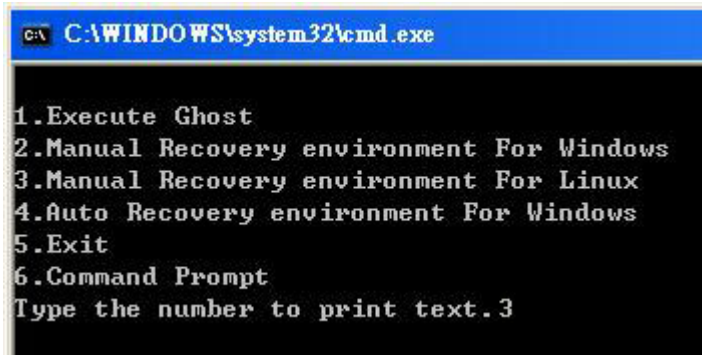

```
C:\WINDOWS\system32\cmd.exe

1.Execute Ghost
2.Manual Recovery environment For Windows
3.Manual Recovery environment For Linux
4.Auto Recovery environment For Windows
5.Exit
6.Command Prompt
Type the number to print text.3
```

Figure B-31: Manual Recovery Environment for Linux

Step 5: Access the recovery tool main menu by modifying the “menu.lst”. To first access the recovery tool main menu, the menu.lst must be modified. In Linux, enter Administrator (root). When prompt appears, type:

```
cd /boot/grub
```

```
vi menu.lst
```

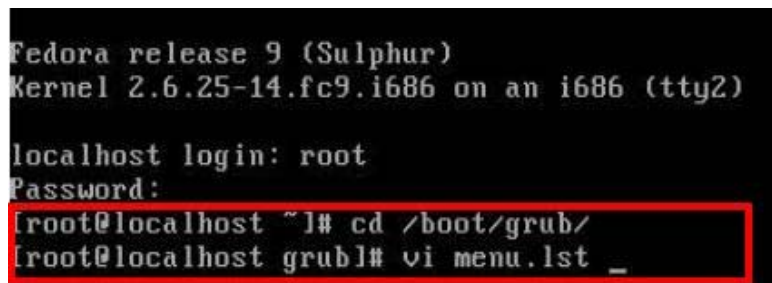

```
Fedora release 9 (Sulphur)
Kernel 2.6.25-14.fc9.i686 on an i686 (tty2)

localhost login: root
Password:
[root@localhost ~]# cd /boot/grub/
[root@localhost grub]# vi menu.lst _
```

Figure B-32: Access menu.lst in Linux (Text Mode)

Step 6: Modify the menu.lst as shown below.

```
#boot=/dev/sda
default=0
timeout=10 ← Modify timeout=10
splashimage=(hd0,0)/grub/splash.xpm.gz
hiddenmenu
title Fedora (2.6.25-14.fc9.i686)
    root (hd0,0)
    kernel /vmlinuz-2.6.25-14.fc9.i686 ro root=UUID=10f1acd
ac38b5c78910 rhgb quiet
    initrd /initrd-2.6.25-14.fc9.i686.img

title Recovery Partition
root (hd0,2)
makeactive ← Type command
chainloader +1
```

- **Type command:**
title Recovery Partition
root (hd0,2)
makeactive
chainloader +1

Step 7: The recovery tool menu appears. (Figure B-33)

```
1. Factory Restore
2. Backup system
3. Restore your last backup.
4. Manual
5. Quit
Please type the number to select and then press Enter:
```

Figure B-33: Recovery Tool Menu

Step 8: Create a factory default image. Follow **Step 2 ~ Step 12** described in **Section B.2.5** to create a factory default image.

B.5 Recovery Tool Functions

After completing the initial setup procedures as described above, users can access the recovery tool by pressing **<F3>** while booting up the system. However, if the setup procedure in Section B.3 has been completed and the auto recovery function is enabled, the system will automatically restore from the factory default image without pressing the F3 key. The recovery tool main menu is shown below.

PICOe-HM650 Half-size PCIe CPU Card

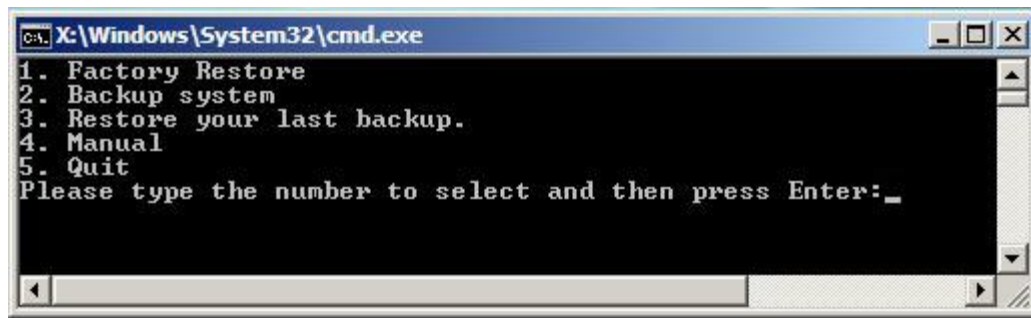

Figure B-34: Recovery Tool Main Menu

The recovery tool has several functions including:

1. **Factory Restore:** Restore the factory default image (iei.GHO) created in Section B.2.5.
2. **Backup system:** Create a system backup image (iei_user.GHO) which will be saved in the hidden partition.
3. **Restore your last backup:** Restore the last system backup image
4. **Manual:** Enter the Symantec Ghost window to configure manually.
5. **Quit:** Exit the recovery tool and restart the system.



WARNING:

Please do not turn off the system power during the process of system recovery or backup.



WARNING:

All data in the system will be deleted during the system recovery. Please backup the system files before restoring the system (either Factory Restore or Restore Backup).

B.5.1 Factory Restore

To restore the factory default image, please follow the steps below.

Step 1: Type <1> and press <Enter> in the main menu.

Step 2: The Symantec Ghost window appears and starts to restore the factory default. A factory default image called **iei.GHO** is created in the hidden Recovery partition.

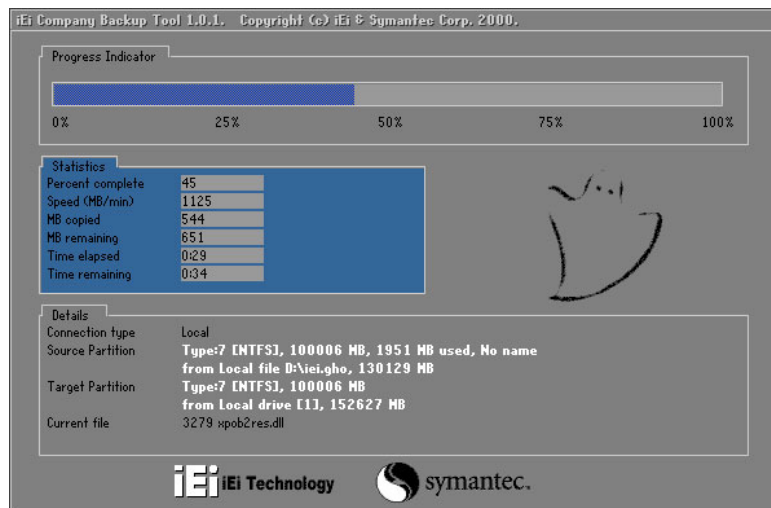

Figure B-35: Restore Factory Default

Step 3: The screen shown in **Figure B-36** appears when completed. Press any key to reboot the system.

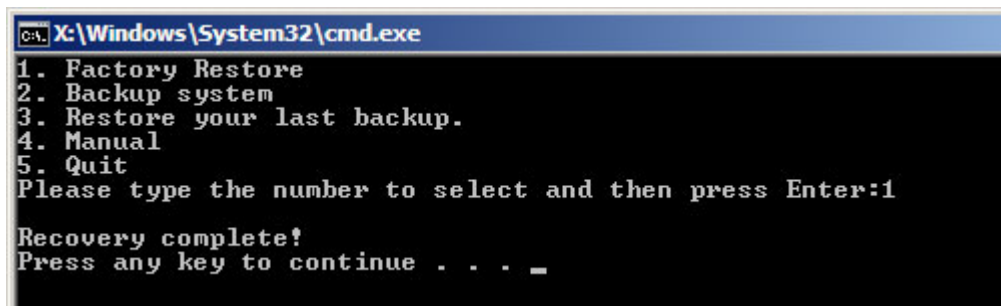

Figure B-36: Recovery Complete Window

PICOe-HM650 Half-size PCIe CPU Card

B.5.2 Backup System

To backup the system, please follow the steps below.

Step 1: Type <2> and press <Enter> in the main menu.

Step 2: The Symantec Ghost window appears and starts to backup the system. A backup image called `iei_user.GHO` is created in the hidden Recovery partition.

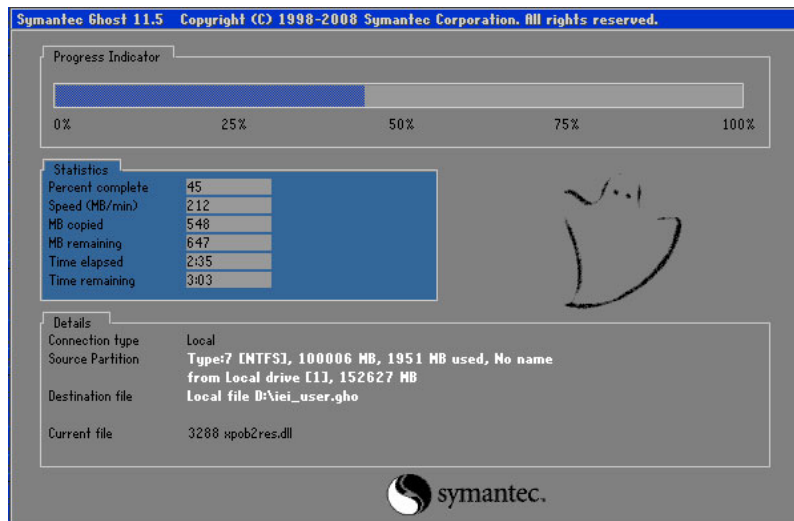

Figure B-37: Backup System

Step 3: The screen shown in **Figure B-38** appears when system backup is complete. Press any key to reboot the system.

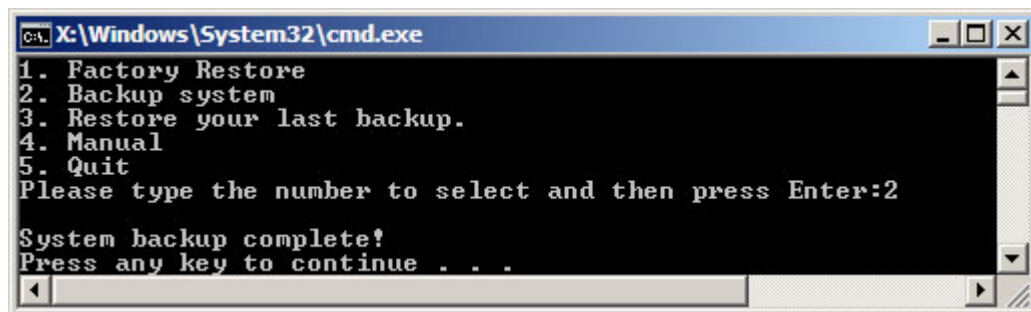

Figure B-38: System Backup Complete Window

B.5.3 Restore Your Last Backup

To restore the last system backup, please follow the steps below.

Step 1: Type <3> and press <Enter> in the main menu.

Step 2: The Symantec Ghost window appears and starts to restore the last backup image (iei_user.GHO).

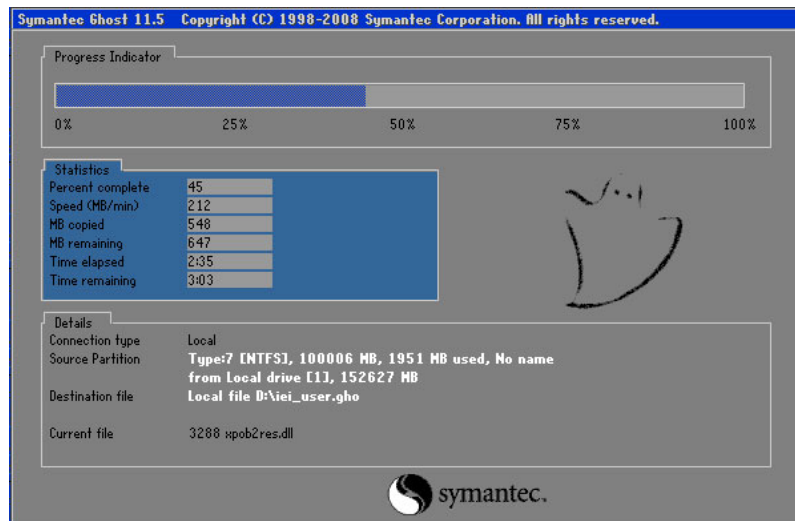

Figure B-39: Restore Backup

Step 3: The screen shown in **Figure B-40** appears when backup recovery is complete. Press any key to reboot the system.

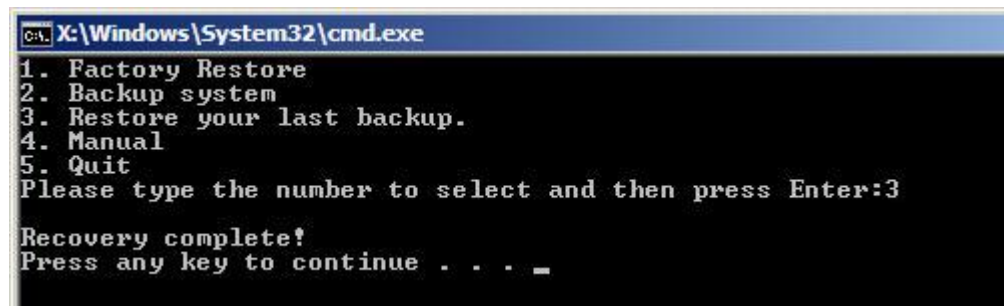

Figure B-40: Restore System Backup Complete Window

PIC0e-HM650 Half-size PCIe CPU Card

B.5.4 Manual

To restore the last system backup, please follow the steps below.

Step 1: Type <4> and press <Enter> in the main menu.

Step 2: The Symantec Ghost window appears. Use the Ghost program to backup or recover the system manually.

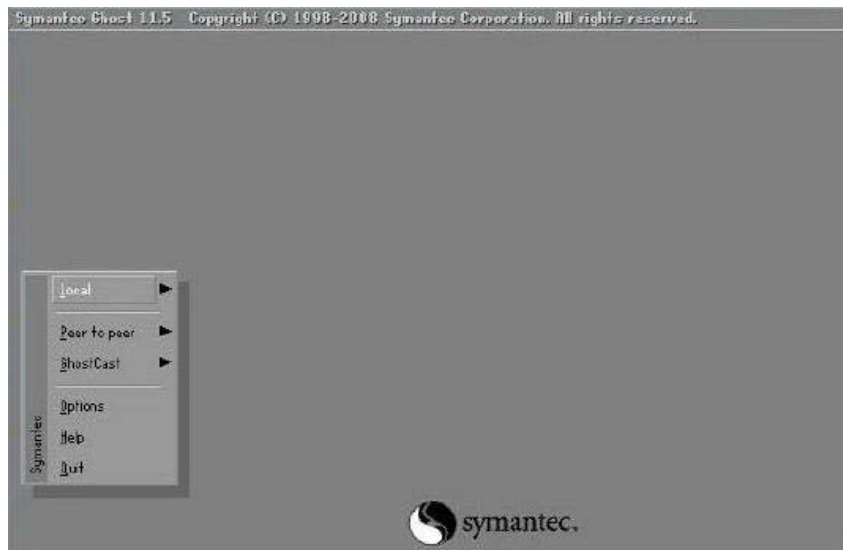
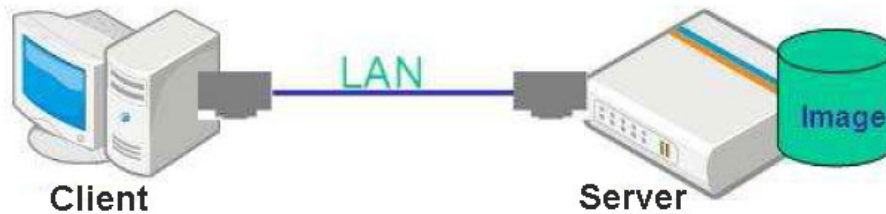

Figure B-41: Symantec Ghost Window

Step 3: When backup or recovery is completed, press any key to reboot the system.

B.6 Restore Systems from a Linux Server through LAN

The One Key Recovery allows a client system to automatically restore to a factory default image saved in a Linux system (the server) through LAN connectivity after encountering a Blue Screen of Death (BSoD) or a hang for around 10 minutes. To be able to use this function, the client system and the Linux system MUST reside in the same domain.



CAUTION:

The supported client OS includes:

- Windows 2000
- Windows XP
- Windows Vista
- Windows 7
- Windows XP Embedded
- Windows Embedded Standard 7

Prior to restoring client systems from a Linux server, a few setup procedures are required.

Step 1: Configure DHCP server settings

Step 2: Configure TFTP settings

Step 3: Configure One Key Recovery server settings

Step 4: Start DHCP, TFTP and HTTP

Step 5: Create a shared directory

Step 6: Setup a client system for auto recovery

The detailed descriptions are described in the following sections. In this document, two types of Linux OS are used as examples to explain the configuration process – CentOS 5.5 (Kernel 2.6.18) and Debian 5.0.7 (Kernel 2.6.26).

PICOe-HM650 Half-size PCIe CPU Card

B.6.1 Configure DHCP Server Settings

Step 1: Install the DHCP

`#yum install dhcp` (CentOS, commands marked in red)

`#apt-get install dhcp3-server` (Debian, commands marked in blue)

Step 2: Confirm the operating system default settings: dhcpd.conf.

CentOS

Use the following command to show the DHCP server sample location:

`#vi /etc/dhcpd.conf`

The DHCP server sample location is shown as below:

```
# DHCP Server Configuration file.
# see /usr/share/doc/dhcp*/dhcpd.conf.sample
```

Use the following command to copy the DHCP server sample to etc/dhcpd.conf:

`#cp /usr/share/doc/dhcp-3.0.5/dhcpd.conf.sample /etc/dhcpd.conf`

`#vi /etc/dhcpd.conf`

```
ddns-update-style interim;
ignore client-updates;

subnet 192.168.0.0 netmask 255.255.255.0 {
# --- default gateway
    option routers                192.168.0.2;
    option subnet-mask            255.255.255.0;

    option nis-domain             "domain.org";
    option domain-name            "domain.org";
    option domain-name-servers   192.168.0.1;
    next-server 192.168.0.6;
    filename "pxelinux.0";
    option time-offset            -18000; # Eastern Standard Time
    option ntp-servers            192.168.1.1;
}
```

Debian

`#vi /etc/dhcpd.conf`

Edit “/etc/dhcpd.conf” for your environment. For example, add

`next-server PXE server IP address;`

```
filename "pxelinux.0";
```

```
ddns-update-style interim;
ignore client-updates;

subnet 192.168.0.0 netmask 255.255.255.0 {
# --- default gateway
option routers 192.168.0.2;
option subnet-mask 255.255.255.0;

option nis-domain "domain.org";
option domain-name "domain.org";
option domain-name-servers 192.168.0.1;
next-server 192.168.0.6;
filename "pxelinux.0";
option time-offset -18000; # Eastern Standard Time
option ntp-servers 192.168.1.1;
}
```

B.6.2 Configure TFTP Settings

Step 1: Install the tftp, httpd and syslinux.

```
#yum install tftp-server httpd syslinux (CentOS)
```

```
#apt-get install tftpd-hpa xinetd syslinux (Debian)
```

Step 2: Enable the TFTP server by editing the "/etc/xinetd.d/tftp" file and make it use the remap file. The "-vvv" is optional but it could definitely help on getting more information while running the remap file. For example:

CentOS

```
#vi /etc/xinetd.d/tftp
```

Modify:

```
disable = no
```

```
server_args = -s /tftpboot -m /tftpboot/tftpd.remap -vvv_
```

```
socket_type      = dgram
protocol        = udp
wait            = yes
user            = root
server          = /usr/sbin/in.tftpd
server_args     = -s /tftpboot -m /tftpboot/tftpd.remap -vvv
disable         = no
per_source      = 11
cps             = 100 2
flags           = IPv4
```

PIC0e-HM650 Half-size PCIe CPU Card

Debian

Replace the TFTP settings from “inetd” to “xinetd” and annotate the “inetd” by adding “#”.

`#vi /etc/inetd.conf`

Modify: `#tftp dgram udp wait root /usr/sbin.....` (as shown below)

```
#:BOOT: TFTP service is provided primarily for booting. Most sites
# run this only on machines acting as "boot servers."
#tftp dgram udp wait root /usr/sbin/in.tftpd /usr/sbin/in.tftpd -s
/var/lib/tftpboot
```

`#vi /etc/xinetd.d/tftp`

```
socket_type      = dgram
protocol        = udp
wait            = yes
user            = root
server          = /usr/sbin/in.tftpd
server_args     = -s /tftpboot -n /tftpboot/tftpd.remap -vvv
disable         = no
per_source      = 11
cps             = 100 2
flags           = IPv4
```

B.6.3 Configure One Key Recovery Server Settings

Step 1: Copy the **Utility/RECOVERYR10.TAR.BZ2** package from the One Key Recovery CD to the system (server side).



Step 2: Extract the recovery package to /.

```
#cp RecoveryR10.tar.bz2 /
#cd /
#tar -xvjf RecoveryR10.tar.bz2
```

Step 3: Copy “pxelinux.0” from “syslinux” and install to “tftpboot”.

```
#cp /usr/lib/syslinux/pxelinux.0 /tftpboot/
```

B.6.4 Start the DHCP, TFTP and HTTP

Start the DHCP, TFTP and HTTP. For example:

CentOS

```
#service xinetd restart
```

```
#service httpd restart
```

```
#service dhcpd restart
```

Debian

```
#/etc/init.d/xinetd reload
```

```
#/etc/init.d/xinetd restart
```

```
#/etc/init.d/dhcp3-server restart
```

B.6.5 Create Shared Directory

Step 1: Install the samba.

```
#yum install samba
```

Step 2: Create a shared directory for the factory default image.

```
#mkdir /share
```

```
#cd /share
```

```
#mkdir /image
```

```
#cp iei.gho /image
```



WARNING:

The file name of the factory default image must be **iei.gho**.

Step 3: Confirm the operating system default settings: smb.conf.

```
#vi /etc/samba/smb.conf
```

PIC0e-HM650 Half-size PCIe CPU Card

Modify:

[image]

comment = One Key Recovery

path = /share/image

browseable = yes

writable = yes

public = yes

create mask = 0644

directory mask = 0755

Step 4: Edit “/etc/samba/smb.conf” for your environment. For example:

```
# "security = user" is always a good idea. This will require a Unix account
# in this server for every user accessing the server. See
# /usr/share/doc/samba-doc/html/docs/Samba3-HOWTO/ServerType.html
# in the samba-doc package for details.
security = share
```

```
[image]
comment = One Key Recovery
path = /share/image
browseable = yes
writable = yes
public = yes
create mask = 0644
directory mask = 0755
```

Step 5: Modify the hostname

```
#vi /etc/hostname
```

Modify: RecoveryServer

```
RecoveryServer
```

B.6.6 Setup a Client System for Auto Recovery

Step 1: Disable the automatically restart function before creating the factory default image. Go to: My Computer → Properties → Advanced. Click the Settings button of Startup and Recovery. Deselect “Automatically restart”. Click OK to save the settings and exit. (See Figure B-23)

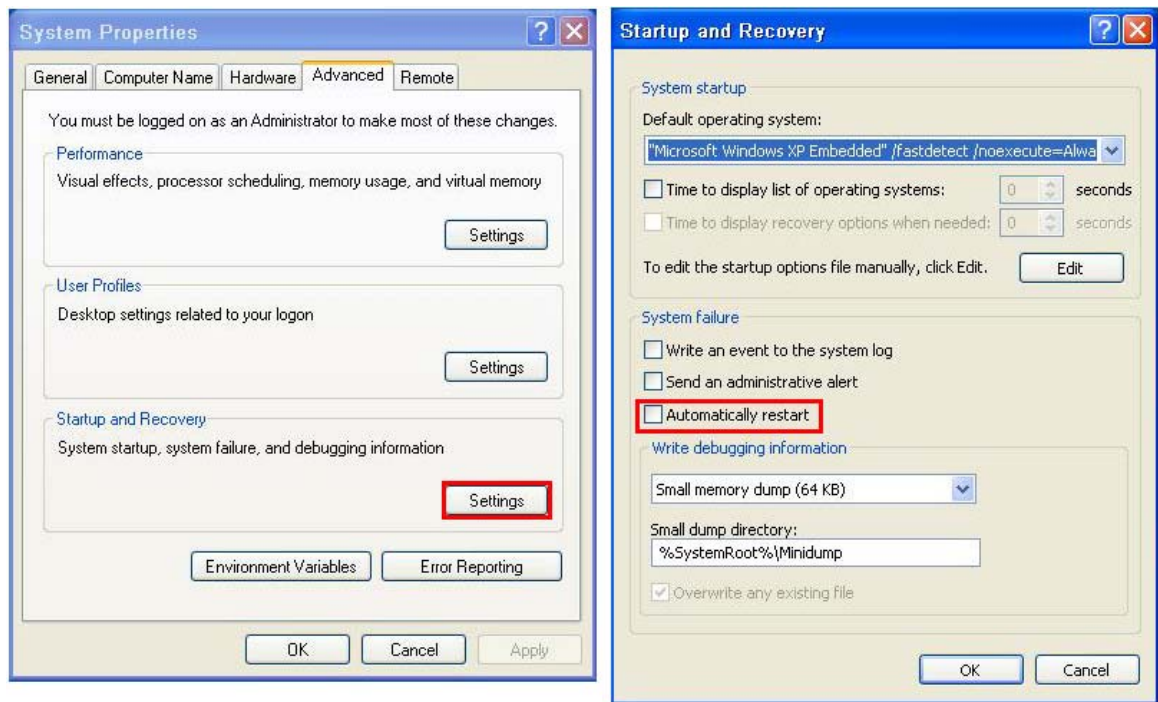

Figure B-42: Disable Automatically Restart

Step 2: Configure the following BIOS options of the client system.

Advanced → iEi Feature → Auto Recovery Function → **Enabled**

Advanced → iEi Feature → Recover from PXE → **Enabled**

Boot → Launch PXE OpROM → **Enabled**

Step 3: Continue to configure the **Boot Option Priorities** BIOS option of the client system:

Boot Option #1 → remain the default setting to boot from the original OS.

Boot Option #2 → select the boot from LAN option.

Step 4: Save changes and exit BIOS menu.

Exit → **Save Changes and Exit**

Step 5: Install the auto recovery utility into the system by double clicking the

Utility/AUTORECOVERY-SETUP.exe in the One Key Recovery CD. This utility

PIC0e-HM650 Half-size PCIe CPU Card

MUST be installed in the system, otherwise, the system will automatically restore from the factory default image every ten (10) minutes.



Step 6: Restart the client system from LAN. If the system encounters a Blue Screen of Death (BSoD) or a hang for around 10 minutes, it will automatically restore from the factory default image. The following screens will show when the system starts auto recovering.

```
Realtek PCIe GBE Family Controller Series v2.35 (06/14/10)
CLIENT MAC ADDR: 00 18 7D 13 E6 89  GUID: 00020003-0004-0005-0006-0007000000
DHCP.. /
```

```
My IP address seems to be C0A80009 192.168.0.9
ip=192.168.0.9:192.168.0.8:192.168.0.2:255.255.255.0
TFTP prefix:
Trying to load: pxelinux.cfg/00020003-0004-0005-0006-000700000009
Trying to load: pxelinux.cfg/01-00-18-7d-13-e6-89
Trying to load: pxelinux.cfg/C0A80009
Trying to load: pxelinux.cfg/C0A8000
Trying to load: pxelinux.cfg/C0A800
Trying to load: pxelinux.cfg/C0A80
Trying to load: pxelinux.cfg/C0A8
Trying to load: pxelinux.cfg/C0A
Trying to load: pxelinux.cfg/C0
Trying to load: pxelinux.cfg/C
Trying to load: pxelinux.cfg/default
boot:
```

```
Windows is loading files...
IP: 192.168.0.8, File: \Boot\WinPE.wim
```

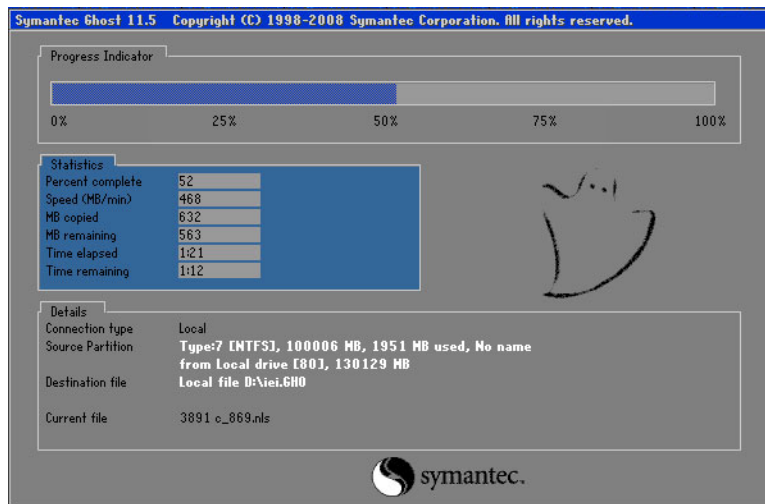
NOTE:

A firewall or a SELinux is not in use in the whole setup process described above. If there is a firewall or a SELinux protecting the system, modify the configuration information to accommodate them.

B.7 Other Information

B.7.1 Using AHCI Mode or ALi M5283 / VIA VT6421A Controller

When the system uses AHCI mode or some specific SATA controllers such as ALi M5283 or VIA VT6421A, the SATA RAID/AHCI driver must be installed before using one key recovery. Please follow the steps below to install the SATA RAID/AHCI driver.

- Step 1:** Copy the SATA RAID/AHCI driver to a floppy disk and insert the floppy disk into a USB floppy disk drive. The SATA RAID/AHCI driver must be especially designed for the on-board SATA controller.
- Step 2:** Connect the USB floppy disk drive to the system.
- Step 3:** Insert the One Key Recovery CD into the system and boot the system from the CD.
- Step 4:** When launching the recovery tool, press <F6>.

PIC0e-HM650 Half-size PCIe CPU Card

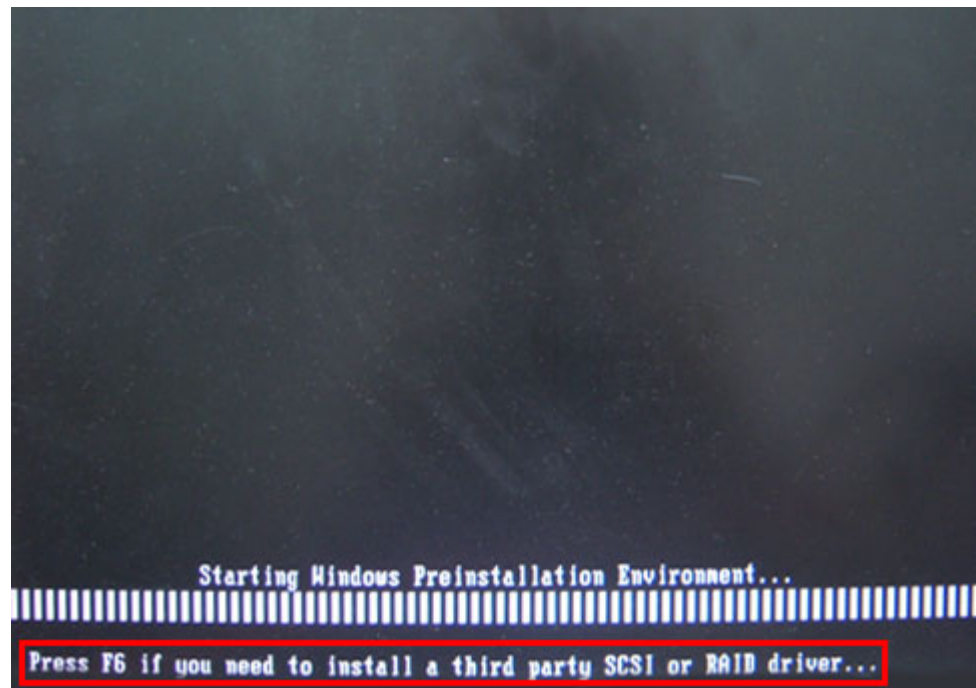

Step 5: When the following window appears, press <S> to select “Specify Additional Device”.

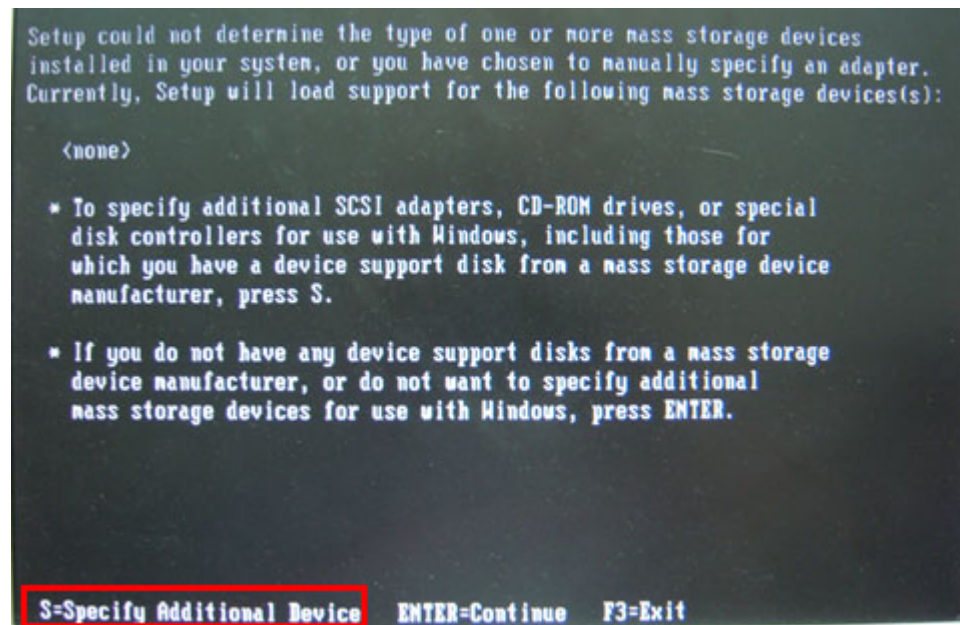

Step 6: In the following window, select a SATA controller mode used in the system. Then press <Enter>. The user can now start using the SATA HDD.

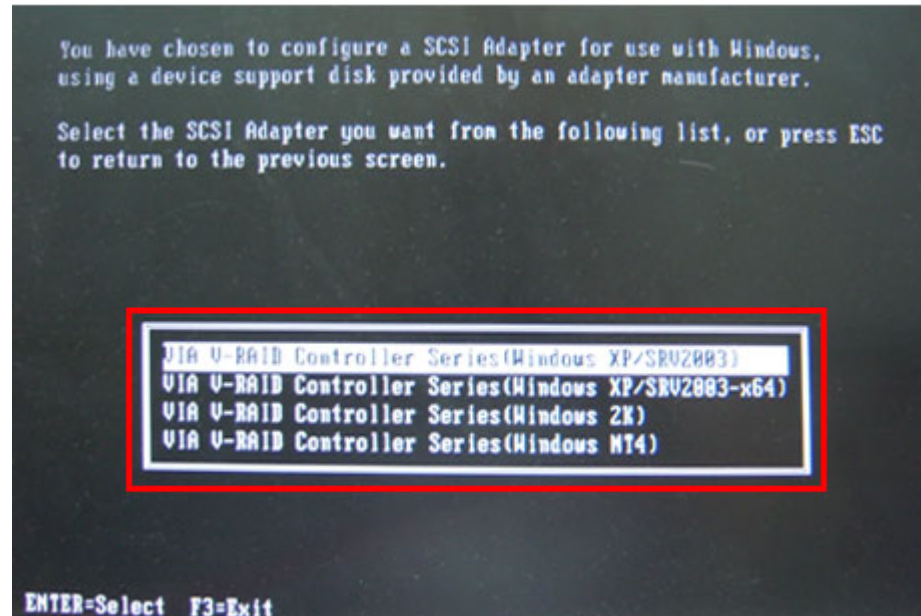

Step 7: After pressing <Enter>, the system will get into the recovery tool setup menu. Continue to follow the setup procedure from **Step 4** in **Section B.2.2 Create Partitions** to finish the whole setup process.

B.7.2 System Memory Requirement

To be able to access the recovery tool by pressing <F3> while booting up the system, please make sure to have enough system memory. The minimum memory requirement is listed below.

- **Using Award BIOS:** 128 MB system memory
- **Using AMI BIOS:** 512 MB system memory.

Appendix

C

Terminology

AC '97	Audio Codec 97 (AC'97) refers to a codec standard developed by Intel® in 1997.
ACPI	Advanced Configuration and Power Interface (ACPI) is an OS-directed configuration, power management, and thermal management interface.
AHCI	Advanced Host Controller Interface (AHCI) is a SATA Host controller register-level interface.
ATA	The Advanced Technology Attachment (ATA) interface connects storage devices including hard disks and CD-ROM drives to a computer.
ARMD	An ATAPI Removable Media Device (ARMD) is any ATAPI device that supports removable media, besides CD and DVD drives.
ASKIR	Amplitude Shift Keyed Infrared (ASKIR) is a form of modulation that represents a digital signal by varying the amplitude (“volume”) of the signal. A low amplitude signal represents a binary 0, while a high amplitude signal represents a binary 1.
BIOS	The Basic Input/Output System (BIOS) is firmware that is first run when the computer is turned on and can be configured by the end user
CODEC	The Compressor-Decompressor (CODEC) encodes and decodes digital audio data on the system.
CompactFlash®	CompactFlash® is a solid-state storage device. CompactFlash® devices use flash memory in a standard size enclosure. Type II is thicker than Type I, but a Type II slot can support both types.
CMOS	Complimentary metal-oxide-conductor is an integrated circuit used in chips like static RAM and microprocessors.
COM	COM refers to serial ports. Serial ports offer serial communication to expansion devices. The serial port on a personal computer is usually a male DB-9 connector.
DAC	The Digital-to-Analog Converter (DAC) converts digital signals to analog signals.
DDR	Double Data Rate refers to a data bus transferring data on both the rising and falling edges of the clock signal.

PIC0e-HM650 Half-size PCIe CPU Card

DMA	Direct Memory Access (DMA) enables some peripheral devices to bypass the system processor and communicate directly with the system memory.
DIMM	Dual Inline Memory Modules are a type of RAM that offer a 64-bit data bus and have separate electrical contacts on each side of the module.
DIO	The digital inputs and digital outputs are general control signals that control the on/off circuit of external devices or TTL devices. Data can be read or written to the selected address to enable the DIO functions.
EHCI	The Enhanced Host Controller Interface (EHCI) specification is a register-level interface description for USB 2.0 Host Controllers.
EIDE	Enhanced IDE (EIDE) is a newer IDE interface standard that has data transfer rates between 4.0 MBps and 16.6 MBps.
EIST	Enhanced Intel® SpeedStep Technology (EIST) allows users to modify the power consumption levels and processor performance through application software. The application software changes the bus-to-core frequency ratio and the processor core voltage.
FSB	The Front Side Bus (FSB) is the bi-directional communication channel between the processor and the Northbridge chipset.
GbE	Gigabit Ethernet (GbE) is an Ethernet version that transfers data at 1.0 Gbps and complies with the IEEE 802.3-2005 standard.
GPIO	General purpose input
HDD	Hard disk drive (HDD) is a type of magnetic, non-volatile computer storage device that stores digitally encoded data.
ICH	The Input/Output Control Hub (ICH) is an Intel® Southbridge chipset.
IrDA	Infrared Data Association (IrDA) specify infrared data transmission protocols used to enable electronic devices to wirelessly communicate with each other.
L1 Cache	The Level 1 Cache (L1 Cache) is a small memory cache built into the system processor.
L2 Cache	The Level 2 Cache (L2 Cache) is an external processor memory cache.

LCD	Liquid crystal display (LCD) is a flat, low-power display device that consists of two polarizing plates with a liquid crystal panel in between.
LVDS	Low-voltage differential signaling (LVDS) is a dual-wire, high-speed differential electrical signaling system commonly used to connect LCD displays to a computer.
POST	The Power-on Self Test (POST) is the pre-boot actions the system performs when the system is turned-on.
RAM	Random Access Memory (RAM) is volatile memory that loses data when power is lost. RAM has very fast data transfer rates compared to other storage like hard drives.
SATA	Serial ATA (SATA) is a serial communications bus designed for data transfers between storage devices and the computer chipsets. The SATA bus has transfer speeds up to 1.5 Gbps and the SATA II bus has data transfer speeds of up to 3.0 Gbps.
S.M.A.R.T	Self Monitoring Analysis and Reporting Technology (S.M.A.R.T) refers to automatic status checking technology implemented on hard disk drives.
UART	Universal Asynchronous Receiver-transmitter (UART) is responsible for asynchronous communications on the system and manages the system's serial communication (COM) ports.
UHCI	The Universal Host Controller Interface (UHCI) specification is a register-level interface description for USB 1.1 Host Controllers.
USB	The Universal Serial Bus (USB) is an external bus standard for interfacing devices. USB 1.1 supports 12Mbps data transfer rates and USB 2.0 supports 480Mbps data transfer rates.
VGA	The Video Graphics Array (VGA) is a graphics display system developed by IBM.

Appendix

D

Digital I/O Interface

D.1 Introduction

The DIO connector on the PIC0e-HM650 is interfaced to GPIO ports on the Super I/O chipset. The DIO has both 4-bit digital inputs and 4-bit digital outputs. The digital inputs and digital outputs are generally control signals that control the on/off circuit of external devices or TTL devices. Data can be read or written to the selected address to enable the DIO functions.



NOTE:

For further information, please refer to the datasheet for the Super I/O chipset.

D.2 DIO Connector Pinouts

The following table describes how the DIO connector pins are connected to the Super I/O GPIO port 1.

Pin	Description	Super I/O Pin	Super I/O Pin Description
1	Ground	N/A	N/A
2	VCC	N/A	N/A
3	Output 3	GP27	General purpose I/O port 2 bit 7.
4	Output 2	GP26	General purpose I/O port 2 bit 6.
5	Output 1	GP25	General purpose I/O port 2 bit 5.
6	Output 0	GP24	General purpose I/O port 2 bit 4.
7	Input 3	GP23	General purpose I/O port 2 bit 3.
8	Input 2	GP22	General purpose I/O port 2 bit 2
9	Input 1	GP21	General purpose I/O port 2 bit 1
10	Input 0	GP20	General purpose I/O port 2 bit 0

Table D-1: Digital I/O Connector Pinouts

D.3 Assembly Language Samples

D.3.1 Enable the DIO Input Function

The BIOS interrupt call INT 15H controls the digital I/O. An assembly program to enable digital I/O input functions is listed below.

MOV	AX, 6F08H	Sets the digital port as input
INT	15H	Initiates the INT 15H BIOS call

D.3.2 Enable the DIO Output Function

The BIOS interrupt call INT 15H controls the digital I/O. An assembly program to enable digital I/O output functions is listed below.

MOV	AX, 6F09H	Sets the digital port as output
MOV	BL, 09H	
INT	15H	Initiates the INT 15H BIOS call

Appendix

E

Watchdog Timer

PIC0e-HM650 Half-size PCIe CPU Card



NOTE:

The following discussion applies to DOS. Contact IEI support or visit the IEI website for drivers for other operating systems.

The Watchdog Timer is a hardware-based timer that attempts to restart the system when it stops working. The system may stop working because of external EMI or software bugs. The Watchdog Timer ensures that standalone systems like ATMs will automatically attempt to restart in the case of system problems.

A BIOS function call (INT 15H) is used to control the Watchdog Timer.

INT 15H:

AH – 6FH Sub-function:	
AL – 2:	Sets the Watchdog Timer's period.
BL:	Time-out value (Its unit-second is dependent on the item "Watchdog Timer unit select" in CMOS setup).

Table E-1: AH-6FH Sub-function

Call sub-function 2 to set the time-out period of Watchdog Timer first. If the time-out value is not zero, the Watchdog Timer starts counting down. When the timer value reaches zero, the system resets. To ensure that this reset condition does not occur, calling sub-function 2 must periodically refresh the Watchdog Timer. However, the watchdog timer is disabled if the time-out value is set to zero.

A tolerance of at least 10% must be maintained to avoid unknown routines within the operating system (DOS), such as disk I/O that can be very time-consuming.



NOTE:

The Watchdog Timer is activated through software. The software application that activates the Watchdog Timer must also deactivate it when closed. If the Watchdog Timer is not deactivated, the system will automatically restart after the Timer has finished its countdown.

EXAMPLE PROGRAM:

; INITIAL TIMER PERIOD COUNTER

;

W_LOOP:

;

```

MOV      AX, 6F02H      ;setting the time-out value
MOV      BL, 30         ;time-out value is 48 seconds
INT      15H

```

;

; ADD THE APPLICATION PROGRAM HERE

;

```

CMP      EXIT_AP, 1     ;is the application over?
JNE      W_LOOP        ;No, restart the application

MOV      AX, 6F02H      ;disable Watchdog Timer
MOV      BL, 0         ;
INT      15H

```

;

; EXIT ;

Appendix

F

Hazardous Materials Disclosure

F.1 Hazardous Materials Disclosure Table for IPB Products Certified as RoHS Compliant Under 2002/95/EC Without Mercury

The details provided in this appendix are to ensure that the product is compliant with the Peoples Republic of China (China) RoHS standards. The table below acknowledges the presences of small quantities of certain materials in the product, and is applicable to China RoHS only.

A label will be placed on each product to indicate the estimated “Environmentally Friendly Use Period” (EFUP). This is an estimate of the number of years that these substances would “not leak out or undergo abrupt change.” This product may contain replaceable sub-assemblies/components which have a shorter EFUP such as batteries and lamps. These components will be separately marked.

Please refer to the table on the next page.

PICOe-HM650 Half-size PCIe CPU Card

Part Name	Toxic or Hazardous Substances and Elements					
	Lead (Pb)	Mercury (Hg)	Cadmium (Cd)	Hexavalent Chromium (CR(VI))	Polybrominated Biphenyls (PBB)	Polybrominated Diphenyl Ethers (PBDE)
Housing	X	O	O	O	O	X
Display	X	O	O	O	O	X
Printed Circuit Board	X	O	O	O	O	X
Metal Fasteners	X	O	O	O	O	O
Cable Assembly	X	O	O	O	O	X
Fan Assembly	X	O	O	O	O	X
Power Supply Assemblies	X	O	O	O	O	X
Battery	O	O	O	O	O	O

O: This toxic or hazardous substance is contained in all of the homogeneous materials for the part is below the limit requirement in SJ/T11363-2006

X: This toxic or hazardous substance is contained in at least one of the homogeneous materials for this part is above the limit requirement in SJ/T11363-2006

此附件旨在确保本产品符合中国 RoHS 标准。以下表格标示此产品中某有毒物质的含量符合中国 RoHS 标准规定的限量要求。

本产品上会附有“环境友好使用期限”的标签，此期限是估算这些物质“不会有泄漏或突变”的年限。本产品可能包含有较短的环境友好使用期限的可替换元件，像是电池或灯管，这些元件将会单独标示出来。

部件名称	有毒有害物质或元素					
	铅 (Pb)	汞 (Hg)	镉 (Cd)	六价铬 (CR(VI))	多溴联苯 (PBB)	多溴二苯 醚 (PBDE)
壳体	X	O	O	O	O	X
显示	X	O	O	O	O	X
印刷电路板	X	O	O	O	O	X
金属螺帽	X	O	O	O	O	O
电缆组装	X	O	O	O	O	X
风扇组装	X	O	O	O	O	X
电力供应组装	X	O	O	O	O	X
电池	O	O	O	O	O	O

O: 表示该有毒有害物质在该部件所有物质材料中的含量均在 SJ/T11363-2006 标准规定的限量要求以下。
X: 表示该有毒有害物质至少在该部件的某一均质材料中的含量超出 SJ/T11363-2006 标准规定的限量要求。