



MODEL:  
**POCi-W22C-ULT5**

**Medical Panel PC with 8<sup>th</sup> Gen. Intel® Core™ i5/i7 CPU,  
Up to 64 GB DDR4 RAM, P-CAP Touchscreen, HDIM Output, M.2,  
Isolated COM, Wi-Fi 802.11ax, Dual Isolated GbE, Audio and RoHS**

# User Manual

# Revision

---

Date	Version	Changes
February 3, 2021	1.00	Initial release

# Copyright

## COPYRIGHT NOTICE

The information in this document is subject to change without prior notice in order to improve reliability, design and function and does not represent a commitment on the part of the manufacturer.

In no event will the manufacturer be liable for direct, indirect, special, incidental, or consequential damages arising out of the use or inability to use the product or documentation, even if advised of the possibility of such damages.

This document contains proprietary information protected by copyright. All rights are reserved. No part of this manual may be reproduced by any mechanical, electronic, or other means in any form without prior written permission of the manufacturer.

## TRADEMARKS

All registered trademarks and product names mentioned herein are used for identification purposes only and may be trademarks and/or registered trademarks of their respective owners.

## CONTACT INFORMATION



**Manufactured by:**  
**IEI Integration Corp.**

**Address:** No. 29, Zongxing Rd., Xizhi Dist.,  
New Taipei City 221, Taiwan

**Phone:** +886-2-8691-6798

**Fax:** +886-2-6616-0028

**Web Site:** [www.ieiworld.com](http://www.ieiworld.com)

**Sales Email:** [sales@ieiworld.com.tw](mailto:sales@ieiworld.com.tw)

# Manual Conventions

---



## **WARNING**

Warnings appear where overlooked details may cause damage to the equipment or result in personal injury. Warnings should be taken seriously.



## **CAUTION**

Cautionary messages should be heeded to help reduce the chance of losing data or damaging the product.



## **NOTE**

These messages inform the reader of essential but non-critical information. These messages should be read carefully as any directions or instructions contained therein can help avoid making mistakes.

# Table of Contents

<b>1 INTRODUCTION.....</b>	<b>1</b>
1.1 OVERVIEW.....	2
1.2 MODEL VARIATIONS .....	3
1.3 FEATURES.....	3
1.4 FRONT PANEL.....	4
1.4.1 Backlit Touch Buttons .....	5
1.5 BOTTOM PANEL.....	6
1.6 SIDE PANELS .....	7
1.7 REAR PANEL.....	7
1.8 SYSTEM SPECIFICATIONS.....	8
1.9 BATTERY SPECIFICATIONS (B SKU ONLY).....	11
1.10 DIMENSIONS.....	12
<b>2 UNPACKING .....</b>	<b>13</b>
2.1 UNPACKING.....	14
2.2 PACKING LIST.....	15
2.3 OPTIONAL ATO ITEMS.....	16
<b>3 INSTALLATION .....</b>	<b>17</b>
3.1 SAFETY PRECAUTIONS .....	18
3.2 ANTI-STATIC PRECAUTIONS .....	19
3.3 INSTALLATION PRECAUTIONS .....	20
3.4 INSTALLATION AND CONFIGURATION STEPS .....	20
3.5 HDD INSTALLATION.....	21
3.6 M.2 M-KEY MODULE INSTALLATION.....	23
3.7 RS-232 SERIAL PORT CONNECTION .....	25
3.8 VESA MOUNTING.....	26
3.9 POWERING ON THE SYSTEM.....	27
<b>4 BIOS SETUP .....</b>	<b>29</b>
4.1 INTRODUCTION.....	30

4.1.1 Starting Setup.....	30
4.1.2 Using Setup .....	30
4.1.3 Getting Help.....	31
4.1.4 BIOS Menu Bar.....	31
4.2 MAIN.....	32
4.3 ADVANCED.....	33
4.3.1 CPU Configuration.....	34
4.3.2 PCH-FW Configuration.....	36
4.3.2.1 PTT Configuration .....	37
4.3.3 Trusted Computing.....	38
4.3.4 ACPI Settings.....	39
4.3.5 RTC Wake Settings.....	40
4.3.6 iWDD H/W Monitor.....	41
4.3.7 F81803 Super IO Configuration .....	42
4.3.7.1 Serial Port 1 Configuration .....	42
4.3.8 Serial Port Console Redirection .....	43
4.3.8.1 Console Redirection Settings.....	44
4.3.8.2 Legacy Console Redirection Settings .....	46
4.3.9 USB Configuration.....	47
4.3.10 CSM Configuration.....	48
4.3.11 NVMe Configuration.....	49
4.4 CHIPSET .....	49
4.4.1 System Agent (SA) Configuration .....	50
4.4.1.1 Memory Configuration .....	51
4.4.1.2 Graphics Configuration.....	52
4.4.2 PCH-IO Configuration .....	53
4.4.2.1 PCI Express Configuration .....	55
4.4.2.2 SATA And RST Configuration.....	56
4.5 SECURITY.....	58
4.6 BOOT.....	59
4.7 SAVE & EXIT .....	61
<b>5 DRIVER INSTALLATION.....</b>	<b>63</b>
5.1 AVAILABLE DRIVERS .....	64
5.2 DRIVER DOWNLOAD .....	64

## POCi-W22C-ULT5 Medical Panel PC

<b>A REGULATORY COMPLIANCE .....</b>	<b>66</b>
<b>B PRODUCT DISPOSAL .....</b>	<b>71</b>
<b>C MAINTENANCE AND CLEANING PRECAUTIONS.....</b>	<b>73</b>
<i>C.1.1 Maintenance and Cleaning .....</i>	<i>75</i>
<i>C.1.2 Cleaning Tools.....</i>	<i>75</i>
<b>D SYMBOL DEFINITIONS .....</b>	<b>76</b>
<b>E BIOS MENU OPTIONS .....</b>	<b>78</b>
<b>F WATCHDOG TIMER.....</b>	<b>81</b>
<b>G HAZARDOUS MATERIALS DISCLOSURE.....</b>	<b>84</b>
G.1 RoHS II DIRECTIVE (2015/863/EU) .....	85
G.2 CHINA RoHS.....	86

# List of Figures

---

Figure 1-1: POCi-W22C-ULT5 Medical Panel PC .....	2
Figure 1-2: Front View .....	4
Figure 1-3: Backlit Touch Buttons .....	5
Figure 1-4: Bottom Panel .....	6
Figure 1-5: Bottom Panel – BP SKU .....	6
Figure 1-6: Side View .....	7
Figure 1-7: Rear View .....	7
Figure 1-8: POCi-W22C-ULT5 Dimensions (mm).....	12
Figure 3-1: HDD Cover Retention Screws .....	21
Figure 3-2: HDD Bracket Retention Screws .....	21
Figure 3-3: Secure HDD .....	22
Figure 3-4: HDD Installation .....	22
Figure 3-5: Bracket Retention Screws.....	23
Figure 3-6: M.2 Slot Location .....	23
Figure 3-7: Inserting the M.2 Module into the Slot at an Angle .....	24
Figure 3-8: Securing the M.2 Module.....	24
Figure 3-9: VESA Mounting Retention Screw Holes .....	26
Figure 3-10: Power Input Connector.....	27
Figure 3-11: Power Input Connector.....	28
Figure 5-1: IEI Resource Download Center .....	64



# List of Tables

---

<b>Table 1-1: Model Variations .....</b>	<b>3</b>
<b>Table 1-2: System Specifications.....</b>	<b>10</b>
<b>Table 3-1: RS-232 Serial Port Pinouts .....</b>	<b>25</b>
<b>Table 4-1: BIOS Navigation Keys .....</b>	<b>31</b>

# List of BIOS Menus

---

BIOS Menu 1: Main .....	32
BIOS Menu 2: Advanced .....	33
BIOS Menu 3: CPU Configuration .....	34
BIOS Menu 4: PCH-FW Configuration .....	36
BIOS Menu 5: PTT Configuration .....	37
BIOS Menu 6: Trusted Computing .....	38
BIOS Menu 7: ACPI Settings .....	39
BIOS Menu 8: RTC Wake Settings .....	40
BIOS Menu 9: iWDD H/W Monitor .....	41
BIOS Menu 10: F81803 Super IO Configuration .....	42
BIOS Menu 11: Serial Port n Configuration Menu .....	42
BIOS Menu 12: Serial Port Console Redirection .....	43
BIOS Menu 13: Console Redirection Settings .....	44
BIOS Menu 14: Legacy Console Redirection Settings .....	46
BIOS Menu 15: USB Configuration .....	47
BIOS Menu 16: CSM Configuration .....	48
BIOS Menu 17: NVMe Configuration .....	49
BIOS Menu 18: Chipset .....	49
BIOS Menu 19: System Agent (SA) Configuration .....	50
BIOS Menu 20: Memory Configuration .....	51
BIOS Menu 21: Graphics Configuration .....	52
BIOS Menu 22: PCH-IO Configuration .....	53
BIOS Menu 23: PCI Express Configuration .....	55
BIOS Menu 24: SATA and RST Configuration .....	56
BIOS Menu 25: Security .....	58
BIOS Menu 26: Boot .....	59
BIOS Menu 27: Save & Exit .....	61

**Chapter**

**1**

# **Introduction**

---

## 1.1 Overview



**Figure 1-1: POCi-W22C-ULT5 Medical Panel PC**

The POCi-W22C-ULT5 is an 8<sup>th</sup> generation Intel® Core™ i7-8665UE / Core™ i5-8365UE processor powered medical-grade panel PC with a rich variety of functions and peripherals. All POCi-W22C-ULT5 models are designed for easy and simplified integration into point-of-care (POC) applications. The system comes with 4 GB of preinstalled DDR4 memory and supports a maximum of 64 GB ensuring smooth data throughputs with reduced bottlenecks and fast system access.

One RS-232 serial port, four USB 3.2 Gen 2 ports and two USB 2.0 ports provide simplified connectivity to a variety of external peripheral devices. Wi-Fi 802.11ax high efficiency wireless and two RJ-45 GbE connectors allow for smooth connection of the system to an external LAN.



**NOTE:**

The POCi-W22C-ULT5 medical panel PC is intended to be used to display general purpose medical images. The device shall not be used for diagnosis purpose or life supporting system.

## POCi-W22C-ULT5 Medical Panel PC

### 1.2 Model Variations

There are six models in the POCi-W22C-ULT5 series. All models are preinstalled with one 4 GB DDR4 memory module and an 802.11ax Wi-Fi module. The model numbers and model variations are listed below.

POCi-W22C-ULT5	CPU	Battery	Built-in Power
-i5/PC/4G	Intel® Core™ i5-8365UE	No	No
-i5/PC/4G-B	Intel® Core™ i5-8365UE	Yes	No
-i5/PC/4G-BP	Intel® Core™ i5-8365UE	No	Yes
-i7/PC/4G	Intel® Core™ i7-8665UE	No	No
-i7/PC/4G-B	Intel® Core™ i7-8665UE	Yes	No
-i7/PC/4G-BP	Intel® Core™ i7-8665UE	No	Yes

**Table 1-1: Model Variations**

### 1.3 Features

The POCi-W22C-ULT5 features are listed below:

- Fanless medical-grade panel PC with anti-bacteria rear cover
- FHD IPS panel with chemical etching AG coating and optional DICOM preset module
- Projected capacitive type touchscreen allows 10-point multi-touch
- Intel® Core™ i7-8665UE / Core™ i5-8365UE processor
- Preinstalled with 4 GB of DDR4 memory (system max. 64 GB)
- Dual reading light
- One HDMI 1.4 port supports an additional display
- Two isolated GbE RJ-45 connectors
- Wi-Fi 802.11ax high efficiency wireless
- Two internal 3 W speakers
- Four USB 3.2 Gen 2 ports and two USB 2.0 ports
- One isolated 1.5kV RS-232 DB-9 connector
- IP 66 compliant front panel

### 1.4 Front Panel

The front side of the POCi-W22C-ULT5 is a flat-bezel panel with a TFT LCD screen surrounded by an aluminum frame (**Figure 1-2**).

The bottom surface contains several backlit touch buttons, a power indicator and an optional RFID reader.

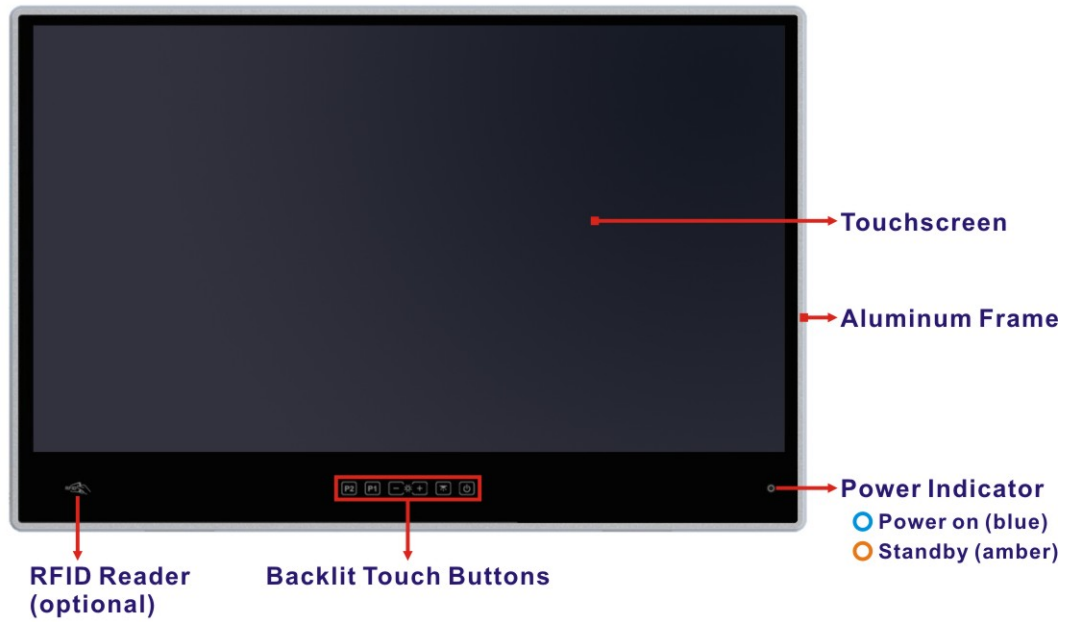

**Figure 1-2: Front View**

## POCi-W22C-ULT5 Medical Panel PC





### 1.4.1 Backlit Touch Buttons

The front panel of the POCi-W22C-ULT5 contains several backlit touch buttons that control reading light, LCD brightness and some other system components.



**Figure 1-3: Backlit Touch Buttons**

The following table describes the function of each button.

Button	Function
	Power on/off: Long-press for 2 seconds to power on the system. Long-press the power button for 10 seconds to force shutdown the panel PC.
	Reading light on/off
	– : Brightness down (minimum brightness: 5%) + : Brightness up (maximum brightness: 100%)
	LCD & touch lock on/off: Long-press to turn on/off the LCD and the touch function. The touch buttons blink when the LCD is off and the touch function is locked.
	Programmable button or DICOM mode button (activated only when the optional DICOM module is installed; press to launch/close the DICOM Management app)

**Note:** Press the touch button for at least one second to activate it.

## 1.5 Bottom Panel

The bottom panel of the POCi-W22C-ULT5 has the following connectors and components (Figure 1-4):

- 1 x DC input jack (standard) / Power inlet (BP SKU)
- 1 x HDMI output connector
- 2 x Isolated GbE RJ-45 connector
- 1 x Isolated 1.5kV RS-232 DB-9 serial port
- 4 x USB 3.2 Gen 2 connector
- 1 x Audio-out and mic-in combo connector
- 2 x 3 W speaker
- 2 x LED reading light

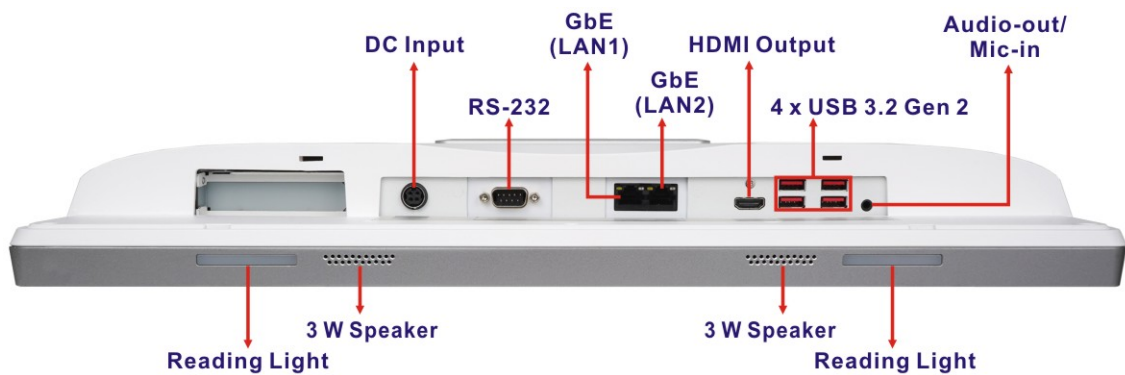

**Figure 1-4: Bottom Panel**

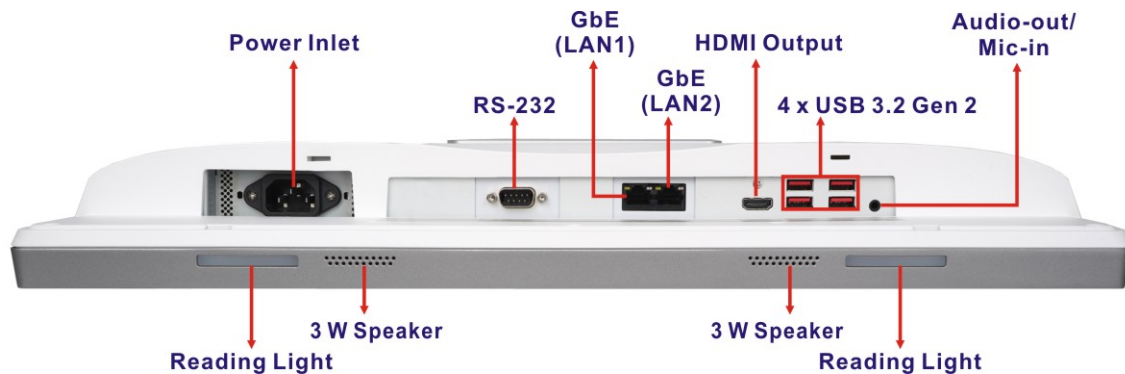

**Figure 1-5: Bottom Panel – BP SKU**



## POCi-W22C-ULT5 Medical Panel PC

### 1.6 Side Panels

The right side panel has two USB 2.0 ports protected by a cover, and a power button.



Figure 1-6: Side View

### 1.7 Rear Panel

The rear panel contains the retention screw holes that support VESA 75/100 mounting (Figure 1-7). HDD/SSD and M.2 modules can also be installed by removing the HDD cover located on the rear panel.

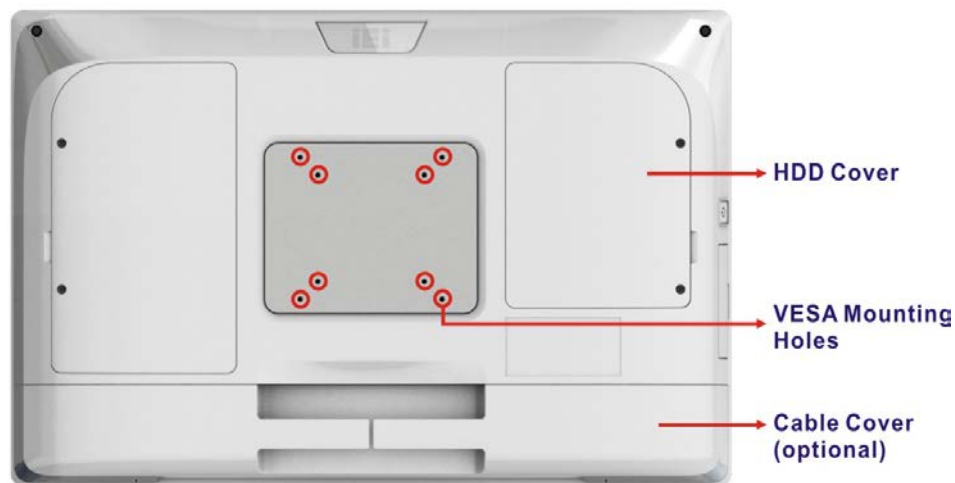

Figure 1-7: Rear View

## 1.8 System Specifications

The technical specifications for the POCi-W22C-ULT5 systems are listed below.

<b>LCD and Touchscreen</b>	
<b>LCD Size</b>	21.5" (16:9)
<b>Max. Resolution</b>	1920 (W) x 1080 (H)
<b>Brightness (cd/m<sup>2</sup>)</b>	250
<b>Contrast Ratio</b>	1000:1
<b>LCD Color</b>	16.7M RGB 6-bit (Hi-FRC)
<b>Pixel Pitch (mm)</b>	247.95 (H) x 247.95 (V)
<b>Viewing Angle (H-V)</b>	178°/178°
<b>Backlight MTBF</b>	30,000 hrs (LED backlight)
<b>Touchscreen</b>	Projected capacitive type with USB interface
<b>Multi-touch</b>	10-point touch
<b>Touch Controller</b>	EETI (80H84)
<b>Surface Hardness</b>	6H
<b>Coating</b>	Chemical etching AG
<b>System</b>	
<b>CPU</b>	Intel® Core™ i7-8665UE (code-named Whiskey Lake) Intel® Core™ i5-8365UE (code-named Whiskey Lake)
<b>Memory</b>	Preinstalled with 4 GB DDR4 SO-DIMM (system max. 64 GB)
<b>GbE Controller</b>	LAN1: Intel® I219 Ethernet controller (AMT 12.x supported by i7/i5 SKUs) LAN2: Intel® I211 Ethernet controller
<b>Wi-Fi and Bluetooth</b>	802.11ax 2T2R (Wi-Fi 6) + Bluetooth v5.0 (via M.2 2230 module)
<b>I/O Ports</b>	1 x DC input jack (not included in the BP model) 1 x HDMI 1.4 output 2 x Isolated GbE LAN (RJ-45)

## POCi-W22C-ULT5 Medical Panel PC

	<ul style="list-style-type: none"> <li>1 x Isolated 1.5kV RS-232 (DB-9)</li> <li>4 x USB 3.2 Gen 2 (10Gb/s)</li> <li>2 x USB 2.0 (side panel)</li> <li>1 x Audio out / Mic-in combo</li> </ul>
<b>Storage</b>	<ul style="list-style-type: none"> <li>1 x Accessible 2.5" SATA 6Gb/s HDD/SSD bay</li> <li>1 x M.2 2242/2260/2280 M-key slot (PCIe x4)</li> </ul>
<b>Audio</b>	2 x 3 W speakers
<b>Expansion Interface</b>	1 x PCIe x4 slot
<b>TPM</b>	TPM 2.0 (optional)
<b>RFID</b>	Mifare RFID reader, 13.56MHz (optional)
<b>Other Features</b>	
<b>Function Keys</b>	<ul style="list-style-type: none"> <li>1 x Power on/off</li> <li>1 x Reading light on/off</li> <li>1 x Brightness up</li> <li>1 x Brightness down</li> <li>1 x LCD &amp; touch lock on/off</li> <li>1 x Programmable button / DICOM mode button (optional)</li> </ul>
<b>LED</b>	<ul style="list-style-type: none"> <li>1 x Power indicator</li> <li>2 x LED reading light</li> <li>1 x RFID indicator (optional)</li> </ul>
<b>Cooling Method</b>	Fanless
<b>Physical</b>	
<b>Construction Material</b>	<ul style="list-style-type: none"> <li>Front bezel: Aluminum die-casting</li> <li>Rear cover: ABS+PC plastic with anti-bacterial material</li> </ul>
<b>Mounting</b>	<ul style="list-style-type: none"> <li>Wall, stand and arm</li> <li>VESA 75 mm x 75 mm or 100 mm x 100 mm</li> </ul>
<b>Dimensions (W x H x D)</b>	507 x 335.5 x 64.5 (mm)
<b>Net Weight</b>	6.9 kg

<b>Environment</b>		
<b>Storage/Transportation</b>	<b>Temperature</b>	-20°C ~ 60°C
	<b>Humidity</b>	10% ~ 95% (non-condensing)
	<b>Pressure</b>	700 hPa ~ 1060 hPa
<b>Operating</b>	<b>Temperature</b>	0°C ~ 40°C
	<b>Humidity</b>	10% ~ 95% (non-condensing)
	<b>Pressure</b>	700 hPa ~ 1060 hPa
<b>Vibration</b>	1G	
<b>Shock</b>	Operating Shock: 5G peak acceleration (11ms duration) Non-Operating Shock: 15G peak acceleration (11ms duration)	
<b>IP Level</b>	IP 66 compliant front panel	
<b>EMC &amp; Safety</b>	CE, FCC Class B Part18 EN 60601-1:2006/A1:2013 (Edition 3.1) EN 60601-1-2: 2015 (Edition 4.0)	
<b>Power</b>		
<b>Power Input</b>	19 V DC	
<b>Power Adapter</b>	150 W FSP FSP150M-ABA medical-grade power adapter (P/N: 63040-010150-400-RS)	
	<b>Input:</b> 100 V AC ~ 240 V AC, 50 Hz ~ 60 Hz, 2 A ~ 0.85 A	
	<b>Output:</b> 19 V  7.89 A	
<b>Battery</b>	3S3P Li-ion battery pack, 11.1V, 7800mAh (optional)	
<b>Built-in Medical Power</b>	150W, 85 ~264VAC, medical power supply (optional)	

**Table 1-2: System Specifications**

## 1.9 Battery Specifications (B SKU only)

---



### WARNING / AVERTISSEMENT

- Danger of explosion if battery is incorrectly replaced. Replace only with the same or equivalent type recommended by the manufacturer.  
Risque d'explosion si la batterie n'est pas remplacée correctement.  
Remplacez uniquement par le même type ou un type équivalent recommandé par le fabricant.
  - Disposal of a battery into fire or a hot oven, or mechanically crushing or cutting of a battery, that can result in an explosion.  
Mise au rebut d'une batterie au feu ou dans un four chaud, ou écrasement ou coupure mécanique d'une batterie, pouvant entraîner une explosion.
  - Leaving a battery in an extremely high temperature surrounding environment that can result in an explosion or the leakage of flammable liquid or gas.  
Laisser une batterie dans un environnement environnant à température extrêmement élevée qui peut entraîner une explosion ou une fuite de liquide ou de gaz inflammable.
  - A battery subjected to extremely low air pressure that may result in an explosion or the leakage of flammable liquid or gas.  
Une batterie soumise à une pression d'air extrêmement basse pouvant entraîner une explosion ou une fuite de liquide ou de gaz inflammable.
- 

Some SKUs of the POCi-W22C-ULT5 series are preinstalled with a Li-ion battery. The followings are some of the specifications of the optional Li-ion battery pack.

- Capacity: 7800 mAh
- Normal voltage: 11.1V
- Charge voltage: 12.6 V
- Continuous charge current: 2.6 A
- Continuous discharge current: 5 A
- Storage temperature: 0°C ~ 40°C

### 1.10 Dimensions

The POCi-W22C-ULT5 dimensions are shown below.

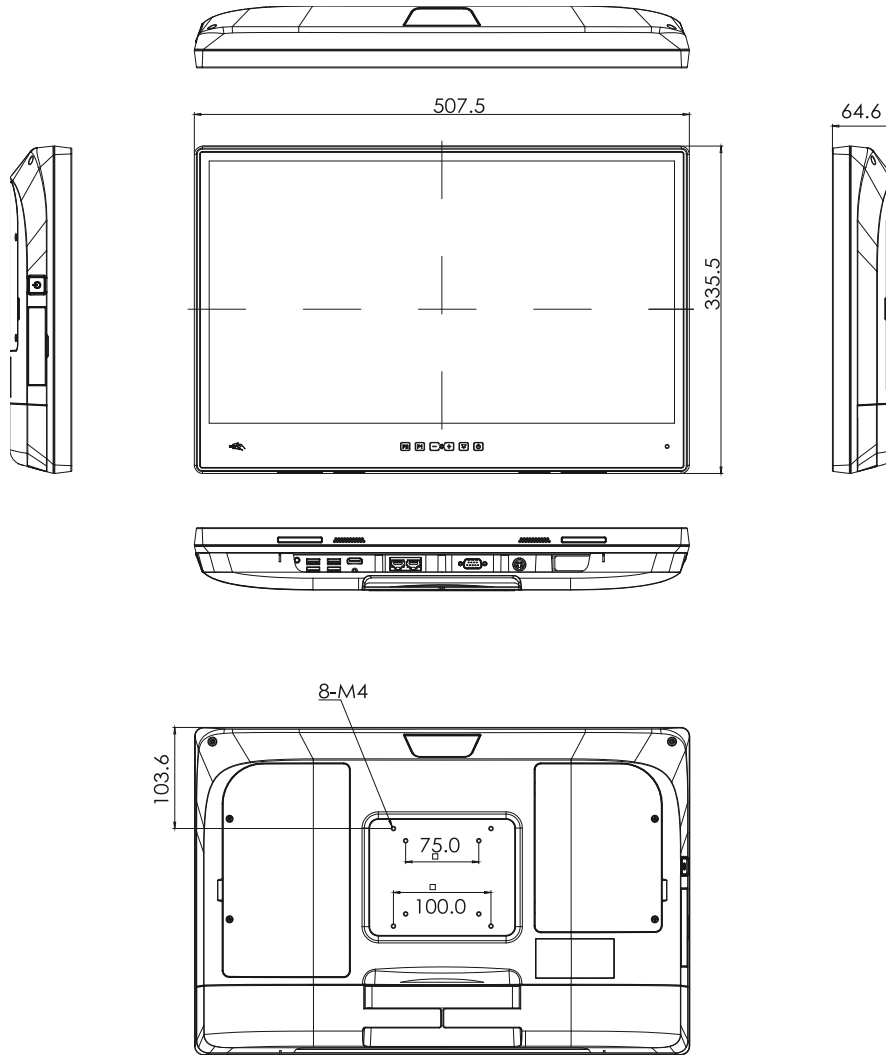

**Figure 1-8: POCi-W22C-ULT5 Dimensions (mm)**

Chapter

2

# Unpacking

---

## 2.1 Unpacking

To unpack the medical panel PC, follow the steps below:



### **WARNING / AVERTISSEMENT**

The front side LCD screen has a protective plastic cover stuck to the screen. Only remove the plastic cover after the medical panel PC has been properly installed. This ensures the screen is protected during the installation process.

L'écran LCD avant a un couvercle en plastique de protection collé à l'écran. Retirez le couvercle en plastique uniquement une fois que le Panel PC médical a été correctement installé. Cela garantit que l'écran est protégé pendant le processus d'installation.

- 
- Step 1:** Use box cutters, a knife or a sharp pair of scissors that seals the top side of the external (second) box.
  - Step 2:** Open the external (second) box.
  - Step 3:** Use box cutters, a knife or a sharp pair of scissors that seals the top side of the internal (first) box.
  - Step 4:** Lift the panel PC out of the boxes.
  - Step 5:** Remove both polystyrene ends, one from each side.
  - Step 6:** Pull the plastic cover off the medical panel PC.
  - Step 7:** Make sure all the components listed in the packing list are present.



## POCi-W22C-ULT5 Medical Panel PC





### 2.2 Packing List



#### NOTE:

If any of the components listed in the checklist below are missing, do not proceed with the installation. Contact the IEI reseller or vendor the POCi-W22C-ULT5 was purchased from or contact an IEI sales representative directly by sending an email to [sales@ieiworld.com](mailto:sales@ieiworld.com).

The POCi-W22C-ULT5 medical panel PC is shipped with the following components:

Quantity	Item	Image
1	POCi-W22C-ULT5 medical panel PC	
1	150 W FSP FSP150M-ABA medical-grade power adapter	
1	Power cord (EU)	
4	Round-head screw (M3*3) for HDD installation	

### 2.3 Optional ATO Items

The following are optional, assemble-to-order components:

Item	Part Number
RFID reader	MEDP-MF-RFID-R11
DICOM module	MEDP-DICOM-R10
PoE card, 2-port 1000BASE-T, 802.3at	GPoE-2P-R20
Cable cover	POCP-CC06-R10
TPM module	TPM-IN03-R10
Li-ion battery pack, 3S3P, 7800 mAh	31603-000069-RS

Chapter

**3**

# Installation

---

### 3.1 Safety Precautions

Please ensure the following safety precautions are adhered to at all times.

- **To prevent the risk of electric shock, make sure power cord is unplugged from wall socket.** To fully disengage the power to the unit, please disconnect the power cord from the ac outlet. Refer servicing to qualified service personnel. The AC outlet shall be readily available and accessible.
- **Users must not allow SIP/SOPs and the patient to come into contact at the same time.**
- **Grounding reliability** can only be achieved when the equipment is connected to an equivalent receptacle marked “Hospital Only” or “Hospital Grade”.
- **Follow the electrostatic precautions** outlined below whenever the POCi-W22C-ULT5 is opened.
- **Make sure the power is turned off and the power cord is disconnected** whenever the POCi-W22C-ULT5 is being installed, moved or modified.
- **Do not apply voltage levels that exceed the specified voltage range.** Doing so may cause fire and/or an electrical shock. Use a power cord that matches the voltage of the power outlet, which has been approved and complies with the safety standard of your particular country.
- **Electric shocks can occur** if the POCi-W22C-ULT5 chassis is opened when the POCi-W22C-ULT5 is running. To avoid risk of electric shock, this equipment must only be connected to a supply mains with protective earth.
- **DO NOT LEAVE THIS EQUIPMENT IN AN UNCONTROLLED ENVIRONMENT WHERE THE STORAGE TEMPERATURE IS BELOW -20° C (-4°F) OR ABOVE 60° C (140° F). IT MAY DAMAGE THE EQUIPMENT.**
- **Do not drop or insert any objects** into the ventilation openings of the POCi-W22C-ULT5.
- **If considerable amounts of dust, water, or fluids enter the POCi-W22C-ULT5,** turn off the power supply immediately, unplug the power cord, and contact the POCi-W22C-ULT5 vendor.

## POCi-W22C-ULT5 Medical Panel PC

- **DO NOT:**
  - Drop the POCi-W22C-ULT5 against a hard surface.
  - Strike or exert excessive force onto the LCD panel.
  - Touch any of the LCD panels with a sharp object
  - In a site where the ambient temperature exceeds the rated temperature

### 3.2 Anti-static Precautions



#### WARNING / AVERTISSEMENT

Failure to take ESD precautions during the maintenance of the POCi-W22C-ULT5 may result in permanent damage to the POCi-W22C-ULT5 and severe injury to the user.

Le fait de ne pas prendre des précautions contre les décharges électrostatiques pendant la maintenance du POCi-W22C-ULT5 peut entraîner des dommages permanents au POCi-W22C-ULT5 et des blessures graves pour l'utilisateur.

Electrostatic discharge (ESD) can cause serious damage to electronic components, including the POCi-W22C-ULT5. Dry climates are especially susceptible to ESD. It is therefore critical that whenever the POCi-W22C-ULT5 is accessed internally, or any other electrical component is handled, the following anti-static precautions are strictly adhered to.

- ***Wear an anti-static wristband:*** Wearing a simple anti-static wristband can help to prevent ESD from damaging the board.
- ***Self-grounding:*** Before handling the board, touch any grounded conducting material. During the time the board is handled, frequently touch any conducting materials that are connected to the ground.
- ***Use an anti-static pad:*** When configuring the POCi-W22C-ULT5, place it on an anti-static pad. This reduces the possibility of ESD damaging the POCi-W22C-ULT5.

### 3.3 Installation Precautions

When installing the medical panel PC, please follow the precautions listed below:

- **Manufacturer authorization:** Do not modify this equipment without authorization of manufacturer.
- **Certified Engineers:** Only certified engineers should install and modify the hardware settings.
- **Power turned off:** When installing the medical panel PC, make sure the power is off. Failing to turn off the power may cause severe injury to the body and/or damage to the system.
- **Anti-static Discharge:** If a user open the rear panel of the medical panel PC, to plug in added peripheral devices, ground themselves first and wear an anti-static wristband.



#### **WARNING / AVERTISSEMENT**

DO NOT power up the POCi-W22C-ULT5 while the front panel is facing down on a sheet of conductive foam. Doing so may cause the touch panel to malfunction due to the large surface area of contact between the conductive form and the touch panel.

NE mettez PAS le POCi-W22C-ULT5 sous tension lorsque le panneau avant est orienté vers le bas sur une feuille de mousse conductrice. Cela pourrait entraîner un dysfonctionnement de l'écran tactile en raison de la grande surface de contact entre la forme conductrice et l'écran tactile.

---

### 3.4 Installation and Configuration Steps

The following installation steps must be followed.

- Step 1:** Unpack the medical panel PC.
- Step 2:** Install an HDD/SSD.
- Step 3:** Connect peripheral devices to the medical panel PC.
- Step 4:** Mount the medical panel PC.

## POCi-W22C-ULT5 Medical Panel PC

### 3.5 HDD Installation

To install the HDD into the system, please follow the steps below:

**Step 1:** Remove the two HDD cover retention screws on the rear panel (**Figure 3-1**).



**Figure 3-1: HDD Cover Retention Screws**

**Step 2:** Remove the HDD cover.

**Step 3:** Remove the two HDD bracket retention screws (**Figure 3-2**) and lift the HDD bracket off the panel PC.



**Figure 3-2: HDD Bracket Retention Screws**

**Step 4:** Insert an HDD into the HDD bracket, aligning the four retention screw holes on the bottom of the HDD bracket with the retention screw holes on the bottom of the HDD (**Figure 3-3**).

**Step 5:** Insert four retention screws (M3\*3) into the bracket (**Figure 3-3**).

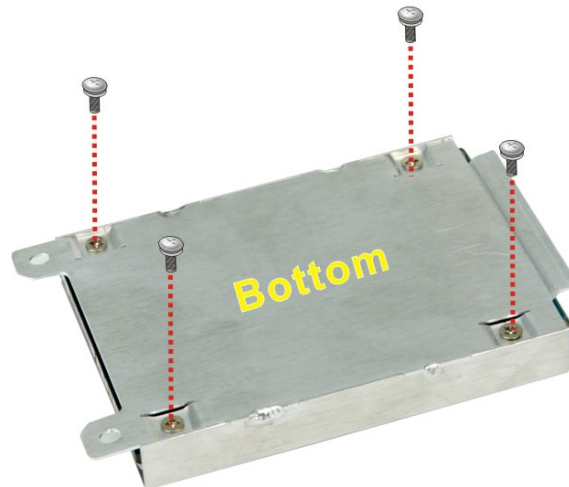

**Figure 3-3: Secure HDD**

**Step 6:** Place the HDD and slide it to securely connect to the SATA connector of the POCi-W22C-ULT5 (**Figure 3-4**).

**Step 7:** Secure the HDD bracket by fastening the two retention screws previously removed (**Figure 3-4**).

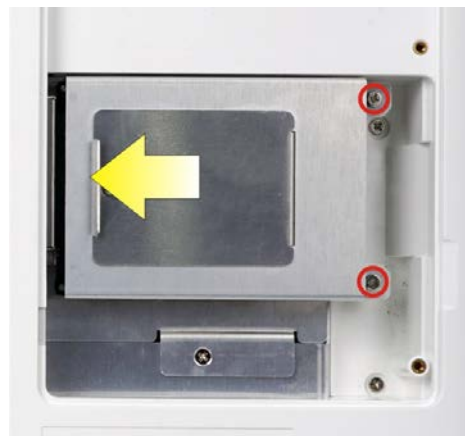

**Figure 3-4: HDD Installation**

**Step 8:** Re-install the HDD cover.



## POCi-W22C-ULT5 Medical Panel PC

### 3.6 M.2 M-Key Module Installation

To install M.2 modules into the system, please follow the steps below:

**Step 1:** Follow the **Step 1 ~ Step 3** instruction described in **Section 3.5** to remove the HDD cover and the HDD bracket.

**Step 2:** Remove the three retention screws to lift the bracket off the panel PC.



Figure 3-5: Bracket Retention Screws

**Step 3:** Locate the M.2 M-key slot.



Figure 3-6: M.2 Slot Location

**NOTE:**

The latch position is adjustable for 2242 or 2260-sized modules. To change the latch position, rotate the latch 90° and lift the latch off the board. Insert the latch into the pre-drilled hole that matches the size of the M.2 module, and rotate the latch 90° to lock it.

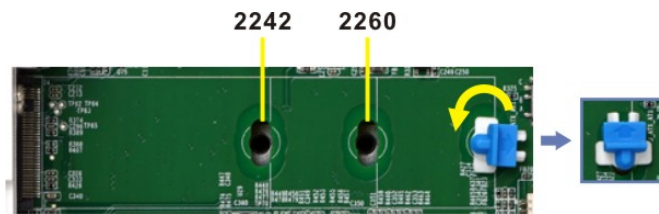

- Step 4:** Line up the notch on the M.2 module with the notch on the slot. Slide the M.2 module into the socket at an angle of about 20° (**Figure 3-7**).



**Figure 3-7: Inserting the M.2 Module into the Slot at an Angle**

- Step 5:** Press the M.2 module down to secure it (**Figure 3-8**).



**Figure 3-8: Securing the M.2 Module**

- Step 6:** Re-install the brackets and the HDD cover.

## POCi-W22C-ULT5 Medical Panel PC

### 3.7 RS-232 Serial Port Connection

The bottom panel of the POCi-W22C-ULT5 has one DB-9 male connector for RS-232 connection. It is 1.5kV isolated and compliant to the MOOP classification. The pinouts of the DB-9 connector are listed below.

Pin	RS-232
1	DCD
2	RX
3	TX
4	DTR
5	GND
6	DSR
7	RTS
8	CTS
9	RI

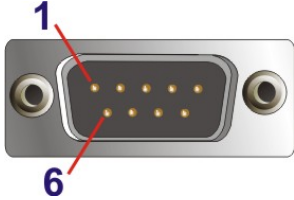
A diagram of a DB-9 male connector. The connector is a rectangular metal housing with a central row of nine gold-plated pins. Two circular mounting holes are located on the left and right sides. Red lines with blue numbers '1' and '6' point to the first and sixth pins from the left, respectively.

**Table 3-1: RS-232 Serial Port Pinouts**

### 3.8 VESA Mounting

The POCi-W22C-ULT5 is VESA (Video Electronics Standards Association) compliant and can be mounted on a mounting device with a 75 mm or a 100 mm interface pad. The POCi-W22C-ULT5 VESA mount retention screw holes are shown below. Refer to the installation guide that came with the mounting device to mount the POCi-W22C-ULT5.

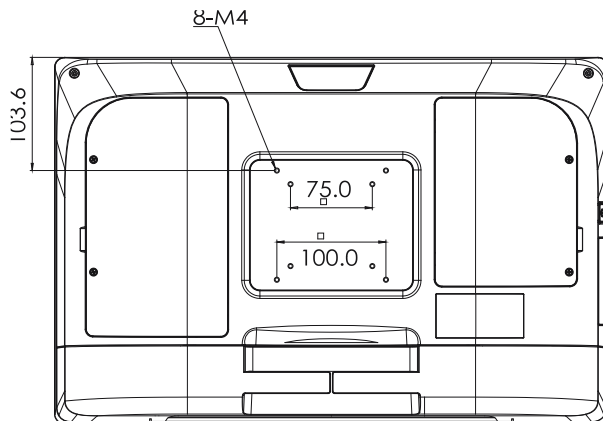

Figure 3-9: VESA Mounting Retention Screw Holes



#### WARNING / AVERTISSEMENT

1. When mounting the POCi-W22C-ULT5 flat panel PC, it is better to have more than one person to help with the installation to make sure the POCi-W22C-ULT5 does not fall down and get damaged.

Lors du montage du PC à écran plat POCi-W22C-ULT5, il est préférable d'avoir plus d'une personne pour aider à l'installation pour s'assurer que le POCi-W22C-ULT5 ne tombe pas et ne soit pas endommagé.

2. Use suitable mounting apparatus and be sure to secure the screws of the mounting apparatus tightly to avoid risk of injury.

Utilisez un appareil de montage approprié et assurez-vous de bien fixer les vis de l'appareil de montage pour éviter tout risque de blessure.

## POCi-W22C-ULT5 Medical Panel PC

### 3.9 Powering On the System



#### WARNING / AVERTISSEMENT

To avoid risk of electric shock, this equipment must only be connected to supply mains with protective earth.

Pour éviter tout risque d'électrocution, cet équipement ne doit être connecté qu'au secteur avec mise à la terre de protection.

To power on the system, follow the steps below:

#### Step 1: [Standard SKU]

Connect the power cord to the power adapter. Connect the other end of the power cord to a power source. Connect the power adapter to the power connector of the POCi-W22C-ULT5. **NOTE:** The FSP FSP150M-ABA power adapter came with the POCi-W22C-ULT5 standard SKU is a forming part of the medical device.

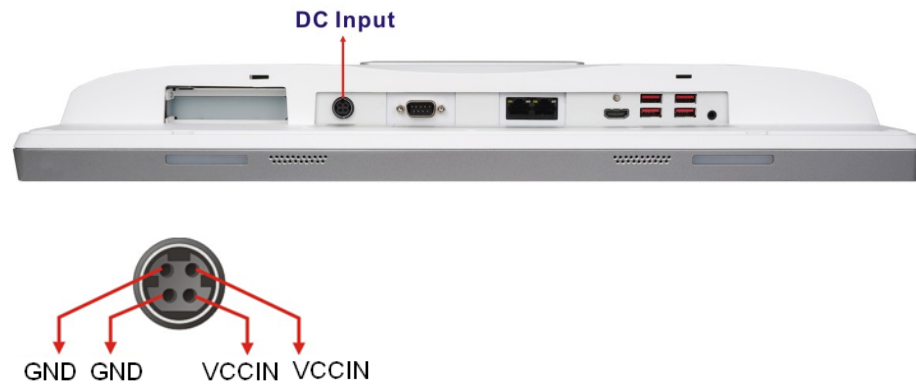

Figure 3-10: Power Input Connector

#### [BP SKU]

Connect the power cord to the power connector of the POCi-W22C-ULT5 BP SKU. Connect the other end of the power cord to a power source.



**Figure 3-11: Power Input Connector**

**Step 2:** Locate the power button on the right panel (**Figure 1-6**).

**Step 3:** Short press the power button to turn on the POCi-W22C-ULT5.



**NOTE:**

1. The user can also long-press the touch button  on the front panel for 2 seconds to power on the system (please refer to **Section 1.4.1**).
  2. Long-press the power button for 10 seconds to force shutdown the panel PC.
-

Chapter

4

# BIOS Setup

---

## 4.1 Introduction

The BIOS is programmed onto the BIOS chip. The BIOS setup program allows changes to certain system settings. This chapter outlines the options that can be changed.



### NOTE:

Some of the BIOS options may vary throughout the life cycle of the product and are subject to change without prior notice.

---

### 4.1.1 Starting Setup

The UEFI BIOS is activated when the computer is turned on. The setup program can be activated in one of two ways.

1. Press the **DEL** key as soon as the system is turned on or
2. Press the **DEL** key when the “**Press DEL to enter SETUP**” message appears on the screen.

If the message disappears before the **DEL** key is pressed, restart the computer and try again.

### 4.1.2 Using Setup

Use the arrow keys to highlight items, press **ENTER** to select, use the PageUp and PageDown keys to change entries, press **F1** for help and press **ESC** to quit. Navigation keys are shown in the following table.

Key	Function
Up arrow	Move to the item above
Down arrow	Move to the item below
Left arrow	Move to the item on the left hand side
Right arrow	Move to the item on the right hand side
+	Increase the numeric value or make changes



## POCi-W22C-ULT5 Medical Panel PC

-	Decrease the numeric value or make changes
F1 key	General help, only for Status Page Setup Menu and Option Page Setup Menu
F2 key	Load previous values.
F3 key	Load optimized defaults
F4 key	Save changes and Exit BIOS
Esc key	Main Menu – Quit and do not save changes into CMOS Status Page Setup Menu and Option Page Setup Menu -- Exit current page and return to Main Menu

**Table 4-1: BIOS Navigation Keys**

### 4.1.3 Getting Help

When **F1** is pressed a small help window describing the appropriate keys to use and the possible selections for the highlighted item appears. To exit the Help Window press **Esc** or the **F1** key again.

### 4.1.4 BIOS Menu Bar

The **menu bar** on top of the BIOS screen has the following main items:

- Main – Changes the basic system configuration.
- Advanced – Changes the advanced system settings.
- Chipset – Changes the chipset settings.
- Security – Sets User and Supervisor Passwords.
- Boot – Changes the system boot configuration.
- Save & Exit – Selects exit options and loads default settings

The following sections completely describe the configuration options found in the menu items at the top of the BIOS screen and listed above.

## 4.2 Main

The **Main** BIOS menu (**BIOS Menu 1**) appears when the **BIOS Setup** program is entered.

The **Main** menu gives an overview of the basic system information.

```

Aptio Setup Utility - Copyright (C) 2020 American Megatrends, Inc.
Main  Advanced  Chipset  Security  Boot  Save & Exit

BIOS Information
BIOS Vendor                American Megatrends
Core Version                5.13
Compliance                 UEFI 2.7; PI 1.6
Project Version             Z641AR12.BIN
Build Date and Time        12/14/2020 11:11:49

iWDD Vendor                 iEi
iWDD Version                Z641ER11.bin

Processor Information
Name                       Whiskeylake ULT
Type                       Intel(R) Core(TM)
                           i7-8655UE CPU @ 1.70GHz
Speed                      2000 MHz
ID                          0x806EC
Stepping                   V0
Number of Processors       4Core(s)/8Thread(s)
Microcode Revision         D6
GT Info                     GT2 (0x3EA0)

IGF VBIOS Version          1017
Memory RC Version           0.7.1.95
Total Memory                4096 MB
Memory Frequency            2133 MHz

PCH Information
Name                       CNL PCH-LP
PCH SKU                     (U) Premium SKU
Stepping                    D0

ME FW Version               12.0.47.1524
ME Firmware SKU             Corporate SKU

Access Level                 Administrator

System Date                 [Thu 12/15/2020]
System Time                 [22:49:37]

-----
-><: Select Screen
↑ ↓: Select Item
Enter: Select
+/-: Change Opt.
F1: General Help
F2: Previous Values
F3: Optimized Defaults
F4: Save & Exit
ESC: Exit

Version 2.20.1271. Copyright (C) 2020 American Megatrends, Inc.
  
```

### BIOS Menu 1: Main

#### → System Date [xx/xx/xx]

Use the **System Date** option to set the system date. Manually enter the day, month and year.

## POCi-W22C-ULT5 Medical Panel PC

### → System Time [xx:xx:xx]

Use the **System Time** option to set the system time. Manually enter the hours, minutes and seconds.

## 4.3 Advanced

Use the **Advanced** menu (**BIOS Menu 2**) to configure the CPU and peripheral devices through the following sub-menus:



### WARNING / AVERTISSEMENT

Setting the wrong values in the sections below may cause the system to malfunction. Make sure that the settings made are compatible with the hardware.

La définition de valeurs erronées dans les sections ci-dessous peut entraîner un dysfonctionnement du système. Assurez-vous que les paramètres définis sont compatibles avec le matériel.

```

Aptio Setup Utility - Copyright (C) 2020 American Megatrends, Inc.
Main  Advanced  Chipset  Security  Boot  Save & Exit
-----
> CPU Configuration          CPU Configuration
> PCH-FW Configuration      Parameters.
> Trusted Computing
> ACPI Settings
> RTC Wake Settings
> iWDD H/M Monitor
> F81803 Super IO Configuration
> Serial Port Console Redirection
> USB Configuration
> CSM Configuration
> NVMe Configuration

-----
→←: Select Screen
↑ ↓: Select Item
Enter: Select
+/-: Change Opt.
F1: General Help
F2: Previous Values
F3: Optimized Defaults
F4: Save & Exit
ESC: Exit

Version 2.20.1271. Copyright (C) 2020 American Megatrends, Inc.
    
```

### BIOS Menu 2: Advanced

### 4.3.1 CPU Configuration

Use the **CPU Configuration (BIOS Menu 3)** to view detailed CPU specifications and configure the CPU.

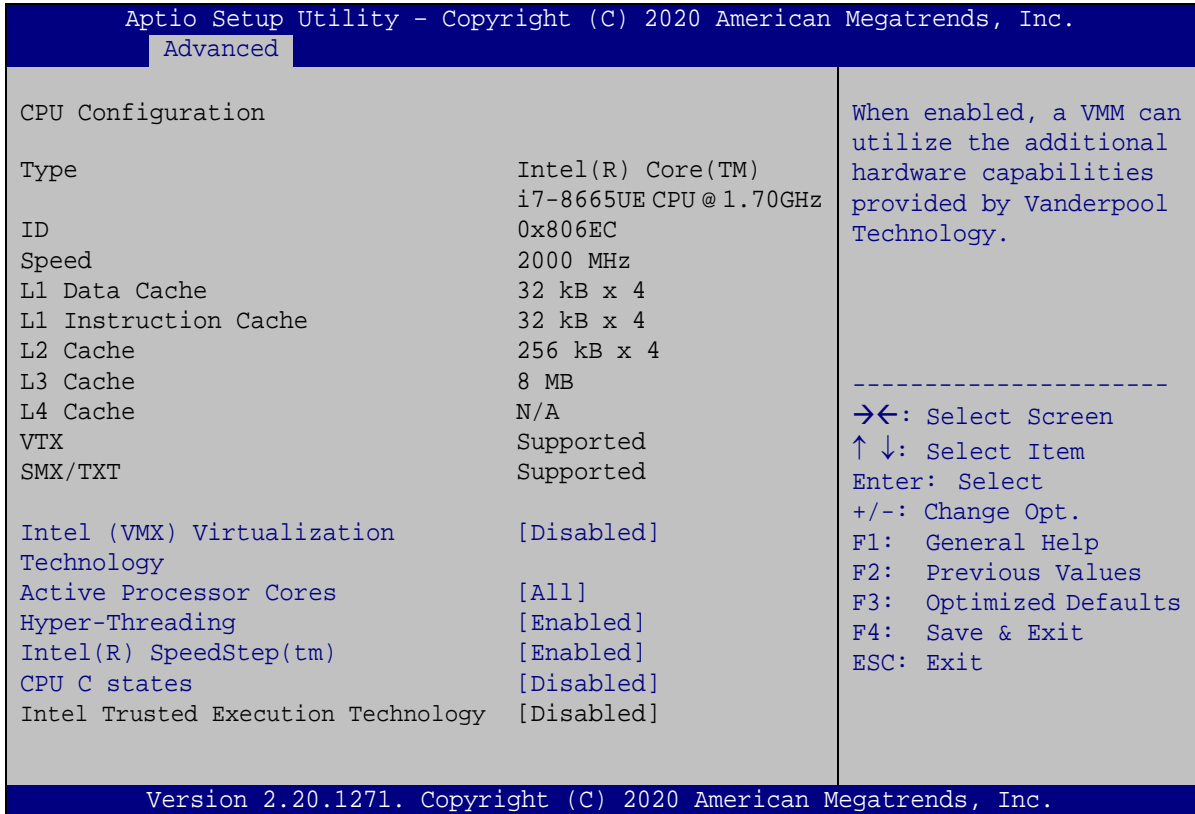

#### BIOS Menu 3: CPU Configuration

##### → Intel (VMX) Virtualization Technology [Disabled]

Use the **Intel (VMX) Virtualization Technology** option to enable or disable virtualization on the system. When combined with third party software, Intel® Virtualization technology allows several OSs to run on the same system at the same time.

- **Disabled**                      **DEFAULT**      Disables Intel Virtualization Technology.
- **Enabled**    Enables Intel Virtualization Technology.

## POCi-W22C-ULT5 Medical Panel PC

### → Active Processor Cores [All]

Use the **Active Processor Cores** BIOS option to enable numbers of cores in the processor package.

- **All**                      **DEFAULT**    Enable all cores in the processor package.
- **1**    Enable one core in the processor package.
- **2**    Enable two cores in the processor package.
- **3**    Enable three cores in the processor package.

### → Hyper-Threading [Enabled]

Use the **Hyper-Threading** option to enable or disable the Intel® Hyper-Threading Technology.

- **Disabled**                                      Disable Intel® Hyper-Threading Technology
- **Enabled**                      **DEFAULT**    Enable Intel® Hyper-Threading Technology

### → Intel® SpeedStep(tm) [Enabled]

Use the **Intel® SpeedStep™** option to enable or disable the Intel® SpeedStep Technology.

- **Disabled**                                      Disables the Intel® SpeedStep Technology.
- **Enabled**                      **DEFAULT**    Enables the Intel® SpeedStep Technology.

### → CPU C State [Disabled]

Use the **CPU C State** option to enable or disable CPU C state.

- **Disabled**                      **DEFAULT**    Disables CPU C state.
- **Enabled**                                      Enables CPU C state.

### 4.3.2 PCH-FW Configuration

The **PCH-FW Configuration** menu (**BIOS Menu 4**) allows Intel® Active Management Technology (AMT) options to be configured.

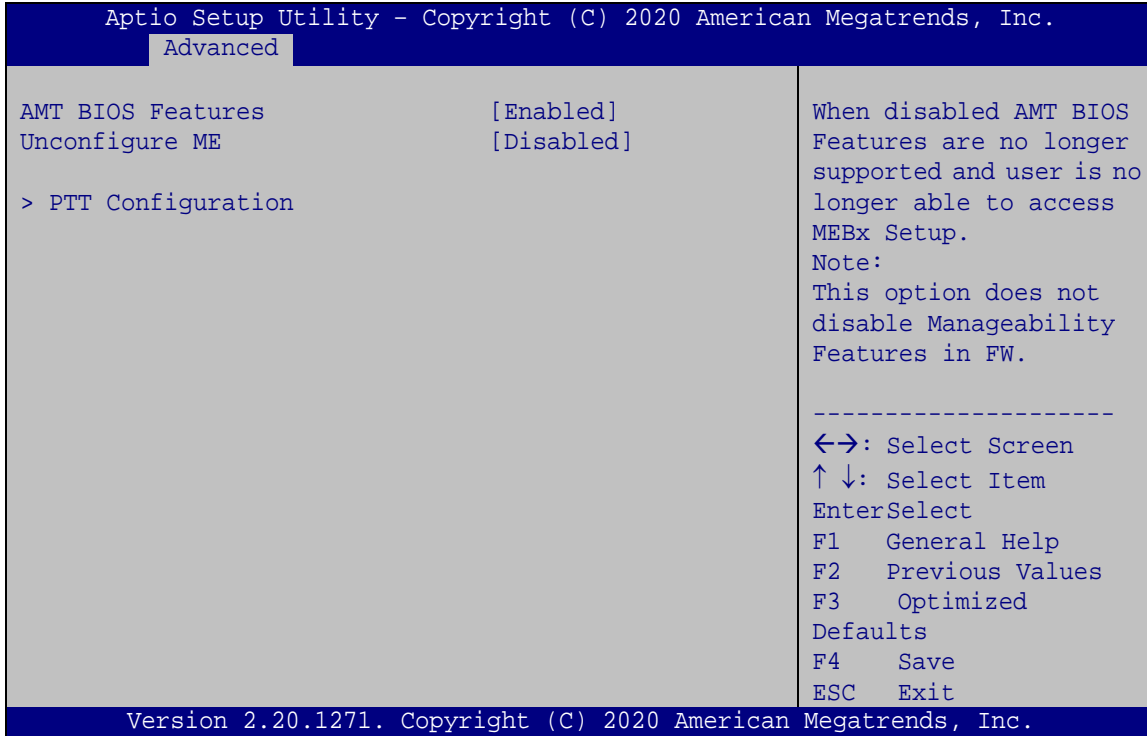

#### BIOS Menu 4: PCH-FW Configuration

##### ➔ AMT BIOS Features [Enabled]

Use **AMT BIOS Features** option to enable or disable the access to MEBx Setup.

- ➔ **Disabled**                      Unable to access MEBx Setup
- ➔ **Enabled      DEFAULT**      Allow access to MEBx Setup

##### ➔ Unconfigure ME [Disabled]

Use the **Unconfigure ME** option to perform ME unconfigure without password operation.

- ➔ **Disabled      DEFAULT**      Not perform AMT/ME unconfigure
- ➔ **Enabled**                      To perform AMT/ME unconfigure

## POCi-W22C-ULT5 Medical Panel PC

### 4.3.2.1 PTT Configuration

Use the **PTT Configuration** menu (**BIOS Menu 5**) to configure settings related to the Trusted Platform Module (TPM).

```

Aptio Setup Utility - Copyright (C) 2020 American Megatrends, Inc.
  Advanced
PTT Capability / State          1 / 0
TPM Device Selection           [dTPM (If supported)]
Select TPM device: PTT or
dTPM. PTT- Enables PTT in
SkuMgr dTPM 1.2 -
Disables PTT in SkuMgr
Warning! PTT/dTPM will
be disabled and all data
saved on it will be lost.

-----
<->: Select Screen
↑ ↓: Select Item
Enter>Select
F1   General Help
F2   Previous Values
F3   Optimized
Defaults
F4   Save
ESC  Exit

Version 2.20.1271. Copyright (C) 2020 American Megatrends, Inc.
  
```

#### BIOS Menu 5: PTT Configuration

##### → TPM Device Selection [dTPM (If supported)]

Use the **TPM Device Selection** option to configure support for the TPM.

- **dTPM** (If **DEFAULT** Disable PTT in SkuMgr.  
supported)
- **PTT** Enable PTT in SkuMgr

### 4.3.3 Trusted Computing

Use the **Trusted Computing** menu (**BIOS Menu 6**) to configure settings related to the Trusted Computing Group (TCG) Trusted Platform Module (TPM).

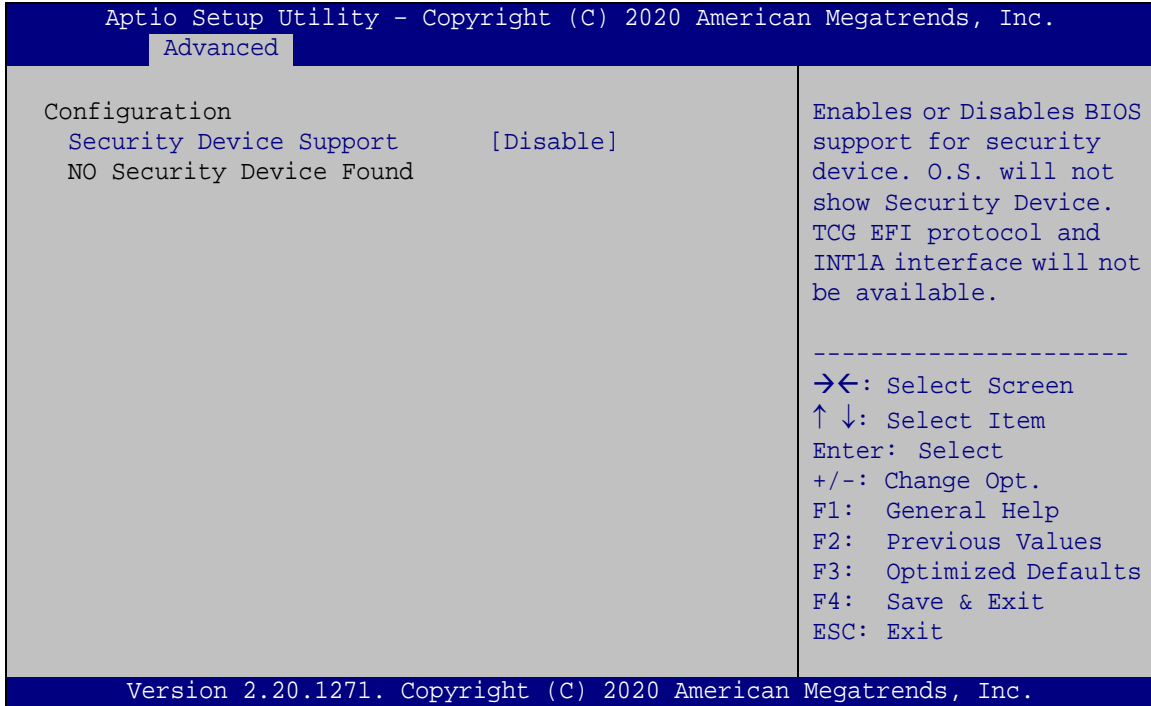

#### BIOS Menu 6: Trusted Computing

##### → Security Device Support [Disable]

Use the **Security Device Support** option to configure support for the security devices.

- **Disable**    **DEFAULT**    Security device support is disabled.
- **Enable**                    Security device support is enabled.



## POCi-W22C-ULT5 Medical Panel PC

### 4.3.4 ACPI Settings

The **ACPI Settings** menu (**BIOS Menu 7**) configures the Advanced Configuration and Power Interface (ACPI) options.

```

Aptio Setup Utility - Copyright (C) 2020 American Megatrends, Inc.
-----
Advanced
-----
ACPI Settings
ACPI Sleep State          [S3 (Suspend to RAM)]

Select ACPI sleep state
the system will enter
when the SUSPEND button
is pressed.

-----
-><: Select Screen
↑↓: Select Item
Enter: Select
+/-: Change Opt.
F1:  General Help
F2:  Previous Values
F3:  Optimized Defaults
F4:  Save & Exit
ESC: Exit

Version 2.20.1271. Copyright (C) 2020 American Megatrends, Inc.
  
```

#### BIOS Menu 7: ACPI Settings

##### → ACPI Sleep State [S3 (Suspend to RAM)]

Use the **ACPI Sleep State** option to specify the sleep state the system enters when it is not being used.

- **S3 (Suspend to RAM)**      **DEFAULT**      The caches are flushed and the CPU is powered off. Power to the RAM is maintained. The computer returns slower to a working state, but more power is saved.

### 4.3.5 RTC Wake Settings

The **RTC Wake Settings** menu (**BIOS Menu 8**) configures RTC wake event.

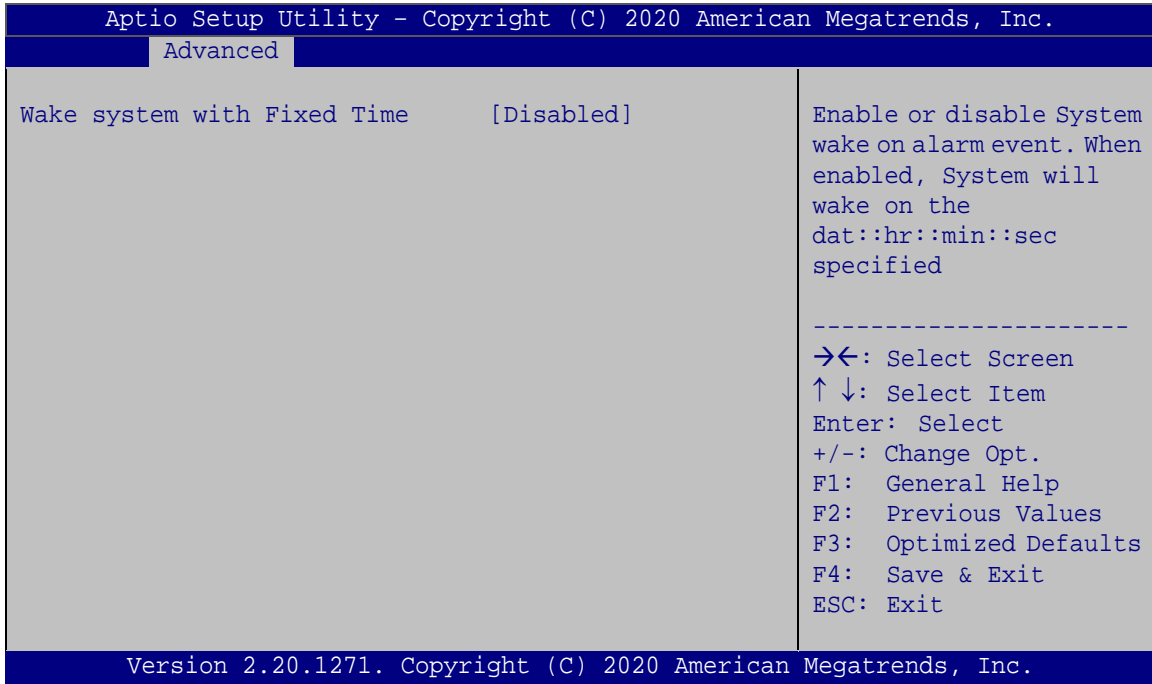

#### BIOS Menu 8: RTC Wake Settings

##### → Wake System with Fixed Time [Disabled]

Use the **Wake System with Fixed Time** option to specify the time the system should be roused from a suspended state.

- **Disabled**      **DEFAULT**      The real time clock (RTC) cannot generate a wake event
- **Enabled**                      If selected, the following appears with values that can be selected:
  - \*Wake up every day
  - \*Wake up date
  - \*Wake up hour
  - \*Wake up minute
  - \*Wake up second
 After setting the alarm, the computer turns itself on from a suspend state when the alarm goes off.

## POCi-W22C-ULT5 Medical Panel PC

### 4.3.6 iWDD H/W Monitor

The **iWDD H/W Monitor** menu (**BIOS Menu 9**) shows the operating temperatures and voltages.

```

Aptio Setup Utility - Copyright (C) 2020 American Megatrends, Inc.
Advanced
PC Health Status
CPU temperature           : +36 °C
+VCCCORE                 : +0.797 V
+VDDQ                    : +1.196 V
+3.3VSB                  : +3.288 V
+3.3V                    : +3.277 V
+5V                      : +4.961 V
+DCIN(BAT)              : +11.912 V
-----
-><: Select Screen
↑↓: Select Item
Enter: Select
+/-: Change Opt.
F1: General Help
F2: Previous Values
F3: Optimized Defaults
F4: Save & Exit
ESC: Exit
Version 2.20.1271. Copyright (C) 2020 American Megatrends, Inc.
    
```

#### BIOS Menu 9: iWDD H/W Monitor

##### → PC Health Status

The following system parameters and values are shown. The system parameters that are monitored are:

- Temperature:
  - CPU Temperature
- Voltages:
  - +VCCCORE
  - +VDDQ
  - +3.3VSB
  - +3.3V
  - +5V
  - +DCIN(BAT)

### 4.3.7 F81803 Super IO Configuration

Use the **F81803 Super IO Configuration** menu (**BIOS Menu 10**) to set or change the configurations for the serial ports.

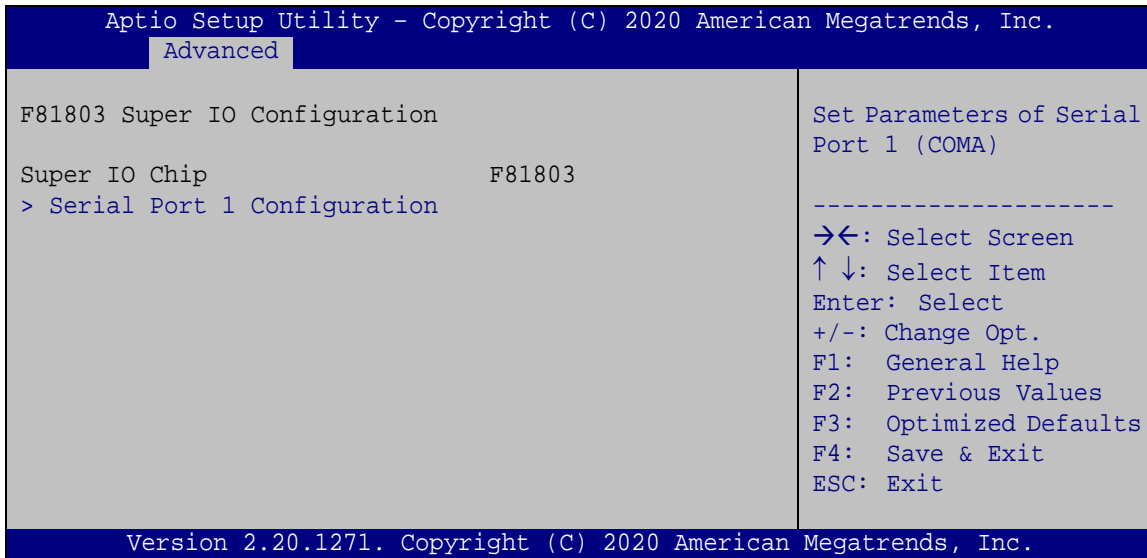

**BIOS Menu 10: F81803 Super IO Configuration**

#### 4.3.7.1 Serial Port 1 Configuration

Use the **Serial Port 1 Configuration** menu (**BIOS Menu 11**) to configure the serial port 1.

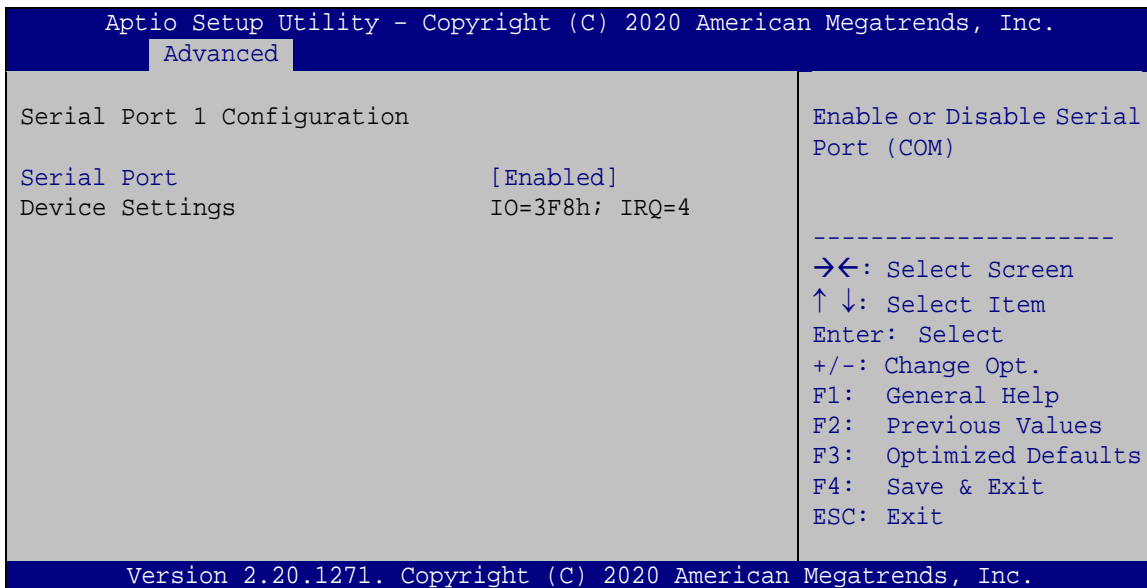

**BIOS Menu 11: Serial Port n Configuration Menu**

## POCi-W22C-ULT5 Medical Panel PC

### → Serial Port [Enabled]

Use the **Serial Port** option to enable or disable the serial port.

- **Disabled**                      Disable the serial port
- **Enabled**      **DEFAULT**      Enable the serial port

### 4.3.8 Serial Port Console Redirection

The **Serial Port Console Redirection** menu (**BIOS Menu 12**) allows the console redirection options to be configured. Console redirection allows users to maintain a system remotely by re-directing keyboard input and text output through the serial port.

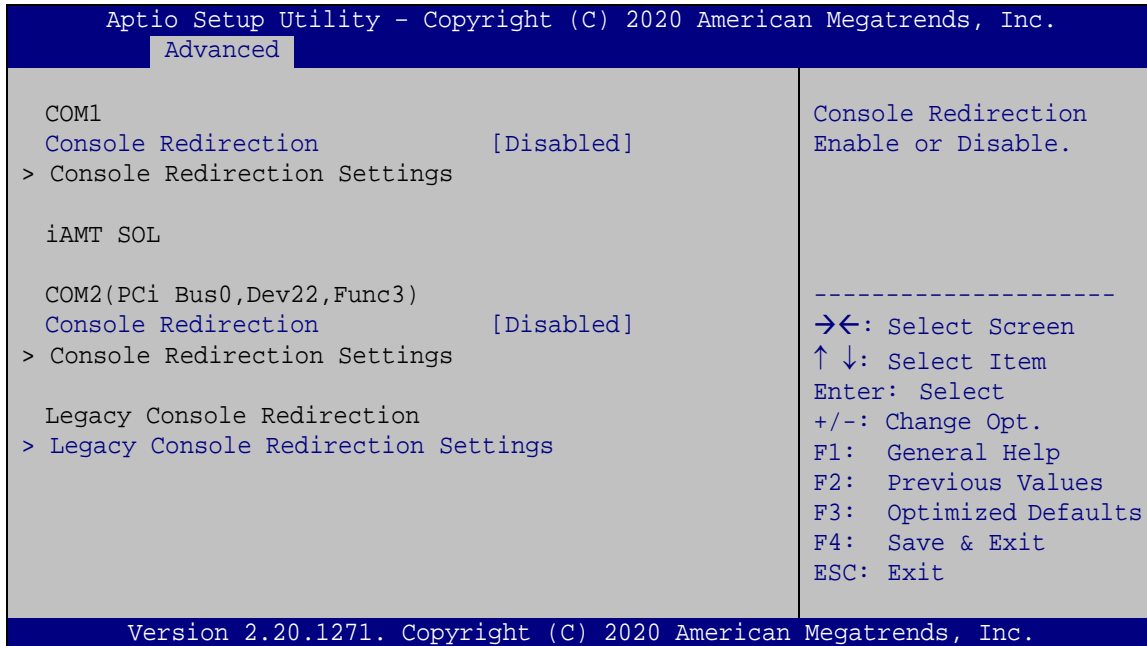

### BIOS Menu 12: Serial Port Console Redirection

### → Console Redirection [Disabled]

Use **Console Redirection** option to enable or disable the console redirection function.

- **Disabled**      **DEFAULT**      Disabled the console redirection function
- **Enabled**                      Enabled the console redirection function

### 4.3.8.1 Console Redirection Settings

Use the **Console Redirection Settings** menu (**BIOS Menu 13**) to configure console redirection settings of the specified serial port. This menu appears only when the **Console Redirection** option is enabled.

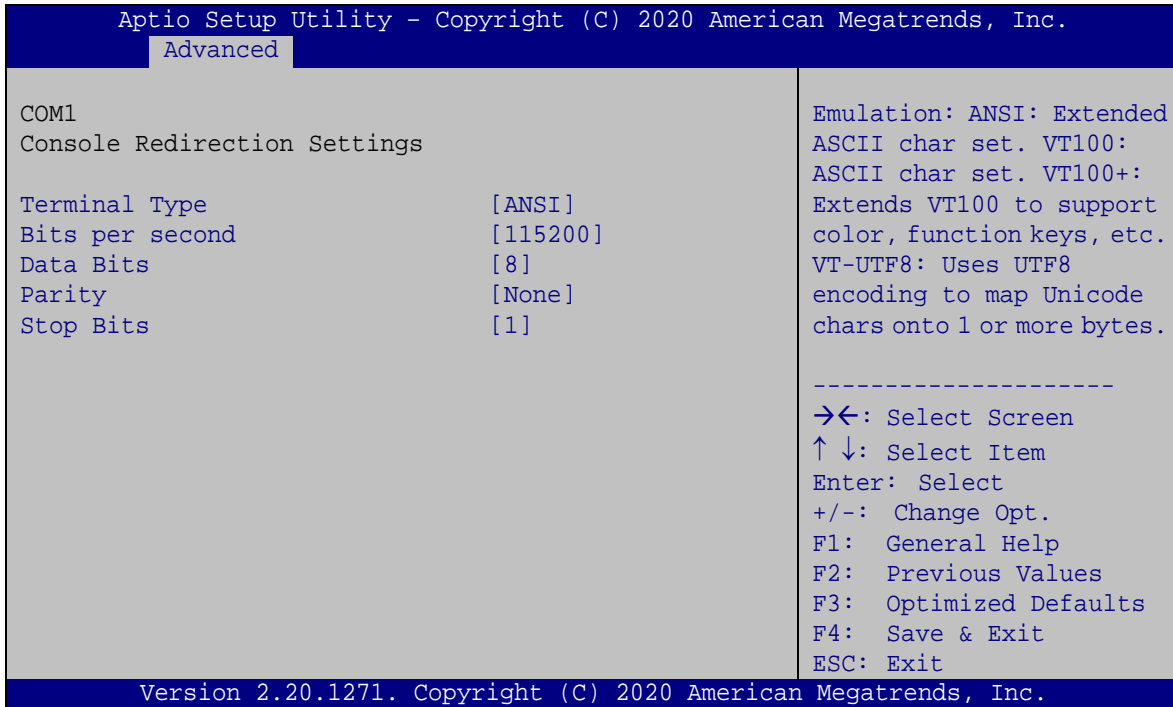

#### BIOS Menu 13: Console Redirection Settings

##### ➔ Terminal Type [ANSI]

Use the **Terminal Type** option to specify the remote terminal type.

- ➔ **VT100**                      The target terminal type is VT100
- ➔ **VT100+**                    The target terminal type is VT100+
- ➔ **VT-UTF8**                    The target terminal type is VT-UTF8
- ➔ **ANSI**                      **DEFAULT**      The target terminal type is ANSI

##### ➔ Bits per second [115200]

Use the **Bits per second** option to specify the serial port transmission speed. The speed must match the other side. Long or noisy lines may require lower speeds.

## POCi-W22C-ULT5 Medical Panel PC

- **9600** Sets the serial port transmission speed at 9600.
- **19200** Sets the serial port transmission speed at 19200.
- **57600** Sets the serial port transmission speed at 57600.
- **115200**      **DEFAULT** Sets the serial port transmission speed at 115200.

### → Data Bits [8]

Use the **Data Bits** option to specify the number of data bits.

- **7** Sets the data bits at 7.
- **8**      **DEFAULT** Sets the data bits at 8.

### → Parity [None]

Use the **Parity** option to specify the parity bit that can be sent with the data bits for detecting the transmission errors.

- **None**      **DEFAULT** No parity bit is sent with the data bits.
- **Even** The parity bit is 0 if the number of ones in the data bits is even.
- **Odd** The parity bit is 0 if the number of ones in the data bits is odd.
- **Mark** The parity bit is always 1. This option does not provide error detection.
- **Space** The parity bit is always 0. This option does not provide error detection.

### → Stop Bits [1]

Use the **Stop Bits** option to specify the number of stop bits used to indicate the end of a serial data packet. Communication with slow devices may require more than 1 stop bit.

- **1**      **DEFAULT** Sets the number of stop bits at 1.
- **2** Sets the number of stop bits at 2.

### 4.3.8.2 Legacy Console Redirection Settings

The **Legacy Console Redirection Settings** menu (**BIOS Menu 14**) allows the legacy console redirection options to be configured.

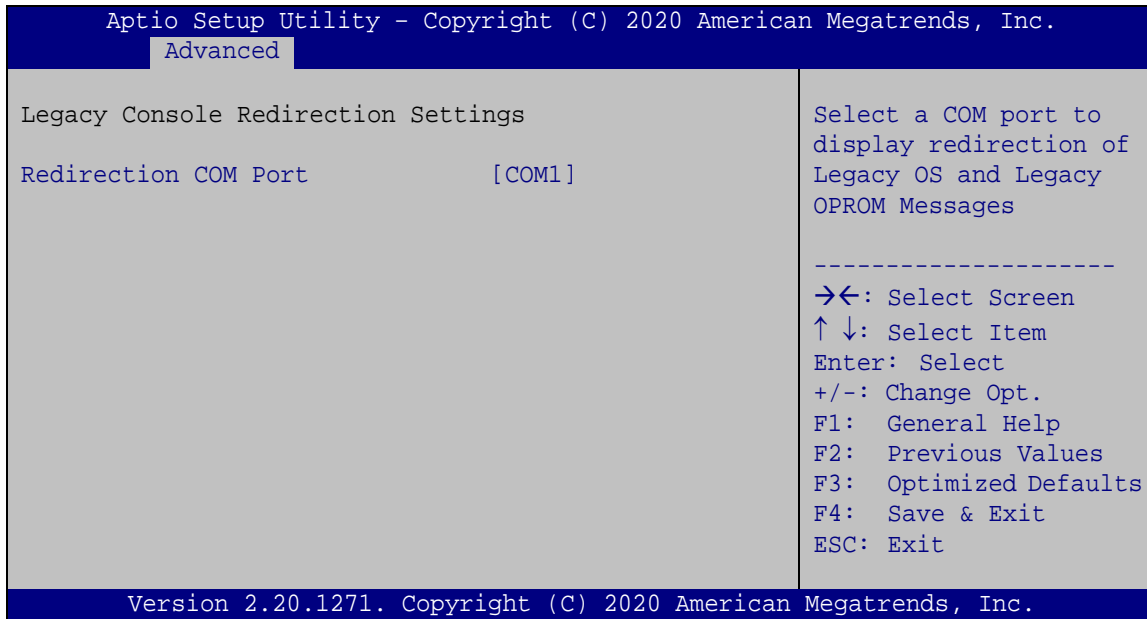

#### BIOS Menu 14: Legacy Console Redirection Settings

##### → Legacy Serial Redirection Port [COM1]

Use the **Legacy Serial Redirection Port** option to specify a COM port to display redirection of legacy OS and legacy OPRM messages. The options include:

- COM1           **DEFAULT**
- COM2 (Pci Bus0, Dev22, Func3)



## POCi-W22C-ULT5 Medical Panel PC

### 4.3.9 USB Configuration

Use the **USB Configuration** menu (**BIOS Menu 15**) to read USB configuration information and configure the USB settings.

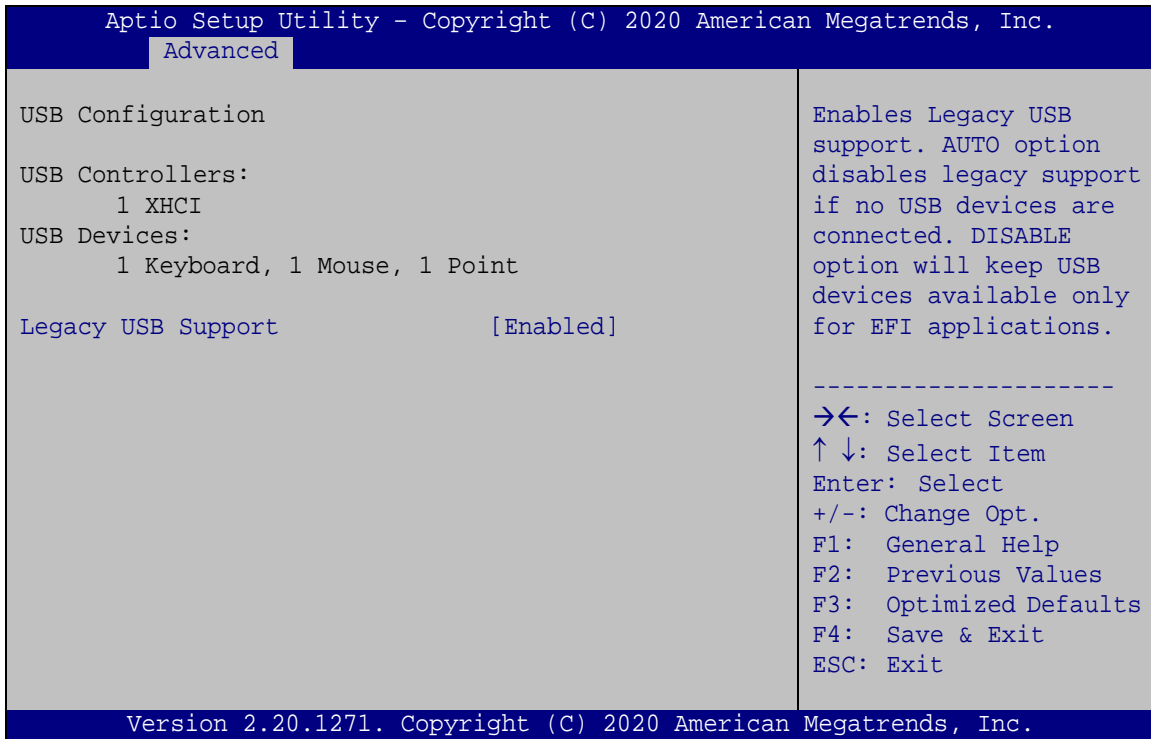

#### BIOS Menu 15: USB Configuration

##### ➔ USB Devices

The **USB Devices Enabled** field lists the USB devices that are enabled on the system

##### ➔ Legacy USB Support [Enabled]

Use the **Legacy USB Support** BIOS option to enable USB mouse and USB keyboard support. Normally if this option is not enabled, any attached USB mouse or USB keyboard does not become available until a USB compatible operating system is fully booted with all USB drivers loaded. When this option is enabled, any attached USB mouse or USB keyboard can control the system even when there is no USB driver loaded onto the system.

- ➔ **Enabled**      **DEFAULT**      Legacy USB support enabled
- ➔ **Disabled**                      Legacy USB support disabled
- ➔ **Auto**                              Legacy USB support disabled if no USB devices are connected

### 4.3.10 CSM Configuration

Use the **CSM Configuration** menu (**BIOS Menu 16**) to configure Compatibility Support Module (CSM).

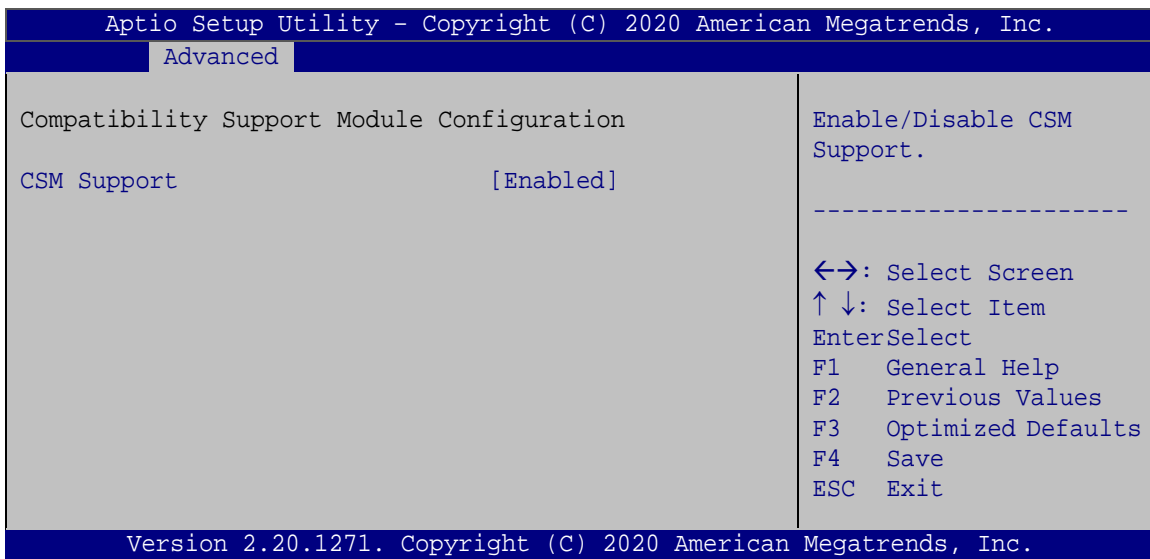

#### BIOS Menu 16: CSM Configuration

##### ➔ **CSM Support [Enabled]**

Use the **CSM Support** BIOS option to enable or disable CSM support.

- ➔ **Disabled**                      CSM support disabled
- ➔ **Enabled**      **DEFAULT**      CSM support enabled

## POCi-W22C-ULT5 Medical Panel PC

### 4.3.11 NVMe Configuration

Use the **NVMe Configuration (BIOS Menu 17)** menu to display the NVMe controller and device information.

```

Aptio Setup Utility - Copyright (C) 2020 American Megatrends, Inc.
  Advanced
NVMe Configuration
No NVME Device Found

-----
-><: Select Screen
↑↓: Select Item
Enter: Select
+/-: Change Opt.
F1: General Help
F2: Previous Values
F3: Optimized Defaults
F4: Save & Exit
ESC: Exit

Version 2.20.1271. Copyright (C) 2020 American Megatrends, Inc.
  
```

**BIOS Menu 17: NVMe Configuration**

### 4.4 Chipset

Use the **Chipset menu (BIOS Menu 18)** to configure the system chipset.

```

Aptio Setup Utility - Copyright (C) 2020 American Megatrends, Inc.
Main  Advanced  Chipset  Security  Boot  Save & Exit
> System Agent (SA) Configuration
> PCH-IO Configuration

System Agent (SA)
Parameters

-----
-><: Select Screen
↑↓: Select Item
Enter: Select
+/-: Change Opt.
F1: General Help
F2: Previous Values
F3: Optimized Defaults
F4: Save & Exit
ESC: Exit

Version 2.20.1271. Copyright (C) 2020 American Megatrends, Inc.
  
```

**BIOS Menu 18: Chipset**

### 4.4.1 System Agent (SA) Configuration

Use the **System Agent (SA) Configuration** menu (**BIOS Menu 19**) to configure the System Agent (SA) parameters.

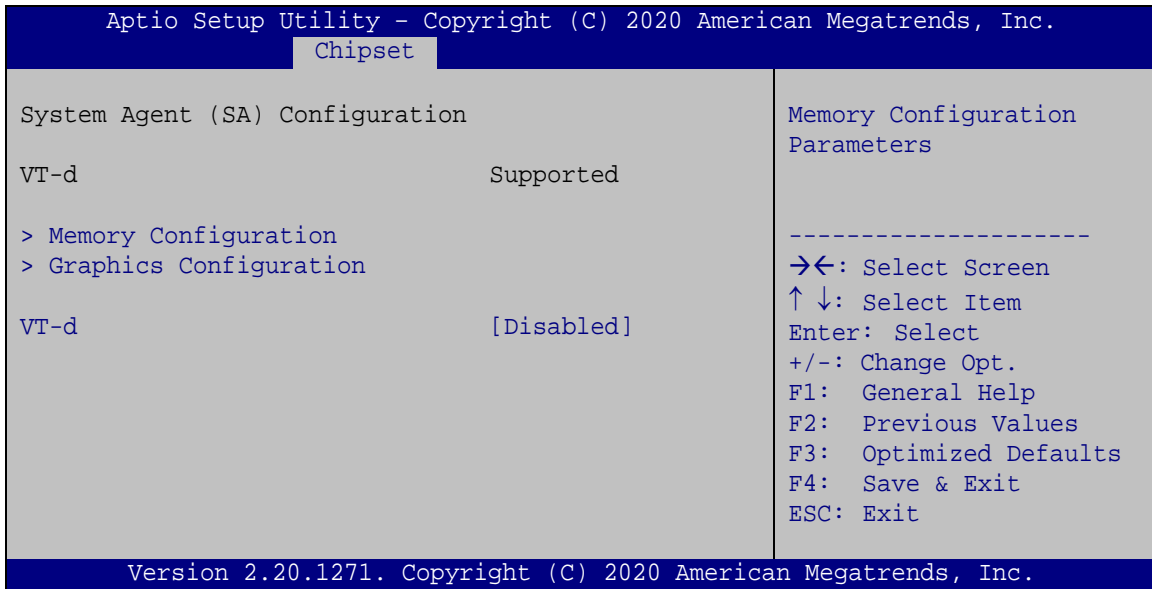

#### BIOS Menu 19: System Agent (SA) Configuration

##### → VT-d [Disabled]

Use the **VT-d** option to enable or disable VT-d support.

- **Disabled**    **DEFAULT**    Disable VT-d support.
- **Enabled**                    Enable VT-d support.

## POCi-W22C-ULT5 Medical Panel PC

### 4.4.1.1 Memory Configuration

Use the **Memory Configuration** submenu (**BIOS Menu 20**) to display the memory information.

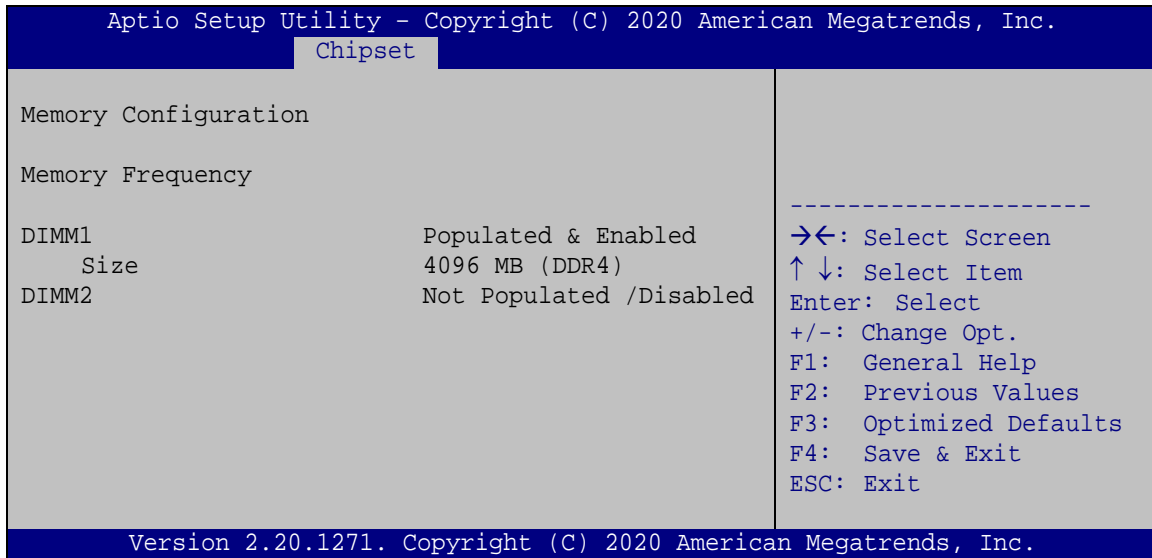

**BIOS Menu 20: Memory Configuration**

### 4.4.1.2 Graphics Configuration

Use the **Graphics Configuration** menu (**BIOS Menu 21**) to configure the graphics settings.

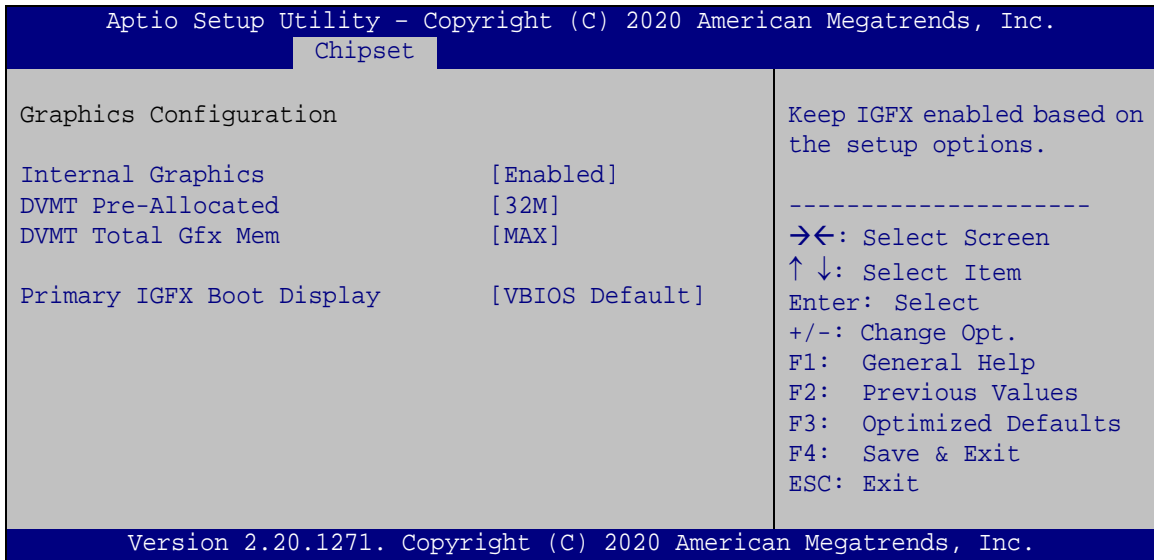

#### **BIOS Menu 21: Graphics Configuration**

##### → **Internal Graphics [Enabled]**

Use the **Internal Graphics** option to enable or disable the internal graphics device.

- **Auto**                      The internal graphics device is automatically detected and enabled.
- **Disabled**                Disable the internal graphics device.
- **Enabled**    **DEFAULT**    Enable the internal graphics device.

##### → **DVMT Pre-Allocated [32M]**

Use the **DVMT Pre-Allocated** option to set the amount of system memory allocated to the integrated graphics processor when the system boots. The system memory allocated can then only be used as graphics memory, and is no longer available to applications or the operating system. Configuration options are listed below:

- 32M                      **DEFAULT**
- 64M

## POCi-W22C-ULT5 Medical Panel PC

### → DVMT Total Gfx Mem [MAX]

Use the **DVMT Total Gfx Mem** option to select DVMT5.0 total graphic memory size used by the internal graphic device. The following options are available:

- 256M
- 128M
- MAX      **DEFAULT**

### → Primary IGFX Boot Display [VBIOS Default]

Use the **Primary IGFX Boot Display** option to select the display device used by the system when it boots.

- VBIOS Default    **DEFAULT**
- HDMI1
- LVDS1

## 4.4.2 PCH-IO Configuration

Use the **PCH-IO Configuration** menu (**BIOS Menu 22**) to configure the PCH-IO chipset.

```

Aptio Setup Utility - Copyright (C) 2020 American Megatrends, Inc.
Chipset
PCH-IO Configuration
Auto Power Button Status      [Enable (AT)]
Power Saving Function(ERP)    [Disabled]
USB Power SW                  [+5V DUAL]
> PCI Express Configuration
> SATA And RST Configuration
HD Audio                      [Enabled]
-----
→←: Select Screen
↑↓: Select Item
Enter: Select
+/-: Change Opt.
F1: General Help
F2: Previous Values
F3: Optimized Defaults
F4: Save & Exit
ESC: Exit
Version 2.20.1271. Copyright (C) 2020 American Megatrends, Inc.
  
```

**BIOS Menu 22: PCH-IO Configuration**

**→ Power Saving Function(ERP) [Disabled]**

Use the **Power Saving Function(ERP)** BIOS option to enable or reduce power consumption in the S5 state. When enabled, the system can only be powered-up using the power button.

**→ Disabled**      **DEFAULT**      Power Saving Function support disabled

**→ Enabled**                      Power Saving Function support enabled

**→ USB Power SW [+5V DUAL]**

Use the **USB Power SW** BIOS option to configure whether to provide power to the external USB connectors when the system is in S3/S4 sleep state. This option is valid only when the above **Power Saving Function (ERP)** BIOS option is disabled.

**→ +5V**      **DEFAULT**      Power is provided to the USB connectors when the system is in S3/S4 sleep state  
**DUAL**

**→ +5V**                      Power is not provided to the USB connectors when the system is in S3/S4 sleep state

**→ HD Audio [Enabled]**

Use the **HD Audio** BIOS option to enable or disable the High Definition Audio controller.

**→ Disabled**                      The High Definition Audio controller is disabled.

**→ Enabled**      **DEFAULT**      The High Definition Audio controller is enabled.



## POCi-W22C-ULT5 Medical Panel PC

### 4.4.2.1 PCI Express Configuration

Use the **PCI Express Configuration** submenu (**BIOS Menu 23**) to configure the PCI Express slots.

```

Aptio Setup Utility - Copyright (C) 2020 American Megatrends, Inc.
Chipset
PCI Express Configuration
> PCIE1
> M1
> M2_M1

PCI Express Root Port Settings.
-----
-><: Select Screen
↑ ↓: Select Item
Enter: Select
+/-: Change Opt.
F1: General Help
F2: Previous Values
F3: Optimized Defaults
F4: Save & Exit
ESC: Exit

Version 2.20.1271. Copyright (C) 2020 American Megatrends, Inc.

```

#### BIOS Menu 23: PCI Express Configuration

The PCIe slot submenus all contain the following options:

#### → PCIE1 / M1 / M2\_M1 [Enabled]

Use the **PCIE1 / M1 / M2\_M1** option to enable or disable the expansion slot.

- **Disabled**                      Disables the expansion slot.
- **Enabled**                      **DEFAULT**      Enables the expansion slot.

#### → PCIe Speed [Auto]

Use the **PCIe Speed** option to configure the PCIe interface speed.

- Auto                      **DEFAULT**
- Gen1
- Gen2
- Gen3

➔ **Detect Non-Compliance Device [Disabled]**

Use the **Detect Non-Compliance Device** option to enable or disable detecting if a non-compliance PCI Express device is connected to the PCI Express slot.

- ➔ **Disabled**                      **DEFAULT**      Disables to detect if a non-compliance PCI Express device is connected to the PCI Express slot.
- ➔ **Enabled**                                      Enables to detect if a non-compliance PCI Express device is connected to the PCI Express slot.

**4.4.2.2 SATA And RST Configuration**

Use the **SATA And RST Configuration** menu (**BIOS Menu 24**) to change and/or set the configuration of the SATA devices installed in the system.

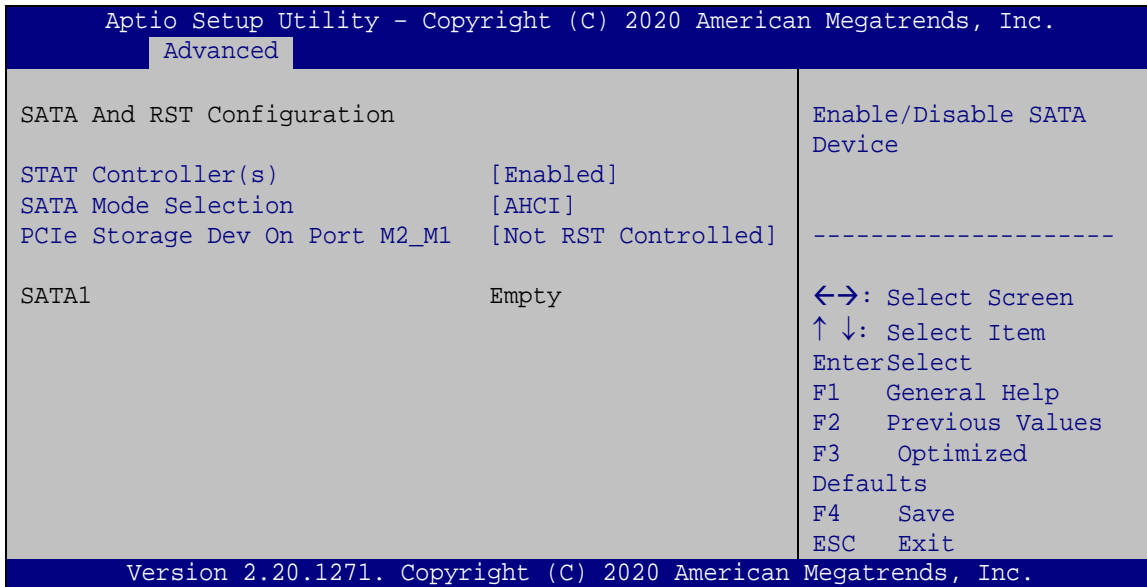

**BIOS Menu 24: SATA and RST Configuration**

➔ **STAT Controller(s) [Enabled]**

Use the **STAT Controller(s)** option to enable or disable the SATA device.

- ➔ **Enabled**                      **DEFAULT**      Enables the SATA device.
- ➔ **Disabled**                                      Disables the SATA device.

## POCi-W22C-ULT5 Medical Panel PC

### → SATA Mode Selection [AHCI]

Use the **SATA Mode Selection** option to configure how the SATA controller(s) operate.

- **AHCI**                      **DEFAULT**      Configures SATA devices as AHCI device.
- **Intel RST**                      Configures SATA devices as RAID device.  
**Premium**



#### NOTE:

Before accessing the RAID configuration utility, ensure to set the **Option ROM Messages** BIOS option in the **Boot** menu to **Force BIOS**. This is to allow the “Press <CTRL+I> to enter Configuration Utility.....” message to appear during POST. Press Ctrl+I when prompted to enter the RAID configuration utility.

---

### → PCIe Storage Dev On Port M2\_M1 [Not RST Controlled]

Use the **PCIe Storage Dev On Port M2\_M1** option to enable or disable RST PCIe storage remapping for the M.2 M-key slot (M2\_M1).

- **RST**                                      Enable RST PCIe storage remapping.  
**Controlled**
- **Not RST**                      **DEFAULT**      Disable RST PCIe storage remapping.  
**Controlled**

## 4.5 Security

Use the **Security** menu (**BIOS Menu 25**) to set system and user passwords.

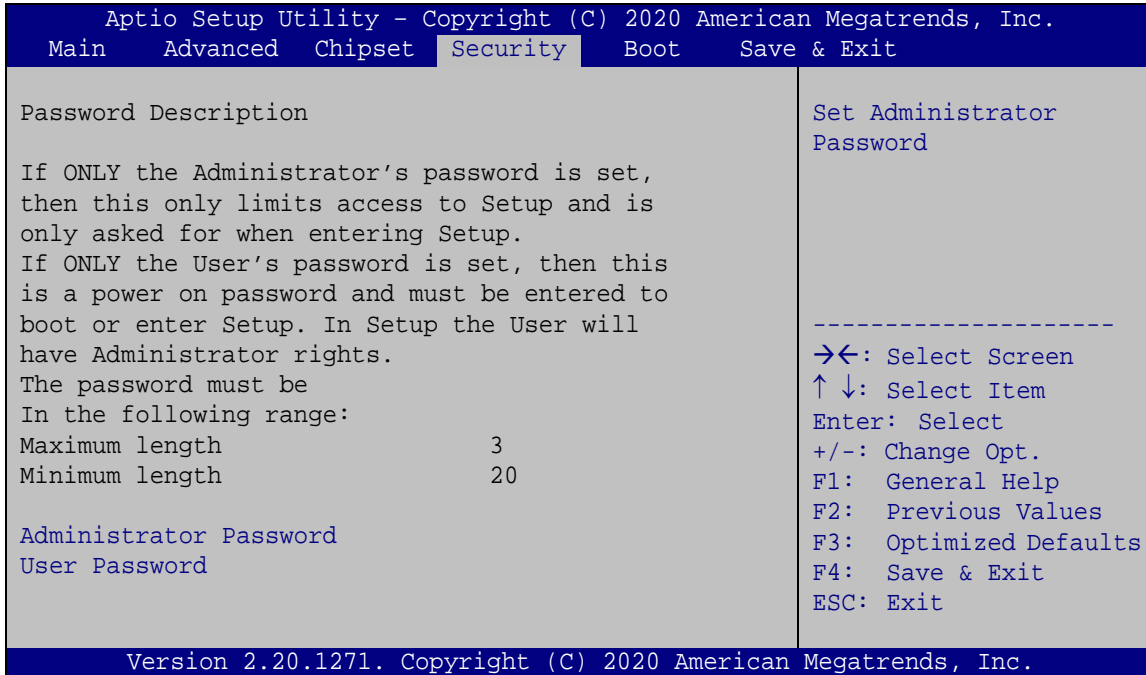

### BIOS Menu 25: Security

#### → Administrator Password

Use the **Administrator Password** field to set or change an administrator password.

#### → User Password

Use the **User Password** field to set or change a user password.

## POCi-W22C-ULT5 Medical Panel PC

### 4.6 Boot

Use the **Boot** menu (**BIOS Menu 26**) to configure system boot options.

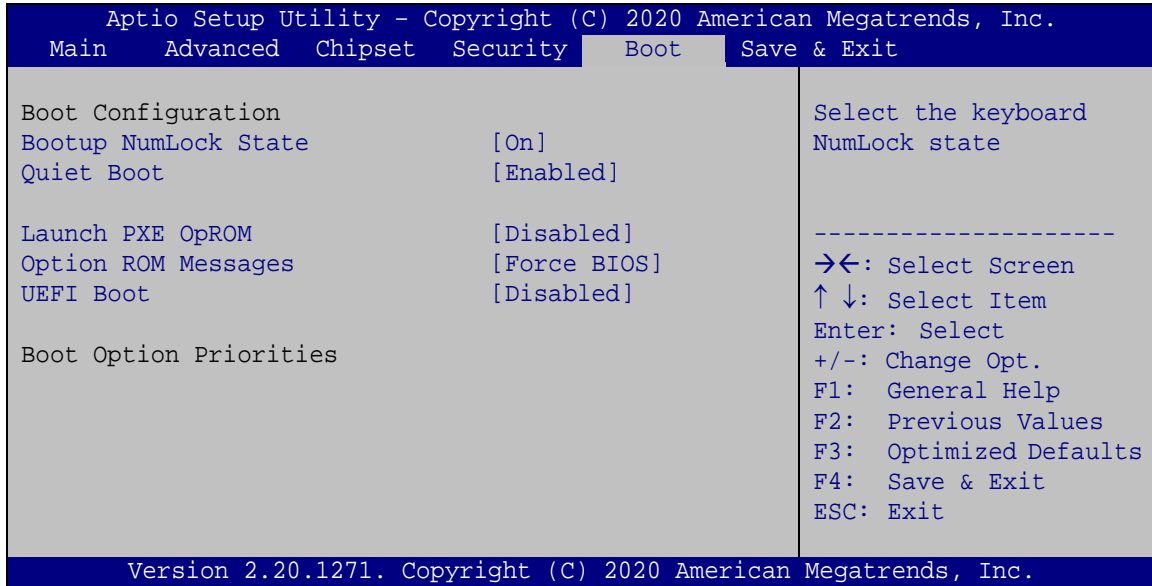

#### BIOS Menu 26: Boot

##### → Bootup NumLock State [On]

Use the **Bootup NumLock State** BIOS option to specify if the number lock setting must be modified during boot up.

→ **On**                      **DEFAULT**                      Allows the Number Lock on the keyboard to be enabled automatically when the computer system boots up. This allows the immediate use of the 10-key numeric keypad located on the right side of the keyboard. To confirm this, the Number Lock LED light on the keyboard is lit.

→ **Off**    Does not enable the keyboard Number Lock automatically. To use the 10-keys on the keyboard, press the Number Lock key located on the upper left-hand corner of the 10-key pad. The Number Lock LED on the keyboard lights up when the Number Lock is engaged.

→ **Quiet Boot [Enabled]**

Use the **Quiet Boot** BIOS option to select the screen display when the system boots.

- **Disabled**                      Normal POST messages displayed
- **Enabled      DEFAULT**      OEM Logo displayed instead of POST messages

→ **Launch PXE OpROM [Disabled]**

Use the **Launch PXE OpROM** option to enable or disable boot option for legacy network devices.

- **Disabled      DEFAULT**      Ignore all PXE Option ROMs
- **Enabled**                      Load PXE Option ROMs.

→ **Option ROM Messages [Force BIOS]**

Use the **Option ROM Messages** option to set the Option ROM display mode.

- **Force              DEFAULT**      Sets display mode to force BIOS.  
**BIOS**
- **Keep**                      Sets display mode to current.  
**Current**

→ **UEFI Boot [Disabled]**

Use the **UEFI Boot** option to enable or disable to boot from the UEFI devices.

- **Disabled      DEFAULT**      Boot from UEFI devices is disabled.
- **Enabled**                      Boot from UEFI devices is enabled.

→ **Boot Option Priority**

Use the **Boot Option Priority** function to set the system boot sequence from the available devices. The drive sequence also depends on the boot sequence in the individual device section.

## POCi-W22C-ULT5 Medical Panel PC

### 4.7 Save & Exit

Use the **Save & Exit** menu (**BIOS Menu 27**) to load default BIOS values, optimal failsafe values and to save configuration changes.

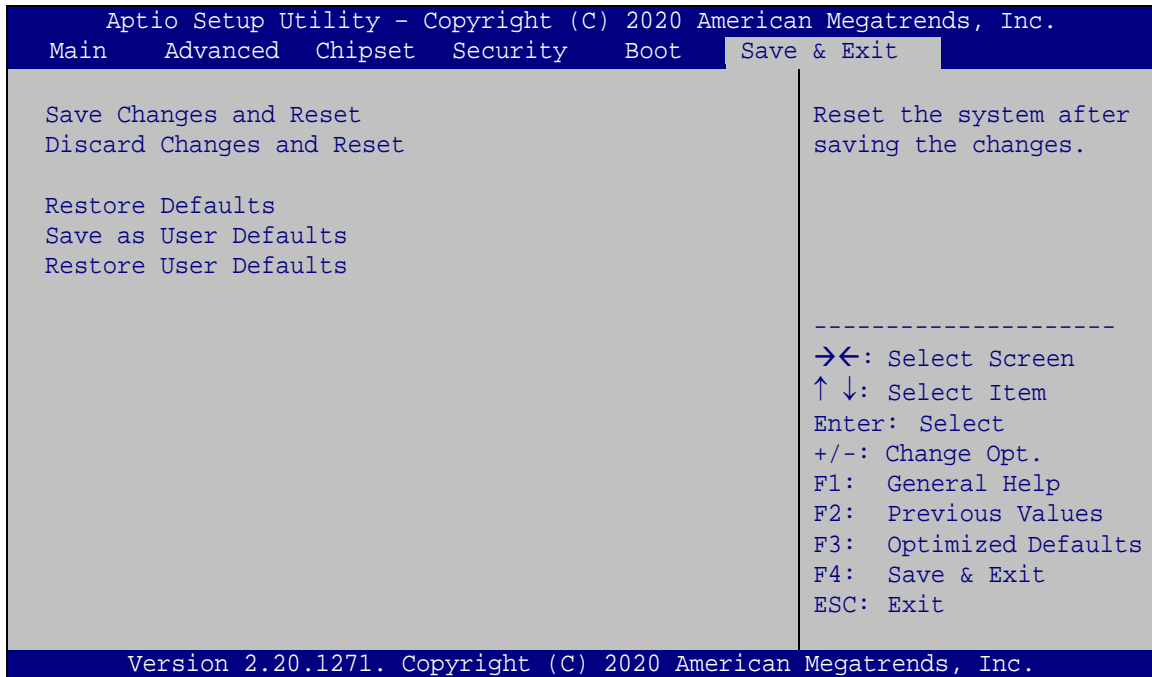

#### BIOS Menu 27: Save & Exit

##### → Save Changes and Reset

Use the **Save Changes and Reset** option to save the changes made to the BIOS options and reset the system.

##### → Discard Changes and Reset

Use the **Discard Changes and Reset** option to exit the system without saving the changes made to the BIOS configuration setup program.

##### → Restore Defaults

Use the **Restore Defaults** option to load the optimal default values for each of the parameters on the Setup menus. **F3 key can be used for this operation.**

→ **Save as User Defaults**

Use the **Save as User Defaults** option to save the changes done so far as user defaults.

→ **Restore User Defaults**

Use the **Restore User Defaults** option to restore the user defaults to all the setup options.



Chapter

**5**

# Driver Installation

---

## 5.1 Available Drivers

All the drivers for the POCi-W22C-ULT5 are available on IEI Resource Download Center (<https://download.ieiworld.com>). Type POCi-W22C-ULT5, and press Enter to find all the relevant software, utilities, and documentation.

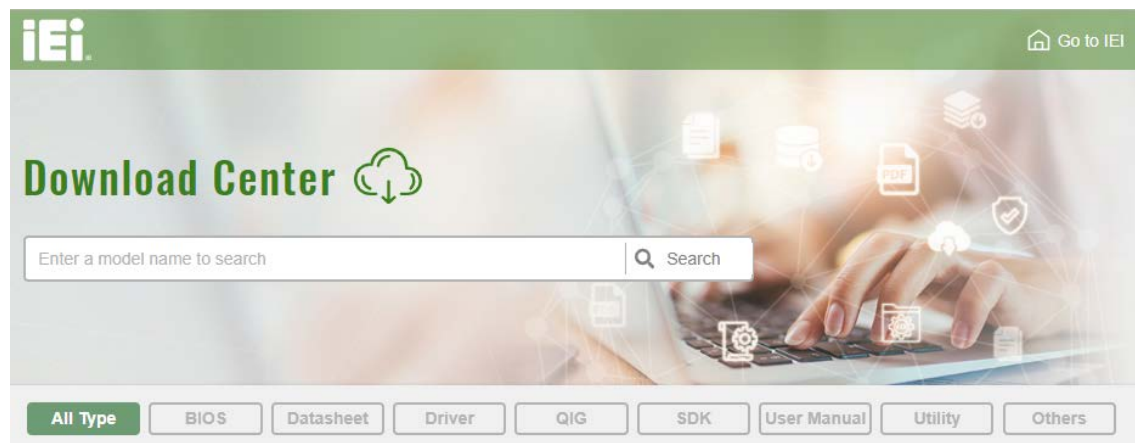
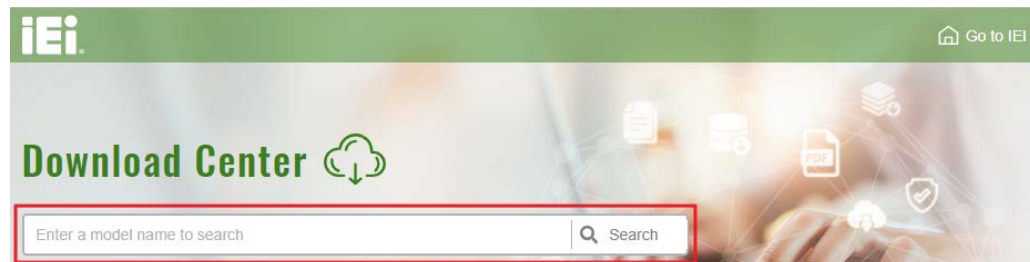

Figure 5-1: IEI Resource Download Center

## 5.2 Driver Download

To download drivers from IEI Resource Download Center, follow the steps below.

**Step 1:** Go to <https://download.ieiworld.com>. Type POCi-W22C-ULT5, and press Enter.



**Step 2:** All product-related software, utilities, and documentation will be listed. You can choose **Driver** to filter the result.

## POCi-W22C-ULT5 Medical Panel PC

[All Type](#)
[BIOS](#)
[Datasheet](#)
[Driver](#)
[QIG](#)
[SDK](#)
[User Manual](#)
[Utility](#)
[Others](#)

**WAFER-BT-i1** [Product Info](#)

[Embedded Computer](#) ▶ [Single Board Computer](#) ▶ [Embedded Board](#)  
 3.5" SBC with Intel® 22nm Atom™/Celeron® on-board SoC

Driver

File Name	Published	Version	File Checksum
<a href="#">7B000-001033-RS V2.3.iso (2.23 GB)</a>	2017/10/03	2.30	3B2DB1F792779A93A8F50DDBC3943E30

**Step 3:** Click the driver file name on the page and you will be prompted with the following window. You can download the entire ISO file (❶), or click the small arrow to find an individual driver and click the file name to download (❷).

7B000-001168-RS\_V1.4.iso

❶ [Click here to download entire ISO file. \(2.99 GB\)](#)

\* Download individual file \*

Docs  
 1.Chipset  
 10.1.1.12.zip (2.7 MB)  
 2.VGA  
 3.Audio  
 4.Lan  
 5.USB 3.0  
 6.Serial IO  
 7.TXE  
 8.Manual



### NOTE:

To install software from the downloaded ISO image file in Windows 8, 8.1 or 10, double-click the ISO file to mount it as a virtual drive to view its content.

Appendix

**A**

# Regulatory Compliance

---

**DECLARATION OF CONFORMITY**

This equipment is in conformity with the following EU directives:

- EMC Directive (2004/108/EC, 2014/30/EU)
- Low-Voltage Directive (2006/95/EC, 2014/35/EU)
- RoHS II Directive (2011/65/EU, 2015/863/EU)
- Medical Device Directive 93/42/EEC: EN 60601-1

If the user modifies and/or install other devices in the equipment, the CE conformity declaration may no longer apply.

If this equipment has telecommunications functionality, it also complies with the requirements of the Radio Equipment Directive 2014/53/EU.

---

English

IEI Integration Corp declares that this equipment is in compliance with the essential requirements and other relevant provisions of Directive 2014/53/EU.

---

Български [Bulgarian]

IEI Integration Corp. декларира, че този оборудване е в съответствие със съществените изисквания и другите приложими правила на Директива 2014/53/EU.

---

Česky [Czech]

IEI Integration Corp tímto prohlašuje, že tento zařizení je ve shodě se základními požadavky a dalšími příslušnými ustanoveními směrnice 2014/53/EU.

---

Dansk [Danish]

IEI Integration Corp erklærer herved, at følgende udstyr overholder de væsentlige krav og øvrige relevante krav i direktiv 2014/53/EU.

---

Deutsch [German]

IEI Integration Corp, erklärt dieses Gerät entspricht den grundlegenden Anforderungen und den weiteren entsprechenden Vorgaben der Richtlinie 2014/53/EU.

---

Eesti [Estonian]

IEI Integration Corp deklareerib seadme seadme vastavust direktiivi 2014/53/EÜ põhinõuetele ja nimetatud direktiivist tulenevatele teistele asjakohastele sätetele.

---

---

**Español [Spanish]**

IEI Integration Corp declara que el equipo cumple con los requisitos esenciales y cualesquiera otras disposiciones aplicables o exigibles de la Directiva 2014/53/EU.

---

**Ελληνική [Greek]**

IEI Integration Corp ΔΗΛΩΝΕΙ ΟΤΙ ΕΞΟΠΛΙΣΜΟΣ ΣΥΜΜΟΡΦΩΝΕΤΑΙ ΠΡΟΣ ΤΙΣ ΟΥΣΙΩΔΕΙΣ ΑΠΑΙΤΗΣΕΙΣ ΚΑΙ ΤΙΣ ΛΟΙΠΕΣ ΣΧΕΤΙΚΕΣ ΔΙΑΤΑΞΕΙΣ ΤΗΣ ΟΔΗΓΙΑΣ 2014/53/EU.

---

**Français [French]**

IEI Integration Corp déclare que l'appareil est conforme aux exigences essentielles et aux autres dispositions pertinentes de la directive 2014/53/EU.

---

**Italiano [Italian]**

IEI Integration Corp dichiara che questo apparecchio è conforme ai requisiti essenziali ed alle altre disposizioni pertinenti stabilite dalla direttiva 2014/53/EU.

---

**Latviski [Latvian]**

IEI Integration Corp deklarē, ka iekārta atbilst būtiskajām prasībām un citiem ar to saistītajiem noteikumiem Direktīvas 2014/53/EU.

---

**Lietuvių [Lithuanian]**

IEI Integration Corp deklaruoja, kad šis įranga atitinka esminius reikalavimus ir kitas 2014/53/EU Direktyvos nuostatas.

---

**Nederlands [Dutch]**

IEI Integrātion Corp dat het toestel toestel in overeenstemming is met de essentiële eisen en de andere relevante bepalingen van richtlijn 2014/53/EU.

---

**Malti [Maltese]**

IEI Integration Corp jiddikjara li dan prodott jikkonforma mal-ftigijiet essenzjali u ma provvedimenti oħrajn relevanti li hemm fid-Dirreċtiva 2014/53/EU.

---

**Magyar [Hungarian]**

IEI Integration Corp nyilatkozom, hogy a berendezés megfelel a vonatkozó alapvető követelményeknek és az 2014/53/EU irányelvégyéb előírásainak.

---

**Polski [Polish]**

IEI Integration Corp oświadcza, że wyrobu jest zgodny z zasadniczymi wymogami oraz pozostałymi stosownymi postanowieniami Dyrektywy 2014/53/EU.

---

**Português [Portuguese]**

IEI Integration Corp declara que este equipamento está conforme com os requisitos essenciais e outras disposições da Directiva 2014/53/EU.

---

## POCi-W22C-ULT5 Medical Panel PC

---

Româna [Romanian]

IEI Integration Corp declară că acest echipament este în conformitate cu cerințele esențiale și cu celelalte prevederi relevante ale Directivei 2014/53/EU.

---

Slovensko [Slovenian]

IEI Integration Corp izjavlja, da je ta opreme v skladu z bistvenimi zahtevami in ostalimi relevantnimi določili direktive 2014/53/EU.

---

Slovensky [Slovak]

IEI Integration Corp týmto vyhlasuje, že zariadenia spĺňa základné požiadavky a všetky príslušné ustanovenia Smernice 2014/53/EU.

---

Suomi [Finnish]

IEI Integration Corp vakuuttaa täten että laitteet on direktiivin 2014/53/EU oleellisten vaatimusten ja sitä koskevien direktiivin muiden ehtojen mukainen.

---

Svenska [Swedish]

IEI Integration Corp förklarar att denna utrustningstyp står i överensstämmelse med de väsentliga egenskapskrav och övriga relevanta bestämmelser som framgår av direktiv 2014/53/EU.

---

## FCC WARNING



This equipment complies with part 18 of the FCC Rules.

This equipment generates, uses and can radiate radio frequency energy and, if not installed and used in accordance with the instructions, may cause harmful interference to radio communications. However, there is no guarantee that interference will not occur in a particular installation. If this equipment does cause harmful interference to radio or television reception, which can be determined by turning the equipment off and on, the user is encouraged to try to correct the interference by one or more of the following measures:

- Reorient or relocate the receiving antenna.
- Increase the separation between the equipment and receiver.
- Connect the equipment into an outlet on a circuit different from that to which the receiver is connected.

**ROHS STATEMENT**

The label on the product indicates this product conforms to European (EU) Restriction of Hazardous Substances (RoHS) that set maximum concentration limits on hazardous materials used in electrical and electronic equipment.

**CHINA ROHS**

The label on the product indicates the estimated “Environmentally Friendly Use Period” (EFUP). This is an estimate of the number of years that these substances would “not leak out or undergo abrupt change.” This product may contain replaceable sub-assemblies/components which have a shorter EFUP such as batteries and lamps. These components will be separately marked.



Appendix

**B**

# Product Disposal

---

**CAUTION / ATTENTION**

Risk of explosion if battery is replaced by an incorrect type. Only certified engineers should replace the on-board battery.

Risque d'explosion si la batterie est remplacée par un type incorrect. Seuls les ingénieurs certifiés doivent remplacer la batterie embarquée.

Dispose of used batteries according to instructions and local regulations.

Jetez les piles usagées conformément aux instructions et aux réglementations locales.

---

- Outside the European Union - If you wish to dispose of used electrical and electronic products outside the European Union, please contact your local authority so as to comply with the correct disposal method.
- Within the European Union–The device that produces less waste and is easier to recycle is classified as electronic device in terms of the European Directive 2012/19/EU (WEEE), and must not be disposed of as domestic garbage.

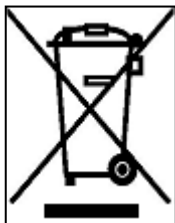

EU-wide legislation, as implemented in each Member State, requires that waste electrical and electronic products carrying the mark (left) must be disposed of separately from normal household waste. This includes monitors and electrical accessories, such as signal cables or power cords. When you need to dispose of your display products, please follow the guidance of your local authority, or ask the shop where you purchased the product. The mark on electrical and electronic products only applies to the current European Union Member States.

Please follow the national guidelines for electrical and electronic product disposal.

Appendix

**C**

# Maintenance and Cleaning Precautions

---

When maintaining or cleaning the POCi-W22C-ULT5, please follow the guidelines below.



### **WARNING / AVERTISSEMENT**

If you dropped any material or liquid such as water onto the panel PC when cleaning, unplug the power cable immediately and contact your dealer or the nearest service center. Always make sure your hands are dry when unplugging the power cable.

Si vous avez fait tomber du matériel ou du liquide tel que de l'eau sur le Panel PC lors du nettoyage, débranchez immédiatement le câble d'alimentation et contactez votre revendeur ou le centre de service le plus proche. Assurez-vous toujours que vos mains sont sèches lorsque vous débranchez le câble d'alimentation.



### **CAUTION / ATTENTION**

- For safety reasons, turn-off the power switch and unplug the panel PC before cleaning.  
Pour des raisons de sécurité, éteignez l'interrupteur d'alimentation et débranchez le Panel PC avant de le nettoyer.
  - Do not scratch or rub the screen with a hard object.  
Ne rayez pas et ne frottez pas l'écran avec un objet dur.
  - Never use any of the following solvents on the medical panel PC. Harsh chemicals may cause damage to the cabinet and the touch sensor.  
N'utilisez jamais l'un des solvants suivants sur le Panel PC médical. Les produits chimiques agressifs peuvent endommager le boîtier et le capteur tactile.  
**Thinner Spray-type cleaner, Benzene, Wax, Abrasive cleaner, Acid or Alkaline solvent.**  
**Diluant nettoyant de type spray, benzène, cire, nettoyant abrasif, solvant acide ou alcalin.**
-

## POCi-W22C-ULT5 Medical Panel PC

### C.1.1 Maintenance and Cleaning

Prior to cleaning any part or component of the POCi-W22C-ULT5, please read the details below.

- To clean the POCi-W22C-ULT5,
  - remove dirt with a lightly moistened cloth. Then wipe the external chassis with a soft dry cloth.
  - use 75% ethanol alcohol to clean the external chassis.
- Cleaning frequency: follow the cleaning method guidelines of the hospital.
- Except for the LCD panel, never spray or squirt liquids directly onto any other components.
- The interior of the POCi-W22C-ULT5 does not require cleaning. Keep fluids away from the POCi-W22C-ULT5 interior.
- Never drop any objects or liquids through the openings of the POCi-W22C-ULT5.

### C.1.2 Cleaning Tools

Some components in the POCi-W22C-ULT5 may only be cleaned using a product specifically designed for the purpose. In such case, the product will be explicitly mentioned in the cleaning tips. Below is a list of items to use when cleaning the POCi-W22C-ULT5.

- **Cloth** – Although paper towels or tissues can be used, a soft, clean piece of cloth is recommended when cleaning the POCi-W22C-ULT5.
- **Water/Ethanol alcohol** – A cloth moistened with water or 75% ethanol alcohol can be used to clean the POCi-W22C-ULT5.
- **Using solvents** – The use of solvents is not recommended when cleaning the POCi-W22C-ULT5 as they may damage the plastic parts.
- **Cotton swabs** - Cotton swabs moistened with water are excellent tools for wiping hard to reach areas.
- **Foam swabs** - Whenever possible, it is best to use lint free swabs such as foam swabs for cleaning.

Appendix











**D**

# Symbol Definitions

---

## POCi-W22C-ULT5 Medical Panel PC

The following symbols appear on the product, its labeling, or the product packing. Each symbol carries a special definition, as defined below:

	Direct current		Fragile, handle with care
	This side up		Keep dry
	Consult the operating instructions		Refer to instruction manual
	Indicates the manufacturer		
	Indicates proof of conformity to applicable European Economic Community Council directives and to harmonized standards published in the official journal of the European Communities.		
	Tested to comply with FCC Class B standard.		
	This symbol indicates that the waste of electronic equipment must not be disposed as unsorted municipal waste and must be collected separately. Please contact the manufacturer or other authorized disposal company to decommission your equipment.		
	This product is recyclable.		

Appendix

**E**

# BIOS Menu Options

---



## POCi-W22C-ULT5 Medical Panel PC

<input type="checkbox"/>	System Date [xx/xx/xx].....	32
<input type="checkbox"/>	System Time [xx:xx:xx].....	33
<input type="checkbox"/>	Intel (VMX) Virtualization Technology [Disabled].....	34
<input type="checkbox"/>	Active Processor Cores [All] .....	35
<input type="checkbox"/>	Hyper-Threading [Enabled].....	35
<input type="checkbox"/>	Intel® SpeedStep(tm) [Enabled].....	35
<input type="checkbox"/>	CPU C State [Disabled].....	35
<input type="checkbox"/>	AMT BIOS Features [Enabled].....	36
<input type="checkbox"/>	Unconfigure ME [Disabled].....	36
<input type="checkbox"/>	TPM Device Selection [dTPM (If supported)] .....	37
<input type="checkbox"/>	Security Device Support [Disable].....	38
<input type="checkbox"/>	ACPI Sleep State [S3 (Suspend to RAM)].....	39
<input type="checkbox"/>	Wake System with Fixed Time [Disabled] .....	40
<input type="checkbox"/>	PC Health Status .....	41
<input type="checkbox"/>	Serial Port [Enabled].....	43
<input type="checkbox"/>	Console Redirection [Disabled] .....	43
<input type="checkbox"/>	Terminal Type [ANSI].....	44
<input type="checkbox"/>	Bits per second [115200].....	44
<input type="checkbox"/>	Data Bits [8] .....	45
<input type="checkbox"/>	Parity [None].....	45
<input type="checkbox"/>	Stop Bits [1].....	45
<input type="checkbox"/>	Legacy Serial Redirection Port [COM1].....	46
<input type="checkbox"/>	USB Devices .....	47
<input type="checkbox"/>	Legacy USB Support [Enabled].....	47
<input type="checkbox"/>	CSM Support [Enabled].....	48
<input type="checkbox"/>	VT-d [Disabled].....	50
<input type="checkbox"/>	Internal Graphics [Enabled].....	52
<input type="checkbox"/>	DVMT Pre-Allocated [32M] .....	52
<input type="checkbox"/>	DVMT Total Gfx Mem [MAX].....	53
<input type="checkbox"/>	Primary IGFX Boot Display [VBIOS Default] .....	53
<input type="checkbox"/>	Power Saving Function(ERP) [Disabled].....	54
<input type="checkbox"/>	USB Power SW [+5V DUAL].....	54
<input type="checkbox"/>	HD Audio [Enabled] .....	54
<input type="checkbox"/>	PCIE1 / M1 / M2_M1 [Enabled] .....	55
<input type="checkbox"/>	PCIe Speed [Auto].....	55

<input type="checkbox"/>	Detect Non-Compliance Device [Disabled] .....	56
<input type="checkbox"/>	STAT Controller(s) [Enabled].....	56
<input type="checkbox"/>	SATA Mode Selection [AHCI].....	57
<input type="checkbox"/>	PCIe Storage Dev On Port M2_M1 [Not RST Controlled].....	57
<input type="checkbox"/>	Administrator Password .....	58
<input type="checkbox"/>	User Password .....	58
<input type="checkbox"/>	Bootup NumLock State [On].....	59
<input type="checkbox"/>	Quiet Boot [Enabled] .....	60
<input type="checkbox"/>	Launch PXE OpROM [Disabled].....	60
<input type="checkbox"/>	Option ROM Messages [Force BIOS].....	60
<input type="checkbox"/>	UEFI Boot [Disabled] .....	60
<input type="checkbox"/>	Boot Option Priority.....	60
<input type="checkbox"/>	Save Changes and Reset .....	61
<input type="checkbox"/>	Discard Changes and Reset .....	61
<input type="checkbox"/>	Restore Defaults .....	61
<input type="checkbox"/>	Save as User Defaults .....	62
<input type="checkbox"/>	Restore User Defaults .....	62

Appendix

**F**

# Watchdog Timer

---



**NOTE:**

The following discussion applies to DOS. Contact IEI support or visit the IEI website for drivers for other operating systems.

The Watchdog Timer is a hardware-based timer that attempts to restart the system when it stops working. The system may stop working because of external EMI or software bugs. The Watchdog Timer ensures that standalone systems like ATMs will automatically attempt to restart in the case of system problems.

A BIOS function call (INT 15H) is used to control the Watchdog Timer.

INT 15H:

<b>AH – 6FH Sub-function:</b>	
AL – 2:	Sets the Watchdog Timer's period.
BL:	Time-out value (Its unit-second is dependent on the item "Watchdog Timer unit select" in CMOS setup).

**Table F-1: AH-6FH Sub-function**

Call sub-function 2 to set the time-out period of Watchdog Timer first. If the time-out value is not zero, the Watchdog Timer starts counting down. When the timer value reaches zero, the system resets. To ensure that this reset condition does not occur, calling sub-function 2 must periodically refresh the Watchdog Timer. However, the watchdog timer is disabled if the time-out value is set to zero.

A tolerance of at least 10% must be maintained to avoid unknown routines within the operating system (DOS), such as disk I/O that can be very time-consuming.

## POCi-W22C-ULT5 Medical Panel PC

**NOTE:**

The Watchdog Timer is activated through software. The software application that activates the Watchdog Timer must also deactivate it when closed. If the Watchdog Timer is not deactivated, the system will automatically restart after the Timer has finished its countdown.

**EXAMPLE PROGRAM:**

**; INITIAL TIMER PERIOD COUNTER**

;

**W\_LOOP:**

;

```

MOV     AX, 6F02H      ;setting the time-out value
MOV     BL, 30         ;time-out value is 48 seconds
INT     15H

```

;

**; ADD THE APPLICATION PROGRAM HERE**

;

```

CMP     EXIT_AP, 1     ;is the application over?
JNE     W_LOOP        ;No, restart the application

MOV     AX, 6F02H      ;disable Watchdog Timer
MOV     BL, 0         ;
INT     15H

```

;

**; EXIT ;**

Appendix

**G**

# **Hazardous Materials Disclosure**

---

## POCi-W22C-ULT5 Medical Panel PC

### G.1 RoHS II Directive (2015/863/EU)

The details provided in this appendix are to ensure that the product is compliant with the RoHS II Directive (2015/863/EU). The table below acknowledges the presences of small quantities of certain substances in the product, and is applicable to RoHS II Directive (2015/863/EU).

Please refer to the following table.

Part Name	Toxic or Hazardous Substances and Elements									
	Lead (Pb)	Mercury (Hg)	Cadmium (Cd)	Hexavalent Chromium (CR(VI))	Polybrominated Biphenyls (PBB)	Polybrominated Diphenyl Ethers (PBDE)	Bis(2-ethylhexyl) phthalate (DEHP)	Butyl benzyl phthalate (BBP)	Dibutyl phthalate (DBP)	Diisobutyl phthalate (DIBP)
Housing	O	O	O	O	O	O	O	O	O	O
Display	O	O	O	O	O	O	O	O	O	O
Printed Circuit Board	O	O	O	O	O	O	O	O	O	O
Metal Fasteners	O	O	O	O	O	O	O	O	O	O
Cable Assembly	O	O	O	O	O	O	O	O	O	O
Fan Assembly	O	O	O	O	O	O	O	O	O	O
Power Supply Assemblies	O	O	O	O	O	O	O	O	O	O
Battery	O	O	O	O	O	O	O	O	O	O

O: This toxic or hazardous substance is contained in all of the homogeneous materials for the part is below the limit requirement in Directive (EU) 2015/863.

X: This toxic or hazardous substance is contained in at least one of the homogeneous materials for this part is above the limit requirement in Directive (EU) 2015/863.

## G.2 China RoHS

此附件旨在确保本产品符合中国 RoHS 标准。以下表格标示此产品中某有毒物质的含量符合中国 RoHS 标准规定的限量要求。

本产品上会附有“环境友好使用期限”的标签，此期限是估算这些物质“不会有泄漏或突变”的年限。本产品可能包含有较短的环境友好使用期限的可替换元件，像是电池或灯管，这些元件将会单独标示出来。

部件名称	有毒有害物质或元素					
	铅 (Pb)	汞 (Hg)	镉 (Cd)	六价铬 (CR(VI))	多溴联苯 (PBB)	多溴二苯醚 (PBDE)
壳体	○	○	○	○	○	○
显示	○	○	○	○	○	○
印刷电路板	○	○	○	○	○	○
金属螺帽	○	○	○	○	○	○
电缆组装	○	○	○	○	○	○
风扇组装	○	○	○	○	○	○
电力供应组装	○	○	○	○	○	○
电池	○	○	○	○	○	○
<p>○: 表示该有毒有害物质在该部件所有物质材料中的含量均在 SJ/T11364-2014 與 GB/T26572-2011 标准规定的限量要求以下。</p> <p>X: 表示该有毒有害物质至少在该部件的某一均质材料中的含量超出 SJ/T11364-2014 與 GB/T26572-2011 标准规定的限量要求。</p>						