



MODEL:  
**PUZZLE-IN001A**

**1U Network Appliance with 8th Gen. Intel® Core™ i3, Pentium®, Celeron® and Intel® Xeon® E Processor, DDR4, Eight 5GbE Ports, Two PCIe Slots, M.2, PCIe Mini, Redundant PSU, Rack Mount, and RoHS Compliant**

## User Manual

# Revision

---

Date	Version	Changes
November 12, 2020	1.01	Modified Table 3-2: RJ-45 Ethernet Connector LEDs
November 6, 2020	1.00	Initial release

# Copyright

---

## **COPYRIGHT NOTICE**

The information in this document is subject to change without prior notice in order to improve reliability, design and function and does not represent a commitment on the part of the manufacturer.

In no event will the manufacturer be liable for direct, indirect, special, incidental, or consequential damages arising out of the use or inability to use the product or documentation, even if advised of the possibility of such damages.

This document contains proprietary information protected by copyright. All rights are reserved. No part of this manual may be reproduced by any mechanical, electronic, or other means in any form without prior written permission of the manufacturer.

## **TRADEMARKS**

All registered trademarks and product names mentioned herein are used for identification purposes only and may be trademarks and/or registered trademarks of their respective owners.

# Manual Conventions

---



## **WARNING**

Warnings appear where overlooked details may cause damage to the equipment or result in personal injury. Warnings should be taken seriously.



## **CAUTION**

Cautionary messages should be heeded to help reduce the chance of losing data or damaging the product.



## **NOTE**

These messages inform the reader of essential but non-critical information. These messages should be read carefully as any directions or instructions contained therein can help avoid making mistakes.

# Table of Contents

<b>1 INTRODUCTION.....</b>	<b>1</b>
1.1 OVERVIEW.....	2
1.2 MODEL VARIATIONS .....	2
1.3 FEATURES.....	3
1.4 FRONT PANEL.....	3
1.5 REAR PANEL.....	4
1.6 TECHNICAL SPECIFICATIONS .....	4
1.6.1 <i>Expansion Slot Block Diagram</i> .....	6
1.7 DIMENSIONS.....	7
<b>2 UNPACKING .....</b>	<b>8</b>
2.1 ANTI-STATIC PRECAUTIONS .....	9
2.2 UNPACKING PRECAUTIONS.....	9
2.3 PACKING LIST.....	10
2.4 OPTIONAL ITEMS .....	11
<b>3 INSTALLATION .....</b>	<b>12</b>
3.1 INSTALLATION PRECAUTIONS .....	13
3.2 TOP COVER REMOVAL .....	14
3.3 DIMM INSTALLATION .....	15
3.4 HDD INSTALLATION.....	16
3.5 PCIe EXPANSION CARD INSTALLATION .....	18
3.6 IEI NETWORKING MODULE INSTALLATION .....	21
3.6.1 <i>Bypass Configuration in BIOS</i> .....	23
3.7 M.2 MODULE INSTALLATION.....	24
3.8 PCIe MINI CARD INSTALLATION .....	25
3.8.1 <i>Half-size PCIe Mini Card Installation</i> .....	26
3.9 LAN CONNECTION.....	27
3.10 CONSOLE CONNECTION.....	28
3.10.1 <i>Enable Console Port When Booting</i> .....	28
3.11 RACK MOUNT .....	31



3.12 POWER-ON PROCEDURE.....	32
3.13 RESOURCE DOWNLOAD.....	33
3.14 MAINTENANCE.....	33
3.14.1 Power Supply Unit Replacement .....	34
3.14.2 Jumper Settings.....	35
3.14.2.1 Clear CMOS.....	35
3.14.2.2 Flash Descriptor Security Override Jumper.....	36
<b>4 BIOS .....</b>	<b>38</b>
4.1 INTRODUCTION.....	39
4.1.1 Starting Setup.....	39
4.1.2 Using Setup .....	39
4.1.3 Getting Help.....	40
4.1.4 Unable to Reboot after Configuration Changes .....	40
4.1.5 BIOS Menu Bar.....	40
4.2 MAIN.....	41
4.3 ADVANCED.....	42
4.3.1 CPU Configuration .....	43
4.3.2 Trusted Computing.....	45
4.3.3 iWDD H/W Monitor.....	46
4.3.3.1 Smart Fan Mode Configuration .....	47
4.3.4 IT8528 Super IO Configuration.....	49
4.3.4.1 Serial Port 1 Configuration .....	49
4.3.5 Serial Port Console Redirection .....	50
4.3.5.1 Legacy Console Redirection Settings .....	52
4.3.6 NVMe Configuration.....	53
4.4 CHIPSET .....	54
4.4.1 System Agent (SA) Configuration .....	55
4.4.1.1 Memory Configuration .....	56
4.4.1.2 Graphics Configuration.....	56
4.4.1.3 PEG Port Configuration.....	58
4.4.2 PCH-IO Configuration .....	59
4.4.2.1 PCI Express Configuration .....	60
4.4.2.2 SATA and RST Configuration.....	62
4.4.2.3 Network Configuration (Bypass Setting).....	64

**PUZZLE-IN001A**

4.5 SECURITY.....	65
4.6 BOOT.....	66
4.7 SAVE & EXIT .....	68
<b>5 INTERFACE CONNECTORS .....</b>	<b>69</b>
5.1 PERIPHERAL INTERFACE CONNECTORS.....	70
5.2 INTERNAL PERIPHERAL CONNECTORS .....	71
5.2.1 ATX Power Connector (ATX1).....	72
5.2.2 ATX PSU SMBus Connector (CN3).....	72
5.2.3 CPU Power Connector (CPU12V1).....	73
5.2.4 Chassis Intrusion Connector (CHASSIS1).....	73
5.2.5 Fan Connectors (CPU_FAN1/2/3, SYS_FAN1) .....	73
5.2.6 LCM Connector (CN2) .....	73
5.2.7 M.2 Slot (M2_1).....	74
5.2.8 PCIe Mini Card Slot (MPCIE1).....	75
5.2.9 Power Button Connector (PWR_BTN2) .....	76
5.2.10 Reset Button Connector (RST_BTN1).....	76
5.2.11 SATA Connector (PCIEX1_SLOT1).....	77
5.2.12 SPI Flash Connector (JSPI1).....	77
5.2.13 SPI Flash Connector - EC (JSPI2).....	78
5.2.14 TPM Connector (TPM1).....	78
5.2.15 USB 2.0 Connector (USB1) .....	79
5.2.16 IEI Networking Module Slot A.....	79
5.2.17 IEI Networking Module Slot B.....	81
<b>A REGULATORY COMPLIANCE .....</b>	<b>83</b>
<b>B SAFETY PRECAUTIONS .....</b>	<b>88</b>
B.1 SAFETY PRECAUTIONS.....	89
B.1.1 General Safety Precautions.....	89
B.1.2 Anti-static Precautions .....	90
B.1.3 Product Disposal.....	91
B.2 MAINTENANCE AND CLEANING PRECAUTIONS .....	92
B.2.1 Maintenance and Cleaning.....	92
B.2.2 Cleaning Tools.....	92
<b>C ERROR BEEP CODE .....</b>	<b>93</b>

C.1 PEI BEEP CODES .....	94
C.2 DXE BEEP CODES .....	94
<b>D HAZARDOUS MATERIALS DISCLOSURE .....</b>	<b>95</b>
D.1 RoHS II DIRECTIVE (2015/863/EU) .....	96
D.2 CHINA RoHS.....	97



# List of Figures

Figure 1-1: PUZZLE-IN001A Series .....	2
Figure 1-2: PUZZLE-IN001A Front Panel .....	3
Figure 1-3: PUZZLE-IN001A Rear Panel .....	4
Figure 1-4: Expansion Slot Block Diagram .....	6
Figure 1-5: Physical Dimensions (millimeters).....	7
Figure 3-1: Top Cover Removal .....	14
Figure 3-2: DIMM Slot Locations.....	15
Figure 3-3: HDD Bracket Retention Screws.....	16
Figure 3-4: Secure HDD to the Bracket .....	17
Figure 3-5: HDD Installation .....	17
Figure 3-6: Expansion Slot Module Retention Screws .....	18
Figure 3-7: Disconnect the Expansion Slot Module.....	19
Figure 3-8: Blank Bracket Screw.....	19
Figure 3-9: PCIe Expansion Card Installation.....	20
Figure 3-10: Expansion Slot Module Installation .....	21
Figure 3-11: Networking Module Slot Cover Screws .....	22
Figure 3-12: Networking Module Installation.....	22
Figure 3-13: PCIe Mini Slot Location .....	26
Figure 3-14: RJ-45 Ethernet Connector.....	27
Figure 3-15: Rack Mount Bracket Installation .....	31
Figure 3-16: IEI Resource Download Center.....	33
Figure 3-17: Clear CMOS Button Location.....	36
Figure 3-18: Flash Descriptor Security Override Jumper Location .....	37

# List of Tables

---

Table 1-1: PUZZLE-IN001A Model Variations .....	2
Table 1-2: Technical Specifications.....	6
Table 3-1: LAN Pinouts .....	27
Table 3-2: RJ-45 Ethernet Connector LEDs .....	27
Table 3-3: RJ-45 Console Port Pinouts .....	28
Table 3-4: Flash Descriptor Security Override Jumper Settings.....	36
Table 4-1: BIOS Navigation Keys .....	40
Table 5-1: Peripheral Interface Connectors .....	71
Table 5-2: ATX Power Connector Pinouts .....	72
Table 5-3: ATX PSU SMBus Connector (CN3) Pinouts.....	72
Table 5-4: CPU Power Connector (CPU12V1) Pinouts.....	73
Table 5-5: Chassis Intrusion Connector (CHASSIS1) Pinouts.....	73
Table 5-6: Fan Connectors (CPU_FAN1/2/3, SYS_FAN1) Pinouts.....	73
Table 5-7: LCM Connector (CN2) Pinouts .....	74
Table 5-8: M.2 Slot (M2_1) Pinouts .....	75
Table 5-9: PCIe Mini Card Slot (MPCIE1) Pinouts .....	76
Table 5-10: Power Button Connector (PWR_BTN2) Pinouts.....	76
Table 5-11: Reset Button Connector (RST_BTN1) Pinouts.....	76
Table 5-12: SATA 6Gb/s Connector (PCIEX1_SLOT1) Pinouts.....	77
Table 5-13: SPI Flash Connector (JSPI1) Pinouts .....	77
Table 5-14: SPI Flash Connector - EC (JSPI2) Pinouts.....	78
Table 5-15: TPM Connector (TPM1) Pinouts.....	78
Table 5-16: USB 2.0 Connector (USB1) Pinouts.....	79
Table 5-17: IEI Networking Module Slot A Pinouts .....	80
Table 5-18: IEI Networking Module Slot B Pinouts .....	82
Table 5-19: PCIe Link Configuration.....	82

Chapter

1

# Introduction

---

## 1.1 Overview



**Figure 1-1: PUZZLE-IN001A Series**

The PUZZLE-IN001A is a 1 U network appliance series powered by the 8th generation Intel® Xeon®, Core™ i3, Pentium® or Celeron® processor. It is optimized to host VNFs (Virtual Network Functions) and is ideal for SD-WAN.

The PUZZLE-IN001A supports 8 copper 5GbE ports for high-speed network applications, and it is equipped with a PCIe 3.0 x8 slot and a PCIe 3.0 x4 slot for upgrading with expansion cards, such as NIC cards or accelerator cards. Multiple storage interfaces for fast and stable data transmission are offered through two SATA 6Gb/s connectors and one PCIe Mini slot that supports mSATA module.



### **WARNING:**

This equipment is not suitable for use in locations where children are likely to be present.

## 1.2 Model Variations

The model variations of the PUZZLE-IN001A are listed below.

PUZZLE-IN001A	CPU	Memory	SSD
-i3T/R	Intel® Core™ i3-8100T	N/A	N/A
-i3T/16G/R	Intel® Core™ i3-8100T	16 GB	256 GB
-XE/R	Intel® Xeon® E-2136	N/A	N/A
-XE/16G/R	Intel® Xeon® E-2136	16 GB	256 GB

**Table 1-1: PUZZLE-IN001A Model Variations**

## PUZZLE-IN001A

### 1.3 Features

The PUZZLE-IN001A features are listed below:

- Powered by 8th gen. Intel® Xeon®, Core™ i3, Pentium® or Celeron® processor
- Support four 2400 MHz DDR4 ECC/non-ECC RDIMMs (system max. 64 GB)
- Support two 2.5" SATA SSD/HDD
- Support up to eight 5GbE connections via Aquantia AQC111C controllers
- Upgradable with future expansion cards by one PCIe 3.0 x8 slot, one PCIe 3.0 x4 slot, one M.2 B-key slot and one PCIe Mini card slot
- One RJ-45 console port
- Supports two USB 3.2 Gen 1 (5 Gb/s) ports
- 1U chassis for rack mounting
- RoHS compliant

### 1.4 Front Panel

The overview of the front panel is shown in **Figure 1-2**.

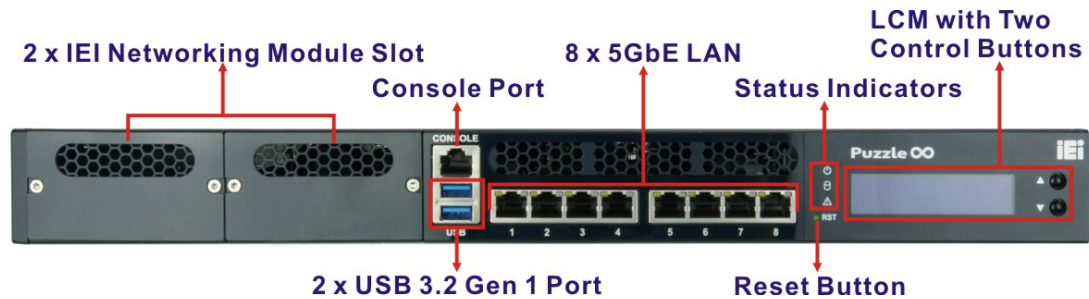

**Figure 1-2: PUZZLE-IN001A Front Panel**

The states of the LED indicators located on the front panel are listed below.

<b>Power LED</b>	Off	The system is turned off.
	Blue	The system is turned on.
<b>HDD Status LED</b>	Off	No HDD activity
	Blinking Green	HDD activity
<b>Alert LED</b>	Off	No alert
	Red	Alert message



## 1.5 Rear Panel

An overview of the PUZZLE-IN001A rear panel is shown in **Figure 1-3** below.

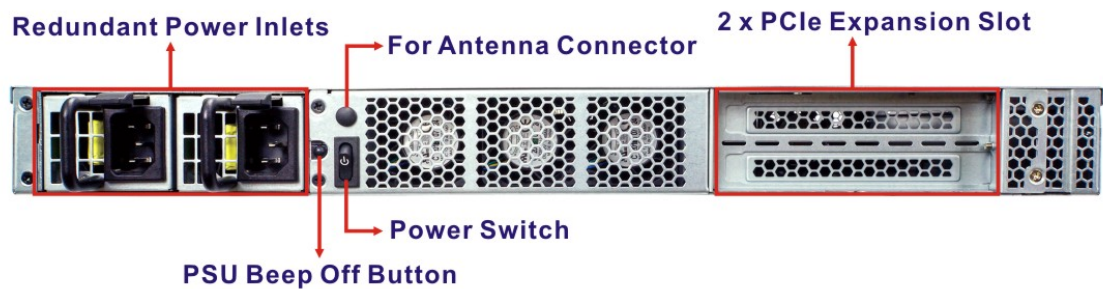

**Figure 1-3: PUZZLE-IN001A Rear Panel**

## 1.6 Technical Specifications

The PUZZLE-IN001A technical specifications are listed in **Table 1-2**.

System	
<b>Form Factor</b>	1U
<b>CPU (SoC)</b>	8 <sup>th</sup> gen Intel® Xeon®, Core™ i3, Pentium® or Celeron® processor <b>XE SKU:</b> 8 <sup>th</sup> gen Intel® Xeon® E-2136 processor <b>i3T SKU:</b> 8 <sup>th</sup> gen Intel® Core™ i3-8100T processor
<b>Chipset</b>	Intel® C246
<b>Memory</b>	Four 288-pin 2400 MHz DDR4 ECC/non-ECC RDIMM slots (system max. 64 GB) (16G SKUs are pre-installed with two 8 GB memory modules)
<b>Networking</b>	Aquantia AQC111C Ethernet controller 8 x Copper 5GbE LAN port 2 x PCIe slot for IEI networking module (Slot A & Slot B)
<b>Network Acceleration and Security</b>	Intel® AES New Instructions Intel® Software Guard Extensions (Intel® SGX) Intel® Memory Protection Extensions (Intel® MPX) Intel® Trusted Execution Technology
<b>Storage</b>	2 x 2.5" SATA 6Gb/s HDD/SSD bay

## PUZZLE-IN001A

Expansion	
<b>PCIe</b>	1 x PCIe 3.0 x4 slot (FHHL) 1 x PCIe 3.0 x8 slot (FHHL)
<b>PCIe Mini</b>	1 x Full-size/Half-size PCIe Mini slot (PCIe 3.0 & SATA 6Gb/s, USB 2.0)
<b>M.2</b>	1 x M.2 B-key 3042/2260 slot (SATA 3.0 / USB 3.2 Gen1) Support SATA SSD and 4G LTE module
I/O and Indicators	
<b>Console</b>	1 x RJ-45
<b>USB</b>	2 x USB 3.2 Gen 1 (5 Gb/s) port (external) 4 x USB 2.0 internal pin-header (8-pin, p=2.54)
<b>Indicator</b>	LCM (with two control buttons) Power status (blue) HDD status (green) Alert LED (programmable, red)
<b>Switch/Button</b>	Power switch (rear panel) Reset button (front panel)
<b>TPM</b>	1 x TPM 2.0 (2x10 pin header)
<b>Antenna Connector</b>	1 x Knockout hole for antenna connector
Power	
<b>Power Input</b>	100 V ~ 240 V, 5 A ~ 2.5 A, 60 Hz ~ 50 Hz
<b>Type/Watt</b>	300 W redundant power
<b>Thermal Solution</b>	1 x Passive heat sink for CPU 3 x Smart fan for CPU 1 x Smart fan for system
Environmental and Mechanical	
<b>Mounting</b>	1U rack mount
<b>Operating Temperature</b>	0°C~40°C (32°F~104°F)
<b>Storage Temperature</b>	-20°C~75°C (-4°F~167°F)
<b>Operating Humidity</b>	5%~90%, non-condensing

<b>Safety</b>	CE, FCC
<b>Weight</b>	7 kg
<b>Physical Dimensions</b>	430 mm x 426 mm x 44.2 mm (W x D x H)
<b>Operating System</b>	Linux Ubuntu 18.04.04 / CentOS 7 / Red Hat / Fedora EPEL / Microsoft Windows 10

**Table 1-2: Technical Specifications**

### 1.6.1 Expansion Slot Block Diagram

The block diagram of the expansion slots is shown below:

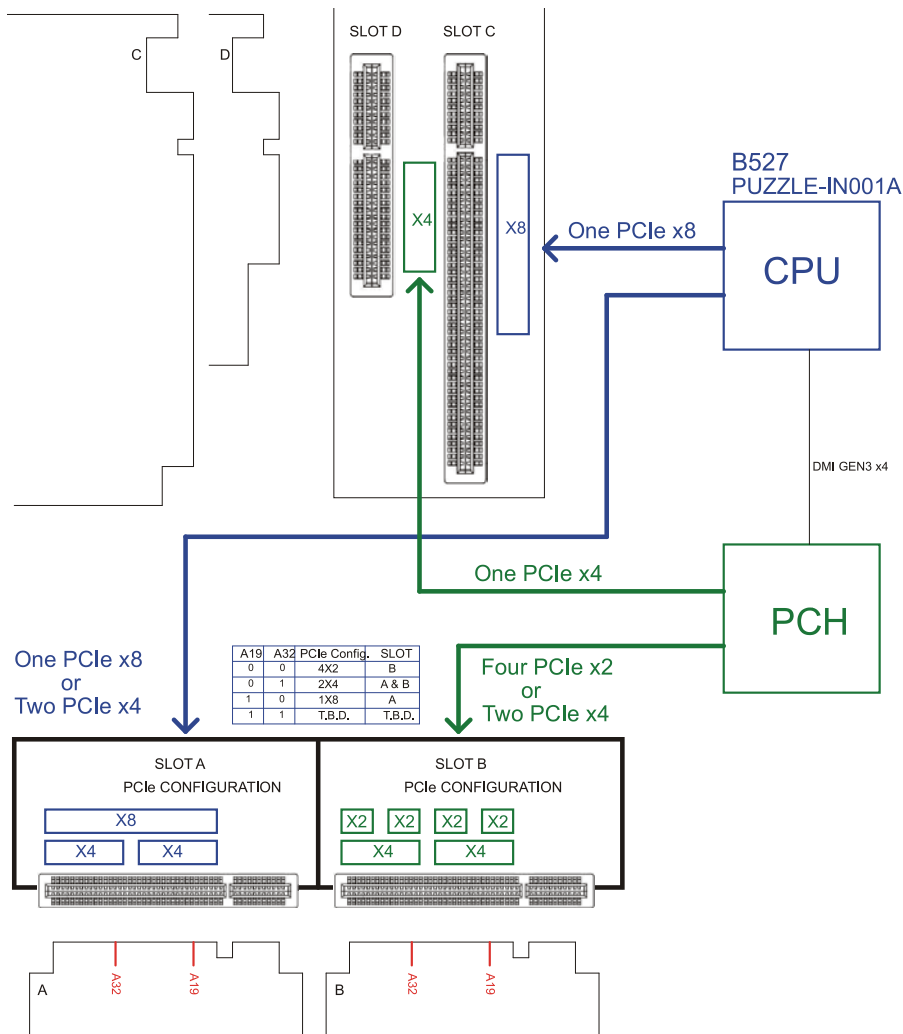

**Figure 1-4: Expansion Slot Block Diagram**

# PUZZLE-IN001A

## 1.7 Dimensions

The physical dimensions are shown below:

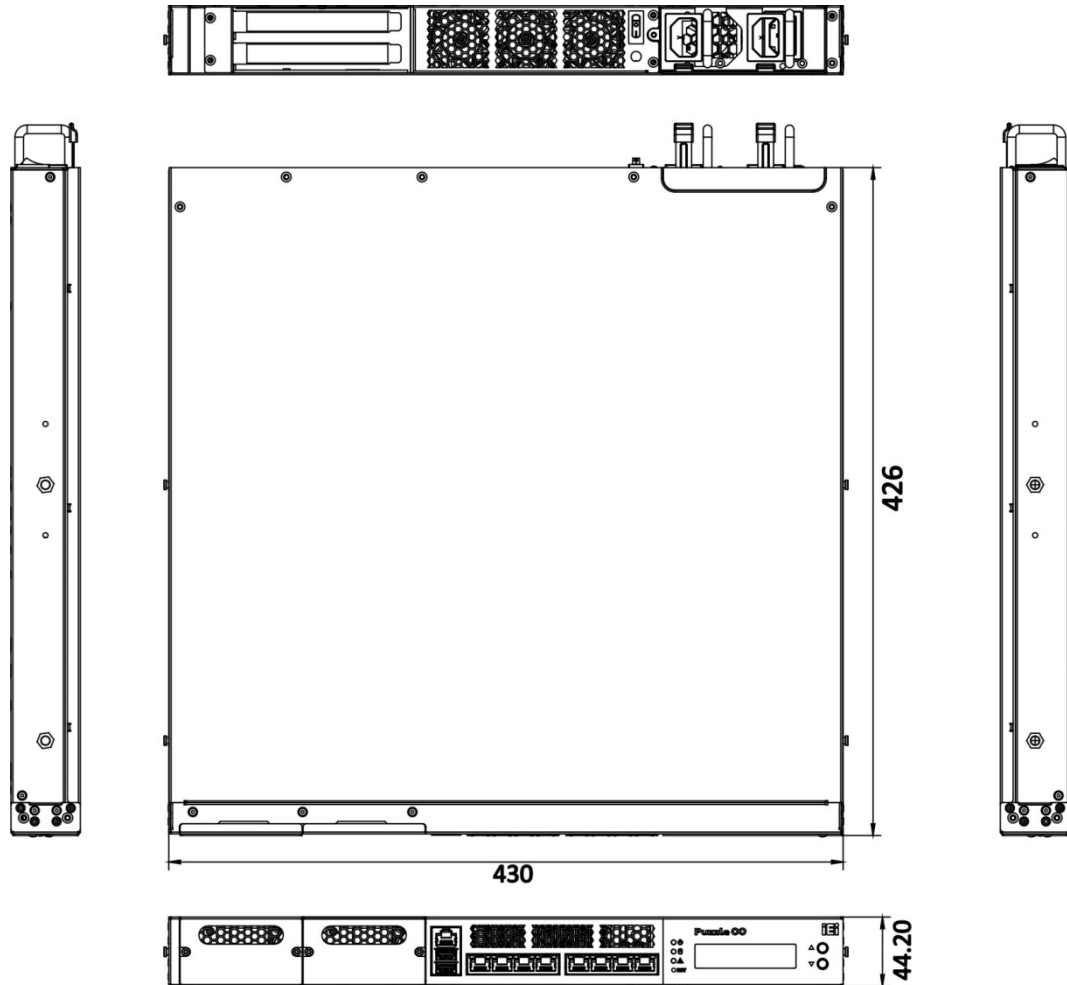

Figure 1-5: Physical Dimensions (millimeters)

Chapter

**2**

# Unpacking

---



## PUZZLE-IN001A

### 2.1 Anti-static Precautions

---



#### **WARNING:**

Failure to take ESD precautions during installation may result in permanent damage to the PUZZLE-IN001A and severe injury to the user.

---

Electrostatic discharge (ESD) can cause serious damage to electronic components, including the PUZZLE-IN001A. Dry climates are especially susceptible to ESD. It is therefore critical that whenever the PUZZLE-IN001A or any other electrical component is handled, the following anti-static precautions are strictly adhered to.

- ***Wear an anti-static wristband:*** Wearing a simple anti-static wristband can help to prevent ESD from damaging the board.
- ***Self-grounding:*** Before handling the board, touch any grounded conducting material. During the time the board is handled, frequently touch any conducting materials that are connected to the ground.
- ***Use an anti-static pad:*** When configuring the PUZZLE-IN001A, place it on an anti-static pad. This reduces the possibility of ESD damaging the PUZZLE-IN001A.

### 2.2 Unpacking Precautions

When the PUZZLE-IN001A is unpacked, please do the following:

- Follow the anti-static precautions outlined in **Section 2.1**.
- Make sure the packing box is facing upwards so the PUZZLE-IN001A does not fall out of the box.
- Make sure all the components shown in **Section 2.3** are present.







## 2.3 Packing List



**NOTE:**

If some of the components listed in the checklist below are missing, please do not proceed with the installation. Contact the IEI reseller or vendor you purchased the PUZZLE-IN001A from or contact an IEI sales representative directly. To contact an IEI sales representative, please send an email to [sales@ieiworld.com](mailto:sales@ieiworld.com).





The PUZZLE-IN001A is shipped with the following components:

Quantity	Item	Image
1	PUZZLE-IN001A	
2	Power cord	
2	Rack mount brackets <i>(Note: The brackets must be used with sliding rails.)</i>	
6	Mounting bracket screw (M4*6)	
1	USB to console cable <i>(only for SKUs with memory)</i>	
1	RS-232 to console cable <i>(only for SKUs without memory)</i>	

## PUZZLE-IN001A

### 2.4 Optional Items

The following table lists the optional items that can be purchased separately.

Optional Item	Image
Sliding rail (P/N: RAIL-B02)	
USB to console cable (P/N: 32013-004000-100-RS)	
RS-232 to console cable (P/N: 32005-005100-100-RS)	
20-pin Infineon TPM 2.0 module, software management tool, firmware v5.5 (P/N: TPM-IN02-R20)	

Chapter

**3**

# Installation

---

## PUZZLE-IN001A

### 3.1 Installation Precautions

---



#### CAUTION!

The PUZZLE-IN001A series has more than one power supply connection point.

To reduce the risk of electric shock, disconnect all power sources before installing or servicing the PUZZLE-IN001A series.

---

During installation, be aware of the precautions below:

- **Read the user manual:** The user manual provides a complete description of the PUZZLE-IN001A, installation instructions and configuration options.
- **DANGER! Disconnect Power:** Power to the PUZZLE-IN001A must be disconnected during the installation process. Failing to disconnect the power may cause severe injury to the body and/or damage to the system.
- **Qualified Personnel:** The PUZZLE-IN001A must be installed and operated only by trained and qualified personnel. Maintenance, upgrades, or repairs may only be carried out by qualified personnel who are familiar with the associated dangers.
- **Air Circulation:** Make sure there is sufficient air circulation when installing the PUZZLE-IN001A. The PUZZLE-IN001A's cooling vents must not be obstructed by any objects. Blocking the vents can cause overheating of the PUZZLE-IN001A. Leave at least 5 cm of clearance around the PUZZLE-IN001A to prevent overheating.
- **Grounding:** The PUZZLE-IN001A should be properly grounded. The voltage feeds must not be overloaded. Adjust the cabling and provide external overcharge protection per the electrical values indicated on the label attached to the back of the PUZZLE-IN001A.



## 3.2 Top Cover Removal



### WARNING:

Never open the equipment. For safety reasons, the equipment should be opened only by qualified skilled person.

Before installing or maintaining the internal components, the top cover must be removed from the PUZZLE-IN001A. Follow the steps below to complete the task.

**Step 1:** Remove the five retention screws indicated in **Figure 3-1**.

**Step 2:** Slide the top cover towards the rear side and gently lift the top cover (**Figure 3-1**).



Figure 3-1: Top Cover Removal

## PUZZLE-IN001A

### 3.3 DIMM Installation

**CAUTION:**

For quad channel configuration, always install four identical memory modules that feature the same capacity, timings, voltage, number of ranks and the same brand.

To install the DIMM module, please follow the steps below.

**Step 1:** Remove the top cover from the PUZZLE-IN001A. Please follow the instruction described in **Section 3.2**.

**Step 2:** Locate the DIMM slots on the motherboard.

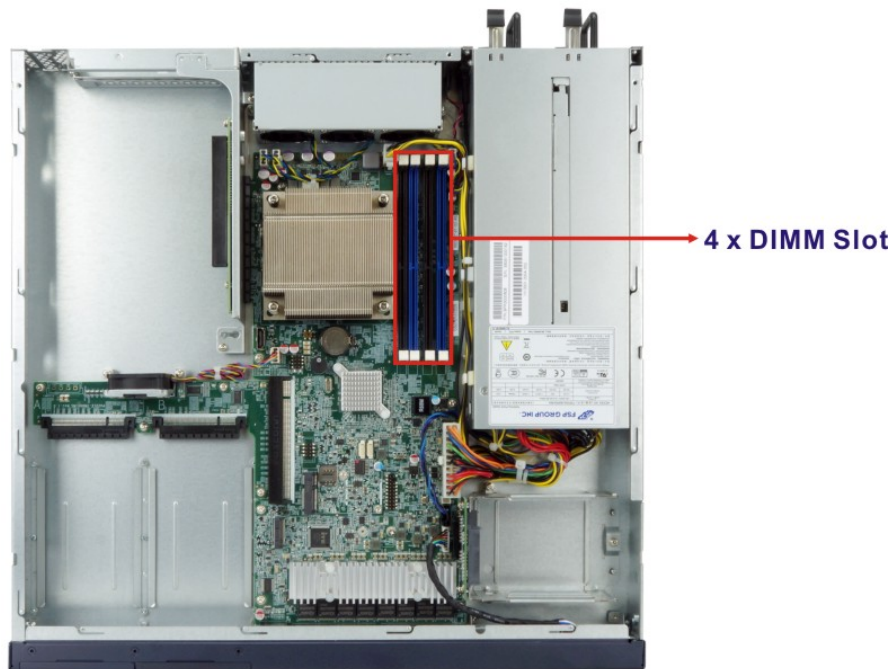

**Figure 3-2: DIMM Slot Locations**

**Step 3:** Open the DIMM socket handles. Open the two handles outwards as far as they can.

- Step 4:** Align the DIMM so the notch on the memory lines up with the notch on the memory socket.
- Step 5:** Once aligned, press down until the DIMM is properly seated. Clip the two handles into place.
- Step 6:** To remove a DIMM, push both handles outward. The memory module is ejected by a mechanism in the socket.

### 3.4 HDD Installation

The PUZZLE-IN001A allows installation of two 2.5" SATA HDD/SSD. To install HDDs into the system, please follow the steps below.

- Step 1:** Remove the top cover from the PUZZLE-IN001A. Please follow the instruction described in **Section 3.2**.
- Step 2:** Remove the HDD bracket from the system. To do this, remove the three retention screws indicated below and disconnect the SATA connector module from the motherboard.



Figure 3-3: HDD Bracket Retention Screws

**PUZZLE-IN001A**

**Step 3:** Insert an HDD into the bracket until the HDD is properly connected to the SATA connector. Secure the HDD with four retention screws (M3\*4). See **Figure 3-5**.



**Figure 3-4: Secure HDD to the Bracket**

**Step 4:** Re-connect the SATA connector module to the motherboard. Make sure the two positioning studs on the chassis go through the two small holes on the HDD bracket (**Figure 3-5**). Secure the bracket to the chassis with three screws removed previously.



**Figure 3-5: HDD Installation**

**Step 5:** Re-install and secure the top cover to the system.



### 3.5 PCIe Expansion Card Installation

The PUZZLE-IN001A allows installation of one PCIe x4 card and one PCIe x8 card. To install a PCIe expansion card, please follow the steps below.

**Step 1:** Remove the top cover from the PUZZLE-IN001A (refer to **Section 3.2**).

**Step 2:** Remove the four expansion slot module retention screws indicated below.

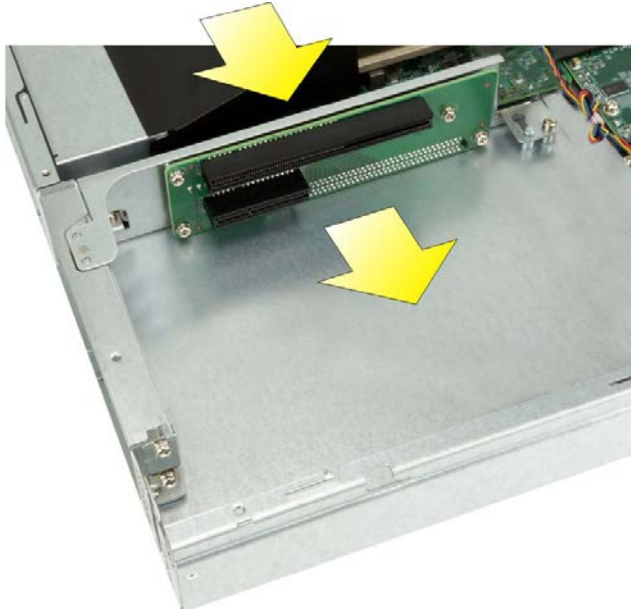

Figure 3-6: Expansion Slot Module Retention Screws



**PUZZLE-IN001A**

**Step 3:** Push the expansion slot module with strength to disconnect the module from the edge connector of the motherboard.



**Figure 3-7: Disconnect the Expansion Slot Module**

**Step 4:** Remove the blank bracket panel that aligns with the PCIe slot for installing the expansion card. Save the bracket screw.



**Figure 3-8: Blank Bracket Screw**

**Step 5:** Align the expansion card to the PCIe slot. Press gently, but firmly, to seat the expansion card correctly in the slot. Install the bracket screw to secure the card to the expansion slot module.



**Figure 3-9: PCIe Expansion Card Installation**

**Step 6:** Place the expansion slot module back to the original position by hooking the slotted hole into the positioning stud in the chassis (**Figure 3-10 A**). Push the connector of the expansion slot module into the edge connector to install it. During installation, ensure that

1. the connector on the slot module is properly aligned and connected to the edge connector;
2. the two studs on the side is going through the two holes in the chassis;
3. the slot module tab is going under the chassis tab.

## PUZZLE-IN001A

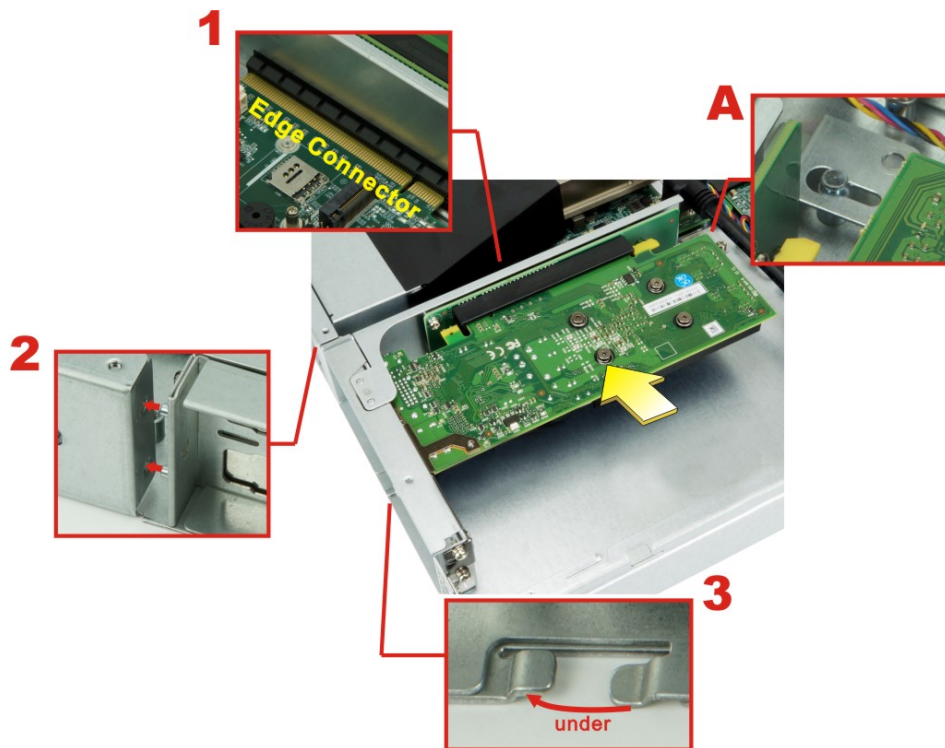

Figure 3-10: Expansion Slot Module Installation

**Step 7:** Secure the expansion slot module with the four retention screws previously removed.

### 3.6 IEI Networking Module Installation

The PUZZLE-IN001A allows installation of two IEI PuIM networking modules. To install a networking module, please follow the steps below.

**Step 1:** Disconnect all power sources from the system. **NOTE:** To install or replace the networking module, the power supply must be fully disconnected before installation.

**Step 2:** Remove the two Torx (star) screws indicated below to remove the slot cover. Save the slot cover screws. The Slot A supports 8 lanes from CPU (1 PCIe x8 or 2 PCIe x4); the Slot B supports 8 lanes from PCH (2 PCIe x4 or 4 PCIe x2). For pinouts of the Slot A/B, refer to **Section 5.2.16** and **Section 5.2.17**.



**Figure 3-11: Networking Module Slot Cover Screws**

**Step 3:** Slide an IEI networking module into the slot until the module is seated in the slot correctly and securely. Install the previously-removed Torx screws to secure the module to the chassis.



**CAUTION:**

When inserting the module, the bottom of the networking module must be as close to the system base as possible so that the module can be slid into the guide rails.

When removing the module, slide the module horizontally all the way until it is completely out of the system. Lifting up the module before completely sliding out may cause the components on the module to be damaged by the chassis structure.

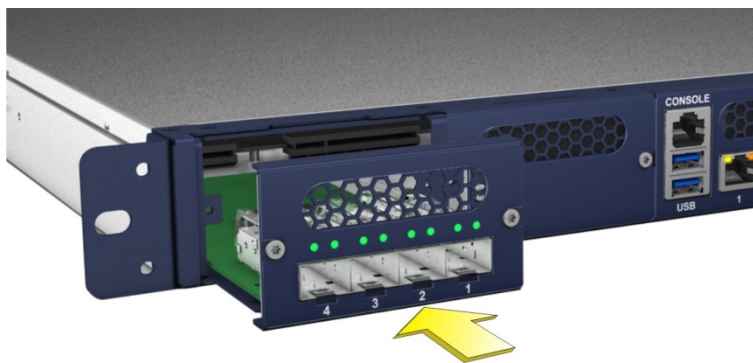

**Figure 3-12: Networking Module Installation**

**Step 4:** Re-install the top cover.



## PUZZLE-IN001A

### 3.6.1 Bypass Configuration in BIOS

Some PuIM modules support bypass. To enable/disable bypass function, configure the BIOS menu of the PUZZLE-IN001A as described below.

**Step 1:** Go to **Chipset** → **PCH - IO Configuration** → **NETWORK Configuration**  
(Bypass Setting).

```

Aptio Setup Utility - Copyright (C) 2018 American Megatrends, Inc.
Chipset
PCH-IO Configuration
Auto Power Button Status      [Disable (ATX)]
Status
Restore AC Power Loss         [Last State]
> PCI Express Configuration
> SATA And RST Configuration
> NETWORK Configuration (ByPass Setting)
M.2 B Key (M2_1)              [SATA]
Device selection
Module B Configuration        [PCIEx4 x 2]

Select AC power state when power is re-applied after a power failure.
-----
-><: Select Screen
↑↓: Select Item
Enter: Select
+/-: Change Opt.
F1:  General Help
F2:  Previous Values
F3:  Optimized Defaults
F4:  Save & Exit
ESC: Exit

Version 2.20.1271. Copyright (C) 2018 American Megatrends, Inc.
  
```

**Step 2:** The **Network ByPass Setting** menu appears. The model names of the PuIM module installed in the PUZZLE-IN001A are shown.

```

Aptio Setup Utility - Copyright (C) 2018 American Megatrends, Inc.
Chipset
Network ByPass setting
Slot_A Model Name              PulM-10G4SF-XL710
Power_ON ByPass Mode          [Disabled]
Power_OFF ByPass Mode         [Enabled]
Slot_B Model Name              PulM-1G4T-I211-BP
Power_ON ByPass Mode          [Disabled]
Power_OFF ByPass Mode         [Enabled]

Switch all ByPass Mode to Enable/Disable after power on.
-----
-><: Select Screen
↑↓: Select Item
Enter: Select
+/-: Change Opt.
F1:  General Help
F2:  Previous Values
F3:  Optimized Defaults
F4:  Save & Exit
ESC: Exit

Version 2.20.1271. Copyright (C) 2018 American Megatrends, Inc.
  
```



**Step 3:** Configure the **Power\_ON ByPass Mode** and the **Power\_OFF ByPass Mode** BIOS options to enable/disable bypass function of the installed PuIM modules.

PUZZLE BIOS Setting	Power_ON ByPass Mode		Power_OFF ByPass Mode	
	Disabled	Enabled	Disabled	Enabled
PuIM Bypass Function	Disable bypass when system on	Enable bypass when system on	Disable bypass when system off	Enable bypass when system off

**Step 4:** Press **F4** to save and exit the BIOS menu. The PUZZLE-IN001A will reboot with the new settings.

### 3.7 M.2 Module Installation



**NOTE:**

The M.2 B-key slot is configured as SATA device by default. To change the M.2 slot to PCIe device, go to **Chipset → PCH-IO Configuration** BIOS menu and configure the **M.2 B Key (M2\_1) device selection** BIOS option (see Section 4.4.2).

The M.2 slot is keyed in the B position and provides mounting screw position for 3042-size/2260-size M.2 module. To install an M.2 module, please follow the steps below.

**Step 1:** Remove the top cover from the PUZZLE-IN001A. See **Section 3.2**.

**Step 2:** Locate the M.2 slot on the motherboard.

## PUZZLE-IN001A

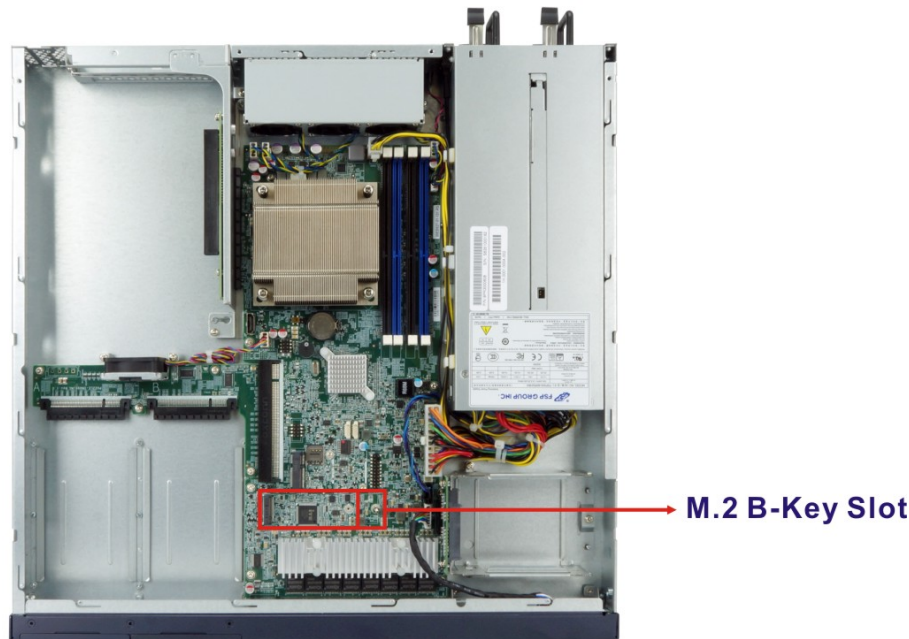

- Step 3:** Remove the on-board retention screw. **NOTE:** For 2260-size module installation, the screw and the standoff for the 3042 module must also be removed to avoid interference.
- Step 4:** Line up the notch on the module with the notch on the slot. Slide the M.2 module into the socket at an angle of about 20°.
- Step 5:** Push the M.2 module down and secure it with the previously removed retention screw.

### 3.8 PCIe Mini Card Installation

The PUZZLE-IN001A has one full-size/half-size PCIe Mini slot on the motherboard. To install a full-size module, follow the instructions below.

- Step 1:** Remove the top cover from the PUZZLE-IN001A. See **Section 3.2**.
- Step 2:** Locate the PCIe Mini slot on the motherboard (Figure 3-13).

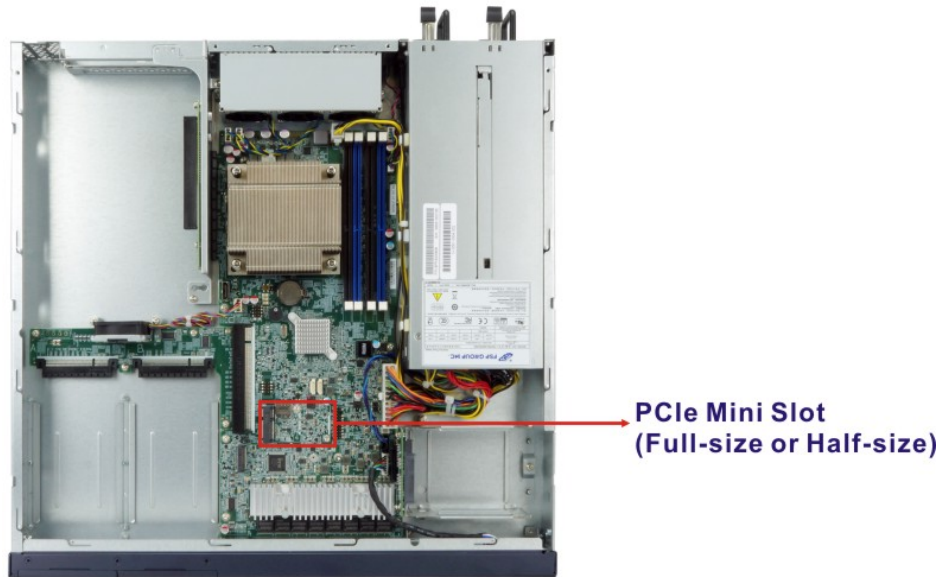

**Figure 3-13: PCIe Mini Slot Location**

- Step 3:** Remove the pre-installed retention screw from the standoff.
- Step 4:** Line up the notch on the card with the notch on the slot. Slide the PCIe Mini card into the socket at an angle of about 20°.
- Step 5:** Secure the full-size PCIe Mini card with the retention screw previously removed.

### 3.8.1 Half-size PCIe Mini Card Installation

The PCIe Mini slot also allows installation of a half-size PCIe Mini card. To install a half-size PCIe Mini card, please follow the steps below.

- Step 1:** Remove the pre-installed retention screw and the standoff from the motherboard.
- Step 2:** Install the previously removed standoff to the screw hole for the half-size PCIe Mini card.
- Step 3:** Line up the notch on the card with the notch on the slot. Slide the PCIe Mini card into the socket at an angle of about 20°.

**PUZZLE-IN001A**

**Step 4:** Secure the half-size PCIe Mini card with the retention screw previously removed.

**3.9 LAN Connection**

The LAN connectors on the front panel allow connection to an external network. The pinouts of the LAN connectors are listed below.

Pin	Description	Pin	Description
1	TRD0+	5	TRD2-
2	TRD0-	6	TRD1-
3	TRD1+	7	TRD3+
4	TRD2+	8	TRD3-

**Table 3-1: LAN Pinouts**

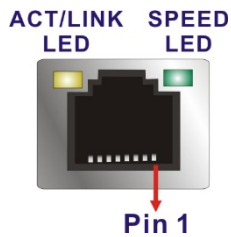

**Figure 3-14: RJ-45 Ethernet Connector**

The RJ-45 Ethernet connector has two status LEDs, one yellow and one green/orange. The yellow LED indicates activity on the port and the green/orange LED indicates the speed. See **Table 3-2**.

Activity/Link LED		Speed LED	
STATUS	DESCRIPTION	STATUS	DESCRIPTION
Off	No link	Off	10 Mbps connection
Yellow	Linked	Green	100 Mbps / 1 Gbps / 2.5 Gbps connection
Blinking	TX/RX activity	Orange	5 Gbps connection

**Table 3-2: RJ-45 Ethernet Connector LEDs**



### 3.10 Console Connection

The PUZZLE-IN001A has one RJ-45 serial device connector on the front panel. The RJ-45 connector for the console port can be identified easily as the RJ-45 for the network has two LEDs on the port, while the connectors for the console port cables don't. The pinouts of the console port are listed below.

Pin	Description	Pin	Description
1	-NRTS1	5	GND
2	-NDTR1	6	NSIN1
3	NSOUT1	7	-NDSR1
4	GND	8	-NCTS1

**Table 3-3: RJ-45 Console Port Pinouts**

The console port (RJ-45) connects to a cable with a standard D-sub 9 connector or a USB connector (varied from SKU) at the other end.

#### 3.10.1 Enable Console Port When Booting

To configure the PUZZLE-IN001A to make it auto enable the console port when booting, follow the steps below.



**NOTE:**

This method only works in Linux Ubuntu, the default operating system.

---

**Step 1:** Use the console cable shipped with the product to connect the RJ-45 console port of the PUZZLE-IN001A with your PC.

**Step 2:** In your PC, go to Windows **Device Manager** and check for the serial line of the connected USB serial port. In this case, it is COM3.



PUZZLE-IN001A

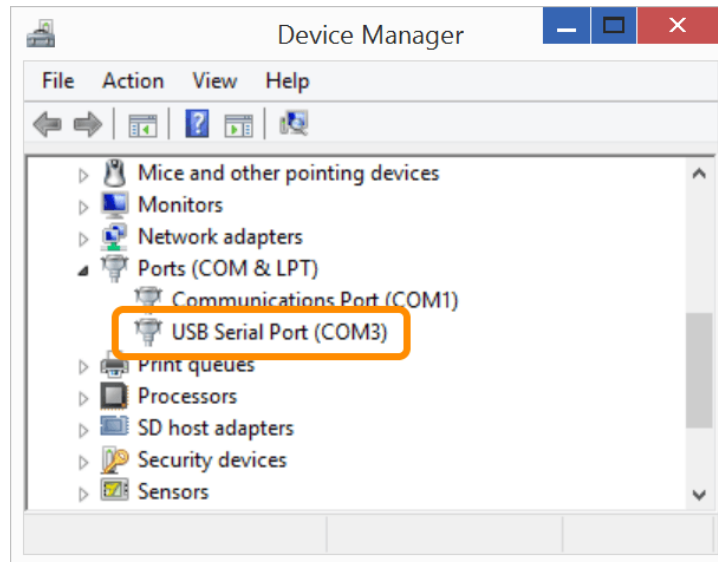

**Step 3:** Open a serial console application, PuTTY, as an example.

**Step 4:** Set the speed of the serial connection to “115200”, and choose “Serial” for Connection Type.

**Step 5:** Click “Open” on PuTTY.

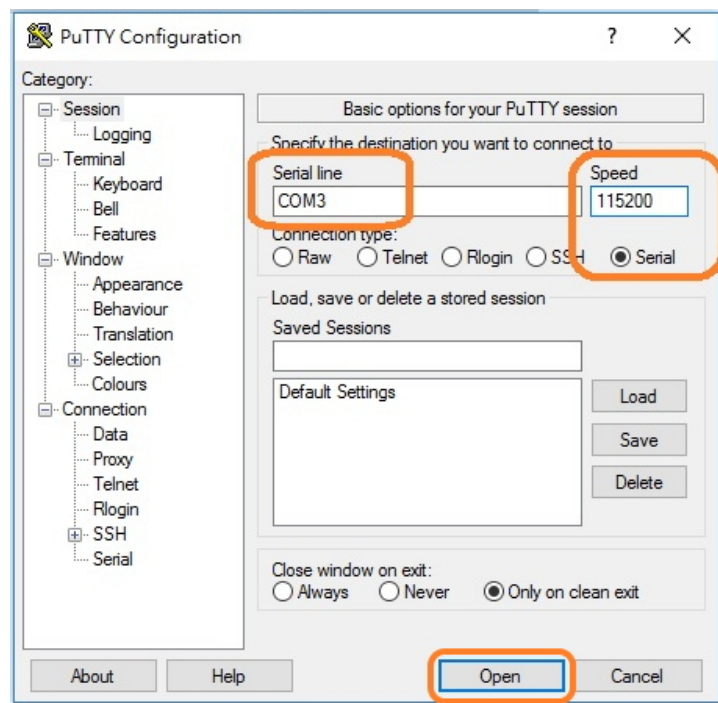

**Step 6:** Enter the following command:

```
sudo vi /lib/systemd/system/ttyS0.service
```

**Step 7:** Ensure the information shown match the followings:

```
[Unit]
```

```
Description=Serial Console Service
```

```
[Service]
```

```
ExecStart=/sbin/getty -L 115200 ttyS0 vt102
```

```
Restart=always
```

```
[Install]
```

```
WantedBy=multi-user.target
```

**Step 8:** Run the following commands one by one:

```
sudo systemctl daemon-reload
```

```
sudo systemctl enable ttyS0
```

```
sudo systemctl start ttyS0
```

## PUZZLE-IN001A

### 3.11 Rack Mount

The PUZZLE-IN001A is shipped with two rack mount brackets that could be used to secure the system to the rack after mounting it with the optional sliding rails. To install the PUZZLE-IN001A into a rack, please follow the steps below.



#### WARNING:

The provided rack mount brackets must be used with sliding rails. Using only the rack mount brackets to mount the system on a rack may cause damage to the system.

- Step 1:** Install the rack mount brackets to the sides of the PUZZLE-IN001A by inserting three retention screws (M4\*6) into each bracket (**Figure 3-15**). Make sure the screws are tight and on the right positions.

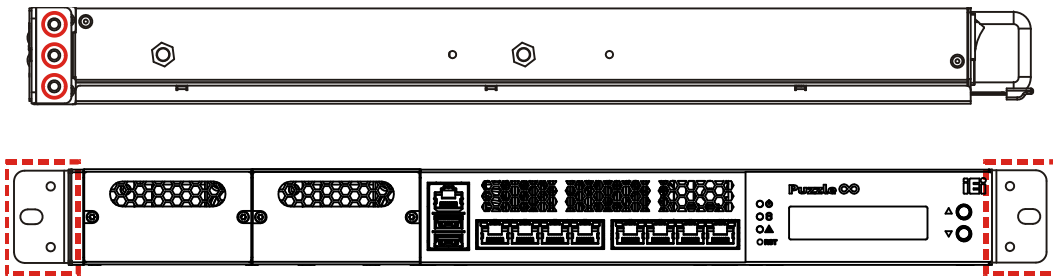

**Figure 3-15: Rack Mount Bracket Installation**

- Step 2:** Install the sliding rails according to the instruction came with the sliding rails.  
**Note:** The sliding rails must be purchased separately.
- Step 3:** Slide the PUZZLE-IN001A all the way into the rack enclosure.
- Step 4:** Secure the front of the rack mount brackets that are attached to the sides of the PUZZLE-IN001A to the front of the rack.

### 3.12 Power-On Procedure



#### WARNING:

Make sure a power supply with the correct input voltage is being fed into the system. Incorrect voltages applied to the system may cause damage to the internal electronic components and may also cause injury to the user.

To power-on the PUZZLE-IN001A please follow the steps below:

- Step 1:** Connect the power source to the power inlets on the rear panel. **Ensure to connect the power cord to a socket-outlet with earthing connection.**
- Step 2:** Turn on the power switch to power up the system.
- Step 3:** The power LED indicator on the front panel turns to green.

#### Redundant Power Inlets



- Step 4:** Use the following information when prompted for the username and password for login to the system.

**Username:** puzzle

**Password:** admin



#### NOTE:

Connecting only one power supply will trigger the beep sound. If redundant power usage is not necessary for the application, press the PSU beep off button to disable the beep sound.

## PUZZLE-IN001A

### 3.13 Resource Download

All the resources for the PUZZLE-IN001A are available on IEI Resource Download Center (<https://download.ieiworld.com>). Type PUZZLE-IN001A and press Enter to find all the relevant software, utilities, and documentation.

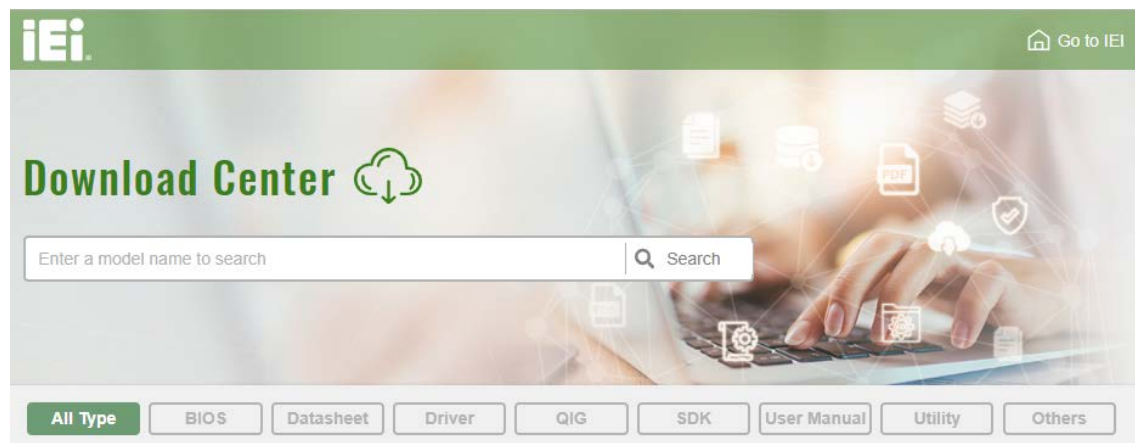

Figure 3-16: IEI Resource Download Center

### 3.14 Maintenance



#### **WARNING:**

The following instructions should only be performed by an authorized and trained technician.

Before starting, please ensure that you turn off the PUZZLE-IN001A, disconnect the power cords, network cable(s), and also remove any other device/cable that is attached to the server.

Take Anti-Static precautions whenever maintenance is being carried out on the system components. Failure to take anti-static precautions can cause permanent system damage. For more details on anti-static precautions, please refer to **Section 2.1**.



### 3.14.1 Power Supply Unit Replacement

To replace a failed power supply unit, please follow the steps below.

**Step 1:** Turn off the PUZZLE-IN001A. Disconnect the power cords, network cable(s), and any other connectors or cables from the PUZZLE-IN001A.

**Step 2:** Firmly press and hold the black button on back of PSU downwards. Pull out power supply by pulling the black handle.

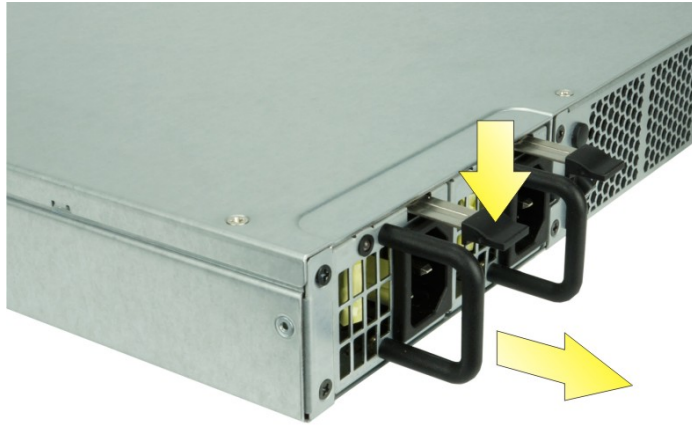

**Step 3:** Insert new power supply into the PUZZLE-IN001A.



**Step 4:** Connect the power cord to the PUZZLE-IN001A.

**Step 5:** Power on the system.

## PUZZLE-IN001A

### 3.14.2 Jumper Settings

To configure the jumper settings, please follow the steps below.

**Step 1:** Remove the top cover. See **Section 3.2**.

**Step 2:** Locate the jumper/button on the embedded motherboard.

**Step 3:** Make the jumper settings in accordance with the settings described and defined in the following sections.

#### 3.14.2.1 Clear CMOS

If the PUZZLE-IN001A fails to boot due to improper BIOS settings, the clear CMOS button clears the CMOS data and resets the system BIOS information. To do this, push the clear CMOS button for a few seconds.

If the “CMOS Settings Wrong” message is displayed during the boot up process, the fault may be corrected by pressing the F1 to enter the CMOS Setup menu. Do one of the following:

- Enter the correct CMOS setting
- Load Optimal Defaults
- Load Failsafe Defaults.

After having done one of the above, save the changes and exit the CMOS Setup menu.

The clear CMOS button location is shown in **Figure 3-17** below.

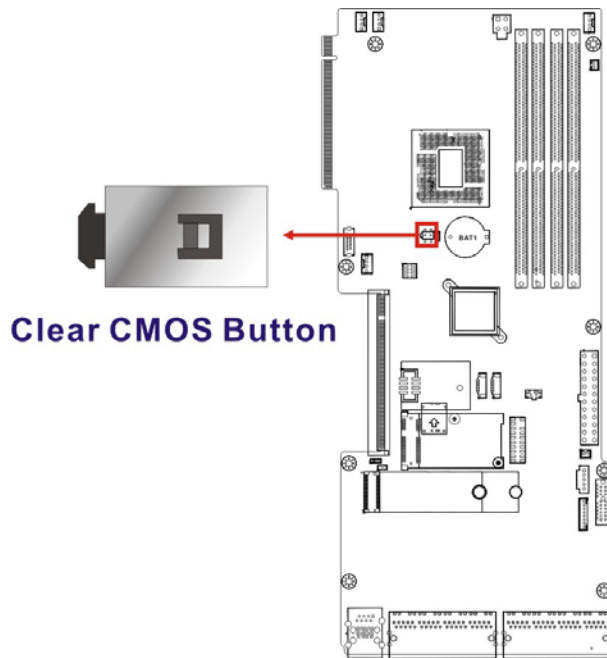

**Figure 3-17: Clear CMOS Button Location**

### 3.14.2.2 Flash Descriptor Security Override Jumper

The Flash Descriptor Security Override jumper (J\_FLASH1) allows users to enable or disable the ME firmware update. Refer to **Figure 3-18** and **Table 3-4** for the jumper location and settings.

Setting	Description
Short 1-2	Disabled (default)
Short 2-3	Enabled

**Table 3-4: Flash Descriptor Security Override Jumper Settings**

## PUZZLE-IN001A

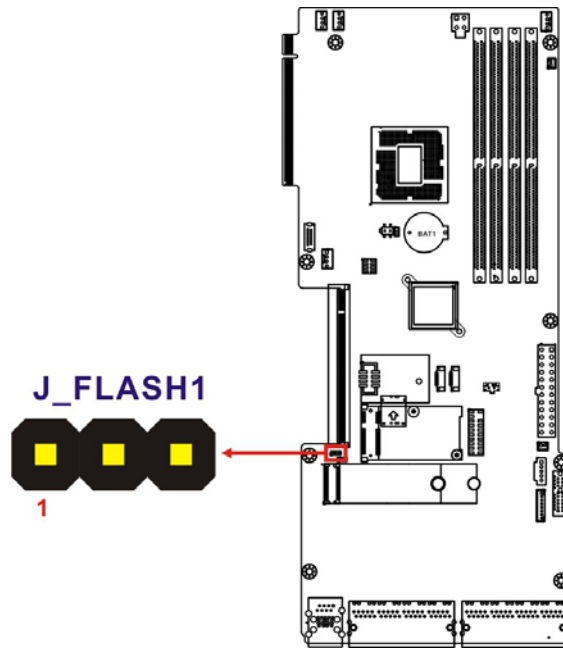

Figure 3-18: Flash Descriptor Security Override Jumper Location

To update the ME firmware, please follow the steps below.

- Step 1:** Before turning on the system power, short pin 2-3 of the jumper.
- Step 2:** Update the BIOS and ME firmware, and then turn off the system power.
- Step 3:** Remove the metal clip on the jumper or return to its default setting (short pin 1-2).
- Step 4:** Restart the system. The system will reboot 2~3 times to complete the ME firmware update.

Chapter

**4**

# **BIOS**

---



## PUZZLE-IN001A

### 4.1 Introduction

The BIOS is programmed onto the BIOS chip. The BIOS setup program allows changes to certain system settings. This chapter outlines the options that can be changed.



#### NOTE:

Some of the BIOS options may vary throughout the life cycle of the product and are subject to change without prior notice.

#### 4.1.1 Starting Setup

The UEFI BIOS is activated when the computer is turned on. The setup program can be activated in one of two ways.

1. Press the **DEL** or **F2** key as soon as the system is turned on or
2. Press the **DEL** or **F2** key when the “**Press DEL or F2 to enter SETUP**” message appears on the screen.

If the message disappears before the **DEL** or **F2** key is pressed, restart the computer and try again.

#### 4.1.2 Using Setup

Use the arrow keys to highlight items, press **ENTER** to select, use the PageUp and PageDown keys to change entries, press **F1** for help and press **ESC** to quit. Navigation keys are shown in **Table 4-1**.

Key	Function
Up arrow	Move to previous item
Down arrow	Move to next item
Left arrow	Move to the item on the left hand side
Right arrow	Move to the item on the right hand side
+	Increase the numeric value or make changes

Key	Function
-	Decrease the numeric value or make changes
Esc key	Main Menu – Quit and not save changes into CMOS Status Page Setup Menu and Option Page Setup Menu -- Exit current page and return to Main Menu
F1 key	General help, only for Status Page Setup Menu and Option Page Setup Menu
F2 key	Load previous values
F3 key	Load optimized defaults
F4 key	Save changes and exit BIOS

**Table 4-1: BIOS Navigation Keys**

### 4.1.3 Getting Help

When **F1** is pressed a small help window describing the appropriate keys to use and the possible selections for the highlighted item appears. To exit the Help Window press **Esc** or the **F1** key again.

### 4.1.4 Unable to Reboot after Configuration Changes

If the computer cannot boot after changes to the system configuration is made, CMOS defaults. Use the clear CMOS button described in **Chapter 3**.

### 4.1.5 BIOS Menu Bar

The **menu bar** on top of the BIOS screen has the following main items:

- Main – Changes the basic system configuration.
- Advanced – Changes the advanced system settings.
- Chipset – Changes the chipset settings.
- Security – Sets User and Supervisor Passwords.
- Boot – Changes the system boot configuration.
- Save & Exit – Selects exit options and loads default settings

## PUZZLE-IN001A

The following sections completely describe the configuration options found in the menu items at the top of the BIOS screen and listed above.

### 4.2 Main

The **Main** BIOS menu (**BIOS Menu 1**) appears when the **BIOS Setup** program is entered.

The **Main** menu gives an overview of the basic system information.

Aptio Setup Utility - Copyright (C) 2019 American Megatrends, Inc.					
Main	Advanced	Chipset	Security	Boot	Save & Exit
BIOS Information				Set the Date. Use Tab to switch between Date elements.	
BIOS Vendor	American Megatrends				
Core Version	5.13				
Compliance	UEFI 2.6; PI 1.4				
Project Version	Z561AR30.R01				
Build Date and Time	09/18/2019 16:56:17				
iWDD Vendor		iEi			
iWDD Version		Z561ER10.bin			
Processor Information					
Name	CoffeeLake DT				
Brand String	Intel(R) Xeon(R)				
	E-2136 CPU @ 3.30GHz				
Frequency	3300 MHz				
ID	0x906EA				
Stepping	U0				
Number of Processors	6Core(s)/12Thread(s)				
Microcode Revision	B4				
GT Info	Not Applicable				
IGFX VBIOS Version		N/A			
Memory RC Version		0.7.1.95			
Total Memory		16384 MB			
Memory Frequency		2400 MHz			
PCH Information					
Name	CNL PCH-H				
PCH SKU	C246				
Stepping	B0				
ME FW Version		12.0.35.1427			
ME Firmware SKU		Corporate SKU			
Access Level		Administrator			
System Date		[Thu 01/01/2019]			
System Time		[01:10:27]			
-----					
→←: Select Screen					
↑ ↓: Select Item					
Enter: Select					
+/-: Change Opt.					
F1: General Help					
F2: Previous Values					
F3: Optimized Defaults					
F4: Save & Exit					
ESC: Exit					
Version 2.20.1271. Copyright (C) 2019 American Megatrends, Inc.					

**BIOS Menu 1: Main**

The **Main** menu has two user configurable fields:

➔ **System Date [xx/xx/xx]**

Use the **System Date** option to set the system date. Manually enter the day, month and year.

➔ **System Time [xx:xx:xx]**

Use the **System Time** option to set the system time. Manually enter the hours, minutes and seconds.

### 4.3 Advanced

Use the **Advanced** menu (**BIOS Menu 2**) to configure the CPU and peripheral devices through the following sub-menus:



**WARNING!**

Setting the wrong values in the sections below may cause the system to malfunction. Make sure that the settings made are compatible with the hardware.

```

Aptio Setup Utility - Copyright (C) 2019 American Megatrends, Inc.
Main  Advanced  Chipset  Security  Boot  Save & Exit
-----
> CPU Configuration
> Trusted Computing
> iWDD H/M Monitor
> IT8528 Super IO Configuration
> Serial Port Console Redirection
> NVMe Configuration

Trusted Computing
Settings

-----
➔←: Select Screen
↑ ↓: Select Item
Enter: Select
+/-: Change Opt.
F1: General Help
F2: Previous Values
F3: Optimized Defaults
F4: Save & Exit
ESC: Exit

Version 2.20.1271. Copyright (C) 2019 American Megatrends, Inc.
    
```

**BIOS Menu 2: Advanced**

## PUZZLE-IN001A

### 4.3.1 CPU Configuration

Use the **CPU Configuration** menu (**BIOS Menu 3**) to view detailed CPU specifications or enable the Intel Virtualization Technology.

```

Aptio Setup Utility - Copyright (C) 2019 American Megatrends, Inc.
  Advanced
CPU Configuration
Type                Intel(R) Xeon(R)
                   E-2136 CPU @ 3.30GHz
ID                  0x906EA
Speed               3300 MHz
L1 Data Cache      32 kB x 6
L1 Instruction Cache 32 kB x 6
L2 Cache           256 kB x 6
L3 Cache           12 MB
L4 Cache           N/A
VMX                 Supported
SMX/TXT             Supported

Intel (VMX) Virtualization Technology [Enabled]
Active Processor Cores [All]
Hyper-Threading      [Enabled]
Intel Trusted Execution Technology [Disabled]

When enabled, a VMM can utilize the additional hardware capabilities provided by Vanderpool Technology.

-----
-><: Select Screen
↑ ↓: Select Item
Enter: Select
+/-: Change Opt.
F1: General Help
F2: Previous Values
F3: Optimized Defaults
F4: Save & Exit
ESC: Exit

Version 2.20.1271. Copyright (C) 2019 American Megatrends, Inc.
  
```

#### BIOS Menu 3: CPU Configuration

#### → Intel (VMX) Virtualization Technology [Enabled]

Use the **Intel (VMX) Virtualization Technology** option to enable or disable virtualization on the system. When combined with third party software, Intel® Virtualization technology allows several OSs to run on the same system at the same time.

- **Disabled** Disables Intel Virtualization Technology.
- **Enabled** **DEFAULT** Enables Intel Virtualization Technology.



**→ Active Processor Cores [All]**

Use the **Active Processor Cores** BIOS option to enable numbers of cores in the processor package.

- **All**      **DEFAULT**      Enable all cores in the processor package.
- **1**                      Enable one core in the processor package.
- **2**                      Enable two cores in the processor package.
- **3**                      Enable three cores in the processor package.
- **4**                      Enable four cores in the processor package.
- **5**                      Enable five cores in the processor package.

**→ Hyper-threading [Enabled]**

Use the **Hyper-threading** BIOS option to enable or disable the Intel Hyper-Threading Technology.

- **Disabled**                      Disables the Intel Hyper-Threading Technology.
- **Enabled**      **DEFAULT**      Enables the Intel Hyper-Threading Technology.

**→ Intel Trusted Execution Technology [Disabled]**

Use the **Intel Trusted Execution Technology** option to enable or disable the Intel® Trusted Execution Technology.

- **Disabled**                      **DEFAULT**      Disable Intel® Trusted Execution Technology
- **Enabled**                              Enable Intel® Trusted Execution Technology

## PUZZLE-IN001A

### 4.3.2 Trusted Computing

Use the **Trusted Computing** menu (**BIOS Menu 4**) to configure settings related to the Trusted Computing Group (TCG) Trusted Platform Module (TPM).

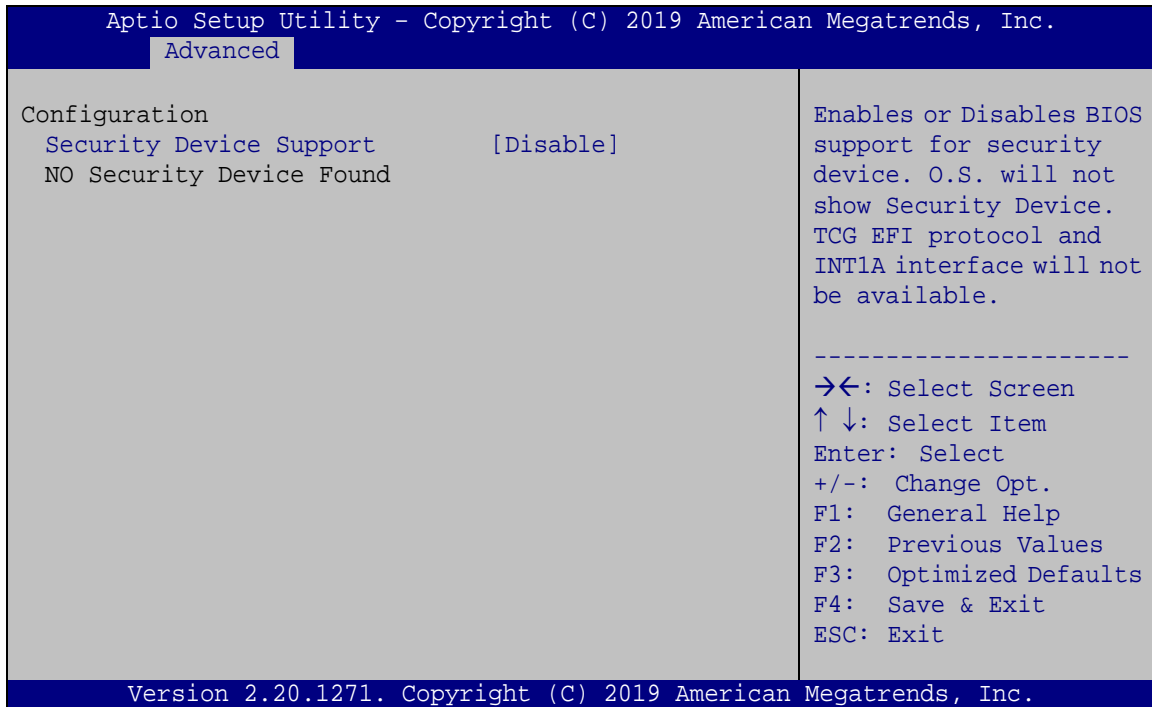

#### BIOS Menu 4: Trusted Computing

##### → Security Device Support [Disable]

Use the **Security Device Support** option to configure support for the TPM.

- **Disable**    DEFAULT    TPM support is disabled.
- **Enable**                    TPM support is enabled.

### 4.3.3 iWDD H/W Monitor

The **iWDD H/W Monitor** menu (**BIOS Menu 5**) contains the fan configuration submenu, and displays the system temperature and CPU fan speed.

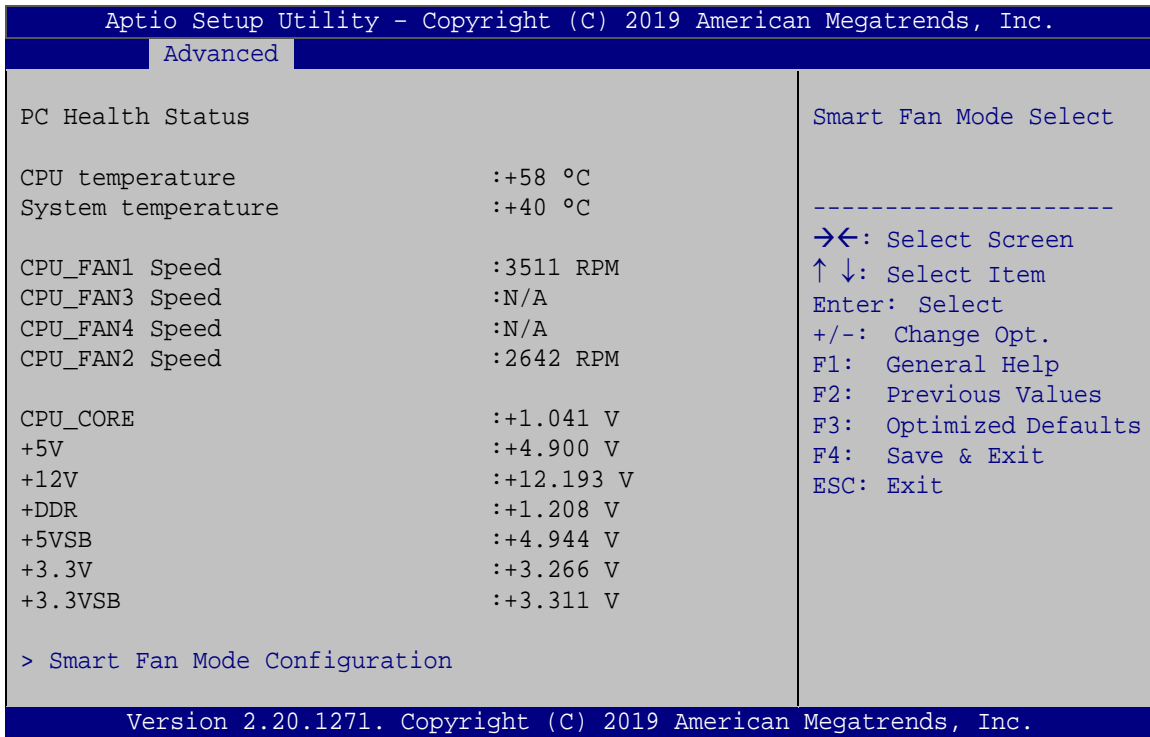

#### BIOS Menu 5: iWDD H/W Monitor

##### → PC Health Status

The following system parameters and values are shown. The system parameters that are monitored are:

- System Temperatures:
  - CPU Temperature
  - System Temperature
- Fan Speeds:
  - CPU Fan Speed
- Voltages:
  - CPU\_CORE
  - +5V

## PUZZLE-IN001A

- +12V
- DDR
- +5VSB
- +3.3V
- +3.3VSB

### 4.3.3.1 Smart Fan Mode Configuration

Use the **Smart Fan Mode Configuration** submenu (**BIOS Menu 6**) to configure the CPU/system fan temperature and speed settings.

```

Aptio Setup Utility - Copyright (C) 2019 American Megatrends, Inc.
-----
Advanced
-----
Smart Fan Mode Configuration
CPU_FAN1 Smart Fan Control      [Auto Mode]
Auto mode fan start temperature 65
Auto mode fan off temperature  40
Auto mode fan start PWM        30
Auto mode fan slope PWM        3

CPU_FAN3 Smart Fan Control      [Auto Mode]
Auto mode fan start temperature 65
Auto mode fan off temperature  40
Auto mode fan start PWM        30
Auto mode fan slope PWM        3

Smart Fan Mode Select
-----
-><-: Select Screen
↑↓: Select Item
Enter: Select
+/-: Change Opt.
F1: General Help
F2: Previous Values
F3: Optimized Defaults
F4: Save & Exit
ESC: Exit

Version 2.20.1271. Copyright (C) 2019 American Megatrends, Inc.
  
```

#### BIOS Menu 6: Smart Fan Mode Configuration

##### → CPU\_FAN Smart Fan Control [Auto Mode]

Use the **CPU\_FAN Smart Fan Control** options to configure the CPU Smart Fans.

- **Manual Mode**                      The fan spins at the speed set in Manual Mode settings.
- **Auto Mode**                      **DEFAULT**      The fan adjusts its speed using Auto Mode settings.

The following options can only be set if the CPU Smart Fan Control option is set to Auto Mode.

→ **Auto mode fan start temperature**

If the CPU temperature is between **fan off** and **fan start**, the fan speed change to **fan start PWM**. To set a value, Use the + or – key to change the value or enter a decimal number between 1 and 100.

→ **Auto mode fan off temperature**

If the CPU temperature is lower than the value set this option, the fan speed change to be lowest. To set a value, Use the + or – key to change the value or enter a decimal number between 1 and 100.

→ **Auto mode fan start PWM**

Use the **Auto mode fan start PWM** option to set the PWM start value. Use the + or – key to change the value or enter a decimal number between 1 and 100.

→ **Auto mode fan slope PWM**

Use the **Auto mode fan slope PWM** option to select the linear rate at which the PWM mode increases with respect to an increase in temperature. Use the + or – key to change the value or enter a decimal number between 1 and 8.



## PUZZLE-IN001A

### 4.3.4 IT8528 Super IO Configuration

Use the **IT8528 Super IO Configuration** menu (**BIOS Menu 7**) to set or change the configurations for the parallel ports and serial ports.

```

Aptio Setup Utility - Copyright (C) 2019 American Megatrends, Inc.
  Advanced
Super IO Configuration
Super IO Chip                IT8528
> Serial Port 1 Configuration

Set Parameters of Serial
Port 1 (COMA)
-----
-><: Select Screen
↑ ↓: Select Item
Enter: Select
+/-: Change Opt.
F1: General Help
F2: Previous Values
F3: Optimized Defaults
F4: Save & Exit
ESC: Exit

Version 2.20.1271. Copyright (C) 2019 American Megatrends, Inc.
  
```

**BIOS Menu 7: IT8528 Super IO Configuration**

#### 4.3.4.1 Serial Port 1 Configuration

Use the **Serial Port 1 Configuration** menu (**BIOS Menu 8**) to configure the serial port n.

```

Aptio Setup Utility - Copyright (C) 2019 American Megatrends, Inc.
  Advanced
Serial Port n Configuration
Serial Port                  [Enabled]
Device Settings              IO=3F8h; IRQ=4

Enable or Disable Serial
Port (COM)
-----
-><: Select Screen
↑ ↓: Select Item
Enter: Select
+/-: Change Opt.
F1: General Help
F2: Previous Values
F3: Optimized Defaults
F4: Save & Exit
ESC: Exit

Version 2.20.1271. Copyright (C) 2019 American Megatrends, Inc.
  
```

**BIOS Menu 8: Serial Port 1 Configuration Menu**

➔ **Serial Port [Enabled]**

Use the **Serial Port** option to enable or disable the serial port.

- ➔ **Disabled**                      Disable the serial port
- ➔ **Enabled**      **DEFAULT**      Enable the serial port

**4.3.5 Serial Port Console Redirection**

The **Serial Port Console Redirection** menu (**BIOS Menu 9**) allows the console redirection options to be configured. Console redirection allows users to maintain a system remotely by re-directing keyboard input and text output through the serial port.

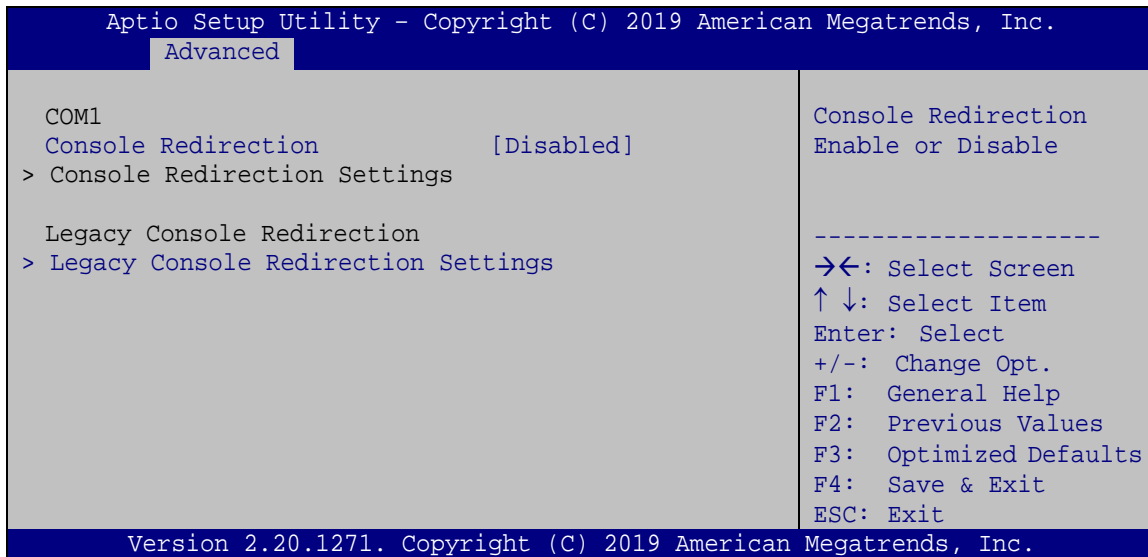

**BIOS Menu 9: Serial Port Console Redirection**

➔ **Console Redirection [Enabled]**

Use **Console Redirection** option to enable or disable the console redirection function.

- ➔ **Disabled**                      Disabled the console redirection function
- ➔ **Enabled**      **DEFAULT**      Enabled the console redirection function

The following options are available in the **Console Redirection Settings** submenu when the **Console Redirection** option is enabled.

**PUZZLE-IN001A****→ Terminal Type [ANSI]**

Use the **Terminal Type** option to specify the remote terminal type.

- **VT100**                      The target terminal type is VT100
- **VT100+**                    The target terminal type is VT100+
- **VT-UTF8**                    The target terminal type is VT-UTF8
- **ANSI**                    **DEFAULT**                    The target terminal type is ANSI

**→ Bits per second [115200]**

Use the **Bits per second** option to specify the serial port transmission speed. The speed must match the other side. Long or noisy lines may require lower speeds.

- **9600**                      Sets the serial port transmission speed at 9600.
- **19200**                      Sets the serial port transmission speed at 19200.
- **57600**                      Sets the serial port transmission speed at 57600.
- **115200**                    **DEFAULT**                    Sets the serial port transmission speed at 115200.

**→ Data Bits [8]**

Use the **Data Bits** option to specify the number of data bits.

- **7**                              Sets the data bits at 7.
- **8**                              **DEFAULT**                    Sets the data bits at 8.

**→ Parity [None]**

Use the **Parity** option to specify the parity bit that can be sent with the data bits for detecting the transmission errors.

- **None**                    **DEFAULT**                    No parity bit is sent with the data bits.
- **Even**                      The parity bit is 0 if the number of ones in the data bits is even.

- ➔ **Odd**                                      The parity bit is 0 if the number of ones in the data bits is odd.
- ➔ **Mark**                                      The parity bit is always 1. This option does not provide error detection.
- ➔ **Space**                                      The parity bit is always 0. This option does not provide error detection.

➔ **Stop Bits [1]**

Use the **Stop Bits** option to specify the number of stop bits used to indicate the end of a serial data packet. Communication with slow devices may require more than 1 stop bit.

- ➔ **1**                      **DEFAULT**              Sets the number of stop bits at 1.
- ➔ **2**    Sets the number of stop bits at 2.

**4.3.5.1 Legacy Console Redirection Settings**

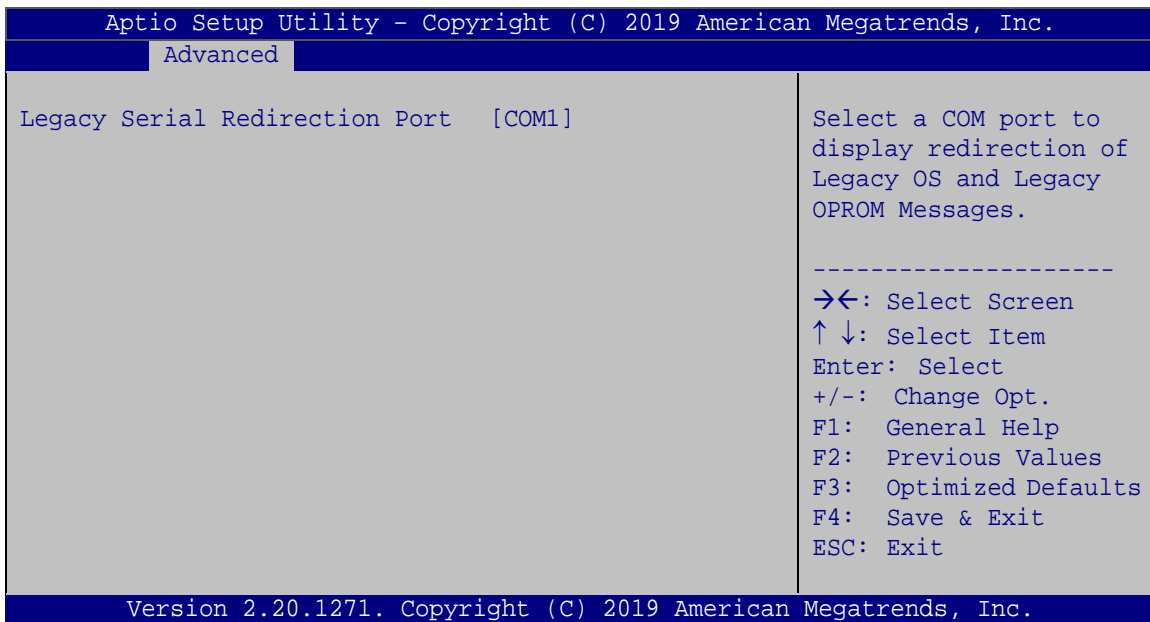

**BIOS Menu 10: Legacy Console Redirection Settings**

## PUZZLE-IN001A

### → Legacy Serial Redirection Port [COM1]

Use the **Legacy Serial Redirection Port** option to select a COM port to display redirection of legacy OS and legacy OPRM messages. Configuration option is listed below.

- COM1 Default

### 4.3.6 NVMe Configuration

Use the **NVMe Configuration (BIOS Menu 11)** menu to display the NVMe controller and device information.

```

Aptio Setup Utility - Copyright (C) 2019 American Megatrends, Inc.
  Advanced
-----
NVMe Configuration
No NVMe Device Found

-----
→←: Select Screen
↑↓: Select Item
Enter: Select
+/-: Change Opt.
F1: General Help
F2: Previous Values
F3: Optimized Defaults
F4: Save & Exit
ESC: Exit
Version 2.20.1271. Copyright (C) 2019 American Megatrends, Inc.
  
```

**BIOS Menu 11: NVMe Configuration**



## 4.4 Chipset

Use the **Chipset** menu (**BIOS Menu 12**) to access the PCH IO and System Agent (SA) configuration menus.



### **WARNING!**

Setting the wrong values for the Chipset BIOS selections in the Chipset BIOS menu may cause the system to malfunction.

```

Aptio Setup Utility - Copyright (C) 2019 American Megatrends, Inc.
Main   Advanced  Chipset  Security  Boot   Save & Exit
-----
> System Agent (SA) Configuration      System Agent (SA)
> PCH-IO Configuration                 Parameters
-----
-><: Select Screen
↑↓: Select Item
Enter: Select
+/-: Change Opt.
F1: General Help
F2: Previous Values
F3: Optimized Defaults
F4: Save & Exit
ESC: Exit

Version 2.20.1271. Copyright (C) 2019 American Megatrends, Inc.
    
```

**BIOS Menu 12: Chipset**

## PUZZLE-IN001A

### 4.4.1 System Agent (SA) Configuration

Use the **System Agent (SA) Configuration** menu (**BIOS Menu 13**) to configure the System Agent (SA) parameters.

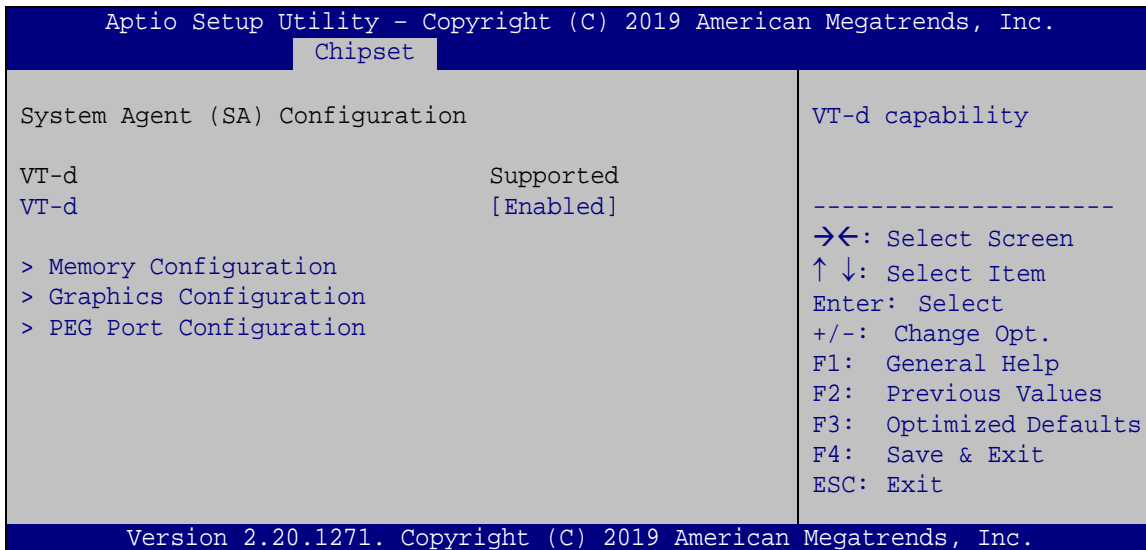

#### BIOS Menu 13: System Agent (SA) Configuration

##### → VT-d [Enabled]

Use the **VT-d** option to enable or disable VT-d capability.

- **Disabled** Disables VT-d capability.
- **Enabled** **DEFAULT** Enables VT-d capability.

### 4.4.1.1 Memory Configuration

Use the **Memory Configuration** submenu (**BIOS Menu 14**) to view memory information.

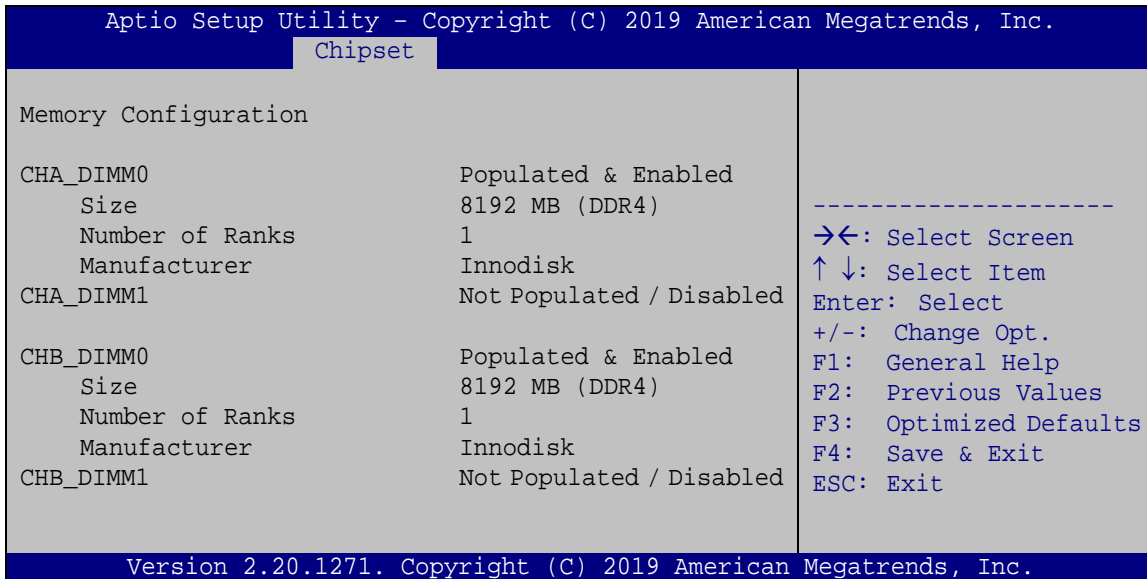

**BIOS Menu 14: Memory Configuration**

### 4.4.1.2 Graphics Configuration

Use the **Graphics Configuration (BIOS Menu 15)** menu to configure the video device connected to the system.

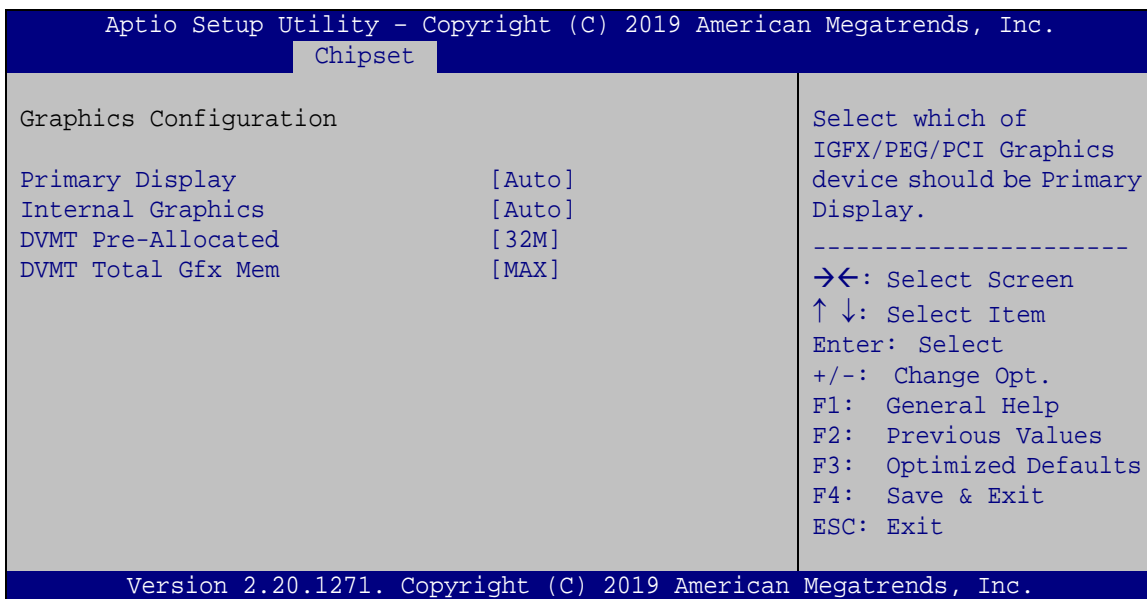

**BIOS Menu 15: Graphics Configuration**

## PUZZLE-IN001A

### → Primary Display [Auto]

Use the **Primary Display** option to select the primary graphics controller the system uses.

The following options are available:

- Auto                      **Default**
- IGFX
- PEG
- PCIe

### → Internal Graphics [Auto]

Use the **Internal Graphics** option to keep IGFX enabled basing on the setup options. The following options are available:

- Auto                      **Default**
- Disabled
- Enabled

### → DVMT Pre-Allocated [32M]

Use the **DVMT Pre-Allocated** option to set the amount of system memory allocated to the integrated graphics processor when the system boots. The system memory allocated can then only be used as graphics memory, and is no longer available to applications or the operating system. Configuration options are listed below:

- 32M                      **Default**
- 64M

### → DVMT Total Gfx Mem [MAX]

Use the **DVMT Total Gfx Mem** option to select DVMT5.0 total graphic memory size used by the internal graphic device. The following options are available:

- 128M
- 256M
- MAX                      **Default**

### 4.4.1.3 PEG Port Configuration

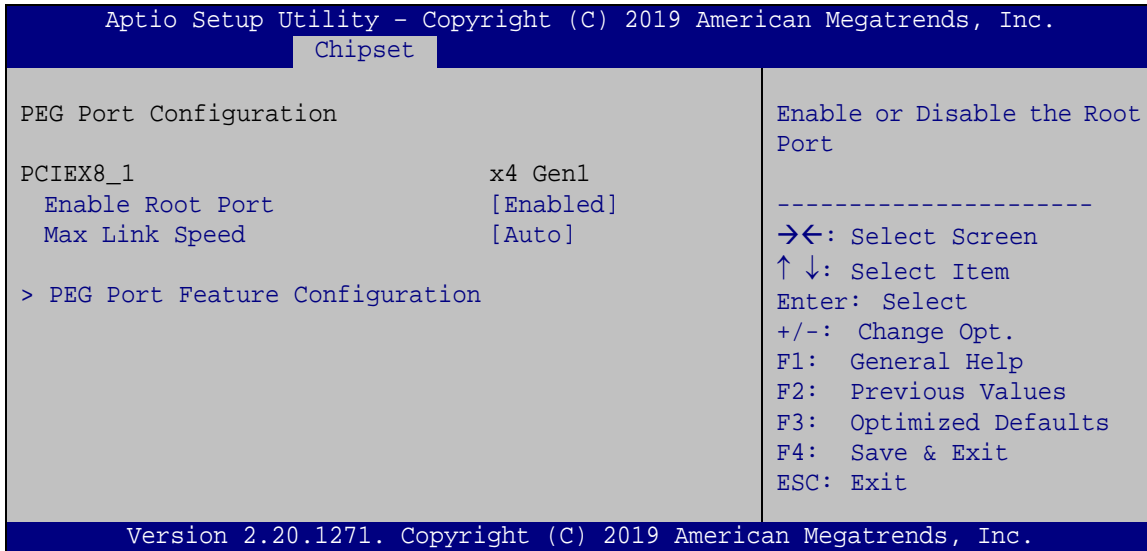

#### BIOS Menu 16: PEG Port Configuration

##### → Enable Root Port [Enabled]

Use the **Enable Root Port** option to enable or disable the PCI Express (PEG) controller.

- **Disabled** Disables the PCI Express (PEG) controller.
- **Enabled** **DEFAULT** Enables the PCI Express (PEG) controller.

##### → Max Link Speed [Auto]

Use the **Max Link Speed** option to select the maximum link speed of the PCI Express slot.

The following options are available:

- Auto **Default**
- Gen1
- Gen2
- Gen3

##### → Detect Non-Compliance Device [Disabled]

Use the **Detect Non-Compliance Device** option to configure whether to detect if a non-compliance PCI Express device is connected to the PCI Express port.



## PUZZLE-IN001A

- |   |                 |                |  |
|---|-----------------|----------------|--|
| ➔ | <b>Disabled</b> | <b>DEFAULT</b> | Do not detect if a non-compliance PCI Express device is connected to the PCI Express port. |
| ➔ | <b>Enabled</b>  |                | Detect if a non-compliance PCI Express device is connected to the PCI Express port.        |

### 4.4.2 PCH-IO Configuration

Use the **PCH-IO Configuration** menu (**BIOS Menu 17**) to configure the PCH parameters.

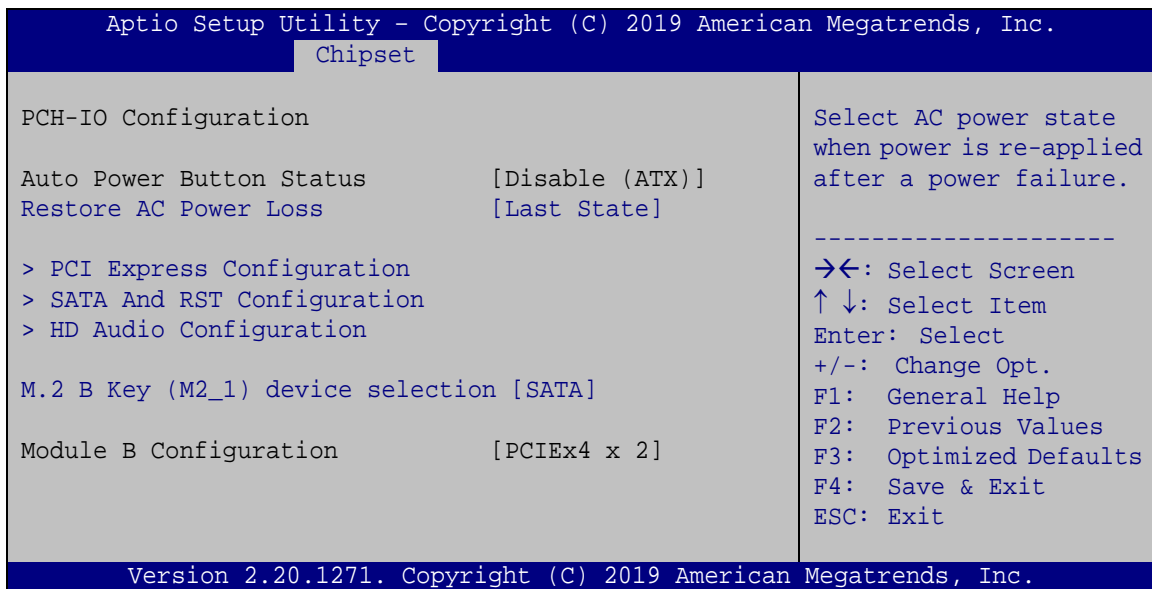

#### BIOS Menu 17: PCH-IO Configuration

##### ➔ Restore AC Power Loss [Last State]

Use the **Restore AC Power Loss** BIOS option to specify what state the system returns to if there is a sudden loss of power to the system.

- |   |                   |                |  |
|---|-------------------|----------------|--|
| ➔ | <b>Power Off</b>  |                | The system remains turned off  |
| ➔ | <b>Power On</b>   |                | The system turns on  |
| ➔ | <b>Last State</b> | <b>DEFAULT</b> | The system returns to its previous state. If it was on, it turns itself on. If it was off, it remains off. |

➔ **M.2 B Key (M2\_1) device selection [SATA]**

Use the **M.2 B Key (M2\_1) device selection [SATA]** BIOS option to configure M.2 device as SATA or PCIe device.

- ➔ **SATA**      **DEFAULT**      Configure M.2 device as SATA device.
- ➔ **PCIEX1**                      Configure M.2 device as PCIe x1 device.
- ➔ **PCIEX1+  
USB3**                      Configure M.2 device as PCIe x1 + USB 3 device.

**4.4.2.1 PCI Express Configuration**

Use the **PCI Express Configuration** menu (**BIOS Menu 18**) to configure the PCI Express slot.

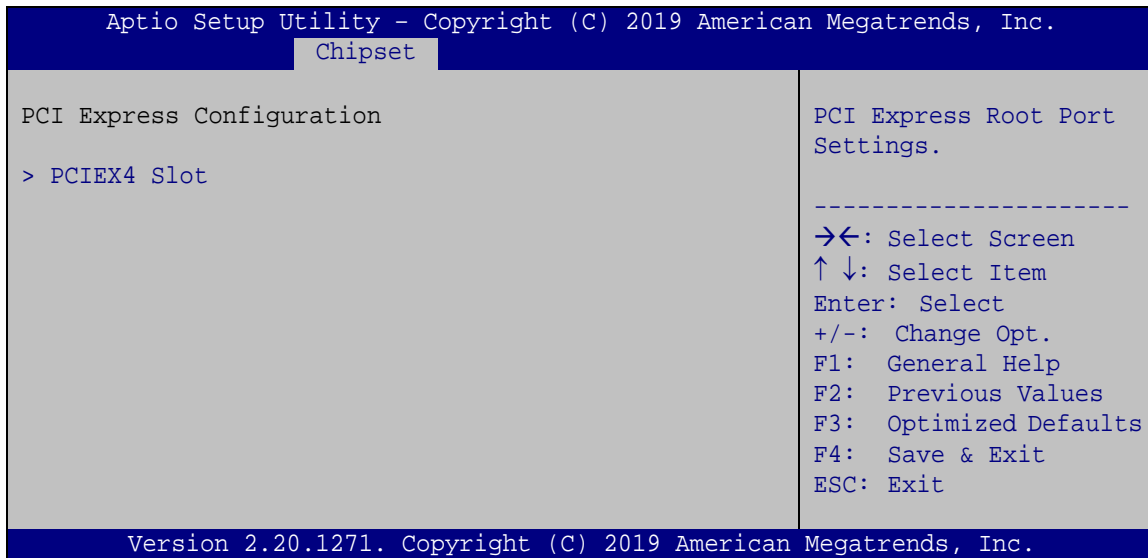

**BIOS Menu 18: PCI Express Configuration**

## PUZZLE-IN001A

### 4.4.2.1.1 PCIEX4 Slot

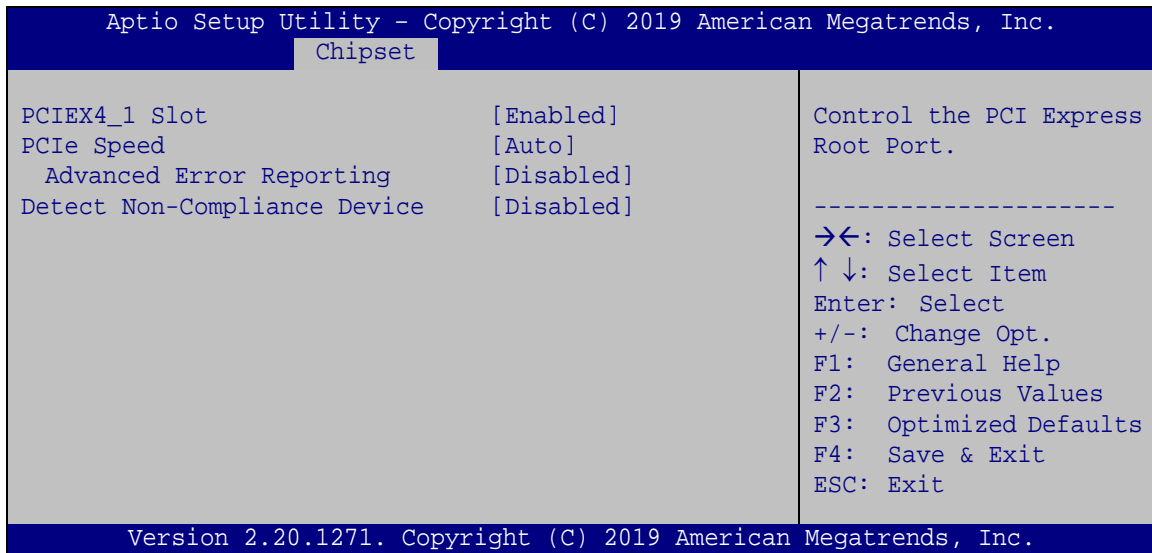

#### BIOS Menu 19: PCIEX4 Slot

##### → PCIEX4\_1 Slot [Enabled]

Use the **PCIEX4\_1 Slot** option to enable or disable the PCIe x4 slot (PCIEX4\_1).

- **Disabled** Disables the PCIe x4 slot.
- **Enabled** **DEFAULT** Enables the PCIe x4 slot.

##### → PCIe Speed [Auto]

Use this option to select the support type of the PCI Express slots. The following options are available:

- Auto **Default**
- Gen1
- Gen2
- Gen3
- Detect

##### → Advanced Error Reporting [Disabled]

Use the **Advanced Error Reporting** option to enable or disable the advanced error reporting function.

- ➔ **Disabled**                      **DEFAULT**      Disable advanced error reporting.
- ➔ **Enabled**    Enable advanced error reporting.

➔ **Non-Compliance Device [Disabled]**

Use the **Detect Non-Compliance Device** option to configure whether to detect if a non-compliance PCI Express device is connected to the PCI Express port.

- ➔ **Disabled**                      **DEFAULT**      Do not detect if a non-compliance PCI Express device is connected to the PCI Express port.
- ➔ **Enabled**    Detect if a non-compliance PCI Express device is connected to the PCI Express port.

**4.4.2.2 SATA and RST Configuration**

Use the **SATA and RST Configuration** menu (**BIOS Menu 20**) to change and/or set the configuration of the SATA devices installed in the system.

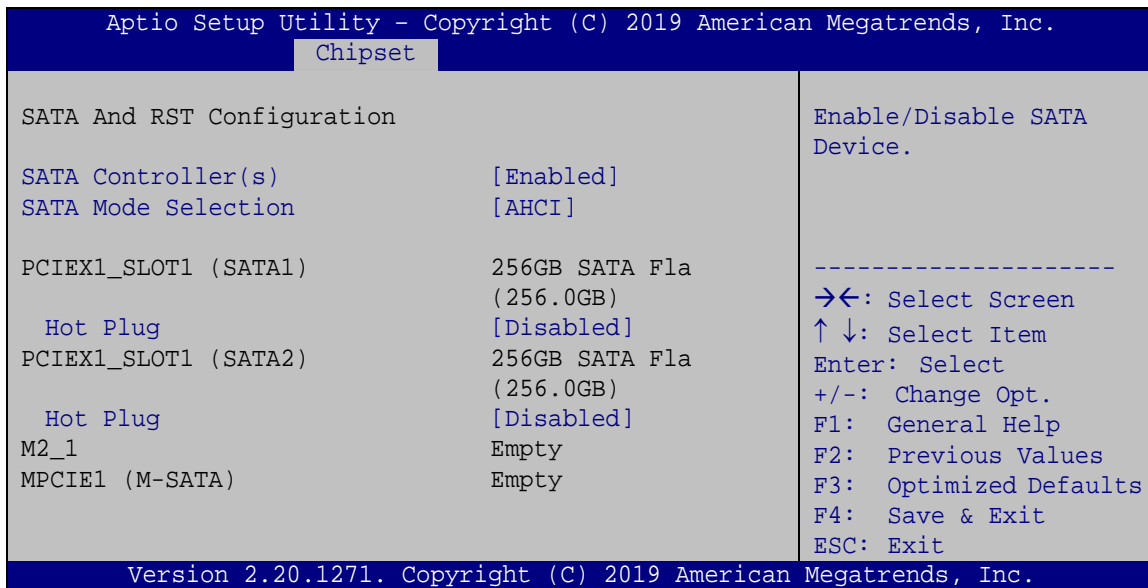

**BIOS Menu 20: SATA and RST Configuration**

➔ **SATA Controller(s) [Enabled]**

Use the **SATA Controller(s)** option to configure the SATA controller(s).

**PUZZLE-IN001A**

- ➔ **Enabled**      **DEFAULT**      Enables the on-board SATA controller(s).
- ➔ **Disabled**                      Disables the on-board SATA controller(s).

**➔ SATA Mode Selection [AHCI]**

Use the **SATA Mode Selection** option to determine how the SATA devices operate.

- ➔ **AHCI**                      **DEFAULT**      Configures SATA devices as AHCI device.
- ➔ **Intel RST Premium With Intel Optane System Acceleration**                      Configures SATA devices to the Intel RST Premium With Intel Optane System Acceleration mode.

**➔ Hot Plug**

Use the **Hot Plug** option to enable or disable the hot plug function.

- ➔ **Disabled**      **DEFAULT**      Disables the hot plug function.
- ➔ **Enabled**                      Enables the hot plug function.



### 4.4.2.3 Network Configuration (Bypass Setting)

Use the **Network Configuration (Bypass Setting)** menu (**BIOS Menu 21**) to configure the bypass settings of the IEI networking module slots.

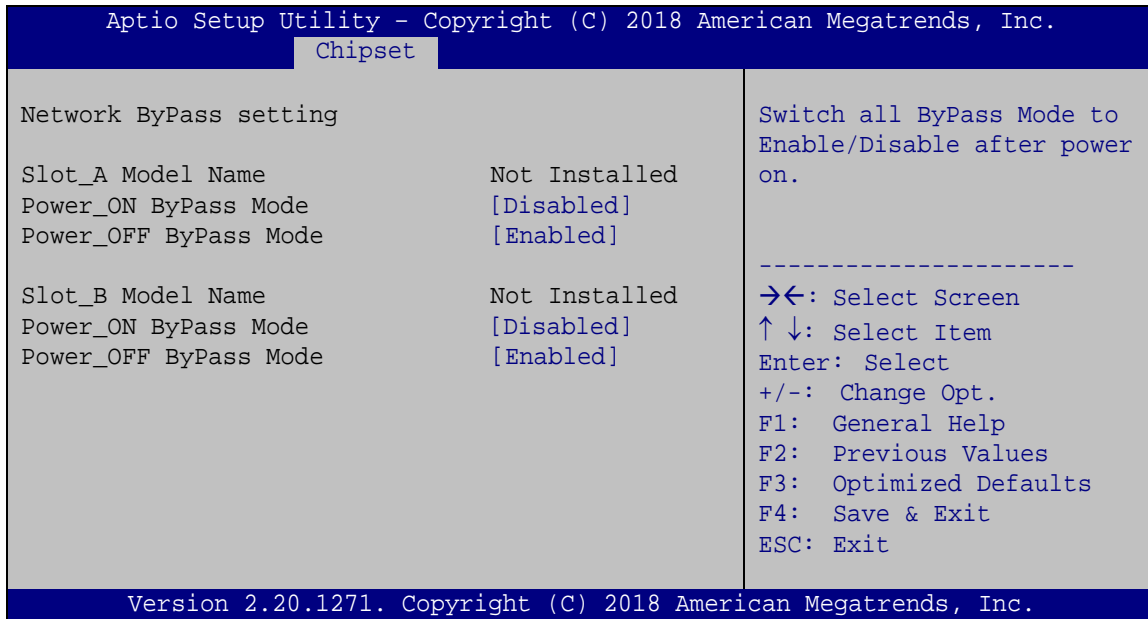

#### BIOS Menu 21: Network Configuration (Bypass Setting)

##### → Power\_ON ByPass Mode [Disabled]

Use the **Power\_ON ByPass Mode** option to enable or disable bypass function of the installed PuIM module when the PUZZLE-IN001A is on.

- **Disabled**    **DEFAULT**    Bypass is disabled when the system is on.
- **Enabled**                    Bypass is enabled when the system is on.

##### → Power\_OFF ByPass Mode [Enabled]

Use the **Power\_OFF ByPass Mode** option to enable or disable bypass function of the installed PuIM module when the PUZZLE-IN001A is off.

- **Disabled**    **DEFAULT**    Bypass is disabled when the system is off.
- **Enabled**                    Bypass is enabled when the system is off.

## PUZZLE-IN001A

### 4.5 Security

Use the **Security** menu (**BIOS Menu 22**) to set system and user passwords.

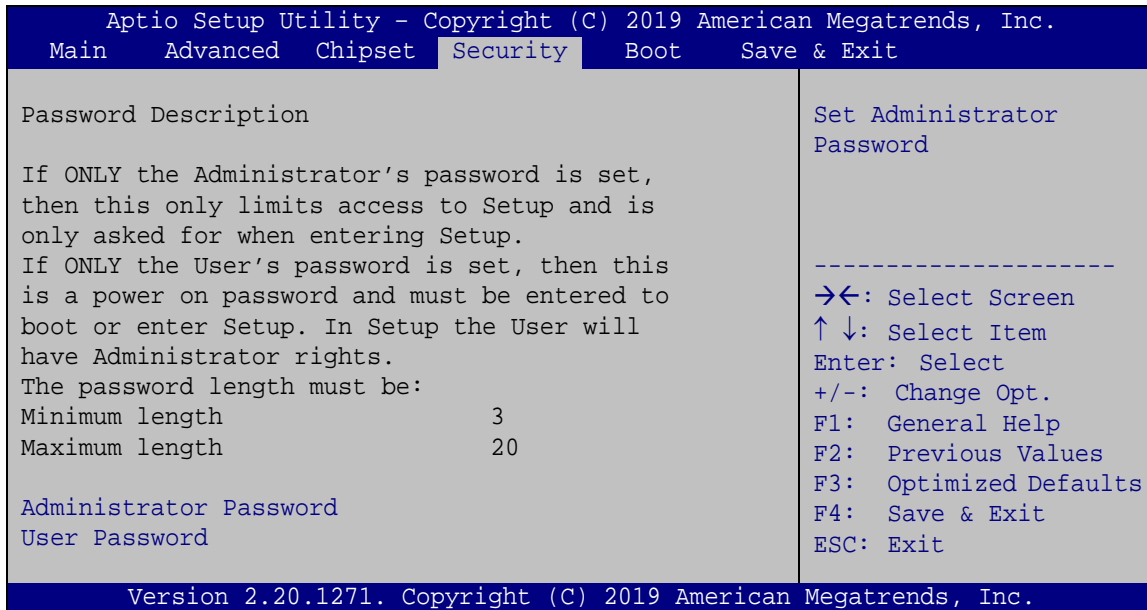

#### BIOS Menu 22: Security

##### → Administrator Password

Use the **Administrator Password** to set or change a administrator password.

##### → User Password

Use the **User Password** to set or change a user password.

## 4.6 Boot

Use the **Boot** menu (**BIOS Menu 23**) to configure system boot options.

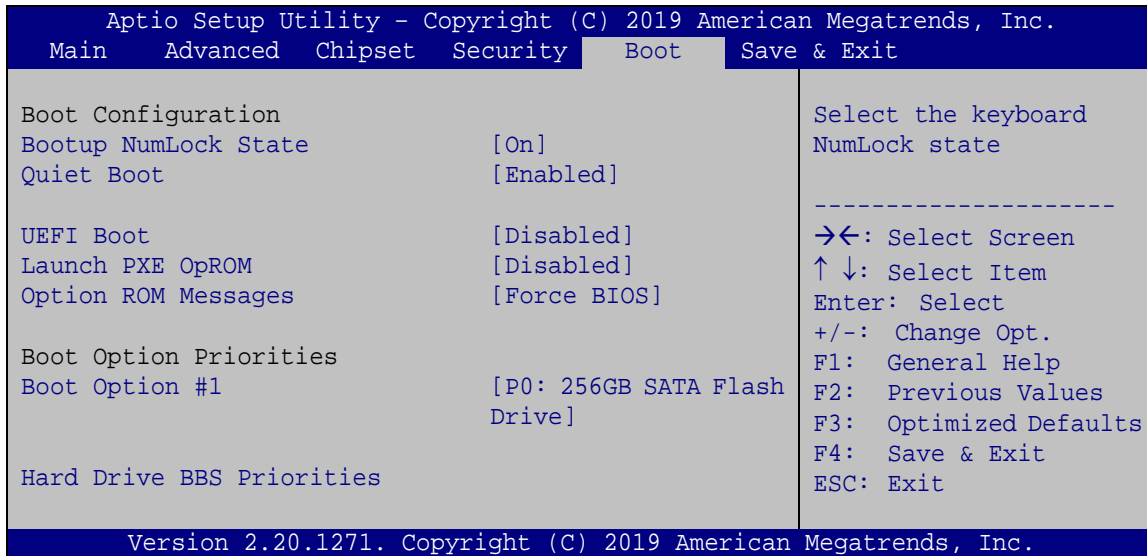

### BIOS Menu 23: Boot

#### → Bootup NumLock State [On]

Use the **Bootup NumLock State** BIOS option to specify if the number lock setting must be modified during boot up.

- **On**                      **DEFAULT**                      Allows the Number Lock on the keyboard to be enabled automatically when the computer system boots up. This allows the immediate use of the 10-key numeric keypad located on the right side of the keyboard. To confirm this, the Number Lock LED light on the keyboard is lit.
- **Off**    Does not enable the keyboard Number Lock automatically. To use the 10-keys on the keyboard, press the Number Lock key located on the upper left-hand corner of the 10-key pad. The Number Lock LED on the keyboard lights up when the Number Lock is engaged.

## PUZZLE-IN001A

### → Quiet Boot [Enabled]

Use the **Quiet Boot** BIOS option to select the screen display when the system boots.

- **Disabled** Normal POST messages displayed
- **Enabled** **DEFAULT** OEM Logo displayed instead of POST messages

### → UEFI Boot [Disabled]

Use the **UEFI Boot** option to enable or disable to boot from the UEFI devices.

- **Disabled** **DEFAULT** Boot from UEFI devices is disabled.
- **Enabled** Boot from UEFI devices is enabled.

### → Launch PXE OpROM [Disabled]

Use the **Launch PXE OpROM** option to enable or disable boot option for legacy network devices.

- **Disabled** **DEFAULT** Ignore all PXE Option ROMs
- **Enabled** Load PXE Option ROMs.

### → Option ROM Messages [Force BIOS]

Use the **Option ROM Messages** option to set the Option ROM display mode.

- **Force BIOS** **DEFAULT** Sets display mode to force BIOS.
- **Keep Current** Sets display mode to current.

## 4.7 Save & Exit

Use the **Safe & Exit** menu (**BIOS Menu 24**) to load default BIOS values, optimal failsafe values and to save configuration changes.

```

Aptio Setup Utility - Copyright (C) 2019 American Megatrends, Inc.
Main  Advanced  Chipset  Security  Boot  Save & Exit
-----
Save Changes and Reset
Discard Changes and Reset

Restore Defaults
Save as User Defaults
Restore User Defaults

Exit the system after
saving the changes.

-----
-><: Select Screen
↑ ↓: Select Item
Enter: Select
+/-: Change Opt.
F1: General Help
F2: Previous Values
F3: Optimized Defaults
F4: Save & Exit
ESC: Exit

Version 2.20.1271. Copyright (C) 2019 American Megatrends, Inc.

```

### BIOS Menu 24: Save & Exit

#### → Save Changes and Reset

Use the **Save Changes and Reset** option to save the changes made to the BIOS options and reset the system.

#### → Discard Changes and Reset

Use the **Discard Changes and Reset** option to exit the system without saving the changes made to the BIOS configuration setup program.

#### → Restore Defaults

Use the **Restore Defaults** option to load the optimal default values for each of the parameters on the Setup menus. **F3 key can be used for this operation.**

#### → Save as User Defaults

Use the **Save as User Defaults** option to save the changes done so far as user defaults.

#### → Restore User Defaults

Use the **Restore User Defaults** option to restore the user defaults to all the setup options.



Chapter

**5**

# Interface Connectors

---

## 5.1 Peripheral Interface Connectors

The connector locations of the PUZZLE-IN001A's motherboard are shown below. The connector pinouts for these connectors are listed in the following sections.

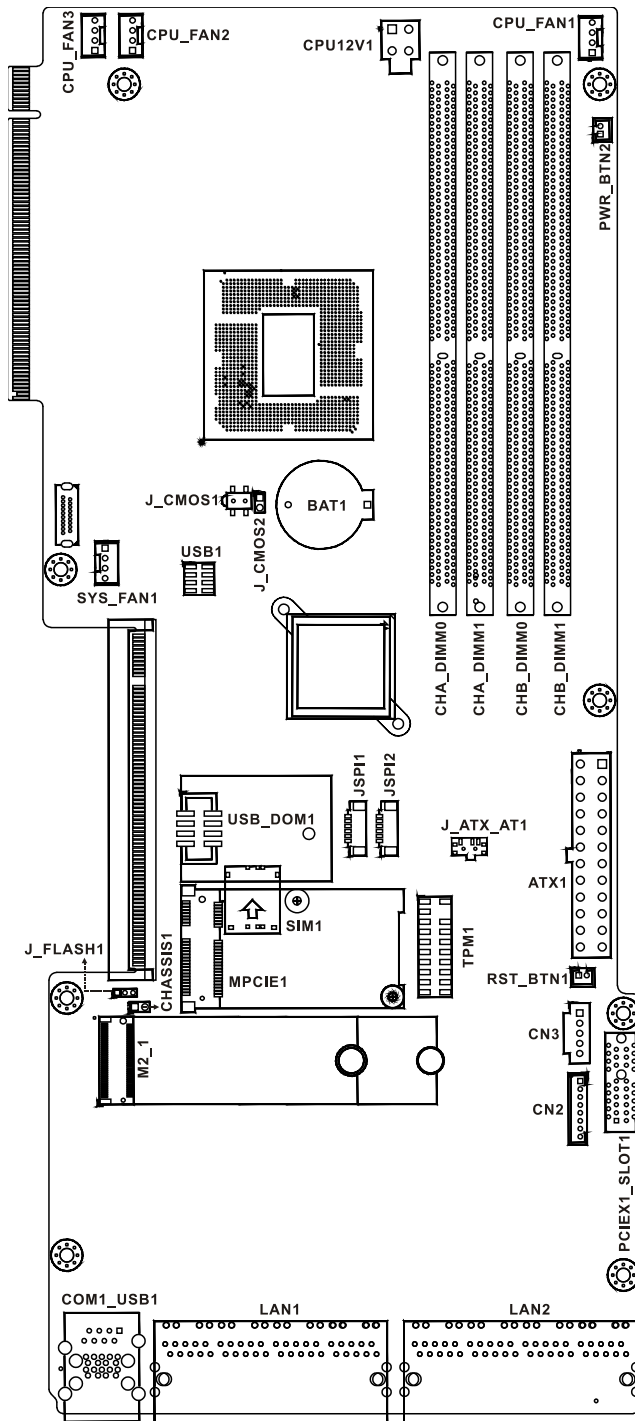

## PUZZLE-IN001A

## 5.2 Internal Peripheral Connectors

Internal peripheral connectors on the motherboard and are only accessible when the motherboard is outside of the chassis. The table below shows a list of the connectors on the motherboard. Pinouts of these connectors can be found in the following sections.

Connector	Type	Label
ATX power connector	24-pin connector	ATX1
ATX PSU SMBus connector	5-pin wafer	CN3
CPU power connector	4-pin connector	CPU12V1
Chassis intrusion connector	2-pin header	CHASSIS1
Fan connectors	4-pin wafer	CPU_FAN1, CPU_FAN2, CPU_FAN3, SYS_FAN1
LCM connector	8-pin wafer	CN2
M.2 B-key slot	M.2 B-key 3042/2260	M2_1
Memory slots	DDR4 DIMM slot	CHA_DIMM0, CHA_DIMM1, CHB_DIMM0, CHB_DIMM1
PCIe Mini slot	Full/Half-size PCIe Mini	MPCIE1
Power button connector	2-pin wafer	PWR_BTN2
Reset button connector	2-pin wafer	RST_BTN1
SATA 6Gb/s socket	36-pin socket	PCIEX1_SLOT1
SPI flash connector	6-pin wafer	JSPI1
SPI flash connector (EC)	6-pin wafer	JSPI2
TPM connector	20-pin header	TPM1
USB 2.0 connector	8-pin header	USB1

**Table 5-1: Peripheral Interface Connectors**

### 5.2.1 ATX Power Connector (ATX1)

Pin	Description	Pin	Description
1	+3.3 V	13	+3.3 V
2	+3.3 V	14	-12 V
3	GND	15	GND
4	+5 V	16	PS-ON
5	GND	17	GND
6	+5 V	18	GND
7	GND	19	GND
8	PW-OK	20	N/C
9	+5VSB	21	+5 V
10	+12V	22	+5 V
11	+12V	23	+5 V
12	+3.3 V	24	GND

**Table 5-2: ATX Power Connector Pinouts**

### 5.2.2 ATX PSU SMBus Connector (CN3)

PIN NO.	DESCRIPTION
1	SMCLKO_EC
2	SMDATO_EC
3	NC
4	GND
5	NC

**Table 5-3: ATX PSU SMBus Connector (CN3) Pinouts**

## PUZZLE-IN001A

### 5.2.3 CPU Power Connector (CPU12V1)

Pin	Description
1	GND
2	GND
3	+12 V
4	+12 V

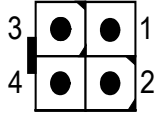

**Table 5-4: CPU Power Connector (CPU12V1) Pinouts**

### 5.2.4 Chassis Intrusion Connector (CHASSIS1)

PIN NO.	DESCRIPTION
1	+3.3VSB
2	CHASSIS OPEN

**Table 5-5: Chassis Intrusion Connector (CHASSIS1) Pinouts**

### 5.2.5 Fan Connectors (CPU\_FAN1/2/3, SYS\_FAN1)

PIN NO.	DESCRIPTION
1	GND
2	+12V
3	FANIO
4	PWM

**Table 5-6: Fan Connectors (CPU\_FAN1/2/3, SYS\_FAN1) Pinouts**

### 5.2.6 LCM Connector (CN2)

PIN NO.	DESCRIPTION
1	VCC5V
2	Power button
3	LCM RX
4	LCM TX



5	HDD LED
6	Alert LED
7	Reset button
8	GND

**Table 5-7: LCM Connector (CN2) Pinouts**

### 5.2.7 M.2 Slot (M2\_1)

PIN NO.	DESCRIPTION	PIN NO.	DESCRIPTION
1	CONFIG_3	2	+3.3V
3	GND	4	+3.3V
5	GND	6	N/C
7	USB_D+	8	N/C
9	USB_D-	10	N/C
11	Notch	12	Notch
13	Notch	14	Notch
15	Notch	16	Notch
17	Notch	18	Notch
19	Notch	20	N/C
21	CONFIG_0	22	N/C
23	N/C	24	N/C
25	N/C	26	N/C
27	GND	28	N/C
29	USB3.0-RX-	30	N/C
31	USB3.0-RX+	32	N/C
33	GND	34	N/C
35	USB3.0-TX-	36	N/C
37	USB3.0-TX+	38	N/C
39	GND	40	N/C
41	PETNO/SATA-B+	42	N/C
43	PETPO/SATA-B-	44	N/C
45	GND	46	N/C

## PUZZLE-IN001A

PIN NO.	DESCRIPTION	PIN NO.	DESCRIPTION
47	PERNO/SATA-A-	48	N/C
49	PERPO/SATA-A+	50	PERST#
51	GND	52	CLKREQ#
53	REFCLKN	54	PEWAKE
55	REFCLKP	56	N/C
57	GND	58	N/C
59	N/C	60	N/C
61	N/C	62	N/C
63	N/C	64	N/C
65	N/C	66	N/C
67	PESET_N	68	N/C
69	N/C	70	+3.3V
71	GND	72	+3.3V
73	GND	74	+3.3V
75	N/C		

**Table 5-8: M.2 Slot (M2\_1) Pinouts**

### 5.2.8 PCIe Mini Card Slot (MPCIE1)

PIN NO.	DESCRIPTION	PIN NO.	DESCRIPTION
1	PCIE_WAKE#	2	+3.3V
3	N/C	4	GND
5	N/C	6	1.5V
7	N/C	8	N/C
9	GND	10	N/C
11	MSATA_CLK#	12	N/C
13	MSATA_CLK	14	N/C
15	GND	16	N/C
17	PLTRST_N	18	GND
19	N/C	20	+3.3V
21	GND	22	PLTRST_N

PIN NO.	DESCRIPTION	PIN NO.	DESCRIPTION
23	PERNO/SATA_RX+	24	+3.3V
25	PERPO/SATA_RX-	26	GND
27	GND	28	1.5V
29	GND	30	SMB_CLK
31	PETNO/SATA_TX-	32	SMB_DATA
33	PETPO/SATA_TX+	34	GND
35	GND	36	USB_DATA-
37	GND	38	USB_DATA+
39	+3.3V	40	GND
41	+3.3V	42	N/C
43	+3.3V	44	N/C
45	CLINK_CLK	46	N/C
47	CLINK_DATA	48	1.5V
49	CLINK_RST#	50	GND
51	MSATA_DET	52	+3.3V

**Table 5-9: PCIe Mini Card Slot (MPCIE1) Pinouts**

### 5.2.9 Power Button Connector (PWR\_BTN2)

PIN NO.	DESCRIPTION
1	PWRBTN_SW#
2	GND

**Table 5-10: Power Button Connector (PWR\_BTN2) Pinouts**

### 5.2.10 Reset Button Connector (RST\_BTN1)

PIN NO.	DESCRIPTION
1	EXTRST-
2	GND

**Table 5-11: Reset Button Connector (RST\_BTN1) Pinouts**

## PUZZLE-IN001A

### 5.2.11 SATA Connector (PCIEX1\_SLOT1)

PIN NO.	DESCRIPTION	PIN NO.	DESCRIPTION
B1	+V12S	A1	N/C
B2	+V12S	A2	+V12S
B3	+V12S	A3	+V12S
B4	GND	A4	GND
B5	SATA_TX2-	A5	+V5S
B6	SATA_TX2+	A6	+V5S
B7	GND	A7	SATA_RX2-
B8	+V3.3S	A8	SATA RX2+
B9	+V5S	A9	+V3.3S
B10	N/C	A10	+V3.3S
B11	+V5S	A11	+V5S
B12	+V5S	A12	GND
B13	GND	A13	N/C
B14	SATA_TX1-	A14	N/C
B15	SATA_TX1+	A15	GND
B16	GND	A16	SATA_RX1-
B17	+V5S	A17	SATA RX1+
B18	GND	A18	GND

**Table 5-12: SATA 6Gb/s Connector (PCIEX1\_SLOT1) Pinouts**

### 5.2.12 SPI Flash Connector (JSPI1)

PIN NO.	DESCRIPTION
1	+3.3V
2	SPI_CS
3	SPI_SO
4	SPI_CLK
5	SPI_SI
6	GND

**Table 5-13: SPI Flash Connector (JSPI1) Pinouts**

### 5.2.13 SPI Flash Connector - EC (JSPI2)

PIN NO.	DESCRIPTION
1	+3.3V
2	SPI_CS#0_CN_EC
3	SPI_SO_SW_EC
4	SPI_CLK_SW_EC
5	SPI_SI_SW_EC
6	GND

**Table 5-14: SPI Flash Connector - EC (JSPI2) Pinouts**

### 5.2.14 TPM Connector (TPM1)

PIN NO.	DESCRIPTION	PIN NO.	DESCRIPTION
1	LCLK	2	GND
3	LFRAME#	4	KEY
5	LRERST#	6	+5V
7	LAD3	8	LAD2
9	+3.3V	10	LAD1
11	LAD0	12	GND
13	SCL	14	SDA
15	SB3V	16	SERIRQ
17	GND	18	GLKRUN#
19	LPCPD#	20	LDRO#

**Table 5-15: TPM Connector (TPM1) Pinouts**



## PUZZLE-IN001A

### 5.2.15 USB 2.0 Connector (USB1)

PIN NO.	DESCRIPTION	PIN NO.	DESCRIPTION
1	VCC	2	GND
3	USB_DATA-	4	USB_DATA+
5	USB_DATA+	6	USB_DATA-
7	GND	8	VCC

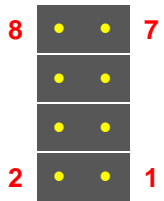

**Table 5-16: USB 2.0 Connector (USB1) Pinouts**

### 5.2.16 IEI Networking Module Slot A

PIN NO.	DESCRIPTION	PIN NO.	DESCRIPTION
B1	+12v	A1	NC
B2	+12v	A2	+12v
B3	+12v	A3	+12v
B4	GND	A4	GND
B5	SMCLK	A5	NC
B6	SMDAT	A6	NC
B7	GND	A7	NC
B8	+3.3v	A8	NC
B9	NC	A9	+3.3v
B10	3.3Vaux	A10	+3.3v
B11	WAKE#	A11	PWRGD
B12	NC	A12	GND
B13	GND	A13	REFCLK+
B14	HSOp(0)	A14	REFCLK-
B15	HSOn(0)	A15	GND
B16	GND	A16	HSIp(0)
B17	RLYCTL1*	A17	HSIn(0)
B18	GND	A18	GND
B19	HSOp(1)	A19	LANID1**
B20	HSOn(1)	A20	GND
B21	GND	A21	HSIp(1)

B22	GND	A22	HSIn(1)
B23	HSOp(2)	A23	GND
B24	HSOn(2)	A24	GND
B25	GND	A25	HSIp(2)
B26	GND	A26	HSIn(2)
B27	HSOp(3)	A27	GND
B28	HSOn(3)	A28	GND
B29	GND	A29	HSIp(3)
B30	RLYCTL2*	A30	HSIn(3)
B31	NC	A31	GND
B32	GND	A32	LANID2**
B33	HSOp(4)	A33	NC
B34	HSOn(4)	A34	GND
B35	GND	A35	HSIp(4)
B36	GND	A36	HSIn(4)
B37	HSOp(5)	A37	GND
B38	HSOn(5)	A38	GND
B39	GND	A39	HSIp(5)
B40	GND	A40	HSIn(5)
B41	HSOp(6)	A41	GND
B42	HSOn(6)	A42	GND
B43	GND	A43	HSIp(6)
B44	GND	A44	HSIn(6)
B45	HSOp(7)	A45	GND
B46	HSOn(7)	A46	GND
B47	GND	A47	HSIp(7)
B48	NC	A48	HSIn(7)
B49	GND	A49	GND
<p>*PIN B17 &amp; B30 is assigned to Relay control signal; it is only active when inserting a specific LAN module that supports LAN bypass function.</p> <p>**PIN A19 &amp; A32 is identification of PCIe Link configuration. See <b>Table 5-19</b> for PCIe Link configuration.</p>			

**Table 5-17: IEI Networking Module Slot A Pinouts**

**PUZZLE-IN001A**

**5.2.17 IEI Networking Module Slot B**

PIN NO.	DESCRIPTION	PIN NO.	DESCRIPTION
B1	+12v	A1	NC
B2	+12v	A2	+12v
B3	+12v	A3	+12v
B4	GND	A4	GND
B5	SMCLK	A5	NC
B6	SMDAT	A6	NC
B7	GND	A7	NC
B8	+3.3v	A8	NC
B9	NC	A9	+3.3v
B10	3.3Vaux	A10	+3.3v
B11	WAKE#	A11	PWRGD
B12	NC	A12	GND
B13	GND	A13	REFCLK+
B14	HSOp(0)	A14	REFCLK-
B15	HSOn(0)	A15	GND
B16	GND	A16	HSIp(0)
B17	RLYCTL1*	A17	HSIn(0)
B18	GND	A18	GND
B19	HSOp(1)	A19	LANID1**
B20	HSOn(1)	A20	GND
B21	GND	A21	HSIp(1)
B22	GND	A22	HSIn(1)
B23	HSOp(2)	A23	GND
B24	HSOn(2)	A24	GND
B25	GND	A25	HSIp(2)
B26	GND	A26	HSIn(2)
B27	HSOp(3)	A27	GND
B28	HSOn(3)	A28	GND
B29	GND	A29	HSIp(3)
B30	RLYCTL2*	A30	HSIn(3)

B31	NC	A31	GND
B32	GND	A32	LANID2**
B33	HSOp(4)	A33	NC
B34	HSOn(4)	A34	GND
B35	GND	A35	HSIp(4)
B36	GND	A36	HSIn(4)
B37	HSOp(5)	A37	GND
B38	HSOn(5)	A38	GND
B39	GND	A39	HSIp(5)
B40	GND	A40	HSIn(5)
B41	HSOp(6)	A41	GND
B42	HSOn(6)	A42	GND
B43	GND	A43	HSIp(6)
B44	GND	A44	HSIn(6)
B45	HSOp(7)	A45	GND
B46	HSOn(7)	A46	GND
B47	GND	A47	HSIp(7)
B48	NC	A48	HSIn(7)
B49	GND	A49	GND

\*PIN B17 & B30 is assigned to Relay control signal; it is only active when inserting a specific LAN module that supports LAN bypass function.

\*\*PIN A19 & A32 is identification of PCIe Link configuration. See **Table 5-19** for PCIe Link configuration.

**Table 5-18: IEI Networking Module Slot B Pinouts**

A19	A32	PCIe Config.
0	0	Four x2
0	1	Two x4
1	0	One x8

**Table 5-19: PCIe Link Configuration**

Appendix

A

# Regulatory Compliance

---



## DECLARATION OF CONFORMITY



This equipment is in conformity with the following EU directives:

- EMC Directive 2014/30/EU
- Low-Voltage Directive 2014/35/EU
- RoHS II Directive 2015/863/EU

If the user modifies and/or install other devices in the equipment, the CE conformity declaration may no longer apply.

If this equipment has telecommunications functionality, it also complies with the requirements of the R&TTE Directive 1999/5/EC.

---

English

IEI Integration Corp declares that this equipment is in compliance with the essential requirements and other relevant provisions of Directive 1999/5/EC.

---

Български [Bulgarian]

IEI Integration Corp. декларира, че този оборудване е в съответствие със съществените изисквания и другите приложими правила на Директива 1999/5/EC.

---

Česky [Czech]

IEI Integration Corp tímto prohlašuje, že tento zařizení je ve shodě se základními požadavky a dalšími příslušnými ustanoveními směrnice 1999/5/ES.

---

Dansk [Danish]

IEI Integration Corp erklærer herved, at følgende udstyr overholder de væsentlige krav og øvrige relevante krav i direktiv 1999/5/EF.

---

Deutsch [German]

IEI Integration Corp, erklärt dieses Gerät entspricht den grundlegenden Anforderungen und den weiteren entsprechenden Vorgaben der Richtlinie 1999/5/EU.

---

Eesti [Estonian]

IEI Integration Corp deklareerib seadme seadme vastavust direktiivi 1999/5/EÜ põhinõuetele ja nimetatud direktiivist tulenevatele teistele asjakohastele sätetele.

---

**PUZZLE-IN001A**

---

**Español [Spanish]**

IEI Integration Corp declara que el equipo cumple con los requisitos esenciales y cualesquiera otras disposiciones aplicables o exigibles de la Directiva 1999/5/CE.

---

**Ελληνική [Greek]**

IEI Integration Corp ΔΗΛΩΝΕΙ ΟΤΙ ΕΞΟΠΛΙΣΜΟΣ ΣΥΜΜΟΡΦΩΝΕΤΑΙ ΠΡΟΣ ΤΙΣ ΟΥΣΙΩΔΕΙΣ ΑΠΑΙΤΗΣΕΙΣ ΚΑΙ ΤΙΣ ΛΟΙΠΕΣ ΣΧΕΤΙΚΕΣ ΔΙΑΤΑΞΕΙΣ ΤΗΣ ΟΔΗΓΙΑΣ 1999/5/EK.

---

**Français [French]**

IEI Integration Corp déclare que l'appareil est conforme aux exigences essentielles et aux autres dispositions pertinentes de la directive 1999/5/CE.

---

**Italiano [Italian]**

IEI Integration Corp dichiara che questo apparecchio è conforme ai requisiti essenziali ed alle altre disposizioni pertinenti stabilite dalla direttiva 1999/5/CE.

---

**Latviski [Latvian]**

IEI Integration Corp deklarē, ka iekārta atbilst būtiskajām prasībām un citiem ar to saistītajiem noteikumiem Direktīvas 1999/5/EK.

---

**Lietuvių [Lithuanian]**

IEI Integration Corp deklaruoja, kad šis įranga atitinka esminius reikalavimus ir kitas 1999/5/EB Direktyvos nuostatas.

---

**Nederlands [Dutch]**

IEI Integration Corp dat het toestel toestel in overeenstemming is met de essentiële eisen en de andere relevante bepalingen van richtlijn 1999/5/EG.

---

**Malti [Maltese]**

IEI Integration Corp jiddikjara li dan prodott jikkonforma mal-ħtiġijiet essenzjali u ma provvedimenti oħrajn relevanti li hemm fid-Direttiva 1999/5/EC.

---

**Magyar [Hungarian]**

IEI Integration Corp nyilatkozom, hogy a berendezés megfelel a vonatkozó alapvető követelményeknek és az 1999/5/EC irányelv egyéb előírásainak.

---

**Polski [Polish]**

IEI Integration Corp oświadcza, że wyrobu jest zgodny z zasadniczymi wymogami oraz pozostałymi stosownymi postanowieniami Dyrektywy 1999/5/EC.

---

**Português [Portuguese]**

IEI Integration Corp declara que este equipamento está conforme com os requisitos essenciais e outras disposições da Directiva 1999/5/CE.

---

---

Româna [Romanian]

IEI Integration Corp declară că acest echipament este în conformitate cu cerințele esențiale și cu celelalte prevederi relevante ale Directivei 1999/5/CE.

---

Slovensko [Slovenian]

IEI Integration Corp izjavlja, da je ta opreme v skladu z bistvenimi zahtevami in ostalimi relevantnimi določili direktive 1999/5/ES.

---

Slovensky [Slovak]

IEI Integration Corp týmto vyhlasuje, že zariadenia spĺňa základné požiadavky a všetky príslušné ustanovenia Smernice 1999/5/ES.

---

Suomi [Finnish]

IEI Integration Corp vakuuttaa täten että laitteet on direktiivin 1999/5/EY oleellisten vaatimusten ja sitä koskevien direktiivin muiden ehtojen mukainen.

---

Svenska [Swedish]

IEI Integration Corp förklarar att denna utrustningstyp står i överensstämmelse med de väsentliga egenskapskrav och övriga relevanta bestämmelser som framgår av direktiv 1999/5/EG.

---

**PUZZLE-IN001A****FCC WARNING**

This equipment complies with Part 15 of the FCC Rules. Operation is subject to the following two conditions:

- This device may not cause harmful interference, and
- This device must accept any interference received, including interference that may cause undesired operation.

This equipment has been tested and found to comply with the limits for a Class A digital device, pursuant to part 15 of the FCC Rules. These limits are designed to provide reasonable protection against harmful interference when the equipment is operated in a commercial environment. This equipment generates, uses, and can radiate radio frequency energy and, if not installed and used in accordance with the instruction manual, may cause harmful interference to radio communications. Operation of this equipment in a residential area is likely to cause harmful interference in which case the user will be required to correct the interference at his own expense.

**ROHS STATEMENT**

The label on the product indicates this product conforms to European (EU) Restriction of Hazardous Substances (RoHS) that set maximum concentration limits on hazardous materials used in electrical and electronic equipment.

**CHINA ROHS**

The label on the product indicates the estimated “Environmentally Friendly Use Period” (EFUP). This is an estimate of the number of years that these substances would “not leak out or undergo abrupt change.” This product may contain replaceable sub-assemblies/components which have a shorter EFUP such as batteries and lamps. These components will be separately marked.

Appendix

**B**

# Safety Precautions

---



## PUZZLE-IN001A

### B.1 Safety Precautions

---



#### WARNING:

The precautions outlined in this appendix should be strictly followed. Failure to follow these precautions may result in permanent damage to the PUZZLE-IN001A.

---

Please follow the safety precautions outlined in the sections that follow:

#### B.1.1 General Safety Precautions

Please ensure the following safety precautions are adhered to at all times.

- ***Make sure the power is turned off and the power cord is disconnected*** when moving, installing or modifying the system.
- ***Do not apply voltage levels that exceed the specified voltage range.*** Doing so may cause fire and/or an electrical shock.
- ***Electric shocks can occur*** if opened while still powered on.
- ***Do not drop or insert any objects*** into the ventilation openings.
- ***If considerable amounts of dust, water, or fluids enter the system***, turn off the power supply immediately, unplug the power cord, and contact the system vendor.
- **DO NOT:**
  - Drop the system against a hard surface.
  - In a site where the ambient temperature exceeds the rated temperature

### B.1.2 Anti-static Precautions

---

**WARNING:**

Failure to take ESD precautions during the installation of the PUZZLE-IN001A may result in permanent damage to the PUZZLE-IN001A and severe injury to the user.

---

Electrostatic discharge (ESD) can cause serious damage to electronic components, including the PUZZLE-IN001A. Dry climates are especially susceptible to ESD. It is therefore critical that whenever the PUZZLE-IN001A is opened and any of the electrical components are handled, the following anti-static precautions are strictly adhered to.

- ***Wear an anti-static wristband:*** Wearing a simple anti-static wristband can help to prevent ESD from damaging any electrical component.
- ***Self-grounding:*** Before handling any electrical component, touch any grounded conducting material. During the time the electrical component is handled, frequently touch any conducting materials that are connected to the ground.
- ***Use an anti-static pad:*** When configuring or working with an electrical component, place it on an anti-static pad. This reduces the possibility of ESD damage.
- ***Only handle the edges of the electrical component:*** When handling the electrical component, hold the electrical component by its edges.

## PUZZLE-IN001A

### B.1.3 Product Disposal

---



#### CAUTION:

Risk of explosion if the battery is replaced by an incorrect type;

Replacement of a battery with an incorrect type that can defeat a safeguard (for example, in the case of some lithium battery types);

Disposal of a battery into fire or a hot oven, or mechanically crushing or cutting of a battery, that can result in an explosion;

Leaving a battery in an extremely high temperature surrounding environment that can result in an explosion or the leakage of flammable liquid or gas;

A battery subjected to extremely low air pressure that may result in an explosion or the leakage of flammable liquid or gas.

Dispose of used batteries according to instructions and local regulations.

---

- Outside the European Union - If you wish to dispose of used electrical and electronic products outside the European Union, please contact your local authority so as to comply with the correct disposal method.
- Within the European Union:

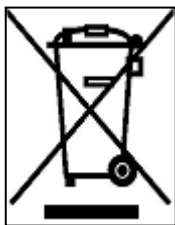

EU-wide legislation, as implemented in each Member State, requires that waste electrical and electronic products carrying the mark (left) must be disposed of separately from normal household waste. This includes monitors and electrical accessories, such as signal cables or power cords. When you need to dispose of your display products, please follow the guidance of your local authority, or ask the shop where you purchased the product. The mark on electrical and electronic products only applies to the current European Union Member States.

Please follow the national guidelines for electrical and electronic product disposal.

## B.2 Maintenance and Cleaning Precautions

When maintaining or cleaning the PUZZLE-IN001A, please follow the guidelines below.

### B.2.1 Maintenance and Cleaning

Prior to cleaning any part or component of the PUZZLE-IN001A, please read the details below.

- The interior of the PUZZLE-IN001A does not require cleaning. Keep fluids away from the PUZZLE-IN001A interior.
- Be cautious of all small removable components when vacuuming the PUZZLE-IN001A.
- Turn the PUZZLE-IN001A off before cleaning the PUZZLE-IN001A.
- Never drop any objects or liquids through the openings of the PUZZLE-IN001A.
- Be cautious of any possible allergic reactions to solvents or chemicals used when cleaning the PUZZLE-IN001A.
- Avoid eating, drinking and smoking within vicinity of the PUZZLE-IN001A.

### B.2.2 Cleaning Tools

Some components in the PUZZLE-IN001A may only be cleaned using a product specifically designed for the purpose. In such case, the product will be explicitly mentioned in the cleaning tips. Below is a list of items to use when cleaning the PUZZLE-IN001A.

- **Cloth** – Although paper towels or tissues can be used, a soft, clean piece of cloth is recommended when cleaning the PUZZLE-IN001A.
- **Water or rubbing alcohol** – A cloth moistened with water or rubbing alcohol can be used to clean the PUZZLE-IN001A.
- **Using solvents** – The use of solvents is not recommended when cleaning the PUZZLE-IN001A as they may damage the plastic parts.
- **Vacuum cleaner** – Using a vacuum specifically designed for computers is one of the best methods of cleaning the PUZZLE-IN001A. Dust and dirt can restrict the airflow in the PUZZLE-IN001A and cause its circuitry to corrode.
- **Swabs** - Swabs moistened with rubbing alcohol or water are excellent tools for wiping hard to reach areas. Whenever possible, it is best to use lint free swabs such as foam swabs for cleaning.

Appendix

C

# Error Beep Code

---



### C.1 PEI Beep Codes

Number of Beeps	Description
1	Memory not Installed
1	Memory was installed twice (InstallPeiMemory routine in PEI Core called twice)
2	Recovery started
3	DXE IPL was not found
3	DXE Core Firmware Volume was not found
4	Recovery failed
4	S3 Resume failed
7	Reset PPI is not available

### C.2 DXE Beep Codes

Number of Beeps	Description
1	Invalid password
4	Some of the Architectural Protocols are not available
5	No Console Output Devices are found
5	No Console Input Devices are found
6	Flash update is failed
7	Reset protocol is not available
8	Platform PCI resource requirements cannot be met



**NOTE:**

If you have any question, please contact IEI for further assistance.

Appendix

D

# Hazardous Materials Disclosure

---

### D.1 RoHS II Directive (2015/863/EU)

The details provided in this appendix are to ensure that the product is compliant with the RoHS II Directive (2015/863/EU). The table below acknowledges the presences of small quantities of certain substances in the product, and is applicable to RoHS II Directive (2015/863/EU).

Please refer to the following table.

Part Name	Toxic or Hazardous Substances and Elements									
	Lead (Pb)	Mercury (Hg)	Cadmium (Cd)	Hexavalent Chromium (CR(VI))	Polybrominated Biphenyls (PBB)	Polybrominated Diphenyl Ethers (PBDE)	Bis(2-ethylhexyl) phthalate (DEHP)	Butyl benzyl phthalate (BBP)	Dibutyl phthalate (DBP)	Diisobutyl phthalate (DIBP)
Housing	O	O	O	O	O	O	O	O	O	O
Display	O	O	O	O	O	O	O	O	O	O
Printed Circuit Board	O	O	O	O	O	O	O	O	O	O
Metal Fasteners	O	O	O	O	O	O	O	O	O	O
Cable Assembly	O	O	O	O	O	O	O	O	O	O
Fan Assembly	O	O	O	O	O	O	O	O	O	O
Power Supply Assemblies	O	O	O	O	O	O	O	O	O	O
Battery	O	O	O	O	O	O	O	O	O	O

O: This toxic or hazardous substance is contained in all of the homogeneous materials for the part is below the limit requirement in Directive (EU) 2015/863.

X: This toxic or hazardous substance is contained in at least one of the homogeneous materials for this part is above the limit requirement in Directive (EU) 2015/863.

## PUZZLE-IN001A

### D.2 China RoHS

此附件旨在确保本产品符合中国 RoHS 标准。以下表格标示此产品中某有毒物质的含量符合中国 RoHS 标准规定的限量要求。

本产品上会附有“环境友好使用期限”的标签，此期限是估算这些物质“不会有泄漏或突变”的年限。本产品可能包含有较短的环境友好使用期限的可替换元件，像是电池或灯管，这些元件将会单独标示出来。

部件名称	有毒有害物质或元素					
	铅 (Pb)	汞 (Hg)	镉 (Cd)	六价铬 (CR(VI))	多溴联苯 (PBB)	多溴二苯醚 (PBDE)
壳体	○	○	○	○	○	○
显示	○	○	○	○	○	○
印刷电路板	○	○	○	○	○	○
金属螺帽	○	○	○	○	○	○
电缆组装	○	○	○	○	○	○
风扇组装	○	○	○	○	○	○
电力供应组装	○	○	○	○	○	○
电池	○	○	○	○	○	○

○: 表示该有毒有害物质在该部件所有物质材料中的含量均在 SJ/T11364-2014 與 GB/T26572-2011 标准规定的限量要求以下。

X: 表示该有毒有害物质至少在该部件的某一均质材料中的含量超出 SJ/T11364-2014 與 GB/T26572-2011 标准规定的限量要求。