

**MODEL:
WAFFER-AL**

**3.5" SBC with 14nm Intel® Pentium®/Celeron® On-board SoC,
DP++, VGA, LVDS, Dual PCIe GbE, USB 3.0, PCIe Mini, mSATA,
SATA 6Gb/s, RS-232/422/485, HD Audio, SIM Slot and RoHS**

User Manual

Rev. 1.01 - May 3, 2018



Revision

Date	Version	Changes
May 3, 2018	1.01	Deleted E series SKUs Updated Chapter 6: Software Drivers
November 30, 2017	1.00	Initial release

Copyright

COPYRIGHT NOTICE

The information in this document is subject to change without prior notice in order to improve reliability, design and function and does not represent a commitment on the part of the manufacturer.

In no event will the manufacturer be liable for direct, indirect, special, incidental, or consequential damages arising out of the use or inability to use the product or documentation, even if advised of the possibility of such damages.

This document contains proprietary information protected by copyright. All rights are reserved. No part of this manual may be reproduced by any mechanical, electronic, or other means in any form without prior written permission of the manufacturer.

TRADEMARKS

All registered trademarks and product names mentioned herein are used for identification purposes only and may be trademarks and/or registered trademarks of their respective owners.

Manual Conventions



WARNING

Warnings appear where overlooked details may cause damage to the equipment or result in personal injury. Warnings should be taken seriously.



CAUTION

Cautionary messages should be heeded to help reduce the chance of losing data or damaging the product.



NOTE

These messages inform the reader of essential but non-critical information. These messages should be read carefully as any directions or instructions contained therein can help avoid making mistakes.



HOT SURFACE

This symbol indicates a hot surface that should not be touched without taking care.

Table of Contents

1 INTRODUCTION.....	1
1.1 INTRODUCTION.....	2
1.2 MODEL VARIATIONS	3
1.3 FEATURES.....	3
1.4 CONNECTORS	4
1.5 DIMENSIONS.....	6
1.6 DATA FLOW	7
1.7 TECHNICAL SPECIFICATIONS	8
2 UNPACKING	10
2.1 ANTI-STATIC PRECAUTIONS	11
2.2 UNPACKING PRECAUTIONS.....	11
2.3 PACKING LIST.....	12
2.4 OPTIONAL ITEMS	13
3 CONNECTORS	14
3.1 PERIPHERAL INTERFACE CONNECTORS.....	15
3.1.1 WAFER-AL Layout.....	15
3.1.2 Peripheral Interface Connectors	16
3.1.3 External Interface Panel Connectors.....	17
3.2 INTERNAL PERIPHERAL CONNECTORS	18
3.2.1 +12V DC-IN Power Connector	18
3.2.2 Audio Connector	19
3.2.3 Battery Connector.....	20
3.2.4 Digital I/O Connector.....	21
3.2.5 Fan Connector	22
3.2.6 iDP Connector (Optional)	23
3.2.7 LVDS Backlight Inverter Connector	24
3.2.8 LVDS LCD Connector	25
3.2.9 LAN LED Connectors	26
3.2.10 mSATA Module Slot.....	27

3.2.11	<i>PCIe Mini Card Slot</i>	29
3.2.12	<i>Power and HDD LED Connector</i>	31
3.2.13	<i>Power Button Connector</i>	32
3.2.14	<i>Reset Button Connector</i>	33
3.2.15	<i>RS-232 Serial Port Connectors</i>	34
3.2.16	<i>RS-232/422/485 Serial Port Connectors</i>	35
3.2.17	<i>SATA 6Gb/s Connectors</i>	36
3.2.18	<i>SATA Power Connectors</i>	37
3.2.19	<i>SIM Card Slot</i>	38
3.2.20	<i>SMBus/I²C Connector</i>	38
3.2.21	<i>SPI Flash Connector</i>	39
3.2.22	<i>TPM Connector</i>	40
3.2.23	<i>USB 2.0 Connectors</i>	41
3.3	EXTERNAL PERIPHERAL INTERFACE CONNECTOR PANEL	42
3.3.1	<i>DisplayPort++ Connector</i>	42
3.3.2	<i>LAN Connectors</i>	44
3.3.3	<i>USB Connectors</i>	44
3.3.4	<i>VGA Connector</i>	45
4	INSTALLATION	47
4.1	ANTI-STATIC PRECAUTIONS	48
4.2	INSTALLATION CONSIDERATIONS	48
4.3	SO-DIMM INSTALLATION	50
4.4	mSATA MODULE INSTALLATION	50
4.4.1	<i>Full-size mSATA Module Installation</i>	51
4.4.2	<i>Half-size mSATA Module Installation</i>	52
4.5	PCIe MINI CARD INSTALLATION	55
4.6	SIM CARD INSTALLATION	55
4.7	SYSTEM CONFIGURATION	57
4.7.1	<i>AT/ATX Mode Select Switch</i>	57
4.7.2	<i>Clear CMOS Button</i>	58
4.7.3	<i>LVDS Voltage Select Jumper</i>	59
4.7.4	<i>LVDS Backlight Mode Select Jumper</i>	60
4.7.5	<i>LVDS Panel Resolution Select Switch</i>	61
4.7.6	<i>RS-232/422/485 Mode Select Switch</i>	62

WAFER-AL SBC

4.8 CHASSIS INSTALLATION.....	63
4.8.1 Airflow.....	63
4.8.2 Motherboard Installation.....	63
4.9 INTERNAL PERIPHERAL DEVICE CONNECTIONS.....	63
4.9.1 Audio Kit Installation.....	63
4.9.2 AT Power Connection.....	64
4.9.3 SATA Drive Connection.....	66
5 BIOS.....	68
5.1 INTRODUCTION.....	69
5.1.1 Starting Setup.....	69
5.1.2 Using Setup.....	69
5.1.3 Getting Help.....	70
5.1.4 Unable to Reboot after Configuration Changes.....	70
5.1.5 BIOS Menu Bar.....	70
5.2 MAIN.....	71
5.3 ADVANCED.....	72
5.3.1 Trusted Computing.....	73
5.3.2 ACPI Settings.....	74
5.3.3 F81866 Super IO Configuration.....	75
5.3.3.1 Serial Port n Configuration.....	75
5.3.3.1.1 Serial Port 1 Configuration.....	76
5.3.3.1.2 Serial Port 2 Configuration.....	77
5.3.3.1.3 Serial Port 3 Configuration.....	78
5.3.3.1.4 Serial Port 4 Configuration.....	79
5.3.4 F81866 H/W Monitor.....	80
5.3.4.1 Smart Fan Mode Configuration.....	81
5.3.5 USB Configuration.....	82
5.3.6 CPU Configuration.....	84
5.3.7 RTC Wake Settings.....	86
5.3.8 Power Saving Configuration.....	87
5.3.9 Serial Port Console Redirection.....	88
5.3.9.1 Legacy Console Redirection Settings.....	89
5.3.10 IEI Feature.....	90
5.4 CHIPSET.....	91

5.4.1 North Bridge Configuration.....	92
5.4.1.1 Intel IGD Configuration.....	92
5.4.2 South Bridge Configuration.....	94
5.4.2.1 HD-Audio Configuration	96
5.4.2.2 PCI Express Configuration	97
5.4.2.2.1 Onboard LAN	98
5.4.2.2.2 MINI-PCIE	99
5.4.2.3 SATA Configuration.....	100
5.5 SECURITY.....	101
5.6 BOOT.....	102
5.7 SAVE & EXIT	104
6 SOFTWARE DRIVERS	106
6.1 AVAILABLE DRIVERS	107
6.2 DRIVER DOWNLOAD	108
A REGULATORY COMPLIANCE	110
B PRODUCT DISPOSAL	112
C BIOS MENU OPTIONS.....	114
D DIGITAL I/O INTERFACE.....	117
E WATCHDOG TIMER.....	120
F HAZARDOUS MATERIALS DISCLOSURE.....	123

List of Figures

Figure 1-1: WAFER-AL	2
Figure 1-2: Connectors (Front Side).....	4
Figure 1-3: Connectors (Solder Side).....	5
Figure 1-4: Dimensions with Heatsink (mm).....	6
Figure 1-5: Data Flow Diagram.....	7
Figure 3-1: Connector and Jumper Locations (Front Side)	15
Figure 3-2: Connector and Jumper Locations (Solder Side)	15
Figure 3-3: +12V DC-IN Power Connector Location.....	18
Figure 3-4: Audio Connector Location.....	19
Figure 3-5: Battery Connector Location.....	20
Figure 3-6: Digital I/O Connector Location	21
Figure 3-7: Fan Connector Location.....	22
Figure 3-8: iDP Connector Location	23
Figure 3-9: Backlight Inverter Connector Location.....	24
Figure 3-10: LVDS Connector Location.....	25
Figure 3-11: LAN LED Connector Locations	26
Figure 3-12: mSATA Module Slot Location.....	28
Figure 3-13: PCIe Mini Card Slot Location.....	29
Figure 3-14: Power and HDD LED Connector Location.....	31
Figure 3-15: Power Button Connector Location.....	32
Figure 3-16: Reset Button Connector Location.....	33
Figure 3-17: RS-232 Serial Port Connector Locations.....	34
Figure 3-18: RS-232/422/485 Connector Locations.....	35
Figure 3-19: SATA 6Gb/s Connector Locations	36
Figure 3-20: SATA Power Connector Locations	37
Figure 3-21: SIM Card Slot Location.....	38
Figure 3-22: SMBus/I ² C Connector Location.....	38
Figure 3-23: SPI Flash Connector Location.....	39
Figure 3-24: TPM Connector Location.....	40
Figure 3-25: USB Connector Locations.....	41
Figure 3-26: External Peripheral Interface Connector	42

Figure 3-27: HDMI Connector Pinout Locations.....	43
Figure 3-28: LAN Connector	44
Figure 3-29: USB 3.0 Port Pinout Locations	45
Figure 3-30: VGA Connector	46
Figure 4-1: SO-DIMM Installation	50
Figure 4-2: Removing the Retention Screw	51
Figure 4-3: Inserting the Full-size mSATA Module into the Slot at an Angle.....	51
Figure 4-4: Securing the mSATA Module.....	52
Figure 4-5: Removing the Retention Screw and the Standoff	53
Figure 4-6: Installing the Standoff	53
Figure 4-7: Inserting the Half-size mSATA Module into the Slot at an Angle.....	54
Figure 4-8: Securing the Half-size mSATA Module.....	54
Figure 4-9: Unlock SIM Card Slot Cover	55
Figure 4-10: SIM Card Installation.....	56
Figure 4-11: Lock SIM Card Slot Cover	56
Figure 4-12: AT/ATX Mode Select Switch Location	57
Figure 4-13: Clear CMOS Button Location.....	58
Figure 4-14: LVDS Voltage Select Jumper Location.....	59
Figure 4-15: LVDS Backlight Mode Select Jumper Location	60
Figure 4-16: LVDS Panel Resolution Select Switch Location.....	61
Figure 4-17: RS-232/422/485 Mode Select Switch Location	62
Figure 4-18: Audio Kit Cable Connection	64
Figure 4-19: Power Cable to Motherboard Connection	65
Figure 4-20: Connect Power Cable to Power Supply.....	65
Figure 4-21: SATA Drive Cable Connection.....	67
Figure 6-1: IEI Resource Download Center.....	107

List of Tables

Table 1-1: WAFER-AL Model Variations.....	3
Table 1-2: Technical Specifications.....	9
Table 3-1: Peripheral Interface Connectors	17
Table 3-2: Rear Panel Connectors	17
Table 3-3: +12V DC-IN Power Connector Pinouts	18
Table 3-4: Audio Connector Pinouts	19
Table 3-5: Battery Connector Pinouts	21
Table 3-6: Digital I/O Connector Pinouts.....	21
Table 3-7: Fan Connector Pinouts	22
Table 3-8: iDP Connector Pinouts.....	23
Table 3-9: Backlight Inverter Connector Pinouts	24
Table 3-10: LVDS Connector Pinouts.....	26
Table 3-11: LAN1 LED Connector (JLAN_LED1) Pinouts.....	27
Table 3-12: LAN2 LED Connector (JLAN_LED2) Pinouts.....	27
Table 3-13: mSATA Module Slot Pinouts	29
Table 3-14: PCIe Mini Card Slot Pinouts	30
Table 3-15: Power and HDD LED Connector Pinouts	31
Table 3-16: Power Button Connector Pinouts	32
Table 3-17: Reset Button Connector Pinouts	33
Table 3-18: RS-232 Serial Port Connector Pinouts	34
Table 3-19: RS-232/422/485 Connector Pinouts	35
Table 3-20: RS-232/422/485 Cable Pinouts	36
Table 3-21: SATA Power Connector Pinouts.....	37
Table 3-22: SMBus/I ² C Connector Pinouts	39
Table 3-23: SPI Flash Connector Pinouts	39
Table 3-24: TPM Connector Pinouts	40
Table 3-25: USB Connector Pinouts.....	41
Table 3-26: HDMI Connector Pinouts	43
Table 3-27: LAN Pinouts	44
Table 3-28: USB 3.0 Port Pinouts.....	45
Table 3-29: VGA Connector Pinouts.....	46

Table 4-1: AT/ATX Mode Select Switch Settings.....	57
Table 4-2: LVDS Voltage Select Jumper Settings	59
Table 4-3: LVDS Backlight Mode Select Jumper Settings.....	60
Table 4-4: LVDS Panel Resolution Selection.....	61
Table 4-5: RS-232/422/485 Mode Selection	62
Table 5-1: BIOS Navigation Keys	70

List of BIOS Menus

BIOS Menu 1: Main	71
BIOS Menu 2: Advanced	72
BIOS Menu 3: Trusted Computing	73
BIOS Menu 4: ACPI Settings	74
BIOS Menu 5: F81866 Super IO Configuration	75
BIOS Menu 6: Serial Port n Configuration	75
BIOS Menu 7: F81866 H/W Monitor	80
BIOS Menu 8: Smart Fan Mode Configuration	81
BIOS Menu 9: USB Configuration	82
BIOS Menu 10: CPU Configuration	84
BIOS Menu 11: RTC Wake Settings	86
BIOS Menu 12: Power Saving Configuration	87
BIOS Menu 13: Serial Port Console Redirection	88
BIOS Menu 14: Legacy Console Redirection Settings	89
BIOS Menu 15: IEI Feature	90
BIOS Menu 16: Chipset	91
BIOS Menu 17: North Bridge Configuration	92
BIOS Menu 18: Intel IGD Configuration	93
BIOS Menu 19: South Bridge Configuration	95
BIOS Menu 20: HD-Audio Configuration	96
BIOS Menu 21: PCI Express Configuration	97
BIOS Menu 22: Onboard LAN	98
BIOS Menu 23: MINI-PCIE	99
BIOS Menu 24: SATA Configuration	100
BIOS Menu 25: Security	101
BIOS Menu 26: Boot	102
BIOS Menu 27: Save & Exit	104

Chapter

1

Introduction

1.1 Introduction

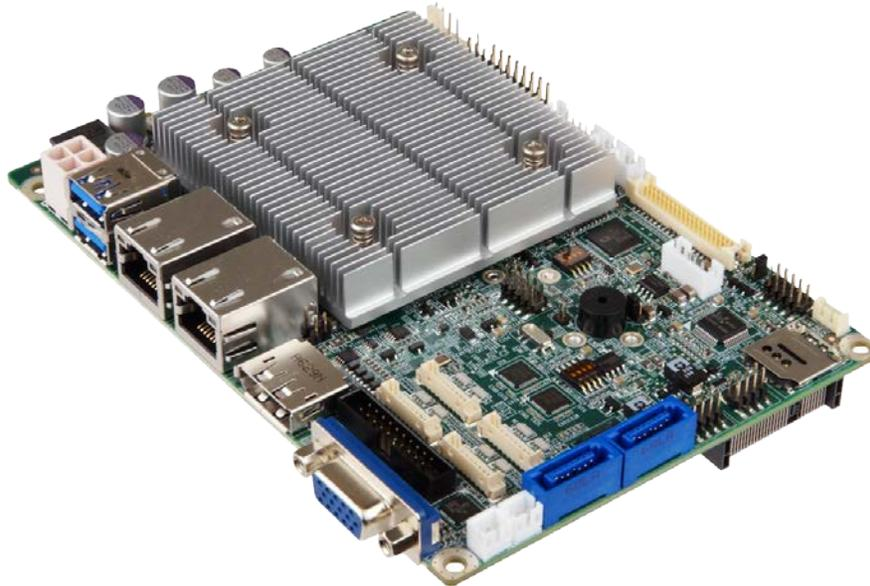

Figure 1-1: WAFER-AL

The WAFER-AL series is a 3.5" single board computer. It has an on-board 14nm Intel® Pentium® or Celeron® processor, and supports one 204-pin 1867/1600 MHz single-channel DDR3 Low Voltage (DDR3L) SDRAM SO-DIMM slot with up to 8.0 GB of memory.

The WAFER-AL series includes one DP++ connector, one VGA connector and one 18-/24-bit LVDS connector for triple independent display. Two RJ-45 GbE connectors provide the system with smooth connections to an external LAN.

Expansion and I/O include one PCIe Mini slot supporting mSATA modules, one PCIe Mini slot with SIM card holder, two USB 3.0 connectors on the rear panel, four USB 2.0 connectors by pin header and two SATA 6Gb/s connectors. Serial device connectivity is provided by two internal RS-232 connectors and two internal RS-232/422/485 connectors.

WAFER-AL SBC

1.2 Model Variations

The model variations of the WAFER-AL series are listed below.

Model No.	SoC	Display Interface
WAFER-AL-N2	Intel® Pentium® N4200 on-board SoC (up to 2.5 GHz, quad-core, TDP=6 W)	DP++, LVDS, VGA
WAFER-AL-N1	Intel® Celeron® N3350 on-board SoC (up to 2.4 GHz, dual-core, TDP=6 W)	DP++, LVDS, VGA
WAFER-AL-N2-iDP*	Intel® Pentium® N4200 on-board SoC (up to 2.5 GHz, quad-core, TDP=6 W)	DP++, LVDS, iDP
WAFER-AL-N1-iDP*	Intel® Celeron® N3350 on-board SoC (up to 2.4 GHz, dual-core, TDP=6 W)	DP++, LVDS, iDP
*By order production, MOQ 100		

Table 1-1: WAFER-AL Model Variations

1.3 Features

Some of the WAFER-AL motherboard features are listed below:

- 3.5" motherboard supports 14nm Intel® Pentium®/Celeron® on-board SoC
- Triple independent display support
- One 1867/1600 MHz DDR3L SO-DIMM slot supports up to 8 GB of memory
- Two SATA 6Gb/s connectors with 5 V power output
- Two USB 3.0 external connectors
- Two RS-232 connectors and two RS-232/422/485 connectors
- One SIM card holder on board
- Two full-size/half-size PCIe Mini card slots for expansion
- Support mSATA modules
- IEI One Key Recovery solution allows you to create rapid OS backup and recovery

1.4 Connectors

The connectors on the WAFER-AL are shown in the figure below.

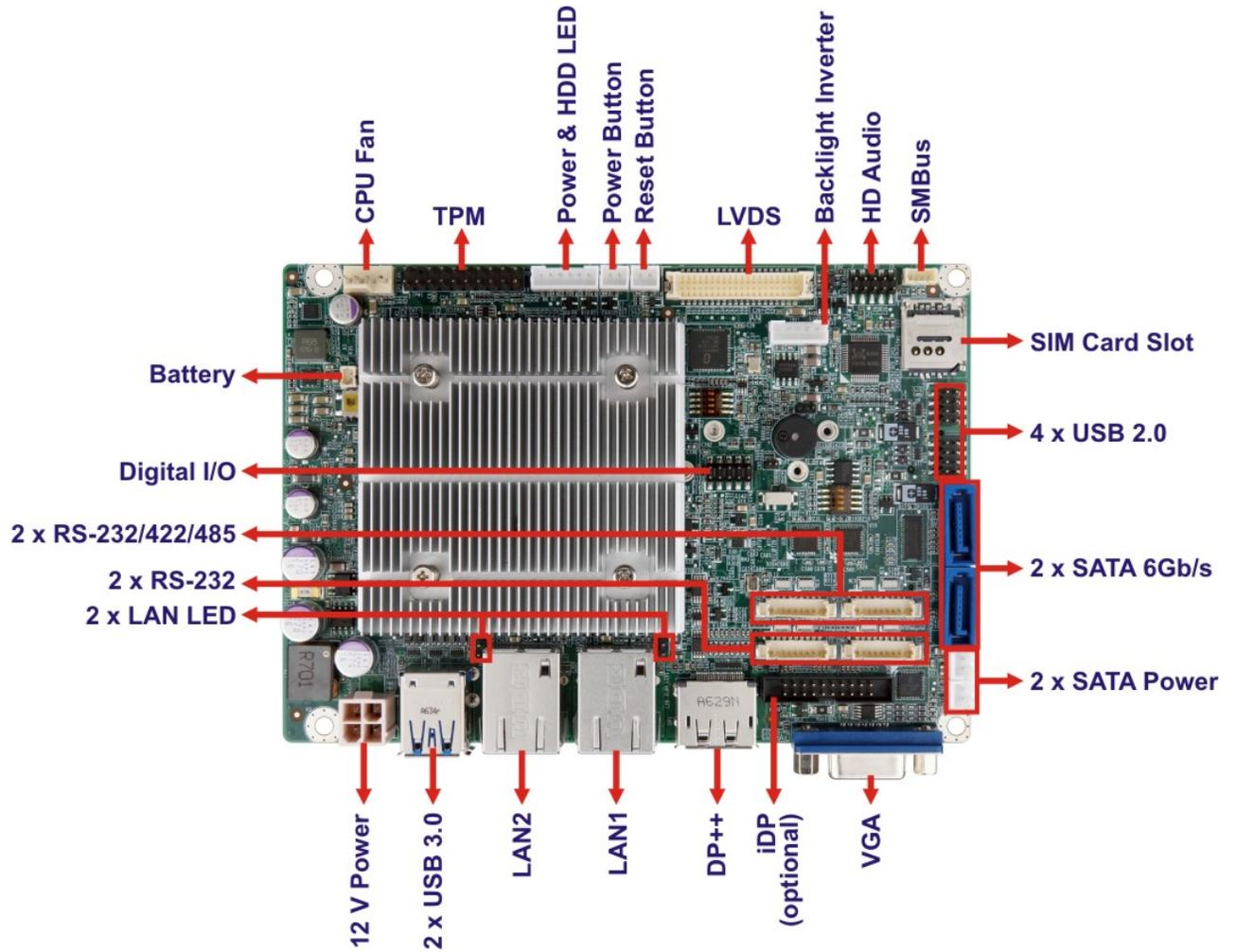

Figure 1-2: Connectors (Front Side)

WAFER-AL SBC

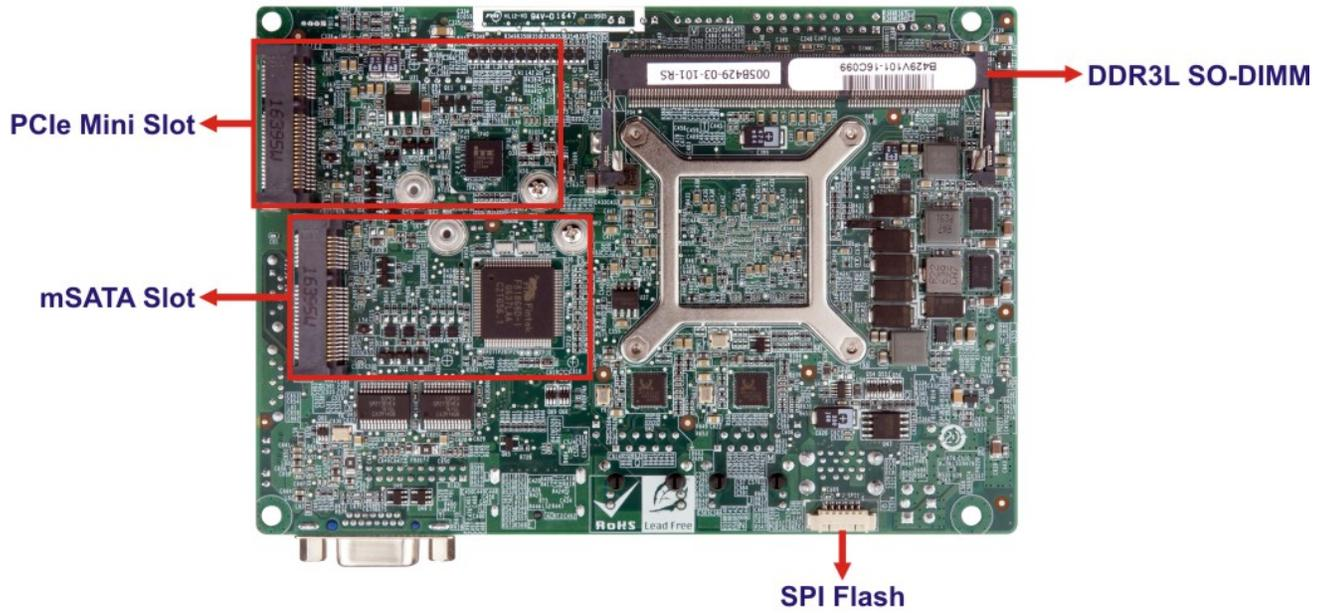

Figure 1-3: Connectors (Solder Side)

1.5 Dimensions

The dimensions of the WAFER-AL series are listed in **Figure 1-4**.

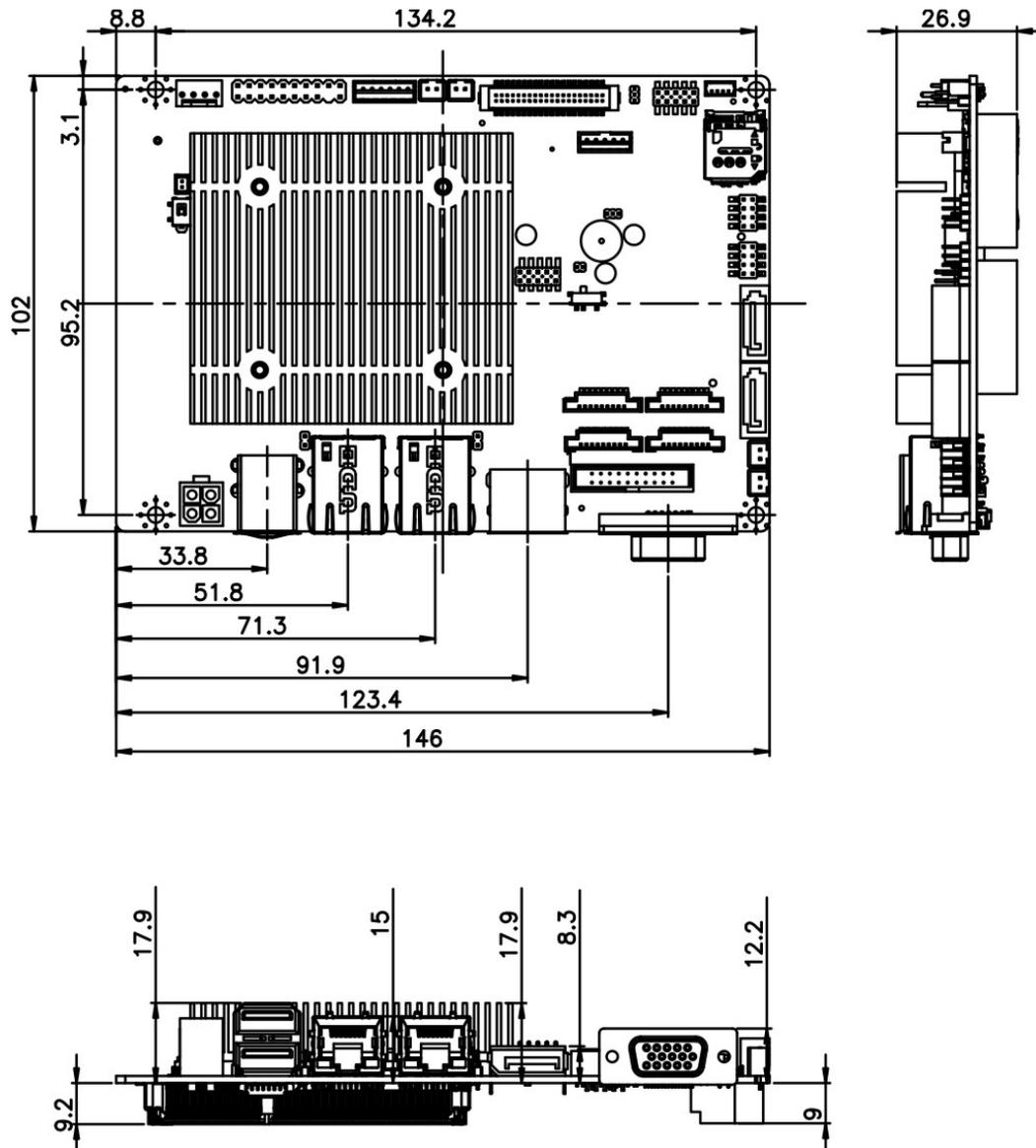

Figure 1-4: Dimensions with Heatsink (mm)

WAFER-AL SBC

1.6 Data Flow

Figure 1-5 shows the data flow between the system chipset, the CPU and other components installed on the motherboard.

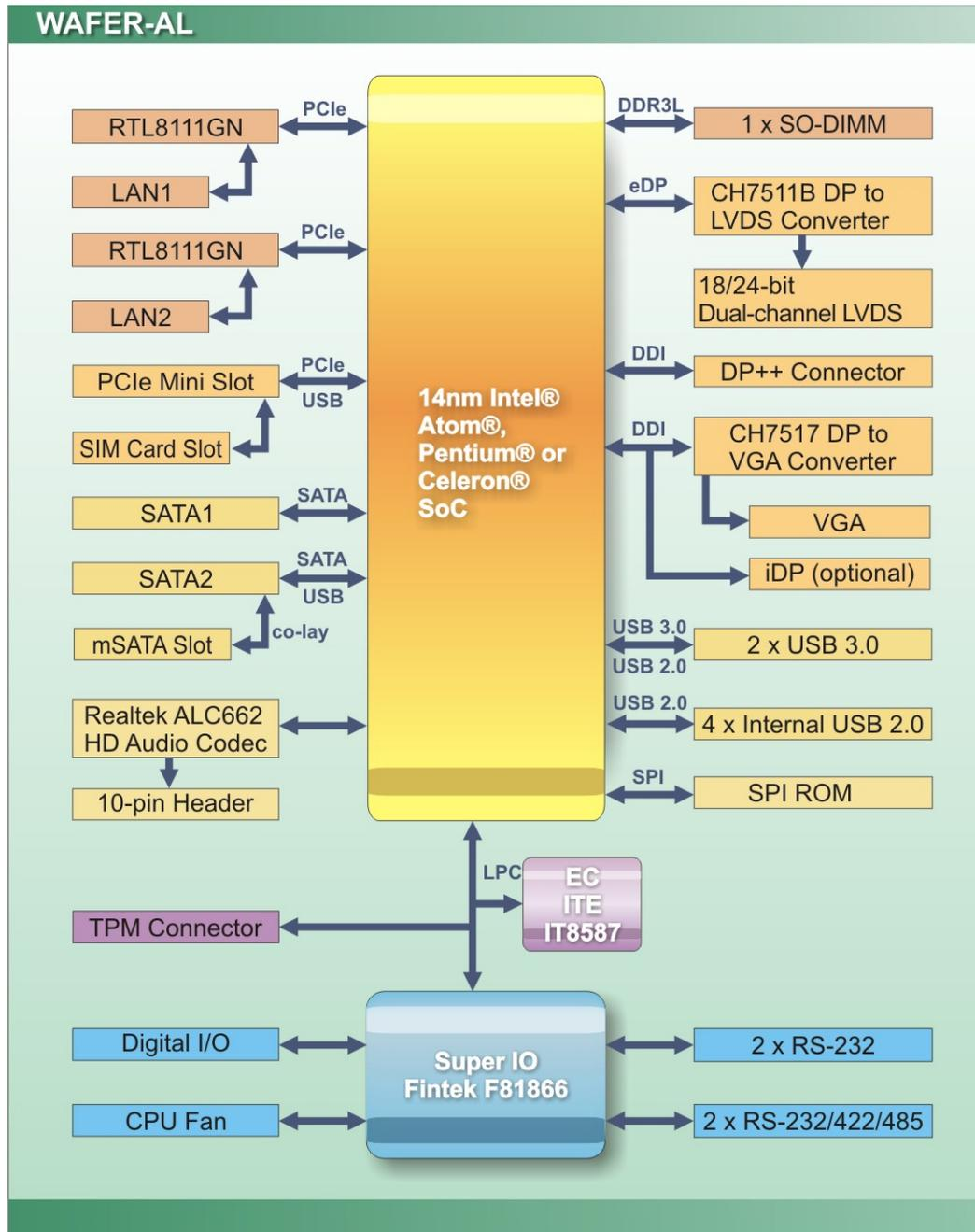

Figure 1-5: Data Flow Diagram

1.7 Technical Specifications

WAFER-AL technical specifications are listed below.

Specification	WAFER-AL
SoC	Intel® Pentium® N4200 on-board SoC (up to 2.5 GHz, quad-core, 2 MB cache, TDP=6 W) Intel® Celeron® N3350 on-board SoC (up to 2.4 GHz, dual-core, 2 MB cache, TDP=6 W)
BIOS	AMI UEFI BIOS
Memory	One 204-pin 1867/1600 MHz single-channel DDR3L SDRAM SO-DIMM slot (system max. 8 GB)
Graphics	9 th generation Intel® HD Graphics with 18 execution units, supporting 4K codec decode & encode for HEVC 4, H.264, VP8, SVC and MVC
Display Output	Triple independent display 1 x DP++ (up to 4096x2160 @ 60 Hz) 1 x VGA (up to 1920x1200 @ 60 Hz) 1 x 18/24-bit dual-channel LVDS (up to 1920x1200 @ 60 Hz) 1 x iDP (colay with VGA, optional by request)
Ethernet	Dual Realtek RTL8111GN PCIe GbE controller
Digital I/O	8-bit digital I/O by 10-pin (2x5) header
Super IO	Fintek F81866
Audio	Realtek ALC662 HD codec
Watchdog Timer	Software programmable support 1~255 sec. system reset
I/O Interface	
Audio Connector	1 x Front audio by 10-pin (2x5) header
Ethernet	2 x RJ-45 GbE port
Serial Ports	2 x RS-232 by 9-pin (1x9) wafer 2 x RS-232/422/485 by 9-pin (1x9) wafer

WAFER-AL SBC

Specification	WAFER-AL
USB Ports	2 x USB 3.0 on rear I/O 4 x USB 2.0 by 8-pin (2x4) header
Front Panel	1 x Power LED & HDD LED by 6-pin (1x6) wafer 1 x Power button by 2-pin wafer 1 x Reset button by 2-pin wafer
LAN LED	2 x LAN link LED connector by 2-pin header
Fan	1 x System fan connector by 4-pin (1x4) wafer
SMBus/I²C	1 x SMBus/I ² C connector by 4-pin (1x4) wafer
Storage	2 x SATA 6Gb/s with 5 V SATA power connectors
TPM	1 x TPM connector by 20-pin (2x10) header
Expansion	Two Full-size/Half-size PCIe Mini card slots: <ul style="list-style-type: none"> ▪ One supports mSATA module (colay SATA2) ▪ One support SIM card holder
Environmental and Power Specifications	
Power Supply	12 V DC input power (AT/ATX support)
Power Connector	1 x Internal power connector by 4-pin (2x2) connector
Power Consumption	+12 V @ 2.57 A (Intel [®] Pentium [®] N4200 processor with 8 GB DDR3L memory)
Operating Temperature	-20°C ~ 60°C
Storage Temperature	-20°C ~ 60°C
Humidity	5% ~ 95%, non-condensing
Physical Specifications	
Dimensions	146 mm x 102 mm
Weight GW/NW	600 g / 250 g

Table 1-2: Technical Specifications

Chapter

2

Unpacking

WAFER-AL SBC

2.1 Anti-static Precautions



WARNING!

Static electricity can destroy certain electronics. Make sure to follow the ESD precautions to prevent damage to the product, and injury to the user.

Make sure to adhere to the following guidelines:

- **Wear an anti-static wristband:** Wearing an anti-static wristband can prevent electrostatic discharge.
- **Self-grounding:** Touch a grounded conductor every few minutes to discharge any excess static buildup.
- **Use an anti-static pad:** When configuring any circuit board, place it on an anti-static mat.
- **Only handle the edges of the PCB:** Don't touch the surface of the motherboard. Hold the motherboard by the edges when handling.

2.2 Unpacking Precautions

When the WAFER-AL is unpacked, please do the following:

- Follow the antistatic guidelines above.
- Make sure the packing box is facing upwards when opening.
- Make sure all the packing list items are present.

2.3 Packing List



NOTE:

If any of the components listed in the checklist below are missing, do not proceed with the installation. Contact the IEI reseller or vendor the WAFER-AL was purchased from or contact an IEI sales representative directly by sending an email to sales@ieiworld.com.

The WAFER-AL is shipped with the following components:

Quantity	Item and Part Number	Image
1	WAFER-AL single board computer	
1	Power cable	
1	RS-232/422/485 cable	
2	SATA and power cable	
1	Quick Installation Guide	

WAFER-AL SBC

2.4 Optional Items

The following are optional components which may be separately purchased:

Item and Part Number	Image
RS-232/422/485 cable, 250 mm, p=1.25 (P/N : 32005-003500-200-RS)	
Dual USB port cable, 210mm, p=2.0 mm (P/N: 32001-008600-200-RS)	
Audio cable, 300mm, p=2.0 mm (P/N: 32007-005200-200-RS)	
Infineon TPM 2.0 module, 20-pin, firmware v5.5 (P/N: TPM-IN02-R20)	

Chapter

3

Connectors

WAFER-AL SBC

3.1 Peripheral Interface Connectors

This chapter details all the jumpers and connectors.

3.1.1 WAFER-AL Layout

The figures below show all the connectors and jumpers.

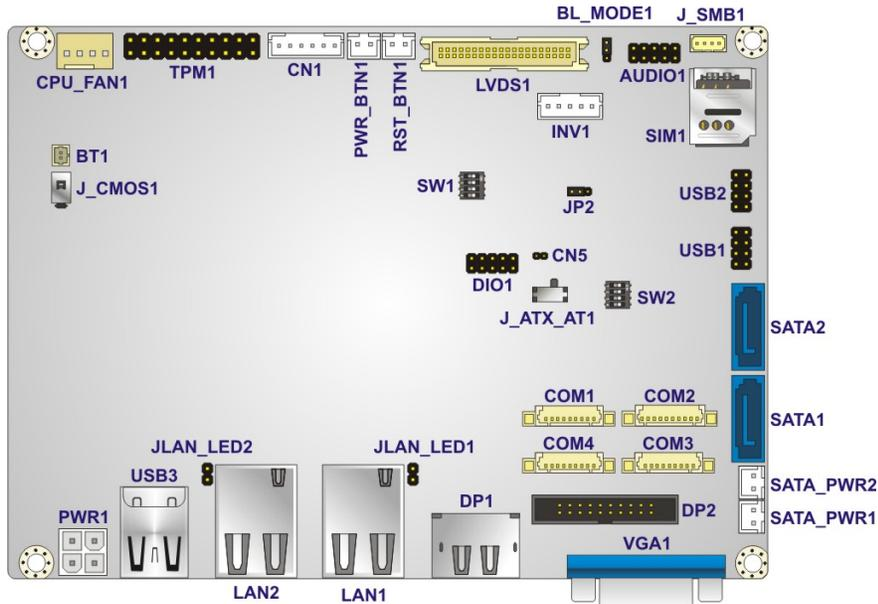

Figure 3-1: Connector and Jumper Locations (Front Side)

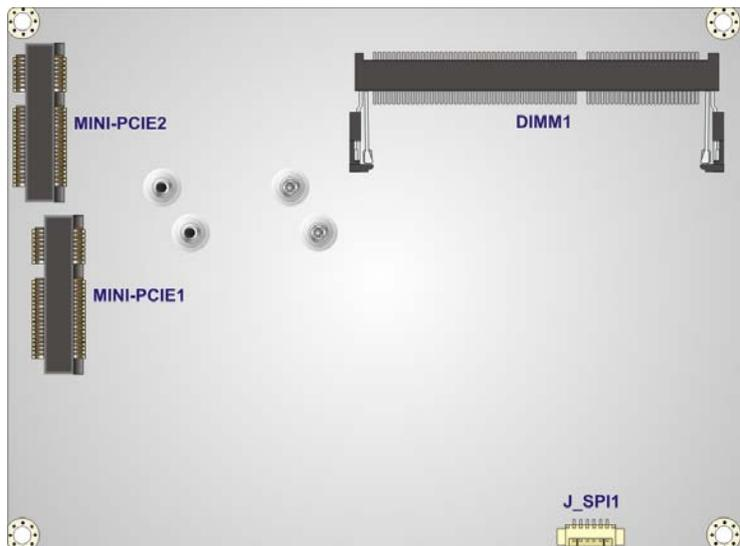

Figure 3-2: Connector and Jumper Locations (Solder Side)

3.1.2 Peripheral Interface Connectors

The table below lists all the connectors on the board.

Connector	Type	Label
+12V DC-IN power connector	4-pin Molex	PWR1
Audio connector	10-pin header	AUDIO1
Battery connector	2-pin wafer	BT1
Digital I/O connector	10-pin header	DIO1
Fan connector, CPU	4-pin wafer	CPU_FAN1
iDP connector (optional)	20-pin box header	DP2
LVDS backlight inverter connector	5-pin wafer	INV1
LVDS LCD connector	40-pin crimp	LVDS1
LAN LED connectors	2-pin header	JLAN_LED1, JLAN_LED2
Memory slot	204-pin SO-DIMM	DIMM1
mSATA module slot	PCIe Mini slot	MINI-PCIE1
PCIe Mini card slot	PCIe Mini slot	MINI-PCIE2
Power and HDD LED connector	6-pin wafer	CN1
Power button connector	2-pin wafer	PWR_BTN1
Reset button connector	2-pin wafer	RST_BTN1
RS-232 serial port connectors	9-pin wafer	COM3, COM4
RS-232/422/485 serial port connectors	9-pin wafer	COM1, COM2
SATA 6Gb/s connectors	7-pin SATA connector	SATA1, SATA2
SATA power connectors	2-pin wafer	SATA_PWR1, SATA_PWR2

WAFER-AL SBC

SIM card slot	Micro SIM card slot	SIM1
SMBus/I ² C connector	4-pin wafer	J_SMB1
SPI Flash Connector	6-pin wafer	J_SPI1
TPM connector	20-pin header	TPM1
USB 2.0 connector	8-pin header	USB1, USB2
EC firmware update connector (for internal use only)	2-pin header	CN5

Table 3-1: Peripheral Interface Connectors

3.1.3 External Interface Panel Connectors

The table below lists the connectors on the external I/O panel.

Connector	Type	Label
DisplayPort++ connector	DP++	DP1
LAN connectors	RJ-45	LAN1, LAN2
USB 3.0 connectors	USB 3.0	USB3
VGA connector	DB-9	VGA1

Table 3-2: Rear Panel Connectors

3.2 Internal Peripheral Connectors

The section describes all of the connectors on the WAFER-AL.

3.2.1 +12V DC-IN Power Connector

- CN Label:** PWR1
- CN Type:** 4-pin Molex, p=4.2 mm
- CN Location:** See **Figure 3-3**
- CN Pinouts:** See **Table 3-3**

The connector supports the +12V power supply.

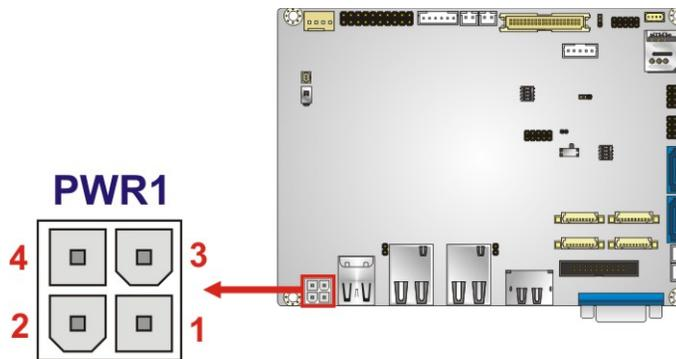

Figure 3-3: +12V DC-IN Power Connector Location

PIN NO.	DESCRIPTION	PIN NO.	DESCRIPTION
1	GND	2	GND
3	+12V	4	+12V

Table 3-3: +12V DC-IN Power Connector Pinouts

WAFER-AL SBC

3.2.2 Audio Connector

- CN Label:** AUDIO1
- CN Type:** 10-pin header, p=2.00 mm
- CN Location:** See **Figure 3-4**
- CN Pinouts:** See **Table 3-4**

The audio connector is connected to external audio devices including speakers and microphones for the input and output of audio signals to and from the system.

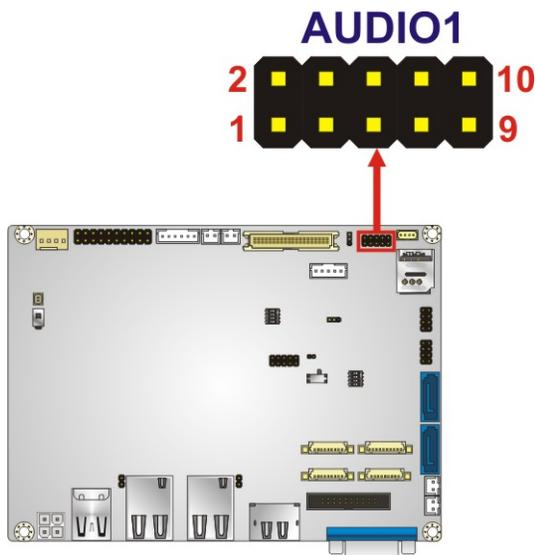

Figure 3-4: Audio Connector Location

PIN NO.	DESCRIPTION	PIN NO.	DESCRIPTION
1	LINE-OUT_R	2	LINE-IN_R
3	AUD_GND	4	AUD_GND
5	LINE-OUT_L	6	LINE-IN_L
7	AUD_GND	8	AUD_GND
9	MIC_R	10	MIC_L

Table 3-4: Audio Connector Pinouts

3.2.3 Battery Connector

**CAUTION:**

Risk of explosion if battery is replaced by an incorrect type. Only certified engineers should replace the on-board battery.

Dispose of used batteries according to instructions and local regulations.

**NOTE:**

It is recommended to attach the RTC battery onto the system chassis in which the WAFER-AL is installed.

CN Label:	BT1
CN Type:	2-pin wafer, p=1.25 mm
CN Location:	See Figure 3-5
CN Pinouts:	See Table 3-5

The battery connector is connected to the system battery. The battery provides power to the system clock to retain the time when power is turned off.

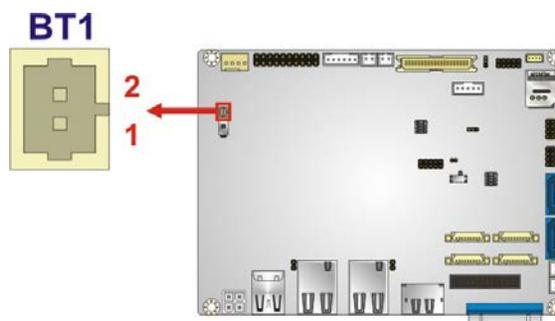

Figure 3-5: Battery Connector Location

WAFER-AL SBC

Pin	Description
1	VBAT+
2	GND

Table 3-5: Battery Connector Pinouts

3.2.4 Digital I/O Connector

- CN Label:** DIO1
- CN Type:** 10-pin header, p=2.00 mm
- CN Location:** See Figure 3-6
- CN Pinouts:** See Table 3-6

The 8-bit digital I/O connector provides programmable input and output for external devices.

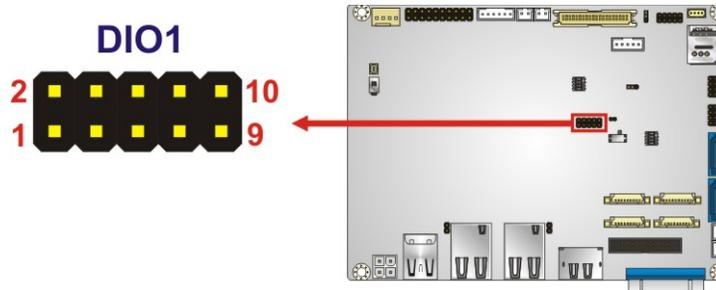

Figure 3-6: Digital I/O Connector Location

PIN NO.	DESCRIPTION	PIN NO.	DESCRIPTION
1	GND	2	VCC
3	DOUT3	4	DOUT2
5	DOUT1	6	DOUT0
7	DIN3	8	DIN2
9	DIN1	10	DIN0

Table 3-6: Digital I/O Connector Pinouts

3.2.5 Fan Connector

- CN Label:** CPU_FAN1
- CN Type:** 4-pin wafer, p=2.54 mm
- CN Location:** See **Figure 3-7**
- CN Pinouts:** See **Table 3-7**

The fan connector attaches to a cooling fan.

CPU_FAN1

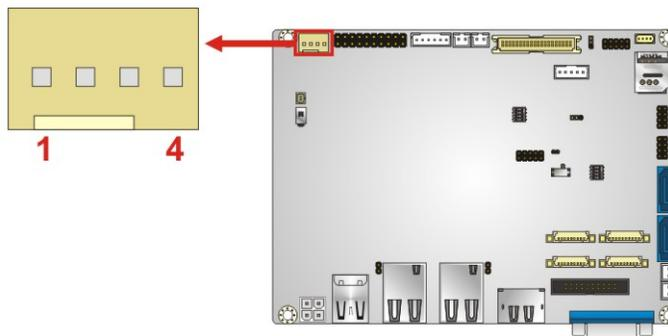

Figure 3-7: Fan Connector Location

Pin	Description
1	GND
2	+V12S
3	Rotation Signal
4	PWM Control Signal

Table 3-7: Fan Connector Pinouts

WAFER-AL SBC

3.2.6 iDP Connector (Optional)

- CN Label:** DP2
- CN Type:** 20-pin box header, p=2.00 mm
- CN Location:** See **Figure 3-8**
- CN Pinouts:** See **Table 3-8**

The internal DisplayPort (iDP) connector supports HDMI, LVDS, VGA, DVI and DisplayPort devices with up to 2560x1600 resolution. The iDP connector is only available in iDP SKUs.

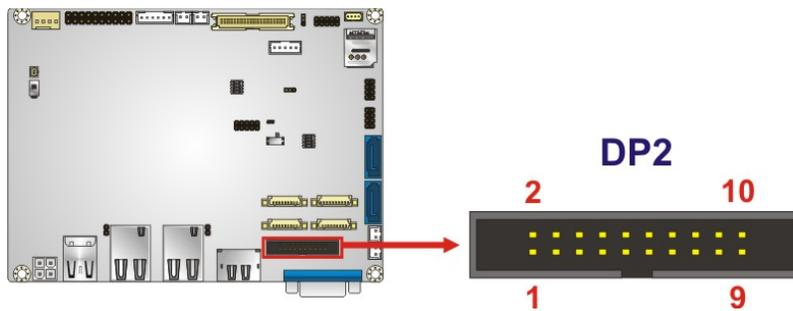

Figure 3-8: iDP Connector Location

Pin	Description	Pin	Description
1	HPD	2	AUXP
3	GND	4	AUXN
5	NC	6	GND
7	GND	8	LANE2P
9	LANE3P	10	LANE2N
11	LANE3N	12	GND
13	GND	14	LANE0P
15	LANE1P	16	LANE0N
17	LANE1N	18	+3.3V
19	+5V	20	NC

Table 3-8: iDP Connector Pinouts

3.2.7 LVDS Backlight Inverter Connector

- CN Label:** INV1
- CN Type:** 5-pin wafer, p=2.00 mm
- CN Location:** See **Figure 3-9**
- CN Pinouts:** See **Table 3-9**

The backlight inverter connector provides power to an LCD panel.

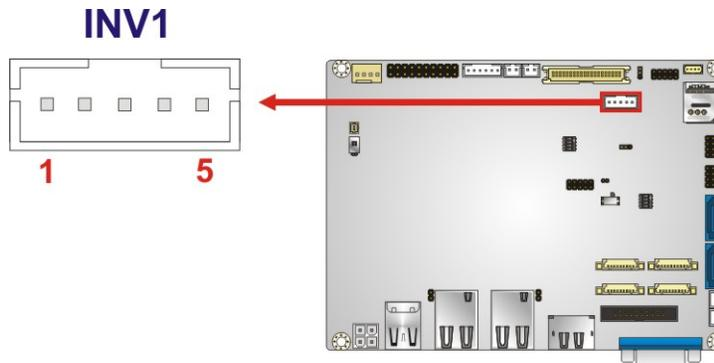

Figure 3-9: Backlight Inverter Connector Location

Pin	Description
1	LCD_BKLTCTL
2	GND
3	+12V
4	GND
5	BACKLIGHT ENABLE

Table 3-9: Backlight Inverter Connector Pinouts

WAFER-AL SBC

3.2.8 LVDS LCD Connector

- CN Label:** LVDS1
- CN Type:** 40-pin crimp, p=1.25 mm
- CN Location:** See **Figure 3-10**
- CN Pinouts:** See **Table 3-10**

The LVDS connector is for an LCD panel connected to the board. The voltage provided to the monitor connected to the LVDS connector is set to 3.3 V by default. To change the setting, refer to **Section 4.7.3**.

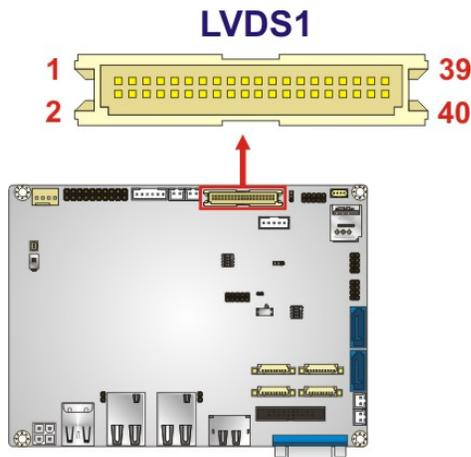

Figure 3-10: LVDS Connector Location

Pin	Description	Pin	Description
1	GROUND	2	GROUND
3	LVDS_A_TX0-N	4	LVDS_A_TX1-N
5	LVDS_A_TX0-P	6	LVDS_A_TX1-P
7	GROUND	8	GROUND
9	LVDS_A_TX2-N	10	LVDS_A_TXCLK-N
11	LVDS_A_TX2-P	12	LVDS_A_TXCLK-P
13	GROUND	14	GROUND
15	LVDS_A_TX3-N	16	LVDS_B_TX0-N
17	LVDS_A_TX3-P	18	LVDS_B_TX0-P
19	GROUND	20	GROUND

Pin	Description	Pin	Description
21	LVDS_B_TX1-N	22	LVDS_B_TX2-N
23	LVDS_B_TX1-P	24	LVDS_B_TX2-P
25	GROUND	26	GROUND
27	LVDS_B_TXCLK-N	28	LVDS_B_TX3-N
29	LVDS_B_TXCLK-P	30	LVDS_B_TX3-P
31	GROUND	32	GROUND
33	GROUND	34	GROUND
35	+LCD VCC	36	+LCD VCC
37	+LCD VCC	38	+LCD VCC
39	+LCD VCC	40	+LCD VCC

Table 3-10: LVDS Connector Pinouts

3.2.9 LAN LED Connectors

CN Label: JLAN_LED1, JLAN_LED2

CN Type: 2-pin header, p=2.00 mm

CN Location: See **Figure 3-11**

CN Pinouts: See **Table 3-11**

The LAN LED connectors connect to the LAN link LEDs on the system.

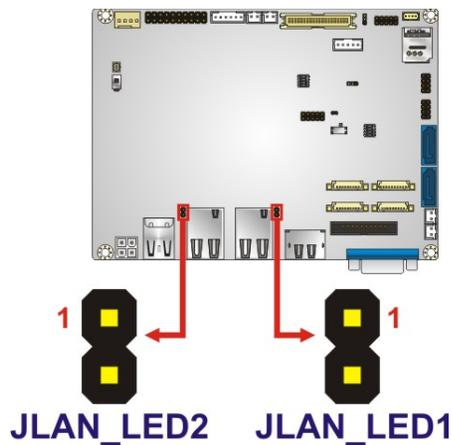

Figure 3-11: LAN LED Connector Locations

WAFER-AL SBC

Pin	Description
1	+3.3V
2	LAN1_LED_LINK#_ACT

Table 3-11: LAN1 LED Connector (JLAN_LED1) Pinouts

Pin	Description
1	+3.3V
2	LAN2_LED_LINK#_ACT

Table 3-12: LAN2 LED Connector (JLAN_LED2) Pinouts

3.2.10 mSATA Module Slot



CAUTION:

If an mSATA module is installed in the mSATA slot (MINI-PCIE1), the SATA port 2 (SATA2) will be disabled. Choose either the SATA2 connector or the mSATA module for storage.

CN Label:	MINI-PCIE1
CN Type:	Half-size/Full-size PCIe Mini card slot
CN Location:	See Figure 3-12
CN Pinouts:	See Table 3-13

The PCIe Mini card slot supports mSATA modules or PCIe Mini cards with USB interface.

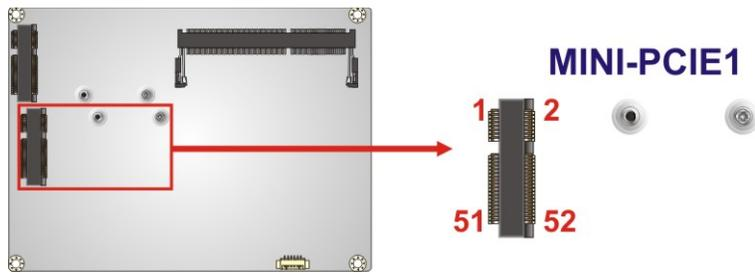

Figure 3-12: mSATA Module Slot Location

Pin	Description	Pin	Description
1	PCIE_WAKE#	2	VCC3
3	N/C	4	GND
5	N/C	6	1.5V
7	N/C	8	N/C
9	GND	10	N/C
11	PCIE_CLK#	12	N/C
13	PCIE_CLK	14	N/C
15	GND	16	N/C
17	N/C	18	GND
19	N/C	20	N/C
21	GND	22	PCIRST#
23	PCIE_RXN (SATA_RX+)	24	N/C
25	PCIE_RXP (SATA_RX-)	26	GND
27	GND	28	1.5V
29	GND	30	SMBCLK
31	PCIE_TXN (SATA_TX-)	32	SMBDATA
33	PCIE_TXP (SATA_TX+)	34	GND
35	GND	36	USBD-
37	GND	38	USBD+
39	VCC3	40	GND
41	VCC3	42	N/C
43	GND	44	N/C
45	N/C	46	N/C
47	N/C	48	1.5V
49	N/C	50	GND

WAFER-AL SBC

Pin	Description	Pin	Description
51	N/C	52	VCC3

Table 3-13: mSATA Module Slot Pinouts

3.2.11 PCIe Mini Card Slot

- CN Label:** MINI-PCIE2
- CN Type:** Half-size/Full-size PCIe Mini card slot
- CN Location:** See **Figure 3-13**
- CN Pinouts:** See **Table 3-14**

The PCIe Mini card slot is for installing a PCIe Mini expansion card with USB interface, such as 3G modules.

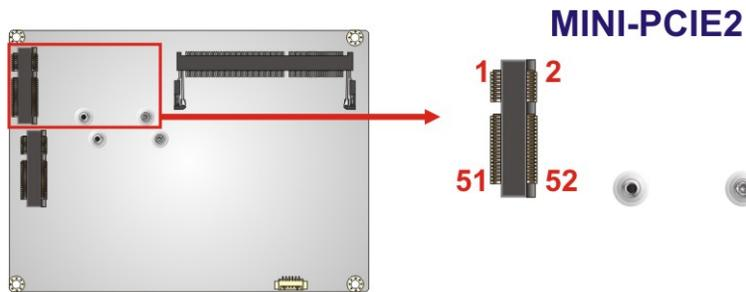

Figure 3-13: PCIe Mini Card Slot Location

Pin	Description	Pin	Description
1	PCIE_WAKE#	2	VCC3
3	N/C	4	GND
5	N/C	6	1.5V
7	N/C	8	UIM_PWR
9	GND	10	UIM_DATA
11	PCIE_CLK#	12	UIM_CLK
13	PCIE_CLK	14	UIM_RST
15	GND	16	UIM_VPP
17	N/C	18	GND
19	N/C	20	N/C

Pin	Description	Pin	Description
21	GND	22	PCIRST#
23	PCIE_RXN	24	N/C
25	PCIE_RXP	26	GND
27	GND	28	1.5V
29	GND	30	SMBCLK
31	PCIE_TXN	32	SMBDATA
33	PCIE_TXP	34	GND
35	GND	36	USBD-
37	GND	38	USBD+
39	VCC3	40	GND
41	VCC3	42	N/C
43	GND	44	N/C
45	N/C	46	N/C
47	N/C	48	1.5V
49	N/C	50	GND
51	N/C	52	VCC3

Table 3-14: PCIe Mini Card Slot Pinouts

WAFER-AL SBC

3.2.12 Power and HDD LED Connector

- CN Label:** CN1
- CN Type:** 6-pin wafer, p=2.00 mm
- CN Location:** See **Figure 3-14**
- CN Pinouts:** See **Table 3-15**

The CN1 connector connects to power and HDD LED indicators.

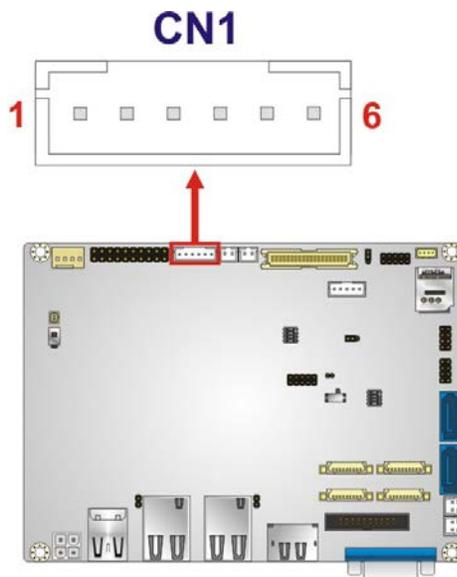

Figure 3-14: Power and HDD LED Connector Location

Pin	Description	
1	VCC	+5V
2	GND	
3	PWR_LED+	Power LED
4	PWR_LED-	
5	HDD_LED+	HDD LED
6	HDD_LED-	

Table 3-15: Power and HDD LED Connector Pinouts

3.2.13 Power Button Connector

- CN Label:** PWR_BTN1
- CN Type:** 2-pin wafer, p=2.00 mm
- CN Location:** See Figure 3-15
- CN Pinouts:** See Table 3-16

The power button connector connects to a power button.

PWR_BTN1

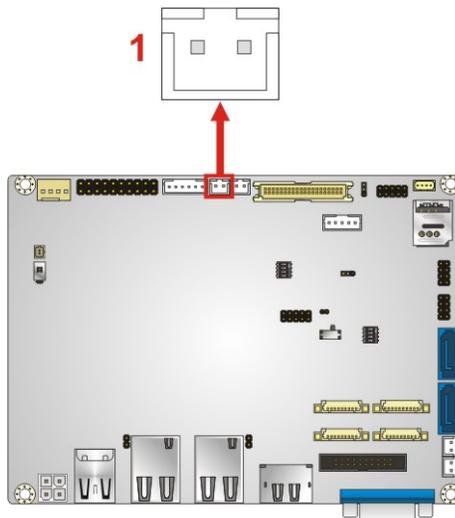

Figure 3-15: Power Button Connector Location

Pin	Description
1	PWR_BTN+
2	PWR_BTN-

Table 3-16: Power Button Connector Pinouts

WAFER-AL SBC

3.2.14 Reset Button Connector

- CN Label:** RST_BTN1
- CN Type:** 2-pin wafer, p=2.00 mm
- CN Location:** See Figure 3-16
- CN Pinouts:** See Table 3-17

The reset button connector connects to a reset button.

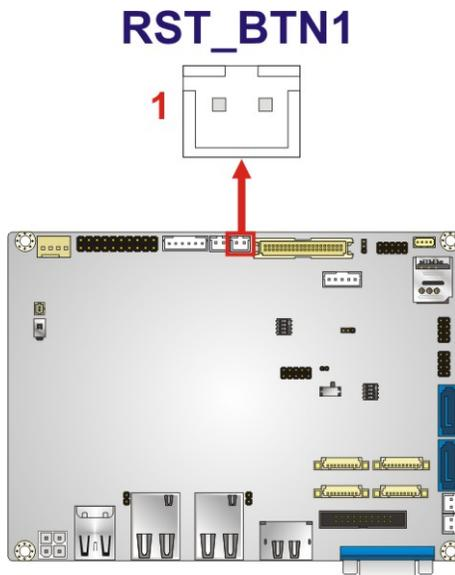

Figure 3-16: Reset Button Connector Location

Pin	Description
1	RESET+
2	RESET-

Table 3-17: Reset Button Connector Pinouts

3.2.15 RS-232 Serial Port Connectors

- CN Label:** COM3, COM4
- CN Type:** 9-pin wafer, p=1.25 mm
- CN Location:** See **Figure 3-17**
- CN Pinouts:** See **Table 3-18**

The serial connectors provide RS-232 connection.

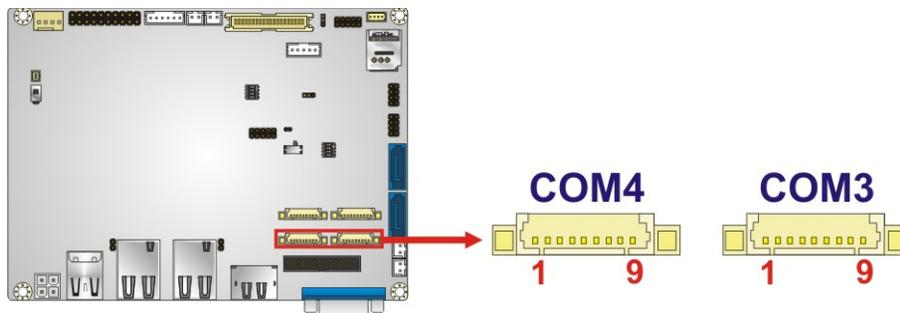

Figure 3-17: RS-232 Serial Port Connector Locations

PIN NO.	DESCRIPTION	PIN NO.	DESCRIPTION
1	DCD	2	DSR
3	RXD	4	RTS
5	TXD	6	CTS
7	DTR	8	RI
9	GND		

Table 3-18: RS-232 Serial Port Connector Pinouts

WAFER-AL SBC

3.2.16 RS-232/422/485 Serial Port Connectors

- CN Label:** COM1, COM2
- CN Type:** 9-pin wafer, p=1.25 mm
- CN Location:** See **Figure 3-18**
- CN Pinouts:** See **Table 3-19**

These two connectors provide RS-232, RS-422 or RS-485 communications. The default mode is set to RS-232 by the on-board switch. To configure the connectors as RS-422 or RS-485, please refer to **Section 4.7.6**.

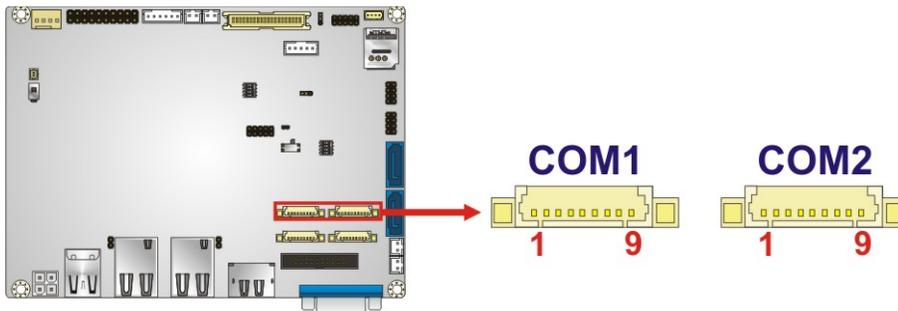

Figure 3-18: RS-232/422/485 Connector Locations

Pin	RS-232	RS-422	RS-485
1	DCD	TXD-	DATA-
2	DSR	--	--
3	RXD	TXD+	DATA+
4	RTS	--	--
5	TXD	RXD+	--
6	CTS	--	--
7	DTR	RXD-	--
8	RI	--	--
9	GND	--	--

Table 3-19: RS-232/422/485 Connector Pinouts

Use the RS-232/422/485 cable to connect to a serial device. The pinouts of the DB-9 connector are listed below.

PIN NO.	RS-232	RS-422	RS-485	
1	DCD	TXD422-	TXD485-	
2	RXD	TXD422+	TXD485+	
3	TXD	RXD422+	--	
4	DTR	RXD422-	--	
5	GND	--	--	
6	DSR	--	--	
7	RTS	--	--	
8	CTS	--	--	
9	RI	--	--	

Table 3-20: RS-232/422/485 Cable Pinouts

3.2.17 SATA 6Gb/s Connectors

- CN Label:** SATA1, SATA2
- CN Type:** 7-pin SATA connector
- CN Location:** See **Figure 3-19**

The SATA 6Gb/s connector is connected to a SATA 6Gb/s device. The SATA 6Gb/s device transfers data at speeds as high as 6Gb/s.

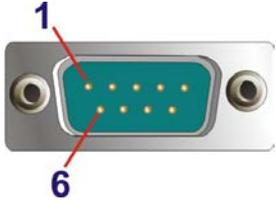
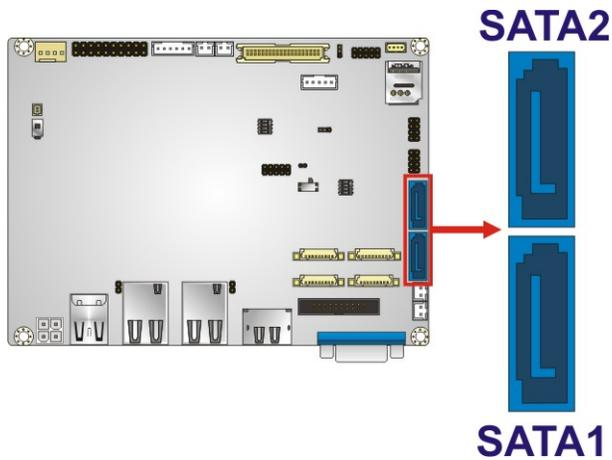

Figure 3-19: SATA 6Gb/s Connector Locations

WAFER-AL SBC



CAUTION:

If an mSATA module is installed in the mSATA slot (MINI-PCIE1), the SATA port 2 (SATA2) will be disabled. Choose either the SATA2 connector or the mSATA module for storage.

3.2.18 SATA Power Connectors

CN Label: SATA_PWR1, SATA_PWR2

CN Type: 2-pin wafer, p=2.00 mm

CN Location: See Figure 3-20

CN Pinouts: See Table 3-21

The SATA power connector provides +5 V power output to the SATA connector.

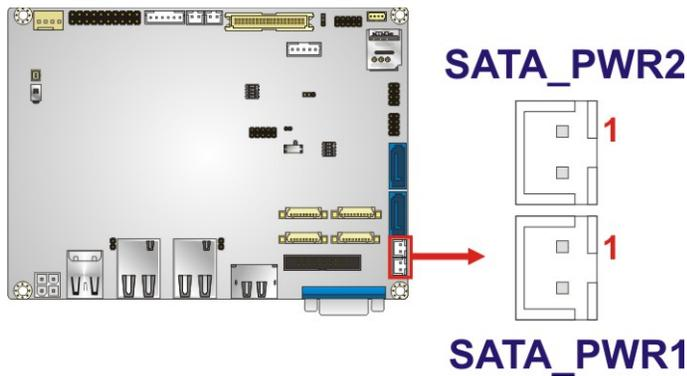

Figure 3-20: SATA Power Connector Locations

Pin	Description
1	+5V
2	GND

Table 3-21: SATA Power Connector Pinouts

3.2.19 SIM Card Slot

- CN Label:** SIM1
- CN Type:** Micro SIM card slot
- CN Location:** See **Figure 3-21**

The SIM card slot accepts a micro SIM card for network communication.

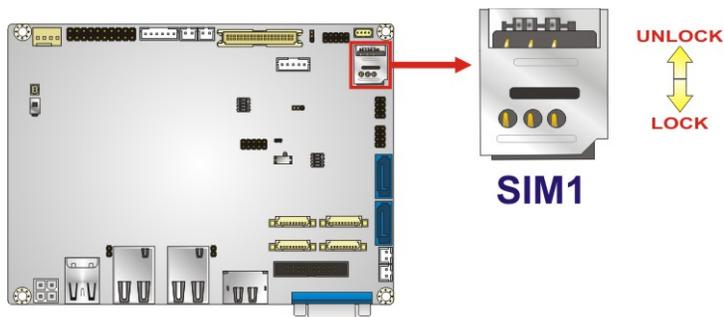

Figure 3-21: SIM Card Slot Location

3.2.20 SMBus/I²C Connector

- CN Label:** J_SMB1
- CN Type:** 4-pin wafer, p=1.25 mm
- CN Location:** See **Figure 3-22**
- CN Pinouts:** See **Table 3-22**

The SMBus/I²C connector provides low-speed system management communications.

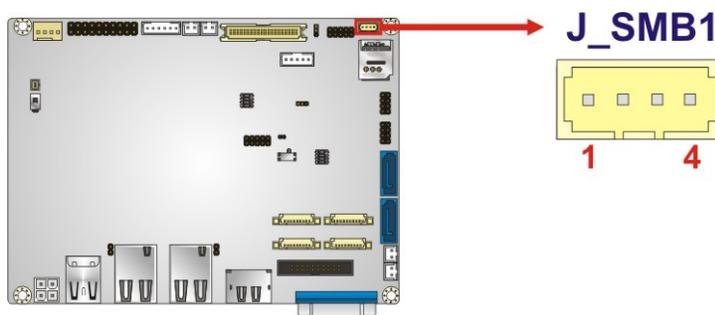

Figure 3-22: SMBus/I²C Connector Location

WAFER-AL SBC

Pin	Description
1	GND
2	SMBus (I ² C) DATA
3	SMBus (I ² C) CLK
4	+5V

Table 3-22: SMBus/I²C Connector Pinouts

3.2.21 SPI Flash Connector

- CN Label:** J_SPI1
- CN Type:** 6-pin wafer, p=1.25 mm
- CN Location:** See Figure 3-23
- CN Pinouts:** See Table 3-23

The 6-pin SPI Flash connector is used to flash the BIOS.

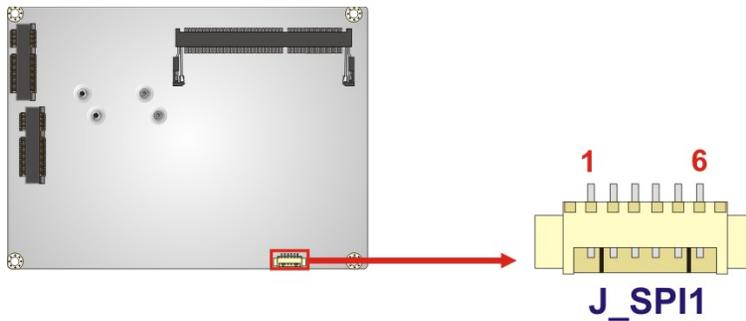

Figure 3-23: SPI Flash Connector Location

Pin	Description
1	VCC
2	SPI_CS
3	SPI_SO
4	SPI_CLK
5	SPI_SI
6	GND

Table 3-23: SPI Flash Connector Pinouts

3.2.22 TPM Connector

- CN Label:** TPM1
- CN Type:** 20-pin header, p=2.54 mm
- CN Location:** See **Figure 3-24**
- CN Pinouts:** See **Table 3-24**

The Trusted Platform Module (TPM) connector secures the system on bootup.

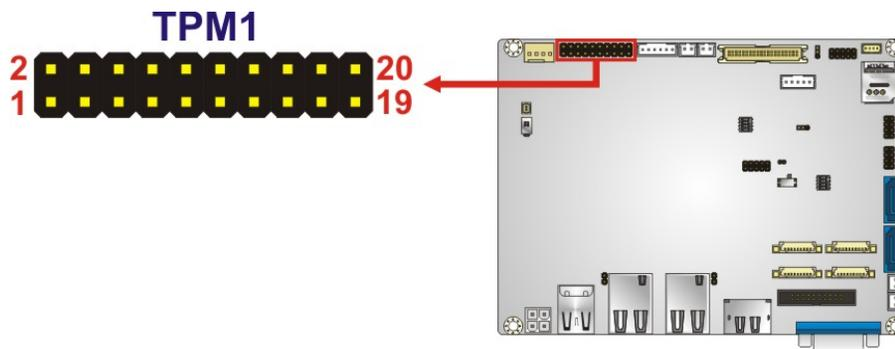

Figure 3-24: TPM Connector Location

Pin	Description	Pin	Description
1	LCLK	2	GND
3	LFRAME#	4	KEY
5	LRERST#	6	+5V
7	LAD3	8	LAD2
9	+3.3V	10	LAD1
11	LAD0	12	GND
13	SCL	14	SDA
15	SB3V	16	SERIRQ
17	GND	18	GLKRUN#
19	LPCPD#	20	LDRQ#

Table 3-24: TPM Connector Pinouts

WAFER-AL SBC

3.2.23 USB 2.0 Connectors

- CN Label:** USB1, USB2
- CN Type:** 8-pin header, p=2.00 mm
- CN Location:** See **Figure 3-25**
- CN Pinouts:** See **Table 3-25**

These USB connectors provide four USB 2.0 ports by dual-port USB cable.

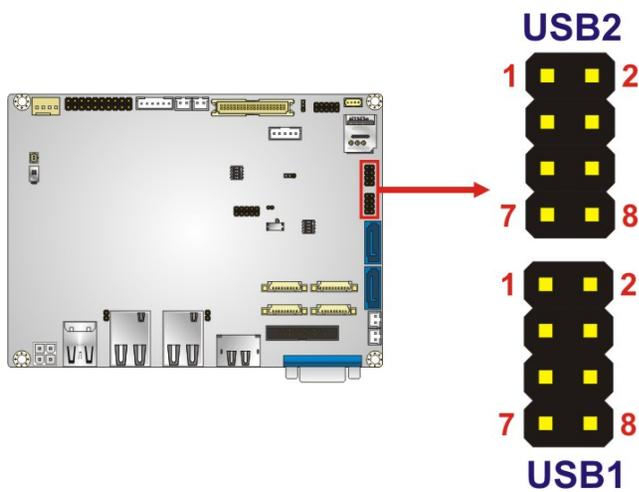

Figure 3-25: USB Connector Locations

PIN NO.	DESCRIPTION	PIN NO.	DESCRIPTION
1	USB_VCC	2	GND
3	DATA-	4	DATA+
5	DATA+	6	DATA-
7	GND	8	USB_VCC

Table 3-25: USB Connector Pinouts

3.3 External Peripheral Interface Connector Panel

Figure 3-26 shows the WAFER-AL external peripheral interface connector (EPIC) panel. The EPIC panel consists of the following:

- 1 x DisplayPort++ connector
- 2 x GbE LAN connector
- 2 x USB 3.0 connector
- 1 x VGA connector

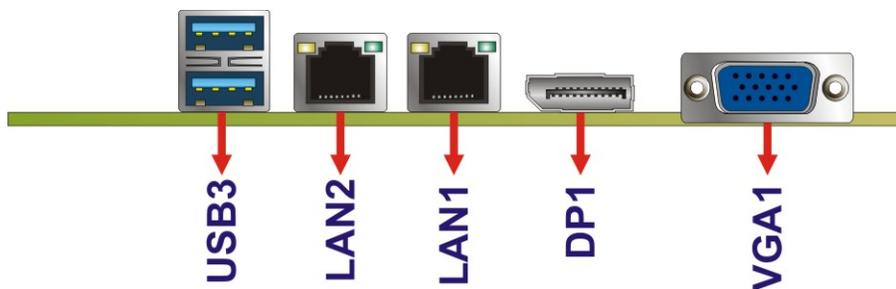

Figure 3-26: External Peripheral Interface Connector

3.3.1 DisplayPort++ Connector

CN Label:	DP1
CN Type:	DisplayPort
CN Location:	See Figure 3-26
CN Pinouts:	See Table 3-26

The DisplayPort++ connector (Dual-mode DisplayPort) can connect to an HDMI or DisplayPort device. The DisplayPort++ connectors support up to 4096x2160 resolutions at 60 Hz.

WAFER-AL SBC

Pin	HDMI	DisplayPort
1	TMDS DATA2+	LOP
2	GND	GND
3	TMDS DATA2-	LON
4	TMDS DATA1+	L1P
5	GND	GND
6	TMDS DATA1-	L1N
7	TMDS DATA0+	L2P
8	GND	GND
9	TMDS DATA0-	L2N
10	TMDS CLK+	L3P
11	GND	GND
12	TMDS CLK-	L3N
13	DP_HDMI_SEL	DP_HDMI_SEL
14	NC	NC
15	SCL	AUXP
16	GND	GND
17	SDA	AUXN
18	HDMI HPD	DP HPD
19	GND	GND
20	HDMI PWR	DP PWR

Table 3-26: HDMI Connector Pinouts

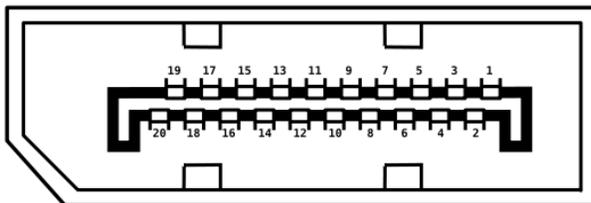

Figure 3-27: HDMI Connector Pinout Locations

3.3.2 LAN Connectors

- CN Label:** LAN1, LAN2
- CN Type:** RJ-45
- CN Location:** See **Figure 3-26**
- CN Pinouts:** See **Figure 3-28** and **Table 3-27**

The LAN connector connects to a local network.

Pin	Description	Pin	Description
1	LAN_MDIO+	7	LAN_MDI2+
2	LAN_MDIO-	8	LAN_MDI2-
3	LAN_MDI1+	9	LAN_MDI3+
4	LAN_MDI1-	10	LAN_MDI3-

Table 3-27: LAN Pinouts

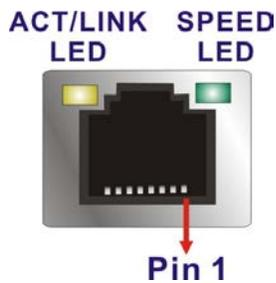

Figure 3-28: LAN Connector

3.3.3 USB Connectors

- CN Label:** USB1
- CN Type:** USB 3.0 ports
- CN Location:** See **Figure 3-26**
- CN Pinouts:** See **Table 3-28**

The WAFER-AL has two external USB 3.0 ports. The USB connector can be connected to a USB 2.0 or USB 3.0 device. The pinouts of USB 3.0 connectors are shown below.

WAFER-AL SBC

Pin	Description	Pin	Description
1	USB_VCC	10	USB_VCC
2	USB2_D0-	11	USB2_D0-
3	USB2_D0+	12	USB2P0_D0+
4	GND	13	GND
5	USB3P0_RXDN1	14	USB3P0_RXDN2
6	USB3P0_RXDP1	15	USB3P0_RXDP2
7	GND	16	GND
8	USB3P0_TXDN1	17	USB3P0_TXDN2
9	USB3P0_TXDP1	18	USB3P0_TXDP2

Table 3-28: USB 3.0 Port Pinouts

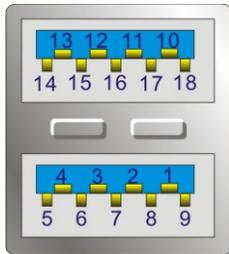

Figure 3-29: USB 3.0 Port Pinout Locations

3.3.4 VGA Connector

- CN Label:** VGA1
- CN Type:** 15-pin Female
- CN Location:** See **Figure 3-26**
- CN Pinouts:** See **Figure 3-30** and **Table 3-29**

The external VGA port connects to a monitor that accepts a standard VGA input.

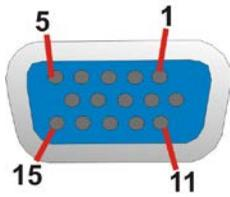

Figure 3-30: VGA Connector

Pin	Description	Pin	Description
1	RED	2	GREEN
3	BLUE	4	NC
5	GND	6	GND
7	GND	8	GND
9	VCC / NC	10	GND
11	NC	12	DDC DAT
13	HSYNC	14	VSYNC
15	DDCCLK		

Table 3-29: VGA Connector Pinouts

Chapter

4

Installation

4.1 Anti-static Precautions



WARNING:

Failure to take ESD precautions during the installation of the WAFER-AL may result in permanent damage to the WAFER-AL and severe injury to the user.

Electrostatic discharge (ESD) can cause serious damage to electronic components, including the WAFER-AL. Dry climates are especially susceptible to ESD. It is therefore critical that whenever the WAFER-AL or any other electrical component is handled, the following anti-static precautions are strictly adhered to.

- **Wear an anti-static wristband:** Wearing a simple anti-static wristband can help to prevent ESD from damaging the board.
- **Self-grounding** Before handling the board, touch any grounded conducting material. During the time the board is handled, frequently touch any conducting materials that are connected to the ground.
- **Use an anti-static pad:** When configuring the WAFER-AL, place it on an anti-static pad. This reduces the possibility of ESD damaging the WAFER-AL.
- **Only handle the edges of the PCB:** When handling the PCB, hold the PCB by the edges.

4.2 Installation Considerations



NOTE:

The following installation notices and installation considerations should be read and understood before installation. All installation notices must be strictly adhered to. Failing to adhere to these precautions may lead to severe damage and injury to the person performing the installation.

WAFER-AL SBC



WARNING:

The installation instructions described in this manual should be carefully followed in order to prevent damage to the WAFER-AL, WAFER-AL components and injury to the user.

Before and during the installation please **DO** the following:

- Read the user manual:
 - The user manual provides a complete description of the WAFER-AL installation instructions and configuration options.
- Wear an electrostatic discharge cuff (ESD):
 - Electronic components are easily damaged by ESD. Wearing an ESD cuff removes ESD from the body and helps prevent ESD damage.
- Place the WAFER-AL on an antistatic pad:
 - When installing or configuring the motherboard, place it on an antistatic pad. This helps to prevent potential ESD damage.
- Turn all power to the WAFER-AL off:
 - When working with the WAFER-AL, make sure that it is disconnected from all power supplies and that no electricity is being fed into the system.

Before and during the installation of the WAFER-AL **DO NOT:**

- Remove any of the stickers on the PCB board. These stickers are required for warranty validation.
- Use the product before verifying all the cables and power connectors are properly connected.
- Allow screws to come in contact with the PCB circuit, connector pins, or its components.

4.3 SO-DIMM Installation

To install an SO-DIMM, please follow the steps below and refer to **Figure 4-1**.

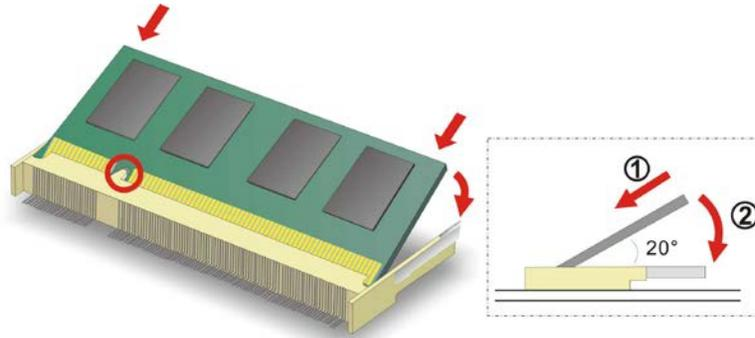

Figure 4-1: SO-DIMM Installation

- Step 1:** Locate the SO-DIMM socket. Place the board on an anti-static mat.
- Step 2:** Align the SO-DIMM with the socket. Align the notch on the memory with the notch on the memory socket.
- Step 3:** Insert the SO-DIMM. Push the memory in at a 20° angle. (See **Figure 4-1**)
- Step 4:** Seat the SO-DIMM. Gently push downwards and the arms clip into place. (See **Figure 4-1**)

4.4 mSATA Module Installation



CAUTION:

If an mSATA module is installed in the mSATA slot (MINI-PCIE1), the SATA port 2 (SATA2) will be disabled. Choose either the SATA2 connector or the mSATA module for storage.

The full-size/half-size PCIe Mini card slot (MINI-PCIE1) allows installation of an mSATA module. To install an mSATA module, please follow the steps below.

WAFER-AL SBC

4.4.1 Full-size mSATA Module Installation

To install a full-size mSATA module, please follow the steps below.

Step 1: Locate the PCIe Mini slot (MINI-PCIE1). See **Chapter 3**.

Step 2: Remove the retention screw as shown in **Figure 4-2**.

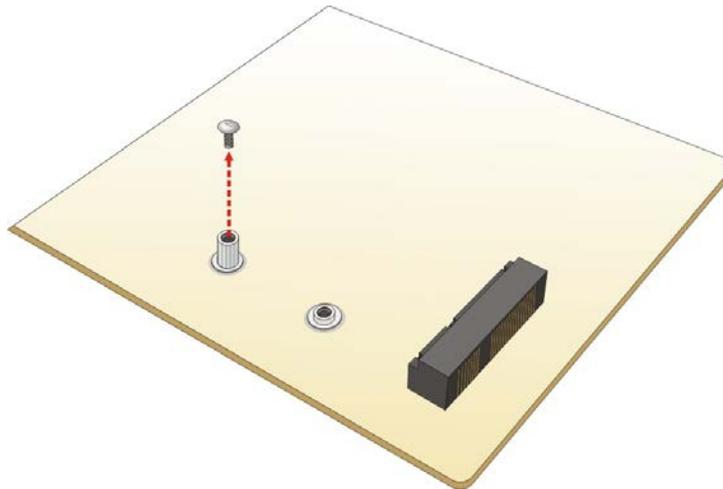

Figure 4-2: Removing the Retention Screw

Step 3: Line up the notch on the mSATA module with the notch on the slot. Slide the mSATA module into the socket at an angle of about 20° (**Figure 4-3**).

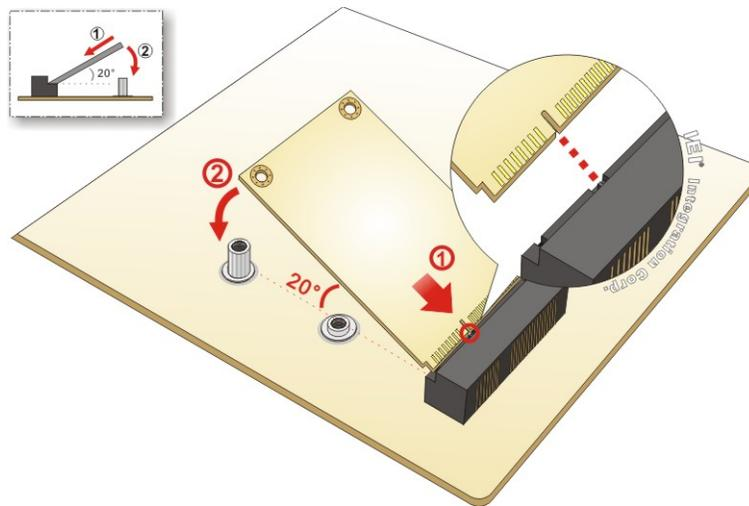

Figure 4-3: Inserting the Full-size mSATA Module into the Slot at an Angle

- Step 4:** Secure the mSATA module with the retention screw previously removed (Figure 4-4).

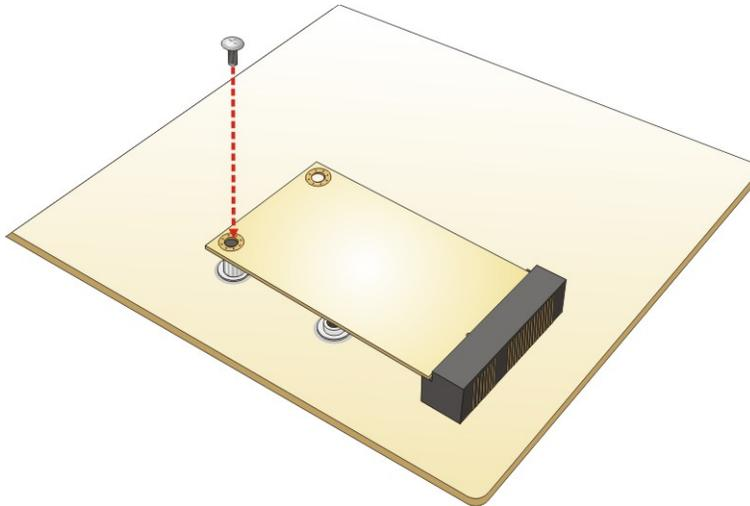

Figure 4-4: Securing the mSATA Module

4.4.2 Half-size mSATA Module Installation

To install a half-size mSATA module, please follow the steps below.

- Step 1:** Locate the PCIe Mini card slot (MINI-PCIE1). See **Chapter 3**.
- Step 2:** Remove the retention screw. Unscrew and remove the standoff secured on the motherboard. See **Figure 4-5**.

WAFER-AL SBC

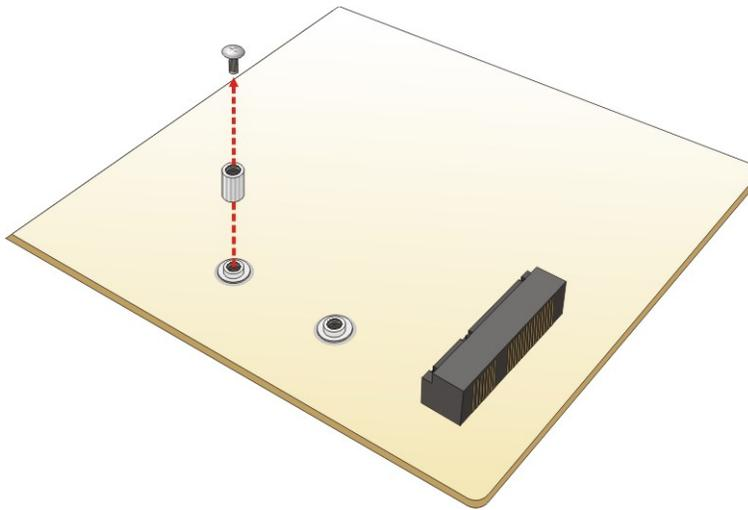

Figure 4-5: Removing the Retention Screw and the Standoff

Step 3: Install the previously removed standoff to the screw hole for the half-size mSATA module (**Figure 4-6**).

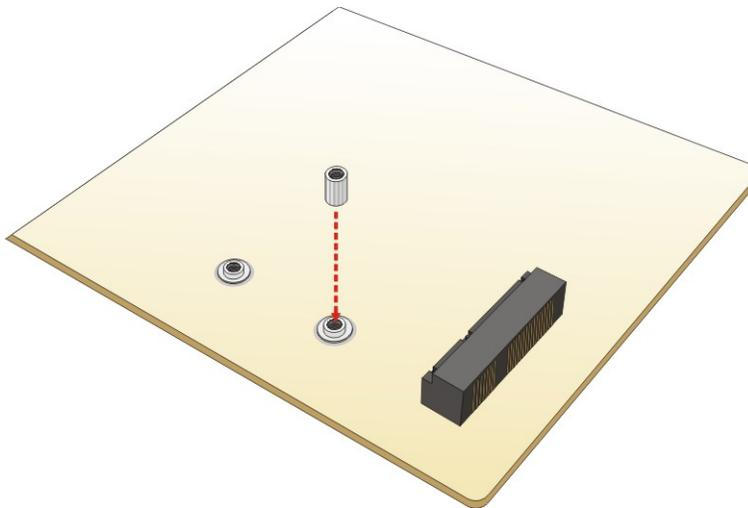

Figure 4-6: Installing the Standoff

Step 4: Line up the notch on the card with the notch on the slot. Slide the mSATA module into the slot at an angle of about 20° (**Figure 4-7**).

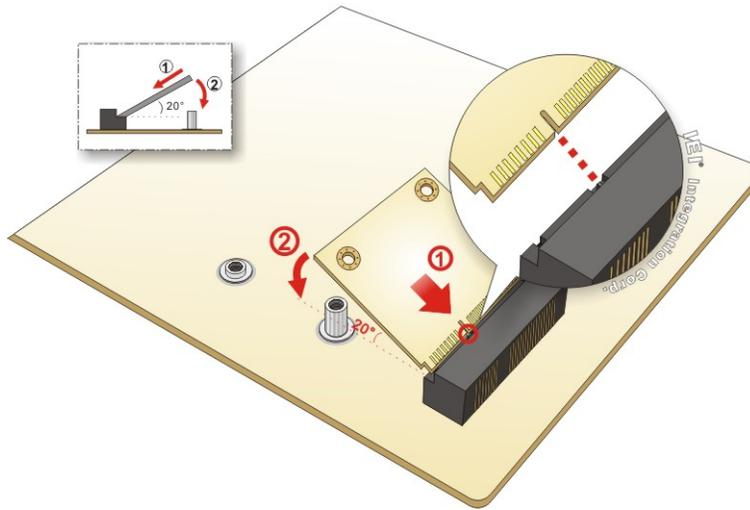

Figure 4-7: Inserting the Half-size mSATA Module into the Slot at an Angle

Step 5: Secure the half-size mSATA module with the retention screw previously removed (**Figure 4-8**).

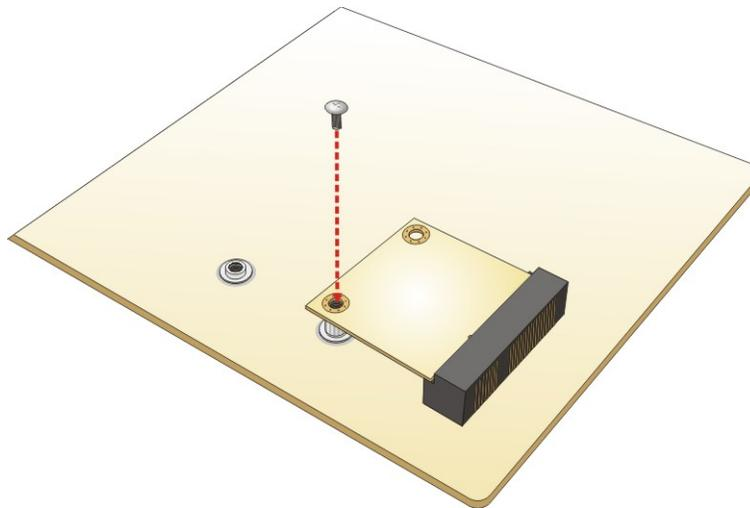

Figure 4-8: Securing the Half-size mSATA Module

WAFER-AL SBC

4.5 PCIe Mini Card Installation

The PCIe Mini card slot (MINI-PCIE2) allows installation of either a full-size or half-size PCIe Mini card. To install a full-size PCIe Mini card, please refer to the steps described in **Section 4.4** above.

4.6 SIM Card Installation

To install a SIM card, please follow the steps below.

Step 1: Locate the SIM card slot. See **Section 3.2.19**.

Step 2: Unlock the SIM card slot cover by sliding the cover in the direction as shown by the arrow in **Figure 4-9**.



Figure 4-9: Unlock SIM Card Slot Cover

Step 3: Open the slot cover and place a SIM card onto the slot. The cut mark on the corner should be facing away from the slot as shown in **Figure 4-10**.

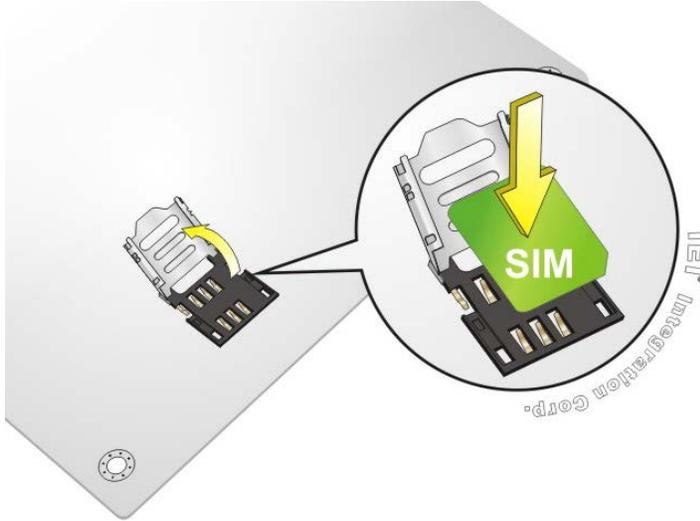

Figure 4-10: SIM Card Installation

Step 4: Close the slot cover and lock it by sliding it in the direction as shown by the arrow in **Figure 4-11**.



Figure 4-11: Lock SIM Card Slot Cover

WAFER-AL SBC

4.7 System Configuration

The system configuration is controlled by buttons, jumpers and switches. The system configuration should be performed before installation.

4.7.1 AT/ATX Mode Select Switch

CN Label:	J_ATX_AT1
CN Type:	Switch
CN Location:	See Figure 4-12
CN Settings:	See Table 4-1

The AT/ATX mode select switch specifies the systems power mode as AT or ATX. AT/ATX mode select switch settings are shown in **Table 4-1**.

Setting	Description
Short 1-2	ATX Mode (Default)
Short 2-3	AT Mode

Table 4-1: AT/ATX Mode Select Switch Settings

The location of the AT/ATX mode select switch is shown in **Figure 4-12** below.

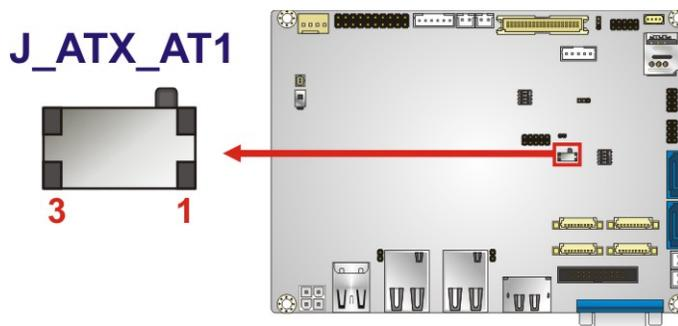

Figure 4-12: AT/ATX Mode Select Switch Location

4.7.2 Clear CMOS Button

CN Label:	J_CMOS1
CN Type:	Button
CN Location:	See Figure 4-13

If the WAFER-AL fails to boot due to improper BIOS settings, use the button to clear the CMOS data and reset the system BIOS information. To clear the CMOS, disconnect the battery (BT1) and press the clear CMOS button for about 3 seconds.

The location of the clear CMOS button is shown in **Figure 4-13**

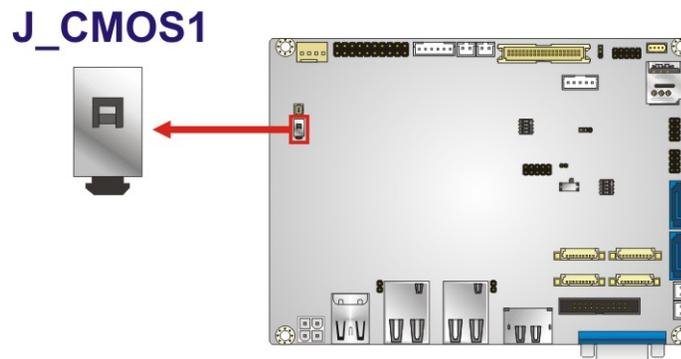

Figure 4-13: Clear CMOS Button Location

WAFER-AL SBC

4.7.3 LVDS Voltage Select Jumper



WARNING:

Permanent damage to the screen and WAFER-AL may occur if the wrong voltage is selected with this jumper. Please refer to the user guide that came with the monitor to select the correct voltage.

- Jumper Label:** JP2
- Jumper Type:** 3-pin header, p=2.00 mm
- Jumper Settings:** See **Table 4-2**
- Jumper Location:** See **Figure 4-14**

The LVDS voltage selection jumper allows setting the voltage provided to the monitor connected to the LVDS connector.

Setting	Description
Short 1-2	+3.3 V (Default)
Short 2-3	+5 V

Table 4-2: LVDS Voltage Select Jumper Settings

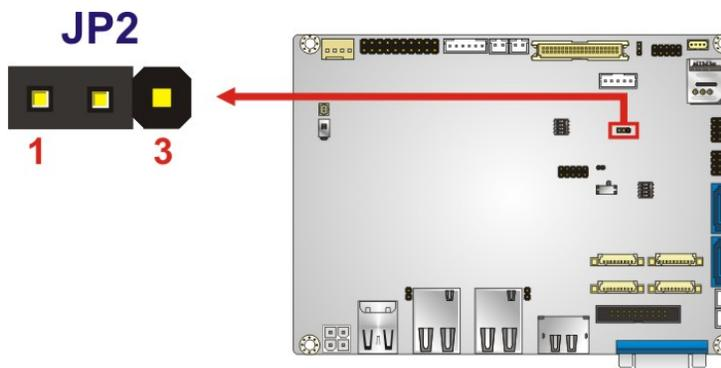

Figure 4-14: LVDS Voltage Select Jumper Location

4.7.4 LVDS Backlight Mode Select Jumper

- Jumper Label:** BL_MODE1
- Jumper Type:** 3-pin header, p=2.00 mm
- Jumper Settings:** See Table 4-3
- Jumper Location:** See Figure 4-15

The LVDS backlight mode selection jumper allows setting the mode of the LVDS backlight.

Setting	Description
Short 1-2	PWM mode (Default)
Short 2-3	DC mode

Table 4-3: LVDS Backlight Mode Select Jumper Settings

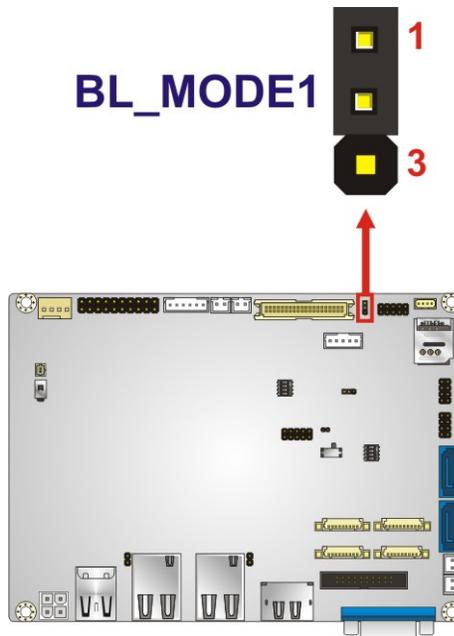

Figure 4-15: LVDS Backlight Mode Select Jumper Location

WAFER-AL SBC

4.7.5 LVDS Panel Resolution Select Switch

- Jumper Label:** SW1
- Jumper Type:** DIP switch
- Jumper Settings:** See Table 4-4
- Jumper Location:** See Figure 4-16

The SW1 selects the resolution of the LCD panel connected to the LVDS connector.

* ON=0, OFF=1; Single=S, Dual=D

SW1 (4-3-2-1)	Description
0000	800x600 18-bit S (default)
0001	1024x768 18-bit S
0010	1024x768 24-bit S
0011	1280x768 18-bit S
0100	1280x800 18-bit S
0101	1280x960 18-bit S
0110	1280x1024 24-bit D
0111	1366x768 18-bit S
1000	1366x768 24-bit S
1001	1440x900 24-bit D
1010	1400x1050 24-bit D
1011	1600x900 24-bit D
1100	1680x1050 24-bit D
1101	1600x1200 24-bit D
1110	1920x1080 24-bit D
1111	1920x1200 24-bit D

Table 4-4: LVDS Panel Resolution Selection

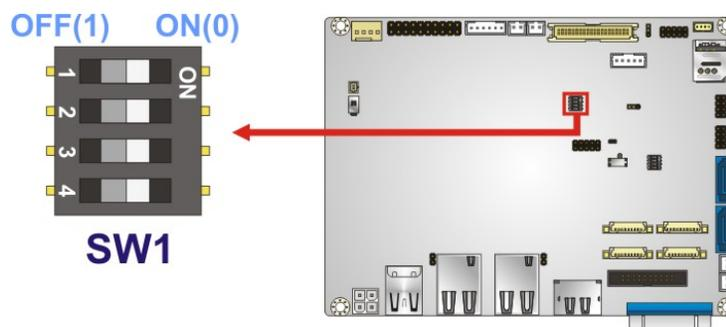

Figure 4-16: LVDS Panel Resolution Select Switch Location

4.7.6 RS-232/422/485 Mode Select Switch

- Jumper Label:** SW2
- Jumper Type:** DIP switch
- Jumper Settings:** See Table 4-5
- Jumper Location:** See Figure 4-17

The SW2 selects RS-232/422/485 mode of the COM1 and COM2 serial ports.

SW2 (1)	SW2 (2)	Description
ON	ON	COM1 RS-422
ON	OFF	COM1 RS-232 (Default)
OFF	ON	COM1 RS-485

SW2 (3)	SW2 (4)	Description
ON	ON	COM2 RS-422
ON	OFF	COM2 RS-232 (Default)
OFF	ON	COM2 RS-485

Table 4-5: RS-232/422/485 Mode Selection

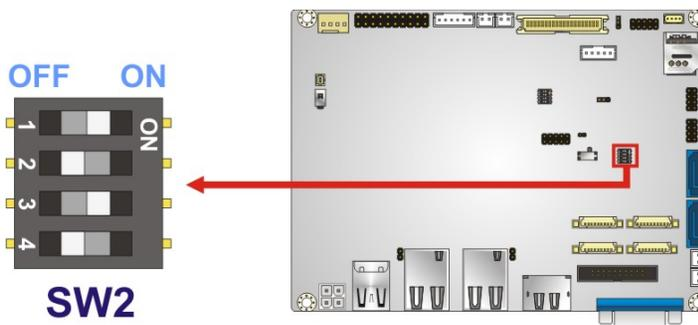

Figure 4-17: RS-232/422/485 Mode Select Switch Location

WAFER-AL SBC

4.8 Chassis Installation

4.8.1 Airflow



WARNING:

Airflow is critical for keeping components within recommended operating temperatures. The chassis should have fans and vents as necessary to keep things cool.

The WAFER-AL must be installed in a chassis with ventilation holes on the sides allowing airflow to travel through the heat sink surface. In a system with an individual power supply unit, the cooling fan of a power supply can also help generate airflow through the board surface.

4.8.2 Motherboard Installation

To install the WAFER-AL motherboard into the chassis please refer to the reference material that came with the chassis.

4.9 Internal Peripheral Device Connections

This section outlines the installation of peripheral devices to the onboard connectors.

4.9.1 Audio Kit Installation

The Audio Kit that came with the WAFER-AL connects to the audio connector on the WAFER-AL. The audio kit consists of three audio jacks. Mic-in connects to a microphone. Line-in provides a stereo line-level input to connect to the output of an audio device. Line-out, a stereo line-level output, connects to two amplified speakers. To install the audio kit, please refer to the steps below:

Step 1: **Locate the audio connector.** The location of the 10-pin audio connector is shown in **Chapter 3**.

Step 2: Align pin 1. Align pin 1 on the on-board connector with pin 1 on the audio kit connector. Pin 1 on the audio kit connector is indicated with a white dot. See Figure 4-18.

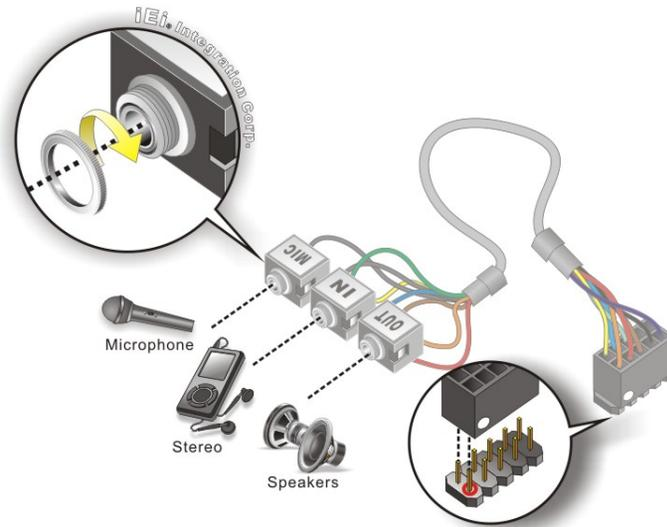

Figure 4-18: Audio Kit Cable Connection

Step 3: Connect the audio devices. Connect speakers to the line-out audio jack. Connect the output of an audio device to the line-in audio jack. Connect a microphone to the mic-in audio jack.

4.9.2 AT Power Connection

Follow the instructions below to connect the WAFER-AL to an AT power supply.



WARNING:

Disconnect the power supply power cord from its AC power source to prevent a sudden power surge to the WAFER-AL.

Step 1: Locate the power cable. The power cable is shown in the packing list in Chapter 2.

WAFER-AL SBC

Step 2: Connect the Power Cable to the Motherboard. Connect the 4-pin (2x2) Molex type power cable connector to the AT power connector on the motherboard. See Figure 4-19.

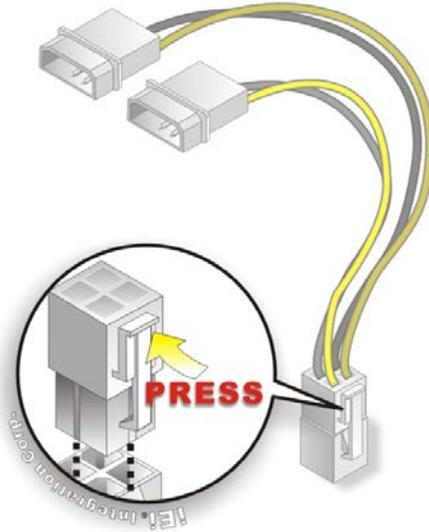

Figure 4-19: Power Cable to Motherboard Connection

Step 3: Connect Power Cable to Power Supply. Connect one of the 4-pin (1x4) Molex type power cable connectors to an AT power supply. See Figure 4-20.

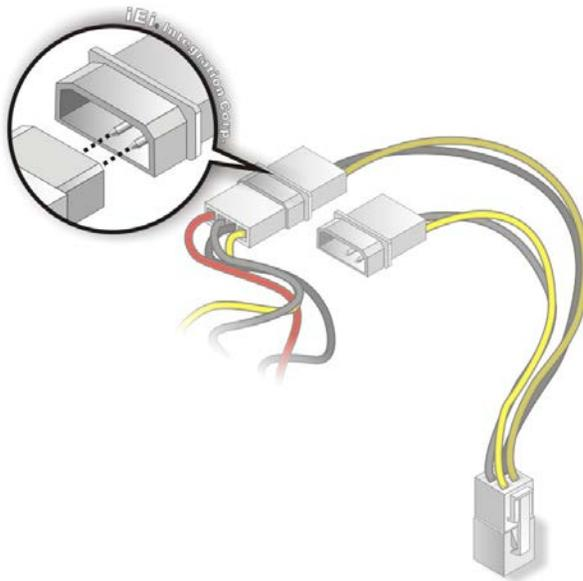

Figure 4-20: Connect Power Cable to Power Supply

4.9.3 SATA Drive Connection

The WAFER-AL is shipped with two SATA cables. To connect the SATA drive to the connector, please follow the steps below.

Step 1: Locate the SATA connector and the SATA power connector. The locations of the connectors are shown in **Chapter 3**.

Step 2: Insert the cable connector. Insert the cable connector into the on-board SATA drive connector and the SATA power connector. See **Figure 4-21**.



NOTE:

The connector locations in the following diagram are just for reference. For the exact locations, please see **Section 3.2.17** and **Section 3.2.18**.

WAFER-AL SBC

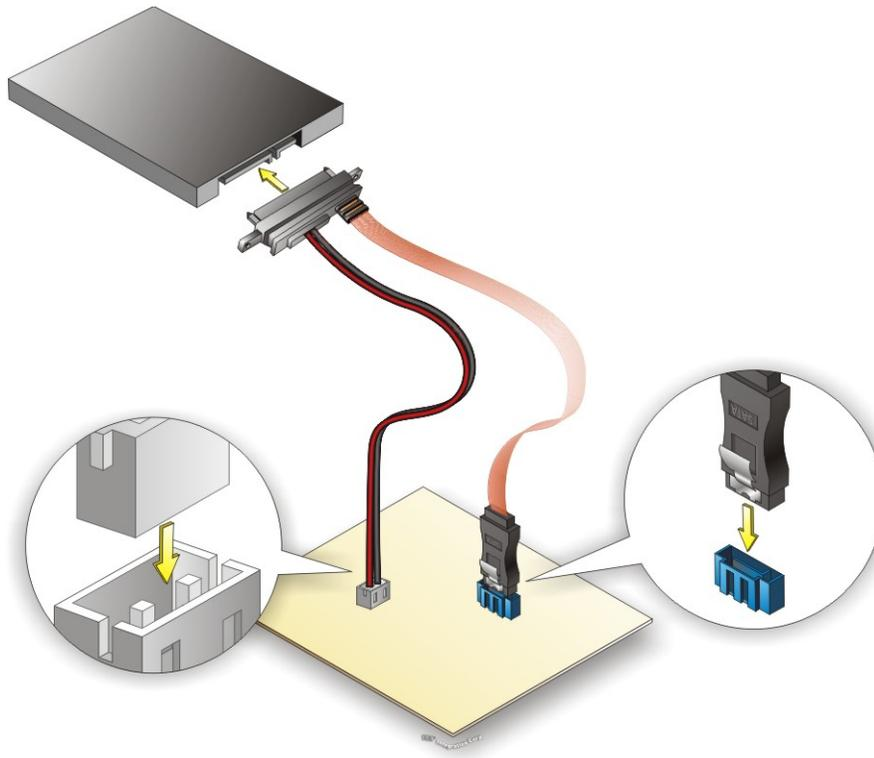

Figure 4-21: SATA Drive Cable Connection

Step 3: **Connect the cable to the SATA disk.** Connect the connector on the other end of the cable to the connector at the back of the SATA drive. See **Figure 4-21**.

Step 4: To remove the SATA cable from the SATA connector, press the clip on the connector at the end of the cable.

Chapter

5

BIOS

WAFER-AL SBC

5.1 Introduction

The BIOS is programmed onto the BIOS chip. The BIOS setup program allows changes to certain system settings. This chapter outlines the options that can be changed.



NOTE:

Some of the BIOS options may vary throughout the life cycle of the product and are subject to change without prior notice.

5.1.1 Starting Setup

The UEFI BIOS is activated when the computer is turned on. The setup program can be activated in one of two ways.

1. Press the **DELETE** or **F2** key as soon as the system is turned on or
2. Press the **DELETE** or **F2** key when the “**Press Del to enter SETUP**” message appears on the screen.

If the message disappears before the **DELETE** or **F2** key is pressed, restart the computer and try again.

5.1.2 Using Setup

Use the arrow keys to highlight items, press **ENTER** to select, use the PageUp and PageDown keys to change entries, press **F1** for help and press **ESC** to quit. Navigation keys are shown in Table 5-1.

Key	Function
Up arrow	Move to previous item
Down arrow	Move to next item
Left arrow	Move to the item on the left hand side
Right arrow	Move to the item on the right hand side
+	Increase the numeric value or make changes

Key	Function
-	Decrease the numeric value or make changes
F1 key	General help, only for Status Page Setup Menu and Option Page Setup Menu
F2 key	Load previous values.
F3 key	Load optimized defaults
F4 key	Save changes and Exit BIOS
Esc key	Main Menu – Quit and not save changes into CMOS Status Page Setup Menu and Option Page Setup Menu -- Exit current page and return to Main Menu

Table 5-1: BIOS Navigation Keys

5.1.3 Getting Help

When **F1** is pressed a small help window describing the appropriate keys to use and the possible selections for the highlighted item appears. To exit the Help Window press **Esc** or the **F1** key again.

5.1.4 Unable to Reboot after Configuration Changes

If the computer cannot boot after changes to the system configuration is made, CMOS defaults. Use the jumper described in **Section 4.7.2**.

5.1.5 BIOS Menu Bar

The **menu bar** on top of the BIOS screen has the following main items:

- Main – Changes the basic system configuration.
- Advanced – Changes the advanced system settings.
- Chipset – Changes the chipset settings.
- Security – Sets User and Supervisor Passwords.
- Boot – Changes the system boot configuration.
- Save & Exit – Selects exit options and loads default settings

WAFER-AL SBC

The following sections completely describe the configuration options found in the menu items at the top of the BIOS screen and listed above.

5.2 Main

The **Main** BIOS menu (**BIOS Menu 1**) appears when the **BIOS Setup** program is entered. The **Main** menu gives an overview of the basic system information.

```

Aptio Setup Utility - Copyright (C) 2017 American Megatrends, Inc.
Main  Advanced  Chipset  Security  Boot  Save & Exit

BIOS Information
BIOS Vendor                American Megatrends
Core Version                5.12
Compliancy                 UEFI 2.5; PI 1.4
Project Version            B409AR09.BIN
Build Date and Time        01/09/2017 15:49:35

Platform firmware Information
BXT SOC                    B1
MRC Version                0.56
PUNIT FW                  24
PMC FW                    03.26
TXE FW                    3.0.11.1131
ISH FW                    4.1.0.3364
GOP                      0.0.0036
CPU Flavor                 BXT Notebook/Desktop
Board ID                   Oxbow Hill CRB (06)
Fab ID                     FAB A

Memory Information
Total Memory               2048 MB
Memory Speed               1600 MHz

System Date                 [Fri 01/01/2010]
System Time                 [00:18:35]

Set the Date. Use Tab to
switch between Data
elements.

-----
<->: Select Screen
^ v: Select Item
Enter: Select
+/-: Change Opt.
F1:  General Help
F2:  Previous Values
F3:  Optimized Defaults
F4:  Save & Exit
ESC: Exit

Version 2.18.1263. Copyright (C) 2017 American Megatrends, Inc.
  
```

BIOS Menu 1: Main

→ System Date [xx/xx/xx]

Use the **System Date** option to set the system date. Manually enter the day, month and year.

→ **System Time [xx:xx:xx]**

Use the **System Time** option to set the system time. Manually enter the hours, minutes and seconds.

5.3 Advanced

Use the **Advanced** menu (**BIOS Menu 2**) to configure the CPU and peripheral devices through the following sub-menus:



WARNING!

Setting the wrong values in the sections below may cause the system to malfunction. Make sure that the settings made are compatible with the hardware.

```

Aptio Setup Utility - Copyright (C) 2017 American Megatrends, Inc.
Main  Advanced  Chipset  Security  Boot  Save & Exit

> Trusted Computing
> ACPI Settings
> F81866 Super IO Configuration
> F81866 H/W Monitor
> USB Configuration
> CPU Configuration
> RTC Wake Settings
> Power Saving Configuration
> Serial Port Console Redirection
> iEi Feature

System ACPI Parameters.

-----
<->: Select Screen
↑ ↓: Select Item
EnterSelect
F1  General Help
F2  Previous Values
F3  Optimized Defaults
F4  Save
ESC Exit

Version 2.18.1263. Copyright (C) 2017 American Megatrends, Inc.
    
```

BIOS Menu 2: Advanced

WAFER-AL SBC

5.3.1 Trusted Computing

Use the **Trusted Computing** menu (**BIOS Menu 3**) to configure settings related to the Trusted Computing Group (TCG) Trusted Platform Module (TPM).

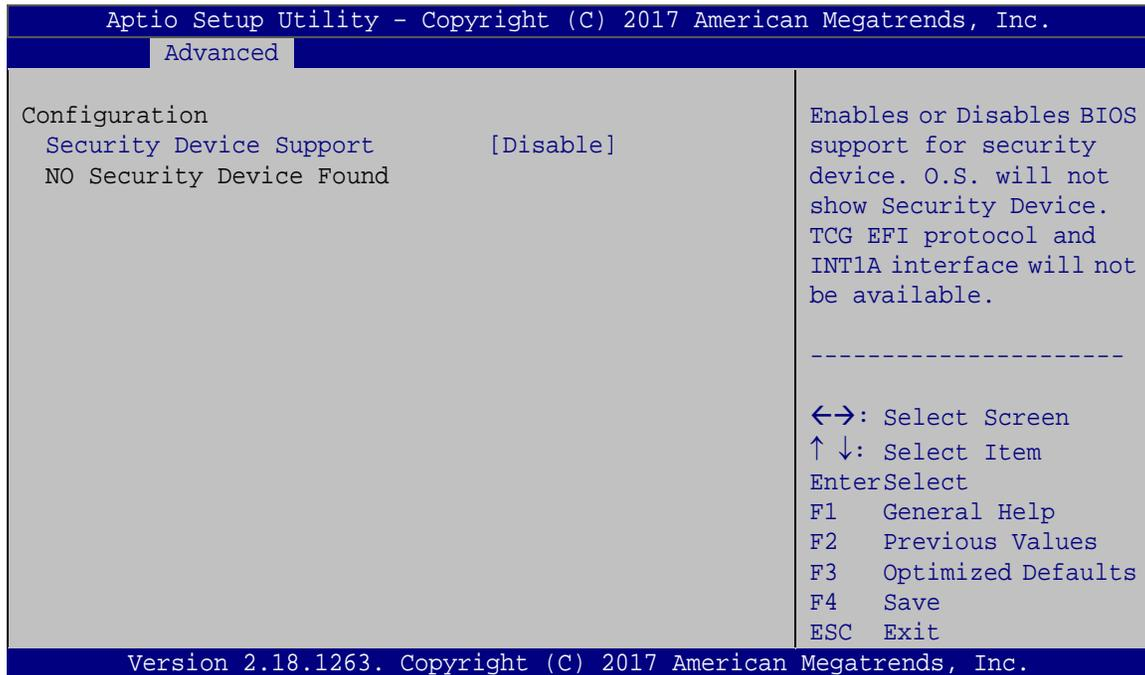

BIOS Menu 3: Trusted Computing

→ Security Device Support [Disable]

Use the **Security Device Support** option to configure support for the security device.

- **Disable** **DEFAULT** Security device support is disabled.
- **Enable** Security device support is enabled.

5.3.2 ACPI Settings

The **ACPI Settings** menu (**BIOS Menu 4**) configures the Advanced Configuration and Power Interface (ACPI) options.

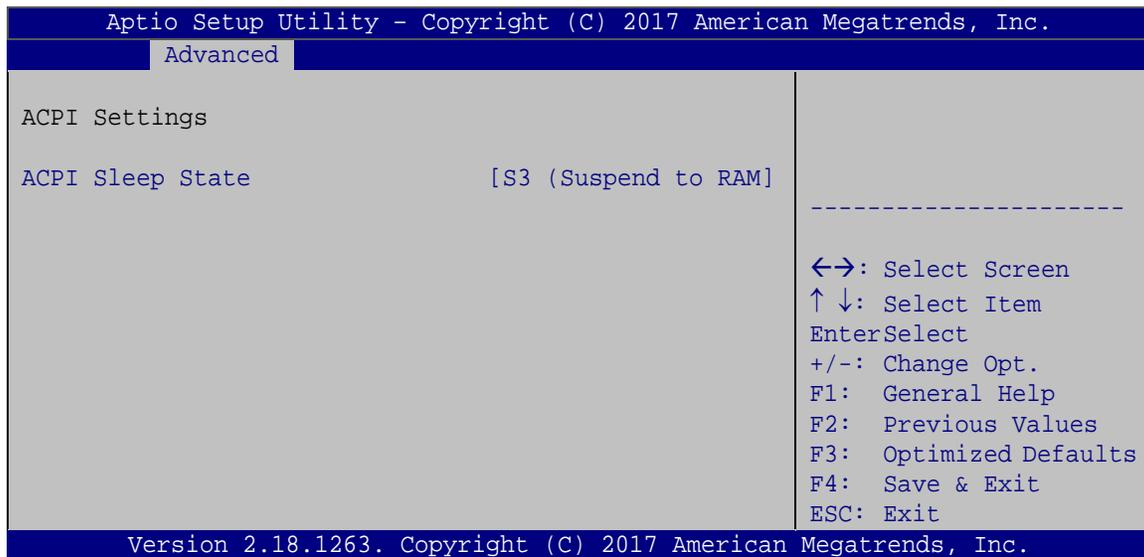

BIOS Menu 4: ACPI Settings

→ **ACPI Sleep State [S3 (Suspend to RAM)]**

Use the **ACPI Sleep State** option to specify the sleep state the system enters when it is not being used.

- **S3 (Suspend to DEFAULT RAM)** The caches are flushed and the CPU is powered off. Power to the RAM is maintained. The computer returns slower to a working state, but more power is saved.

WAFER-AL SBC

5.3.3 F81866 Super IO Configuration

Use the **F81866 Super IO Configuration** menu (**BIOS Menu 5**) to set or change the configurations for the serial ports.

```

Aptio Setup Utility - Copyright (C) 2017 American Megatrends, Inc.
  Advanced
F81866 Super IO Configuration                               Set Parameters of Serial
                                                           Port 1 (COMA)
Super IO Chip                                             F81866
> Serial Port 1 Configuration
> Serial Port 2 Configuration
> Serial Port 3 Configuration
> Serial Port 4 Configuration
                                                           -----
                                                           <->: Select Screen
                                                           ↑ ↓: Select Item
                                                           EnterSelect
                                                           F1   General Help
                                                           F2   Previous Values
                                                           F3   Optimized
                                                           Defaults
                                                           F4   Save
                                                           ESC  Exit
Version 2.18.1263. Copyright (C) 2017 American Megatrends, Inc.
    
```

BIOS Menu 5: F81866 Super IO Configuration

5.3.3.1 Serial Port n Configuration

Use the **Serial Port n Configuration** menu (**BIOS Menu 6**) to configure the serial port n.

```

Aptio Setup Utility - Copyright (C) 2017 American Megatrends, Inc.
  Advanced
Serial Port 1 Configuration                               Enable or Disable Serial
                                                           Port (COM)
Serial Port                                             [Enabled]
Device Settings                                       IO=3F8h; IRQ=4
                                                           -----
Change Settings                                       [IO=3F8h; IRQ=4]
Transfer Mode                                         [RS232]
                                                           -----
                                                           <->: Select Screen
                                                           ↑ ↓: Select Item
                                                           EnterSelect
                                                           F1   General Help
                                                           F2   Previous Values
                                                           F3   Optimized
                                                           Defaults
                                                           F4   Save
                                                           ESC  Exit
Version 2.18.1263. Copyright (C) 2017 American Megatrends, Inc.
    
```

BIOS Menu 6: Serial Port n Configuration

5.3.3.1.1 Serial Port 1 Configuration

→ **Serial Port [Enabled]**

Use the **Serial Port** option to enable or disable the serial port.

- **Disabled** Disable the serial port
- **Enabled DEFAULT** Enable the serial port

→ **Change Settings [IO=3F8h; IRQ=4]**

Use the **Change Settings** option to change the serial port IO port address and interrupt address.

- **IO=3F8h; IRQ=4 DEFAULT** Serial Port I/O port address is 3F8h and the interrupt address is IRQ4
- **IO=3F8h;
IRQ=3, 4** Serial Port I/O port address is 3F8h and the interrupt address is IRQ3, 4
- **IO=2F8h;
IRQ=3, 4** Serial Port I/O port address is 2F8h and the interrupt address is IRQ3, 4
- **IO=3E8h;
IRQ=3, 4** Serial Port I/O port address is 3E8h and the interrupt address is IRQ3, 4
- **IO=2E8h;
IRQ=3, 4** Serial Port I/O port address is 2E8h and the interrupt address is IRQ3, 4

→ **Transfer Mode [RS232]**

Use the **Transfer Mode** option to select the Serial Port 1 signaling mode.

- **RS422** Serial Port 6 signaling mode is RS-422
- **RS232 DEFAULT** Serial Port 6 signaling mode is RS-232
- **RS485** Serial Port 6 signaling mode is RS-485

WAFER-AL SBC

5.3.3.1.2 Serial Port 2 Configuration

→ Serial Port [Enabled]

Use the **Serial Port** option to enable or disable the serial port.

- **Disabled** Disable the serial port
- **Enabled** **DEFAULT** Enable the serial port

→ Change Settings [IO=2F8h; IRQ=3]

Use the **Change Settings** option to change the serial port IO port address and interrupt address.

- **IO=2F8h; IRQ=3** **DEFAULT** Serial Port I/O port address is 2F8h and the interrupt address is IRQ3
- **IO=3F8h;
IRQ=3, 4** Serial Port I/O port address is 3F8h and the interrupt address is IRQ3, 4
- **IO=2F8h;
IRQ=3, 4** Serial Port I/O port address is 2F8h and the interrupt address is IRQ3, 4
- **IO=3E8h;
IRQ=3, 4** Serial Port I/O port address is 3E8h and the interrupt address is IRQ3, 4
- **IO=2E8h;
IRQ=3, 4** Serial Port I/O port address is 2E8h and the interrupt address is IRQ3, 4

→ Transfer Mode [RS232]

Use the **Transfer Mode** option to select the Serial Port 2 signaling mode.

- **RS422** Serial Port 6 signaling mode is RS-422
- **RS232** **DEFAULT** Serial Port 6 signaling mode is RS-232
- **RS485** Serial Port 6 signaling mode is RS-485

5.3.3.1.3 Serial Port 3 Configuration

→ Serial Port [Enabled]

Use the **Serial Port** option to enable or disable the serial port.

- **Disabled** Disable the serial port
- **Enabled** **DEFAULT** Enable the serial port

→ Change Settings [IO=3E8h; IRQ=10]

Use the **Change Settings** option to change the serial port IO port address and interrupt address.

- **IO=3E8h; IRQ=10** **DEFAULT** Serial Port I/O port address is 3E8h and the interrupt address is IRQ10
- **IO=2E8h; IRQ=10** Serial Port I/O port address is 2E8h and the interrupt address is IRQ10
- **IO=3E0h; IRQ=10** Serial Port I/O port address is 3E0h and the interrupt address is IRQ10
- **IO=2E0h; IRQ=10** Serial Port I/O port address is 2E0h and the interrupt address is IRQ10

WAFER-AL SBC

5.3.3.1.4 Serial Port 4 Configuration

→ Serial Port [Enabled]

Use the **Serial Port** option to enable or disable the serial port.

- **Disabled** Disable the serial port
- **Enabled** **DEFAULT** Enable the serial port

→ Change Settings [IO=2E8h; IRQ=10]

Use the **Change Settings** option to change the serial port IO port address and interrupt address.

- **IO=3E8h; IRQ=10** Serial Port I/O port address is 3E8h and the interrupt address is IRQ10
- **IO=2E8h; IRQ=10** **DEFAULT** Serial Port I/O port address is 2E8h and the interrupt address is IRQ10
- **IO=3E0h; IRQ=10** Serial Port I/O port address is 3E0h and the interrupt address is IRQ10
- **IO=2E0h; IRQ=10** Serial Port I/O port address is 2E0h and the interrupt address is IRQ10

5.3.4 F81866 H/W Monitor

The **F81866 H/W Monitor** menu (**BIOS Menu 7**) contains the fan configuration submenus and displays operating temperature, fan speeds and system voltages.

```

Aptio Setup Utility - Copyright (C) 2017 American Megatrends, Inc.
  Advanced
PC Health Status
> Smart Fan Mode Configuration
CPU Temperature      :+50 °C
System Temperature  :+49 °C
CPU_FAN1 Speed      :N/A
CPU_CORE            :+0.712 V
+5V                 :+5.087 V
+12V                :+12.144 V
+5VSB               :+5.064 V
+3.3V               :+3.456 V
+3.3VSB            :+3.424 V
Smart Fan Mode Select
-----
<=>: Select Screen
↑↓: Select Item
Enter>Select
+ - Change Opt.
F1  General Help
F2  Previous Values
F3  Optimized Defaults
F4  Save & Exit
ESC Exit
Version 2.18.1263. Copyright (C) 2017 American Megatrends, Inc.
    
```

BIOS Menu 7: F81866 H/W Monitor

→ PC Health Status

The following system parameters and values are shown. The system parameters that are monitored are:

- System Temperatures:
 - CPU Temperature
 - System temperature
- Fan Speed:
 - CPU Fan Speed
- Voltages
 - CPU_CORE
 - +5V
 - +12V
 - +5VSB
 - +3.3V

WAFER-AL SBC

- +3.3VSB

5.3.4.1 Smart Fan Mode Configuration

Use the **Smart Fan Mode Configuration** submenu (**BIOS Menu 8**) to configure fan temperature and speed settings.

```

Aptio Setup Utility - Copyright (C) 2017 American Megatrends, Inc.
Advanced
Smart Fan Mode Configuration
CPU_FAN1 Smart Fan Control [Auto Duty-Cycle Mode]
CPU Temperature 1 60
CPU Temperature 2 50
CPU Temperature 3 40
CPU Temperature 4 30
Smart Fan Mode Select
-----
<->: Select Screen
↑ ↓: Select Item
Enter>Select
+ - Change Opt.
F1 General Help
F2 Previous Values
F3 Optimized Defaults
F4 Save & Exit
ESC Exit
Version 2.18.1263. Copyright (C) 2017 American Megatrends, Inc.
    
```

BIOS Menu 8: Smart Fan Mode Configuration

➔ CPU_FAN1 Smart Fan Control [Auto Duty-Cycle Mode]

Use the **CPU_FAN1 Smart Fan Control** BIOS option to configure the CPU Smart Fan.

- ➔ **Manual Duty Mode** The fan spins at the speed set in the Manual Mode option
- ➔ **Auto Duty-Cycle Mode** **DEFAULT** The fan adjusts its speed using Auto Duty-Cycle Mode settings

➔ CPU Temperature 1

If CPU temperature is higher than the value set in this BIOS option, the fan duty cycle is 100. Use the + or – key to change the value or enter a decimal number between 1 and 100.

➔ **CPU Temperature 2**

If CPU temperature is higher than the value set in this BIOS option, the fan duty cycle is 85. Use the + or – key to change the value or enter a decimal number between 1 and 100.

➔ **CPU Temperature 3**

If CPU temperature is higher than the value set in this BIOS option, the fan duty cycle is 70. Use the + or – key to change the value or enter a decimal number between 1 and 100.

➔ **CPU Temperature 4**

If CPU temperature is higher than the value set in this BIOS option, the fan duty cycle is 60; if it is lower than the value, the fan duty cycle is 50. Use the + or – key to change the value or enter a decimal number between 1 and 100.

5.3.5 USB Configuration

Use the **USB Configuration** menu (**BIOS Menu 9**) to read USB configuration information and configure the USB settings.

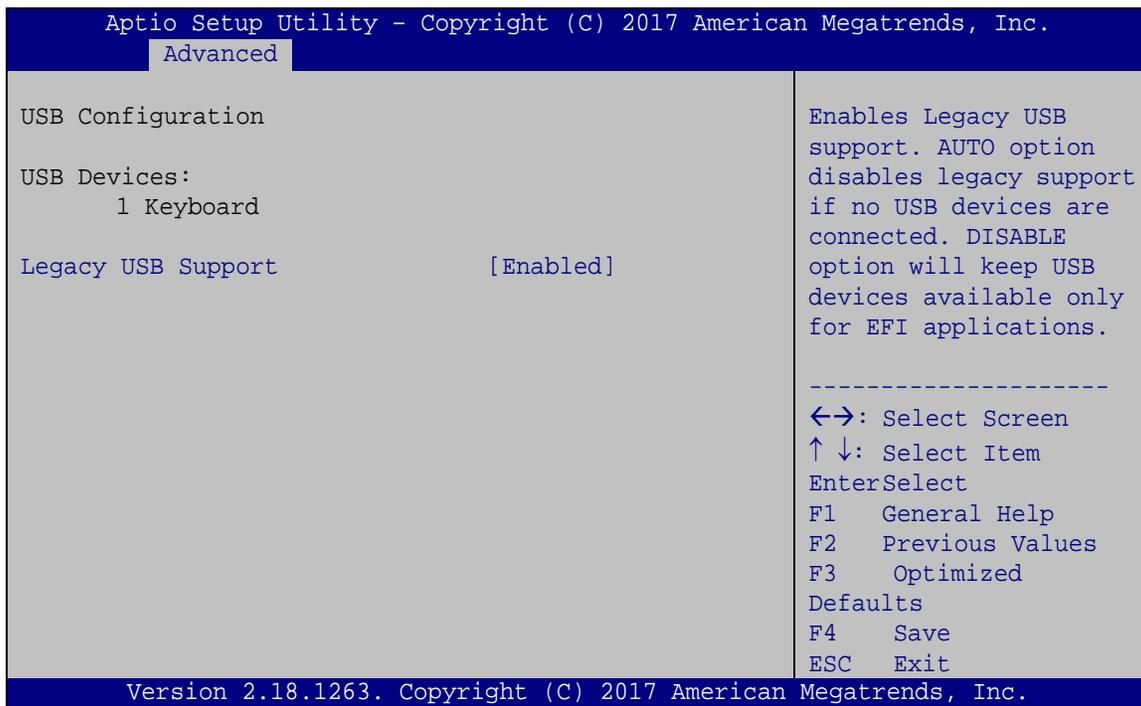

BIOS Menu 9: USB Configuration

WAFER-AL SBC

→ USB Devices

The **USB Devices Enabled** field lists the USB devices that are enabled on the system

→ Legacy USB Support [Enabled]

Use the **Legacy USB Support** BIOS option to enable USB mouse and USB keyboard support. Normally if this option is not enabled, any attached USB mouse or USB keyboard does not become available until a USB compatible operating system is fully booted with all USB drivers loaded. When this option is enabled, any attached USB mouse or USB keyboard can control the system even when there is no USB driver loaded onto the system.

- | | | |
|-------------------|----------------|---|
| → Enabled | DEFAULT | Legacy USB support enabled |
| → Disabled | | Legacy USB support disabled |
| → Auto | | Legacy USB support disabled if no USB devices are connected |

5.3.6 CPU Configuration

Use the **CPU Configuration** menu (**BIOS Menu 10**) to view detailed CPU specifications and configure the CPU.

```

Apdio Setup Utility - Copyright (C) 2017 American Megatrends, Inc.
  Advanced
CPU Configuration
Intel(R) Celeron(R) CPU N3350 @ 1.10GHz
CPU Signature          506C9
Microcode Patch       28
Max CPU Speed         1100 MHz
Min CPU Speed         800 MHz
Processor Cores       2
Intel HT Technology   Not Supported
Intel VT-x Technology Supported
-----
L1 Data Cache         24 KB x 2
L1 Code Cache         32 KB x 2
L2 Cache              1024 KB x 1
L3 Cache              Not Present
64-bit                Supported

EIST                  [Enabled]
C-States              [Disabled]
Intel Virtualization Technology [Disabled]
VT-d                  [Disabled]

Enable/Disable Intel SpeedStep

<=>: Select Screen
↑ ↓: Select Item
Enter>Select
F1  General Help
F2  Previous Values
F3  Optimized
Defaults
F4  Save
ESC Exit

Version 2.18.1263. Copyright (C) 2017 American Megatrends, Inc.
    
```

BIOS Menu 10: CPU Configuration

→ EIST [Enabled]

Use the **EIST** option to enable or disable the Intel® Speed Step Technology.

- **Disabled** Disables the Intel® Speed Step Technology.
- **Enabled** **DEFAULT** Enables the Intel® Speed Step Technology.

→ C-States [Disabled]

Use the **C-States** option to enable or disable the C-states.

- **Disabled** **DEFAULT** Disables the C-state

WAFER-AL SBC

→ **Enabled** Enables the C-state

→ **Intel Virtualization Technology [Disabled]**

Use the **Intel Virtualization Technology** option to enable or disable virtualization on the system. When combined with third party software, Intel® Virtualization technology allows several OSs to run on the same system at the same time.

→ **Disabled** **DEFAULT** Disables Intel® Virtualization Technology.

→ **Enabled** Enables Intel® Virtualization Technology.

→ **VT-d [Disabled]**

Use the **VT-d** BIOS option to enable or disabled VT-d support.

→ **Disabled** **DEFAULT** Disable VT-d support.

→ **Enabled** Enable VT-d support.

5.3.7 RTC Wake Settings

The **RTC Wake Settings** menu (**BIOS Menu 11**) configures RTC wake event.

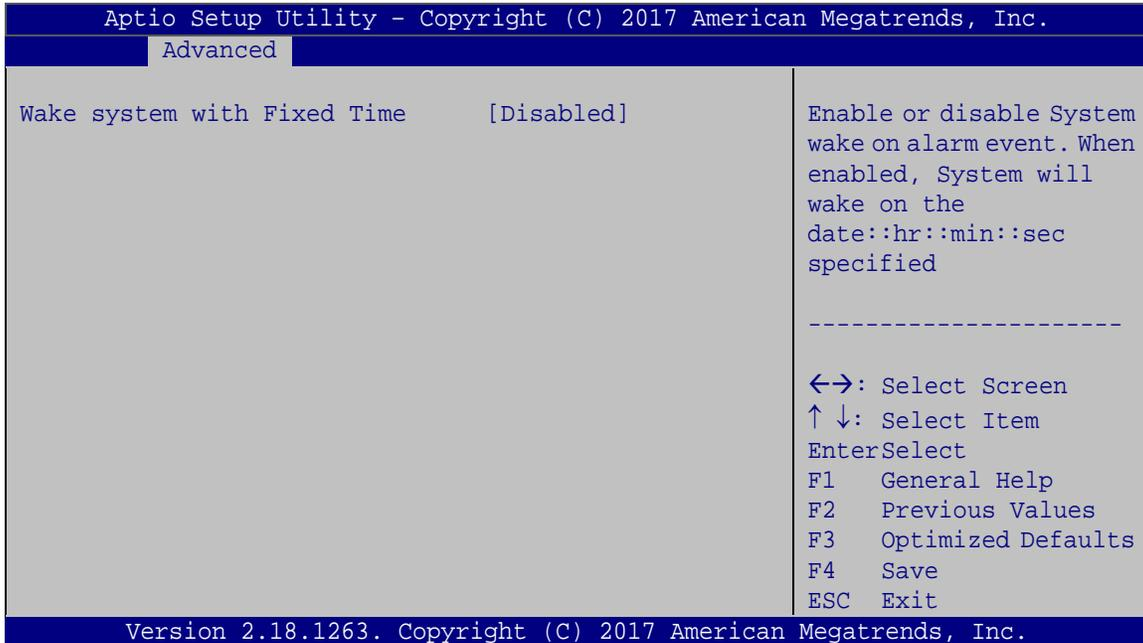

BIOS Menu 11: RTC Wake Settings

→ Wake system with Fixed Time [Disabled]

Use the **Wake system with Fixed Time** option to enable or disable the system wake on alarm event.

- **Disabled** **DEFAULT** The real time clock (RTC) cannot generate a wake event
- **Enabled** If selected, the **Wake up every day** option appears allowing you to enable to disable the system to wake every day at the specified time. Besides, the following options appear with values that can be selected:
 - Wake up date
 - Wake up hour
 - Wake up minute

WAFER-AL SBC

Wake up second

After setting the alarm, the computer turns itself on from a suspend state when the alarm goes off.

5.3.8 Power Saving Configuration

Use the **Power Saving Configuration** menu (**BIOS Menu 12**) to configure system to reduce power consumption in system off state.

```

Aptio Setup Utility - Copyright (C) 2017 American Megatrends, Inc.
  Advanced
Power Saving Configuration
Power Saving Function          [Disabled]
Enable or Disable to
reduce power consumption
in system off state.
-----
<=>: Select Screen
↑ ↓: Select Item
Enter Select
F1   General Help
F2   Previous Values
F3   Optimized
Defaults
F4   Save
ESC  Exit
Version 2.18.1263. Copyright (C) 2017 American Megatrends, Inc.
    
```

BIOS Menu 12: Power Saving Configuration

→ Power Saving Function(ERP) [Disabled]

Use the **Power Saving Function** BIOS option to enable or disable the power saving function.

- **Disabled** **DEFAULT** Power saving function is disabled.
- **Enabled** Power saving function is enabled. It will reduce power consumption when the system is off.

5.3.9 Serial Port Console Redirection

The **Serial Port Console Redirection** menu (**BIOS Menu 13**) allows the console redirection options to be configured. Console redirection allows users to maintain a system remotely by re-directing keyboard input and text output through the serial port.

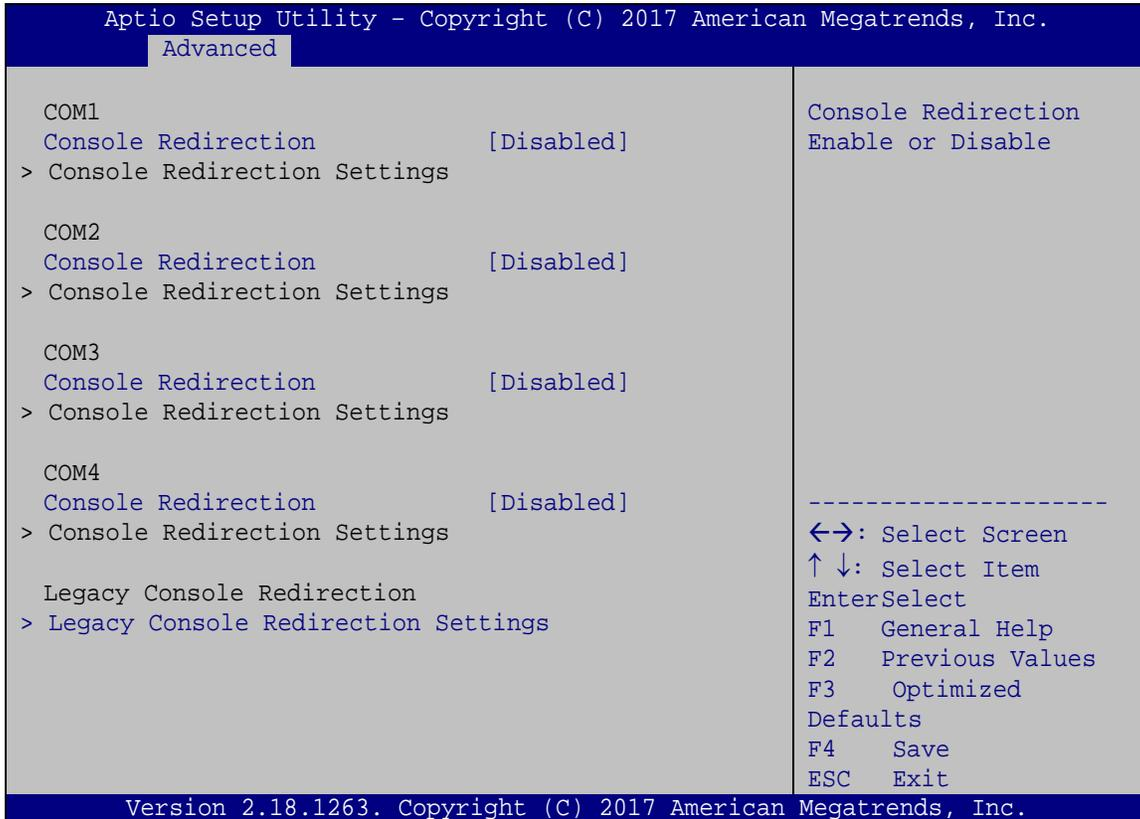

BIOS Menu 13: Serial Port Console Redirection

→ Console Redirection [Disabled]

Use **Console Redirection** option to enable or disable the console redirection function.

- **Disabled** **DEFAULT** Disabled the console redirection function
- **Enabled** Enabled the console redirection function

WAFER-AL SBC

5.3.9.1 Legacy Console Redirection Settings

The **Legacy Console Redirection Settings** menu (**BIOS Menu 14**) allows the legacy console redirection options to be configured.

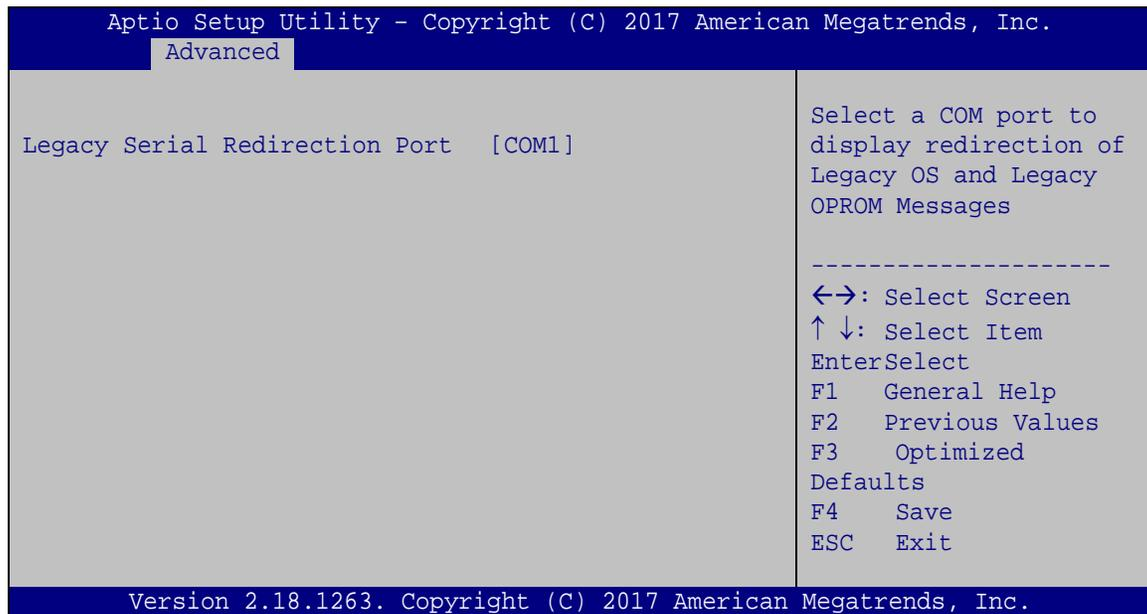

BIOS Menu 14: Legacy Console Redirection Settings

→ Legacy Serial Redirection Port [COM1]

Use the **Legacy Serial Redirection Port** option to specify a COM port to display redirection of legacy OS and legacy OPROM messages. The options include:

- COM1 **DEFAULT**
- COM2
- COM3
- COM4

WAFER-AL SBC

5.4 Chipset

Use the **Chipset** menu (**BIOS Menu 16**) to access the north bridge and south bridge configuration menus



WARNING!

Setting the wrong values for the Chipset BIOS selections in the Chipset BIOS menu may cause the system to malfunction.

```

Aptio Setup Utility - Copyright (C) 2017 American Megatrends, Inc.
Main   Advanced  Chipset  Security  Boot   Save & Exit
-----
> North Bridge
> South Bridge

North Bridge Parameters
-----
<=>: Select Screen
↑ ↓: Select Item
Enter>Select
+/-: Change Opt.
F1   General Help
F2   Previous Values
F3   Optimized Defaults
F4   Save & Exit
ESC  Exit

Version 2.18.1263. Copyright (C) 2017 American Megatrends, Inc.
    
```

BIOS Menu 16: Chipset

5.4.1 North Bridge Configuration

Use the **North Bridge Configuration** menu (**BIOS Menu 17**) to configure the Intel IGD settings.

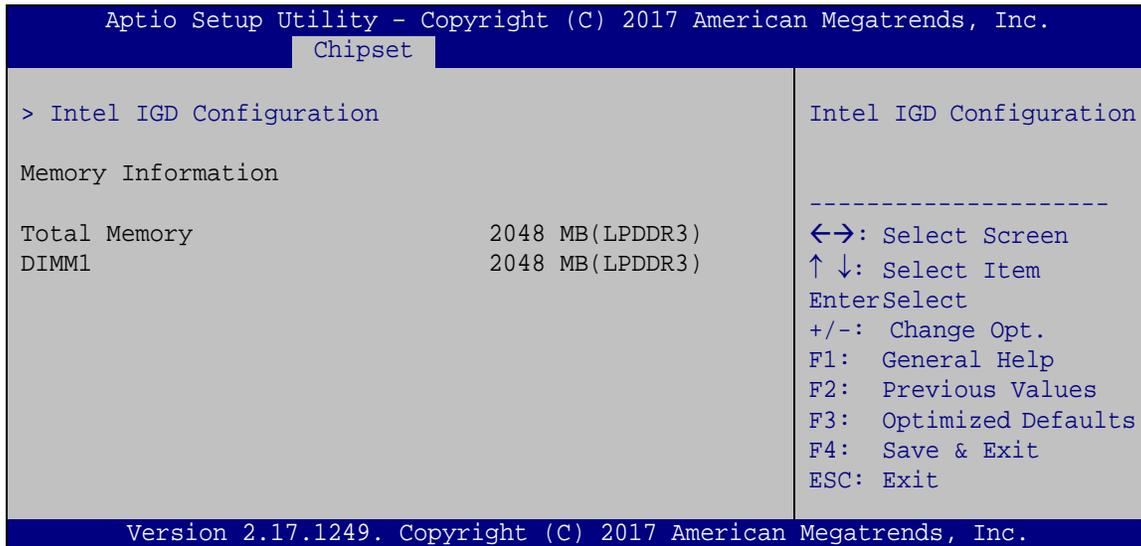

BIOS Menu 17: North Bridge Configuration

→ Memory Information

The **Memory Information** lists a brief summary of the on-board memory. The fields in **Memory Information** cannot be changed.

5.4.1.1 Intel IGD Configuration

Use the **Intel IGD Configuration** menu (**BIOS Menu 18**) to configure the video device connected to the system.

WAFER-AL SBC

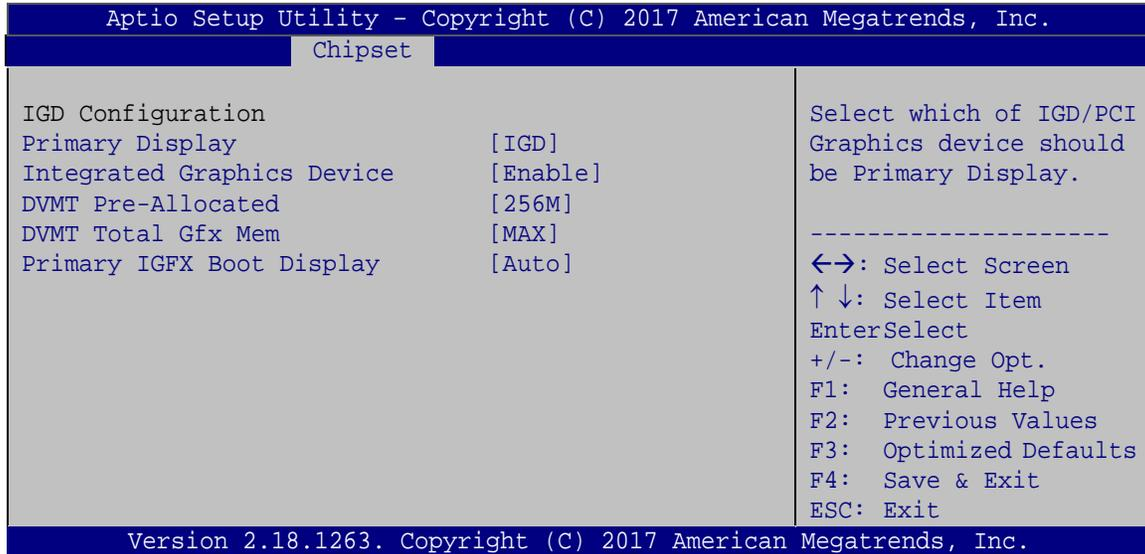

BIOS Menu 18: Intel IGD Configuration

→ Primary Display [IGD]

Use the **Primary Display** option to select the graphics controller used as the primary boot device. Select either an integrated graphics controller (IGD) or a PCI express (PEG) controller. Configuration options are listed below:

- IGD **DEFAULT**
- PCIe

→ Integrated Graphics Device [Enable]

Use the **Integrated Graphics Device** option enables or disables Integrated Graphics Device (IGD).

- **Disable** Always disable IGD.
- **Enable** **DEFAULT** Enabled Integrated Graphics Device (IGD) when selected as the Primary Video Adaptor.

→ DVMT Pre-Allocated [256MB]

Use the **DVMT Pre-Allocated** option to set the amount of system memory allocated to the integrated graphics processor when the system boots. The system memory allocated can

then only be used as graphics memory, and is no longer available to applications or the operating system. Configuration options are listed below:

- 64M
- 128M
- 256M **DEFAULT**
- 512M

→ **DVMT Total Gfx Mem [MAX]**

Use the **DVMT Total Gfx Mem** option to select DVMT5.0 total graphic memory size used by the internal graphic device. The following options are available:

- 128M
- 256M
- MAX **DEFAULT**

→ **Primary IGFX Boot Display [Auto]**

Use the **Primary IGFX Boot Display** option to select the display device used by the system when it boots. Configuration options are listed below.

- Auto **DEFAULT**
- CRT
- LVDS
- DP

5.4.2 South Bridge Configuration

Use the **South Bridge Configuration** menu (**BIOS Menu 19**) to configure the south bridge chipset.

WAFER-AL SBC

```

Aptio Setup Utility - Copyright (C) 2017 American Megatrends, Inc.
Chipset
Auto Power Button Function      [Disable (ATX)]
> HD-Audio Configuration
> PCI Express Configuration
> SATA Configuration

Restore AC Power Loss          [Last State]

-----
←→: Select Screen
↑↓: Select Item
Enter: Select
+/-: Change Opt.
F1:  General Help
F2:  Previous Values
F3:  Optimized Defaults
F4:  Save & Exit
ESC: Exit

Version 2.18.1263. Copyright (C) 2017 American Megatrends, Inc.

```

BIOS Menu 19: South Bridge Configuration

→ Restore on AC Power Loss [Last State]

Use the **Restore on AC Power Loss** BIOS option to specify what state the system returns to if there is a sudden loss of power to the system.

- **Power Off** The system remains turned off
- **Power On** The system turns on
- **Last State** **DEFAULT** The system returns to its previous state. If it was on, it turns itself on. If it was off, it remains off.

5.4.2.1 HD-Audio Configuration

Use the **HD-Audio Configuration** menu (**BIOS Menu 20**) to configure the HD Audio.



BIOS Menu 20: HD-Audio Configuration

→ HD-Audio Support [Enable]

Use the **HD-Audio Support** option to enable or disable the High Definition Audio controller.

- **Disable** The onboard High Definition Audio controller is disabled
- **Enable** **DEFAULT** The onboard High Definition Audio controller is detected automatically and enabled

WAFER-AL SBC

5.4.2.2 PCI Express Configuration

Use the **PCI Express Configuration** menu (**BIOS Menu 21**) to configure the PCI Express.

```

Aptio Setup Utility - Copyright (C) 2017 American Megatrends, Inc.
Chipset
-----
PCI Express Configuration
> Onboard LAN1
> Onboard LAN2
> MINI-PCIE1
> MINI-PCIE2

Control the PCI Express Root Port.
Enable: Enable PCIe root port
Disable: Disable PCIe root port

-----
<=>: Select Screen
↑ ↓: Select Item
Enter>Select
F1   General Help
F2   Previous Values
F3   Optimized
Defaults
F4   Save
ESC  Exit

Version 2.18.1263. Copyright (C) 2017 American Megatrends, Inc.
  
```

BIOS Menu 21: PCI Express Configuration

5.4.2.2.1 Onboard LAN

Use the **Onboard LAN** menus (**BIOS Menu 22**) to configure the LAN 1 or LAN 2 port.

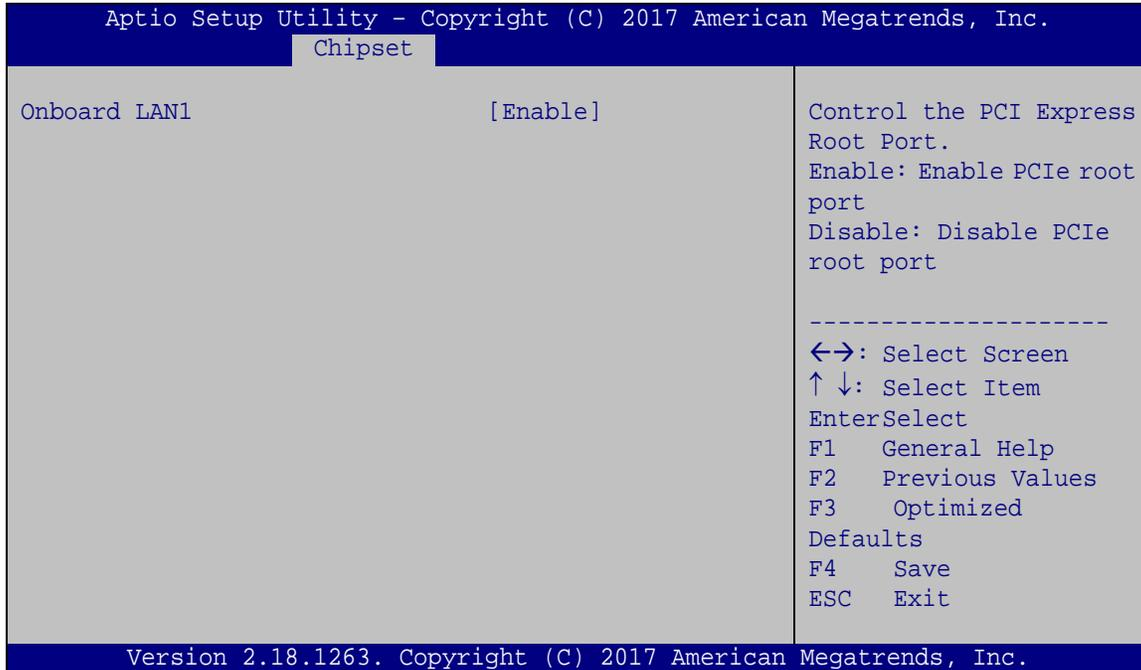

BIOS Menu 22: Onboard LAN

→ Onboard LAN1/2 [Enable]

Use the **Onboard LAN1/** option to enable or disable the LAN port.

- **Disable** Disable the LAN port
- **Enable** **DEFAULT** Enable the LAN port

WAFER-AL SBC

5.4.2.2.2 MINI-PCIE

Use the **MINI-PCIE** menus (**BIOS Menu 23**) to configure the PCIe Mini slots.

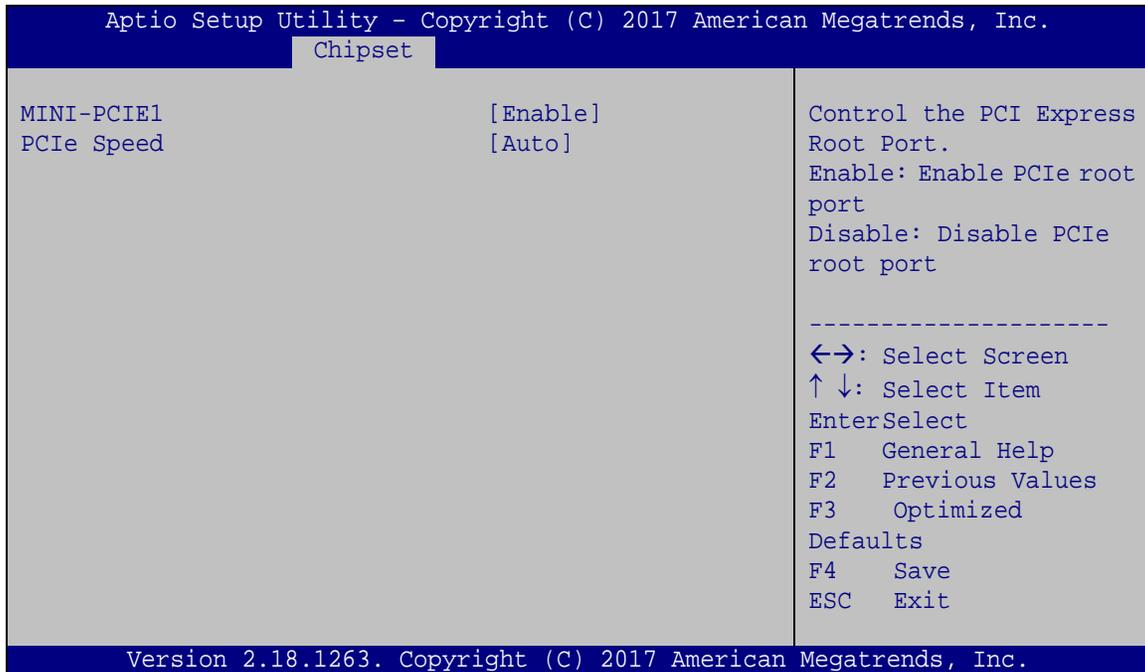

BIOS Menu 23: MINI-PCIE

→ MINI-PCIE1/ MINI-PCIE2 [Enable]

Use the **MINI-PCIE1/ MINI-PCIE2** option to enable or disable the PCIe Mini slot.

- **Disable** Disable PCIe Mini slot.
- **Enable** **DEFAULT** Enable PCIe Mini slot.

→ PCIe Speed [Auto]

Use the **PCIe Speed** option to configure PCIe Mini slot speed.

- **Auto** **DEFAULT** Configure PCIe Mini slot speed to auto
- **Gen 1** Configure PCIe Mini slot speed to Gen1
- **Gen 2** Configure PCIe Mini slot speed to Gen2

5.4.2.3 SATA Configuration

Use the **SATA Configuration** menu (**BIOS Menu 24**BIOS Menu 24BIOS Menu 24BIOS Menu 24BIOS Menu 24) to change and/or set the configuration of the SATA devices installed in the system. BIOS Menu 24BIOS Menu 24

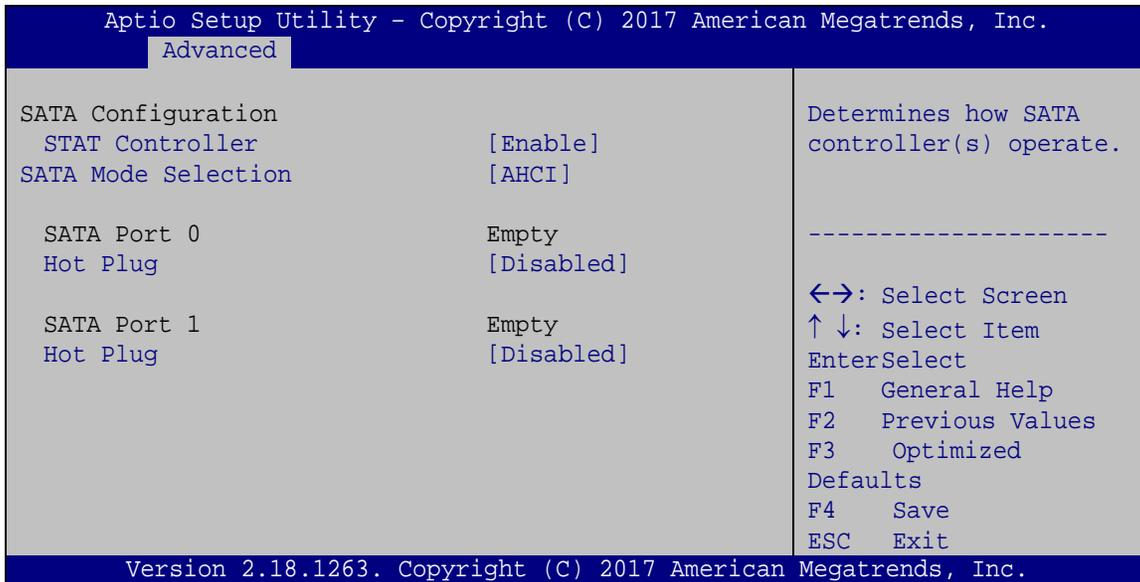

BIOS Menu 24: SATA Configuration

→ STAT Controller [Enable]

Use the **STAT Controller(s)** option to enable or disable the SATA device.

- **Enable** **DEFAULT** Enables the SATA device.
- **Disable** Disables the SATA device.

→ SATA Mode Selection [AHCI]

Use the **SATA Mode Selection** option to configure SATA devices as AHCI devices.

- **AHCI** **DEFAULT** Configures SATA devices as AHCI device.

WAFER-AL SBC

→ Hot Plug [Disabled]

Use the **Hot Plug** option to enable or disable the SATA device hot plug.

- **Disabled** **DEFAULT** Disables the SATA device hot plug.
- **Enabled** Enables the SATA device hot plug

5.5 Security

Use the **Security** menu (**BIOS Menu 25**) to set system and user passwords.

```

Aptio Setup Utility - Copyright (C) 2017 American Megatrends, Inc.
Main   Advanced  Chipset  Security  Boot   Save & Exit

Password Description
-----
If ONLY the Administrator's password is set,
then this only limits access to Setup and is
only asked for when entering Setup
If ONLY the User's password is set, then this
is a power on password and must be entered to
boot or enter Setup. In Setup the User will
have Administrator rights.
The password length must be:
Minimum length           3
Maximum length          20

Administrator Password
User Password

Set Administrator
Password

-----
←→: Select Screen
↑ ↓: Select Item
Enter>Select
F1  General Help
F2  Previous Values
F3  Optimized
Defaults
F4  Save
ESC Exit

Version 2.18.1263. Copyright (C) 2017 American Megatrends, Inc.
    
```

BIOS Menu 25: Security

→ Administrator Password

Use the **Administrator Password** to set or change a administrator password.

→ User Password

Use the **User Password** to set or change a user password.

5.6 Boot

Use the **Boot** menu (**BIOS Menu 26**) to configure system boot options.

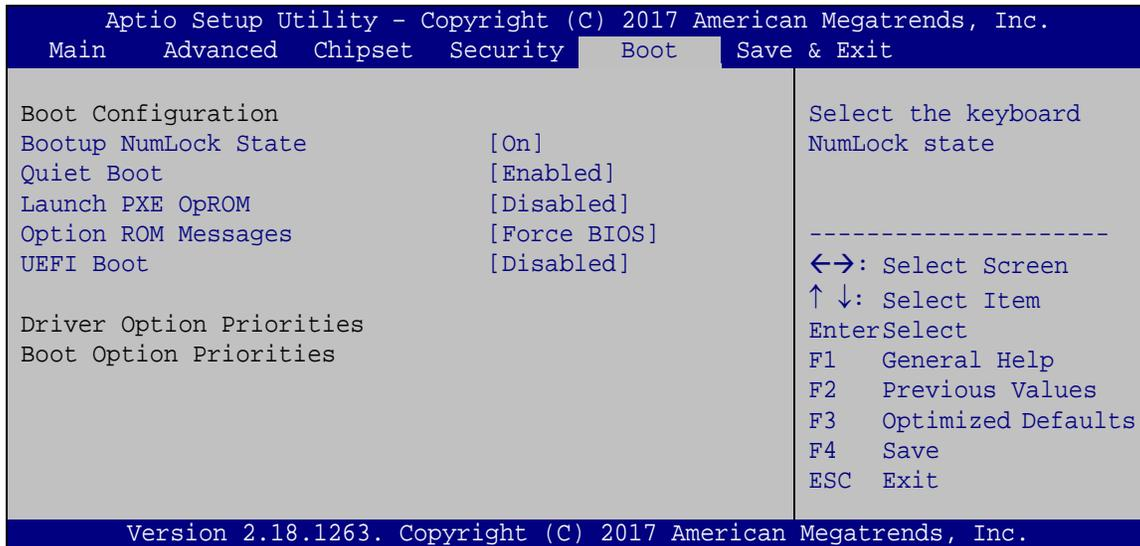

BIOS Menu 26: Boot

→ Bootup NumLock State [On]

Use the **Bootup NumLock State** BIOS option to specify if the number lock setting must be modified during boot up.

- **On** **DEFAULT** Allows the Number Lock on the keyboard to be enabled automatically when the computer system boots up. This allows the immediate use of the 10-key numeric keypad located on the right side of the keyboard. To confirm this, the Number Lock LED light on the keyboard is lit.

- **Off** Does not enable the keyboard Number Lock automatically. To use the 10-keys on the keyboard, press the Number Lock key located on the upper left-hand corner of the 10-key pad. The Number Lock LED on the keyboard lights up when the Number Lock is engaged.

WAFER-AL SBC

→ Quiet Boot [Enabled]

Use the **Quiet Boot** BIOS option to select the screen display when the system boots.

- **Disabled** Normal POST messages displayed
- **Enabled** **DEFAULT** OEM Logo displayed instead of POST messages

→ Launch PXE OpROM [Disabled]

Use the **Launch PXE OpROM** option to enable or disable boot option for legacy network devices.

- **Disabled** **DEFAULT** Ignore all PXE Option ROMs
- **Enabled** Load PXE Option ROMs.

→ Option ROM Messages [Force BIOS]

Use the **Option ROM Messages** option to set the Option ROM display mode.

- **Force BIOS** **DEFAULT** Sets display mode to force BIOS.
- **Keep Current** Sets display mode to current.

→ UEFI Boot [Disabled]

Use the **UEFI Boot** option to enable or disable to boot from the UEFI devices.

- **Enabled** Boot from UEFI devices is enabled.
- **Disabled** **DEFAULT** Boot from UEFI devices is disabled.

→ Boot Option Priority

Use the **Boot Option Priority** function to set the system boot sequence from the available devices. The drive sequence also depends on the boot sequence in the individual device section.

5.7 Save & Exit

Use the **Save & Exit** menu (**BIOS Menu 27**) to load default BIOS values, optimal failsafe values and to save configuration changes.

```
Aptio Setup Utility - Copyright (C) 2017 American Megatrends, Inc.
Main   Advanced  Chipset  Security  Boot   Save & Exit
-----
Save Changes and Reset
Discard Changes and Reset

Restore Defaults
Save as User Defaults
Restore User Defaults

Reset the system after
saving the changes.

-----
<=>: Select Screen
↑ ↓: Select Item
Enter>Select
F1   General Help
F2   Previous Values
F3   Optimized
Defaults
F4   Save
ESC  Exit

Version 2.18.1263. Copyright (C) 2017 American Megatrends, Inc.
```

BIOS Menu 27: Save & Exit

→ Save Changes and Reset

Use the **Save Changes and Reset** option to save the changes made to the BIOS options and to exit the BIOS configuration setup program.

→ Discard Changes and Reset

Use the **Discard Changes and Reset** option to exit the system without saving the changes made to the BIOS configuration setup program.

→ Restore Defaults

Use the **Restore Defaults** option to load the optimal default values for each of the parameters on the Setup menus. **F3 key can be used for this operation.**

WAFER-AL SBC

→ Save as User Defaults

Use the **Save as User Defaults** option to save the changes done so far as user defaults.

→ Restore User Defaults

Use the **Restore User Defaults** option to restore the user defaults to all the setup options.

Chapter

6

Software Drivers

WAFER-AL SBC

6.1 Available Drivers

All the drivers for the WAFER-AL are available on IEI Resource Download Center (<https://download.ieiworld.com>). Type WAFER-AL and press Enter to find all the relevant software, utilities, and documentation.



Figure 6-1: IEI Resource Download Center

IEI provides the following drivers for Windows 7, Windows 8 and Windows 10 operating systems.

- Chipset
- Graphics
- LAN
- Audio
- Serial I/O
- TXE

6.2 Driver Download

To download drivers from IEI Resource Download Center, follow the steps below.

Step 1: Go to <https://download.ieiworld.com>. Type WAFER-AL and press Enter.



Step 2: All product-related software, utilities, and documentation will be listed. You can choose **Driver** to filter the result.

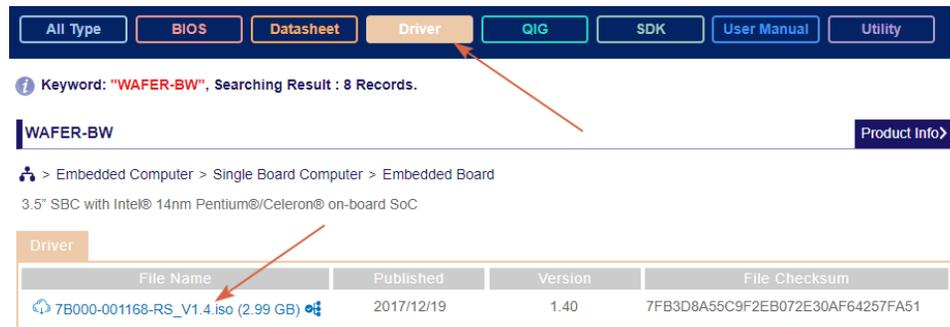

Step 3: Click the driver file name on the page and you will be prompted with the following window. You can download the entire ISO file (❶), or click the small arrow to find an individual driver and click the file name to download (❷).

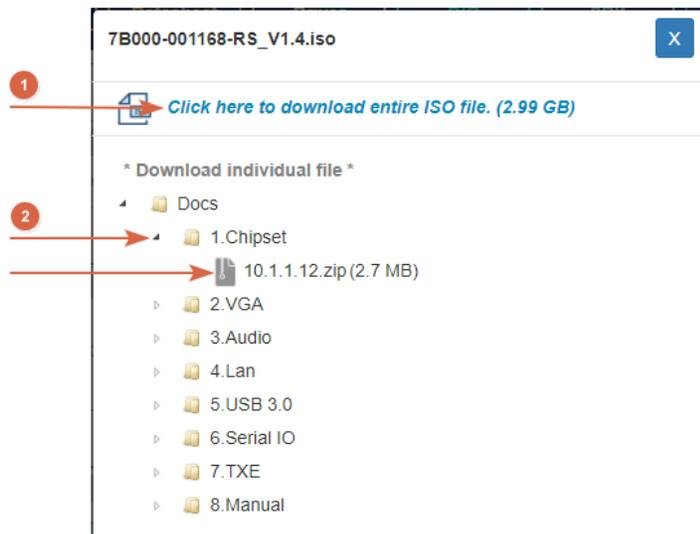

**NOTE:**

To install software from the downloaded ISO image file in Windows 8, 8.1 or 10, double-click the ISO file to mount it as a virtual drive to view its content. On Windows 7 system, an additional tool (such as Virtual CD-ROM Control Panel from Microsoft) is needed to mount the file.

**NOTE:**

The Intel TXE requires that Microsoft's "Kernel-Mode Driver Framework (KMDf) version 1.11 update for Windows 7" must be installed first on Windows 7 OS. If the KMDf is not installed, either error 37 or error 28 may appear on the Intel TXE device in Device Manager.

Please find the KMDf version 1.11 update for Windows 7 in the TXE driver folder in the driver CD or click the following link to download it.

<http://www.microsoft.com/en-us/download/details.aspx?id=38423>

Appendix

A

Regulatory Compliance

DECLARATION OF CONFORMITY



This equipment has been tested and found to comply with specifications for CE marking. If the user modifies and/or installs other devices in the equipment, the CE conformity declaration may no longer apply.

FCC WARNING



This equipment complies with Part 15 of the FCC Rules. Operation is subject to the following two conditions:

- This device may not cause harmful interference, and
- This device must accept any interference received, including interference that may cause undesired operation.

This equipment has been tested and found to comply with the limits for a Class A digital device, pursuant to part 15 of the FCC Rules. These limits are designed to provide reasonable protection against harmful interference when the equipment is operated in a commercial environment. This equipment generates, uses, and can radiate radio frequency energy and, if not installed and used in accordance with the instruction manual, may cause harmful interference to radio communications. Operation of this equipment in a residential area is likely to cause harmful interference in which case the user will be required to correct the interference at his own expense.

Appendix

B

Product Disposal

**CAUTION:**

Risk of explosion if battery is replaced by an incorrect type. Only certified engineers should replace the on-board battery.

Dispose of used batteries according to instructions and local regulations.

- Outside the European Union – If you wish to dispose of used electrical and electronic products outside the European Union, please contact your local authority so as to comply with the correct disposal method.
- Within the European Union – The device that produces less waste and is easier to recycle is classified as electronic device in terms of the European Directive 2012/19/EU (WEEE), and must not be disposed of as domestic garbage.

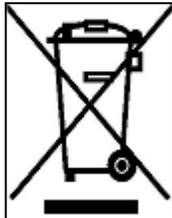

EU-wide legislation, as implemented in each Member State, requires that waste electrical and electronic products carrying the mark (left) must be disposed of separately from normal household waste. This includes monitors and electrical accessories, such as signal cables or power cords. When you need to dispose of your device, please follow the guidance of your local authority, or ask the shop where you purchased the product. The mark on electrical and electronic products only applies to the current European Union Member States.

Please follow the national guidelines for electrical and electronic product disposal.

Appendix

C

BIOS Menu Options

WAFER-AL SBC

<input type="checkbox"/>	System Date [xx/xx/xx].....	71
<input type="checkbox"/>	System Time [xx:xx:xx].....	72
<input type="checkbox"/>	Security Device Support [Disable].....	73
<input type="checkbox"/>	ACPI Sleep State [S3 (Suspend to RAM)].....	74
<input type="checkbox"/>	Serial Port [Enabled].....	76
<input type="checkbox"/>	Change Settings [IO=3F8h; IRQ=4].....	76
<input type="checkbox"/>	Transfer Mode [RS232].....	76
<input type="checkbox"/>	Serial Port [Enabled].....	77
<input type="checkbox"/>	Change Settings [IO=2F8h; IRQ=3].....	77
<input type="checkbox"/>	Transfer Mode [RS232].....	77
<input type="checkbox"/>	Serial Port [Enabled].....	78
<input type="checkbox"/>	Change Settings [IO=3E8h; IRQ=10].....	78
<input type="checkbox"/>	Serial Port [Enabled].....	79
<input type="checkbox"/>	Change Settings [IO=2E8h; IRQ=10].....	79
<input type="checkbox"/>	PC Health Status.....	80
<input type="checkbox"/>	CPU_FAN1 Smart Fan Control [Auto Duty-Cycle Mode].....	81
<input type="checkbox"/>	CPU Temperature 1.....	81
<input type="checkbox"/>	CPU Temperature 2.....	82
<input type="checkbox"/>	CPU Temperature 3.....	82
<input type="checkbox"/>	CPU Temperature 4.....	82
<input type="checkbox"/>	USB Devices.....	83
<input type="checkbox"/>	Legacy USB Support [Enabled].....	83
<input type="checkbox"/>	EIST [Enabled].....	84
<input type="checkbox"/>	C-States [Disabled].....	84
<input type="checkbox"/>	Intel Virtualization Technology [Disabled].....	85
<input type="checkbox"/>	VT-d [Disabled].....	85
<input type="checkbox"/>	Wake system with Fixed Time [Disabled].....	86
<input type="checkbox"/>	Power Saving Function(ERP) [Disabled].....	87
<input type="checkbox"/>	Console Redirection [Disabled].....	88
<input type="checkbox"/>	Legacy Serial Redirection Port [COM1].....	89
<input type="checkbox"/>	Auto Recovery Function [Disabled].....	90
<input type="checkbox"/>	Memory Information.....	92
<input type="checkbox"/>	Primary Display [IGD].....	93
<input type="checkbox"/>	Integrated Graphics Device [Enable].....	93

<input type="checkbox"/>	DVMT Pre-Allocated [256MB].....	93
<input type="checkbox"/>	DVMT Total Gfx Mem [MAX].....	94
<input type="checkbox"/>	Primary IGFX Boot Display [Auto]	94
<input type="checkbox"/>	Restore on AC Power Loss [Last State].....	95
<input type="checkbox"/>	HD-Audio Support [Enable]	96
<input type="checkbox"/>	Onboard LAN1/2 [Enable]	98
<input type="checkbox"/>	MINI-PCIE1/ MINI-PCIE2 [Enable]	99
<input type="checkbox"/>	PCIe Speed [Auto].....	99
<input type="checkbox"/>	STAT Controller [Enable]	100
<input type="checkbox"/>	SATA Mode Selection [AHCI].....	100
<input type="checkbox"/>	Hot Plug [Disabled].....	101
<input type="checkbox"/>	Administrator Password	101
<input type="checkbox"/>	User Password	101
<input type="checkbox"/>	Bootup NumLock State [On].....	102
<input type="checkbox"/>	Quiet Boot [Enabled]	103
<input type="checkbox"/>	Launch PXE OpROM [Disabled].....	103
<input type="checkbox"/>	Option ROM Messages [Force BIOS].....	103
<input type="checkbox"/>	UEFI Boot [Disabled]	103
<input type="checkbox"/>	Boot Option Priority.....	103
<input type="checkbox"/>	Save Changes and Reset	104
<input type="checkbox"/>	Discard Changes and Reset	104
<input type="checkbox"/>	Restore Defaults	104
<input type="checkbox"/>	Save as User Defaults	105
<input type="checkbox"/>	Restore User Defaults	105

Appendix

D

Digital I/O Interface

The DIO connector on the WAFER-AL is interfaced to GPIO ports on the Super I/O chipset. The DIO has both 8-bit digital inputs and 8-bit digital outputs. The digital inputs and digital outputs are generally control signals that control the on/off circuit of external devices or TTL devices. Data can be read or written to the selected address to enable the DIO functions.



NOTE:

For further information, please refer to the datasheet for the Super I/O chipset.

The BIOS interrupt call **INT 15H** controls the digital I/O.

INT 15H:

AH – 6FH	
<u>Sub-function:</u>	
AL – 8	: Set the digital port as INPUT
AL	: Digital I/O input value

Assembly Language Sample 1

```
MOV     AX, 6F08H      ; setting the digital port as input
INT     15H            ;
```

AL low byte = value

WAFER-AL SBC

AH – 6FH	
<u>Sub-function:</u>	
AL – 9	: Set the digital port as OUTPUT
BL	: Digital I/O output value

Assembly Language Sample 2

```
MOV    AX, 6F09H      ; setting the digital port as output  
MOV    BL, 09H        ; digital value is 09H  
INT    15H           ;
```

Digital Output is 1001b

Appendix

E

Watchdog Timer

WAFER-AL SBC



NOTE:

The following discussion applies to DOS. Contact IEI support or visit the IEI website for drivers for other operating systems.

The Watchdog Timer is a hardware-based timer that attempts to restart the system when it stops working. The system may stop working because of external EMI or software bugs. The Watchdog Timer ensures that standalone systems like ATMs will automatically attempt to restart in the case of system problems.

A BIOS function call (INT 15H) is used to control the Watchdog Timer.

INT 15H:

AH – 6FH Sub-function:	
AL – 2:	Sets the Watchdog Timer's period.
BL:	Time-out value (Its unit-second is dependent on the item "Watchdog Timer unit select" in CMOS setup).

Table E-1: AH-6FH Sub-function

Call sub-function 2 to set the time-out period of Watchdog Timer first. If the time-out value is not zero, the Watchdog Timer starts counting down. When the timer value reaches zero, the system resets. To ensure that this reset condition does not occur, calling sub-function 2 must periodically refresh the Watchdog Timer. However, the watchdog timer is disabled if the time-out value is set to zero.

A tolerance of at least 10% must be maintained to avoid unknown routines within the operating system (DOS), such as disk I/O that can be very time-consuming.

**NOTE:**

The Watchdog Timer is activated through software. The software application that activates the Watchdog Timer must also deactivate it when closed. If the Watchdog Timer is not deactivated, the system will automatically restart after the Timer has finished its countdown.

EXAMPLE PROGRAM:

```
; INITIAL TIMER PERIOD COUNTER
```

```
;
```

```
W_LOOP:
```

```
;
```

```
    MOV     AX, 6F02H      ;setting the time-out value  
    MOV     BL, 30        ;time-out value is 48 seconds  
    INT     15H
```

```
;
```

```
; ADD THE APPLICATION PROGRAM HERE
```

```
;
```

```
    CMP     EXIT_AP, 1    ;is the application over?  
    JNE     W_LOOP       ;No, restart the application
```

```
    MOV     AX, 6F02H    ;disable Watchdog Timer  
    MOV     BL, 0        ;  
    INT     15H
```

```
;
```

```
; EXIT ;
```

Appendix

F

Hazardous Materials Disclosure

The details provided in this appendix are to ensure that the product is compliant with the Peoples Republic of China (China) RoHS standards. The table below acknowledges the presences of small quantities of certain materials in the product, and is applicable to China RoHS only.

A label will be placed on each product to indicate the estimated “Environmentally Friendly Use Period” (EFUP). This is an estimate of the number of years that these substances would “not leak out or undergo abrupt change.” This product may contain replaceable sub-assemblies/components which have a shorter EFUP such as batteries and lamps. These components will be separately marked.

Please refer to the following table.

Part Name	Toxic or Hazardous Substances and Elements					
	Lead (Pb)	Mercury (Hg)	Cadmium (Cd)	Hexavalent Chromium (CR(VI))	Polybrominated Biphenyls (PBB)	Polybrominated Diphenyl Ethers (PBDE)
Housing	O	O	O	O	O	O
Display	O	O	O	O	O	O
Printed Circuit Board	O	O	O	O	O	O
Metal Fasteners	O	O	O	O	O	O
Cable Assembly	O	O	O	O	O	O
Fan Assembly	O	O	O	O	O	O
Power Supply Assemblies	O	O	O	O	O	O
Battery	O	O	O	O	O	O

O: This toxic or hazardous substance is contained in all of the homogeneous materials for the part is below the limit requirement in SJ/T11363-2006 (now replaced by GB/T 26572-2011).

X: This toxic or hazardous substance is contained in at least one of the homogeneous materials for this part is above the limit requirement in SJ/T11363-2006 (now replaced by GB/T 26572-2011).

WAFER-AL SBC

此附件旨在确保本产品符合中国 RoHS 标准。以下表格标示此产品中某有毒物质的含量符合中国 RoHS 标准规定的限量要求。

本产品上会附有“环境友好使用期限”的标签，此期限是估算这些物质“不会有泄漏或突变”的年限。本产品可能包含有较短的环境友好使用期限的可替换元件，像是电池或灯管，这些元件将会单独标示出来。

部件名称	有毒有害物质或元素					
	铅 (Pb)	汞 (Hg)	镉 (Cd)	六价铬 (CR(VI))	多溴联苯 (PBB)	多溴二苯 醚 (PBDE)
壳体	○	○	○	○	○	○
显示	○	○	○	○	○	○
印刷电路板	○	○	○	○	○	○
金属螺帽	○	○	○	○	○	○
电缆组装	○	○	○	○	○	○
风扇组装	○	○	○	○	○	○
电力供应组装	○	○	○	○	○	○
电池	○	○	○	○	○	○

○: 表示该有毒有害物质在该部件所有物质材料中的含量均在 SJ/T 11363-2006 (现由 GB/T 26572-2011 取代) 标准规定的限量要求以下。

X: 表示该有毒有害物质至少在该部件的某一均质材料中的含量超出 SJ/T 11363-2006 (现由 GB/T 26572-2011 取代) 标准规定的限量要求。