

MODEL:
WAFER-ULT3/ULT4

3.5" SBC with 6th/7th Generation Intel® Mobile Core™ i7/i5/i3 or Celeron® SoC, DDR4 SO-DIMM, Triple Display, Dual GbE, PCIe Mini, SATA 6Gb/s, USB 3.1 Gen1, COM and RoHS

User Manual

Revision

Date	Version	Changes
June 18, 2019	1.04	Clarified the LVDS connector pinouts (Section 3.2.9)
February 27, 2019	1.03	Corrected Table 4-4: LVDS Voltage Selection Jumper Settings
October 30, 2018	1.02	Modified Section 4.7: Motherboard Installation Modified the part number of the optional RS-232/422/485 cable.
May 24, 2018	1.01	Added a note for the LVDS connector (Section 3.2.9) Updated Section 4.11: Available Drivers
October 23, 2017	1.00	Initial release

Copyright

COPYRIGHT NOTICE

The information in this document is subject to change without prior notice in order to improve reliability, design and function and does not represent a commitment on the part of the manufacturer.

In no event will the manufacturer be liable for direct, indirect, special, incidental, or consequential damages arising out of the use or inability to use the product or documentation, even if advised of the possibility of such damages.

This document contains proprietary information protected by copyright. All rights are reserved. No part of this manual may be reproduced by any mechanical, electronic, or other means in any form without prior written permission of the manufacturer.

TRADEMARKS

All registered trademarks and product names mentioned herein are used for identification purposes only and may be trademarks and/or registered trademarks of their respective owners.

Manual Conventions



WARNING

Warnings appear where overlooked details may cause damage to the equipment or result in personal injury. Warnings should be taken seriously.



CAUTION

Cautionary messages should be heeded to help reduce the chance of losing data or damaging the product.



NOTE

These messages inform the reader of essential but non-critical information. These messages should be read carefully as any directions or instructions contained therein can help avoid making mistakes.

Table of Contents

1 INTRODUCTION.....	1
1.1 INTRODUCTION.....	2
1.2 MODEL VARIATIONS	3
1.3 FEATURES.....	3
1.4 CONNECTORS	4
1.5 DIMENSIONS.....	6
1.6 DATA FLOW	8
1.7 TECHNICAL SPECIFICATIONS	9
2 PACKING LIST.....	11
2.1 ANTI-STATIC PRECAUTIONS.....	12
2.2 UNPACKING PRECAUTIONS.....	12
2.3 PACKING LIST.....	13
2.4 OPTIONAL ITEMS.....	14
3 CONNECTORS	15
3.1 PERIPHERAL INTERFACE CONNECTORS.....	16
3.1.1 WAFER-ULT3/ULT4 Layout.....	16
3.1.2 Peripheral Interface Connectors	17
3.1.3 External Interface Panel Connectors.....	18
3.2 INTERNAL PERIPHERAL CONNECTORS	18
3.2.1 +12V Power Connector	18
3.2.2 5 V SATA Power Connector	20
3.2.3 Audio Connector	20
3.2.4 Battery Connector.....	21
3.2.5 CPU Fan Connector	23
3.2.6 Digital I/O Connector.....	24
3.2.7 Internal DisplayPort Connector	25
3.2.8 LVDS Backlight Control Connector.....	26
3.2.9 LVDS Connector	27

3.2.10 PCIe Mini Card Slot (with mSAT Support)	28
3.2.11 PCIe Mini Card Slot (with SIM Card Socket)	30
3.2.12 Power and HDD LED Connector	32
3.2.13 Power Button Connector	33
3.2.14 Reset Button Connector	34
3.2.15 RS-232/422/485 Serial Port Connectors	34
3.2.16 SATA 6Gb/s Connector	36
3.2.17 SIM Card Slot	37
3.2.18 SMBus Connector	38
3.2.19 SO-DIMM Slot	39
3.2.20 SPI Flash Connector	40
3.2.21 USB 2.0 Connector	41
3.3 EXTERNAL INTERFACE CONNECTORS	42
3.3.1 GbE Connectors	42
3.3.2 HDMI Connector	43
3.3.3 USB 3.1 Gen 1 Ports	44
3.3.4 VGA Connector	45
4 INSTALLATION	46
4.1 ANTI-STATIC PRECAUTIONS	47
4.2 INSTALLATION CONSIDERATIONS	47
4.3 SO-DIMM INSTALLATION	49
4.4 PCIe MINI CARD INSTALLATION	49
4.5 SIM CARD INSTALLATION	51
4.6 SYSTEM CONFIGURATION	53
4.6.1 AT/ATX Power Mode Selection	53
4.6.2 Clear CMOS Button	54
4.6.3 Flash Descriptor Security Override Jumper	54
4.6.4 LVDS Panel Type Selection	55
4.6.5 LVDS Voltage Selection	57
4.6.6 Serial Port Mode Selection Switch	58
4.6.7 VGA/iDP Selection Switch	59
4.7 MOTHERBOARD INSTALLATION	60
4.7.1 Heat Spreader	60
4.7.2 Motherboard Installation Example	61

WAFER-ULT3/ULT4 3.5" SBC

4.8 INTERNAL PERIPHERAL DEVICE CONNECTIONS.....	62
4.8.1 AT/ATX Power Connection.....	62
4.8.2 SATA Drive Connection.....	64
4.9 ADDING USB 3.1 GEN 1 DRIVERS TO A WINDOWS 7 INSTALLATION IMAGE (6TH GENERATION INTEL® MOBILE ULT ON-BOARD SOC ONLY).....	65
4.10 INTEL® AMT SETUP PROCEDURE.....	67
4.11 AVAILABLE DRIVERS.....	68
4.11.1 Driver Download.....	68
5 BIOS.....	70
5.1 INTRODUCTION.....	71
5.1.1 Starting Setup.....	71
5.1.2 Using Setup.....	71
5.1.3 Getting Help.....	72
5.1.4 Unable to Reboot after Configuration Changes.....	72
5.1.5 BIOS Menu Bar.....	72
5.2 MAIN.....	73
5.3 ADVANCED.....	74
5.3.1 CPU Configuration.....	75
5.3.2 PCH-FW Configuration.....	77
5.3.3 ACPI Settings.....	78
5.3.4 F81866 Super IO Configuration.....	79
5.3.4.1 Serial Port n Configuration.....	79
5.3.5 iWDD H/W Monitor.....	82
5.3.5.1 Smart Fan Mode Configuration.....	83
5.3.6 RTC Wake Settings.....	84
5.3.7 Serial Port Console Redirection.....	85
5.3.7.1 Console Redirection Settings.....	86
5.3.7.2 Legacy Console Redirection Settings.....	88
5.3.8 USB Configuration.....	89
5.3.9 iEi Feature.....	90
5.4 CHIPSET.....	91
5.4.1 System Agent (SA) Configuration.....	91
5.4.1.1 Memory Configuration.....	92
5.4.1.2 Graphics Configuration.....	93

5.4.2 PCH-IO Configuration	96
5.4.2.1 PCI Express Configuration	97
5.4.2.2 SATA Configuration.....	99
5.4.2.3 HD Audio Configuration.....	100
5.5 SECURITY.....	101
5.6 BOOT.....	102
5.7 SAVE & EXIT	104
A REGULATORY COMPLIANCE	105
B BIOS OPTIONS	107
C TERMINOLOGY	110
D DIGITAL I/O INTERFACE.....	114
D.1 INTRODUCTION.....	115
D.2 ASSEMBLY LANGUAGE SAMPLE 1.....	116
D.3 ASSEMBLY LANGUAGE SAMPLE 2.....	116
E WATCHDOG TIMER.....	117
F HAZARDOUS MATERIALS DISCLOSURE.....	120

List of Figures

Figure 1-1: WAFER-ULT3/ULT4.....	2
Figure 1-2: Connectors (Front Side).....	4
Figure 1-3: Connectors (Solder Side).....	5
Figure 1-4: WAFER-ULT3/ULT4 Dimensions (mm)	6
Figure 1-5: Dimensions with Optional Heatsink (mm).....	7
Figure 1-6: Data Flow Diagram.....	8
Figure 3-1: Peripheral Interface Connectors	16
Figure 3-2: Power Connector Location	19
Figure 3-3: 5 V SATA Power Connector Location	20
Figure 3-4: Audio Connector Location	21
Figure 3-5: Battery Connector Location.....	22
Figure 3-6: CPU Fan Connector Location	23
Figure 3-7: Digital I/O Connector Location	24
Figure 3-8: Internal DisplayPort Connector Location.....	25
Figure 3-9: LVDS Backlight Control Connector Location	26
Figure 3-10: LVDS Connector Location.....	27
Figure 3-11: PCIe Mini Card Slot (with mSATA Support) Location	29
Figure 3-12: PCIe Mini Card Slot (with SIM Card Socket) Location.....	31
Figure 3-13: Power and HDD LED Connector Location.....	32
Figure 3-14: Power Button Connector Location.....	33
Figure 3-15: Reset Button Connector Location.....	34
Figure 3-16: RS-232 Serial Port Connector Locations.....	35
Figure 3-17: SATA 6Gb/s Connector Location	36
Figure 3-18: SIM Card Slot Location.....	37
Figure 3-19: SMBus Connector Location	38
Figure 3-20: SO-DIMM Slot Location	39
Figure 3-21: SPI Flash Connector Location.....	40
Figure 3-22: USB 2.0 Connector Location	41
Figure 3-23: External Interface Connectors.....	42
Figure 3-24: LAN Connector.....	42

Figure 3-25: HDMI Connector Pinout Locations.....	43
Figure 3-26: USB 3.1 Gen 1 Port Pinout Locations	44
Figure 3-27: VGA Connector	45
Figure 4-1: SO-DIMM Installation	49
Figure 4-2: Removing the Retention Screw	50
Figure 4-3: Inserting the PCIe Mini Card into the Slot at an Angle.....	50
Figure 4-4: Securing the PCIe Mini Card	51
Figure 4-5: Unlock SIM Card Slot Cover	52
Figure 4-6: SIM Card Installation.....	52
Figure 4-7: Lock SIM Card Slot Cover	53
Figure 4-8: AT/ATX Power Mode Switch Location	53
Figure 4-9: Clear CMOS Button Location.....	54
Figure 4-10: Flash Descriptor Security Override Jumper Location	55
Figure 4-11: LVDS Panel Type Selection Switch Location.....	56
Figure 4-12: LVDS Voltage Selection Jumper Location	57
Figure 4-13: Serial Port Mode Selection Switch Location	58
Figure 4-14: VGA/iDP Selection Switch Location.....	59
Figure 4-15: Heat Spreader Retention Screws	61
Figure 4-16: Motherboard Installation Example	61
Figure 4-17: Power Cable to Motherboard Connection	62
Figure 4-18: Connect Power Cable to Power Supply.....	63
Figure 4-19: SATA Drive Cable Connection.....	64
Figure 4-20: Windows 7 USB 3.0 Creator Utility.....	66
Figure 4-21: Update Process is Complete	66
Figure 4-22: IEI Resource Download Center.....	68

List of Tables

Table 1-1: Model Variations	3
Table 1-2: WAFER-ULT3/ULT4 Specifications	10
Table 2-1: Packing List.....	13
Table 2-2: Optional Items	14
Table 3-1: Peripheral Interface Connectors	17
Table 3-2: External Peripheral Connectors	18
Table 3-3: Power Connector Pinouts.....	19
Table 3-4: 5 V SATA Power Connector Pinouts	20
Table 3-5: Audio Connector Pinouts	21
Table 3-6: Battery Connector Pinouts	22
Table 3-7: CPU Fan Connector Pinouts.....	23
Table 3-8: Digital I/O Connector Pinouts.....	24
Table 3-9: Internal DisplayPort Connector Pinouts	26
Table 3-10: LVDS Backlight Control Connector Pinouts.....	27
Table 3-11: LVDS Connector Pinouts	28
Table 3-12: PCIe Mini Card Slot (with mSATA Support) Pinouts.....	30
Table 3-13: PCIe Mini Card Slot (with SIM Card Socket) Pinouts	32
Table 3-14: Power and HDD LED Connector Pinouts	33
Table 3-15: Power Button Connector Pinouts	33
Table 3-16: Reset Button Connector Pinouts	34
Table 3-17: RS-232/422/485 Serial Port Connector Pinouts	35
Table 3-18: DB-9 RS-232/422/485 Pinouts	36
Table 3-19: SATA 6Gb/s Drive Connector Pinouts.....	37
Table 3-20: SMBus Connector Pinouts	38
Table 3-21: SPI Flash Connector Pinouts	40
Table 3-22: USB 2.0 Connector Pinouts.....	41
Table 3-23: LAN Pinouts	43
Table 3-24: HDMI Connector Pinouts	43
Table 3-25: USB 3.1 Gen 1 Port Pinouts.....	44
Table 3-26: VGA Connector Pinouts.....	45

Table 4-1: AT/ATX Power Mode Switch Settings.....	53
Table 4-2: Flash Descriptor Security Override Jumper Settings.....	54
Table 4-3: LVDS Panel Type Selection.....	56
Table 4-4: LVDS Voltage Selection Jumper Settings.....	57
Table 4-5: Signal Mode Settings for Serial Port 1.....	58
Table 4-6: Signal Mode Settings for Serial Port 2.....	58
Table 4-7: VGA/iDP Selection Switch Settings.....	59
Table 5-1: BIOS Navigation Keys.....	72

BIOS Menus

BIOS Menu 1: Main	73
BIOS Menu 2: Advanced	74
BIOS Menu 3: CPU Configuration	75
BIOS Menu 4: PCH-FW Configuration	77
BIOS Menu 5: ACPI Settings	78
BIOS Menu 6: F81866 Super IO Configuration	79
BIOS Menu 7: Serial Port n Configuration Menu	79
BIOS Menu 8: iWDD H/W Monitor	82
BIOS Menu 9: Smart Fan Mode Configuration	83
BIOS Menu 10: RTC Wake Settings	84
BIOS Menu 11: Serial Port Console Redirection	85
BIOS Menu 12: Console Redirection Settings	86
BIOS Menu 13: Legacy Console Redirection Settings	88
BIOS Menu 14: USB Configuration	89
BIOS Menu 15: iEi Feature	90
BIOS Menu 16: Chipset	91
BIOS Menu 17: System Agent (SA) Configuration	91
BIOS Menu 18: Memory Configuration	92
BIOS Menu 19: Graphics Configuration	93
BIOS Menu 20: LCD Control	95
BIOS Menu 21: PCH-IO Configuration	96
BIOS Menu 22: PCI Express Configuration	97
BIOS Menu 23: M_PCIE2 Configuration Menu	98
BIOS Menu 24: SATA Configuration	99
BIOS Menu 25: PCH Azalia Configuration	100
BIOS Menu 26: Security	101
BIOS Menu 27: Boot	102
BIOS Menu 28: Save & Exit	104

Chapter

1

Introduction

1.1 Introduction



Figure 1-1: WAFER-ULT3/ULT4

The WAFER-ULT3/ULT4 3.5" SBC is a 6th/7th generation Intel® mobile ULT SoC platform that supports one 2133 MHz DDR4 SO-DIMM and on-board memory (optional, by request). The WAFER-ULT3/ULT4 provides two GbE interfaces through the Intel® I219LM (with Intel® AMT 11.0 support) and the Intel® I211AT GbE controllers. In addition, the WAFER-ULT3/ULT4 includes HDMI, VGA, LVDS and iDP interfaces for triple independent display. Four USB 3.1 Gen 1 on the rear panel, two USB 2.0 by pin header, two RS-232/422/485, two PCIe Mini card slots, one SATA 6Gb/s and one audio connector provide flexible expansion options.

WAFER-ULT3/ULT4 3.5" SBC

1.2 Model Variations

The model variations of the WAFER-ULT3/ULT4 are listed below.

Model	On-board SoC
7th Generation Intel® Mobile ULT On-board SoC	
WAFER-ULT4-i7 (MOQ: 100 pcs/lot)	Intel® Core™ i7-7600U (up to 3.9 GHz, dual-core, 4 MB cache, TDP=15W)
WAFER-ULT4-i5	Intel® Core™ i5-7300U (up to 3.5 GHz, dual-core, 3 MB cache, TDP=15W)
WAFER-ULT4-i3 (MOQ: 100 pcs/lot)	Intel® Core™ i3-7100U (up to 2.4 GHz, dual-core, 3 MB cache, TDP=15W)
6th Generation Intel® Mobile ULT On-board SoC	
WAFER-ULT3-i7	Intel® Core™ i7-6600U (up to 3.4 GHz, dual-core, 4 MB cache, TDP=15W)
WAFER-ULT3-i5	Intel® Core™ i5-6300U (up to 3 GHz, dual-core, 3 MB cache, TDP=15W)
WAFER-ULT3-i3	Intel® Core™ i3-6100U (up to 2.3 GHz, dual-core, 3 MB cache, TDP=15W)
WAFER-ULT3-C	Intel® Celeron® 3955U (up to 2 GHz, dual-core, 2 MB cache, TDP=15W)
WAFER-ULT3-CE	Intel® Celeron® 3855U (up to 1.6 GHz, dual-core, 2 MB cache, TDP=15W)

Table 1-1: Model Variations

1.3 Features

Some of the WAFER-ULT3/ULT4 motherboard features are listed below:

- 3.5" form factor
- 6th/7th generation Intel® mobile ULT SoC
- One 260-pin 2133 MHz DDR4 SO-DIMM slot support (on-board memory supported, by request)
- Triple display with selection of HDMI, VGA, iDP and LVDS
- Two Intel® GbE connectors (LAN1 with Intel® AMT 11.0 support)
- Two PCIe Mini card slots with SIM card socket/mSATA support
- Four USB 3.1 Gen 1 (5 Gb/s) external connectors
- IEI One Key Recovery solution allows you to create rapid OS backup and recovery

1.4 Connectors

The connectors on the WAFER-ULT3/ULT4 are shown in the figure below.

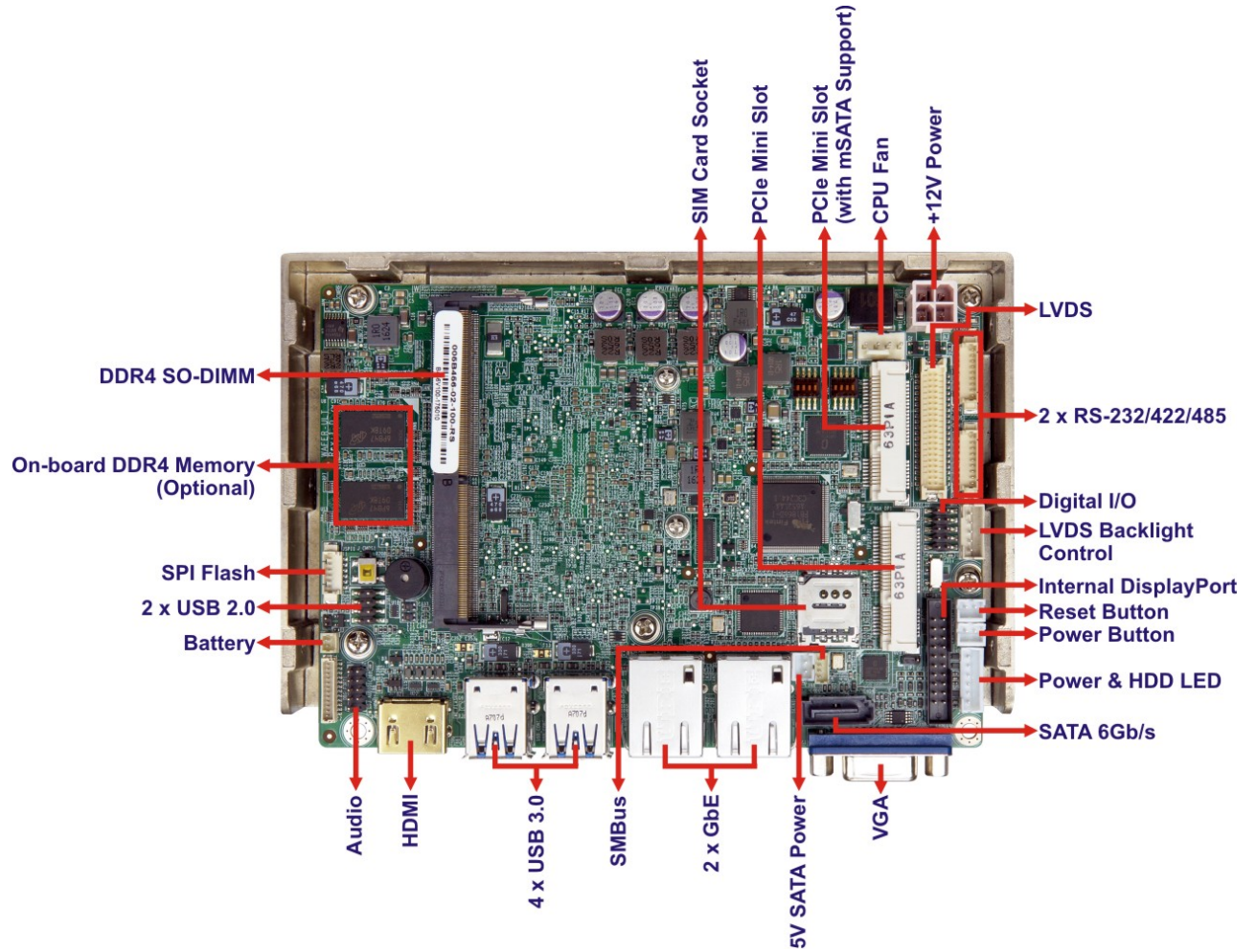

Figure 1-2: Connectors (Front Side)

WAFER-ULT3/ULT4 3.5" SBC

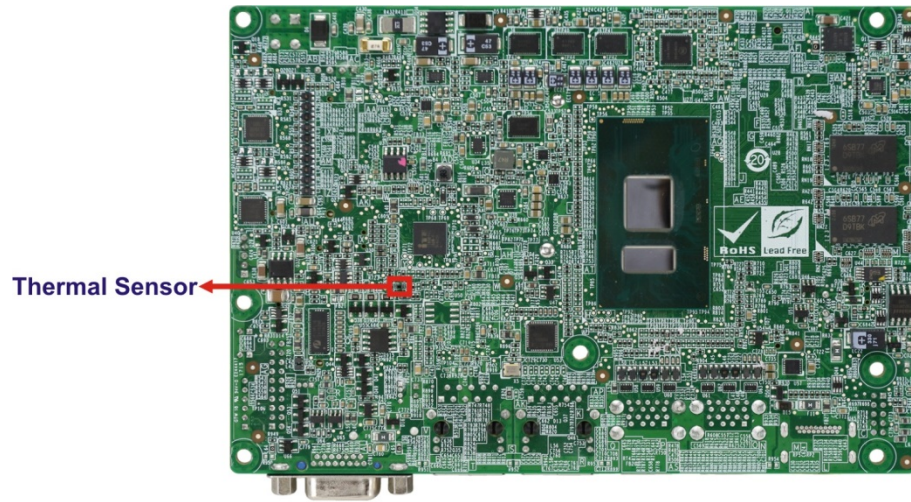

Figure 1-3: Connectors (Solder Side)

1.5 Dimensions

The main dimensions of the WAFER-ULT3/ULT4 are shown in the diagram below.

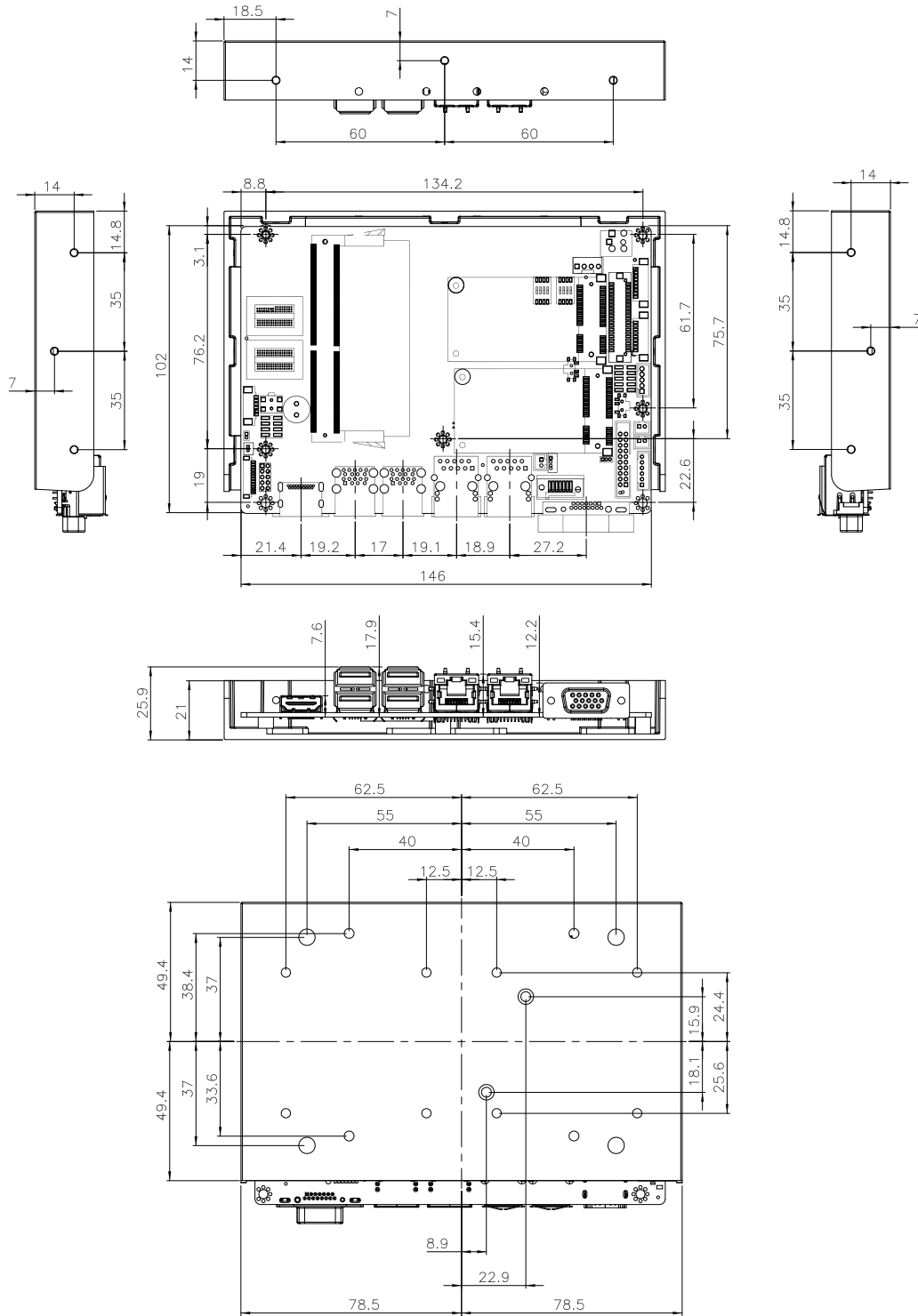

Figure 1-4: WAFER-ULT3/ULT4 Dimensions (mm)

WAFER-ULT3/ULT4 3.5" SBC

Figure 1-5 shows the dimensions of the WAFER-ULT3/ULT4 installed with the optional heatsink (P/N: 34000-000673-RS).

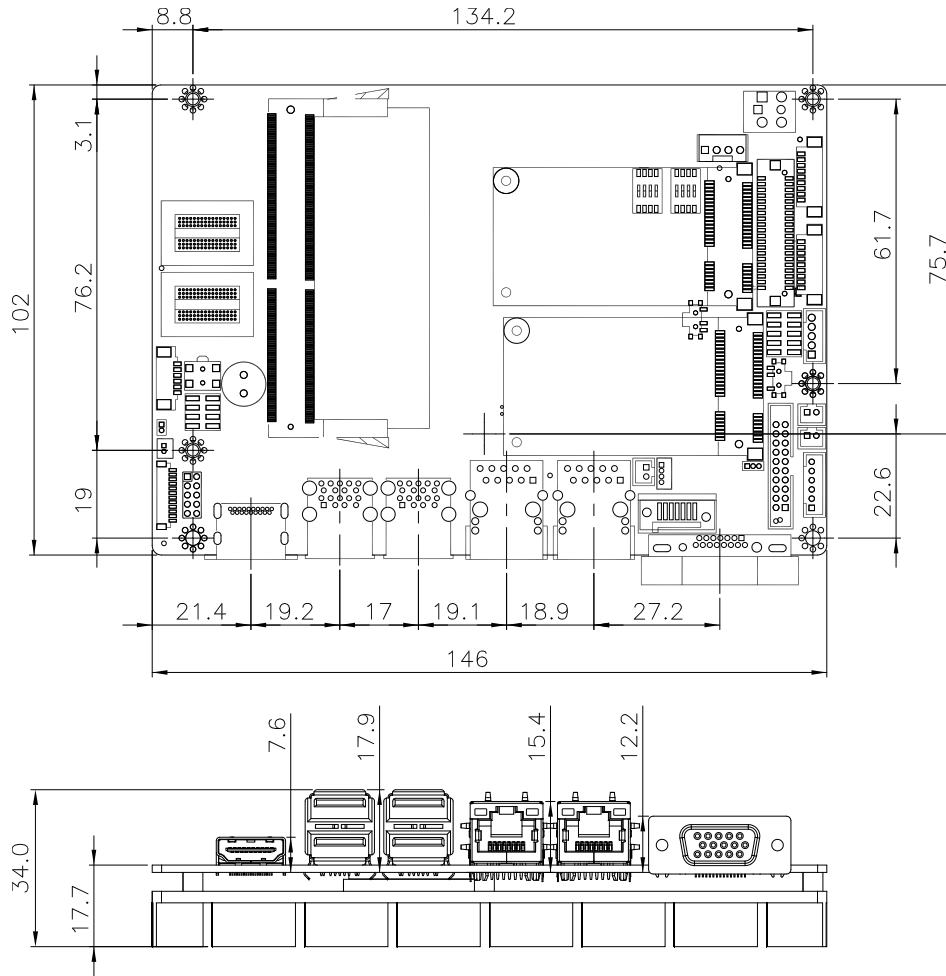

Figure 1-5: Dimensions with Optional Heatsink (mm)

1.6 Data Flow

Figure 1-6 shows the data flow between the system chipset, the CPU and other components installed on the motherboard.

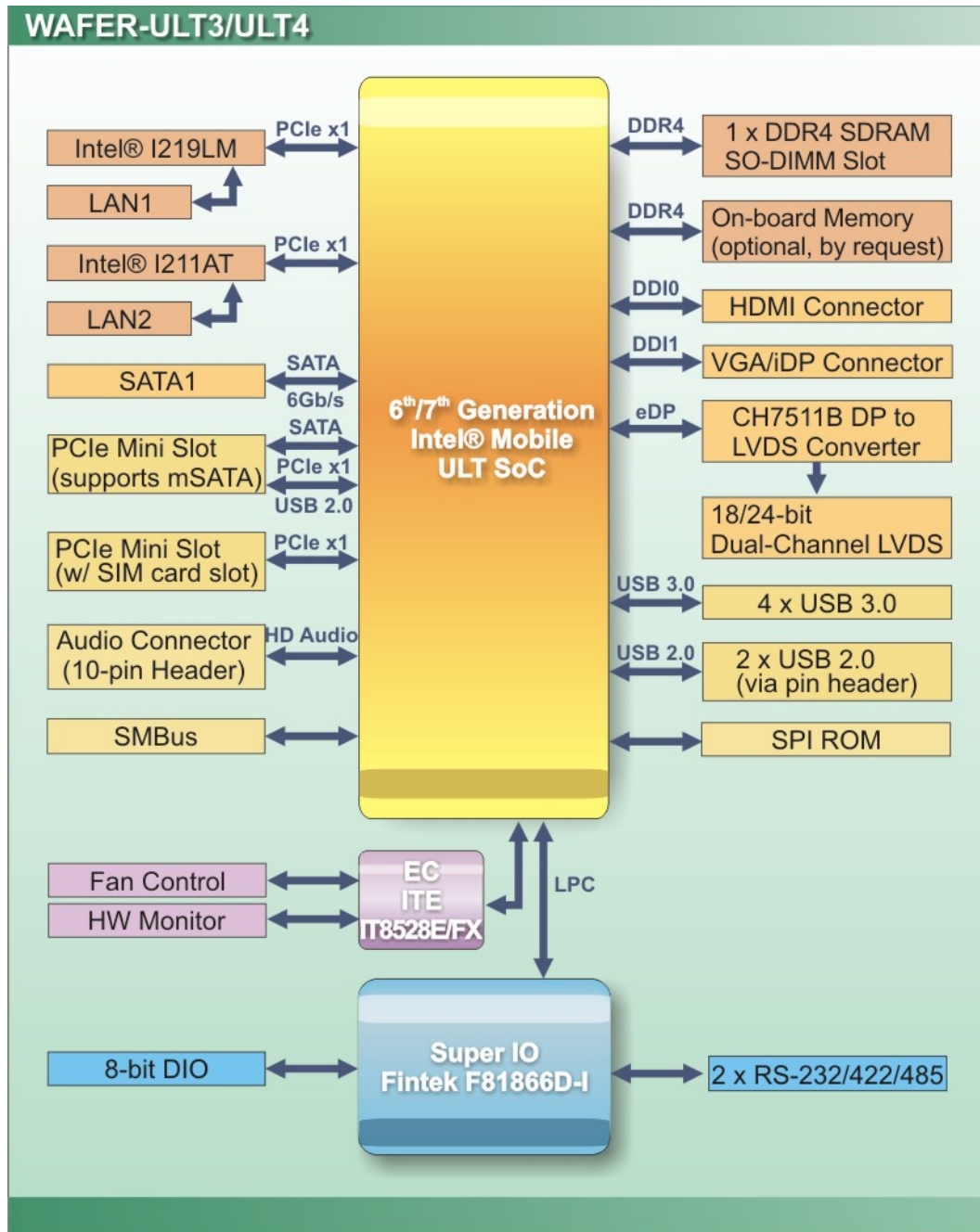

Figure 1-6: Data Flow Diagram

WAFER-ULT3/ULT4 3.5" SBC

1.7 Technical Specifications

The WAFER-ULT3/ULT4 technical specifications are listed below.

Specifications	WAFER-ULT3/ULT4
Form Factor	3.5"
SoC	<p>7th generation Intel® mobile ULT on-board SoC:</p> <p>Intel® Core™ i7-7600U (up to 3.9 GHz, dual-core, 4 MB cache, TDP=15W) Intel® Core™ i5-7300U (up to 3.5 GHz, dual-core, 3 MB cache, TDP=15W) Intel® Core™ i3-7100U (up to 2.4 GHz, dual-core, 3 MB cache, TDP=15W)</p> <p>6th generation Intel® mobile ULT on-board SoC:</p> <p>Intel® Core™ i7-6600U (up to 3.4 GHz, dual-core, 4 MB cache, TDP=15W) Intel® Core™ i5-6300U (up to 3 GHz, dual-core, 3 MB cache, TDP=15W) Intel® Core™ i3-6100U (up to 2.3 GHz, dual-core, 3 MB cache, TDP=15W) Intel® Celeron® 3955U (up to 2 GHz, dual-core, 2 MB cache, TDP=15W) Intel® Celeron® 3855U (up to 1.6 GHz, dual-core, 2 MB cache, TDP=15W)</p>
Memory	<p>One 260-pin 2133 MHz DDR4 SDRAM SO-DIMM slot (channel 1)</p> <p>On-board 4 GB/8 GB DDR4 memory (channel 2, optional support by request)</p>
Graphics Engine	Intel® HD Graphics
Display Output	<p>Triple independent display support</p> <p>One VGA (up to 1920x1200@60 Hz)</p> <p>One HDMI (up to 4096x2160@30 Hz)</p> <p>One 18/24-bit dual-channel LVDS (up to 1920x1200@60 Hz)</p> <p>One iDP interface for HDMI, LVDS, VGA, DVI and DisplayPort (co-layout with VGA)</p>
Ethernet	<p>LAN1: Intel® I219LM PHY with Intel® AMT 11.0 support</p> <p>LAN2: Intel® I211AT GbE controller</p>
Super I/O Controller	Fintek F81866D-I
Watchdog Timer	Software programmable, supports 1~255 sec. system reset
BIOS	AMI UEFI BIOS

Specifications	WAFER-ULT3/ULT4
Expansions	One full-size PCIe Mini card slot (with SATA signal, supports mSATA) One full-size PCIe Mini card slot (with SIM card socket) <i>*3855U SoC belongs to Skylake ULT Base series which supports PCIe Gen 2 signal only.</i>
Audio	One audio connector (10-pin header, supports 7.1-channel HD audio by IEI AC-KIT-892HD kit)
Digital I/O	8-bit digital I/O (10-pin header)
Fan Connector	One CPU fan connector (4-pin wafer)
Front Panel	One power & HDD LED connector (6-pin wafer) One power button connector (2-pin wafer) One reset button connector (2-pin wafer)
Serial ATA	One SATA 6Gb/s connector One 5V SATA power connector
Serial Ports	Two RS-232/422/485 serial ports via internal 9-pin wafer connectors
SMBus	One 4-pin wafer connector
USB	Four USB 3.1 Gen 1 (5 Gb/s) ports on rear panel Two USB 2.0 ports by pin header
Power Supply	12V only DC input One Internal 4-pin (2x2) power connector
Power Consumption	+12V@4.28A (Intel® Core™ i7-6600U SoC with one 16 GB 2133 MHz DDR4 SO-DIMM, running in 3 GHz)
Operating Temperature	-20°C ~ 60°C
Storage Temperature	-20°C ~ 60°C
Operating Humidity	5% ~ 95% (non-condensing)
Dimensions	146 mm x 102 mm
Weight (GW/NW)	600 g/250 g

Table 1-2: WAFER-ULT3/ULT4 Specifications

Chapter

2

Packing List

2.1 Anti-static Precautions



WARNING!

Static electricity can destroy certain electronics. Make sure to follow the ESD precautions to prevent damage to the product, and injury to the user.

Make sure to adhere to the following guidelines:

- **Wear an anti-static wristband:** Wearing an anti-static wristband can prevent electrostatic discharge.
- **Self-grounding:** Touch a grounded conductor every few minutes to discharge any excess static buildup.
- **Use an anti-static pad:** When configuring any circuit board, place it on an anti-static mat.
- **Only handle the edges of the PCB:** Don't touch the surface of the motherboard. Hold the motherboard by the edges when handling.

2.2 Unpacking Precautions

When the WAFER-ULT3/ULT4 is unpacked, please do the following:

- Follow the anti-static guidelines above.
- Make sure the packing box is facing upwards when opening.
- Make sure all the packing list items are present.

WAFER-ULT3/ULT4 3.5" SBC

2.3 Packing List



NOTE:

If any of the components listed in the checklist below are missing, do not proceed with the installation. Contact the IEI reseller or vendor the WAFER-ULT3/ULT4 was purchased from or contact an IEI sales representative directly by sending an email to sales@ieiworld.com.

The WAFER-ULT3/ULT4 is shipped with the following components:





Quantity	Item and Part Number	Image
1	WAFER-ULT3/ULT4 SBC with heat spreader	
1	SATA signal and power cable	
1	Power cable	
1	RS-232/422/485 cable	
1	Quick installation guide	

Table 2-1: Packing List

2.4 Optional Items

These optional items are available.



Item and Part Number	Image
RS-232/422/485 cable (250 mm, P=1.25) (P/N: 32005-003500-200-RS)	
Dual-port USB 2.0 cable, 210 mm, p=2.00 mm (P/N: 32001-008600-200-RS)	
Heatsink for WAFER-ULT3/ULT4, 146 mm x 102 mm x 14.6 mm (P/N: 34000-000673-RS)	

Table 2-2: Optional Items

Chapter

3

Connectors

3.1 Peripheral Interface Connectors

This chapter details all the peripheral interface connectors.

3.1.1 WAFER-ULT3/ULT4 Layout

The figure below shows all the peripheral interface connectors.

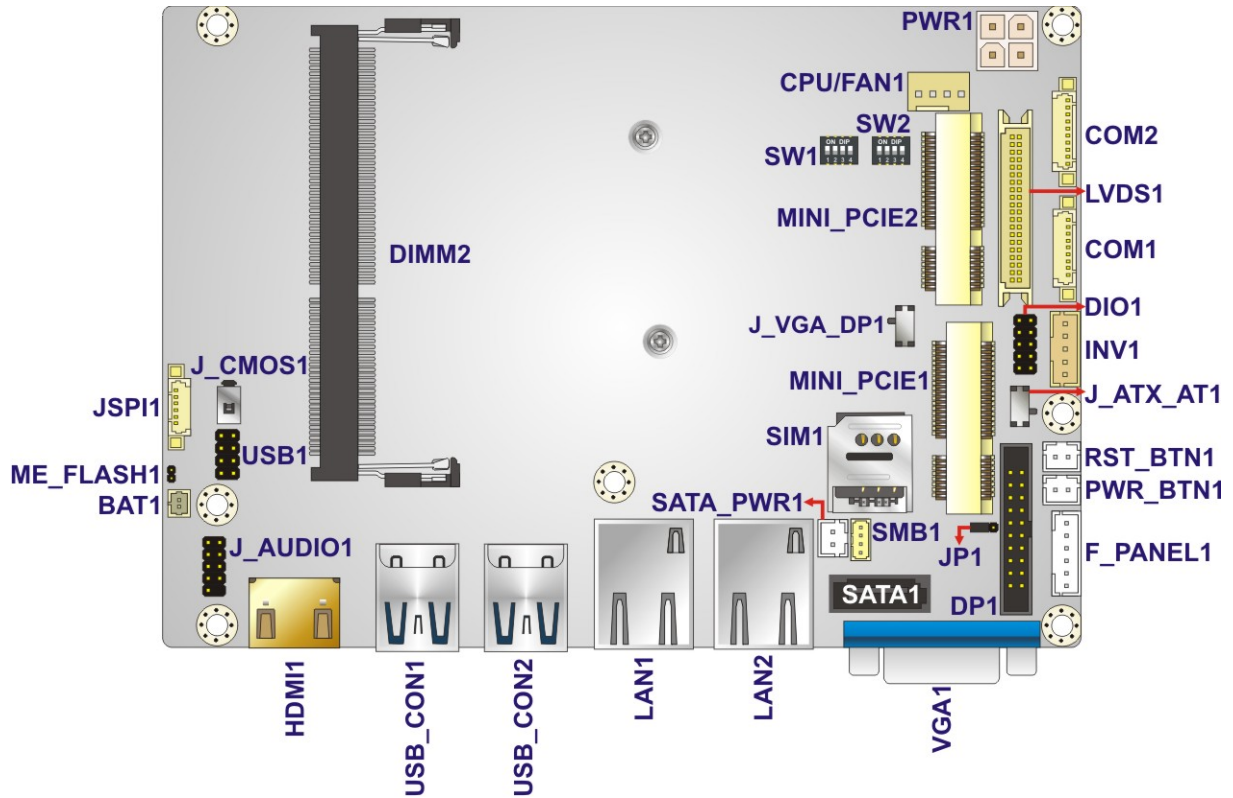

Figure 3-1: Peripheral Interface Connectors

WAFER-ULT3/ULT4 3.5" SBC

3.1.2 Peripheral Interface Connectors

The table below lists all the connectors on the board.

Connector	Type	Label
+12V power connector	4-pin Molex power connector	PWR1
5 V SATA power connector	2-pin wafer	SATA_PWR1
Audio connector	10-pin header	J_AUDIO1
Battery connector	2-pin wafer	BAT1
CPU fan connector	4-pin wafer	CPU/FAN1
Digital I/O connector	10-pin header	DIO1
Internal DisplayPort connector	20-pin box header	DP1
LVDS backlight control connector	5-pin wafer	INV1
LVDS connector	40-pin crimp	LVDS1
PCIe Mini card slots	PCIe Mini card slot	MINI_PCIE1, MINI_PCIE2
Power and HDD LED connector	6-pin wafer	F_PANEL1
Power button connector	2-pin wafer	PWR_BTN1
Reset button connector	2-pin wafer	RST_BTN1
SATA 6Gb/s connector	7-pin SATA connector	SATA1
RS-232/422/485 serial ports	9-pin wafer	COM1, COM2
SIM card slot	Micro SIM card slot	SIM1
SMBus connector	4-pin wafer	SMB1
SO-DIMM slot	260-pin DDR4 SO-DIMM slot	DIMM2
SPI flash connector	6-pin wafer	JSPI1
USB 2.0 connector	8-pin header	USB1

Table 3-1: Peripheral Interface Connectors

3.1.3 External Interface Panel Connectors

The table below lists the connectors on the external I/O panel.

Connector	Type	Label
GbE connectors	RJ-45	LAN1, LAN2
HDMI connector	HDMI	HDMI1
USB 3.1 Gen 1 connectors	Dual USB 3.1 Gen 1 port	USB_CON1, USB_CON2
VGA connector	15-pin female	VGA1

Table 3-2: External Peripheral Connectors

3.2 Internal Peripheral Connectors

Internal peripheral connectors are found on the motherboard and are only accessible when the motherboard is outside of the chassis. This section has complete descriptions of all the internal peripheral connectors on the WAFER-ULT3/ULT4.

3.2.1 +12V Power Connector

- CN Label:** PWR1
- CN Type:** 4-pin Molex power connector, p=4.2 mm
- CN Location:** See **Figure 3-2**
- CN Pinouts:** See **Table 3-3**

The power connector is connected to an external power supply and supports +12V power input. Power is provided to the system, from the power supply through this connector.

WAFER-ULT3/ULT4 3.5" SBC

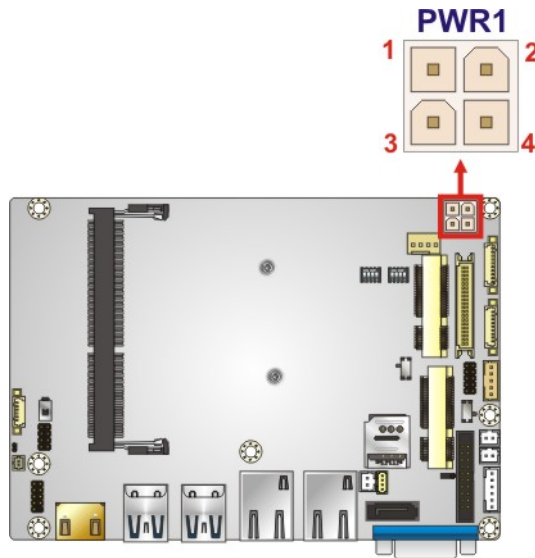

Figure 3-2: Power Connector Location

Pin	Description	Pin	Description
1	GND	2	GND
3	+12V	4	+12V

Table 3-3: Power Connector Pinouts

3.2.2 5 V SATA Power Connector

- CN Label:** SATA_PWR1
- CN Type:** 2-pin wafer, p=2 mm
- CN Location:** See **Figure 3-3**
- CN Pinouts:** See **Table 3-4**

Use the 5 V SATA power connector to connect to SATA device power connection.

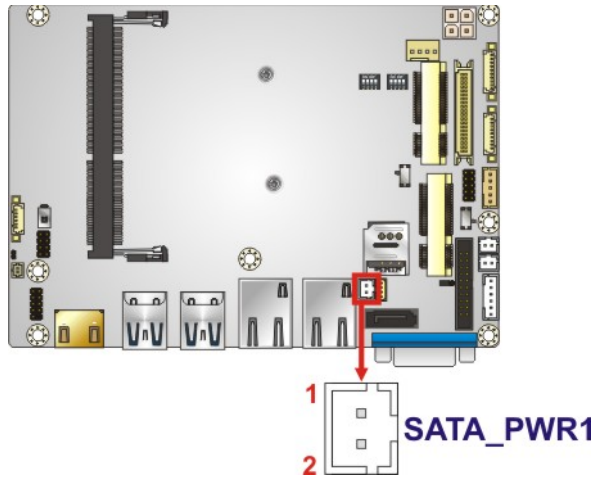

Figure 3-3: 5 V SATA Power Connector Location

Pin	Description
1	+5V
2	GND

Table 3-4: 5 V SATA Power Connector Pinouts

3.2.3 Audio Connector

- CN Label:** J_AUDIO1
- CN Type:** 10-pin header, p=2 mm
- CN Location:** See **Figure 3-4**
- CN Pinouts:** See **Table 3-5**

WAFER-ULT3/ULT4 3.5" SBC

The audio connector is connected to external audio devices including speakers and microphones for the input and output of audio signals to and from the system.

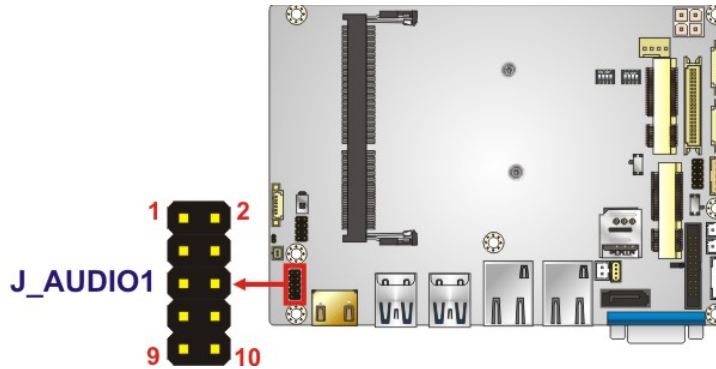

Figure 3-4: Audio Connector Location

Pin	Description	Pin	Description
1	HDA_SYNC	2	HDA_CLK
3	HDA_SDO	4	HDA_BEEP
5	HDA_SDI	6	HDA_RESET
7	+5V	8	AUD_GND
9	+12V	10	AUD_GND

Table 3-5: Audio Connector Pinouts

3.2.4 Battery Connector



CAUTION:

Risk of explosion if battery is replaced by an incorrect type. Only certified engineers should replace the on-board battery.

Dispose of used batteries according to instructions and local regulations.



NOTE:

It is recommended to attach the RTC battery onto the system chassis in which the WAFER-ULT3/ULT4 is installed.

- CN Label:** **BAT1**
- CN Type:** 2-pin wafer, p=1.25 mm
- CN Location:** See **Figure 3-5**
- CN Pinouts:** See **Table 3-6**

This is connected to the system battery. The battery provides power to the system clock to retain the time when power is turned off.

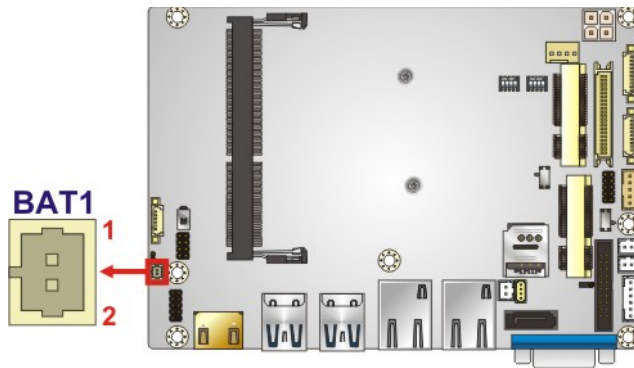

Figure 3-5: Battery Connector Location

Pin	Description
1	VBATT
2	GND

Table 3-6: Battery Connector Pinouts

WAFER-ULT3/ULT4 3.5" SBC

3.2.5 CPU Fan Connector

- CN Label:** CPU/FAN1
- CN Type:** 4-pin wafer, p=2.54 mm
- CN Location:** See **Figure 3-6**
- CN Pinouts:** See **Table 3-7**

The fan connector attaches to a system cooling fan.

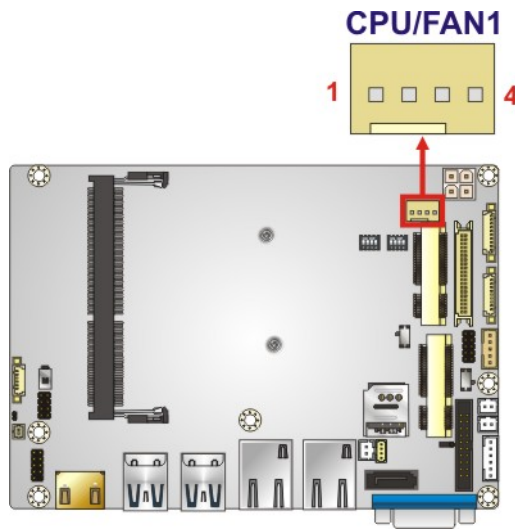

Figure 3-6: CPU Fan Connector Location

Pin	Description
1	GND
2	+12V
3	Rotation signal
4	PWM control signal

Table 3-7: CPU Fan Connector Pinouts

3.2.6 Digital I/O Connector

- CN Label:** DIO1
- CN Type:** 10-pin header, p=2 mm
- CN Location:** See **Figure 3-7**
- CN Pinouts:** See **Table 3-8**

The digital I/O connector provides programmable input and output for external devices. The digital I/O provides 4-bit output and 4-bit input.

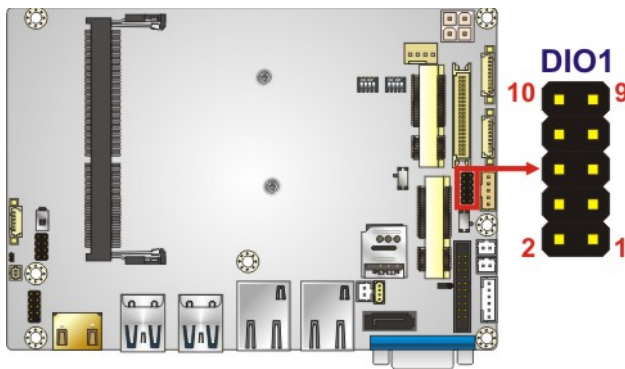

Figure 3-7: Digital I/O Connector Location

Pin	Description	Pin	Description
1	GND	2	VCC
3	Output 3	4	Output 2
5	Output 1	6	Output 0
7	Input 3	8	Input 2
9	Input 1	10	Input 0

Table 3-8: Digital I/O Connector Pinouts

WAFER-ULT3/ULT4 3.5" SBC

3.2.7 Internal DisplayPort Connector



NOTE:

The user can select either to use the VGA connector or the internal DisplayPort connector. Use the VGA/iDP selection switch to configure the settings. Please refer to **Section 4.6.7** for detailed information.

CN Label:	DP1
CN Type:	20-pin box header, p=2 mm
CN Location:	See Figure 3-8
CN Pinouts:	See Table 3-9

The DisplayPort connector supports HDMI, LVDS, VGA, DVI and DisplayPort graphics interfaces.

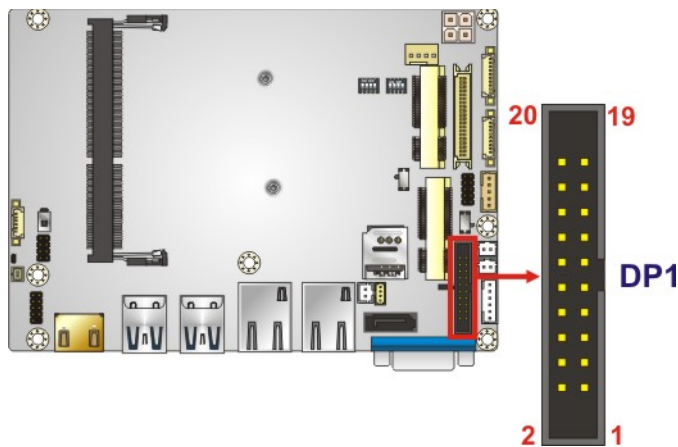

Figure 3-8: Internal DisplayPort Connector Location

Pin	Description	Pin	Description
1	HPD	2	AUX_P
3	GND	4	AUX_N
5	NC	6	GND
7	GND	8	LANE2P
9	LANE3P	10	LANE2N
11	LANE3N	12	GND
13	GND	14	LANE0P
15	LANE1P	16	LANE0N
17	LANE1N	18	VCC3V
19	VCC5V	20	NC

Table 3-9: Internal DisplayPort Connector Pinouts

3.2.8 LVDS Backlight Control Connector

- CN Label:** INV1
- CN Type:** 5-pin wafer, p=2 mm
- CN Location:** See Figure 3-9
- CN Pinouts:** See Table 3-10

The backlight control connector provides the backlight on the LCD display connected to the WAFER-ULT3/ULT4 with +12V of power.

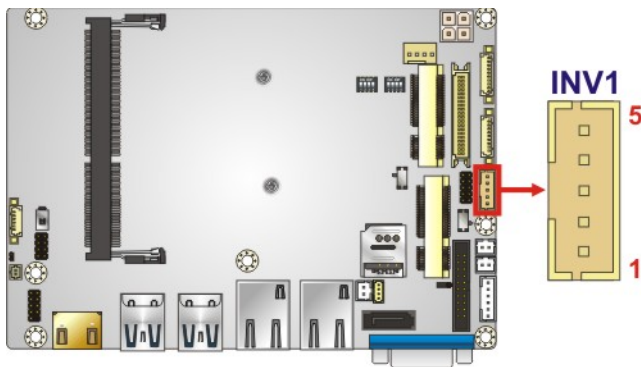

Figure 3-9: LVDS Backlight Control Connector Location

WAFER-ULT3/ULT4 3.5" SBC

Pin	Description
1	LCD_BKLTCTL
2	GROUND
3	+12V
4	GROUND
5	BACKLIGHT ENABLE

Table 3-10: LVDS Backlight Control Connector Pinouts

3.2.9 LVDS Connector

- CN Label:** LVDS1
- CN Type:** 40-pin crimp, p=1.25 mm
- CN Location:** See **Figure 3-10**
- CN Pinouts:** See **Table 3-11**

The LVDS LCD connector can be connected to an 18/24-bit dual-channel LVDS panel.

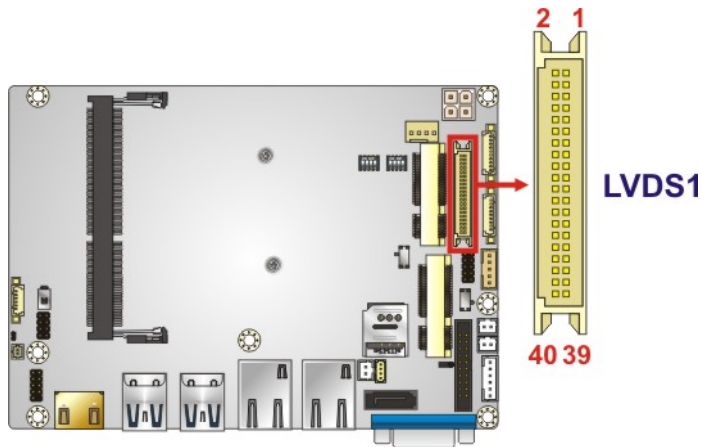

Figure 3-10: LVDS Connector Location



NOTE:

To use LVDS, the #33 pin of LVDS1 connector must be connected with GND pin; otherwise the LVDS panel will not be detected, or fail to display.

Pin	Description	Pin	Description
1	GND	2	GND
3	A_Y0#	4	A_Y1#
5	A_Y0	6	A_Y1
7	GND	8	GND
9	A_Y2#	10	A_CK#
11	A_Y2	12	A_CK
13	GND	14	GND
15	A_Y3#	16	B_Y0#
17	A_Y3	18	B_Y0
19	GND	20	GND
21	B_Y1#	22	B_Y2#
23	B_Y1	24	B_Y2
25	GND	26	GND
27	B_CK#	28	B_Y3#
29	B_CK	30	B_Y3
31	GND	32	GND
33	LVDS Detect (GND)*	34	GND
35	LVDS_VCC	36	LVDS_VCC
37	LVDS_VCC	38	LVDS_VCC
39	LVDS_VCC	40	LVDS_VCC

***LVDS Detect must be connected to GND.**

Table 3-11: LVDS Connector Pinouts

3.2.10 PCIe Mini Card Slot (with mSAT Support)

- CN Label:** MINI_PCIE2
- CN Type:** PCIe Mini card slot
- CN Location:** See **Figure 3-11**
- CN Pinouts:** See **Table 3-12**

The PCIe Mini card slot enables a full-size PCIe Mini card expansion module (including an mSATA module) to be connected to the board.

WAFER-ULT3/ULT4 3.5" SBC

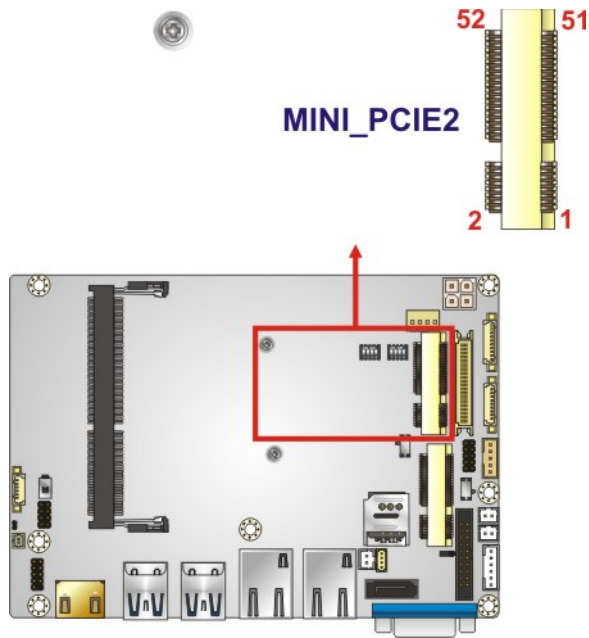

Figure 3-11: PCIe Mini Card Slot (with mSATA Support) Location

Pin	Description	Pin	Description
1	PCIE_WAKE#	2	VCC3
3	N/C	4	GND
5	N/C	6	1.5V
7	N/C	8	N/C
9	GND	10	N/C
11	PCIE_CLK#	12	N/C
13	PCIE_CLK	14	N/C
15	GND	16	N/C
17	N/C	18	GND
19	N/C	20	N/C
21	GND	22	PCIRST#
23	PCIE_RXN(SATA_RX+)	24	N/C
25	PCIE_RXP(SATA_RX-)	26	GND
27	GND	28	1.5V
29	GND	30	SMBCLK
31	PCIE_TXN(SATA_TX-)	32	SMBDATA
33	PCIE_TXP(SATA_TX+)	34	GND

Pin	Description	Pin	Description
35	GND	36	USBD-
37	GND	38	USBD+
39	VCC3	40	GND
41	VCC3	42	N/C
43	GND	44	N/C
45	N/C	46	N/C
47	N/C	48	1.5V
49	N/C	50	GND
51	N/C	52	VCC3

Table 3-12: PCIe Mini Card Slot (with mSATA Support) Pinouts

3.2.11 PCIe Mini Card Slot (with SIM Card Socket)

- CN Label:** MINI_PCIE1
- CN Type:** PCIe Mini card slot
- CN Location:** See **Figure 3-12**
- CN Pinouts:** See **Table 3-13**

The PCIe Mini card slot enables a full-size PCIe Mini card expansion module to be connected to the board.

WAFER-ULT3/ULT4 3.5" SBC

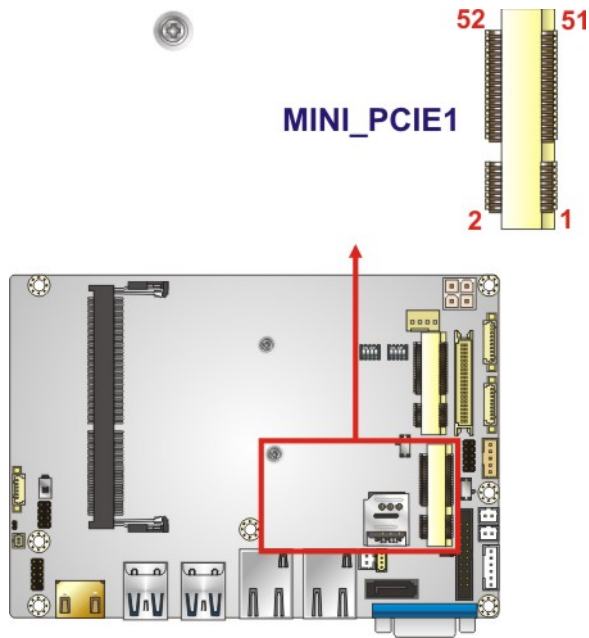

Figure 3-12: PCIe Mini Card Slot (with SIM Card Socket) Location

Pin	Description	Pin	Description
1	PCIE_WAKE#	2	VCC3
3	N/C	4	GND
5	N/C	6	1.5V
7	N/C	8	UIM_PWR
9	GND	10	UIM_DATA
11	PCIE_CLK#	12	UIM_CLK
13	PCIE_CLK	14	UIM_RST
15	GND	16	UIM_VPP
17	N/C	18	GND
19	N/C	20	N/C
21	GND	22	PCIRST#
23	PCIE_RXN	24	N/C
25	PCIE_RXP	26	GND
27	GND	28	1.5V
29	GND	30	SMBCLK
31	PCIE_TXN	32	SMBDATA

Pin	Description	Pin	Description
33	PCIE_TXP	34	GND
35	GND	36	USBD-
37	GND	38	USBD+
39	VCC3	40	GND
41	VCC3	42	N/C
43	GND	44	N/C
45	N/C	46	N/C
47	N/C	48	1.5V
49	N/C	50	GND
51	M-SATA Detect	52	VCC3

Table 3-13: PCIe Mini Card Slot (with SIM Card Socket) Pinouts

3.2.12 Power and HDD LED Connector

- CN Label:** F_PANEL1
- CN Type:** 6-pin wafer, p=2 mm
- CN Location:** See Figure 3-13
- CN Pinouts:** See Table 3-14

The LED connector connects to an HDD indicator LED and a power LED on the system chassis to inform the user about HDD activity and the power on/off status of the system.

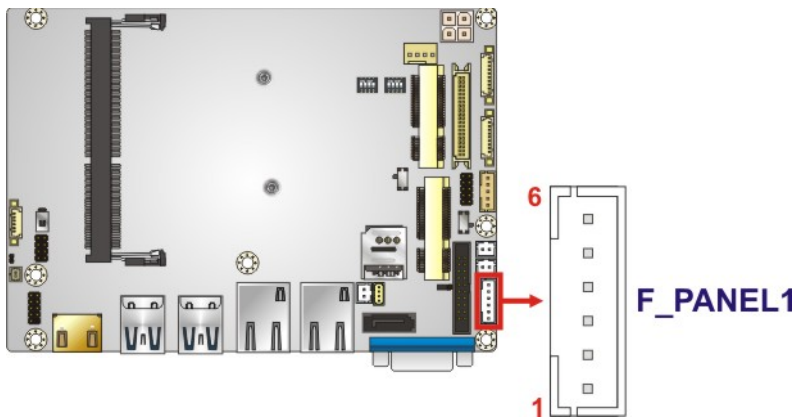

Figure 3-13: Power and HDD LED Connector Location

WAFAER-ULT3/ULT4 3.5" SBC

Function	Pin	Description
+5V	1	VCC
	2	GND
Power LED	3	PWR_LED+
	4	PWR_LED-
HDD LED	5	HDD_LED+
	6	HDD_LED-

Table 3-14: Power and HDD LED Connector Pinouts

3.2.13 Power Button Connector

- CN Label:** PWR_BTN1
- CN Type:** 2-pin wafer, p=2 mm
- CN Location:** See **Figure 3-14**
- CN Pinouts:** See **Table 3-15**

The power button connector is connected to a power switch on the system chassis to enable users to turn the system on and off.

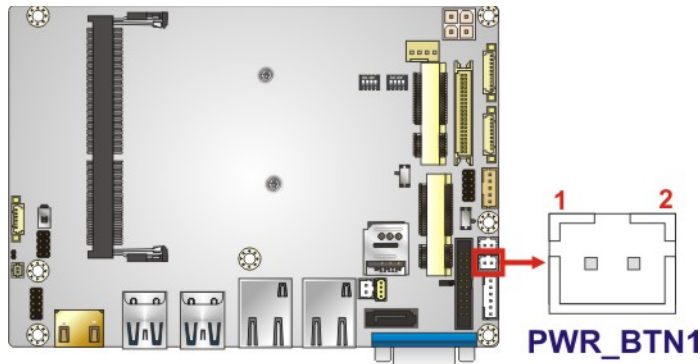

Figure 3-14: Power Button Connector Location

Pin	Description
1	PWR_BTN+
2	PWR_BTN-

Table 3-15: Power Button Connector Pinouts

3.2.14 Reset Button Connector

- CN Label:** RST_BTN1
- CN Type:** 2-pin wafer, p=2 mm
- CN Location:** See **Figure 3-15**
- CN Pinouts:** See **Table 3-16**

The reset button connector is connected to a reset switch on the system chassis to enable users to reboot the system when the system is turned on.

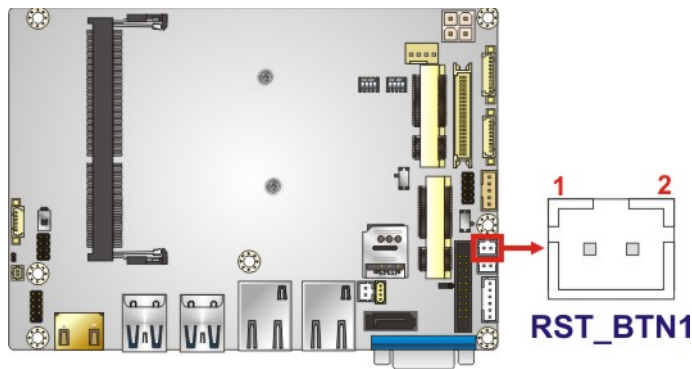

Figure 3-15: Reset Button Connector Location

Pin	Description
1	RESET+
2	RESET-

Table 3-16: Reset Button Connector Pinouts

3.2.15 RS-232/422/485 Serial Port Connectors

- CN Label:** COM1, COM2
- CN Type:** 9-pin wafer, p=1.25 mm
- CN Location:** See **Figure 3-16**
- CN Pinouts:** See **Table 3-17**

WAFER-ULT3/ULT4 3.5" SBC

These two connectors provide RS-232, RS-422 or RS-485 communications. The default mode is set to RS-232. To configure the connectors as RS-422 or RS-485, please refer to **Section 4.6.6**.

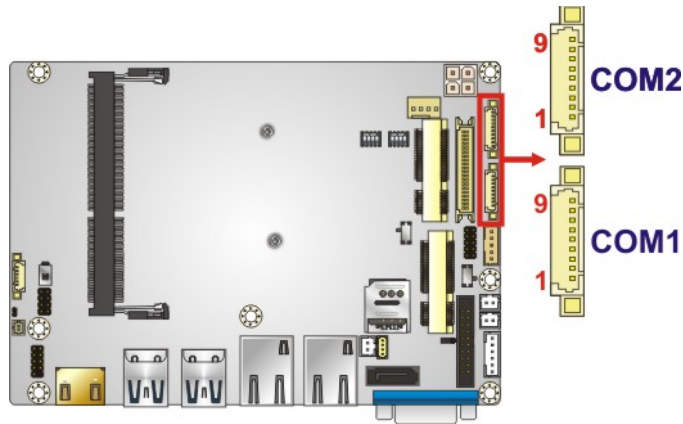

Figure 3-16: RS-232 Serial Port Connector Locations

Pin	RS-232	RS-422	RS-485
1	DCD	TXD-	DATA-
2	DSR	N/A	N/A
3	RXD	TXD+	DATA+
4	RTS	N/A	N/A
5	TXD	RXD+	N/A
6	CTS	N/A	N/A
7	DTR	RXD-	N/A
8	RI	N/A	N/A
9	GND	N/A	N/A

Table 3-17: RS-232/422/485 Serial Port Connector Pinouts

Use the optional RS-232/422/485 cable to connect to a serial device. The pinouts of the DB-9 connector are listed below.

Pin	RS-232	RS-422	RS-485
1	DCD	TXD422-	TXD485-
2	RXD	TXD422+	TXD485+
3	TXD	RXD422+	--
4	DTR	RXD422-	--
5	GND	--	--
6	DSR	--	--
7	RTS	--	--
8	CTS	--	--
9	RI	--	--

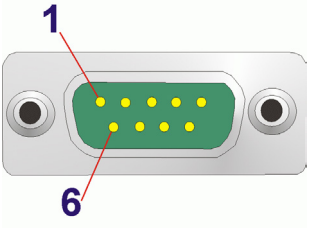

Table 3-18: DB-9 RS-232/422/485 Pinouts

3.2.16 SATA 6Gb/s Connector

- CN Label:** SATA1
- CN Type:** 7-pin SATA drive connector
- CN Location:** See **Figure 3-17**
- CN Pinouts:** See **Table 3-19**

The SATA drive connector can be connected to the SATA drive and supports up to 6Gb/s data transfer rate.

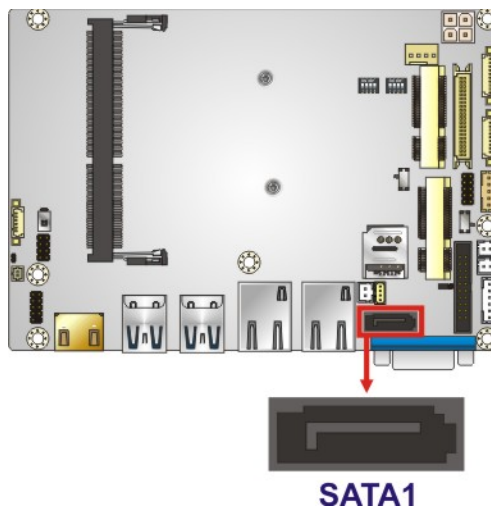

Figure 3-17: SATA 6Gb/s Connector Location

WAFER-ULT3/ULT4 3.5" SBC

Pin	Description
1	GND
2	TX+
3	TX-
4	GND
5	RX-
6	RX+
7	GND

Table 3-19: SATA 6Gb/s Drive Connector Pinouts

3.2.17 SIM Card Slot

- CN Label:** SIM1
- CN Type:** SIM card slot
- CN Location:** See **Figure 3-18**

The SIM card slot accepts a SIM card for WWAN network communication. **NOTE:** A WWAN module must be installed in the **MINI-PCIe1** PCIe Mini slot to provide WWAN communication.

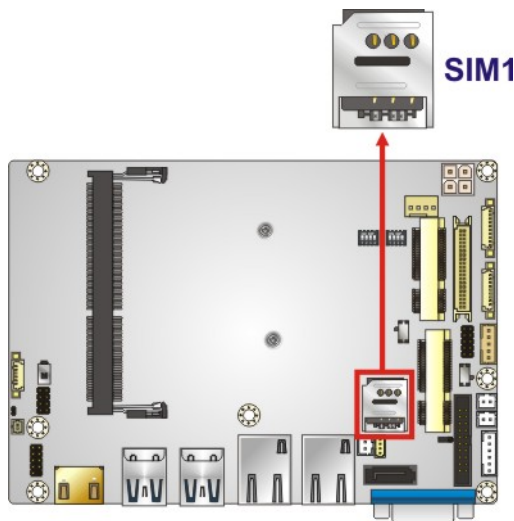

Figure 3-18: SIM Card Slot Location

3.2.18 SMBus Connector

- CN Label:** SMB1
- CN Type:** 4-pin wafer, p=1.25 mm
- CN Location:** See **Figure 3-19**
- CN Pinouts:** See **Table 3-20**

The SMBus (System Management Bus) connector provides low-speed system management communications.

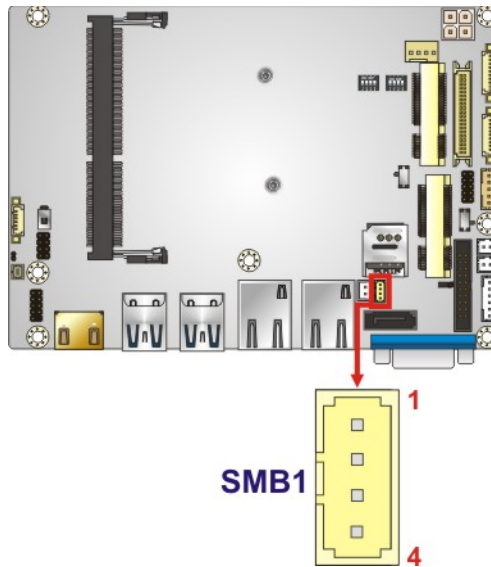

Figure 3-19: SMBus Connector Location

Pin	Description
1	GND
2	SMBUS(I2C) DATA
3	SMBUS(I2C) CLK
4	+5V

Table 3-20: SMBus Connector Pinouts

WAFER-ULT3/ULT4 3.5" SBC

3.2.19 SO-DIMM Slot

- CN Label:** DIMM2
- CN Type:** 260-pin DDR4 SO-DIMM slot
- CN Location:** See **Figure 3-20**

The SO-DIMM slot is for installing the SO-DIMM on the system.

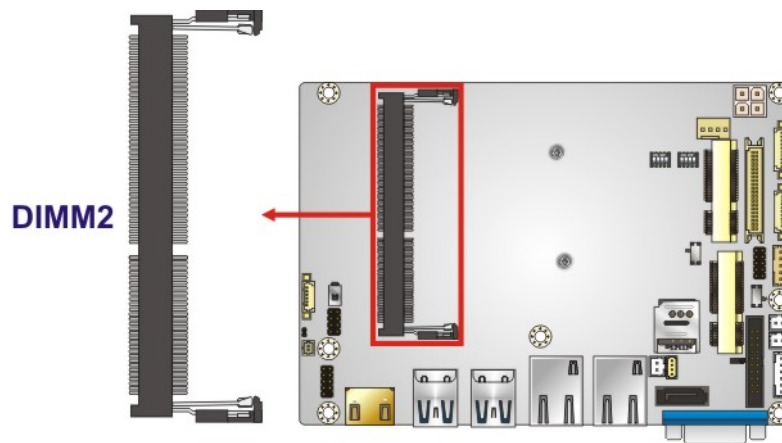

Figure 3-20: SO-DIMM Slot Location

3.2.20 SPI Flash Connector

- CN Label:** JSPI1
- CN Type:** 6-pin wafer, p=1.25 mm
- CN Location:** See **Figure 3-21**
- CN Pinouts:** See **Table 3-21**

The SPI flash connector is used to flash the SPI ROM.

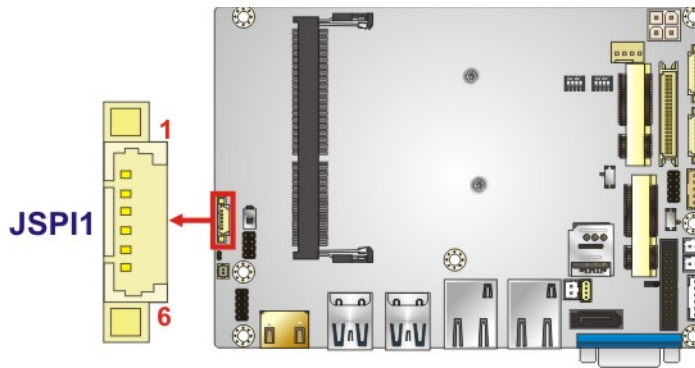

Figure 3-21: SPI Flash Connector Location

Pin	Description
1	+3.3V_SPI_CON
2	SPI_CS#0_N
3	SPI_SO_N
4	SPI_CLK_N
5	SPI_SI_N
6	GND

Table 3-21: SPI Flash Connector Pinouts

WAFER-ULT3/ULT4 3.5" SBC

3.2.21 USB 2.0 Connector

- CN Label:** USB1
- CN Type:** 8-pin header, p=2 mm
- CN Location:** See **Figure 3-22**
- CN Pinouts:** See **Table 3-22**

The USB header can connect to two USB 2.0/1.1 devices.

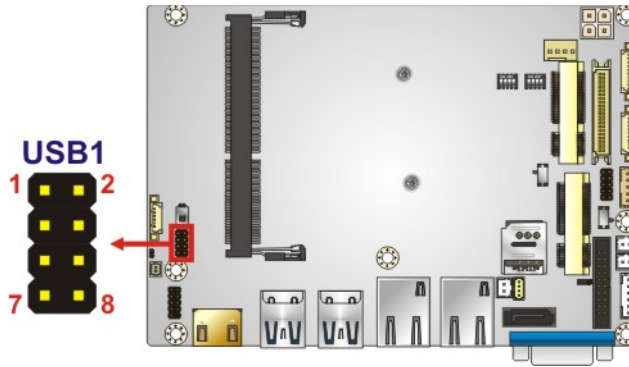

Figure 3-22: USB 2.0 Connector Location

Pin	Description	Pin	Description
1	USB_VCC	2	GND
3	DATA-	4	DATA+
5	DATA+	6	DATA-
7	GND	8	USB_VCC

Table 3-22: USB 2.0 Connector Pinouts

3.3 External Interface Connectors

The figure below shows the external peripheral interface connector (EPIC) panel. The EPIC panel consists of the following:

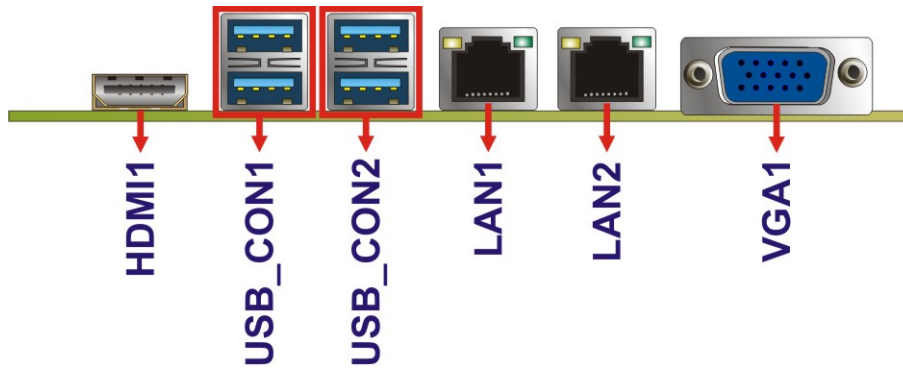

Figure 3-23: External Interface Connectors

3.3.1 GbE Connectors

- CN Label:** LAN1, LAN2
- CN Type:** RJ-45
- CN Location:** See Figure 3-23
- CN Pinouts:** See Figure 3-24 and Table 3-23

Each LAN connector connects to a local network.

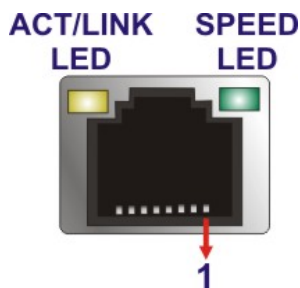

Figure 3-24: LAN Connector

Pin	Description	Pin	Description
1	LAN_MDIO+	7	LAN_MDIO2+
2	LAN_MDIO-	8	LAN_MDIO2-

WAFER-ULT3/ULT4 3.5" SBC

Pin	Description	Pin	Description
3	LAN_MDI1+	9	LAN_MDI3+
4	LAN_MDI1-	10	LAN_MDI3-

Table 3-23: LAN Pinouts

3.3.2 HDMI Connector

- CN Label:** HDMI1
- CN Type:** HDMI connector
- CN Location:** See **Figure 3-23**
- CN Pinouts:** See **Figure 3-25** and **Table 3-24**

The HDMI connector can connect to an HDMI device.

Pin	Description	Pin	Description
1	HDMI_DATA2	2	GND
3	HDMI_DATA2#	4	HDMI_DATA1
5	GND	6	HDMI_DATA1#
7	HDMI_DATA0	8	GND
9	HDMI_DATA0#	10	HDMI_CLK
11	GND	12	HDMI_CLK#
13	N/C	14	N/C
15	HDPMI_SCL	16	HDMI_SDA
17	GND	18	+5V
19	HDPMI_HPD	20	HDMI_GND

Table 3-24: HDMI Connector Pinouts

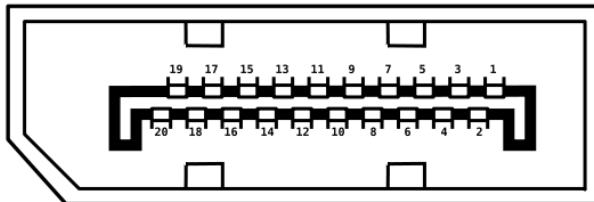

Figure 3-25: HDMI Connector Pinout Locations

3.3.3 USB 3.1 Gen 1 Ports

- CN Label:** USB_CON1, USB_CON2
- CN Type:** Dual USB 3.1 Gen 1 port
- CN Location:** See **Figure 3-23**
- CN Pinouts:** See **Figure 3-26** and **Table 3-25**

The WAFER-ULT3/ULT4 has four external USB 3.1 Gen 1 (5 Gb/s) ports.

Pin	Description	Pin	Description
1	USB_VCC	2	USB2_D0-
3	USB2_D0-	4	GND
5	USB3_RXD0-	6	USB3_RXD0+
7	GND	8	USB3_TXD0-
9	USB3_TXD0+	10	USB_VCC
11	USB2_D1-	12	USB2_D1+
13	GND	14	USB3_RXD1-
15	USB3_RXD1+	16	GND
17	USB3_TXD1-	18	USB3_TXD1+

Table 3-25: USB 3.1 Gen 1 Port Pinouts

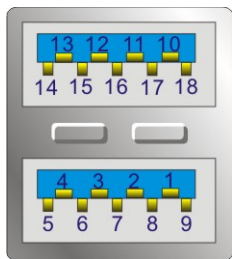

Figure 3-26: USB 3.1 Gen 1 Port Pinout Locations

WAFER-ULT3/ULT4 3.5" SBC

3.3.4 VGA Connector

- CN Label:** VGA1
- CN Type:** 15-pin female
- CN Location:** See **Figure 3-23**
- CN Pinouts:** See **Figure 3-27** and **Table 3-26**

The VGA connector connects to a monitor that accepts a standard VGA input.

Pin	Description	Pin	Description
1	RED	2	GREEN
3	BLUE	4	NC
5	GND	6	GND
7	GND	8	GND
9	VCC	10	GND
11	NC	12	DDCDAT
13	HSYNC	14	VSYNC
15	DDCCLK		

Table 3-26: VGA Connector Pinouts

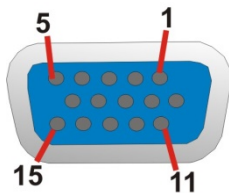

Figure 3-27: VGA Connector



NOTE:

The VGA connector is co-lay with the iDP connector. When the iDP connector is enabled, the VGA connector will be disabled. This is controlled by the VGA/iDP selection switch. Please refer to **Section 4.6.7** for detailed information.

Chapter

4

Installation

WAFER-ULT3/ULT4 3.5" SBC

4.1 Anti-static Precautions



WARNING:

Failure to take ESD precautions during the installation of the WAFER-ULT3/ULT4 may result in permanent damage to the WAFER-ULT3/ULT4 and severe injury to the user.

Electrostatic discharge (ESD) can cause serious damage to electronic components, including the WAFER-ULT3/ULT4. Dry climates are especially susceptible to ESD. It is therefore critical that whenever the WAFER-ULT3/ULT4 or any other electrical component is handled, the following anti-static precautions are strictly adhered to.

- ***Wear an anti-static wristband:*** - Wearing a simple anti-static wristband can help to prevent ESD from damaging the board.
- ***Self-grounding:***- Before handling the board touch any grounded conducting material. During the time the board is handled, frequently touch any conducting materials that are connected to the ground.
- ***Use an anti-static pad:*** When configuring the WAFER-ULT3/ULT4, place it on an anti-static pad. This reduces the possibility of ESD damaging the WAFER-ULT3/ULT4.
- ***Only handle the edges of the PCB:-:*** When handling the PCB, hold the PCB by the edges.

4.2 Installation Considerations



NOTE:

The following installation notices and installation considerations should be read and understood before installation. All installation notices must be strictly adhered to. Failing to adhere to these precautions may lead to severe damage and injury to the person performing the installation.

**WARNING:**

The installation instructions described in this manual should be carefully followed in order to prevent damage to the components and injury to the user.

Before and during the installation please **DO** the following:

- Read the user manual:
The user manual provides a complete description of the WAFER-ULT3/ULT4 installation instructions and configuration options.
- Wear an electrostatic discharge cuff (ESD):
Electronic components are easily damaged by ESD. Wearing an ESD cuff removes ESD from the body and helps prevent ESD damage.
- Place the WAFER-ULT3/ULT4 on an anti-static pad:
When installing or configuring the motherboard, place it on an anti-static pad. This helps to prevent potential ESD damage.
- Turn all power to the WAFER-ULT3/ULT4 off:
When working with the WAFER-ULT3/ULT4, make sure that it is disconnected from all power supplies and that no electricity is being fed into the system.

Before and during the installation of the WAFER-ULT3/ULT4, **DO NOT:**

- Remove any of the stickers on the PCB board. These stickers are required for warranty validation.
- Use the product before verifying all the cables and power connectors are properly connected.
- Allow screws to come in contact with the PCB circuit, connector pins, or its components.

WAFFER-ULT3/ULT4 3.5" SBC

4.3 SO-DIMM Installation

To install a SO-DIMM, please follow the steps below and refer to **Figure 4-1**.

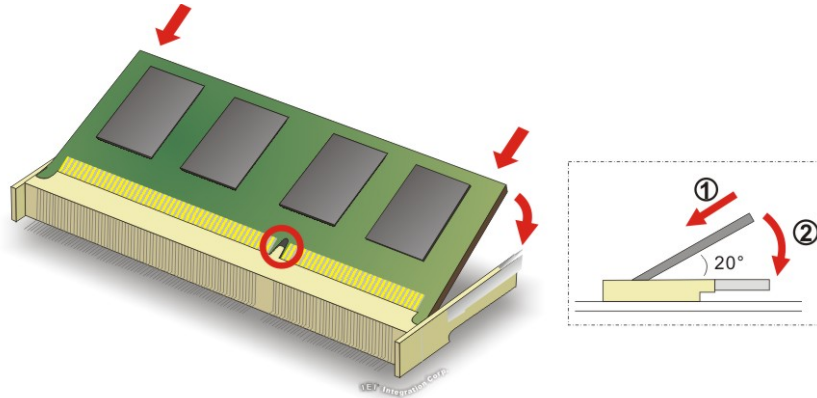

Figure 4-1: SO-DIMM Installation

- Step 1:** Locate the SO-DIMM socket. Place the board on an anti-static mat.
- Step 2:** Align the SO-DIMM with the socket. Align the notch on the memory with the notch on the memory socket.
- Step 3:** Insert the SO-DIMM. Push the memory in at a 20° angle. (See **Figure 4-1**)
- Step 4:** Seat the SO-DIMM. Gently push downwards and the arms clip into place. (See **Figure 4-1**)

4.4 PCIe Mini Card Installation

To install a full-size PCIe Mini card, please follow the steps below.

- Step 1:** Locate the PCIe Mini card slot. See **Chapter 3**.
- Step 2:** Remove the retention screw. Remove the retention screw as shown in **Figure 4-2**.

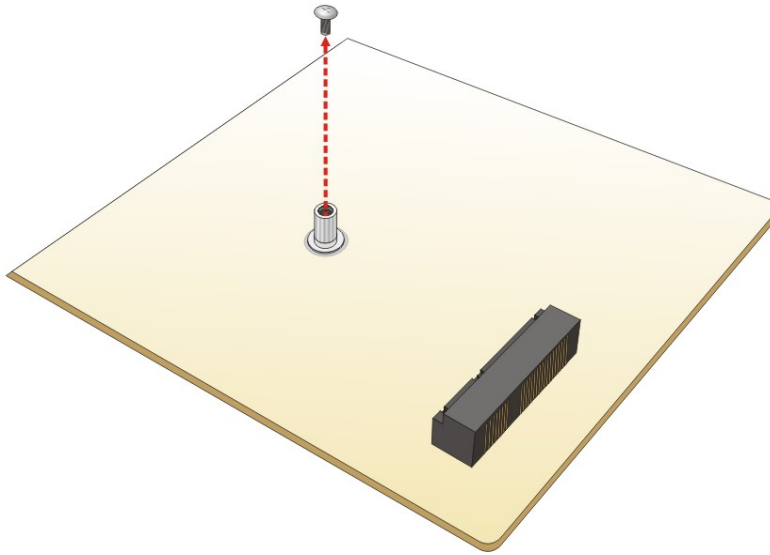

Figure 4-2: Removing the Retention Screw

Step 3: Insert into the socket at an angle. Line up the notch on the card with the notch on the slot. Slide the PCIe Mini card into the socket at an angle of about 20° (Figure 4-3).

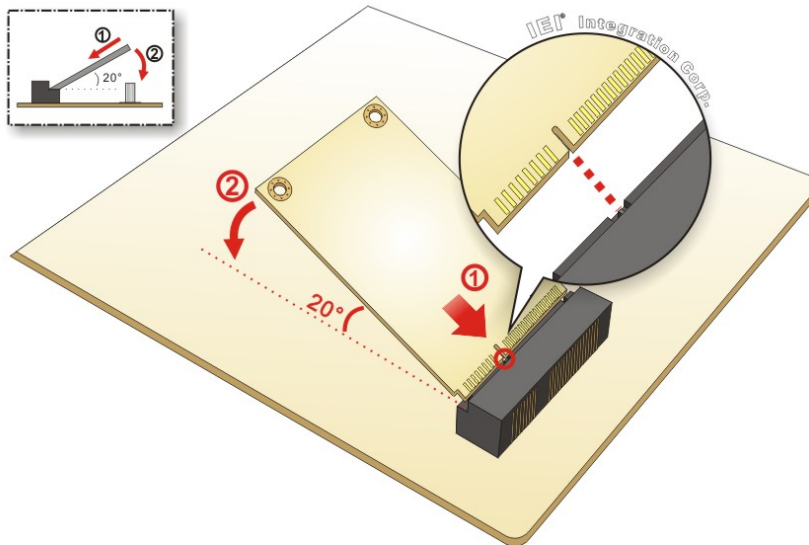

Figure 4-3: Inserting the PCIe Mini Card into the Slot at an Angle

WAFER-ULT3/ULT4 3.5" SBC

Step 4: **Secure the PCIe Mini card.** Secure the PCIe Mini card with the retention screw previously removed (**Figure 4-4**).

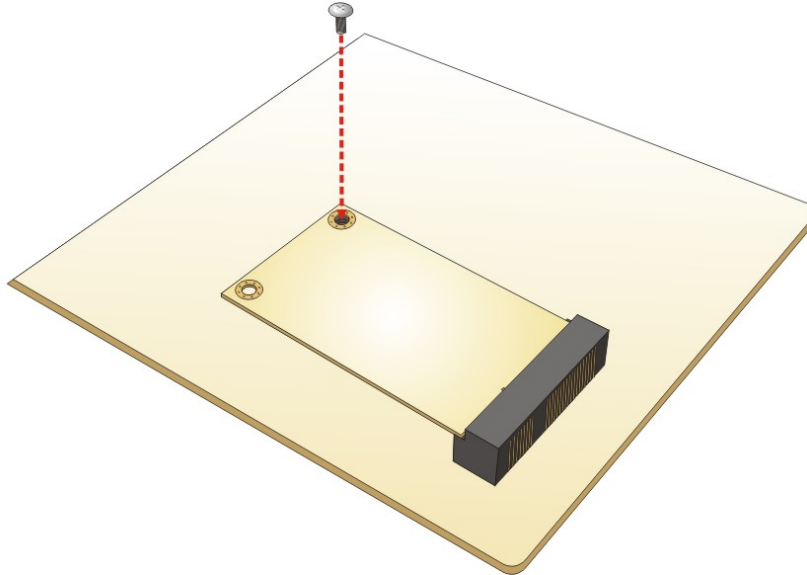

Figure 4-4: Securing the PCIe Mini Card

4.5 SIM Card Installation



NOTE:

A WWAN module must be installed in the PCIe Mini slot (MINI-PICE1) to provide WWAN communication.

To install a SIM card, please follow the steps below.

Step 1: Locate the SIM card slot. See **Chapter 3**.

Step 2: Unlock the SIM card slot cover by sliding the cover in the direction as shown by the arrow in **Figure 4-5**.



Figure 4-5: Unlock SIM Card Slot Cover

Step 3: Open the slot cover and place a SIM card onto the slot. The cut mark on the corner should be facing away from the slot as shown in **Figure 4-6**.

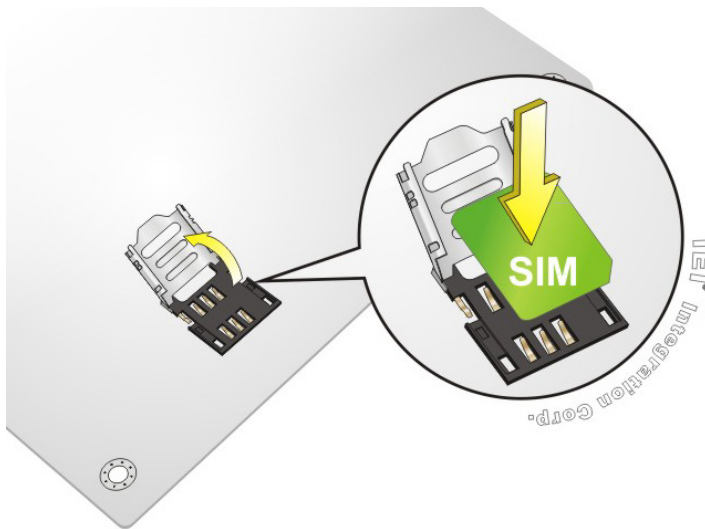

Figure 4-6: SIM Card Installation

Step 4: Close the slot cover and lock it by sliding it in the direction as shown by the arrow in **Figure 4-7**.

WAFER-ULT3/ULT4 3.5" SBC



Figure 4-7: Lock SIM Card Slot Cover

4.6 System Configuration

The system configuration is controlled by buttons, jumpers and switches. The system configuration should be performed before installation.

4.6.1 AT/ATX Power Mode Selection

The AT and ATX power mode selection is made through the AT/ATX power mode switch which is shown in **Figure 4-8**.

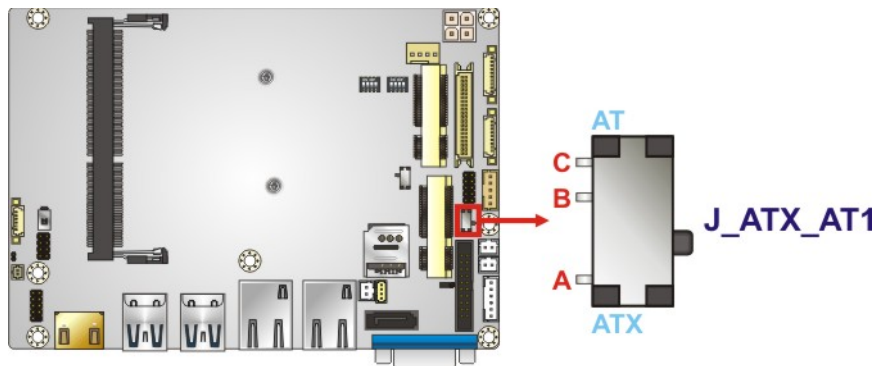

Figure 4-8: AT/ATX Power Mode Switch Location

Setting	Description
A-B	ATX power mode (default)
B-C	AT power mode

Table 4-1: AT/ATX Power Mode Switch Settings

4.6.2 Clear CMOS Button

To reset the BIOS, remove the on-board battery and press the clear CMOS button for three seconds or more. The clear CMOS button location is shown in **Figure 4-9**.

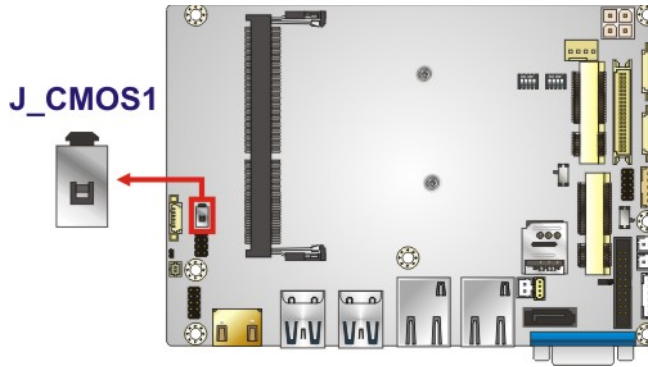

Figure 4-9: Clear CMOS Button Location

4.6.3 Flash Descriptor Security Override Jumper

- CN Label:** ME_FLASH1
- CN Type:** 2-pin header, p=1.27 mm
- CN Location:** See **Figure 4-10**
- CN Settings:** See **Table 4-2**

The Flash Descriptor Security Override jumper (ME_FLASH1) allows to enable or disable the ME firmware update. Refer to **Figure 4-10** and **Table 4-2** for the jumper location and settings.

Setting	Description
Open	Disabled (default)
Short	Enabled

Table 4-2: Flash Descriptor Security Override Jumper Settings

WAFER-ULT3/ULT4 3.5" SBC

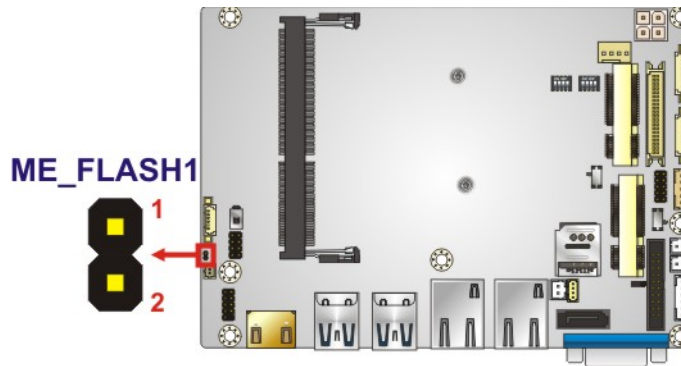

Figure 4-10: Flash Descriptor Security Override Jumper Location

To update the ME firmware, please follow the steps below.

- Step 1:** Before turning on the system power, short the Flash Descriptor Security Override jumper.
- Step 2:** Update the BIOS and ME firmware, and then turn off the system power.
- Step 3:** Remove the metal clip on the Flash Descriptor Security Override jumper to its default setting.
- Step 4:** Restart the system. The system will reboot 2 ~ 3 times to complete the ME firmware update.

4.6.4 LVDS Panel Type Selection

- Jumper Label:** SW1
- Jumper Type:** DIP switch
- Jumper Settings:** See Table 4-3
- Jumper Location:** See Figure 4-11

Selects the resolution of the LCD panel connected to the LVDS connector.

* ON=0, OFF=1; Single=S, Dual=D

SW1 (4-3-2-1)	Description
0000	800x600 18-bit S (default)
0001	1024x768 18-bit S

SW1 (4-3-2-1)	Description
0010	1024x768 24-bit S
0011	1280x768 18-bit S
0100	1280x800 18-bit S
0101	1280x960 18-bit S
0110	1280x1024 24-bit D
0111	1366x768 18-bit S
1000	1366x768 24-bit S
1001	1440x960 24-bit D
1010	1400x1050 24-bit D
1011	1600x900 24-bit D
1100	1680x1050 24-bit D
1101	1600x1200 24-bit D
1110	1920x1080 24-bit D
1111	1920x1200 24-bit D

Table 4-3: LVDS Panel Type Selection

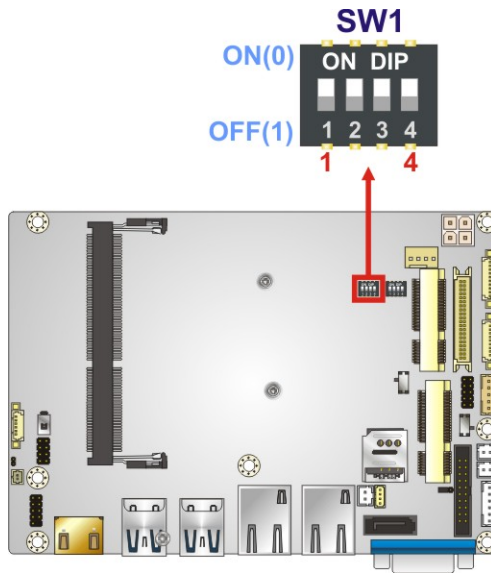

Figure 4-11: LVDS Panel Type Selection Switch Location

WAFER-ULT3/ULT4 3.5" SBC

4.6.5 LVDS Voltage Selection



WARNING:

Permanent damage to the screen and WAFER-ULT3/ULT4 may occur if the wrong voltage is selected with this jumper. Please refer to the user guide that came with the monitor to select the correct voltage.

- Jumper Label:** JP1
- Jumper Type:** 3-pin header, p=2 mm
- Jumper Settings:** See **Table 4-4**
- Jumper Location:** See **Figure 4-12**

The LVDS voltage selection jumper allows setting the voltage provided to the monitor connected to the LVDS connector.

Setting	Description
Short 1-2	+3.3V LVDS (Default)
Short 2-3	+5V LVDS

Table 4-4: LVDS Voltage Selection Jumper Settings

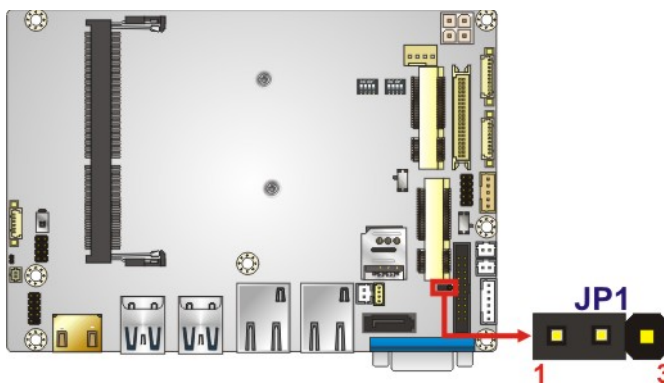

Figure 4-12: LVDS Voltage Selection Jumper Location

4.6.6 Serial Port Mode Selection Switch

- CN Label:** SW2
- CN Type:** Switch
- CN Location:** See **Figure 4-13**
- CN Settings:** See **Table 4-5** and **Table 4-6**

Use the serial port mode selection switch to select the signal mode for the correspondent serial port.

SW2: 1	SW2: 2	Description (Signal Mode)
ON	ON	RS-422
ON	OFF	RS-232 (Default)
OFF	ON	RS-485

Table 4-5: Signal Mode Settings for Serial Port 1

SW2: 3	SW2: 4	Description (Signal Mode)
ON	ON	RS-422
ON	OFF	RS-232 (Default)
OFF	ON	RS-485

Table 4-6: Signal Mode Settings for Serial Port 2

The location of the serial port mode selection switch is shown in **Figure 4-13** below.

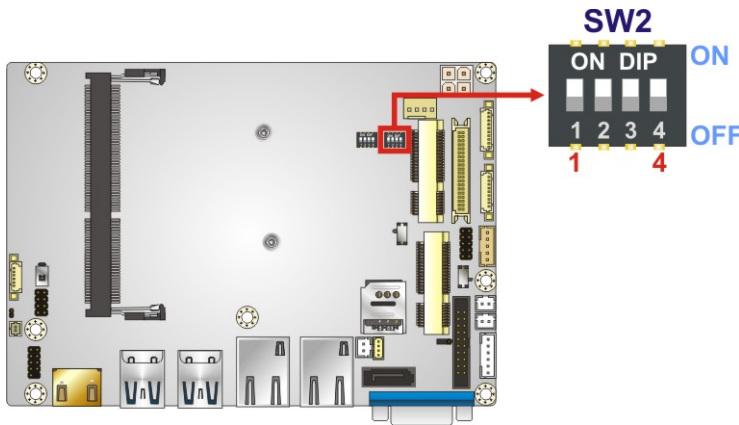

Figure 4-13: Serial Port Mode Selection Switch Location

WAFER-ULT3/ULT4 3.5" SBC

4.6.7 VGA/iDP Selection Switch

- CN Label:** J_VGA_DP1
- CN Type:** Switch
- CN Location:** See **Figure 4-14**
- CN Settings:** See **Table 4-7**

Use the VGA/iDP selection switch to select VGA mode or iDP mode since the iDP connector (DP1) is co-lay with the VGA connector. The VGA/iDP selection switch settings are shown in **Table 4-7**.

Setting	Description
Short A-B	VGA mode (Default)
Short B-C	IEI Internal DisplayPort mode

Table 4-7: VGA/iDP Selection Switch Settings

The location of the VGA/iDP selection switch is shown in **Figure 4-14** below.

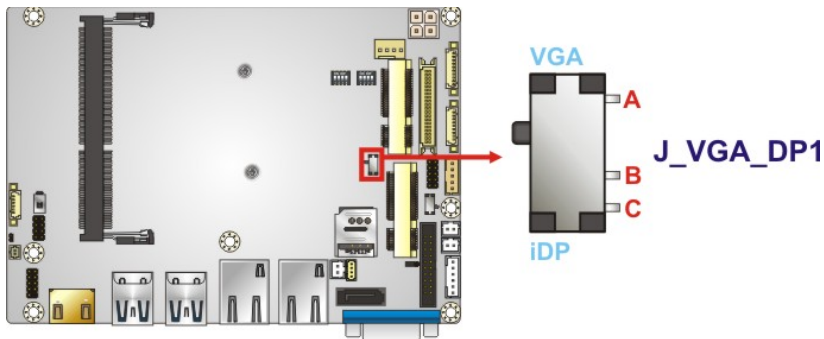

Figure 4-14: VGA/iDP Selection Switch Location

4.7 Motherboard Installation

4.7.1 Heat Spreader



WARNING:

The heat spreader installed on the WAFER-ULT3/ULT4 can only serve as a heat conductor which needs additional heat dissipation mechanism to achieve suitable thermal condition. DO NOT put the WAFER-ULT3/ULT4 with the heat spreader directly on a surface that cannot dissipate system heat, and never run the WAFER-ULT3/ULT4 without the heat spreader secured to the board.

When the WAFER-ULT3/ULT4 is shipped, it is secured to a heat spreader with five retention screws. The heat spreader must have a direct contact with a heat dissipation surface to ensure stable operation. In addition, a thin layer of thermal paste has to be applied onto the heat dissipation surface where it contacts the heat spreader. The following diagrams show an example of a heat sink module and how it can be installed for dissipating the heat generated from the motherboard:

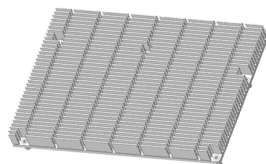

Heat sink module:

Material: Aluminum

Size: 146 mm x 102 mm x 14.6 mm

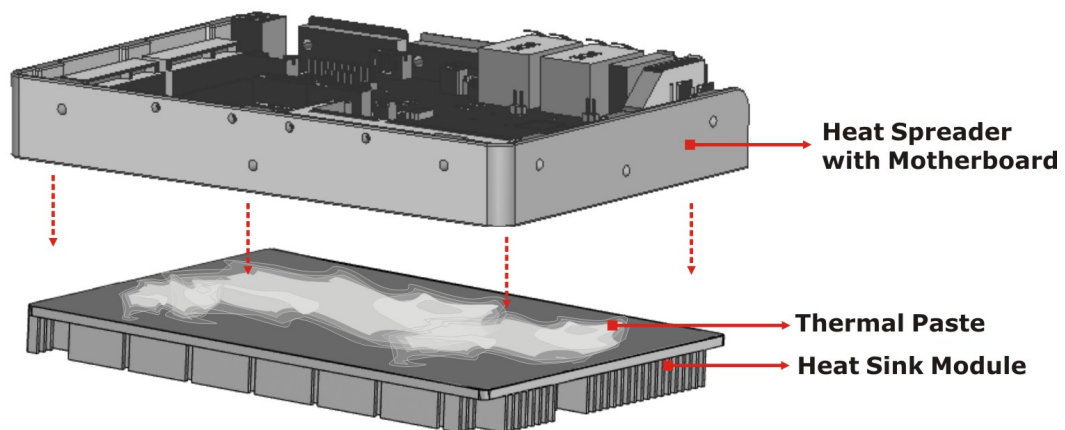

WAFER-ULT3/ULT4 3.5" SBC

If the WAFER-ULT3/ULT4 must be removed from the heat spreader, the five retention screws must be removed.

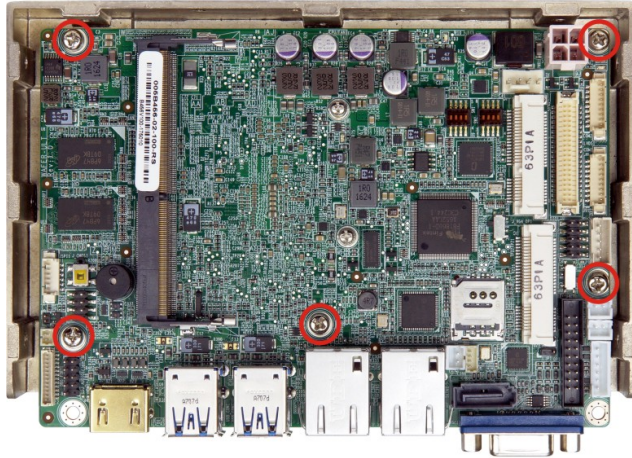

Figure 4-15: Heat Spreader Retention Screws

4.7.2 Motherboard Installation Example

Each side of the heat spreader has several screw holes allowing the WAFER-ULT3/ULT4 to be mounted into a chassis (please refer to **Figure 1-4** for the detailed dimensions). The user can design or select a chassis that has screw holes matching up with the holes on the heat spreader for installing the WAFER-ULT3/ULT4. The following diagram shows an example of motherboard installation.

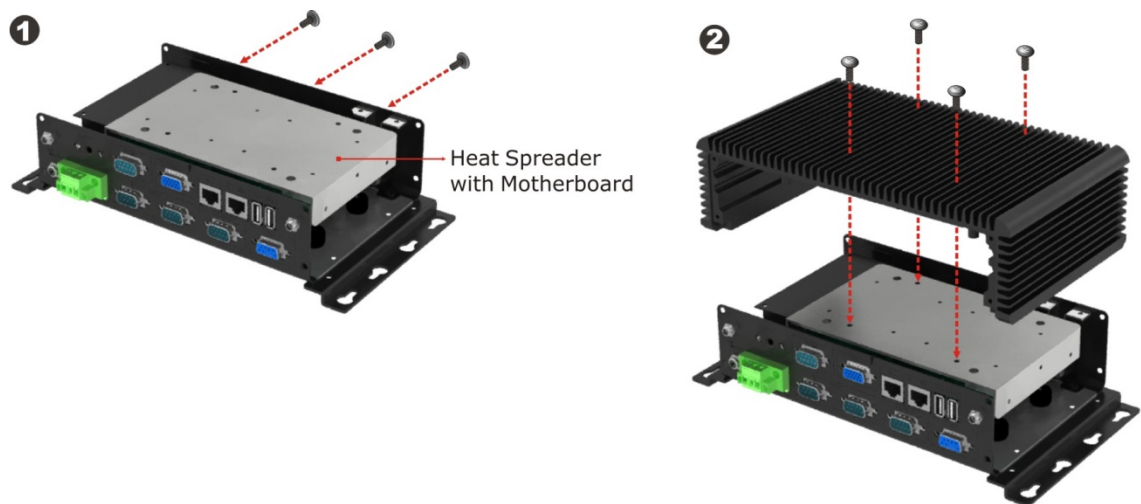

Figure 4-16: Motherboard Installation Example

4.8 Internal Peripheral Device Connections

This section outlines the installation of peripheral devices to the on-board connectors.

4.8.1 AT/ATX Power Connection

Follow the instructions below to connect the WAFER-ULT3/ULT4 to an AT or ATX power supply.



WARNING:

Disconnect the power supply power cord from its AC power source to prevent a sudden power surge to the WAFER-ULT3/ULT4.

Step 1: **Locate the power cable.** The power cable is shown in the packing list in Chapter 2.

Step 2: **Connect the Power Cable to the Motherboard.** Connect the 4-pin (2x2) Molex type power cable connector to the power connector on the motherboard. See Figure 4-17.

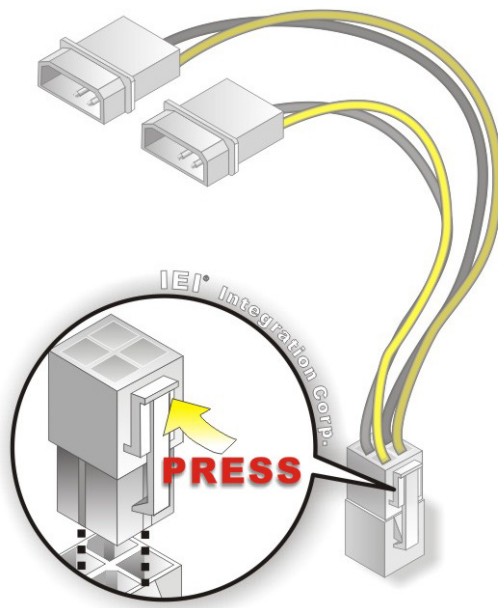

Figure 4-17: Power Cable to Motherboard Connection

WAFER-ULT3/ULT4 3.5" SBC

Step 3: Connect Power Cable to Power Supply. Connect one of the 4-pin (1x4) Molex type power cable connectors to an AT/ATX power supply. See **Figure 4-18**.

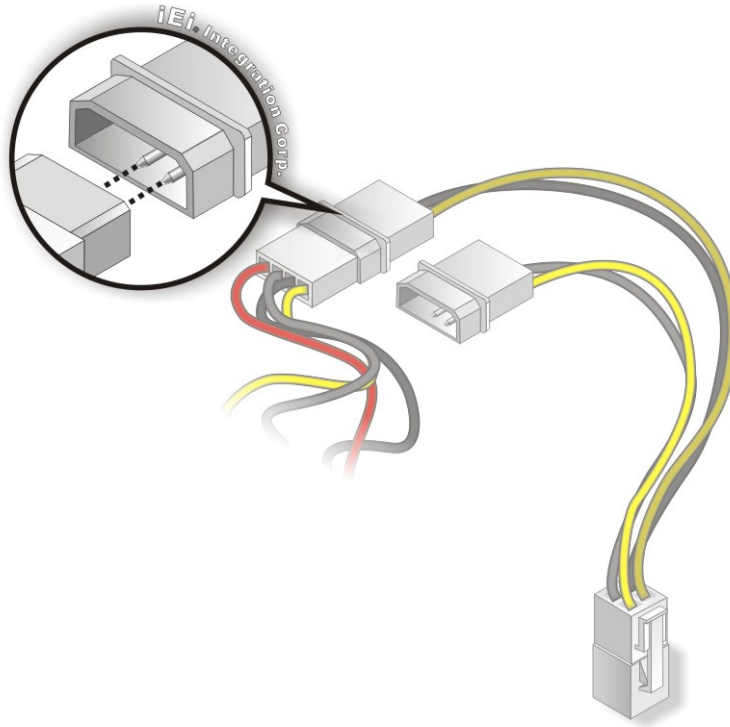

Figure 4-18: Connect Power Cable to Power Supply

4.8.2 SATA Drive Connection

The WAFER-ULT3/ULT4 is shipped with one SATA signal and power cable. To connect the SATA drive to the connectors, please follow the steps below.

Step 1: Locate the SATA connector and the SATA power connector. The locations of the connectors are shown in **Chapter 3**.

Step 2: Insert the cable connectors. Insert the cable connectors into the on-board SATA drive connector and the SATA power connector. See **Figure 4-19**.

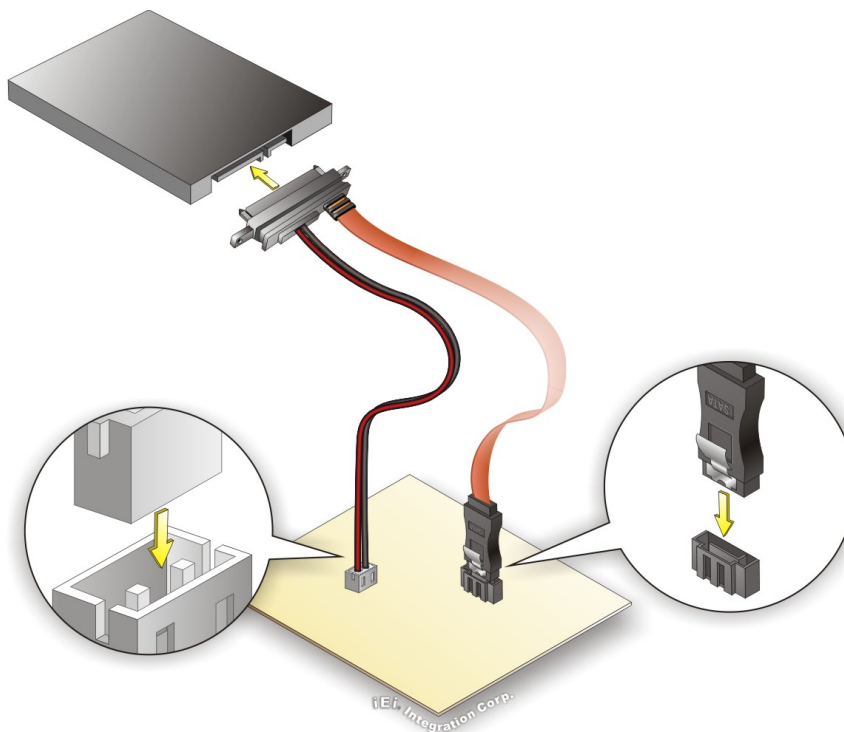

Figure 4-19: SATA Drive Cable Connection

Step 3: Connect the cable to the SATA disk. Connect the connector on the other end of the cable to the connector at the back of the SATA drive. See **Figure 4-19**.

Step 4: To remove the SATA cable from the SATA connector, press the clip on the connector at the end of the cable.

WAFER-ULT3/ULT4 3.5" SBC

4.9 Adding USB 3.1 Gen 1 Drivers to a Windows 7 Installation Image (6th Generation Intel® Mobile ULT On-board SoC Only)

The Windows 7 installation media does not include native driver support for USB 3.1 Gen 1. In order to use the USB keyboard or mouse connected to a USB 3.1 Gen 1 port during OS installation, the user has to update the Windows 7 installation image so that it contains USB drivers. Please follow the instructions below to complete the task.

Step 1: Prepare a USB flash drive installer.

On a working computer, use your Windows 7 DVD or ISO image to create a bootable USB flash drive.

Step 2: Download the Windows 7 USB 3.0 Creator Utility from:

<https://downloadcenter.intel.com/download/26254/Intel-USB-3-0-Device-Driver-for-Windows-7-for-Intel-NUC-Kit-NUC6i7KYK>

Step 3: Extract the downloaded file to a temporary folder on a computer where the user has logged in as the administrator.



NOTE:

The OS version of the computer can be Windows 7, Windows 8.1 or Windows 10.

Step 4: Connect the USB drive containing the Windows 7 installation image to the computer.

Step 5: Right click on **Installer_Creator.exe** from the extracted files and select **Run as administrator**.

Step 6: The Windows 7 USB 3.0 Creator Utility screen appears (**Figure 4-20**). Click  to browse to the root of the USB drive containing the Windows 7 image.

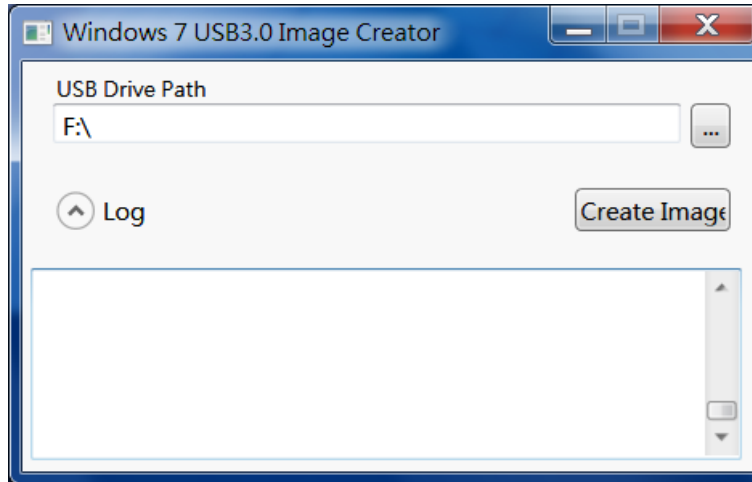

Figure 4-20: Windows 7 USB 3.0 Creator Utility

Step 7: Click **Create Image** to start the update process.

Step 8: Wait for the process to finish. It may take up to 15 minutes.

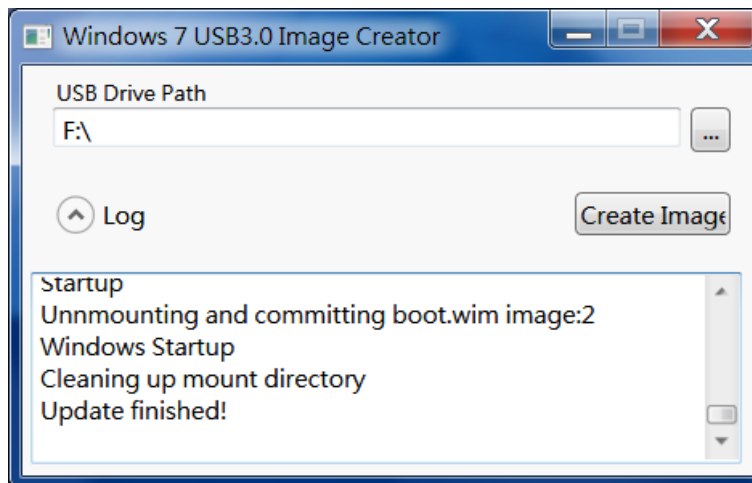

Figure 4-21: Update Process is Complete

Step 9: Now the user can proceed with the Windows 7 installation using the updated installer.

WAFER-ULT3/ULT4 3.5" SBC

4.10 Intel® AMT Setup Procedure

The WAFER-ULT3/ULT4 is featured with the Intel® Active Management Technology (AMT). To enable the Intel® AMT function, follow the steps below.

- Step 1:** Make sure the memory socket is installed with a DDR4 SO-DIMM.
- Step 2:** Connect an Ethernet cable to the RJ-45 connector labeled **LAN1**.
- Step 3:** The AMI BIOS options regarding the Intel® ME or Intel® AMT must be enabled,
- Step 4:** Properly install the Intel® Management Engine Components drivers from the ME Driver downloaded from IEI website.
- Step 5:** Configure the Intel® Management Engine BIOS extension (MEBx). To get into the Intel® MEBx settings, press <Ctrl+P> after a single beep during boot-up process. Enter the Intel® current ME password as it requires (the Intel® default password is **admin**).



NOTE:

To change the password, enter a new password following the strong password rule (containing at least one upper case letter, one lower case letter, one digit and one special character, and be at least eight characters).

4.11 Available Drivers

All the drivers for the WAFER-ULT3/ULT4 are available on IEI Resource Download Center (<https://download.ieiworld.com>). Type WAFER-ULT3 or WAFER-ULT4 and press Enter to find all the relevant software, utilities, and documentation.

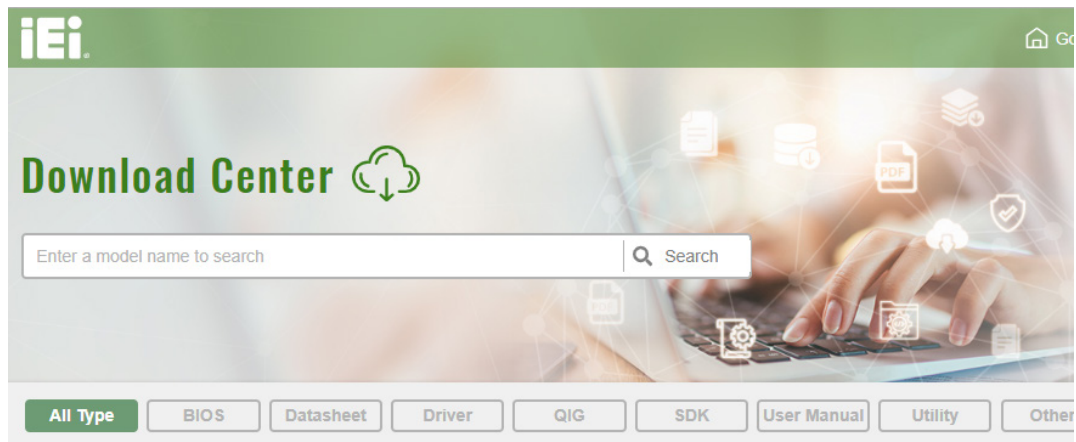
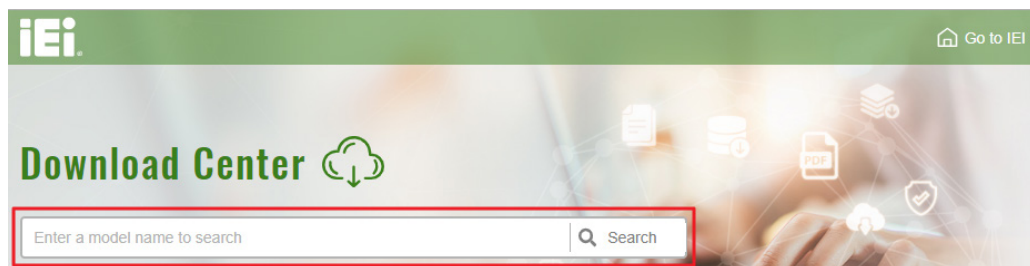

Figure 4-22: IEI Resource Download Center

4.11.1 Driver Download

To download drivers from IEI Resource Download Center, follow the steps below.

Step 1: Go to <https://download.ieiworld.com>. Type WAFER-ULT3 or WAFER-ULT4 and press Enter.



Step 2: All product-related software, utilities, and documentation will be listed. You can choose **Driver** to filter the result.

WAFER-ULT3/ULT4 3.5" SBC

[All Type](#)
[BIOS](#)
[Datasheet](#)
[Driver](#)
[QIG](#)
[SDK](#)
[User Manual](#)
[Utility](#)
[Others](#)

WAFER-BT-i1 [Product Info](#)

[Embedded Computer](#) ▶ [Single Board Computer](#) ▶ [Embedded Board](#)
 3.5" SBC with Intel® 22nm Atom™/Celeron® on-board SoC

Driver

File Name	Published	Version	File Checksum
7B000-001033-RS V2.3.iso (2.23 GB)	2017/10/03	2.30	3B2DB1F792779A93A8F50DDBC3943E30

Step 3: Click the driver file name on the page and you will be prompted with the following window. You can download the entire ISO file (❶), or click the small arrow to find an individual driver and click the file name to download (❷).

7B000-001168-RS_V1.4.iso

❶ [Click here to download entire ISO file. \(2.99 GB\)](#)

* Download individual file *

- Docs
 - 1.Chipset
 - ❷ 10.1.1.12.zip (2.7 MB)
 - 2.VGA
 - 3.Audio
 - 4.Lan
 - 5.USB 3.0
 - 6.Serial IO
 - 7.TXE
 - 8.Manual



NOTE:

To install software from the downloaded ISO image file in Windows 8, 8.1 or 10, double-click the ISO file to mount it as a virtual drive to view its content. On Windows 7 system, an additional tool (such as Virtual CD-ROM Control Panel from Microsoft) is needed to mount the file.

Chapter

5

BIOS

WAFER-ULT3/ULT4 3.5" SBC

5.1 Introduction

The BIOS is programmed onto the BIOS chip. The BIOS setup program allows changes to certain system settings. This chapter outlines the options that can be changed.



NOTE:

Some of the BIOS options may vary throughout the life cycle of the product and are subject to change without prior notice.

5.1.1 Starting Setup

The UEFI BIOS is activated when the computer is turned on. The setup program can be activated by pressing the **DEL** or **F2** key as soon as the system is turned on.

If the system enters the OS environment before the **DEL** or **F2** key is pressed, restart the computer and try again.

5.1.2 Using Setup

Use the arrow keys to highlight items, press **ENTER** to select, use the PageUp and PageDown keys to change entries, press **F1** for help and press **ESC** to quit. Navigation keys are shown in the following table.

Key	Function
Up arrow	Move to previous item
Down arrow	Move to next item
Left arrow	Move to the item on the left hand side
Right arrow	Move to the item on the right hand side
+	Increase the numeric value or make changes
-	Decrease the numeric value or make changes
Esc	Main Menu – Quit and not save changes into CMOS Status Page Setup Menu and Option Page Setup Menu -- Exit current page and return to Main Menu

Key	Function
F1	General help, only for Status Page Setup Menu and Option Page Setup Menu
F2	Load previous values
F3	Load optimized defaults
F4	Save changes and Exit BIOS

Table 5-1: BIOS Navigation Keys

5.1.3 Getting Help

When **F1** is pressed, a small help window describing the appropriate keys to use and the possible selections for the highlighted item appears. To exit the Help Window, press **Esc**.

5.1.4 Unable to Reboot after Configuration Changes

If the computer cannot boot after changes to the system configuration is made, CMOS defaults. Use the clear CMOS button described in **Chapter 4**.

5.1.5 BIOS Menu Bar

The **menu bar** on top of the BIOS screen has the following main items:

- Main – Changes the basic system configuration.
- Advanced – Changes the advanced system settings.
- Chipset – Changes the chipset settings.
- Security – Sets User and Supervisor Passwords.
- Boot – Changes the system boot configuration.
- Save & Exit – Selects exit options and loads default settings

The following sections completely describe the configuration options found in the menu items at the top of the BIOS screen and listed above.

WAFER-ULT3/ULT4 3.5" SBC

5.2 Main

The **Main** BIOS menu (**BIOS Menu 1**) appears when the **BIOS Setup** program is entered.

The **Main** menu gives an overview of the basic system information.

Aptio Setup Utility - Copyright (C) 2017 American Megatrends, Inc.					
Main	Advanced	Chipset	Security	Boot	Save & Exit
BIOS Information				Set the Date. Use Tab to switch between Date elements.	
BIOS Vendor	American Megatrends				
Core Version	5.12				
Compliancy	UEFI 2.6; PI 1.4				
Project Version	B456AR10.ROM				
Build Date and Time	08/10/2017 18:07:06				
iWDD Vendor		iEi			
iWDD Version		B456ER10.bin			
Processor Information					
Name	SkyLake ULT				
Type	Intel(R) Core(TM) i5-6300U CPU @ 2.40GHz				
Speed	2500 MHz				
ID	0x406E3				
Stepping	D0/K0				
Number of Processors	2Core(s) / 4Thread(s)				
Microcode Revision	BA				
GT Info	GT2 (0x1916)				
IGFX VBIOS Version		1049			
Memory RC Version		2.0.0.6			
Total Memory		4096 MB			
Memory Frequency		1600 MHz			
PCH Information					
Name	SKL PCH-LP				
PCH SKU	(U) Premium SKU				
Stepping	C1				
LAN PHY Revision	A6 (B2 Stepping)				
ME FW Version		11.6.29.3287			
ME Firmware SKU		Corporate SKU			
SPI Clock Frequency					
Dual Output Fast Read support		Not supported			
Read ID/Status Clock Freq		17 MHz			
Write and Erase Clock Freq		48 MHz			
Fast Read Clock Freq		48 MHz			
System Date		[Mon 10/02/2017]			
System Time		[15:10:27]			
Access Level		Administrator			

→←: Select Screen					
↑↓: Select Item					
Enter: Select					
+/-: Change Opt.					
F1: General Help					
F2: Previous Values					
F3: Optimized Defaults					
F4: Save & Exit					
ESC: Exit					
Version 2.18.1263. Copyright (C) 2017 American Megatrends, Inc.					

BIOS Menu 1: Main

The Main menu has two user configurable fields:

→ **System Date [xx/xx/xx]**

Use the **System Date** option to set the system date. Manually enter the day, month and year.

→ **System Time [xx:xx:xx]**

Use the **System Time** option to set the system time. Manually enter the hours, minutes and seconds.

5.3 Advanced

Use the **Advanced** menu (**BIOS Menu 2**) to configure the CPU and peripheral devices through the following sub-menus:



WARNING:

Setting the wrong values in the sections below may cause the system to malfunction. Make sure that the settings made are compatible with the hardware.

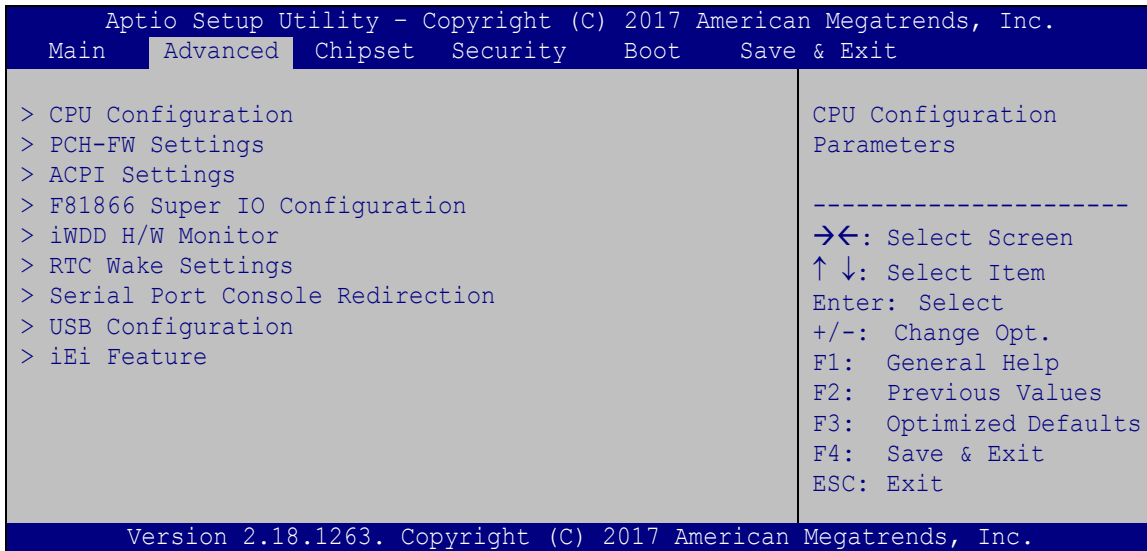

BIOS Menu 2: Advanced

WAFER-ULT3/ULT4 3.5" SBC

5.3.1 CPU Configuration

Use the **CPU Configuration** menu (**BIOS Menu 3**) to view detailed CPU specifications.

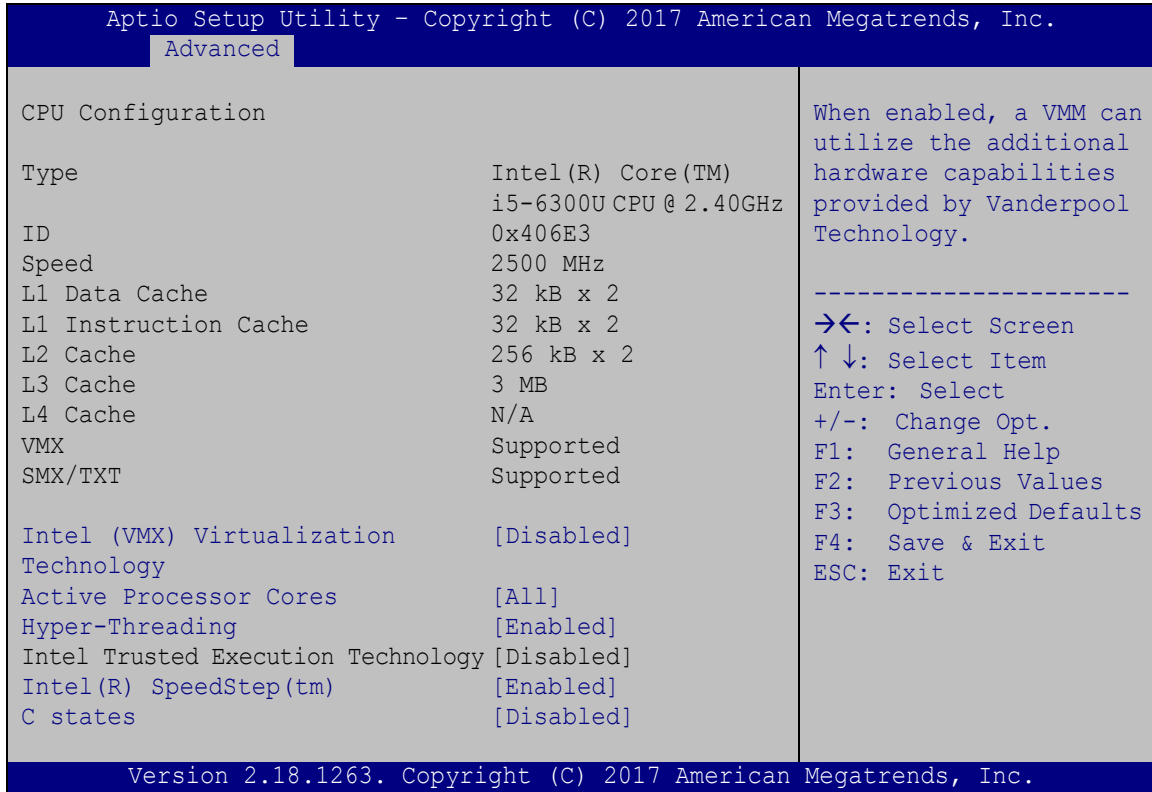

BIOS Menu 3: CPU Configuration

→ Intel (VMX) Virtualization Technology [Disabled]

Use the **Intel (VMX) Virtualization Technology** option to enable or disable virtualization on the system. When combined with third party software, Intel® Virtualization technology allows several OSs to run on the same system at the same time.

- **Disabled** **DEFAULT** Disables Intel Virtualization Technology.
- **Enabled** Enables Intel Virtualization Technology.

→ Active Processor Cores [All]

Use the **Active Processor Cores** BIOS option to enable numbers of cores in the processor package.

- **All** **DEFAULT** Enable all cores in the processor package.
- **1** Enable one core in the processor package.

→ **Hyper-threading [Enabled]**

Use the **Hyper-threading** BIOS option to enable or disable the Intel Hyper-Threading Technology.

- **Disabled** Disables the Intel Hyper-Threading Technology.
- **Enabled** **DEFAULT** Enables the Intel Hyper-Threading Technology.

→ **Intel® SpeedStep™ [Enabled]**

Use the **Intel® SpeedStep™** option to enable or disable the Intel® SpeedStep Technology.

- **Disabled** Disables the Intel® SpeedStep Technology.
- **Enabled** **DEFAULT** Enables the Intel® SpeedStep Technology.

→ **C State [Disabled]**

Use the **C State** option to enable or disable CPU C state.

- **Disabled** **DEFAULT** Disables CPU C state.
- **Enabled** Enables CPU C state.

WAFER-ULT3/ULT4 3.5" SBC

5.3.2 PCH-FW Configuration

The **PCH-FW Configuration** menu (**BIOS Menu 4**) allows configuration of the Management Engine parameters.

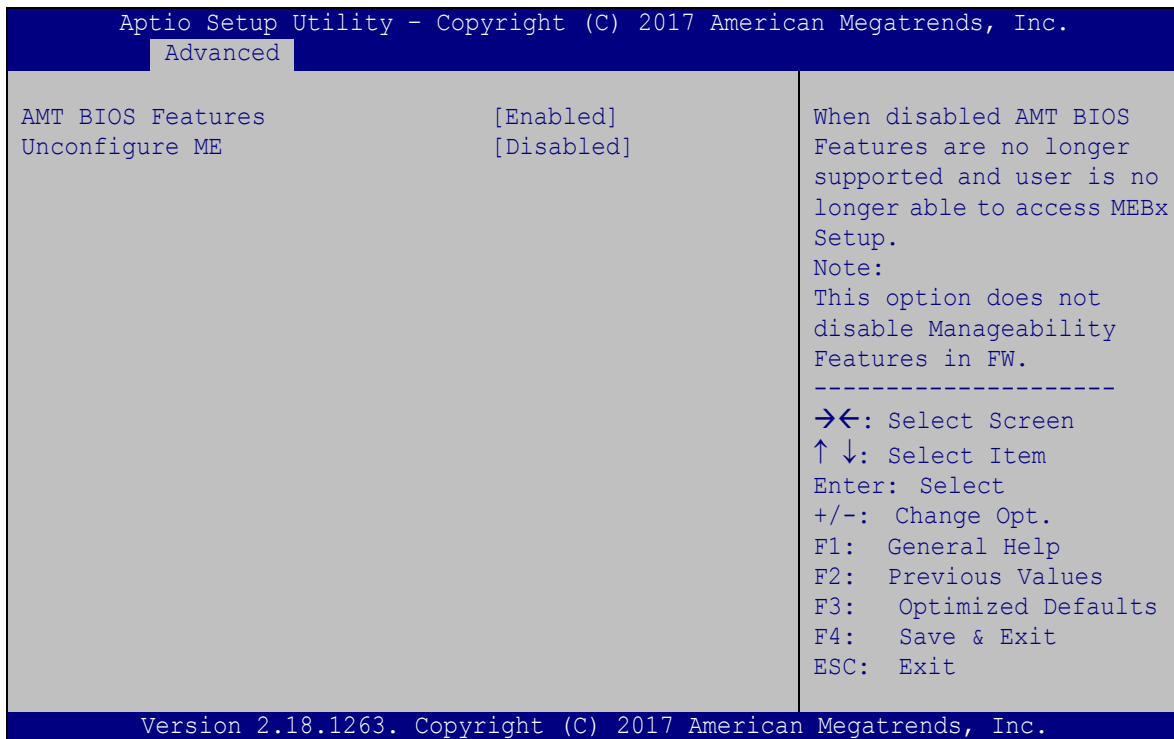

BIOS Menu 4: PCH-FW Configuration

→ AMT BIOS Features [Enabled]

Use **AMT BIOS Features** option to enable or disable the AMT BIOS features.

- **Disabled** AMT BIOS features are not supported
- **Enabled** **DEFAULT** AMT BIOS features are enabled

→ Unconfigure ME [Disabled]

Use the **Unconfigure ME** option to perform ME unconfigure without password operation.

- **Disabled** **DEFAULT** Not perform ME unconfigure
- **Enabled** To perform ME unconfigure

5.3.3 ACPI Settings

The **ACPI Settings** menu (**BIOS Menu 5**) configures the Advanced Configuration and Power Interface (ACPI) options.

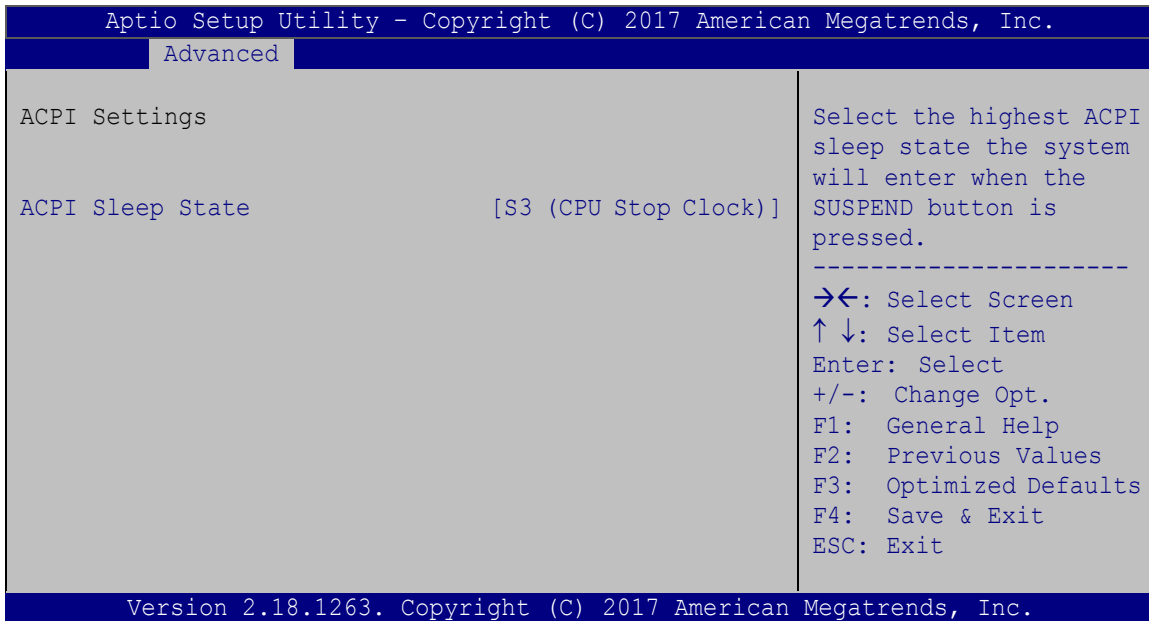

BIOS Menu 5: ACPI Settings

→ ACPI Sleep State [S3 (Suspend to RAM)]

Use the **ACPI Sleep State** option to specify the sleep state the system enters when it is not being used.

- **S3 (Suspend to RAM)** **DEFAULT** The caches are flushed and the CPU is powered off. Power to the RAM is maintained. The computer returns slower to a working state, but more power is saved.

WAFER-ULT3/ULT4 3.5" SBC

5.3.4 F81866 Super IO Configuration

Use the **F81866 Super IO Configuration** menu (**BIOS Menu 6**) to set or change the configurations for the serial ports.

```

Aptio Setup Utility - Copyright (C) 2017 American Megatrends, Inc.
  Advanced
F81866 Super IO Configuration                               Set Parameters of Serial
                                                           Port 1 (COMA)
Super IO Chip                                             F81866
> Serial Port 1 Configuration
> Serial Port 2 Configuration
                                                           -----
                                                           →←: Select Screen
                                                           ↑↓: Select Item
                                                           Enter: Select
                                                           +/-: Change Opt.
                                                           F1: General Help
                                                           F2: Previous Values
                                                           F3: Optimized Defaults
                                                           F4: Save & Exit
                                                           ESC: Exit
Version 2.18.1263. Copyright (C) 2017 American Megatrends, Inc.
    
```

BIOS Menu 6: F81866 Super IO Configuration

5.3.4.1 Serial Port n Configuration

Use the **Serial Port n Configuration** menu (**BIOS Menu 7**) to configure the serial port n.

```

Aptio Setup Utility - Copyright (C) 2017 American Megatrends, Inc.
  Advanced
Serial Port n Configuration                               Enable or Disable Serial
                                                           Port (COM)
Serial Port                                             [Enabled]
Device Settings                                         IO=3F8h; IRQ=4
                                                           -----
Change Settings                                         [Auto]
Device Mode                                             [RS232]
                                                           -----
                                                           →←: Select Screen
                                                           ↑↓: Select Item
                                                           Enter: Select
                                                           +/-: Change Opt.
                                                           F1: General Help
                                                           F2: Previous Values
                                                           F3: Optimized Defaults
                                                           F4: Save & Exit
                                                           ESC: Exit
Version 2.18.1263. Copyright (C) 2017 American Megatrends, Inc.
    
```

BIOS Menu 7: Serial Port n Configuration Menu

5.3.4.1.1 Serial Port 1 Configuration

➔ **Serial Port [Enabled]**

Use the **Serial Port** option to enable or disable the serial port.

- ➔ **Disabled** Disable the serial port
- ➔ **Enabled DEFAULT** Enable the serial port

➔ **Change Settings [Auto]**

Use the **Change Settings** option to change the serial port IO port address and interrupt address.

- ➔ **Auto DEFAULT** The serial port IO port address and interrupt address are automatically detected.
- ➔ **IO=3F8h;
IRQ=4** Serial Port I/O port address is 3F8h and the interrupt address is IRQ4
- ➔ **IO=3F8h;
IRQ=3, 4,
5, 6, 7, 9,
10, 11, 12** Serial Port I/O port address is 3F8h and the interrupt address is IRQ3, 4, 5, 6, 7, 9, 10, 11, 12
- ➔ **IO=2F8h;
IRQ=3, 4,
5, 6, 7, 9,
10, 11, 12** Serial Port I/O port address is 2F8h and the interrupt address is IRQ3, 4, 5, 6, 7, 9, 10, 11, 12
- ➔ **IO=3E8h;
IRQ=3, 4,
5, 6, 7, 9,
10, 11, 12** Serial Port I/O port address is 3E8h and the interrupt address is IRQ3, 4, 5, 6, 7, 9, 10, 11, 12
- ➔ **IO=2E8h;
IRQ=3, 4,
5, 6, 7, 9,
10, 11, 12** Serial Port I/O port address is 2E8h and the interrupt address is IRQ3, 4, 5, 6, 7, 9, 10, 11, 12

WAFER-ULT3/ULT4 3.5" SBC

→ Device Mode [RS232]

Use the **Device Mode** option to select the Serial Port 1 signaling mode.

- **RS422** Serial Port 1 signaling mode is RS-422
- **RS232** **DEFAULT** Serial Port 1 signaling mode is RS-232
- **RS485** Serial Port 1 signaling mode is RS-485

5.3.4.1.2 Serial Port 2 Configuration

→ Serial Port [Enabled]

Use the **Serial Port** option to enable or disable the serial port.

- **Disabled** Disable the serial port
- **Enabled** **DEFAULT** Enable the serial port

→ Change Settings [Auto]

Use the **Change Settings** option to change the serial port IO port address and interrupt address.

- **Auto** **DEFAULT** The serial port IO port address and interrupt address are automatically detected.
- **IO=2F8h;
IRQ=3** Serial Port I/O port address is 2F8h and the interrupt address is IRQ3
- **IO=3F8h;
IRQ=3, 4,
5, 6, 7, 9,
10, 11, 12** Serial Port I/O port address is 3F8h and the interrupt address is IRQ3, 4, 5, 6, 7, 9, 10, 11, 12
- **IO=2F8h;
IRQ=3, 4,
5, 6, 7, 9,
10, 11, 12** Serial Port I/O port address is 2F8h and the interrupt address is IRQ3, 4, 5, 6, 7, 9, 10, 11, 12

- ➔ **IO=3E8h;** Serial Port I/O port address is 3E8h and the interrupt address is IRQ3, 4, 5, 6, 7, 9, 10, 11, 12
IRQ=3, 4,
5, 6, 7, 9,
10, 11, 12
- ➔ **IO=2E8h;** Serial Port I/O port address is 2E8h and the interrupt address is IRQ3, 4, 5, 6, 7, 9, 10, 11, 12
IRQ=3, 4,
5, 6, 7, 9,
10, 11, 12

➔ **Device Mode [RS232]**

Use the **Device Mode** option to select the Serial Port 2 signaling mode.

- ➔ **RS422** Serial Port 2 signaling mode is RS-422
- ➔ **RS232** **DEFAULT** Serial Port 2 signaling mode is RS-232
- ➔ **RS485** Serial Port 2 signaling mode is RS-485

5.3.5 iWDD H/W Monitor

The **iWDD H/W Monitor** menu (**BIOS Menu 8**) contains the fan configuration submenu and displays the system temperatures and voltages.

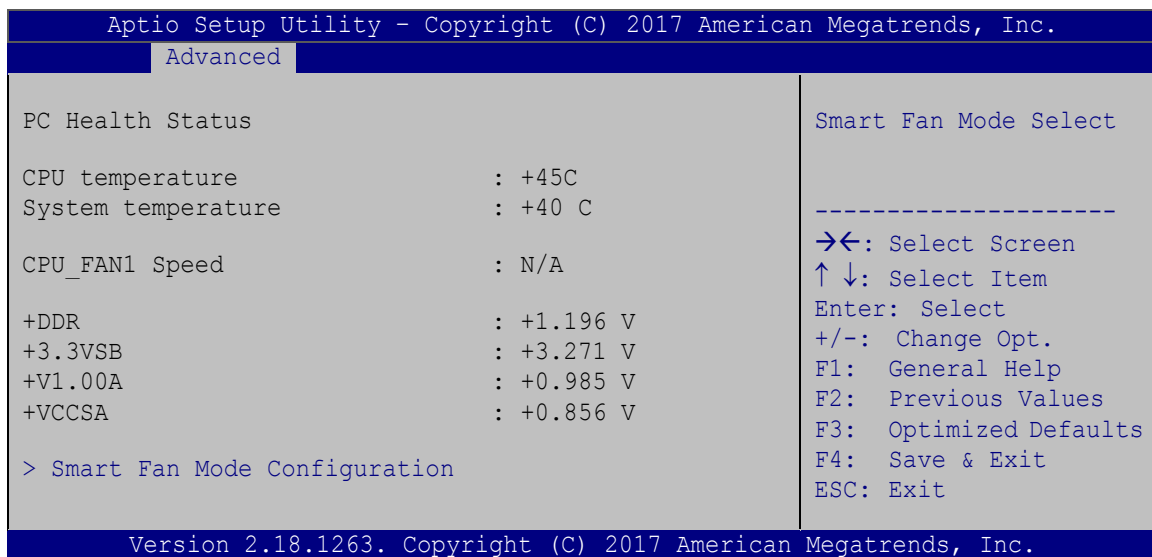

BIOS Menu 8: iWDD H/W Monitor

WAFER-ULT3/ULT4 3.5" SBC

5.3.5.1 Smart Fan Mode Configuration

Use the **Smart Fan Mode Configuration** submenu (**BIOS Menu 9**) to configure the smart fan temperature and speed settings.

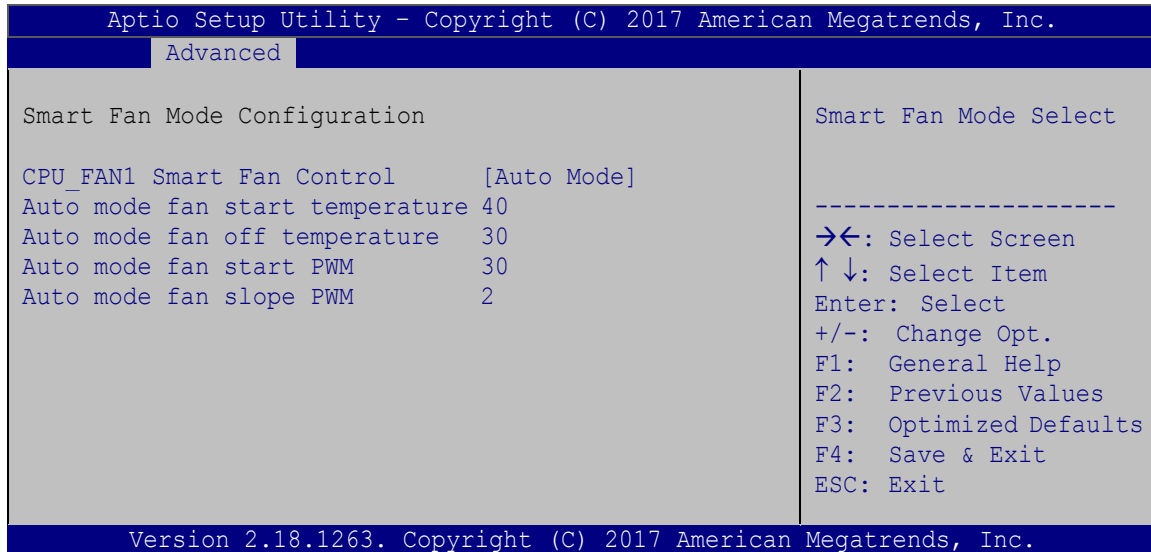

BIOS Menu 9: Smart Fan Mode Configuration

→ CPU_FAN1 Smart Fan Control [Auto Mode]

Use the **CPU_FAN1 Smart Fan Control** option to configure the system fan.

- **Manual Mode** The fan spins at the speed set in Manual PWM Setting settings.
- **Auto Mode** **DEFAULT** The fan adjusts its speed using Auto PWM Mode settings.

→ Auto mode fan start/off temperature

Use the + or – key to change the **Auto mode fan start/off temperature** value. Enter a decimal number between 1 and 100.

→ Auto mode fan start PWM

Use the + or – key to change the **Auto mode fan start PWM** value. Enter a decimal number between 1 and 100.

→ Auto mode fan slope PWM

Use the + or – key to change the **Auto mode fan slope PWM** value. Enter a decimal number between 1 and 8.

5.3.6 RTC Wake Settings

The **RTC Wake Settings** menu (**BIOS Menu 10**) enables the system to wake at the specified time.

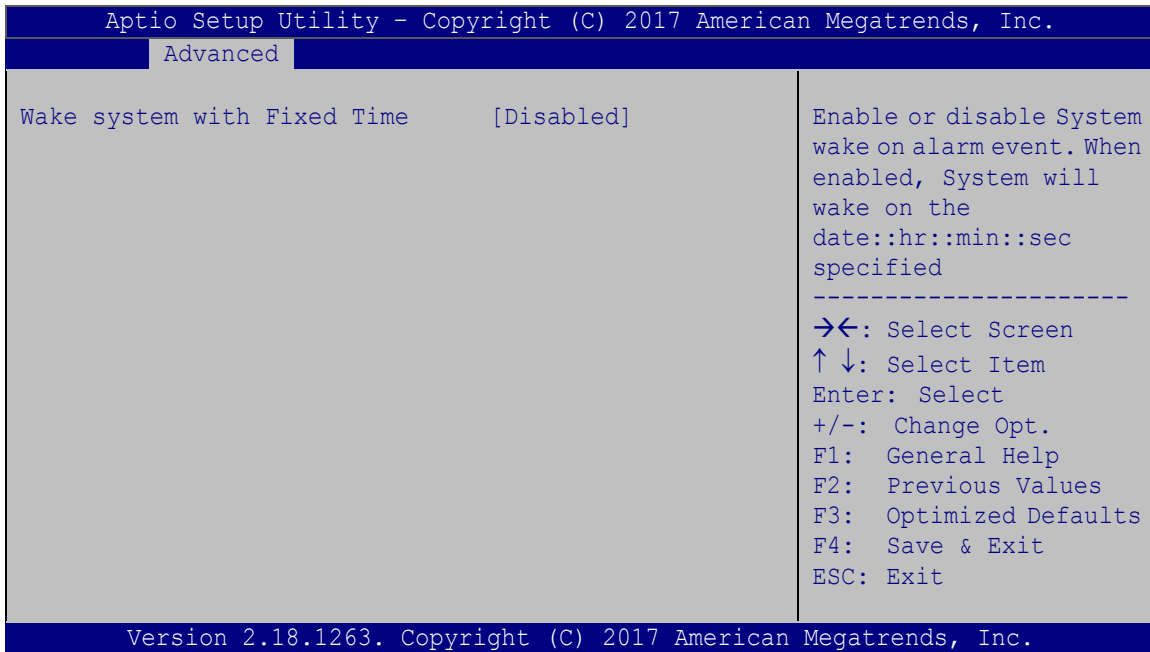

BIOS Menu 10: RTC Wake Settings

→ Wake system with Fixed Time [Disabled]

Use the **Wake system with Fixed Time** option to enable or disable the system wake on alarm event.

- **Disabled** **DEFAULT** The real time clock (RTC) cannot generate a wake event
- **Enabled** If selected, the **Wake up every day** option appears allowing you to enable to disable the system to wake every day at the specified time. Besides, the following options appear with values that can be selected:

Wake up every day

Wake up date

WAFER-ULT3/ULT4 3.5" SBC

Wake up hour

Wake up minute

Wake up second

After setting the alarm, the computer turns itself on from a suspend state when the alarm goes off.

5.3.7 Serial Port Console Redirection

The **Serial Port Console Redirection** menu (**BIOS Menu 11**) allows the console redirection options to be configured. Console redirection allows users to maintain a system remotely by re-directing keyboard input and text output through the serial port.

```

Aptio Setup Utility - Copyright (C) 2017 American Megatrends, Inc.
  Advanced
COM1
  Console Redirection          [Disabled]
> Console Redirection Settings
  Console Redirection          [Disabled]
> Console Redirection Settings
iAMT SOL
COM3(Pci Bus0,Dev22,Func3)
  Console Redirection          [Disabled]
> Console Redirection Settings
Legacy Console Redirection
> Legacy Console Redirection Settings

-----
-><: Select Screen
↑↓: Select Item
Enter: Select
+/-: Change Opt.
F1: General Help
F2: Previous Values
F3: Optimized Defaults
F4: Save & Exit
ESC: Exit

Version 2.18.1263. Copyright (C) 2017 American Megatrends, Inc.
  
```

BIOS Menu 11: Serial Port Console Redirection

➔ Console Redirection [Disabled]

Use **Console Redirection** option to enable or disable the console redirection function.

- ➔ **Disabled** **DEFAULT** Disabled the console redirection function
- ➔ **Enabled** Enabled the console redirection function

5.3.7.1 Console Redirection Settings

The **Console Redirection Settings** menu (**BIOS Menu 12**) allows the console redirection options to be configured. The option is active when **Console Redirection** option is enabled.

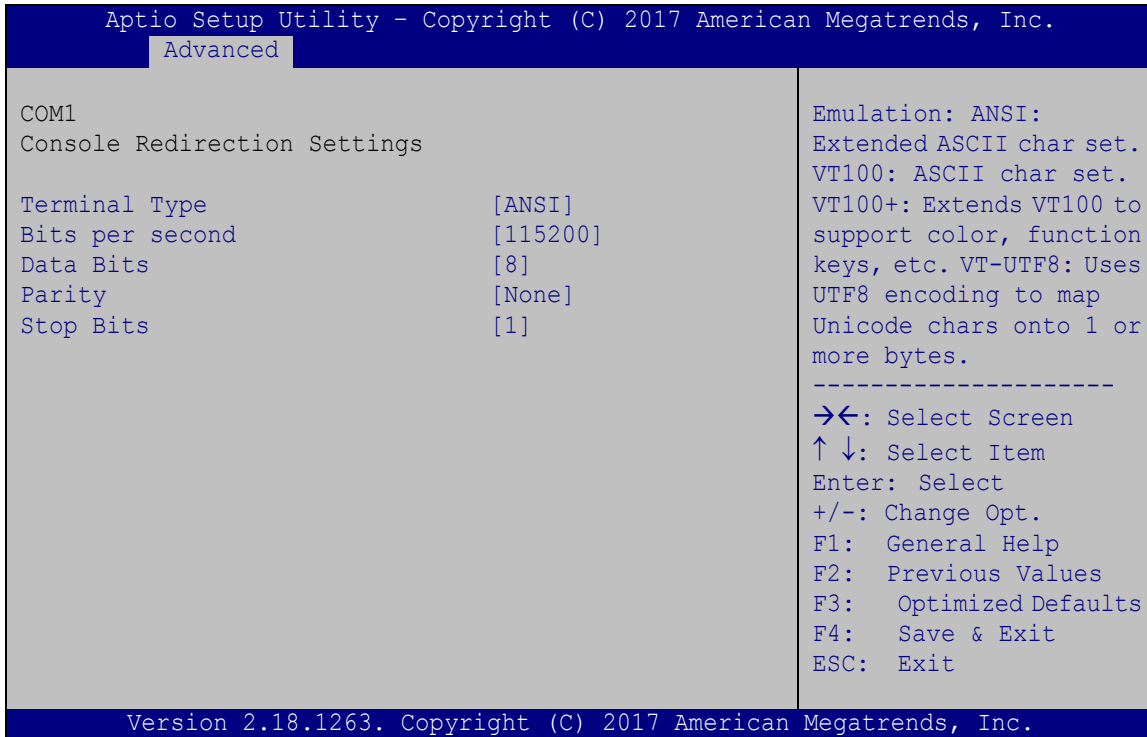

BIOS Menu 12: Console Redirection Settings

→ Terminal Type [ANSI]

Use the **Terminal Type** option to specify the remote terminal type.

- **VT100** The target terminal type is VT100
- **VT100+** The target terminal type is VT100+
- **VT-UTF8** The target terminal type is VT-UTF8
- **ANSI** **DEFAULT** The target terminal type is ANSI

WAFER-ULT3/ULT4 3.5" SBC

→ Bits per second [115200]

Use the **Bits per second** option to specify the serial port transmission speed. The speed must match the other side. Long or noisy lines may require lower speeds.

- | | | | |
|---|---------------|----------------|--|
| → | 9600 | | Sets the serial port transmission speed at 9600. |
| → | 19200 | | Sets the serial port transmission speed at 19200. |
| → | 57600 | | Sets the serial port transmission speed at 57600. |
| → | 115200 | DEFAULT | Sets the serial port transmission speed at 115200. |

→ Data Bits [8]

Use the **Data Bits** option to specify the number of data bits.

- | | | | |
|---|----------|----------------|--------------------------|
| → | 7 | | Sets the data bits at 7. |
| → | 8 | DEFAULT | Sets the data bits at 8. |

→ Parity [None]

Use the **Parity** option to specify the parity bit that can be sent with the data bits for detecting the transmission errors.

- | | | | |
|---|--------------|----------------|---|
| → | None | DEFAULT | No parity bit is sent with the data bits. |
| → | Even | | The parity bit is 0 if the number of ones in the data bits is even. |
| → | Odd | | The parity bit is 0 if the number of ones in the data bits is odd. |
| → | Mark | | The parity bit is always 1. This option does not provide error detection. |
| → | Space | | The parity bit is always 0. This option does not provide error detection. |

➔ Stop Bits [1]

Use the **Stop Bits** option to specify the number of stop bits used to indicate the end of a serial data packet. Communication with slow devices may require more than 1 stop bit.

- ➔ 1 **DEFAULT** Sets the number of stop bits at 1.
- ➔ 2 Sets the number of stop bits at 2.

5.3.7.2 Legacy Console Redirection Settings

The **Legacy Console Redirection Settings** menu (**BIOS Menu 13**) allows the legacy console redirection options to be configured.

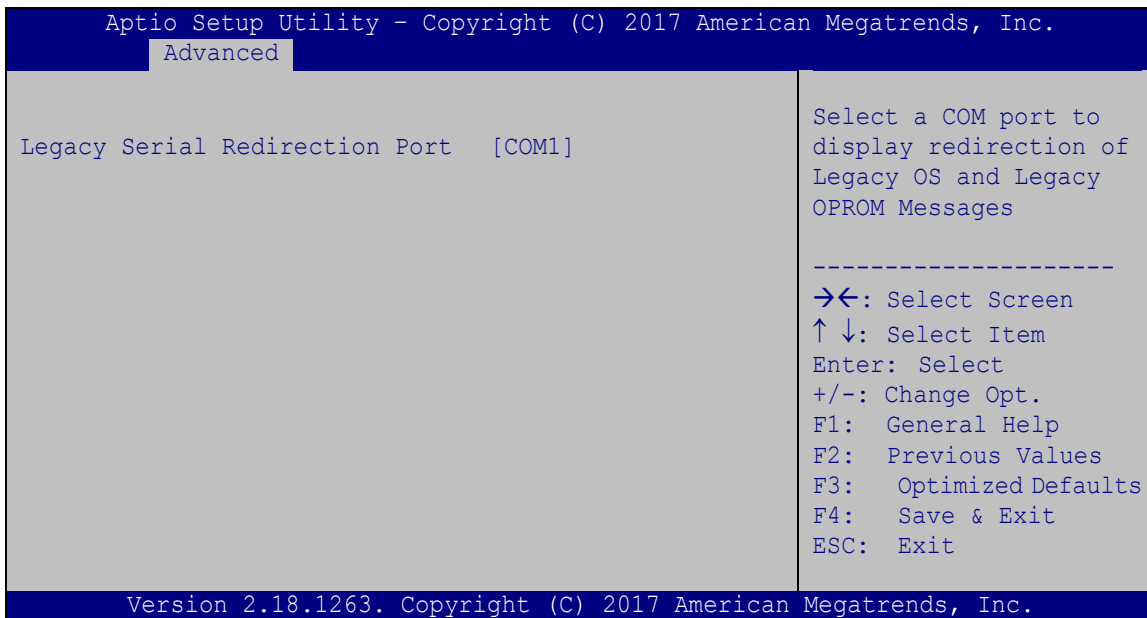

BIOS Menu 13: Legacy Console Redirection Settings

➔ Legacy Serial Redirection Port [COM1]

Use the **Legacy Serial Redirection Port** option to specify a COM port to display redirection of legacy OS and legacy OPROM messages. The options include:

- COM1 **DEFAULT**
- COM2
- COM3 (Pci Bus0, Dev22, Func3) (Disabled)

WAFER-ULT3/ULT4 3.5" SBC

5.3.8 USB Configuration

Use the **USB Configuration** menu (**BIOS Menu 14**) to read USB configuration information and configure the USB settings.

```

Aptio Setup Utility - Copyright (C) 2017 American Megatrends, Inc.
  Advanced
USB Configuration
USB Controllers:
  1 XHCI
USB Devices:
  1 Keyboard
Legacy USB Support           [Enabled]

-----
-><: Select Screen
↑ ↓: Select Item
Enter: Select
+/-: Change Opt.
F1: General Help
F2: Previous Values
F3: Optimized Defaults
F4: Save & Exit
ESC: Exit

Version 2.18.1263. Copyright (C) 2017 American Megatrends, Inc.
  
```

BIOS Menu 14: USB Configuration

➔ USB Devices

The **USB Devices** field lists the USB devices that are enabled on the system

➔ Legacy USB Support [Enabled]

Use the **Legacy USB Support** BIOS option to enable USB mouse and USB keyboard support.

Normally if this option is not enabled, any attached USB mouse or USB keyboard does not become available until a USB compatible operating system is fully booted with all USB drivers loaded. When this option is enabled, any attached USB mouse or USB keyboard can control the system even when there is no USB driver loaded onto the system.

- ➔ **Enabled** **DEFAULT** Legacy USB support enabled
- ➔ **Disabled** Legacy USB support disabled
- ➔ **Auto** Legacy USB support disabled if no USB devices are connected

5.3.9 iEi Feature

Use the **iEi Feature** menu (**BIOS Menu 15**) to configure One Key Recovery function.

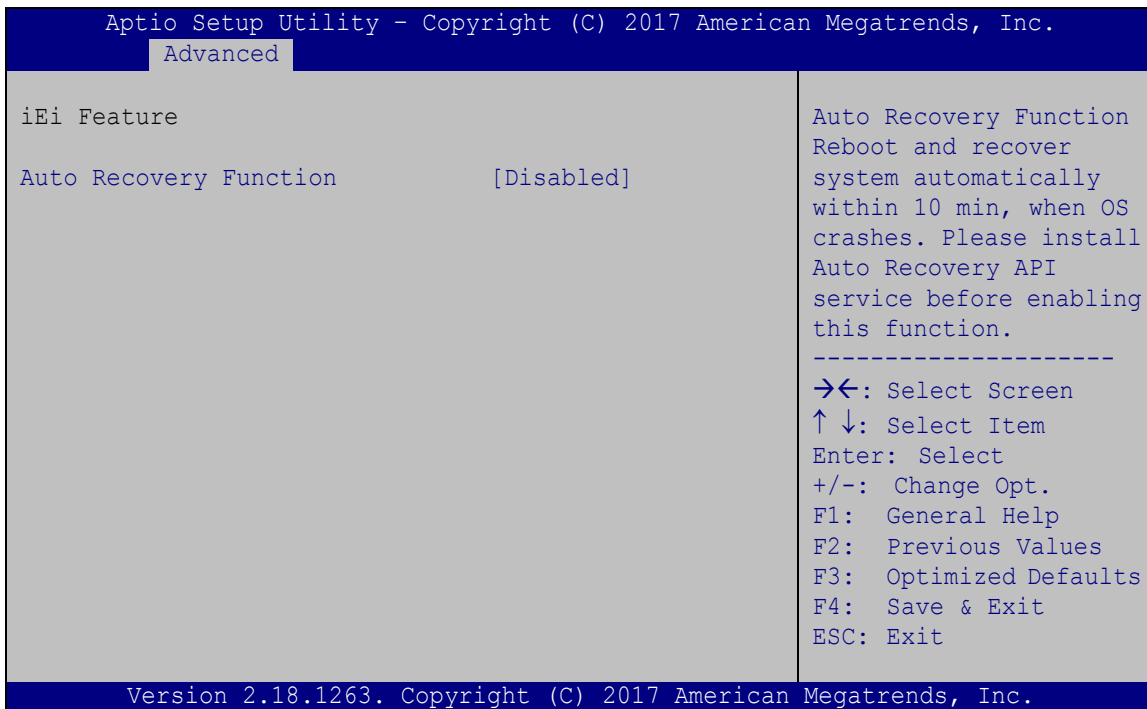

BIOS Menu 15: iEi Feature

➔ **Auto Recovery Function [Disabled]**

Use the **Auto Recovery Function** BIOS option to enable or disable the auto recovery function of the IEI One Key Recovery.

- ➔ **Disabled** **DEFAULT** Auto recovery function disabled
- ➔ **Enabled** Auto recovery function enabled

WAFER-ULT3/ULT4 3.5" SBC

5.4 Chipset

Use the **Chipset** menu (**BIOS Menu 16**) to access the PCH-IO and System Agent (SA) configuration menus.

```

Aptio Setup Utility - Copyright (C) 2017 American Megatrends, Inc.
Main   Advanced  Chipset  Security  Boot   Save & Exit

> System Agent (SA) Configuration
> PCH-IO Configuration

System Agent (SA)
Parameters

-----
-><: Select Screen
↑ ↓: Select Item
Enter: Select
+/-: Change Opt.
F1: General Help
F2: Previous Values
F3: Optimized Defaults
F4: Save & Exit
ESC: Exit

Version 2.18.1263. Copyright (C) 2017 American Megatrends, Inc.
  
```

BIOS Menu 16: Chipset

5.4.1 System Agent (SA) Configuration

Use the **System Agent (SA) Configuration** menu (**BIOS Menu 17**) to display the memory information.

```

Aptio Setup Utility - Copyright (C) 2017 American Megatrends, Inc.
Chipset

System Agent (SA) Configuration
VT-d                Supported
VT-d                [Disabled]

> Memory Configuration
> Graphics Configuration

VT-d capability

-----
-><: Select Screen
↑ ↓: Select Item
Enter: Select
+/-: Change Opt.
F1: General Help
F2: Previous Values
F3: Optimized Defaults
F4: Save & Exit
ESC: Exit

Version 2.18.1263. Copyright (C) 2017 American Megatrends, Inc.
  
```

BIOS Menu 17: System Agent (SA) Configuration

→ VT-d [Disabled]

Use the VT-d option to enable or disable VT-d support.

- Disabled **DEFAULT** Disables VT-d support.
- Enabled Enables VT-d support.

5.4.1.1 Memory Configuration

Use the **Memory Configuration** submenu (**BIOS Menu 18**) to view memory information.

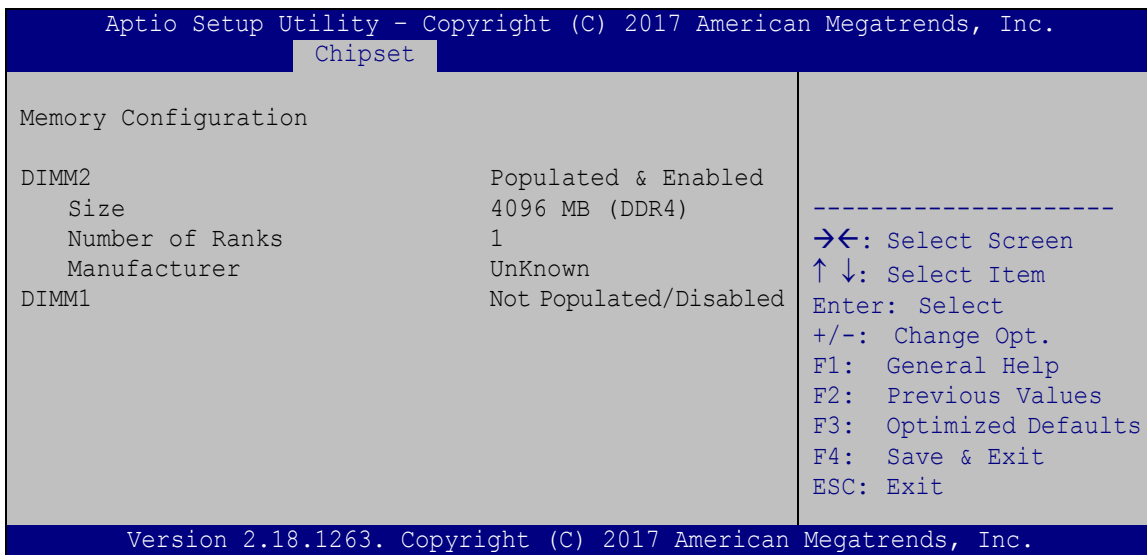

BIOS Menu 18: Memory Configuration

WAFER-ULT3/ULT4 3.5" SBC

5.4.1.2 Graphics Configuration

Use the **Graphics Configuration (BIOS Menu 19)** menu to configure the video device connected to the system.

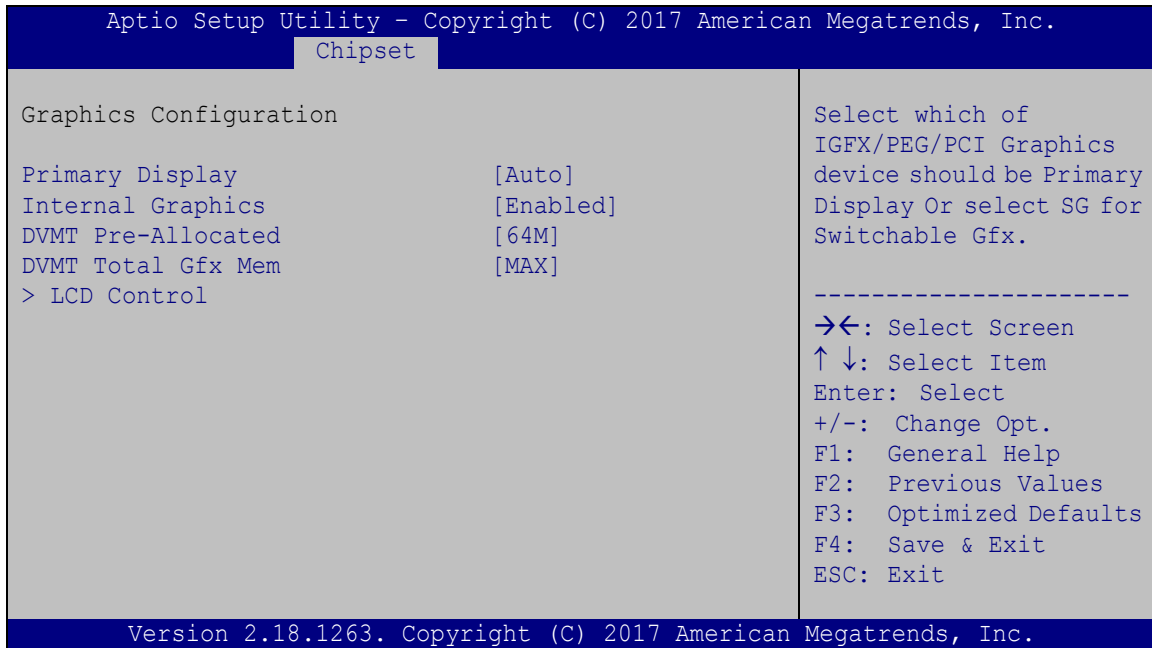

BIOS Menu 19: Graphics Configuration

→ Primary Display [Auto]

Use the **Primary Display** option to select the display device used by the system when it boots. Configuration options are listed below.

- Auto **DEFAULT**
- IGFX
- PCIE

→ Internal Graphics [Enabled]

Use the **Internal Graphics** option to enable or disable the internal graphics device.

- **Auto** The internal graphics device is automatically detected and enabled.
- **Disabled** Disable the internal graphics device.

→ **Enabled** **DEFAULT** Enable the internal graphics device. The following options/submenu appear with values that can be selected:

DVMT Pre-Allocated

DVMT Total Gfx Mem

LCD Control

→ **DVMT Pre-Allocated [64M]**

Use the **DVMT Pre-Allocated** option to set the amount of system memory allocated to the integrated graphics processor when the system boots. The system memory allocated can then only be used as graphics memory, and is no longer available to applications or the operating system. Configuration options are listed below:

- 32M
- 64M **Default**

→ **DVMT Total Gfx Mem [MAX]**

Use the **DVMT Total Gfx Mem** option to select DVMT5.0 total graphic memory size used by the internal graphic device. The following options are available:

- 256M
- 128M
- MAX **Default**

WAFER-ULT3/ULT4 3.5" SBC

5.4.1.2.1 LCD Control

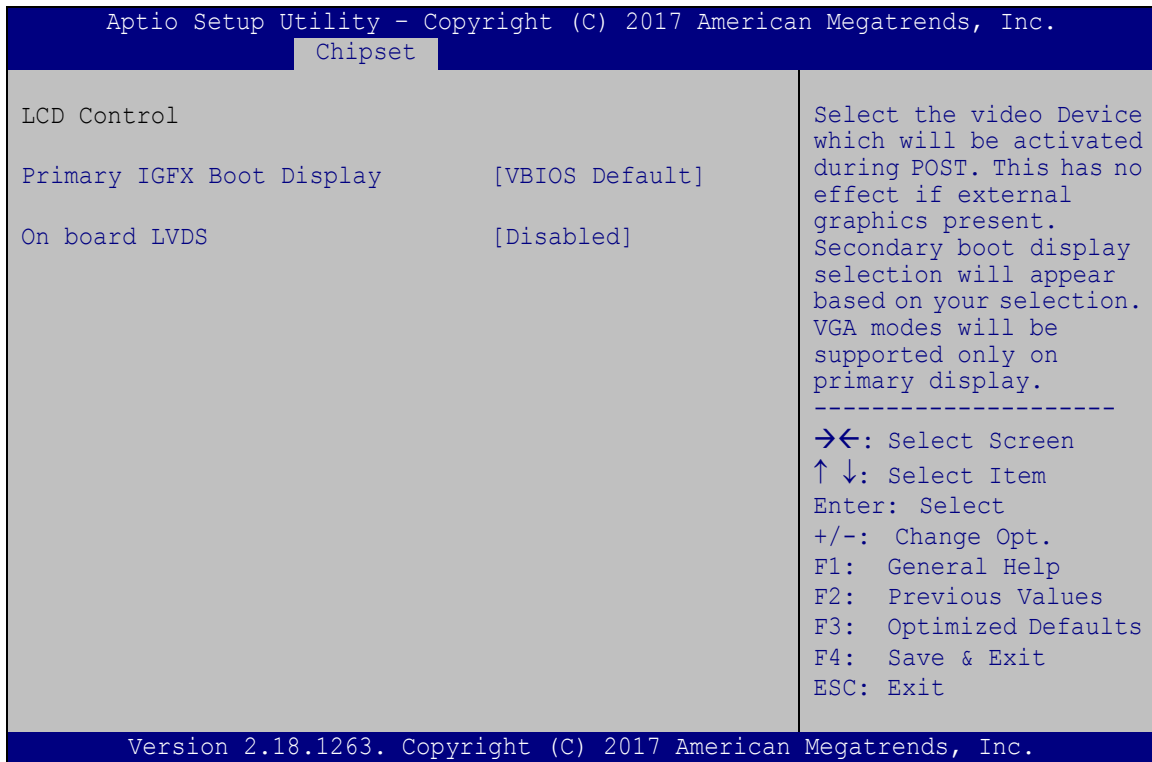

BIOS Menu 20: LCD Control

→ Primary IGFX Boot Display [VBIOS Default]

Use the **Primary IGFX Boot Display** option to select the display device used by the system when it boots. Configuration options are listed below.

- VBIOS Default **DEFAULT**
- HDMI
- LVDS
- VGA1/DP1

→ On board LVDS [Disabled]

Use the **On board LVDS** option enables or disables the on-board LVDS connector.

- **Disabled** **DEFAULT** The on-board LVDS connector is disabled.
- **Enabled** The on-board LVDS connector is disabled.



NOTE:

The following two options will be available to configure only when the **On board LVDS** option is set to **Enabled**.

→ **Backlight Control [LED(PWM)]**

Use the **Backlight Control** BIOS option to select the LCD backlight control type. Configuration options are listed below.

- LED(PWM) **DEFAULT**
- CCFL(DC)

→ **Backlight Control Voltage Level [3.3V]**

Use the **Backlight Control Voltage Level** BIOS option to select the LCD backlight dimming voltage level from **5.0V** or **3.3V**.

5.4.2 PCH-IO Configuration

Use the **PCH-IO Configuration** menu (**BIOS Menu 21**) to configure the PCH parameters.

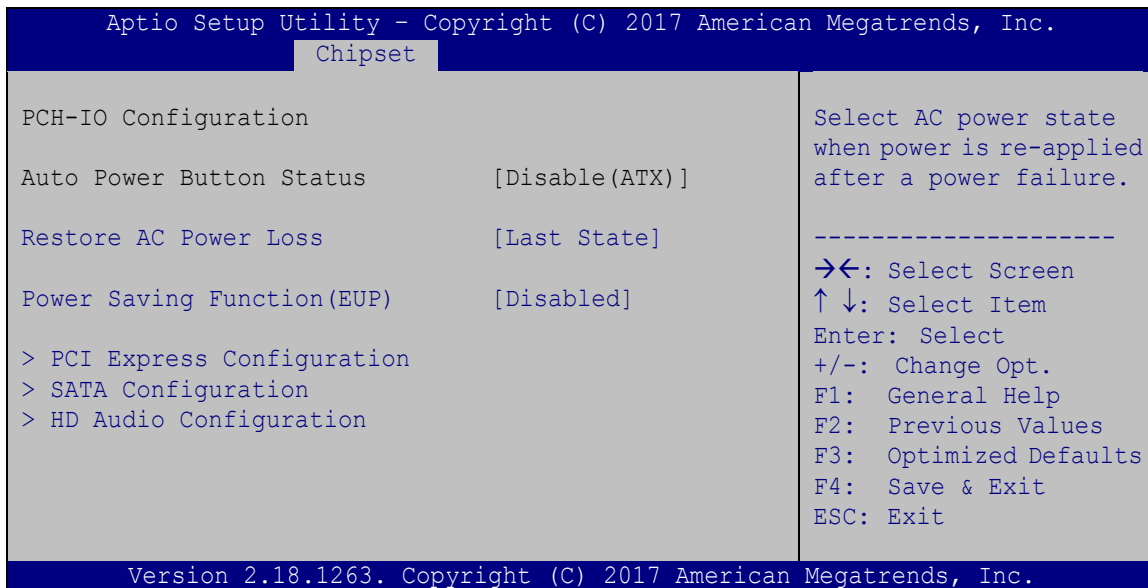

BIOS Menu 21: PCH-IO Configuration

WAFER-ULT3/ULT4 3.5" SBC

→ Restore AC Power Loss [Last State]

Use the **Restore AC Power Loss** BIOS option to specify what state the system returns to if there is a sudden loss of power to the system.

- **Power Off** The system remains turned off
- **Power On** The system turns on
- **Last State** **DEFAULT** The system returns to its previous state. If it was on, it turns itself on. If it was off, it remains off.

→ Power Saving Function(EUP) [Disabled]

Use the **Power Saving Function(EUP)** BIOS option to enable or disable the power saving function.

- **Disabled** **DEFAULT** Power saving function is disabled.
- **Enabled** Power saving function is enabled. It will reduce power consumption when the system is off.

5.4.2.1 PCI Express Configuration

Use the **PCI Express Configuration** menu (**BIOS Menu 22**) to configure the PCIe Mini slots.

```

Aptio Setup Utility - Copyright (C) 2017 American Megatrends, Inc.
Chipset
PCI Express Configuration
> MINI_PCIE1
> MINI_PCIE2

MINI_PCIE1 Settings.
-----
-><: Select Screen
↑↓: Select Item
Enter: Select
+/-: Change Opt.
F1: General Help
F2: Previous Values
F3: Optimized Defaults
F4: Save & Exit
ESC: Exit

Version 2.18.1263. Copyright (C) 2017 American Megatrends, Inc.
    
```

BIOS Menu 22: PCI Express Configuration

5.4.2.1.1 MINI_PcIe1/MINI_PcIe2

Use the **MINI_PcIe1/MINI_PcIe2** menu (**BIOS Menu 23**) to configure the PCIe Mini slot settings.



BIOS Menu 23: M_PCIE2 Configuration Menu

→ PCIe Speed [Auto]

Use this option to select the support type of the PCIe Mini slot. The following options are available:

- Auto **Default**
- Gen1
- Gen2
- Gen3

→ Detect Non-Compliance Device [Disabled]

Use the **Detect Non-Compliance Device** option to enable or disable detecting if a non-compliance PCI Express device is connected to the PCI Express slot.

→ **Disabled** **DEFAULT** Disables to detect if a non-compliance PCI Express device is connected to the PCI Express slot.

→ **Enabled** Enables to detect if a non-compliance PCI Express device is connected to the PCI Express slot.

WAFER-ULT3/ULT4 3.5" SBC

5.4.2.2 SATA Configuration

Use the **SATA Configuration** menu (**BIOS Menu 24**) to change and/or set the configuration of the SATA devices installed in the system.

```

Aptio Setup Utility - Copyright (C) 2017 American Megatrends, Inc.
  Advanced
SATA Configuration
STAT Controller(s)      [Enabled]
SATA Mode Selection    [AHCI]

SATA1                  Empty
  Hot Plug              [Disabled]
mSATA (MINI_PCIE2)    Empty
  Hot Plug              [Disabled]

Enable/Disable SATA Device.
-----
-><: Select Screen
↑↓: Select Item
Enter: Select
+/-: Change Opt.
F1: General Help
F2: Previous Values
F3: Optimized Defaults
F4: Save & Exit
ESC: Exit

Version 2.18.1263. Copyright (C) 2017 American Megatrends, Inc.
  
```

BIOS Menu 24: SATA Configuration

→ **STAT Controller(s) [Enabled]**

Use the **STAT Controller(s)** option to enable or disable the SATA device.

- **Enabled** **DEFAULT** Enables the SATA device.
- **Disabled** Disables the SATA device.

→ **SATA Mode Selection [AHCI]**

Use the **SATA Mode Selection** option to configure SATA devices as AHCI devices.

- **AHCI** **DEFAULT** Configures SATA devices as AHCI device.

→ **Hot Plug [Disabled]**

Use the **Hot Plug** option to enable or disable the SATA device hot plug.

- **Disabled** **DEFAULT** Disables the SATA device hot plug.
- **Enabled** Enables the SATA device hot plug

5.4.2.3 HD Audio Configuration

Use the **HD Audio Configuration** menu (**BIOS Menu 25**) to configure the HD Audio settings.

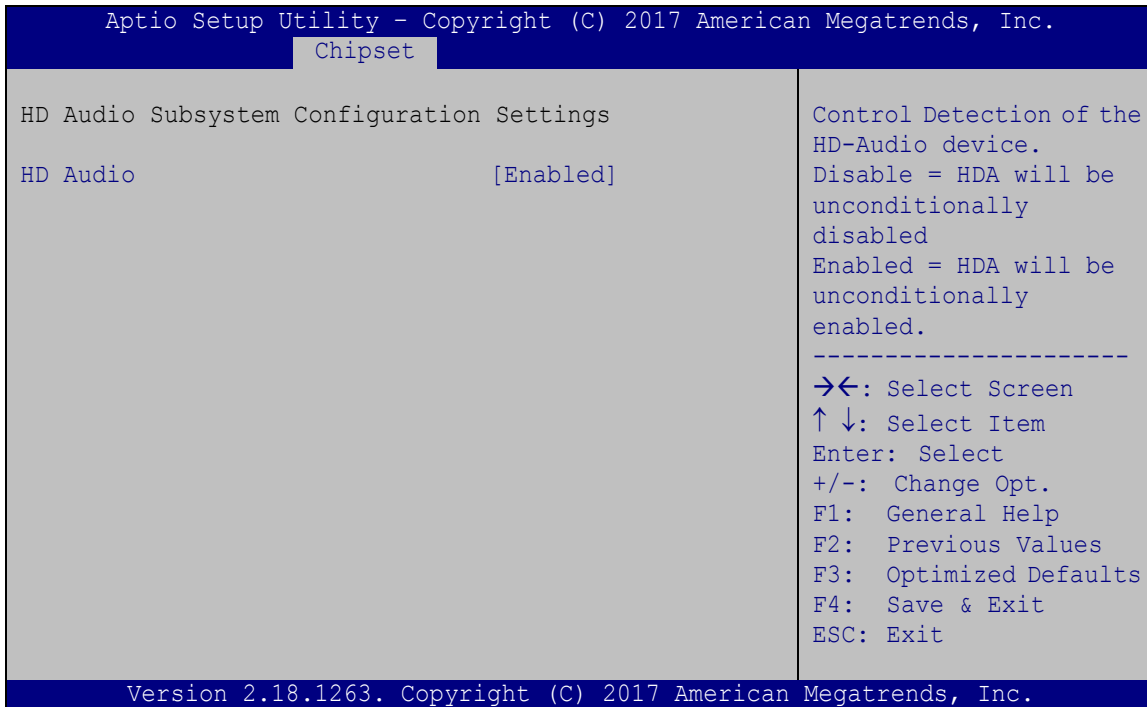

BIOS Menu 25: PCH Azalia Configuration

→ HD Audio [Enabled]

Use the **HD Audi**) option to enable or disable the High Definition Audio controller.

- **Disabled** The onboard High Definition Audio controller is disabled
- **Enabled DEFAULT** The onboard High Definition Audio controller automatically detected and enabled

WAFER-ULT3/ULT4 3.5" SBC

5.5 Security

Use the **Security** menu (**BIOS Menu 26**) to set system and user passwords.

```

Aptio Setup Utility - Copyright (C) 2017 American Megatrends, Inc.
Main   Advanced  Chipset  Security  Boot   Save & Exit

Password Description
-----
If ONLY the Administrator's password is set,
then this only limits access to Setup and is
only asked for when entering Setup.
If ONLY the User's password is set, then this
is a power on password and must be entered to
boot or enter Setup. In Setup the User will
have Administrator rights.
The password length must be
in the following range:
Minimum length           3
Maximum length          20

Administrator Password
User Password

Set Administrator
Password

-----
-><: Select Screen
↑↓: Select Item
Enter: Select
+/-: Change Opt.
F1: General Help
F2: Previous Values
F3: Optimized Defaults
F4: Save & Exit
ESC: Exit

Version 2.18.1263. Copyright (C) 2017 American Megatrends, Inc.

```

BIOS Menu 26: Security

→ Administrator Password

Use the **Administrator Password** to set or change an administrator password.

→ User Password

Use the **User Password** to set or change a user password.

5.6 Boot

Use the **Boot menu (BIOS Menu 27)** to configure system boot options.

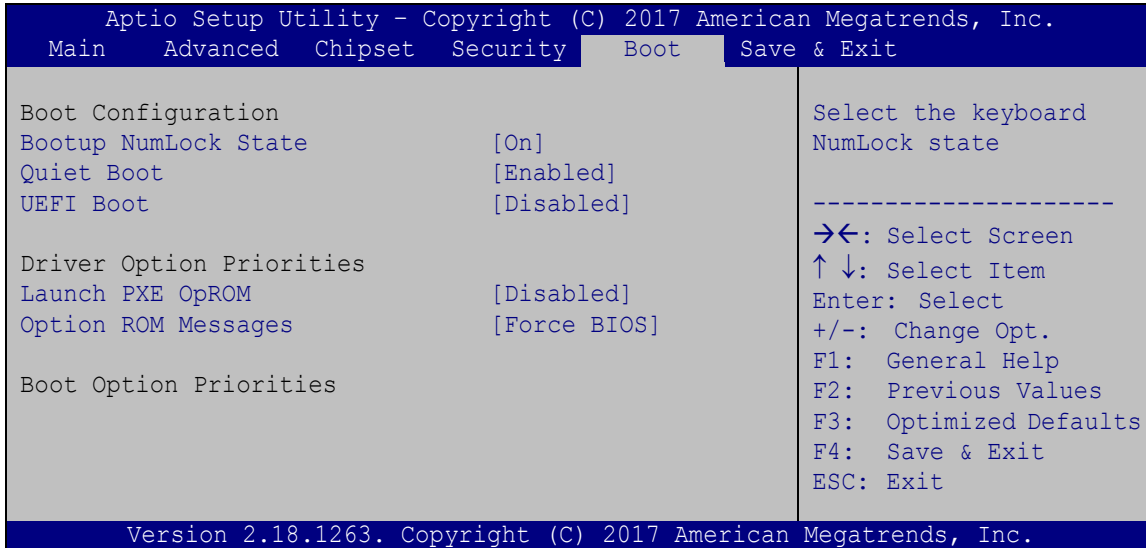

BIOS Menu 27: Boot

→ Bootup NumLock State [On]

Use the **Bootup NumLock State** BIOS option to specify if the number lock setting must be modified during boot up.

- **On** **DEFAULT** Allows the Number Lock on the keyboard to be enabled automatically when the computer system boots up. This allows the immediate use of the 10-key numeric keypad located on the right side of the keyboard. To confirm this, the Number Lock LED light on the keyboard is lit.

- **Off** Does not enable the keyboard Number Lock automatically. To use the 10-keys on the keyboard, press the Number Lock key located on the upper left-hand corner of the 10-key pad. The Number Lock LED on the keyboard lights up when the Number Lock is engaged.

WAFER-ULT3/ULT4 3.5" SBC

→ Quiet Boot [Enabled]

Use the **Quiet Boot** BIOS option to select the screen display when the system boots.

- **Disabled** Normal POST messages displayed
- **Enabled** **DEFAULT** OEM Logo displayed instead of POST messages

→ UEFI Boot [Disabled]

Use the **UEFI Boot** option to enable or disable to boot from the UEFI devices.

- **Enabled** Boot from UEFI devices is enabled.
- **Disabled** **DEFAULT** Boot from UEFI devices is disabled.

→ Launch PXE OpROM [Disabled]

Use the **Launch PXE OpROM** option to enable or disable boot option for legacy network devices.

- **Disabled** **DEFAULT** Ignore all PXE Option ROMs
- **Enabled** Load PXE Option ROMs.

→ Option ROM Messages [Force BIOS]

Use the **Option ROM Messages** option to set the Option ROM display mode.

- **Force BIOS** **DEFAULT** Sets display mode to force BIOS.
- **Keep Current** Sets display mode to current.

→ Boot Option Priorities

Use the **Boot Option Priorities** function to set the system boot sequence from the available devices. The drive sequence also depends on the boot sequence in the individual device section.

5.7 Save & Exit

Use the **Save & Exit** menu (**BIOS Menu 28**) to load default BIOS values, optimal failsafe values and to save configuration changes.

```
Aptio Setup Utility - Copyright (C) 2017 American Megatrends, Inc.
Main  Advanced  Chipset  Security  Boot  Save & Exit

Save Changes and Reset
Discard Changes and Reset

Restore Defaults
Save as User Defaults
Restore User Defaults

Reset the system after
saving the changes.

-----
-><: Select Screen
↑↓: Select Item
Enter: Select
+/-: Change Opt.
F1: General Help
F2: Previous Values
F3: Optimized Defaults
F4: Save & Exit
ESC: Exit

Version 2.18.1263. Copyright (C) 2017 American Megatrends, Inc.
```

BIOS Menu 28: Save & Exit

→ Save Changes and Reset

Use the **Save Changes and Reset** option to save the changes made to the BIOS options and reset the system.

→ Discard Changes and Reset

Use the **Discard Changes and Reset** option to exit the system without saving the changes made to the BIOS configuration setup program.

→ Restore Defaults

Use the **Restore Defaults** option to load the optimal default values for each of the parameters on the Setup menus. **F3 key can be used for this operation.**

→ Save as User Defaults

Use the **Save as User Defaults** option to save the changes done so far as user defaults.

→ Restore User Defaults

Use the **Restore User Defaults** option to restore the user defaults to all the setup options.

Appendix

A

Regulatory Compliance

DECLARATION OF CONFORMITY

This equipment has been tested and found to comply with specifications for CE marking. If the user modifies and/or installs other devices in the equipment, the CE conformity declaration may no longer apply.

FCC WARNING

This equipment complies with Part 15 of the FCC Rules. Operation is subject to the following two conditions:

- This device may not cause harmful interference, and
- This device must accept any interference received, including interference that may cause undesired operation.

This equipment has been tested and found to comply with the limits for a Class A digital device, pursuant to part 15 of the FCC Rules. These limits are designed to provide reasonable protection against harmful interference when the equipment is operated in a commercial environment. This equipment generates, uses, and can radiate radio frequency energy and, if not installed and used in accordance with the instruction manual, may cause harmful interference to radio communications. Operation of this equipment in a residential area is likely to cause harmful interference in which case the user will be required to correct the interference at his own expense.

Appendix

B

BIOS Options

Below is a list of BIOS configuration options in the BIOS chapter.

<input type="checkbox"/>	System Date [xx/xx/xx]	74
<input type="checkbox"/>	System Time [xx:xx:xx]	74
<input type="checkbox"/>	Intel (VMX) Virtualization Technology [Disabled]	75
<input type="checkbox"/>	Active Processor Cores [All]	75
<input type="checkbox"/>	Hyper-threading [Enabled]	76
<input type="checkbox"/>	Intel® SpeedStep™ [Enabled]	76
<input type="checkbox"/>	C State [Disabled]	76
<input type="checkbox"/>	AMT BIOS Features [Enabled]	77
<input type="checkbox"/>	Unconfigure ME [Disabled]	77
<input type="checkbox"/>	ACPI Sleep State [S3 (Suspend to RAM)]	78
<input type="checkbox"/>	Serial Port [Enabled]	80
<input type="checkbox"/>	Change Settings [Auto]	80
<input type="checkbox"/>	Device Mode [RS232]	81
<input type="checkbox"/>	Serial Port [Enabled]	81
<input type="checkbox"/>	Change Settings [Auto]	81
<input type="checkbox"/>	Device Mode [RS232]	82
<input type="checkbox"/>	CPU_FAN1 Smart Fan Control [Auto Mode]	83
<input type="checkbox"/>	Auto mode fan start/off temperature	83
<input type="checkbox"/>	Auto mode fan start PWM	83
<input type="checkbox"/>	Auto mode fan slope PWM	83
<input type="checkbox"/>	Wake system with Fixed Time [Disabled]	84
<input type="checkbox"/>	Console Redirection [Disabled]	85
<input type="checkbox"/>	Terminal Type [ANSI]	86
<input type="checkbox"/>	Bits per second [115200]	87
<input type="checkbox"/>	Data Bits [8]	87
<input type="checkbox"/>	Parity [None]	87
<input type="checkbox"/>	Stop Bits [1]	88
<input type="checkbox"/>	Legacy Serial Redirection Port [COM1]	88
<input type="checkbox"/>	USB Devices	89
<input type="checkbox"/>	Legacy USB Support [Enabled]	89
<input type="checkbox"/>	Auto Recovery Function [Disabled]	90
<input type="checkbox"/>	VT-d [Disabled]	92
<input type="checkbox"/>	Primary Display [Auto]	93

WAFER-ULT3/ULT4 3.5" SBC

<input type="checkbox"/>	Internal Graphics [Enabled]	93
<input type="checkbox"/>	DVMT Pre-Allocated [64M]	94
<input type="checkbox"/>	DVMT Total Gfx Mem [MAX]	94
<input type="checkbox"/>	Primary IGFX Boot Display [VBIOS Default]	95
<input type="checkbox"/>	On board LVDS [Disabled]	95
<input type="checkbox"/>	Backlight Control [LED(PWM)]	96
<input type="checkbox"/>	Backlight Control Voltage Level [3.3V]	96
<input type="checkbox"/>	Restore AC Power Loss [Last State]	97
<input type="checkbox"/>	Power Saving Function(EUP) [Disabled]	97
<input type="checkbox"/>	PCIe Speed [Auto]	98
<input type="checkbox"/>	Detect Non-Compliance Device [Disabled]	98
<input type="checkbox"/>	STAT Controller(s) [Enabled]	99
<input type="checkbox"/>	SATA Mode Selection [AHCI]	99
<input type="checkbox"/>	Hot Plug [Disabled]	99
<input type="checkbox"/>	HD Audio [Enabled]	100
<input type="checkbox"/>	Administrator Password	101
<input type="checkbox"/>	User Password	101
<input type="checkbox"/>	Bootup NumLock State [On]	102
<input type="checkbox"/>	Quiet Boot [Enabled]	103
<input type="checkbox"/>	UEFI Boot [Disabled]	103
<input type="checkbox"/>	Launch PXE OpROM [Disabled]	103
<input type="checkbox"/>	Option ROM Messages [Force BIOS]	103
<input type="checkbox"/>	Boot Option Priorities	103
<input type="checkbox"/>	Save Changes and Reset	104
<input type="checkbox"/>	Discard Changes and Reset	104
<input type="checkbox"/>	Restore Defaults	104
<input type="checkbox"/>	Save as User Defaults	104
<input type="checkbox"/>	Restore User Defaults	104

Appendix

C

Terminology

WAFER-ULT3/ULT4 3.5" SBC

AC '97	Audio Codec 97 (AC'97) refers to a codec standard developed by Intel® in 1997.
ACPI	Advanced Configuration and Power Interface (ACPI) is an OS-directed configuration, power management, and thermal management interface.
AHCI	Advanced Host Controller Interface (AHCI) is a SATA Host controller register-level interface.
ATA	The Advanced Technology Attachment (ATA) interface connects storage devices including hard disks and CD-ROM drives to a computer.
ARMD	An ATAPI Removable Media Device (ARMD) is any ATAPI device that supports removable media, besides CD and DVD drives.
ASKIR	Amplitude Shift Keyed Infrared (ASKIR) is a form of modulation that represents a digital signal by varying the amplitude ("volume") of the signal. A low amplitude signal represents a binary 0, while a high amplitude signal represents a binary 1.
BIOS	The Basic Input/Output System (BIOS) is firmware that is first run when the computer is turned on and can be configured by the end user
CODEC	The Compressor-Decompressor (CODEC) encodes and decodes digital audio data on the system.
CMOS	Complimentary metal-oxide-conductor is an integrated circuit used in chips like static RAM and microprocessors.
COM	COM refers to serial ports. Serial ports offer serial communication to expansion devices. The serial port on a personal computer is usually a male DB-9 connector.
DAC	The Digital-to-Analog Converter (DAC) converts digital signals to analog signals.
DDR	Double Data Rate refers to a data bus transferring data on both the rising and falling edges of the clock signal.
DMA	Direct Memory Access (DMA) enables some peripheral devices to bypass the system processor and communicate directly with the system memory.

DIMM	Dual Inline Memory Modules are a type of RAM that offer a 64-bit data bus and have separate electrical contacts on each side of the module.
DIO	The digital inputs and digital outputs are general control signals that control the on/off circuit of external devices or TTL devices. Data can be read or written to the selected address to enable the DIO functions.
EHCI	The Enhanced Host Controller Interface (EHCI) specification is a register-level interface description for USB 2.0 Host Controllers.
EIDE	Enhanced IDE (EIDE) is a newer IDE interface standard that has data transfer rates between 4.0 MBps and 16.6 MBps.
EIST	Enhanced Intel® SpeedStep Technology (EIST) allows users to modify the power consumption levels and processor performance through application software. The application software changes the bus-to-core frequency ratio and the processor core voltage.
FSB	The Front Side Bus (FSB) is the bi-directional communication channel between the processor and the Northbridge chipset.
GbE	Gigabit Ethernet (GbE) is an Ethernet version that transfers data at 1.0 Gbps and complies with the IEEE 802.3-2005 standard.
GPIO	General purpose input
HDD	Hard disk drive (HDD) is a type of magnetic, non-volatile computer storage device that stores digitally encoded data.
ICH	The Input/Output Control Hub (ICH) is an Intel® Southbridge chipset.
IrDA	Infrared Data Association (IrDA) specify infrared data transmission protocols used to enable electronic devices to wirelessly communicate with each other.
L1 Cache	The Level 1 Cache (L1 Cache) is a small memory cache built into the system processor.
L2 Cache	The Level 2 Cache (L2 Cache) is an external processor memory cache.
LCD	Liquid crystal display (LCD) is a flat, low-power display device that consists of two polarizing plates with a liquid crystal panel in between.

WAFER-ULT3/ULT4 3.5" SBC

LVDS	Low-voltage differential signaling (LVDS) is a dual-wire, high-speed differential electrical signaling system commonly used to connect LCD displays to a computer.
POST	The Power-on Self Test (POST) is the pre-boot actions the system performs when the system is turned-on.
RAM	Random Access Memory (RAM) is volatile memory that loses data when power is lost. RAM has very fast data transfer rates compared to other storage like hard drives.
SATA	Serial ATA (SATA) is a serial communications bus designed for data transfers between storage devices and the computer chipsets. The SATA bus has transfer speeds up to 1.5 Gbps and the SATA II bus has data transfer speeds of up to 3.0 Gbps.
S.M.A.R.T	Self Monitoring Analysis and Reporting Technology (S.M.A.R.T) refers to automatic status checking technology implemented on hard disk drives.
UART	Universal Asynchronous Receiver-transmitter (UART) is responsible for asynchronous communications on the system and manages the system's serial communication (COM) ports.
UHCI	The Universal Host Controller Interface (UHCI) specification is a register-level interface description for USB 1.1 Host Controllers.
USB	The Universal Serial Bus (USB) is an external bus standard for interfacing devices. USB 1.1 supports 12Mbps data transfer rates and USB 2.0 supports 480Mbps data transfer rates.
VGA	The Video Graphics Array (VGA) is a graphics display system developed by IBM.

Appendix

D

Digital I/O Interface

WAFER-ULT3/ULT4 3.5" SBC

D.1 Introduction

The DIO connector on the WAFER-ULT3/ULT4 is interfaced to GPIO ports on the Super I/O chipset. The digital inputs and digital outputs are generally control signals that control the on/off circuit of external devices or TTL devices. Data can be read or written to the selected address to enable the DIO functions.



NOTE:

For further information, please refer to the datasheet for the Super I/O chipset.

The BIOS interrupt call **INT 15H** controls the digital I/O.

INT 15H:

AH – 6FH
<u>Sub-function:</u>
AL – 8 :Set the digital port as INPUT
AL :Digital I/O input value

D.2 Assembly Language Sample 1

```

MOV    AX, 6F08H    ;setting the digital port as input
INT    15H          ;
    
```

AL low byte = value

AH – 6FH
<u>Sub-function:</u>
AL – 9 :Set the digital port as OUTPUT
BL :Digital I/O input value

D.3 Assembly Language Sample 2

```

MOV    AX, 6F09H    ;setting the digital port as output
MOV    BL, 09H      ;digital value is 09H
INT    15H          ;
    
```

Digital Output is 1001b

Appendix

E

Watchdog Timer



NOTE:

The following discussion applies to DOS environment. Contact IEI support or visit the IEI website for specific drivers for other operating systems.

The Watchdog Timer is provided to ensure that standalone systems can always recover from catastrophic conditions that cause the CPU to crash. This condition may have occurred by external EMIs or a software bug. When the CPU stops working correctly, Watchdog Timer either performs a hardware reset (cold boot) or a Non-Maskable Interrupt (NMI) to bring the system back to a known state.

A BIOS function call (INT 15H) is used to control the Watchdog Timer.

INT 15H:

AH – 6FH Sub-function:	
AL – 2:	Sets the Watchdog Timer's period.
BL:	Time-out value (Its unit-second is dependent on the item "Watchdog Timer unit select" in CMOS setup).

Table E-1: AH-6FH Sub-function

Call sub-function 2 to set the time-out period of Watchdog Timer first. If the time-out value is not zero, the Watchdog Timer starts counting down. When the timer value reaches zero, the system resets. To ensure that this reset condition does not occur, calling sub-function 2 must periodically refresh the Watchdog Timer. However, the watchdog timer is disabled if the time-out value is set to zero.

A tolerance of at least 10% must be maintained to avoid unknown routines within the operating system (DOS), such as disk I/O that can be very time-consuming.

WAFER-ULT3/ULT4 3.5" SBC



NOTE:

When exiting a program it is necessary to disable the Watchdog Timer, otherwise the system resets.

EXAMPLE PROGRAM:

; INITIAL TIMER PERIOD COUNTER

;

W_LOOP:

;

```

MOV      AX, 6F02H      ;setting the time-out value
MOV      BL, 30         ;time-out value is 48 seconds
INT      15H

```

;

; ADD THE APPLICATION PROGRAM HERE

;

```

CMP      EXIT_AP, 1     ;is the application over?
JNE      W_LOOP         ;No, restart the application

MOV      AX, 6F02H      ;disable Watchdog Timer
MOV      BL, 0          ;
INT      15H

```

;

; EXIT ;

Appendix

F

Hazardous Materials Disclosure

WAFER-ULT3/ULT4 3.5" SBC

The details provided in this appendix are to ensure that the product is compliant with the Peoples Republic of China (China) RoHS standards. The table below acknowledges the presences of small quantities of certain materials in the product, and is applicable to China RoHS only.

A label will be placed on each product to indicate the estimated “Environmentally Friendly Use Period” (EFUP). This is an estimate of the number of years that these substances would “not leak out or undergo abrupt change.” This product may contain replaceable sub-assemblies/components which have a shorter EFUP such as batteries and lamps. These components will be separately marked.

Please refer to below table.

Part Name	Toxic or Hazardous Substances and Elements					
	Lead (Pb)	Mercury (Hg)	Cadmium (Cd)	Hexavalent Chromium (CR(VI))	Polybrominated Biphenyls (PBB)	Polybrominated Diphenyl Ethers (PBDE)
Housing	O	O	O	O	O	O
Display	O	O	O	O	O	O
Printed Circuit Board	O	O	O	O	O	O
Metal Fasteners	O	O	O	O	O	O
Cable Assembly	O	O	O	O	O	O
Fan Assembly	O	O	O	O	O	O
Power Supply Assemblies	O	O	O	O	O	O
Battery	O	O	O	O	O	O

O: This toxic or hazardous substance is contained in all of the homogeneous materials for the part is below the limit requirement in SJ/T11363-2006 (now replaced by GB/T 26572-2011).

X: This toxic or hazardous substance is contained in at least one of the homogeneous materials for this part is above the limit requirement in SJ/T11363-2006 (now replaced by GB/T 26572-2011).

此附件旨在确保本产品符合中国 RoHS 标准。以下表格标示此产品中某有毒物质的含量符合中国 RoHS 标准规定的限量要求。

本产品上会附有“环境友好使用期限”的标签，此期限是估算这些物质“不会有泄漏或突变”的年限。本产品可能包含有较短的环境友好使用期限的可替换元件，像是电池或灯管，这些元件将会单独标示出来。

部件名称	有毒有害物质或元素					
	铅 (Pb)	汞 (Hg)	镉 (Cd)	六价铬 (CR(VI))	多溴联苯 (PBB)	多溴二苯 醚 (PBDE)
壳体	○	○	○	○	○	○
显示	○	○	○	○	○	○
印刷电路板	○	○	○	○	○	○
金属螺帽	○	○	○	○	○	○
电缆组装	○	○	○	○	○	○
风扇组装	○	○	○	○	○	○
电力供应组装	○	○	○	○	○	○
电池	○	○	○	○	○	○

○: 表示该有毒有害物质在该部件所有物质材料中的含量均在 SJ/T11363-2006 (现由 GB/T 26572-2011 取代) 标准规定的限量要求以下。

X: 表示该有毒有害物质至少在该部件的某一均质材料中的含量超出 SJ/T11363-2006 (现由 GB/T 26572-2011 取代) 标准规定的限量要求。