

MODEL:
WSB-9454

**PICMG 1.0 CPU Card with LGA775 CPU Socket
VGA, DVI, Gigabit Ethernet, SATA II and Audio
RoHS Compliant**

User Manual

Revision

Date	Version	Changes
November 7, 2014	4.03	Deleted Onboard LAN1 and Onboard LAN2 BIOS options
September 2012	4.02	Updated Table 4-4: SPI Flash Connector Settings
May 2011	4.01	Minor update to cover page and connector images. Deleted erroneous wording from Section 3.2.15 SATA Drive Connectors. Deleted all instances of R12 board name.
December 2010	4.00	Changed LAN chipset from Broadcom to Realtek RTL8111E Added JSPI1 jumper setting
October 2009	1.20	EMI improvement and temperature range adjusted
May 2009	1.10	LAN power selection jumper added
December 2006	1.00	Initial release

Copyright

COPYRIGHT NOTICE

The information in this document is subject to change without prior notice in order to improve reliability, design and function and does not represent a commitment on the part of the manufacturer.

In no event will the manufacturer be liable for direct, indirect, special, incidental, or consequential damages arising out of the use or inability to use the product or documentation, even if advised of the possibility of such damages.

This document contains proprietary information protected by copyright. All rights are reserved. No part of this manual may be reproduced by any mechanical, electronic, or other means in any form without prior written permission of the manufacturer.

TRADEMARKS

All registered trademarks and product names mentioned herein are used for identification purposes only and may be trademarks and/or registered trademarks of their respective owners.

Table of Contents

1 INTRODUCTION.....	1
1.1 OVERVIEW.....	2
1.2 MODEL VARIATIONS	2
1.3 BENEFITS	2
1.4 FEATURES.....	3
1.5 OVERVIEW PICTURE	4
1.6 CONNECTORS	4
1.7 TECHNICAL SPECIFICATIONS	5
2 DETAILED SPECIFICATIONS	7
2.1 COMPATIBLE IEI BACKPLANES.....	8
2.2 CPU SUPPORT	8
2.3 DATA FLOW	9
3 CONNECTORS AND JUMPERS	11
3.1 PERIPHERAL INTERFACE CONNECTORS.....	12
3.1.1 <i>Layout</i>	12
3.1.2 <i>Peripheral Interface Connectors</i>	12
3.1.3 <i>External Peripheral Interface Connectors</i>	13
3.1.4 <i>Jumpers</i>	14
3.2 INTERNAL PERIPHERAL CONNECTORS	14
3.2.1 <i>ATX-12V Power Source Connector</i>	14
3.2.2 <i>Audio Module Connector</i>	15
3.2.3 <i>Backplane to Mainboard Power Connector</i>	15
3.2.4 <i>CPU Fan Connector</i>	16
3.2.5 <i>Digital Input/Output (DIO) Connector</i>	17
3.2.6 <i>DVI (Digital Visual Interface) Connector (Optional)</i>	17
3.2.7 <i>FDD Connector</i>	18
3.2.8 <i>Front Panel Connector</i>	20
3.2.9 <i>IDE Connector</i>	20
3.2.10 <i>IrDA Interface Connector</i>	22

WSB-9454 PCIMG 1.0 CPU Card

3.2.11 Keyboard Connector	22
3.2.12 Memory Connectors.....	23
3.2.13 Parallel Port Connector	23
3.2.14 RS-232 Serial Port Connectors.....	24
3.2.15 SATA Drive Connectors	25
3.2.16 USB Connectors.....	27
3.3 EXTERNAL PERIPHERAL INTERFACE CONNECTORS.....	27
3.3.1 LAN Connectors.....	28
3.3.2 Mini-DIN 6 PS/2 Connector	29
3.3.3 USB Connector	30
3.3.4 VGA connector.....	30
4 INSTALLATION AND CONFIGURATION	32
4.1 ANTI-STATIC PRECAUTIONS	33
4.2 INSTALLATION CONSIDERATIONS.....	33
4.2.1 Installation Notices	33
4.3 UNPACKING.....	34
4.3.1 Unpacking Precautions.....	34
4.3.2 Checklist.....	35
4.4 WSB-9454 CPU CARD INSTALLATION.....	35
4.4.1 CPU Installation	36
4.4.2 Cooling Kit Installation	39
4.4.3 DIMM Module Installation.....	41
4.5 PERIPHERAL DEVICE CONNECTION	42
4.5.1 IDE Drive Connector.....	43
4.5.2 Floppy Drive Connector	44
4.5.3 SATA Drive Connection	45
4.5.4 Installing the RS-232 Cable.....	46
4.5.5 USB 2.0 Cable Connection	47
4.6 ON-BOARD JUMPER	49
4.6.1 Clear CMOS Jumper.....	49
4.6.2 SPI Flash Connector.....	50
4.7 CHASSIS INSTALLATION.....	51
4.8 REAR PANEL CONNECTORS	51
4.8.1 Keyboard and Mouse Connection.....	51

4.8.2 VGA Port Installation	51
4.8.3 Ethernet Connection	51
4.8.4 USB Connection.....	52
5 BIOS.....	53
5.1 INTRODUCTION.....	54
5.1.1 Starting Setup.....	54
5.1.2 Using Setup	54
5.1.3 Getting Help.....	55
5.1.4 Unable to Reboot After Configuration Changes.....	55
5.1.5 BIOS Menu Bar.....	55
5.2 MAIN.....	56
5.3 ADVANCED.....	57
5.3.1 CPU Configuration.....	58
5.3.2 IDE Configuration	59
5.3.2.1 IDE Master, IDE Slave	63
5.3.3 Floppy Configuration.....	68
5.3.4 Super IO Configuration	69
5.3.5 Hardware Health Configuration.....	72
5.3.6 Power Function.....	73
5.3.6.1 Power Function	73
5.3.7 Remote Access Configuration	76
5.3.8 USB Configuration.....	80
5.3.8.1 USB Mass Storage Device Configuration.....	81
5.4 PCI/PNP.....	83
5.5 BOOT.....	86
5.5.1 Boot Settings Configuration.....	86
5.5.2 Boot Device Priority	88
5.5.3 Hard Disk Drives	89
5.5.4 Removable Drives	89
5.5.5 CD/DVD Drives.....	90
5.6 SECURITY.....	91
5.7 CHIPSET	92
5.7.1 Northbridge Configuration	93
5.7.2 Southbridge Configuration	95

WSB-9454 PCIMG 1.0 CPU Card

5.8 EXIT	96
6 SOFTWARE DRIVERS	98
6.1 AVAILABLE SOFTWARE DRIVERS	99
6.2 CHIPSET DRIVER INSTALLATION.....	99
6.3 VGA DRIVER	102
6.4 REALTEK LAN DRIVER (FOR GbE LAN) INSTALLATION	106
6.5 REALTEK AC'97 (ALC655) AUDIO DRIVER INSTALLATION.....	110
6.5.1 BIOS Setup.....	110
6.5.2 Driver Installation	110
A BIOS OPTIONS	116
B TERMINOLOGY.....	120
C DIGITAL I/O INTERFACE.....	124
C.1 INTRODUCTION	125
C.2 ASSEMBLY LANGUAGE SAMPLE 1	126
C.3 ASSEMBLY LANGUAGE SAMPLE 2.....	126
D WATCHDOG TIMER	127
E HAZARDOUS MATERIALS DISCLOSURE	130
E.1 HAZARDOUS MATERIALS DISCLOSURE TABLE FOR IPB PRODUCTS CERTIFIED AS ROHS COMPLIANT UNDER 2002/95/EC WITHOUT MERCURY	131

List of Figures

Figure 1–1: Overview.....	4
Figure 2-1: Data Flow Block Diagram.....	9
Figure 3-1: Connector and Jumper Locations.....	12
Figure 3-2: ATX–12V Connector Location	14
Figure 3-3: Audio Module Connector Location	15
Figure 3-4: Backplane to Mainboard Power Connector Location	16
Figure 3-5: CPU Fan Connector Location	16
Figure 3-6: DIO Connector Location.....	17
Figure 3-7: DVI Connector Location	18
Figure 3-8: FDD Connector Location.....	19
Figure 3-9: Front Panel Connector Location	20
Figure 3-10: IDE Connector Location	21
Figure 3-11: IrDA Interface Connector Location	22
Figure 3-12: Keyboard Connector Location	23
Figure 3-13: Memory Connectors Location	23
Figure 3-14: Parallel Port Connector Location	24
Figure 3-15: RS-232 Serial Port Connectors Location.....	25
Figure 3-16: SATA Connectors Location	26
Figure 3-17: USB Port Connector Location	27
Figure 3-18: External Peripheral Interface Connector Panel	28
Figure 3-19: RJ-45 Ethernet Connector.....	28
Figure 3-20: Mini-DIN 6 PS/2 Connector.....	29
Figure 3-21: VGA Connector	31
Figure 4-1: Intel® LGA775 Socket.....	37
Figure 4-2: Remove the CPU Socket Protective Shield.....	37
Figure 4-3: Open the CPU Socket Load Plate.....	38
Figure 4-4: Insert the Socket LGA775 CPU.....	39
Figure 4-5: Cooling Kit.....	40
Figure 4-6: Securing the Heat sink to the PCB.....	41
Figure 4-7: Installing the DIMM Module.....	42

WSB-9454 PCIMG 1.0 CPU Card

Figure 4-8: Connection of IDE Connector	44
Figure 4-9: SATA Drive Cable Connection.....	45
Figure 4-10: SATA Drive Connection.....	46
Figure 4-11: Dual RS-232 Cable Installation	47
Figure 4-12: USB Cable Installation.....	48
Figure4-13: Clear CMOS Jumper Location	50
Figure4-14: SPI Flash Connector Location	51
Figure 6-1: InstallShield Wizard Preparation Screen	100
Figure 6-2: Welcome Screen	100
Figure 6-3: License Agreement	101
Figure 6-4: Readme Information	101
Figure 6-5: Restart the Computer	102
Figure 6-6: Starting Install Shield Wizard Screen	103
Figure 6-7: Preparing Setup Screen	103
Figure 6-8: VGA Driver Installation Welcome Screen	104
Figure 6-9: VGA Driver License Agreement.....	104
Figure 6-10: VGA Driver Installing Notice	105
Figure 6-11: VGA Driver Installation Complete	105
Figure 6-12: Access Windows Control Panel	106
Figure 6-13: Double Click the System Icon.....	107
Figure 6-14: Double Click the Device Manager Tab	107
Figure 6-15: Device Manager List	108
Figure 6-16: Search for Suitable Driver	108
Figure 6-17: Locate Driver Files	109
Figure 6-18: Location Browsing Window	109
Figure 6-19: CD 4-AUDIO\AC-KIT08R\Windows Folder	111
Figure 6-20: AC`97 Audio Driver Install Shield Wizard Starting	111
Figure 6-21: AC`97 Audio Driver Setup Preparation	112
Figure 6-22: AC`97 Audio Driver Welcome Screen	112
Figure 6-23: AC`97 Audio Driver Software Configuration	113
Figure 6-24: AC`97 Audio Driver Digital Signal	113
Figure 6-25: AC`97 Audio Driver Installation Begins	114
Figure 6-26: AC`97 Audio Driver Installation Complete.....	114

List of Tables

Table 1-1: Model Variations	2
Table 1-2: Technical Specifications.....	6
Table 2-1: Supported CPUs	8
Table 2-2: Power Consumption.....	10
Table 3-1: Peripheral Interface Connectors	13
Table 3-2: External Peripheral Interface Connectors.....	13
Table 3-3: On-board Jumper.....	14
Table 3-4: ATX-12V Connector Pinouts.....	15
Table 3-5: Audio Module Connector Pinouts.....	15
Table 3-6: Backplane to Mainboard Power Pinouts.....	16
Table 3-7: CPU Fan Connector Pinouts.....	17
Table 3-8: DIO Connector Pinouts	17
Table 3-9: DVI Connector Pinouts.....	18
Table 3-10: FDD Connector Pinouts	19
Table 3-11: Front Panel Connector Location.....	20
Table 3-12: IDE Connector Pinouts.....	21
Table 3-13: IrDA Interface Connector Pinouts.....	22
Table 3-14: KB1 Connector Pinouts	23
Table 3-15: Parallel Port Connector Pinouts	24
Table 3-16: RS-232 Serial Port Connectors Pinouts	25
Table 3-17: SATA Connectors Pinouts.....	26
Table 3-18: USB Port Connector Pinouts.....	27
Table 3-19: LAN Pinouts	28
Table 3-20: RJ-45 Ethernet Connector LEDs	29
Table 3-21: Mini-DIN 6 PS/2 Connector	30
Table 3-22: USB Port Pinouts.....	30
Table 3-23: VGA Connector Pinouts.....	31
Table 4-1: IEI Provided Cables	43
Table 4-2: On-board Jumpers.....	49
Table 4-3: Clear CMOS Jumper Settings.....	50

WSB-9454 PCIMG 1.0 CPU Card

Table 4-4: SPI Flash Connector Settings	50
Table 5-1: BIOS Navigation Keys	55

BIOS Menus

BIOS Menu 1: Main	56
BIOS Menu 2: Advanced	58
BIOS Menu 3: CPU Configuration	58
BIOS Menu 4: IDE Configuration	59
BIOS Menu 5: IDE Master and IDE Slave Configuration	64
BIOS Menu 6: IDE Master and IDE Slave Configuration	68
BIOS Menu 7: Super IO Configuration	69
BIOS Menu 8: Hardware Health Configuration	72
BIOS Menu 9: ACPI Configuration	73
BIOS Menu 10: APM Configuration	74
BIOS Menu 11: Remote Access Configuration	77
BIOS Menu 12: USB Configuration	80
BIOS Menu 13: USB Mass Storage Device Configuration	82
BIOS Menu 14: PCI/PnP Configuration	84
BIOS Menu 15: Boot	86
BIOS Menu 16: Boot Settings Configuration	86
BIOS Menu 17: Boot Device Priority Settings	88
BIOS Menu 18: Hard Disk Drives	89
BIOS Menu 19: Removable Drives	89
BIOS Menu 20: CD/DVD Drives	90
BIOS Menu 21: Security	91
BIOS Menu 22: Chipset	92
BIOS Menu 23: Northbridge Chipset Configuration	93
BIOS Menu 24: Southbridge Chipset Configuration	95
BIOS Menu 25: Exit	96

Chapter

1

Introduction

1.1 Overview

The PCIMG 1.0 form factor WSB-9454 CPU card with Intel® Pentium® D processor platform is fully equipped with the latest technology and advanced multi-mode I/Os. The WSB-9454 is designed for system manufacturers, integrators, and VARs that want performance, reliability, and quality at a reasonable price.

The WSB-9454 CPU card has been designed for use in industrial applications where board expansion is critical and operational reliability is essential.

1.2 Model Variations

The WSB-9454 has two model variations shown in Table 1-1:

Model Name	SATA II	DVI
WSB-9454-R40	Four	None
WSB-9454DVI-R40	Four	One

Table 1-1: Model Variations

1.3 Benefits

Some of the WSB-9454 CPU card benefits include:

- Dual-core Intel® processor support
 - Two physical cores in a package share the system load
 - Each core has its own L1 cache and shares the L2 cache to enhance the processing speed
 - High performance levels especially in 3D graphic and multimedia application
- Enhanced Intel SpeedStep® Technology support ensures better power consumption management
- Intel® EMT64 Technology supports 64-bit computing for improved performance, allowing systems to address more than 4GB of both virtual and physical memory
- providing access to multiple PCI and ISA expansion slots for easy system expansion

WSB-9454 PCIMG 1.0 CPU Card

- operating reliably in harsh industrial environments with ambient temperatures as high as 60°C
- rebooting automatically if the BIOS watchdog timer detects that the system is no longer operating

1.4 Features

Some of the WSB-9454 CPU card features are listed below:

- PCIMG 1.0 compliant
- RoHS compliant
- Supports Intel® Core™2 Duo / Pentium® 4 / Pentium® D / Celeron® D CPUs
- Supports a maximum front side bus (FSB) speed up to 1066MHz
- Supports up to 4GB of 400/533/667MHz of DDR2 memory
- Comes with two high performance PCI Express Gigabit Ethernet (PCI-E GbE) controllers
- Supports SATA II channels with transfer rates up to 300Mb/s
- Supports up to seven USB 2.0 devices
- Analog display supported
- One DVI interface with resolution from VGA to UXGA supported by one model

1.5 Overview Picture

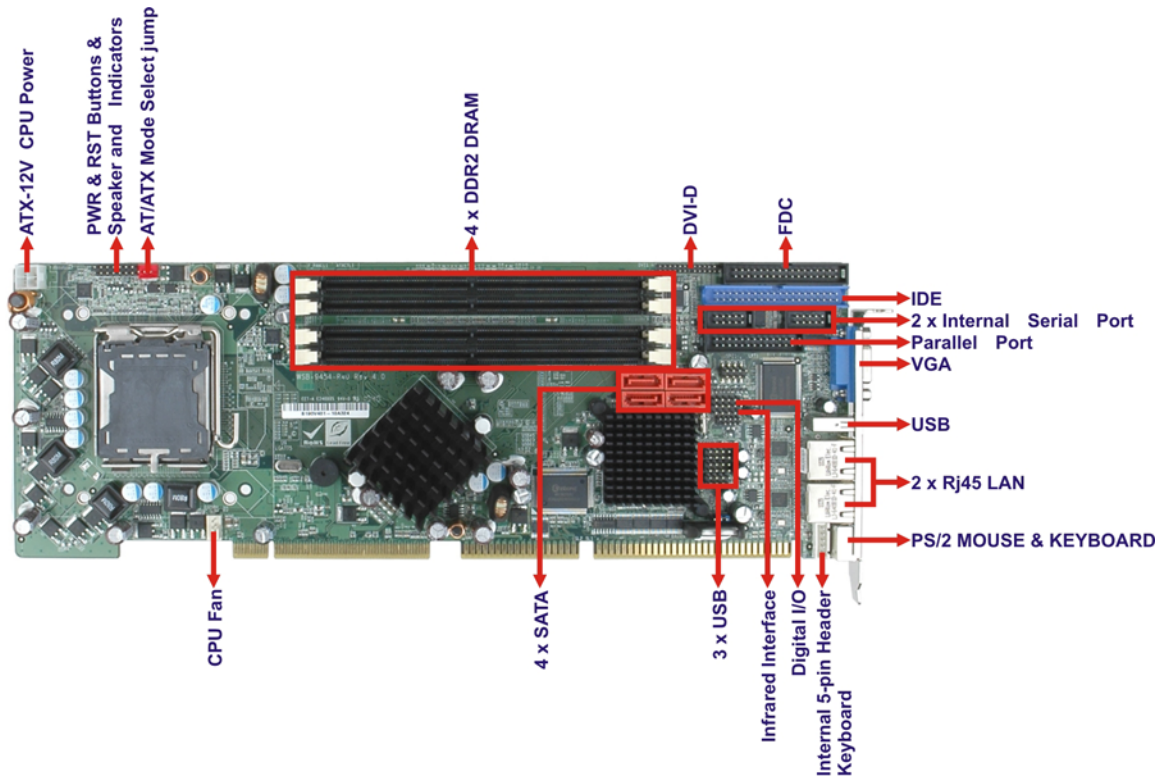

Figure 1-1: Overview

1.6 Connectors

The WSB-9454 CPU card has the following connectors on-board:

- 1 x ATX-12V connector
- 1 x Audio module connector
- 1 x Backplane to mainboard power connector
- 1 x CPU fan connector
- 4 x DDR2 DIMM sockets
- 1 x Digital I/O connector
- 1 x Digital Visual Interface (DVI) Connector (see Table 1-1:)
- 1 x FDD connector
- 1 x Front panel connector
- 1 x 40-pin IDE connector
- 1 x IrDA connector
- 1 x Keyboard/mouse connector

WSB-9454 PCIMG 1.0 CPU Card

- 1 x Parallel port connector
- 2 x RS-232 Serial port connectors
- 4 x SATA II connectors (see Table 1-1:)
- 6 x USB connectors

1.7 Technical Specifications

Technical specifications are listed in Table 1-2:

SPECIFICATION	DESCRIPTION
Supported CPUs	Intel® Core™ 2 Duo Intel® Pentium® 4 Intel® Pentium® D Intel® Celeron® D
Front Side Bus	533/800/1066MHz
Socket	LGA775
Chipsets	Northbridge: Intel® 945G Express Chipset Intel® 82945G Graphics and Memory Controller Hub (GMCH) Southbridge: Intel® ICH7 I/O Controller Hub (ICH)
Graphics Support	Intel® Graphics Media Accelerator 950 (GMA 950) integrated in the Northbridge One VGA Silicon Image Sil1362 One DVI (See Table 1-1:)
Memory	Four 400/533/667 MHz DDR2 memory modules (Max. 4GB)
PCI Bus Interface	33MHz, Revision 2.3
ISA Bus Interface	Supports three fully compatible ISA slots without buffering ISA DMA and ISA Bus Master function are not supported
Serial ATA (SATA)	Four SATA II channels with 300Mb/s transfer rates (see

SPECIFICATION	DESCRIPTION
	Table 1-1:)
HDD Interface	One IDE channel supports two Ultra ATA 100/66/33 devices (see Table 1-1:)
Floppy Disk Drive (FDD)	Supports FDD
USB Interfaces	Six internal USB 2.0 connectors and one external USB port support seven USB devices
Serial Ports	Two RS-232 serial port connectors (COM1 and COM2)
Real Time Clock	256-byte battery backed CMOS RAM
Hardware Monitoring	Cooling fans, temperature and system voltages
Power Management	Supports Advanced Configuration and Power Interface (ACPI) Specifications Revision 2.0
Power Consumption	5V @ 6.75A, +12V @ 7.24A (Intel® Pentium® 4 3.0GHz, DDR2 533MHz 1GB*4) -3D MARK)
Infrared Support	One Infrared Data Association (IrDA) interface
Ethernet	Two PCI Express Gigabit Ethernet (PCI-E GbE) channels
BIOS	AMI BIOS
Physical Dimensions	12.2cm x 34.1cm (width x length)
Operating Temperature	Minimum: 0°C (32°F) Maximum: 60°C (140°F)
Operating Humidity	Minimum: 5% Maximum: 95%
Optional Audio Interface	5.1 channel audio kit 7.1 channel HD audio kit with dual audio streams

Table 1-2: Technical Specifications

Chapter

2

Detailed Specifications

2.1 Compatible IEI Backplanes

The WSB-9454 CPU card is compatible with the all IEI PICMG1.0 backplanes. For more information on these backplanes, visit the IEI website or contact your CPU card reseller or vendor.

2.2 CPU Support

Table 2-1 lists the CPUs supported by the WSB-9454 board.

Model	Clock Speed	L2 Cache	Max. FSB	Socket
Intel® Core™2 Duo	1.86 to 2.66 GHz	2 to 4 MB	1066 MHz	LGA775
Intel® Pentium® Processor Extreme Edition	3.2 GHz	2 x 1 to 2 MB	1066 MHz	LGA775
Intel® Pentium® D	2.80 to 3.60 GHz	2 x 1 to 2 MB	800 MHz	LGA775
Intel® Pentium® 4	2.66 to 3.80 GHz	1 to 2 MB	800 MHz	LGA775
Intel® Celeron® D	2.13 to 3.46 GHz	256 to 512 KB	533 MHz	LGA775

Table 2-1: Supported CPUs

WSB-9454 PCIMG 1.0 CPU Card

2.3 Data Flow

Figure 2-1 shows the data flow between the user-installed CPU, the two on-board chipsets, and other components installed on the CPU card.

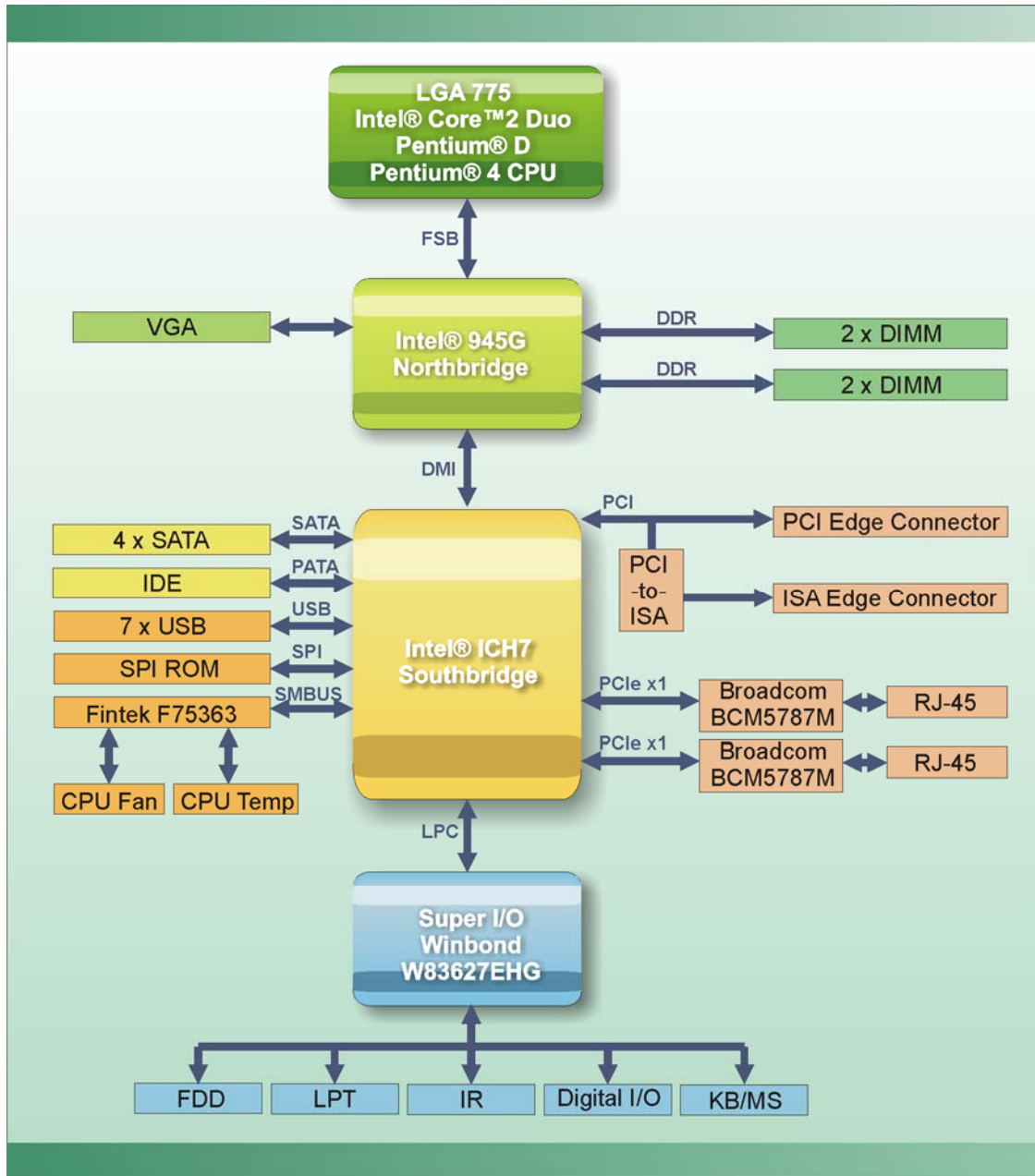

Figure 2-1: Data Flow Block Diagram

Table 2-2 shows the power consumption parameters for the WSB-9454 CPU card when a 3GHz Intel® Pentium® 4 processor is running with four 1GB, DDR2 533MHz SDRAM memory modules.

Voltage	Current
5V	6.75A
+12V	7.24A

Table 2-2: Power Consumption

Chapter

3

Connectors and Jumpers

3.1 Peripheral Interface Connectors

This section shows the location of, and describes the peripheral interface connectors on the WSB-9454.

3.1.1 Layout

Figure 3-1 shows the on-board peripheral connectors, backplane peripheral connectors and on-board jumpers.

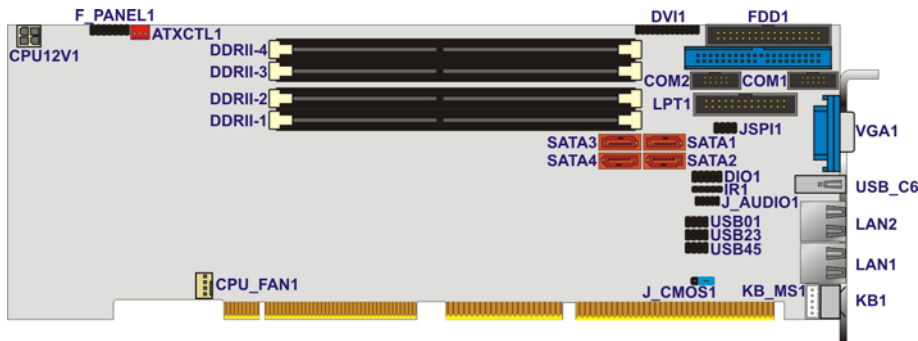

Figure 3-1: Connector and Jumper Locations

3.1.2 Peripheral Interface Connectors

Table 3-1 lists the peripheral interface connectors on the WSB-9454 CPU card. Detailed descriptions of these connectors can be found in Section 3.2.

Label	Connector	Type
CPU12V1	ATX-12V CPU Power Source	4-pin terminal block
J_AUDIO1	Audio Module Connector	9-pin header
ATXCTL1	Backplane to Mainboard Power Connector	3-pin wafer connector
CPU_FAN1	CPU Fan Connector	4-pin wafer connector
DIO1	Digital I/O Connector	10-pin header
DVI1	Digital Visual Interface Connector (Optional)	25-pin header
FDD1	FDD Connector	34-pin box header
F_PANEL1	Front Panel Connector	14-pin header
PIDE1	IDE Connector	40-pin box header

WSB-9454 PCIMG 1.0 CPU Card

Label	Connector	Type
IR1	IrDA Infrared Interface Connector	5-pin header
KB1	Keyboard Connector	4-pin wafer connector
DDRII-1 DDRII-2 DDRII-3 DDRII-4	Memory Connectors	DDR2 DRAM Slot
LPT1	Parallel Port Connector	25-pin box header
COM1 COM2	RS-232 Serial Port Connectors	10-pin box header
SATA1 SATA2 SATA3 SATA4	Serial ATA Connectors	7-pin SATA connector
USB01 USB23 USB45	USB Connectors	8-pin header

Table 3-1: Peripheral Interface Connectors

3.1.3 External Peripheral Interface Connectors

Table 3-2 lists the external peripheral interface connectors on the WSB-9454. Detailed descriptions of these connectors can be found in Section 3.3.

Connector	Type	Label
Ethernet connectors	RJ-45 connector	LAN1 LAN2
Keyboard/mouse connector	MINI-DIN connector	KB_MS1
USB connector	USB 2.0 connector	USB_C6
VGA connector	HD-D-sub 15 female connector	VGA1

Table 3-2: External Peripheral Interface Connectors

3.1.4 Jumpers

Table 3-3 lists the on-board jumper. Detailed descriptions are in a later chapter.

Label	Connector	Type
JSPI1	SPI Flash Connector	8-pin header (2 x 4)
J_CMOS1	CMOS state setting	3-pin header

Table 3-3: On-board Jumper

3.2 Internal Peripheral Connectors

Internal peripheral connectors are found on the CPU card and are only accessible when the CPU card is outside of the chassis. This section has complete descriptions of all the internal peripheral connectors on the WSB-9454 CPU card.

3.2.1 ATX-12V Power Source Connector

- CN Label:** CPU12V1
- CN Type:** 4-pin terminal block
- CN Location:** See Figure 3-2
- CN Pinouts:** See Table 3-4

This connector supports the ATX-12V power supply.

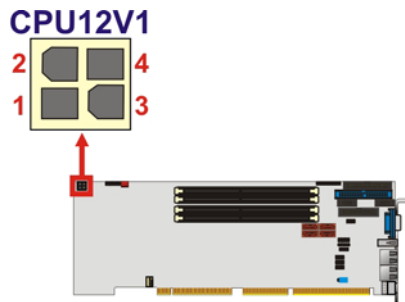

Figure 3-2: ATX-12V Connector Location

WSB-9454 PCIMG 1.0 CPU Card

Pin	Description	Pin	Description
1	GND	2	GND
3	+12V	4	+12V

Table 3-4: ATX-12V Connector Pinouts

3.2.2 Audio Module Connector

- CN Label:** J_AUDIO1
- CN Type:** 10- pin header
- CN Location:** See Figure 3-3
- CN Pinouts:** See Table 3-5

The WSB-9454 CPU card does not have a built-in AC'97 audio codec. If your system needs audio then this connector must be connected to an external audio module.



Figure 3-3: Audio Module Connector Location

Pin	Description	Pin	Description
1	SYNC	2	BITCLK
3	SDOUT	4	PCBEEP
5	SDIN	6	RST#
7	VCC	8	GND
9	+12V		

Table 3-5: Audio Module Connector Pinouts

3.2.3 Backplane to Mainboard Power Connector

- CN Label:** ATXCTL1
- CN Type:** 3-pin wafer connector
- CN Location:** See Figure 3-4
- CN Pinouts:** See Table 3-6

Connects a power source from a backplane with an ATX Connector.

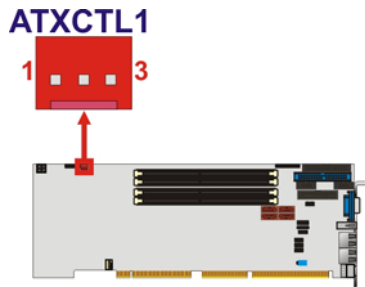

Figure 3-4: Backplane to Mainboard Power Connector Location

Pin	Description
1	GND
2	ATX-ON
3	5VSB

Table 3-6: Backplane to Mainboard Power Pinouts

3.2.4 CPU Fan Connector

- CN Label:** CPU_FAN1
- CN Type:** 4-pin wafer connector
- CN Location:** See Figure 3-5
- CN Pinouts:** See Table 3-7

The cooling fan connector provides a 12V, 500mA current to a CPU cooling fan. The connector has a "rotation" pin to get rotation signals from fans and notify the system so the system BIOS can recognize the fan speed. Please note that only specified fans can issue the rotation signals.

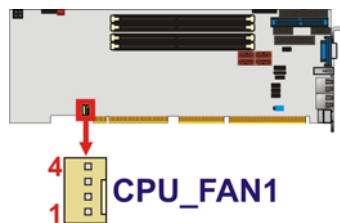

Figure 3-5: CPU Fan Connector Location

WSB-9454 PCIMG 1.0 CPU Card

Pin	Description
1	Ground
2	+12V
3	Rotation Signal
4	Control

Table 3-7: CPU Fan Connector Pinouts

3.2.5 Digital Input/Output (DIO) Connector

- CN Label:** DIO1
- CN Type:** 10-pin header
- CN Location:** See Figure 3-6
- CN Pinouts:** See Table 3-8

The DIO connector is managed through a Super I/O chip. The DIO connector pins are user programmable.

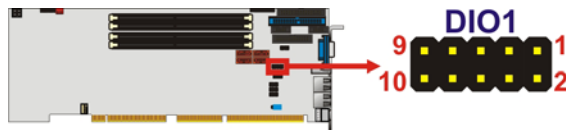

Figure 3-6: DIO Connector Location

Pin	Description	Pin	Description
1	Ground	2	VCC
3	Output 0	4	Output 1
5	Output 2	6	Output 3
7	Input 0	8	Input 1
9	Input 2	10	Input 3

Table 3-8: DIO Connector Pinouts

3.2.6 DVI (Digital Visual Interface) Connector (Optional)

- CN Label:** DVI1
- CN Type:** 25-pin header

CN Location: See Figure 3-7

CN Pinouts: See Table 3-9

The WSB-9454DVI-R40 model provides a digital visual interface for digital display. Optional accessory IO-KIT-001 modules can be selected to connect to external DVI devices.

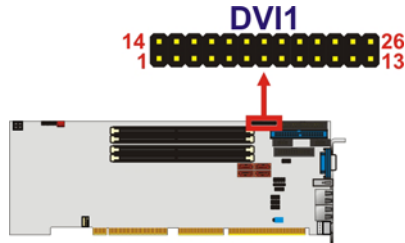

Figure 3-7: DVI Connector Location

Pin	Description	Pin	Description
1	Data 2-	14	VCC
2	Data 2+	15	GND
3	GND	16	Hot Plug Detect.
4	N/C	17	Data 0-
5	N/C	18	Data 0+
6	DDC Clock	19	GND
7	DDC Data	20	N/C
8	N/C	21	N/C
9	Data 1-	22	GND
10	Data 1+	23	Clock +
11	GND	24	Clock -
12	N/C	25	GND
13	N/C		

Table 3-9: DVI Connector Pinouts

3.2.7 FDD Connector

CN Label: FDD1

CN Type: 34-pin header

WSB-9454 PCIMG 1.0 CPU Card

CN Location: See Figure 3-8

CN Pinouts: See Table 3-10

The WSB-9454 is shipped with a 34-pin daisy-chain drive connector cable. This cable can be connected to the FDD connector.

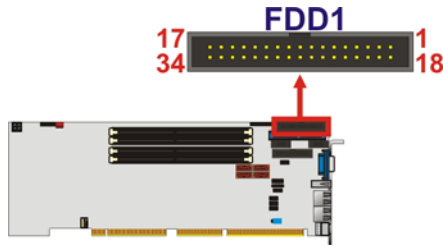

Figure 3-8: FDD Connector Location

Pin	Description	Pin	Description
1	GND	2	REDUCE WRITE
3	GND	4	N/C
5	N/C	6	N/C
7	GND	8	INDEX#
9	GND	10	MOTOR ENABLE A#
11	GND	12	DRIVE SELECT B#
13	GND	14	DRIVE SELECT A#
15	GND	16	MOTOR ENABLE B#
17	GND	18	DIRECTION#
19	GND	20	STEP#
21	GND	22	WRITE DATA#
23	GND	24	WRITE GATE#
25	GND	26	TRACK 0#
27	GND	28	WRITE PROTECT#
29	GND	30	READ DATA#
31	GND	32	SIDE 1 SELECT#
33	GND	34	DISK CHANGE#

Table 3-10: FDD Connector Pinouts

3.2.8 Front Panel Connector

- CN Label:** F_PANEL1
- CN Type:** 14-pin header
- CN Location:** See Figure 3-9
- CN Pinouts:** See Table 3-11

The system front panel connector connects to:

- the system chassis front panel LEDs
- the chassis speaker
- the power switch
- the reset button

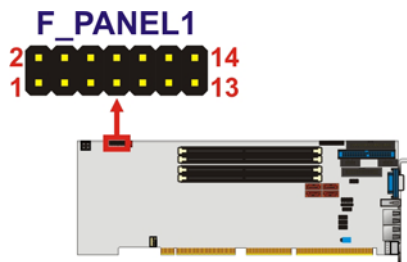

Figure 3-9: Front Panel Connector Location

Pin	Description	Pin	Description
1	PWR_LED+	2	SPKR+
3	N/C	4	N/C
5	PWR_LED-	6	N/C
7	PWR_BTN+	8	SPKR-
9	PWR_BTN-	10	N/C
11	HDD_LED+	12	RESET+
13	HDD_LED-	14	RESET-

Table 3-11: Front Panel Connector Location

3.2.9 IDE Connector

- CN Label:** PIDE1
- CN Type:** 40-pin box header

WSB-9454 PCIMG 1.0 CPU Card

CN Location: See Figure 3-10

CN Pinouts: See Table 3-12

One IDE connector provides connectivity for two IDE devices.

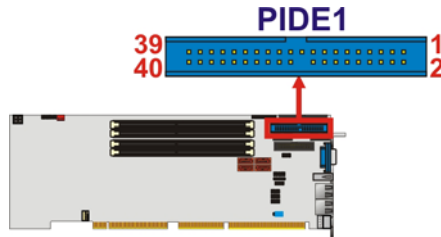

Figure 3-10: IDE Connector Location

Pin	Description	Pin	Description
1	RESET#	2	GND
3	DATA 7	4	DATA 8
5	DATA 6	6	DATA 9
7	DATA 5	8	DATA 10
9	DATA 4	10	DATA 11
11	DATA 3	12	DATA 12
13	DATA 2	14	DATA 13
15	DATA 1	16	DATA 14
17	DATA 0	18	DATA 15
19	GND	20	N/C
21	IDE DRQ	22	GND
23	IOW#	24	GND
25	IOR#	26	GND
27	IDE CHRDY	28	BALE – DEFAULT
29	IDE DACK	30	GND
31	INTERRUPT	32	N/C
33	SA1	34	PDIAG#
35	SA0	36	SA2
37	HDC CS0#	38	HDC CS1#
39	HDD ACTIVE#	40	GND

Table 3-12: IDE Connector Pinouts

3.2.10 IrDA Interface Connector

- CN Label:** IR1
- CN Type:** 5-pin header
- CN Location:** See Figure 3-11
- CN Pinouts:** See Table 3-13

The integrated IrDA interface connector supports both the SIR and ASKIR infrared protocols.

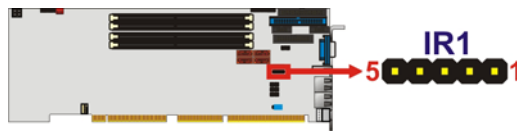

Figure 3-11: IrDA Interface Connector Location

Pin	Description
1	VCC
2	NC
3	SIN1_IRRX
4	GND
5	SOUT1_IRTX

Table 3-13: IrDA Interface Connector Pinouts

3.2.11 Keyboard Connector

- CN Label:** KB1
- CN Type:** 4-pin wafer
- CN Location:** See Figure 3-12
- CN Pinouts:** See Table 3-14

For alternative application, a keyboard pin header connector is also available on board. This connector requires a special adapter cable.

WSB-9454 PCIMG 1.0 CPU Card

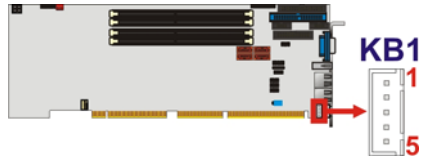

Figure 3-12: Keyboard Connector Location

Pin	Description
1	Keyboard Clock
2	Keyboard Data
3	NC
4	GND
5	VCC

Table 3-14: KB1 Connector Pinouts

3.2.12 Memory Connectors

CN Label: DDRII-1, DDRII-2, DDRII-3, DDRII-4

CN Type: DDR2 DRAM Slot

CN Location: See Figure 3-14

Four slots are provided for inserting DDR2 type memory cards.

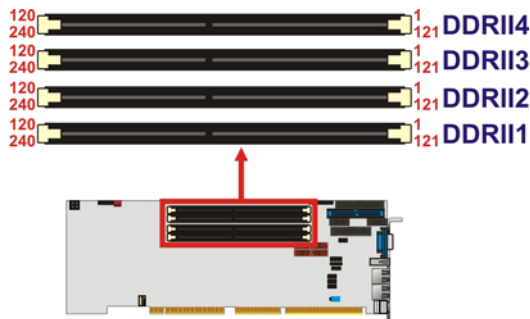

Figure 3-13: Memory Connectors Location

3.2.13 Parallel Port Connector

CN Label: LPT1

CN Type: 26-pin box header

CN Location: See Figure 3-14

CN Pinouts: See Table 3-15

The parallel port connector is usually connected to a printer or other parallel device with a 26-pin flat-cable connector.

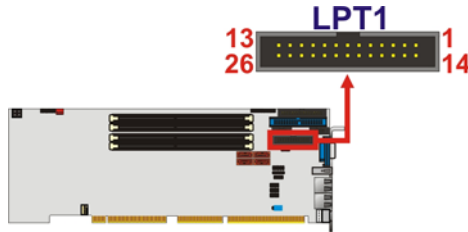

Figure 3-14: Parallel Port Connector Location

Pin	Description	Pin	Description
1	STROBE#	14	AUTO FORM FEED #
2	DATA0	15	ERROR#
3	DATA1	16	INITIALIZE#
4	DATA2	17	PRINTER SELECT LN#
5	DATA3	18	GND
6	DATA4	19	GND
7	DATA5	20	GND
8	DATA6	21	GND
9	DATA7	22	GND
10	ACKNOWLEDGE#	23	GND
11	BUSY	24	GND
12	PAPER EMPTY	25	GND
13	PRINTER SELECT		

Table 3-15: Parallel Port Connector Pinouts

3.2.14 RS-232 Serial Port Connectors

CN Label: COM1, COM2

CN Type: 10-pin box header

CN Location: See Figure 3-15

CN Pinouts: See Table 3-16

WSB-9454 PCIMG 1.0 CPU Card

The WSB-9454 CPU card has two internal high-speed UART connectors accessed through a 10-pin cable connector.

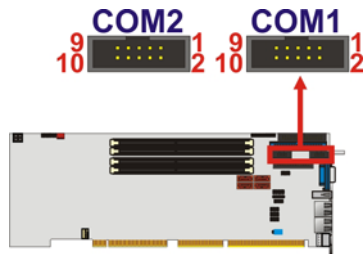

Figure 3-15: RS-232 Serial Port Connectors Location

Pin	Description	Pin	Description
1	DATA CARRIER DETECT (DCD)	6	DATA SET READY (DSR)
2	RECEIVE DATA (RXD)	7	REQUEST TO SEND (RTS)
3	TRANSMIT DATA (TXD)	8	CLEAR TO SEND (CTS)
4	DATA TERMINAL READY (DTR)	9	RING INDICATOR (RI)
5	GND (GND)	10	GND (GND)

Table 3-16: RS-232 Serial Port Connectors Pinouts

3.2.15 SATA Drive Connectors

CN Label: SATA1, SATA2, SATA3, SATA4

CN Type: 7-pin SATA drive connector

CN Location: See Figure 3-16

CN Pinouts: See Table 3-17

The SATA drive ports are connect to SATA HDDs with SATA signal cables. The SATA II connectors provide connectivity with a maximum data transfer rate of 300Mb/s.

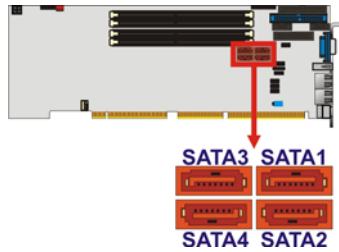

Figure 3-16: SATA Connectors Location

Pin	Description	Pin	Description
1	GND	5	RX-
2	TX+	6	RX+
3	TX-	7	GND
4	GND	8	N/C

Table 3-17: SATA Connectors Pinouts



CAUTION:

Your SATA hard drives may come with both a 4P power connector and a SATA power interface. Attach either the 4P connector or the included SATA power cable to your SATA hard drives. **DO NOT** attach both the power connectors to your SATA hard drives at the same time! Doing so will cause damage.



NOTE:

SATA is supported by:

- Windows® 2000 SP4
- Windows® XP SP1
- Windows® 2003, or later versions

Older OSes, such as Windows® 98SE or Me, do not support the SATA interface.

WSB-9454 PCIMG 1.0 CPU Card

3.2.16 USB Connectors

- CN Label:** USB01, USB23, USB45
- CN Type:** 8-pin header
- CN Location:** See Figure 3-17
- CN Pinouts:** See Table 3-18

Three 2x4 pin connectors provide connectivity to six USB 2.0 ports. An additional USB port is found on the rear panel. The USB ports are used for I/O bus expansion.

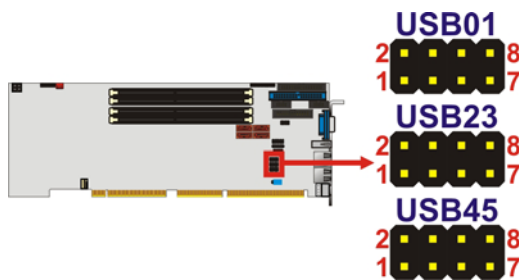

Figure 3-17: USB Port Connector Location

Pin	Description	Pin	Description
1	VCC	2	GND
3	DATA-	4	DATA+
5	DATA+	6	DATA-
7	GND	8	VCC

Table 3-18: USB Port Connector Pinouts

3.3 External Peripheral Interface Connectors

Figure 3-18 shows the WSB-9454 CPU card rear panel. The peripheral connectors on the back panel can be connected to devices externally when the CPU card is installed in a chassis. The peripheral connectors on the rear panel are:

- 1 x PS/2 keyboard connector
- 1 x USB connectors
- 2 x RJ-45 GbE connectors
- 1 x VGA connector

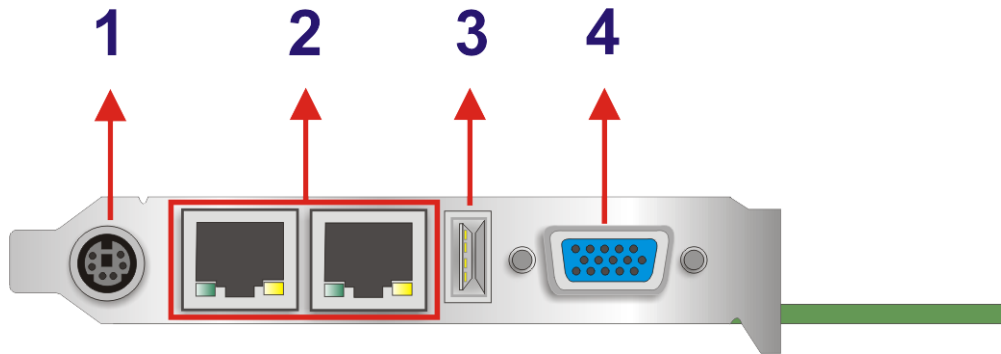

Figure 3-18: External Peripheral Interface Connector Panel

3.3.1 LAN Connectors

- CN Label:** LAN1 and LAN2
- CN Type:** RJ-45
- CN Location:** See Figure 3-18 (labeled number 2)
- CN Pinouts:** See Table 3-19

The WSB-9454 is equipped with two built-in GbE Ethernet controllers. The controllers can connect to the LAN through two RJ-45 LAN connectors. There are two LEDs on the connector indicating the status of LAN. The pin assignments are listed in the following table:

Pin	Description	Pin	Description
1	MDIA3-	5	MDIA2+
2	MDIA3+	6	MDIA1+
3	MDIA1-	7	MDIA0-
4	MDIA2-	8	MDIA0+

Table 3-19: LAN Pinouts

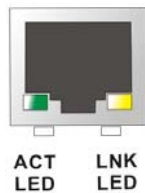

Figure 3-19: RJ-45 Ethernet Connector

WSB-9454 PCIMG 1.0 CPU Card

The RJ-45 Ethernet connector has two status LEDs, one green and one yellow. The green LED indicates activity on the port and the yellow LED indicates the port is linked. See Table 3-20.

STATUS	DESCRIPTION	STATUS	DESCRIPTION
GREEN	Activity	YELLOW	Linked

Table 3-20: RJ-45 Ethernet Connector LEDs

3.3.2 Mini-DIN 6 PS/2 Connector

- CN Label:** KB_MS1
- CN Type:** Mini-DIN 6 PS/2
- CN Location:** See Figure 3-18 (labeled number 1)
- CN Pinouts:** See Table 3-21

The WSB-9454CPU card has a mini-DIN 6 PS/2 connector on the mounting bracket for easy connection to a PS/2 keyboard or PS/2 mouse. The card comes with a cable to convert the mini-DIN 6 PS/2 into two mini-DIN 6 PS/2 connectors for keyboard and mouse connection.

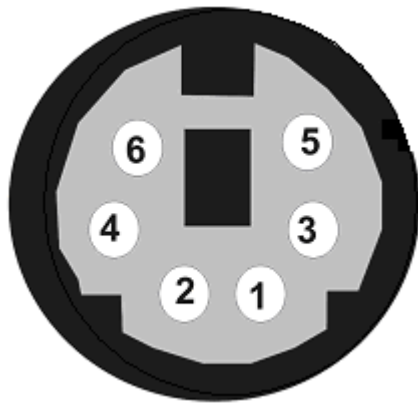

Figure 3-20: Mini-DIN 6 PS/2 Connector

Pin	Description
1	Keyboard Data
2	Mouse Data
3	GND

Pin	Description
4	VCC
5	Keyboard Clock
6	Mouse Clock

Table 3-21: Mini-DIN 6 PS/2 Connector

3.3.3 USB Connector

- CN Label:** USB_C6
- CN Type:** USB port
- CN Location:** See Figure 3-18 (labeled number 3)
- CN Pinouts:** See Table 3-22

The WSB-9454 has one rear panel USB port. This port connects to both USB 2.0 and USB 1.1 devices.

Pin	Description
1	VCC
2	DATA-
3	DATA+
4	GROUND

Table 3-22: USB Port Pinouts

3.3.4 VGA connector

- CN Label:** VGA1
- CN Type:** HD-D-sub 15 female connector
- CN Location:** See Figure 3-18 (labeled number 4)
- CN Pinouts:** See Table 3-23

A 15-pin VGA connector connects to standard displays.

WSB-9454 PCIMG 1.0 CPU Card

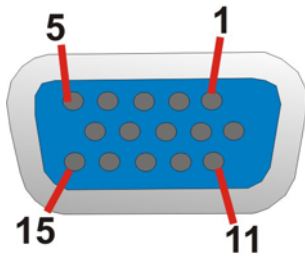

Figure 3-21: VGA Connector

Pin	Description	Pin	Description
1	RED	2	GREEN
3	BLUE	4	NC
5	GND	6	GND
7	GND	8	GND
9	VCC	10	GND
11	NC	12	DDCDAT
13	HSYNC	14	VSYNC
15	DDCCLK		

Table 3-23: VGA Connector Pinouts

Chapter

4

Installation and Configuration

WSB-9454 PCIMG 1.0 CPU Card

4.1 Anti-static Precautions

Electrostatic discharge (ESD) can cause serious damage to electronic components, including the WSB-9454. (Dry climates are especially susceptible to ESD.) It is therefore critical that whenever the WSB-9454 (or any other electrical component) is handled, the following anti-static precautions are strictly adhered to.

- **Wear an anti-static wrist band:** Wearing a simple anti-static wrist band can help to prevent ESD from damaging the board.
- **Self-grounding:** Before handling the board, touch any grounded conducting material. During the time the board is handled, frequently touch any conducting materials that are connected to the ground.

4.2 Installation Considerations



NOTE:

The following installation notices and installation considerations should be read and understood before the CPU card is installed. All installation notices pertaining to the installation of the CPU card should be strictly adhered to. Failing to adhere to these precautions may lead to severe damage of the CPU card and injury to the person installing the CPU card.

4.2.1 Installation Notices

Before and during the installation of the WSB-9454 CPU card, please **do** the following:

- Read the user manual
 - The user manual provides a complete description of the WSB-9454 CPU card, installation instructions and configuration options.
- Wear an electrostatic discharge cuff (ESD)
 - Electronic components are easily damaged by ESD. Wearing an ESD cuff will remove ESD from your body and help to prevent ESD damage to the CPU card.

- Place the CPU Card on an antistatic pad
 - When you are installing or configuring the CPU Card, place it on an antistatic pad. This will help to prevent potential ESD damage.
- Turn off all power to the WSB-9454 CPU card
 - When working with the CPU card, make sure that it is disconnected from all power supplies and that no electricity is being fed into the system.

Before and during the installation of the WSB-9454 CPU card **DO NOT** do the following:

- **DO NOT** remove any of the stickers on the PCB board. These stickers are required for warranty validation.
- **DO NOT** use the product before you have verified that all cables and power connectors are properly connected.
- **DO NOT** allow screws to come in contact with the PCB circuit, connector pins, or its components.

4.3 Unpacking



NOTE:

If any of the items listed below are missing when you unpack the WSB-9454 CPU card, do not proceed with the installation and contact the reseller or vendor you purchased the CPU card from.

4.3.1 Unpacking Precautions

Before you install the WSB-9454 CPU card, you must unpack the CPU card. Some components on WSB-9454 are very sensitive to static electricity and can be damaged by a sudden rush of power. To protect it from being damage, follow these precautions:

- Ground yourself to remove any static charge before touching your WSB-9454 . You can do so by wearing a grounded wrist strap at all times or by frequently touching any conducting materials that is connected to the ground.
- Handle your WSB-9454 by its edges. Do not touch the IC chips, leads or circuitry if not necessary.

WSB-9454 PCIMG 1.0 CPU Card

Do not place a PCB on top of an anti-static bag. Only the inside of the bag is safe from static discharge.

4.3.2 Checklist

When you unpack the WSB-9454, please make sure that your package contains the following items.

- 1 x WSB-9454 single board computer
- 1 x Mini jumper pack
- 1 x ATA 66/100 flat cable
- 1 x Dual RS-232 cable
- 2 x SATA cables
- 1 x SATA power cable
- 1 x Keyboard/ PS2 mouse Y cable
- 1 x USB cable
- 1 x Utility CD
- 1 x QIG (quick installation guide)

If one or more of these items are missing, please contact the reseller or vendor you purchased the WSB-9454 CPU card from and do not proceed any further with the installation.

4.4 WSB-9454 CPU Card Installation



WARNING:

Never run the CPU card without an appropriate heatsink and cooler that can be ordered from IEI or purchased separately. Be sure to use the CPU 12V power connector (CPU12V1) for the CPU power.

**WARNING:**

Please note that the installation instructions described in this manual must be carefully followed in order to avoid damage to the CPU card components and injury to you.

**WARNING:**

When installing electronic components onto the CPU card always follow the previously outlined anti-static precautions in order to prevent ESD damage to your board and other electronic components like the CPU and DIMM modules

The following components must be installed onto the CPU card or connected to the CPU card during the installation process.

- CPU
- CPU cooling kit
- DDR2 memory modules
- Peripheral devices

4.4.1 CPU Installation**WARNING:**

CPUs are expensive and sensitive components. When installing the CPU please be careful not to damage it in anyway. Make sure the CPU is installed properly and ensure that a heat sink and CPU cooling fan are properly installed before the WSB-9454 is run.

If a heat sink and cooling fan are not properly installed both the CPU and the board may be damaged.

WSB-9454 PCIMG 1.0 CPU Card

The LGA775 socket is shown in Figure 4-1.

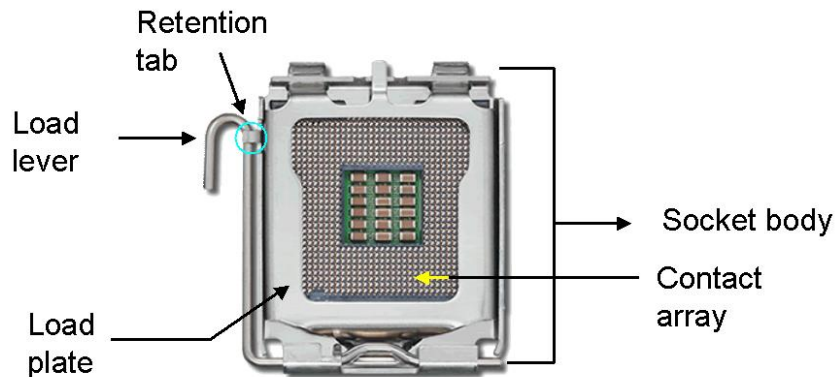

Figure 4-1: Intel® LGA775 Socket



WARNING:

When handling the CPU, only hold it on the sides. DO NOT touch the pins at the bottom of the CPU.

To install Socket LGA775 CPU onto the WSB-9454, follow the steps below:

Step 1: Remove the protective cover. Remove the black protective cover by prying it off the load plate. To remove the protective cover, locate the “**REMOVE**” sign and use the fingernail to pry the protective cover off. (See Figure 4-2)

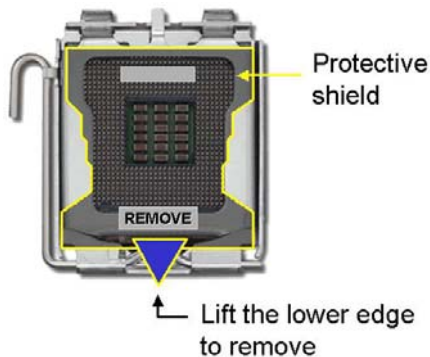

Figure 4-2: Remove the CPU Socket Protective Shield

Step 2: Open the socket. Disengage the load lever by pressing the lever down and slightly outward to clear the retention tab. Rotate the load lever to a fully open position. Then rotate the load plate towards the opposite direction. (See Figure 4-3)

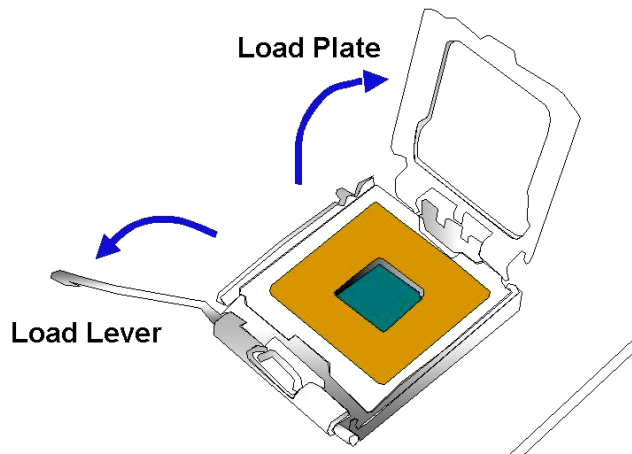

Figure 4-3: Open the CPU Socket Load Plate

Step 3: Inspect the CPU socket Make sure there are no bent pins and make sure the socket contacts are free of foreign material. If any debris is found, remove it with compressed air.

Step 4: Orientate the CPU properly. Make sure the IHS (Integrated Heat Sink) side is facing upward.

Step 5: Correctly position the CPU. Match the Pin 1 mark with the cut edge on the CPU socket.

Step 6: Align the CPU pins. Locate pin 1 and the two orientation notches on the CPU. Carefully match the two orientation notches on the CPU with the socket alignment keys.

Step 7: Insert the CPU. Gently insert the CPU into the socket. If the CPU pins are properly aligned, the CPU should slide into the CPU socket smoothly. See Figure 4-4.

WSB-9454 PCIMG 1.0 CPU Card

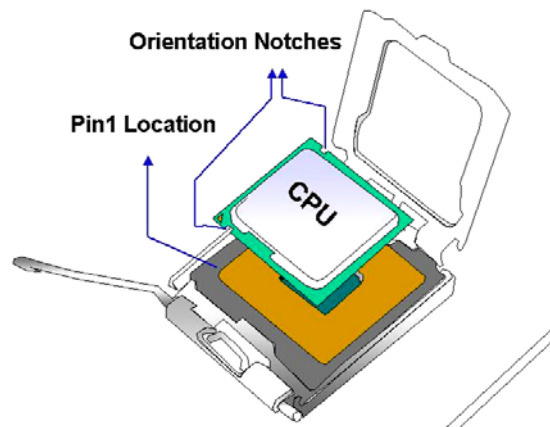

Figure 4-4: Insert the Socket LGA775 CPU

- Step 8: Close the CPU socket.** Close the load plate and engage the load lever by pushing it back to its original position. Secure the load lever under the retention tab on the side of CPU socket.
- Step 9: Connect the CPU power connector.** Connect the CPU 12V cable to the CPU 12V power connector after the cooling kit is installed.

4.4.2 Cooling Kit Installation



WARNING:

It is strongly recommended that you DO NOT use the original heat sink and cooler provided by Intel on the WSB-9454.

The WSB-9454 is vertically mounted on a horizontal backplane. Intel's heat sink does not come with a support bracket on the soldering side, so the PCB may be bent by the weight of the cooling kit.

IEI's cooling kit (CF-520) includes a support bracket that is combined with the heat sink mounted on the CPU to counterweigh and balance the load on both sides of the PCB.



Figure 4-5: Cooling Kit

The cooling kit comprises a CPU heat sink and a cooling fan.



NOTE:

Do not wipe off (accidentally or otherwise) the pre-sprayed layer of thermal paste on the bottom of the heat sink. The thermal paste between the CPU and the heat sink is important for optimum heat dissipation.

To install the cooling kit, follow the instructions below.

- Step 1:** Place the cooling kit onto the socket LGA775 CPU. Make sure the CPU cable can be properly routed when the cooling kit is installed.
- Step 2:** Properly align the cooling kit. Make sure the four spring screw fasteners can pass through the pre-drilled holes on the PCB.
- Step 3:** Mount the cooling kit. Gently place the cooling kit on top of the CPU. Make sure the four threaded screws on the corners of the cooling kit properly pass through the predrilled holes on the bottom of the PCB.
- Step 4:** Secure the cooling kit. From the solder side of the PCB, align the support bracket to the screw threads on heat sink that were inserted through the PCB holes. (See Figure 4-6)

WSB-9454 PCIMG 1.0 CPU Card

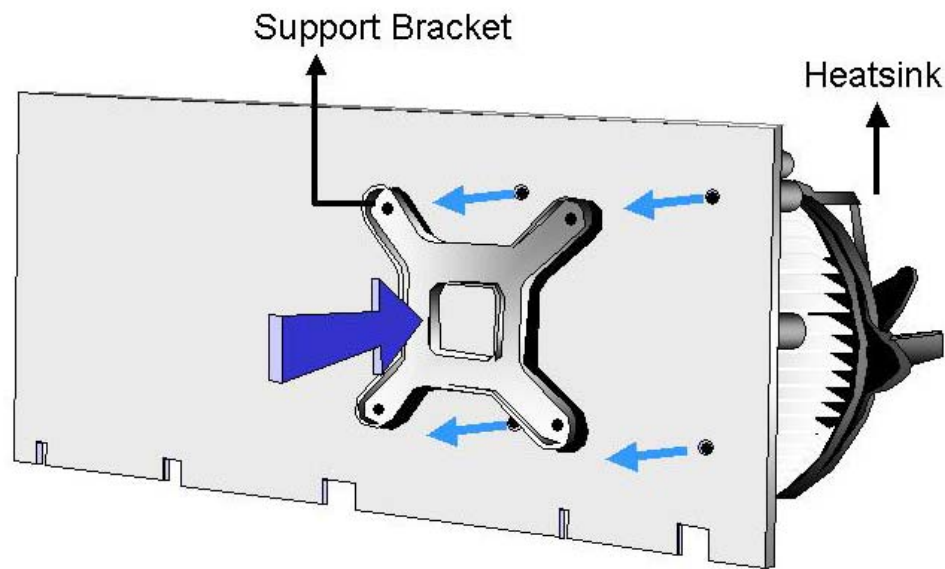

Figure 4-6: Securing the Heat sink to the PCB

- Step 5: Tighten the screws.** Use a screwdriver to tighten the four screws. Tighten each nut a few turns at a time and do not over-tighten the screws.
- Step 6: Connect the fan cable.** Connect the cooling kit fan cable to the fan connector on the WSB-9454. Carefully route the cable and avoid heat generating chips and fan blades.

4.4.3 DIMM Module Installation

The WSB-9454 CPU card has four 240-pin DDR2 SDRAM DIMM sockets. To install the DIMM modules, follow the instructions below.

- Step 1:** Make sure the two handles of the DIMM socket are in the "open" position, leaning outward (Figure 4-7).

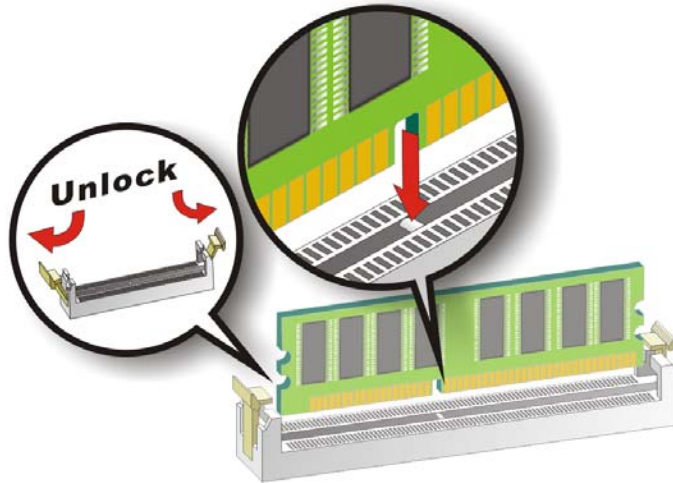

Figure 4-7: Installing the DIMM Module

- Step 2:** Slowly slide the DIMM module along the plastic guides on both ends of the socket. Press the DIMM module down into the socket until it clicks into position and the two handles have automatically locked the memory module into place.
- Step 3:** To remove the memory module, push both handles outward, and the memory module is ejected by the mechanism in the socket.

4.5 Peripheral Device Connection

Cables provided by IEI that connect peripheral devices to the CPU Card are listed in Table 4-1. Cables not included in the kit must be separately purchased.

Quantity	Type
1	ATA 66/100 flat cable
2	SATA cables
1	SATA power cable
1	Keyboard/ PS2 mouse Y cable
1	RS-232 cable

WSB-9454 PCIMG 1.0 CPU Card

Quantity	Type
1	USB cable

Table 4-1: IEI Provided Cables

4.5.1 IDE Drive Connector

The cable used to connect the motherboard to the IDE device is a standard 40-pin ATA/100 flat cable. To connect an IDE device to the motherboard, follow the instructions below.

- Step 1:** Find the IDE flat cable in the kit that came with the motherboard.
- Step 2:** Connect one end of the cable to the IDE connector on the motherboard. A keyed pin on the IDE connector prevents it from being connected incorrectly.
- Step 3:** Locate the red wire on the other side of the cable that corresponds to the pin 1 connector.
- Step 4:** Connect the other side of the cable to the IDE device making sure that the pin 1 cable corresponds to pin 1 on the connector.

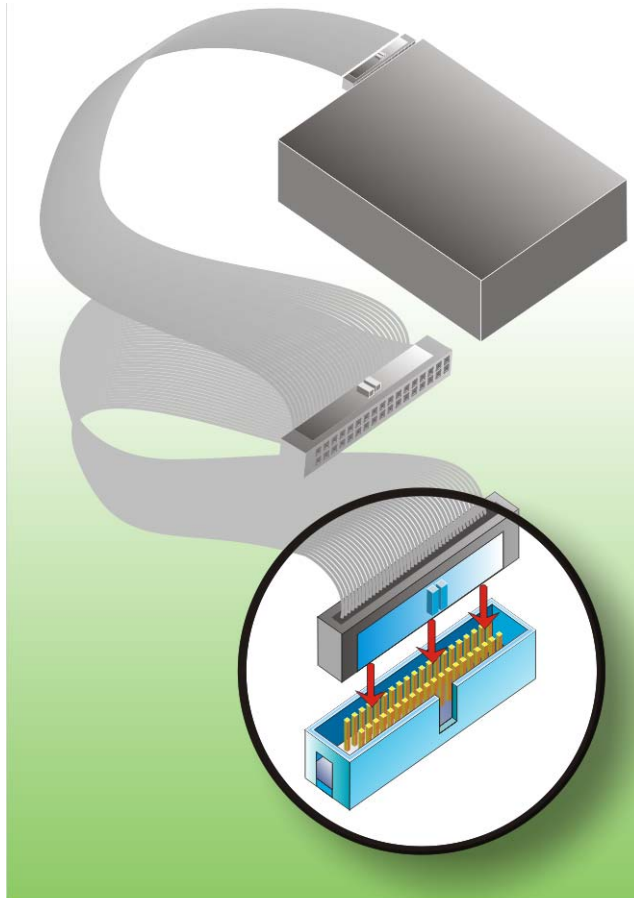

Figure 4-8: Connection of IDE Connector



NOTE:

When two IDE disk drives are connected together, back-end jumpers on the drives must be used to configure one drive as a master and the other as a slave.

4.5.2 Floppy Drive Connector

This connector provides access to an externally mounted 3.5" floppy drive. To connect the CPU Card to a FDD, follow the instructions below.

Step 1: Insert one side of the cable into the FDC making sure that the red wire on the cable corresponds to pin 1 on the connector.

WSB-9454 PCIMG 1.0 CPU Card

Step 2: Attach the connector on the other side of the cable to the floppy drive(s). You can only use one connector in the set. The connection sequence determines which of the two connected floppy drives is drive A and which is drive B.

4.5.3 SATA Drive Connection

The CPU card has on-board SATA drive connectors. Refer to Table 1-1: for model variations supporting two or four SATA II connectors. To connect the SATA drives to the connectors, follow the steps below.

Step 1: Locate the SATA drive connector on the board.

Step 2: Press the clip on the connector at the end of the SATA cable and insert the cable connector into the on-board SATA drive connector (Figure 4-9).

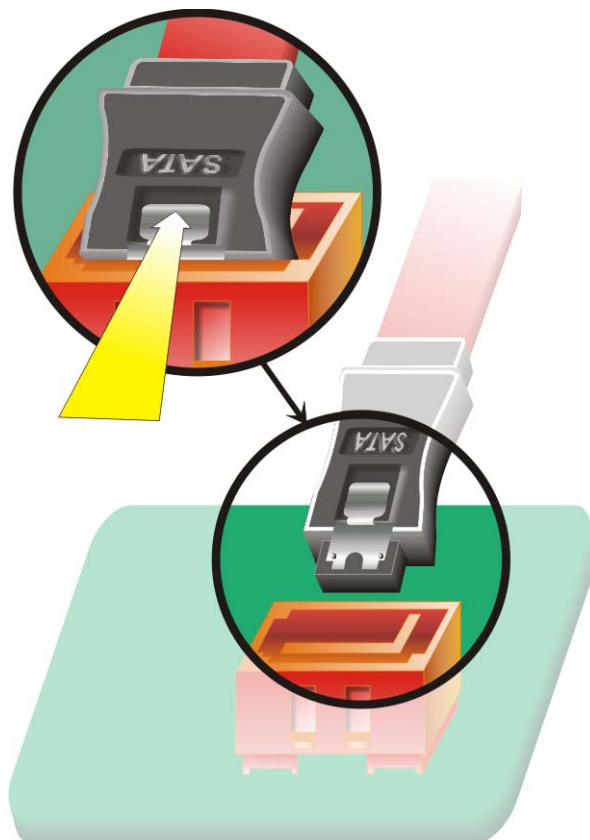

Figure 4-9: SATA Drive Cable Connection

Step 3: Connect the connector on the other end of the cable to the connector at the back of the SATA drive (Figure 4-10).

Step 4: Connect the SATA power connector to the back of the SATA drive (Figure 4-10).

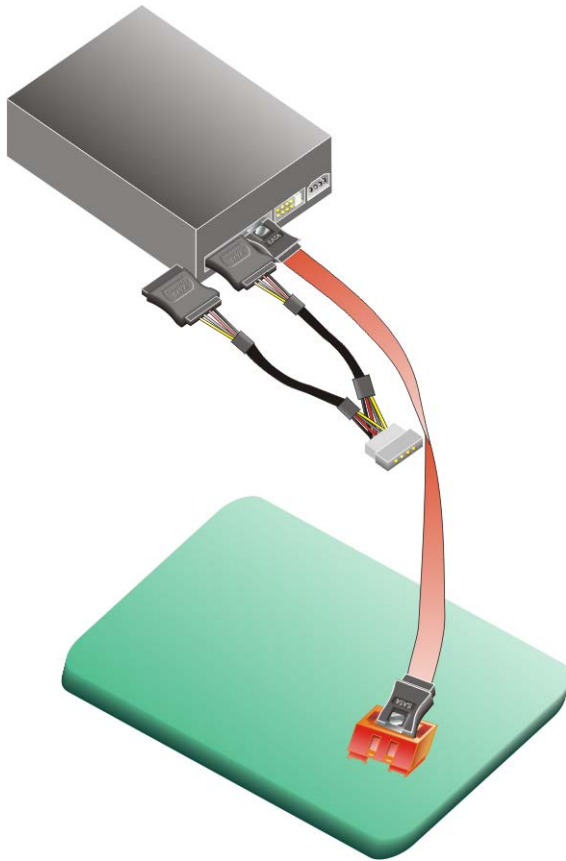

Figure 4-10: SATA Drive Connection

4.5.4 Installing the RS-232 Cable

A dual RS-232 cable consisting of two cables attached to two D-sub 9 male connectors that are mounted onto a bracket can be connected to the COM1 and COM2 RS-232 connectors. To install an RS-232 cable, follow the steps below.

Step 1: Locate the two RS-232 serial port connectors.

Step 2: Insert the two small connectors on the cables into the serial port box headers on the CPU card (Figure 4-11).

WSB-9454 PCIMG 1.0 CPU Card

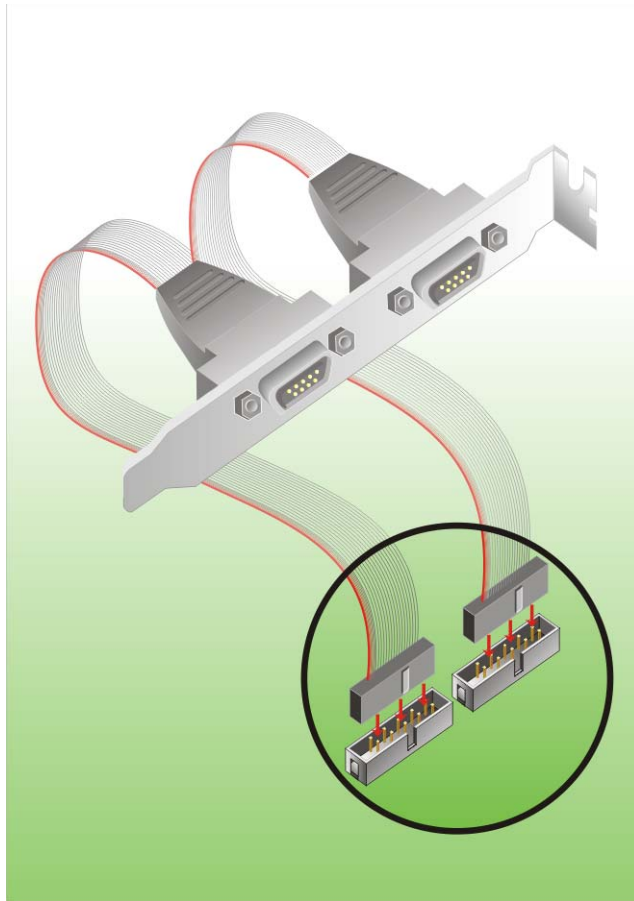

Figure 4-11: Dual RS-232 Cable Installation

- Step 3:** Secure the bracket supporting the two D-sub 9 male connectors to the chassis. To do this, refer to the chassis manual.

4.5.5 USB 2.0 Cable Connection

The CPU card is shipped with a dual USB cable. The dual USB cable consists of two connectors attached to two independent cables. Each cable is then attached to a USB port connector that is mounted on a bracket. To install the USB cable, follow the steps below.

- Step 1:** Install a USB module supporting two USB ports to the chassis. Secure the USB module bracket following the instructions in the documentation that came with the USB module and the chassis.

Step 2: Insert the two 4-pin connectors from the module into the USB pin headers on the CPU card. (Figure 4-12)

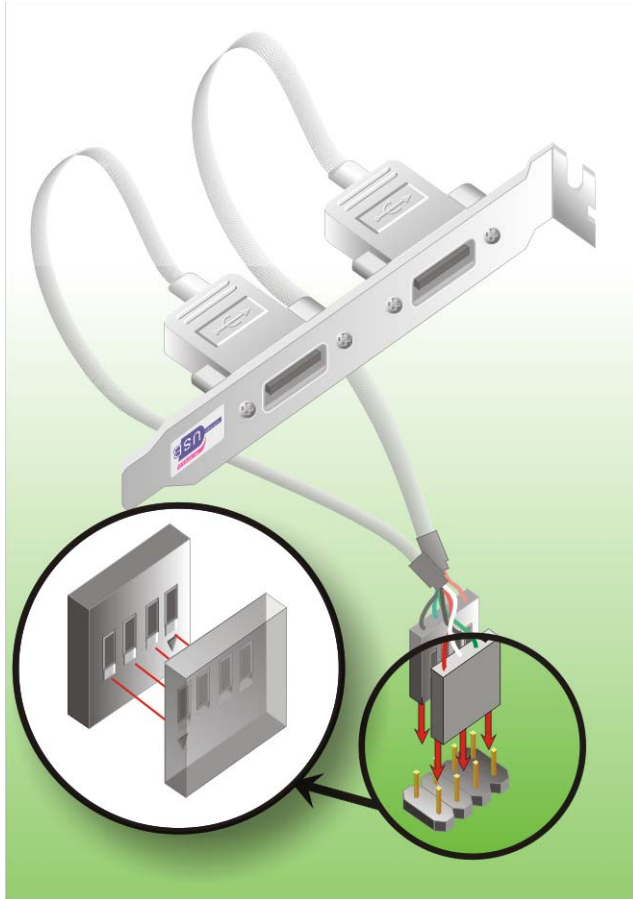

Figure 4-12: USB Cable Installation

WSB-9454 PCIMG 1.0 CPU Card

4.6 On-board Jumper



NOTE:

A jumper is a metal bridge that is used to close an electrical circuit. It consists of two metal pins and a small metal clip (often protected by a plastic cover) that slides over the pins to connect them. To CLOSE/SHORT a jumper means connecting the pins of the jumper with the plastic clip and to OPEN a jumper means removing the plastic clip from a jumper.

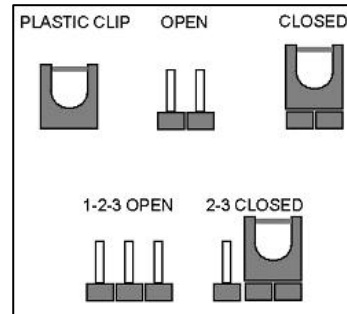

The CPU card has the following on-board jumpers. The jumpers are described in Table 4-2.

Label	Connector	Type
J_CMOS1	CMOS state setting	3-pin header
JSPI1	SPI Flash Connector	8-pin header

Table 4-2: On-board Jumpers

4.6.1 Clear CMOS Jumper

- Jumper Label:** J_CMOS1
- Jumper Type:** 3-pin header
- Jumper Settings:** See Table 4-3
- Jumper Location:** See Figure 4-13

If the CPU card fails to boot due to improper BIOS settings, use this jumper to clear the CMOS data and reset the system BIOS information. To do this, use the jumper cap to close pins 2 and 3 for a few seconds then reinstall the jumper clip back to pins 1 and 2.

If the “CMOS Settings Wrong” message is displayed during the boot up process, the fault may be corrected by pressing the F1 to enter the CMOS Setup menu. Do one of the following:

- Enter the correct CMOS setting
- Load Optimal Defaults
- Load Failsafe Defaults.

After having done one of the above, save the changes and exit the CMOS Setup menu.

Pin	Description
1-2	Normal Operation
2-3	Clear CMOS Setup

Table 4-3: Clear CMOS Jumper Settings

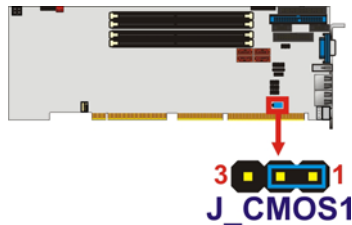

Figure 4-13: Clear CMOS Jumper Location

4.6.2 SPI Flash Connector

- Jumper Label:** JSPI1
- Jumper Type:** 8-pin header (2x4)
- Jumper Settings:** See Table 4-4
- Jumper Location:** See Figure 4-14

The 8-pin SPI Flash connector is used to flash the BIOS.

Pin	Description	Pin	Description
1	SPI_VCC	5	GND
2	SPI_CS0	6	SPI_CLK
3	SPI_MISO	7	SPI_MOSI
4	NC	8	NC

Table 4-4: SPI Flash Connector Settings

WSB-9454 PCIMG 1.0 CPU Card

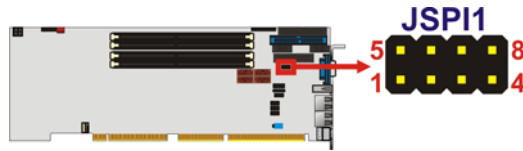

Figure 4-14: SPI Flash Connector Location

4.7 Chassis Installation

After the CPU, the cooling kit, and the DIMM modules have been installed and after the internal peripheral connectors have been connected to the peripheral devices and the jumpers have been configured, the CPU card can be mounted into a chassis.

To mount the CPU card into a chassis please refer to the chassis user guide that came with the product.

4.8 Rear Panel Connectors

4.8.1 Keyboard and Mouse Connection

A PS/2 keyboard and a PS/2 mouse can be connected to the appropriate PS/2 connector on the rear panel.

4.8.2 VGA Port Installation

The cable used to connect the motherboard to a VGA port is a 10-pin header to female HD-D-sub 15 connector. To connect a VGA port to the motherboard, follow the instructions below.

Step 1: Connect a standard male HD-D-sub 15 connector end to the VGA connector on the rear panel.

Step 2: Connect the other end to a display device.

4.8.3 Ethernet Connection

The rear panel RJ-45 connectors can be connected to an external LAN and communicate with data transfer rates up to 1 Gb/s.

4.8.4 USB Connection

The rear panel USB connector provides easier and quicker access to external USB devices. The rear panel USB connector is a standard connector and can easily be connected to other USB devices.

Chapter

5

BIOS

5.1 Introduction

The BIOS is programmed onto the BIOS chip. The BIOS setup program allows changes to certain system settings. This chapter outlines the options that can be changed.



NOTE:

Some of the BIOS options may vary throughout the life cycle of the product and are subject to change without prior notice.

5.1.1 Starting Setup

The AMI BIOS is activated when the computer is turned on. The setup program can be activated in one of two ways.

1. Press the **DELETE** key as soon as the system is turned on or
2. Press the **DELETE** key when the “**Press Del to enter SETUP**” message appears on the screen.

If the message disappears before the **DELETE** key is pressed, restart the computer and try again.

5.1.2 Using Setup

Use the arrow keys to highlight items, press **ENTER** to select, use the PageUp and PageDown keys to change entries, press **F1** for help and press **Esc** to quit. Navigation keys are shown in.

Key	Function
Up arrow	Move to previous item
Down arrow	Move to next item
Left arrow	Move to the item on the left hand side
Right arrow	Move to the item on the right hand side
Esc key	Main Menu – Quit and not save changes into CMOS Status Page Setup Menu and Option Page Setup Menu -- Exit current page and return to Main Menu

WSB-9454 PCIMG 1.0 CPU Card

Key	Function
Page Up key	Increase the numeric value or make changes
Page Dn key	Decrease the numeric value or make changes
F1 key	General help, only for Status Page Setup Menu and Option Page Setup Menu
F2 /F3 key	Change color from total 16 colors. F2 to select color forward.
F10 key	Save all the CMOS changes, only for Main Menu

Table 5-1: BIOS Navigation Keys

5.1.3 Getting Help

When **F1** is pressed a small help window describing the appropriate keys to use and the possible selections for the highlighted item appears. To exit the Help Window press **Esc** or the **F1** key again.

5.1.4 Unable to Reboot After Configuration Changes

If the computer cannot boot after changes to the system configuration is made, CMOS defaults. Use the jumper described in Chapter 5.

5.1.5 BIOS Menu Bar

The **menu bar** on top of the BIOS screen has the following main items:

- Main – Changes the basic system configuration.
- Advanced – Changes the advanced system settings.
- PCIPnP – Changes the advanced PCI/PnP Settings
- Boot – Changes the system boot configuration.
- Security – Sets User and Supervisor Passwords.
- Chipset – Changes the chipset settings.
- Power – Changes power management settings.
- Exit – Selects exit options and loads default settings

The following sections completely describe the configuration options found in the menu items at the top of the BIOS screen and listed above.

5.2 Main

The **Main** BIOS menu (BIOS Menu 1) appears when the **BIOS Setup** program is entered. The **Main** menu gives an overview of the basic system information.

```

BIOS SETUP UTILITY
Main  Advanced  PCIPNP  Boot  Security  Chipset  Exit
-----
System Overview
-----
AMIBIOS
Version      :08.00.13
Build Date   :01/12/09
ID:          :B126MR14

Processor
Type         :Intel® Pentium® 4 CPU 3.60GHz
Speed        :3600MHz
Count        :1

System Memory
Size         :2040MB

System Time           [14:20:27]
System Time           [Tue 05/06/2008]

v02.61 ©Copyright 1985-2006, American Megatrends, Inc.

Use [ENTER], [TAB] or [SHIFT-TAB] to select a field.
Use [+] or [-] to configure system time.

←→ Select Screen
↑↓ Select Item
Enter Go to SubScreen
F1  General Help
F10 Save and Exit
ESC Exit
    
```

BIOS Menu 1: Main

- **System Overview**

The **System Overview** lists a brief summary of different system components. The fields in **System Overview** cannot be changed. The items shown in the system overview include:

- AMI BIOS: Displays auto-detected BIOS information
 - **Version:** Current BIOS version
 - **Build Date:** Date the current BIOS version was made
 - **ID:** Installed BIOS ID
- Processor: Displays auto-detected CPU specifications
 - **Type:** Names the currently installed processor
 - **Speed:** Lists the processor speed
 - **Count:** The number of CPUs on the motherboard
- System Memory: Displays the auto-detected system memory.
 - **Size:** Lists memory size

WSB-9454 PCIMG 1.0 CPU Card

The System Overview field also has two user configurable fields:

- **System Time [xx:xx:xx]**

Use the **System Time** option to set the system time. Manually enter the hours, minutes and seconds.

- **System Date [xx/xx/xx]**

Use the **System Date** option to set the system date. Manually enter the day, month and year.

5.3 Advanced

Use the **Advanced** menu (BIOS Menu 2) to configure the CPU and peripheral devices through the following sub-menus:



WARNING!

Setting the wrong values in the sections below may cause the system to malfunction. Make sure that the settings made are compatible with the hardware.

-
- CPU Configuration (see **Section 5.3.1**)
 - IDE Configuration (see **Section 5.3.2**)
 - Floppy Configuration (see **Section 5.3.3**)
 - Super IO Configuration (see **Section 5.3.4**)
 - Hardware Health Configuration (see **Section 5.3.5**)
 - Power Function (see **Section 5.3.6**)
 - Remote Access Configuration (see **Section**)
 - USB Configuration (see **Section 5.3.8**)

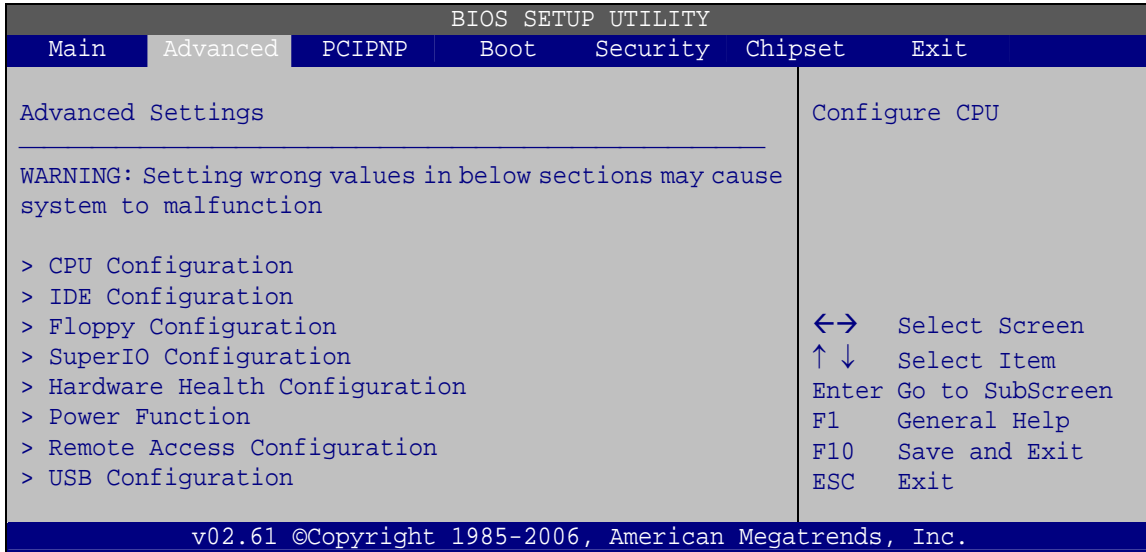

BIOS Menu 2: Advanced

5.3.1 CPU Configuration

Use the **CPU Configuration** menu (BIOS Menu 3) to view detailed CPU specifications and configure the CPU.

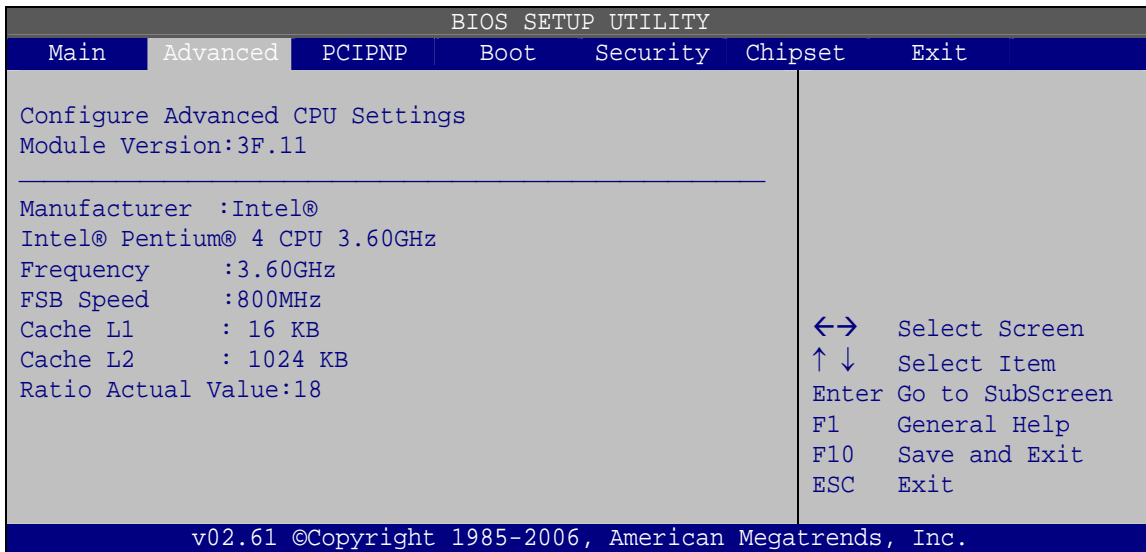

BIOS Menu 3: CPU Configuration

The CPU Configuration menu (BIOS Menu 3) lists the following CPU details:

- Manufacturer: Lists the name of the CPU manufacturer
- Brand String: Lists the brand name of the CPU being used

WSB-9454 PCIMG 1.0 CPU Card

- Frequency: Lists the CPU processing speed
- FSB Speed: Lists the FSB speed
- Cache L1: Lists the CPU L1 cache size
- Cache L2: Lists the CPU L2 cache size

5.3.2 IDE Configuration

Use the **IDE Configuration** menu (BIOS Menu 4) to change and/or set the configuration of the IDE devices installed in the system.

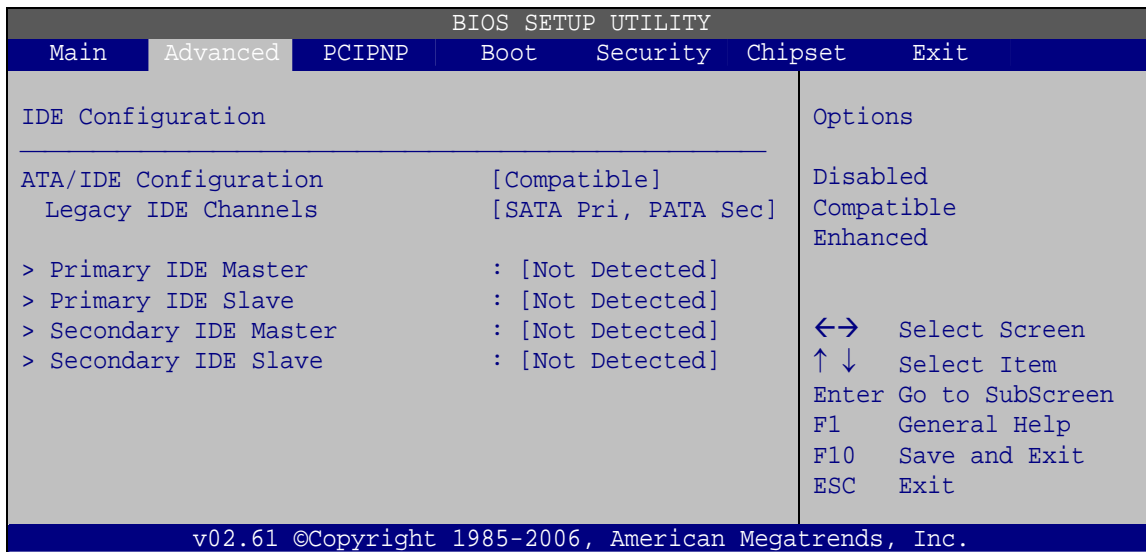

BIOS Menu 4: IDE Configuration

- **ATA/IDE Configurations [Compatible]**

Use the **ATA/IDE Configurations** option to configure the ATA/IDE controller.

- ➔ **Disabled** Disables the on-board ATA/IDE controller.
- ➔ **Compatible** Configures the on-board ATA/IDE controller to be in compatible mode. In this mode, a SATA channel will replace one of the IDE channels. This mode supports up to 4 storage devices.

➔ **Enhanced** **DEFAULT** Configures the on-board ATA/IDE controller to be in Enhanced mode. In this mode, IDE channels and SATA channels are separated. This mode supports up to 6 storage devices. Some legacy OS do not support this mode.

- **Configure SATA as [IDE]**

Use the **Configure SATA as** option to configure SATA devices as normal IDE devices.

➔ **IDE** **DEFAULT** Configures SATA devices as normal IDE device.

- **Configure SATA Channels [Behind PATA]**

Use the **Configure SATA Channels** option to determine how SATA channels and PATA channels are ordered.

➔ **Before PATA** Puts SATA channels before PATA channels.

➔ **Behind PATA** **DEFAULT** Puts SATA channels behind PATA channels.

- **Legacy IDE Channels [PATA Pri, SATA Sec]**

➔ **SATA Only** Only the SATA drives are enabled.

➔ **PATA Pri, SATA Sec** **DEFAULT** The IDE drives are enabled on the Primary IDE channel. The SATA drives are enabled on the Secondary IDE channel.

➔ **PATA Pri., PATA Sec** The IDE drives are enabled on the primary and secondary IDE channels. SATA drives are disabled.

- **OnBoard PCI IDE Controller [Both]**

Use the **OnBoard PCI IDE Controller** BIOS option to specify the IDE channels used by the onboard PCI IDE controller. The following configuration options are available.

WSB-9454 PCIMG 1.0 CPU Card

- ➔ **Disabled** Prevents the system from using the onboard IDE controller
- ➔ **Primary** Only allows the system to detect the Primary IDE channel, including both the Primary Master and the Primary Slave
- ➔ **Secondary** Only allows the system to detect the Secondary IDE channel, including both the Secondary Master and Secondary Slave
- ➔ **Both** **DEFAULT** Allows the system to detect both the Primary and Secondary IDE channels including the Primary Master, Primary Slave, Secondary Master and Secondary Slave.

- **Onboard PCI IDE Mode [Legacy Mode]**

Use the **Onboard PCI IDE Mode** BIOS option to set the running mode for the PCI IDE.

- ➔ **Legacy Mode** **DEFAULT** The PCI IDE mode is the same as the IDE mode
- ➔ **Native Mode** The PCI IDE mode is the native mode

- **Onboard PCI S-ATA Controller**

Use the **Onboard PCI S-ATA Controller** option to set the onboard SATA controller. If the RAID function is going to be used this option must be set in the **RAID** mode.

- ➔ **Disabled** **DEFAULT** The onboard PCI SATA controller is disabled
- ➔ **Native Mode** The SATA controller is set as an IDE device with an ID at 0181h
- ➔ **Raid Mode** The SATA controller is set as a RAID device with an ID at 0181h

- **IDE Master and IDE Slave**

When entering setup, BIOS auto detects the presence of IDE devices. BIOS displays the status of the auto detected IDE devices. The following IDE devices are detected and are shown in the **IDE Configuration** menu:

- Primary IDE Master
- Primary IDE Slave
- Secondary IDE Master
- Secondary IDE Slave

The **IDE Configuration** menu (BIOS Menu 4) allows changes to the configurations for the IDE devices installed in the system. If an IDE device is detected and one of the above listed four BIOS configuration options are selected, the IDE configuration options shown in **Section 5.3.2.1** appear.

- **Hard Disk Write Protect [Disabled]**

Use the **Hard Disk Write Protect** BIOS option to protect the hard disks from being overwritten. This menu item is only effective if the device is accessed through the BIOS.

- ➔ **Disabled** **DEFAULT** Allows hard disks to be overwritten
- ➔ **Enabled** Prevents hard disks from being overwritten

- **IDE Detect Time Out (Sec) [35]**

Use the **IDE Detect Time Out (Sec)** BIOS to specify the maximum time (in seconds) the AMI BIOS can search for IDE devices. This allows fine-tuning of the settings to allow for faster boot times. The following configuration options are available.

- 0 seconds
- 5 seconds **DEFAULT**
- 10 seconds
- 15 seconds
- 20 seconds
- 25 seconds
- 30 seconds

WSB-9454 PCIMG 1.0 CPU Card

- 35 seconds

The best setting to use if the onboard IDE controllers are set to a specific IDE disk drive in the AMIBIOS is “0 seconds” and a large majority of ultra ATA hard disk drives can be detected well within “5 seconds”.

- **ATA (PI) 80Pin Cable Detection [Host & Device]**

Use the **ATA (PI) 80Pin Cable Detection** option to enable the system to detect the correct cable. When an Ultra ATA/66, an Ultra ATA/100 or an Ultra ATA/133 IDE hard disk drive is used, an 80-conductor ATA cable must be used. The 80-conductor ATA cable is plug compatible with the standard 40-conductor ATA cable. The system must detect the presence of correct cable so that the AMIBIOS can instruct the drive to run at the correct speed for the cable type detected.

- ➔ **Host & Device** **DEFAULT** Both the motherboard onboard IDE controller and IDE disk drive are used to detect the type of IDE cable used.
- ➔ **Host** The motherboard onboard IDE controller detects the type of IDE cable used.
- ➔ **Device** The IDE disk drive detects the type of IDE cable used.

5.3.2.1 IDE Master, IDE Slave

Use the **IDE Master** and **IDE Slave** configuration menu to view both primary and secondary IDE device details and configure the IDE devices connected to the system.

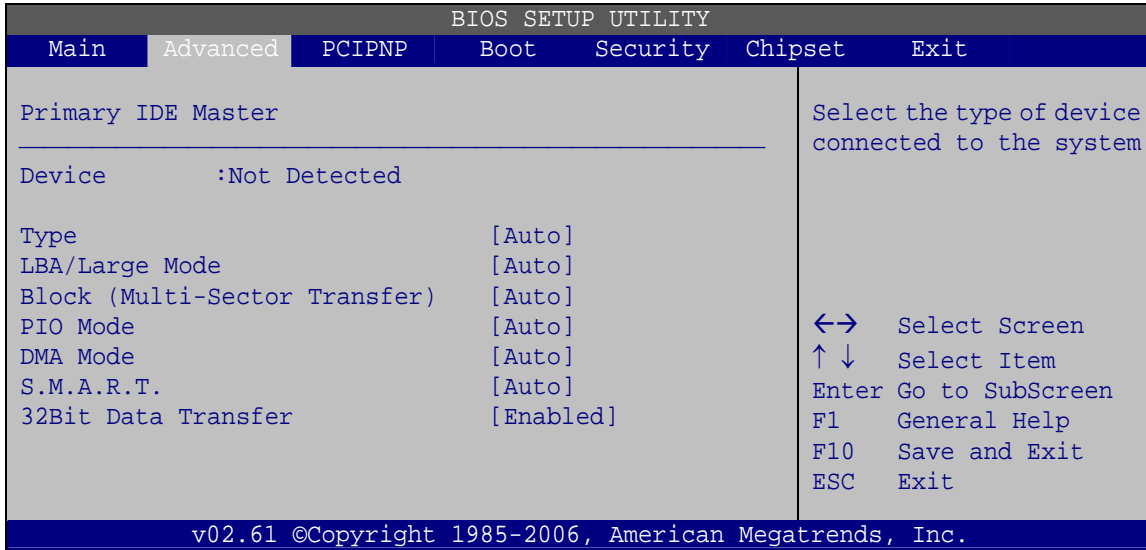

BIOS Menu 5: IDE Master and IDE Slave Configuration

- **Auto-Detected Drive Parameters**

The “grayed-out” items in the left frame are IDE disk drive parameters automatically detected from the firmware of the selected IDE disk drive. The drive parameters are listed as follows:

- Device: Lists the device type (e.g. hard disk, CD-ROM etc.)
- Type: Indicates the type of devices a user can manually select
- Vendor: Lists the device manufacturer
- Size: List the storage capacity of the device.
- LBA Mode: Indicates whether the LBA (Logical Block Addressing) is a method of addressing data on a disk drive is supported or not.
- Block Mode: Block mode boosts IDE drive performance by increasing the amount of data transferred. Only 512 bytes of data can be transferred per interrupt if block mode is not used. Block mode allows transfers of up to 64 KB per interrupt.
- PIO Mode: Indicates the PIO mode of the installed device.
- Async DMA: Indicates the highest Asynchronous DMA Mode that is supported.
- Ultra DMA: Indicates the highest Synchronous DMA Mode that is supported.
- S.M.A.R.T.: Indicates whether or not the Self-Monitoring Analysis and Reporting Technology protocol is supported.
- 32Bit Data Transfer: Enables 32-bit data transfer.

WSB-9454 PCIMG 1.0 CPU Card

- **Type [Auto]**

Use the **Type** BIOS option select the type of device the AMIBIOS attempts to boot from after the Power-On Self-Test (POST) is complete.

- ➔ **Not Installed** BIOS is prevented from searching for an IDE disk drive on the specified channel.
- ➔ **Auto** **DEFAULT** The BIOS auto detects the IDE disk drive type attached to the specified channel. This setting should be used if an IDE hard disk drive is attached to the specified channel.
- ➔ **CD/DVD** The CD/DVD option specifies that an IDE CD-ROM drive is attached to the specified IDE channel. The BIOS does not attempt to search for other types of IDE disk drives on the specified channel.
- ➔ **ARMD** This option specifies an ATAPI Removable Media Device. These include, but are not limited to:
ZIP
LS-120

- **LBA/Large Mode [Auto]**

Use the **LBA/Large Mode** option to disable or enable BIOS to auto detects LBA (Logical Block Addressing). LBA is a method of addressing data on a disk drive. In LBA mode, the maximum drive capacity is 137 GB.

- ➔ **Disabled** BIOS is prevented from using the LBA mode control on the specified channel.
- ➔ **Auto** **DEFAULT** BIOS auto detects the LBA mode control on the specified channel.

- **Block (Multi Sector Transfer) [Auto]**

Use the **Block (Multi Sector Transfer)** to disable or enable BIOS to auto detect if the device supports multi-sector transfers.

- ➔ **Disabled** BIOS is prevented from using Multi-Sector Transfer on the specified channel. The data to and from the device occurs one sector at a time.
- ➔ **Auto** **DEFAULT** BIOS auto detects Multi-Sector Transfer support on the drive on the specified channel. If supported the data transfer to and from the device occurs multiple sectors at a time.

▪ **PIO Mode [Auto]**

Use the **PIO Mode** option to select the IDE PIO (Programmable I/O) mode program timing cycles between the IDE drive and the programmable IDE controller. As the PIO mode increases, the cycle time decreases.

- ➔ **Auto** **DEFAULT** BIOS auto detects the PIO mode. Use this value if the IDE disk drive support cannot be determined.
- ➔ **0** PIO mode 0 selected with a maximum transfer rate of 3.3 MB/s
- ➔ **1** PIO mode 1 selected with a maximum transfer rate of 5.2 MB/s
- ➔ **2** PIO mode 2 selected with a maximum transfer rate of 8.3 MB/s
- ➔ **3** PIO mode 3 selected with a maximum transfer rate of 11.1 MB/s
- ➔ **4** PIO mode 4 selected with a maximum transfer rate of 16.6 MB/s
(This setting generally works with all hard disk drives manufactured after 1999. For other disk drives, such as IDE CD-ROM drives, check the specifications of the drive.)

▪ **DMA Mode [Auto]**

Use the **DMA Mode** BIOS selection to adjust the DMA mode options.

- ➔ **Auto** **DEFAULT** BIOS auto detects the DMA mode. Use this value if the IDE disk drive support cannot be determined.
- ➔ **SWDMA0** Single Word DMA mode 0 selected with a maximum data transfer rate of 2.1 MB/s

WSB-9454 PCIMG 1.0 CPU Card

- ➔ **SWDMA1** Single Word DMA mode 1 selected with a maximum data transfer rate of 4.2 MB/s
- ➔ **SWDMA2** Single Word DMA mode 2 selected with a maximum data transfer rate of 8.3 MB/s
- ➔ **MWDMA0** Multi Word DMA mode 0 selected with a maximum data transfer rate of 4.2 MB/s
- ➔ **MWDMA1** Multi Word DMA mode 1 selected with a maximum data transfer rate of 13.3 MB/s
- ➔ **MWDMA2** Multi Word DMA mode 2 selected with a maximum data transfer rate of 16.6 MB/s
- ➔ **UDMA0** Ultra DMA mode 0 selected with a maximum data transfer rate of 16.6 MB/s
- ➔ **UDMA1** Ultra DMA mode 1 selected with a maximum data transfer rate of 25 MB/s
- ➔ **UDMA2** Ultra DMA mode 2 selected with a maximum data transfer rate of 33.3 MB/s
- ➔ **UDMA3** Ultra DMA mode 3 selected with a maximum data transfer rate of 44 MB/s (To use this mode, it is required that an 80-conductor ATA cable is used.)
- ➔ **UDMA4** Ultra DMA mode 4 selected with a maximum data transfer rate of 66.6 MB/s (To use this mode, it is required that an 80-conductor ATA cable is used.)
- ➔ **UDMA5** Ultra DMA mode 5 selected with a maximum data transfer rate of 99.9 MB/s (To use this mode, it is required that an 80-conductor ATA cable is used.)

- **S.M.A.R.T [Auto]**

Use the **S.M.A.R.T** option to auto-detect, disable or enable Self-Monitoring Analysis and Reporting Technology (SMART) on the drive on the specified channel. **S.M.A.R.T** predicts impending drive failures. The **S.M.A.R.T** BIOS option enables or disables this function.

- ➔ **Auto** **DEFAULT** BIOS auto detects HDD SMART support.
- ➔ **Disabled** Prevents BIOS from using the HDD SMART feature.
- ➔ **Enabled** Allows BIOS to use the HDD SMART feature

- **32Bit Data Transfer [Enabled]**

Use the **32Bit Data Transfer** BIOS option to enables or disable 32-bit data transfers.

- ➔ **Disabled** Prevents the BIOS from using 32-bit data transfers.
- ➔ **Enabled** **DEFAULT** Allows BIOS to use 32-bit data transfers on supported hard disk drives.

5.3.3 Floppy Configuration

Use the **Floppy Configuration menu** to configure the floppy disk drive connected to the system.

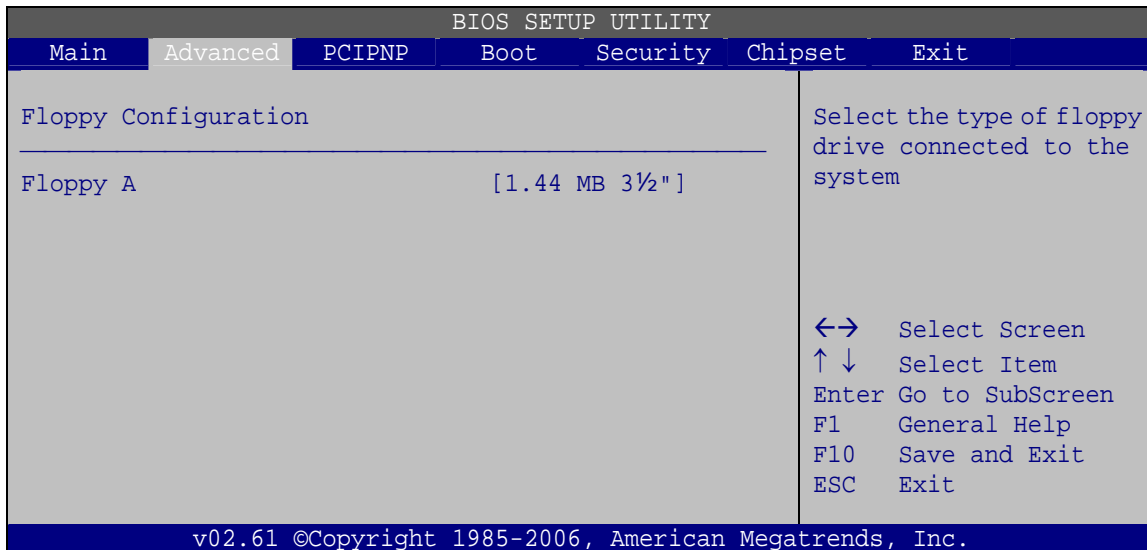

BIOS Menu 6: IDE Master and IDE Slave Configuration

- **Floppy A/B**

Use the **Floppy A/B** option to configure the floppy disk drive. Options are listed below:

- Disabled

WSB-9454 PCIMG 1.0 CPU Card

- 360 KB 51/4"
- 1.2 MB 51/4"
- 720 KB 31/2"
- 1.44 MB 31/2'
- 2.88 MB 31/2"

5.3.4 Super IO Configuration

Use the **Super IO Configuration** menu (BIOS Menu 7) to set or change the configurations for the FDD controllers, parallel ports and serial ports.

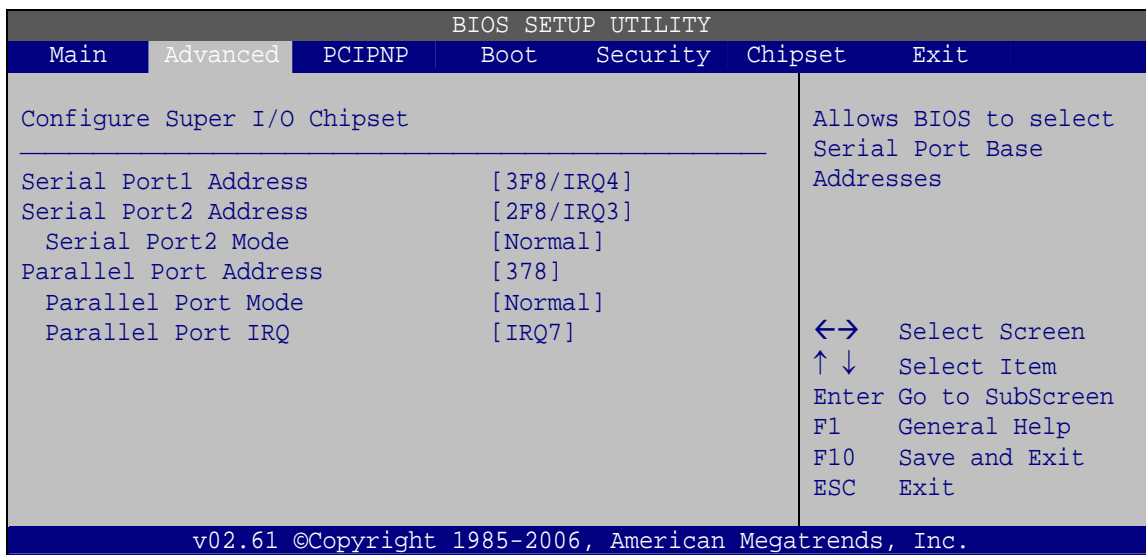

BIOS Menu 7: Super IO Configuration

- **Serial Port1 Address [3F8/IRQ4]**

Use the **Serial Port1 Address** option to select the Serial Port 1 base address.

- ➔ **Disabled** No base address is assigned to Serial Port 1
- ➔ **3F8/IRQ4** **DEFAULT** I/O port address is 3F8 and the interrupt address is IRQ4
- ➔ **3E8/IRQ4** I/O port address is 3E8 and the interrupt address is IRQ4
- ➔ **2E8/IRQ3** I/O port address is 2E8 and the interrupt address is IRQ3

- **Serial Port2 Address [2F8/IRQ3]**

Use the **Serial Port2 Address** option to select the Serial Port 2 base address.

- ➔ **Disabled** No base address is assigned to Serial Port 2
- ➔ **2F8/IRQ3** **DEFAULT** I/O port address is 3F8 and the interrupt address is IRQ3
- ➔ **3E8/IRQ4** I/O port address is 3E8 and the interrupt address is IRQ4
- ➔ **2E8/IRQ3** I/O port address is 2E8 and the interrupt address is IRQ3

- **Serial Port2 Mode [Normal]**

Use the **Serial Port2 Mode** option to select the Serial Port2 operational mode.

- **Normal** **DEFAULT**
- IrDA
- ASK IR

- **Parallel Port Address [378]**

Use the **Parallel Port Address** option to select the parallel port base address.

- ➔ **Disabled** No base address is assigned to the Parallel Port
- ➔ **378** **DEFAULT** Parallel Port I/O port address is 378
- ➔ **278** Parallel Port I/O port address is 278
- ➔ **3BC** Parallel Port I/O port address is 3BC

- **Parallel Port Mode [Normal]**

Use the **Parallel Port Mode** option to select the mode the parallel port operates in.

- ➔ **Normal** **DEFAULT** The normal parallel port mode is the standard mode for parallel port operation.
- ➔ **Bi-directional** Parallel port outputs are 8-bits long. Inputs are accomplished by reading 4 of the 8 bits on the status register.

WSB-9454 PCIMG 1.0 CPU Card

→ EPP

The parallel port operates in the enhanced parallel port mode (EPP). The EPP mode supports bi-directional communication between the system and the parallel port device and the transmission rates between the two are much faster than the Normal mode.

→ ECP+EPP

The parallel port operates in the extended capabilities port (ECP) mode. The ECP mode supports bi-directional communication between the system and the parallel port device and the transmission rates between the two are much faster than the Normal mode

The parallel port is also be compatible with EPP devices described above

▪ Parallel Port IRQ [IRQ7]

Use the **Parallel Port IRQ** selection to set the parallel port interrupt address.

→ **IRQ5** IRQ5 is assigned as the parallel port interrupt address

→ **IRQ7** **DEFAULT** IRQ7 is assigned as the parallel port interrupt address

5.3.5 Hardware Health Configuration

The **Hardware Health Configuration** menu (BIOS Menu 8) shows the operating temperature, fan speeds and system voltages.

BIOS SETUP UTILITY	
Main	Advanced
PCIPNP Boot Security Chipset Exit	
Hardware Health Event Monitoring	

CPUFAN Mode Setting	[Temperature Mode]
CPUFAN PWM Control	[100]

System Temperature	:25°C/77°F
CPU Temperature	:55°C/131°F
CPU Fan Speed	:4386 RPM
Vore	:1.160 V
+12V	:11.563 V
VCC3	:3.424 V
1.8V	:1.928 V
5VSB	:5.017 V
5VCC	:0.179 V
3VSB	:3.376 V
VBAT	:3.360 V
	←→ Select Screen
	↑ ↓ Select Item
	Enter Go to SubScreen
	F1 General Help
	F10 Save and Exit
	ESC Exit
v02.61 ©Copyright 1985-2006, American Megatrends, Inc.	

BIOS Menu 8: Hardware Health Configuration

- **Mode Setting [Full On Mode]**

Use the **Mode Setting** option to configure the second fan.

- ➔ **Temperature Mode** **DEFAULT** Fan adjusts according to the temperature
- ➔ **Manual Mode** Fan speed remains at the speed set by:
CPUFAN PWM control

- **CPUFAN PWM Control [100]**

This value specifies the speed of the fan.

- Minimum: 0
- Maximum: 100

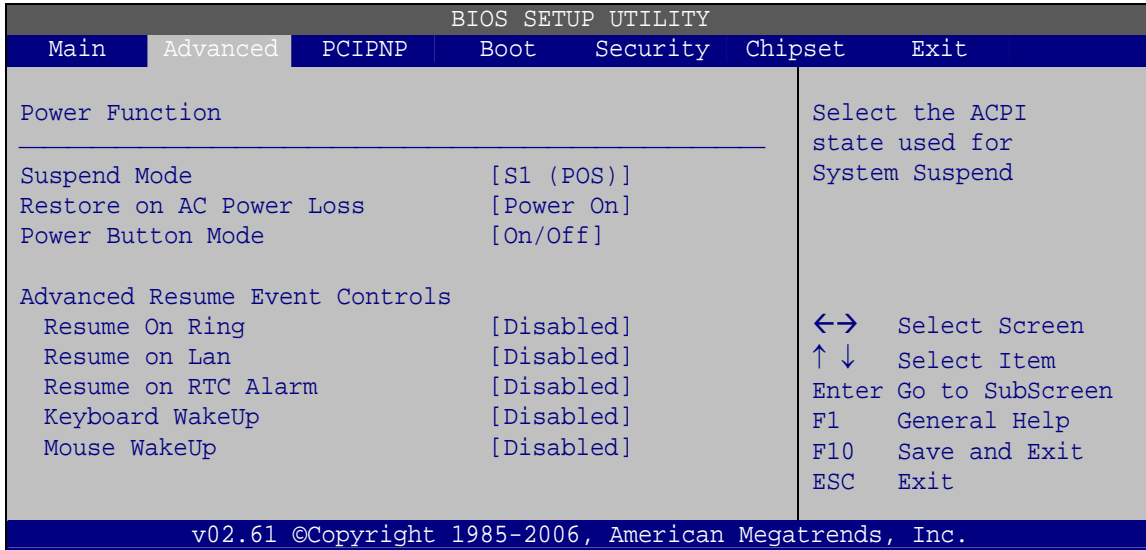

BIOS Menu 10: APM Configuration

- **Suspend Mode [S1(POS)]**

Use the **Suspend Mode** option to specify the sleep state the system enters when it is not being used.

- ➔ **S1 (POS) DEFAULT** In S1 sleep state, the CPU is stopped, RAM power is maintained and everything else is off or in a low-power state.
- ➔ **S3 (STR)** In S3 sleep state, the CPU has no power, RAM power is maintained but refreshes slowly, and the power supply reduces power to the system.

- **Restore on AC Power Loss [Last State]**

Use the **Restore on AC Power Loss** BIOS option to specify what state the system returns to if there is a sudden loss of power to the system.

- ➔ **Power Off** The system remains turned off
- ➔ **Power On** The system turns on
- ➔ **Last State DEFAULT** The system returns to its previous state. If it was on, it turns itself on. If it was off, it remains off.

WSB-9454 PCIMG 1.0 CPU Card

- **Power Button Mode [On/Off]**

Use the **Power Button Mode** BIOS to specify how the power button functions.

- ➔ **On/Off** **DEFAULT** When the power button is pressed the system is either turned on or off
- ➔ **Suspend** When the power button is pressed the system goes into suspend mode

- **Resume on Keyboard/Mouse [Disabled]**

Use the **Resume on Keyboard/Mouse** BIOS option to enable activity on either the keyboard or mouse to rouse the system from a suspended or standby state. That is, the system is roused when the mouse is moved or a button on the keyboard is pressed.

- ➔ **Disabled** **DEFAULT** Wake event not generated by activity on the keyboard or mouse
- ➔ **Enabled** Wake event generated by activity on the keyboard or mouse

- **Resume on Ring [Disabled]**

Use the **Resume on Ring** BIOS option to enable activity on the RI (ring in) modem line to rouse the system from a suspended or standby state. That is, the system will be roused by an incoming call on a modem.

- ➔ **Disabled** **DEFAULT** Wake event not generated by an incoming call
- ➔ **Enabled** Wake event generated by an incoming call

- **Resume on LAN [Disabled]**

The **Resume on LAN** BIOS option specifies if the system is roused from a suspended or standby state when there is activity on the LAN.

- ➔ **Disabled** **DEFAULT** Wake event not generated by LAN activity
- ➔ **Enabled** Wake event generated by LAN activity

- **Resume On RTC Alarm [Disabled]**

Use the **Resume On RTC Alarm** option to specify the time the system should be roused from a suspended state.

➔ **Disabled** **DEFAULT** The real time clock (RTC) cannot generate a wake event

➔ **Enabled** If selected, the following appears with values that can be selected:

RTC Alarm Date (Days)

System Time

After setting the alarm, the computer turns itself on from a suspend state when the alarm goes off.

- **Keyboard WakeUp [Disabled]**

When enabled, using the keyboard will wake the system from a sleep state.

- Disabled **DEFAULT**
- Enabled

- **Mouse WakeUp [Disabled]**

When enabled, using the mouse will wake the system from a sleep state.

- Disabled **DEFAULT**
- Enabled

5.3.7 Remote Access Configuration

Use the **Remote Access Configuration** menu (BIOS Menu 11) to configure remote access parameters. The **Remote Access Configuration** is an AMIBIOS feature and allows a remote host running a terminal program to display and configure the BIOS settings.

WSB-9454 PCIMG 1.0 CPU Card

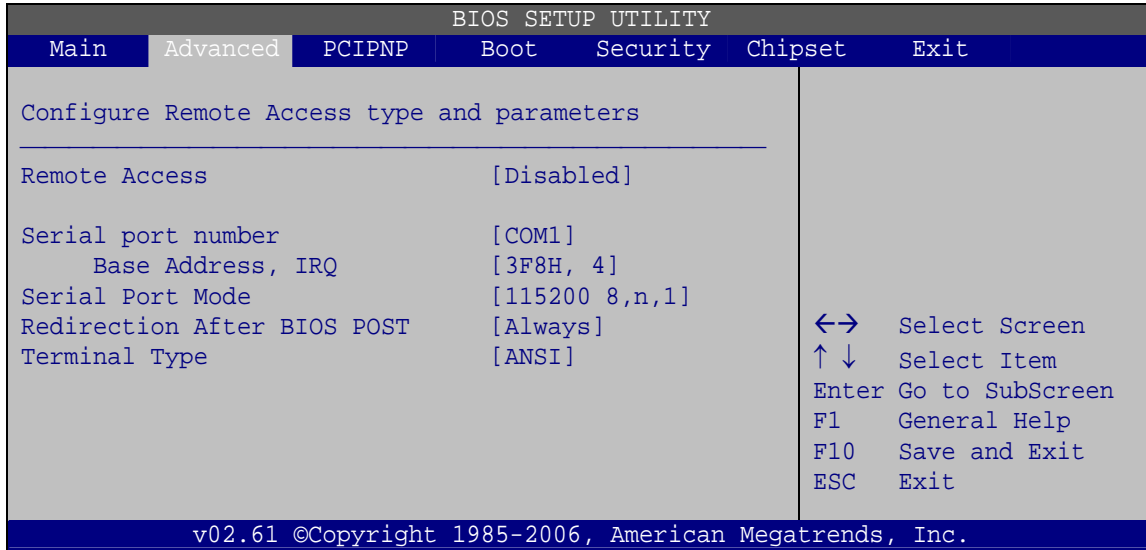

BIOS Menu 11: Remote Access Configuration

- **Remote Access [Disabled]**

Use the **Remote Access** option to enable or disable access to the remote functionalities of the system.

➔ **Disabled** **DEFAULT** Remote access is disabled.

➔ **Enabled** Remote access configuration options shown below appear:

Serial Port Number

Serial Port Mode

Flow Control

Redirection after BIOS POST

Terminal Type

VT-UTF8 Combo Key Support

These configuration options are discussed below.

- **Serial Port Number [COM1]**

Use the **Serial Port Number** option to select the serial port used for remote access.

- ➔ **COM1** **DEFAULT** System is remotely accessed through COM1
- ➔ **COM2** System is remotely accessed through COM2

NOTE: Make sure the selected COM port is enabled through the Super I/O configuration menu.

- **Base Address, IRQ [2F8h,3]**

The **Base Address, IRQ** option cannot be configured and only shows the interrupt address of the serial port listed above.

- **Serial Port Mode [115200 8,n,1]**

Use the **Serial Port Mode** option to select baud rate through which the console redirection is made. The following configuration options are available

- 115200 8,n,1 **DEFAULT**
- 57600 8,n,1
- 38400 8,n,1
- 19200 8,n,1
- 09600 8,n,1



NOTE:

Identical baud rate setting must be set on the host (a management computer running a terminal software) and the slave

- **Flow Control [None]**

Use the **Flow Control** option to report the flow control method for the console redirection application.

- ➔ **None** **DEFAULT** No control flow,
- ➔ **Hardware** Hardware is set as the console redirection
- ➔ **Software** Software is set as the console redirection

WSB-9454 PCIMG 1.0 CPU Card

- **Redirection After BIOS POST [Always]**

Use the **Redirection After BIOS POST** option to specify when console redirection should occur.

- ➔ **Disabled** The console is not redirected after POST
- ➔ **Boot Loader** Redirection is active during POST and during Boot Loader
- ➔ **Always** **DEFAULT** Redirection is always active (Some Oses may not work if set to Always)

- **Terminal Type [ANSI]**

Use the **Terminal Type** BIOS option to specify the remote terminal type.

- ➔ **ANSI** **DEFAULT** The target terminal type is ANSI
- ➔ **VT100** The target terminal type is VT100
- ➔ **VT-UTF8** The target terminal type is VT-UTF8

- **VT-UTF8 Combo Key Support [Disabled]**

Use the **VT-UFT8 Combo Key Support** option to enable additional keys that are not provided by VT100 for the PC 101 keyboard.

The VT100 Terminal Definition is the standard convention used to configure and conduct emergency management tasks with UNIX-based servers. VT100 does not support all keys on the standard PC 101-key layout, however. The VT-UTF8 convention makes available additional keys that are not provided by VT100 for the PC 101 keyboard.

- ➔ **Disabled** **DEFAULT** Disables the VT-UTF8 terminal keys
- ➔ **Enabled** Enables the VT-UTF8 combination key. Support for ANSI/VT100 terminals

- **Sredir Memory Display Delay [Disabled]**

Use the **Sredir Memory Display Delay** option to select the delay before memory information is displayed. Configuration options are listed below

- No Delay DEFAULT
- Delay 1 sec
- Delay 2 sec
- Delay 4 sec

5.3.8 USB Configuration

Use the **USB Configuration** menu (BIOS Menu 12) to read USB configuration information and configure the USB settings.

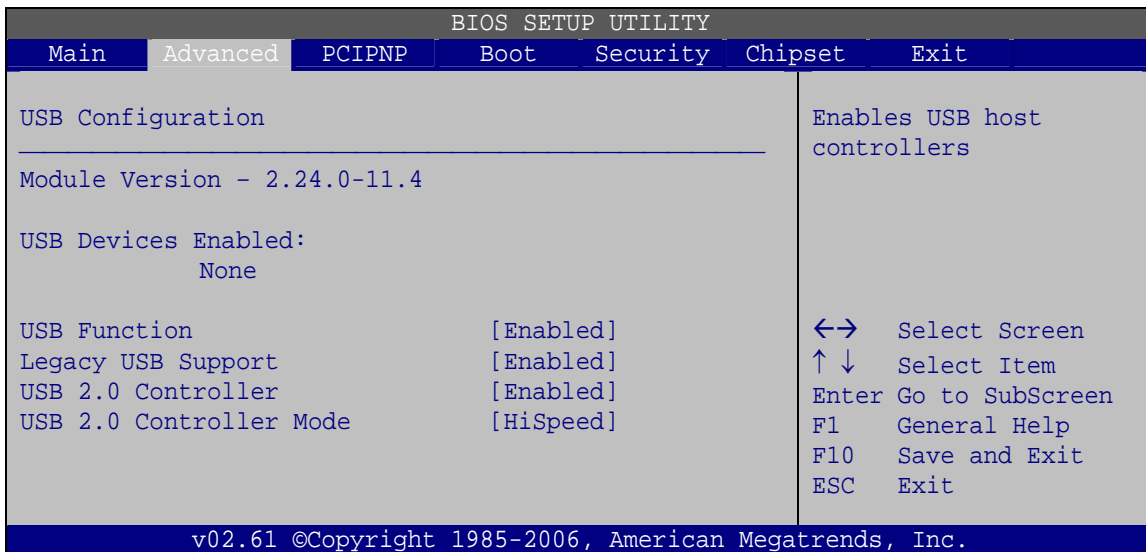

BIOS Menu 12: USB Configuration

- **USB Function [Enabled]**

Use the **USB Function** BIOS option to enable or disable USB function support.

- ➔ **Disabled** USB function support disabled
- ➔ **Enabled** DEFAULT USB function support enabled

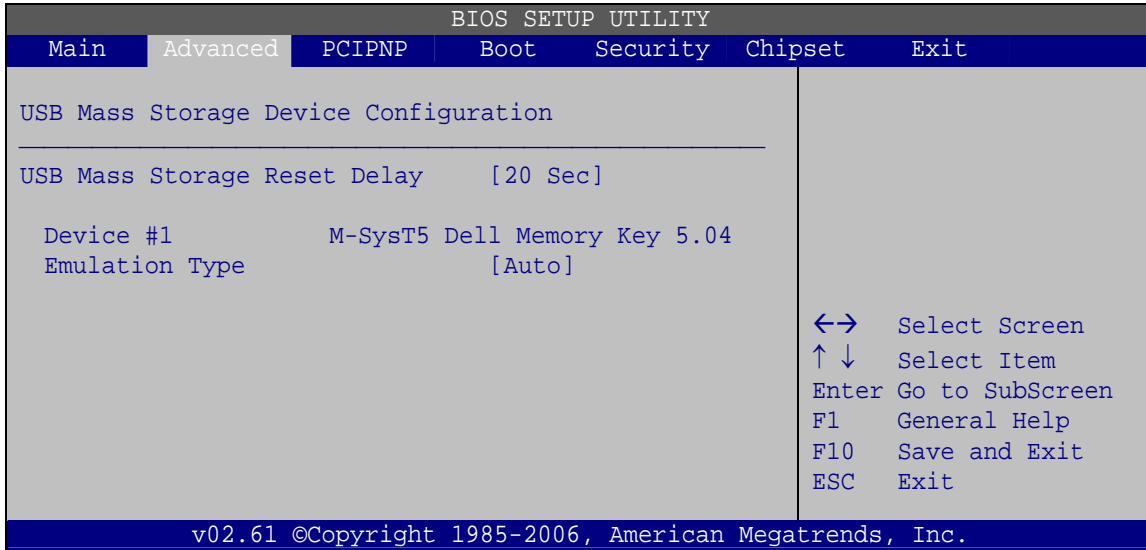

BIOS Menu 13: USB Mass Storage Device Configuration

- **USB Mass Storage Reset Delay [20 Sec]**

Use the **USB Mass Storage Reset Delay** option to set the number of seconds POST waits for the USB mass storage device after the start unit command.

- ➔ **10 Sec** POST waits 10 seconds for the USB mass storage device after the start unit command.
- ➔ **20 Sec** **DEFAULT** POST waits 20 seconds for the USB mass storage device after the start unit command.
- ➔ **30 Sec** POST waits 30 seconds for the USB mass storage device after the start unit command.
- ➔ **40 Sec** POST waits 40 seconds for the USB mass storage device after the start unit command.

- **Device ##**

The **Device##** field lists the USB devices that are connected to the system.

- **Emulation Type [Auto]**

Use the **Emulation Type** BIOS option to specify the type of emulation BIOS has to provide for the USB device.

WSB-9454 PCIMG 1.0 CPU Card

- | | | | |
|---|-------------------|----------------|--|
| → | Auto | DEFAULT | BIOS auto-detects the current USB. |
| → | Floppy | | The USB device will be emulated as a floppy drive. The device can be either A: or B: responding to INT13h calls that return DL = 0 or DL = 1 respectively. |
| → | Forced FDD | | Allows a hard disk image to be connected as a floppy image. This option works only for drives formatted with FAT12, FAT16 or FAT32. |
| → | Hard Disk | | Allows the USB device to be emulated as hard disk responding to INT13h calls that return DL values of 80h or above. |
| → | CDROM | | Assumes the CD-ROM is formatted as bootable media. All the devices that support block sizes greater than 512 bytes can only be booted using this option. |

5.4 PCI/PnP

Use the **PCI/PnP** menu (BIOS Menu 14) to configure advanced PCI and PnP settings.



WARNING!

Setting wrong values for the BIOS selections in the PCIPnP BIOS menu may cause the system to malfunction.

BIOS SETUP UTILITY		
Main	Advanced	PCIPNP
Advanced PCI/PnP Settings		Available: Specified IRQ is available to be used by PCI/PnP devices
WARNING: Setting wrong values in below sections may cause system to malfunction		
IRQ3	[Reserved]	Reserved: Specified IRQ is reserved for use by legacy ISA devices
IRQ4	[Reserved]	
IRQ5	[Available]	
IRQ7	[Available]	
IRQ9	[Available]	
IRQ10	[Available]	
IRQ11	[Available]	
IRQ14	[Available]	
IRQ15	[Available]	
DMA Channel 0	[Available]	←→ Select Screen
DMA Channel 1	[Available]	↑ ↓ Select Item
DMA Channel 3	[Available]	Enter Go to SubScreen
DMA Channel 5	[Available]	F1 General Help
DMA Channel 6	[Available]	F10 Save and Exit
DMA Channel 7	[Available]	ESC Exit
v02.61 ©Copyright 1985-2006, American Megatrends, Inc.		

BIOS Menu 14: PCI/PnP Configuration

- **IRQ# [Available]**

Use the **IRQ#** address to specify what IRQs can be assigned to a particular peripheral device.

- ➔ **Available** **DEFAULT** The specified IRQ is available to be used by PCI/PnP devices
- ➔ **Reserved** The specified IRQ is reserved for use by Legacy ISA devices

Available IRQ addresses are:

- IRQ3
- IRQ4
- IRQ5
- IRQ7
- IRQ9
- IRQ10

WSB-9454 PCIMG 1.0 CPU Card

- IRQ 11
- IRQ 14
- IRQ 15

- **DMA Channel# [Available]**

Use the **DMA Channel#** option to assign a specific DMA channel to a particular PCI/PnP device.

- | | | | |
|---|------------------|----------------|--|
| ➔ | Available | DEFAULT | The specified DMA is available to be used by PCI/PnP devices |
| ➔ | Reserved | | The specified DMA is reserved for use by Legacy ISA devices |

Available DMA Channels are:

- DM Channel 0
- DM Channel 1
- DM Channel 3
- DM Channel 5
- DM Channel 6
- DM Channel 7

5.5 Boot

Use the **Boot** menu (BIOS Menu 15) to configure system boot options.

BIOS SETUP UTILITY						
Main	Advanced	PCIPNP	Boot	Security	Chipset	Exit
Boot Settings <hr/> > Boot Settings Configuration > Boot Device Priority > Hard Disk Drives > CD/DVD Drives > Removable Drives				Configure settings during system boot. ←→ Select Screen ↑↓ Select Item Enter Go to SubScreen F1 General Help F10 Save and Exit ESC Exit		
v02.61 ©Copyright 1985-2006, American Megatrends, Inc.						

BIOS Menu 15: Boot

5.5.1 Boot Settings Configuration

Use the **Boot Settings Configuration** menu (BIOS Menu 16) to configure advanced system boot options.

BIOS SETUP UTILITY						
Main	Advanced	PCIPNP	Boot	Security	Chipset	Exit
Boot Settings Configuration <hr/> Quick Boot [Enabled] Quiet Boot [Enabled] AddOn ROM Display Mode [Force BIOS] Bootup Num-Lock [On] Boot from LAN Support [Disabled]				Allows BIOS to skip certain tests while booting. This will decrease the time needed to boot the system. ←→ Select Screen ↑↓ Select Item Enter Go to SubScreen F1 General Help F10 Save and Exit ESC Exit		
v02.61 ©Copyright 1985-2006, American Megatrends, Inc.						

BIOS Menu 16: Boot Settings Configuration

WSB-9454 PCIMG 1.0 CPU Card

- **Quick Boot [Enabled]**

Use the **Quick Boot** BIOS option to make the computer speed up the boot process.

- ➔ **Disabled** No POST procedures are skipped
- ➔ **Enabled** **DEFAULT** Some POST procedures are skipped to decrease the system boot time

- **Quiet Boot [Disabled]**

Use the **Quiet Boot** BIOS option to select the screen display when the system boots.

- ➔ **Disabled** **DEFAULT** Normal POST messages displayed
- ➔ **Enabled** OEM Logo displayed instead of POST messages

- **AddOn ROM Display Mode [Force BIOS]**

Use the **AddOn ROM Display Mode** option to allow add-on ROM (read-only memory) messages to be displayed.

- ➔ **Force BIOS** **DEFAULT** The system forces third party BIOS to display during system boot.
- ➔ **Keep Current** The system displays normal information during system boot.

- **Bootup Num-Lock [On]**

Determines the state of the Num Lock button on boot. The NumLock key treats the number keypad as numbers when turned on, and treats them as directional keys when off.

- **On** **DEFAULT**
- **Off**

- **Onboard Lan Rom [Disabled]**

When enabled, the system can be woken when a "magic" packet is sent over the network.

- **Disabled** **DEFAULT**
- **Enabled**

5.5.2 Boot Device Priority

Use the **Boot Device Priority** menu (BIOS Menu 17) to specify the boot sequence from the available devices. The drive sequence also depends on the boot sequence in the individual device section.

BIOS SETUP UTILITY						
Main	Advanced	PCIPNP	Boot	Security	Chipset	Exit
Boot Device Priority				Specifies the boot sequence from the available devices.		
>	1st Boot Device		[1st Boot Device]			
>	2nd Boot Device		[2nd Boot Device]			
>	3rd Boot Device		[3rd Boot Device]			
				←→ Select Screen ↑↓ Select Item Enter Go to SubScreen F1 General Help F10 Save and Exit ESC Exit		
v02.61 ©Copyright 1985-2006, American Megatrends, Inc.						

BIOS Menu 17: Boot Device Priority Settings

WSB-9454 PCIMG 1.0 CPU Card

5.5.3 Hard Disk Drives

Use the **Hard Disk Drives** menu to specify the boot sequence of the available HDDs. Only installed hard drives are shown.

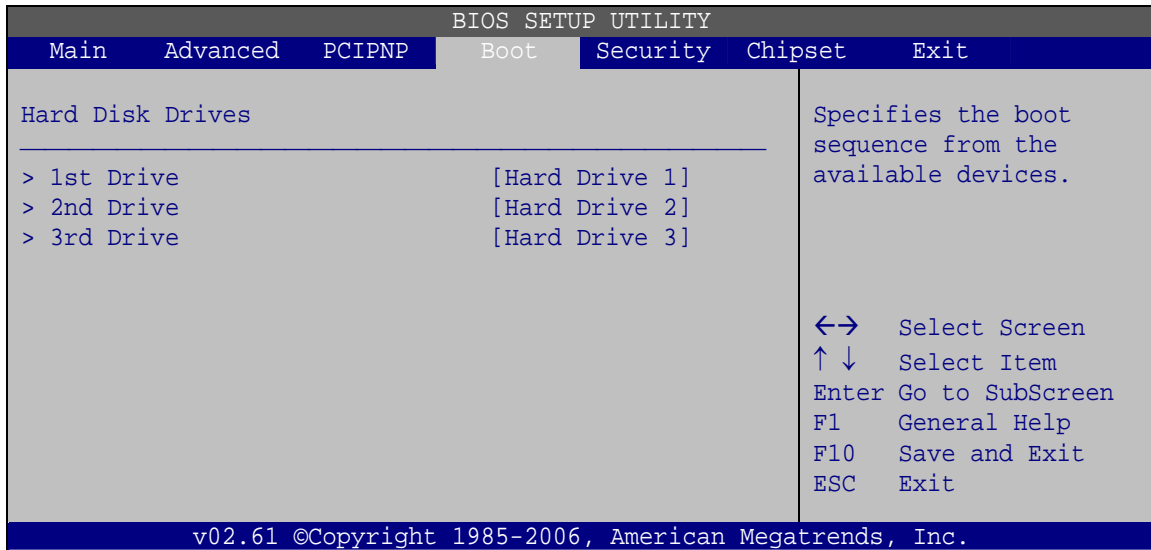

BIOS Menu 18: Hard Disk Drives

5.5.4 Removable Drives

Use the **Removable Drives** menu (BIOS Menu 19) to specify the boot sequence of the removable drives. Only connected drives are shown.

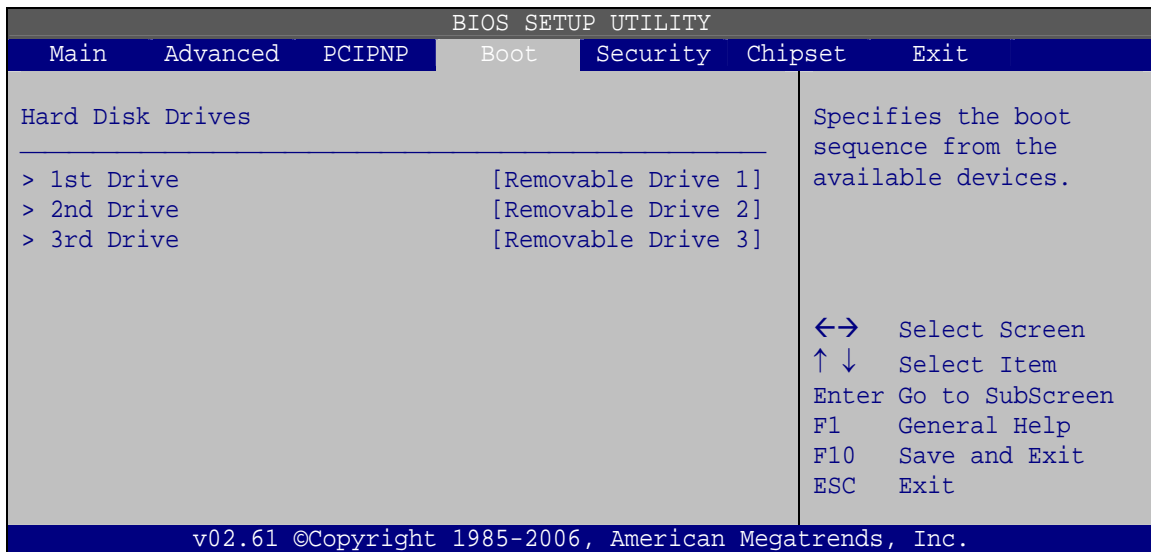

BIOS Menu 19: Removable Drives

5.5.5 CD/DVD Drives

Use the **CD/DVD Drives** menu to specify the boot sequence of the available CD/DVD drives. When the menu is opened, the CD drives and DVD drives connected to the system are listed as shown below:

- 1st Drive [CD/DVD: PM-(part ID)]
- 2nd Drive [HDD: PS-(part ID)]
- 3rd Drive [HDD: SM-(part ID)]
- 4th Drive [HDD: SM-(part ID)]



NOTE:

Only the drives connected to the system are shown. For example, if only two CDs or DVDs are connected only “**1st Drive**” and “**2nd Drive**” are listed.

The boot sequence from the available devices is selected. If the “**1st Drive**” option is selected a list of available CD/DVD drives is shown. Select the first CD/DVD drive the system boots from. If the “**1st Drive**” is not used for booting this option may be disabled.

BIOS SETUP UTILITY						
Main	Advanced	PCIPNP	Boot	Security	Chipset	Exit
Hard Disk Drives				Specifies the boot sequence from the available devices.		
>	1st Drive		[CD/DVD 1]			
>	2nd Drive		[CD/DVD 2]			
>	3rd Drive		[CD/DVD 3]			
				←→ Select Screen ↑ ↓ Select Item Enter Go to SubScreen F1 General Help F10 Save and Exit ESC Exit		
v02.61 ©Copyright 1985-2006, American Megatrends, Inc.						

BIOS Menu 20: CD/DVD Drives

5.6 Security

Use the **Security** menu (BIOS Menu 21) to set system and user passwords.

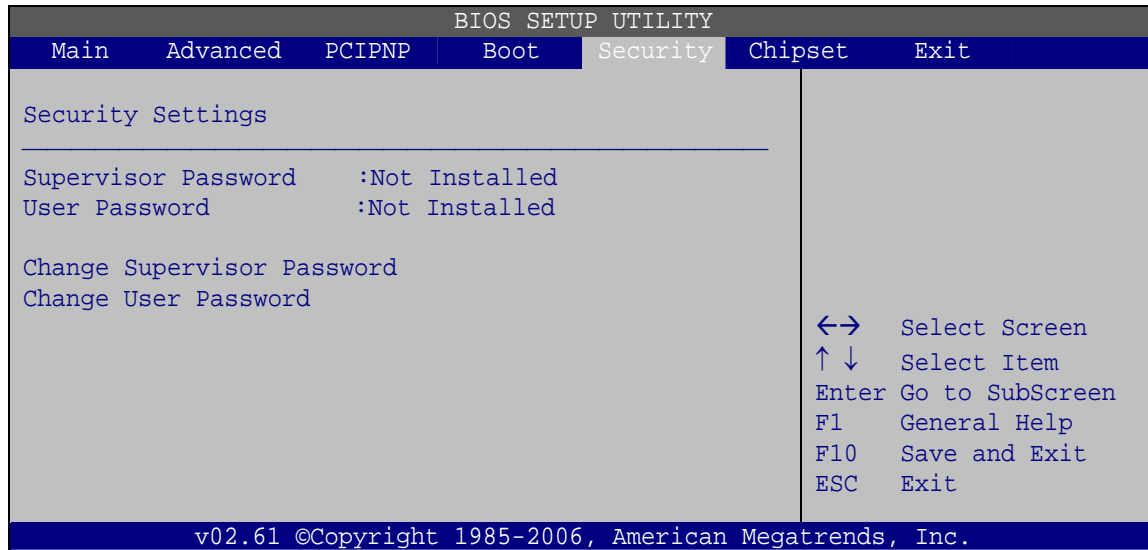

BIOS Menu 21: Security

- **Change Supervisor Password**

Use the **Change Supervisor Password** to set or change a supervisor password. The default for this option is **Not Installed**. If a supervisor password must be installed, select this field and enter the password. After the password has been added, **Install** appears next to **Change Supervisor Password**.

- **Change User Password**

Use the **Change User Password** to set or change a user password. The default for this option is **Not Installed**. If a user password must be installed, select this field and enter the password. After the password has been added, **Install** appears next to **Change User Password**.

- **Clear User Password**

Use the **Clear User Password** to clear a user's password. The default for this option is **Not Installed**. If a user password must be cleared, use this option.

- **Boot Sector Virus Protection [Disabled]**

Use the **Boot Sector Virus Protection** to enable or disable boot sector protection.

- ➔ **Disabled** **DEFAULT** Disables the boot sector virus protection
- ➔ **Enabled** Enables the boot sector virus protection

5.7 Chipset

Use the **Chipset** menu (BIOS Menu 22) to access the Northbridge and Southbridge configuration menus



WARNING!

Setting the wrong values for the Chipset BIOS selections in the Chipset BIOS menu may cause the system to malfunction.

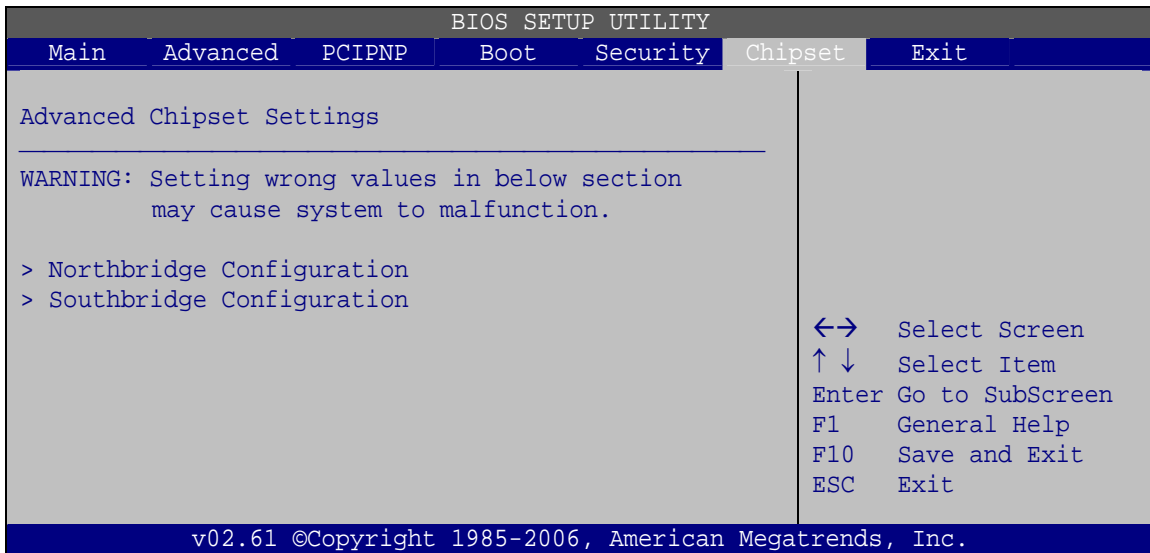

BIOS Menu 22: Chipset

WSB-9454 PCIMG 1.0 CPU Card

5.7.1 Northbridge Configuration

Use the **Northbridge Chipset Configuration** menu (BIOS Menu 23) to configure the Northbridge chipset.

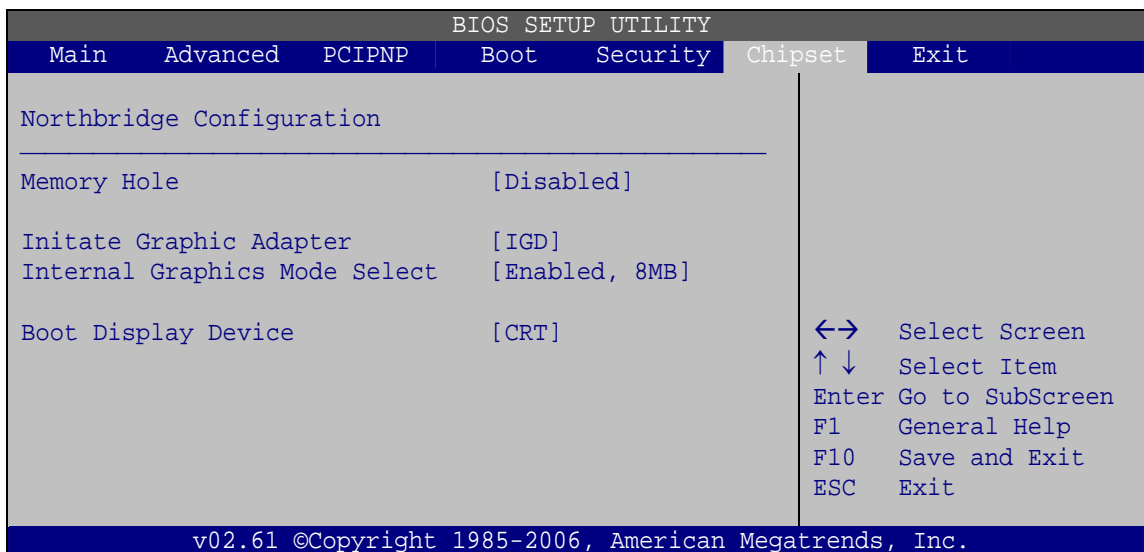

BIOS Menu 23: Northbridge Chipset Configuration

- **Memory Hole [Disabled]**

Use the **Memory Hole** option to reserve memory space between 15 MB and 16 MB for ISA expansion cards that require a specified area of memory to work properly. If an older ISA expansion card is used, please refer to the documentation that came with the card to see if it is necessary to reserve the space.

- ➔ **Disabled** **DEFAULT** Memory is not reserved for ISA expansion cards
- ➔ **15 MB–16 MB** Between 15 MB and 16 MB of memory is reserved for ISA expansion cards

- **Initiate Graphic Adapter**

Use the **Initiate Graphic Adapter** option to select the graphics controller used as the primary boot device. Select either an integrated graphics controller (IGD) or a combination of PCI graphics controller, a PCI express (PEG) controller or an IGD. Configuration options are listed below:

WSB-9454 PCIMG 1.0 CPU Card

5.7.2 Southbridge Configuration

The **Southbridge Configuration** menu (BIOS Menu 24) allows the Southbridge chipset to be configured.

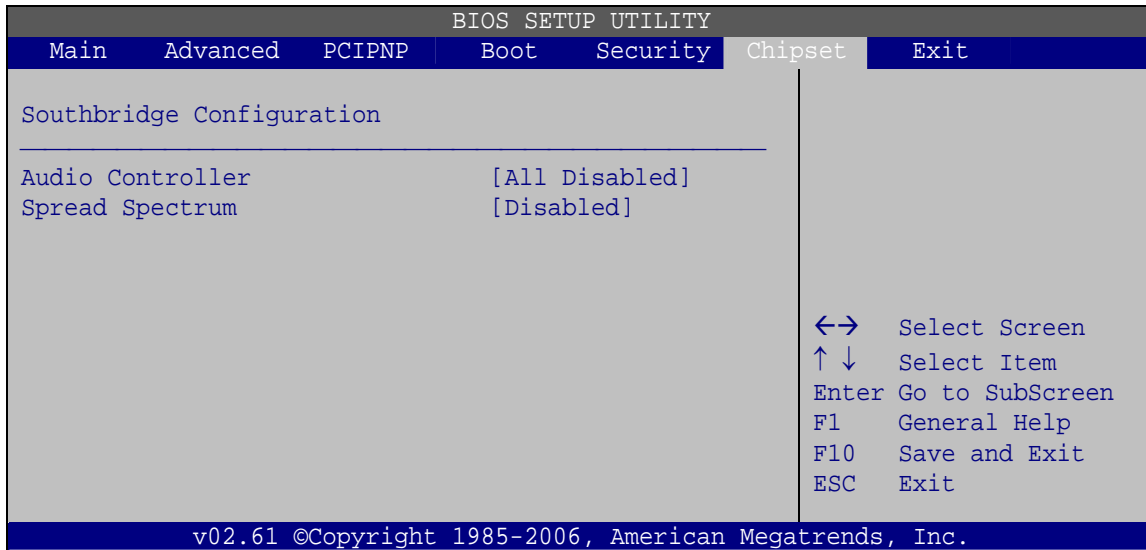

BIOS Menu 24:Southbridge Chipset Configuration

- **Audio Controller [All Disabled]**

Sets the audio communication method of the audio controller.

- ➔ **Azalia** High Definition audio is enabled
- ➔ **AC'97** Only AC'97 audio is enabled
- ➔ **All Disabled** **DEFAULT** The audio controller is disabled

- **Spread Spectrum [Disabled]**

Use the **Spread Spectrum** option to reduce the EMI. Excess EMI is generated when the system clock generator pulses have extreme values. Spreading the pulse spectrum modulates changes in the extreme values from spikes to flat curves, thus reducing the EMI. This benefit may in some cases be outweighed by problems with timing-critical devices, such as a clock-sensitive SCSI device.

- ➔ **Disabled** **DEFAULT** EMI not reduced
- ➔ **Enabled** EMI reduced

5.8 Exit

Use the **Exit** menu (BIOS Menu 25) to load default BIOS values, optimal failsafe values and to save configuration changes.

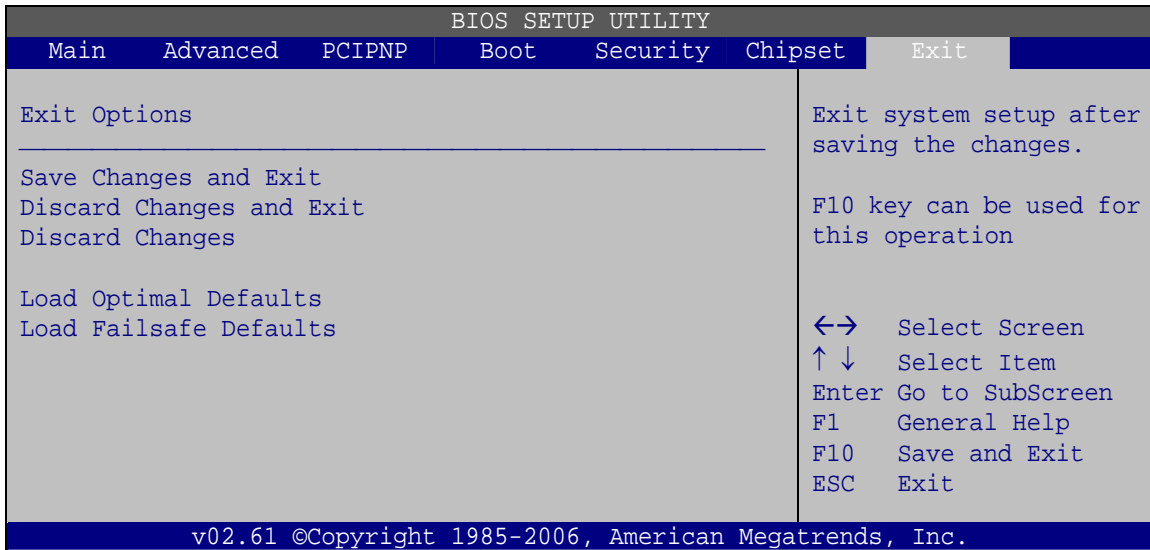

BIOS Menu 25:Exit

- **Save Changes and Exit**

Use the **Save Changes and Exit** option to save the changes made to the BIOS options and to exit the BIOS configuration setup program.

- **Discard Changes and Exit**

Use the **Discard Changes and Exit** option to exit the BIOS configuration setup program without saving the changes made to the system.

- **Discard Changes**

Use the **Discard Changes** option to discard the changes and remain in the BIOS configuration setup program.

- **Load Optimal Defaults**

Use the **Load Optimal Defaults** option to load the optimal default values for each of the parameters on the Setup menus. **F9 key can be used for this operation.**

WSB-9454 PCIMG 1.0 CPU Card

- **Load Failsafe Defaults**

Use the **Load Failsafe Defaults** option to load failsafe default values for each of the parameters on the Setup menus. **F8 key can be used for this operation.**

Chapter

6

Software Drivers

WSB-9454 PCIMG 1.0 CPU Card

6.1 Available Software Drivers



NOTE:

The content of the CD may vary throughout the life cycle of the product and is subject to change without prior notice. Visit the IEI website or contact technical support for the latest updates.

The WSB-9454 motherboard has the following software drivers:

- Intel® Chipset Driver Installation
- VGA Utilities Driver
- LAN Driver (for GbE LAN) Installation
- Audio Driver (ALC655) Installation
- SATA Driver Installation

All drivers can be found on the CD that came with the motherboard. To install the drivers please follow the instructions in the sections below.

6.2 Chipset Driver Installation

To install the chipset driver, please follow the steps below:

Step 1: Insert the CD into the system that contains the drivers and utilities for the WSB-9454 board. Open the **1-INF** directory and locate the icon for the **infinst_autol.exe** installation file. Once located, use the mouse to double click the icon.

Step 2: The “InstallShield Wizard Preparation Screen” in Figure 6-1 appears.

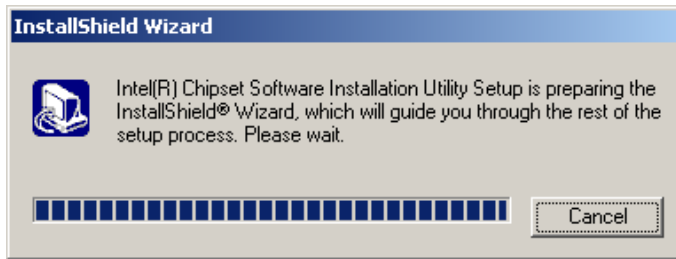

Figure 6-1: InstallShield Wizard Preparation Screen

Step 3: The “Welcome” window in Figure 6-2 appears next.

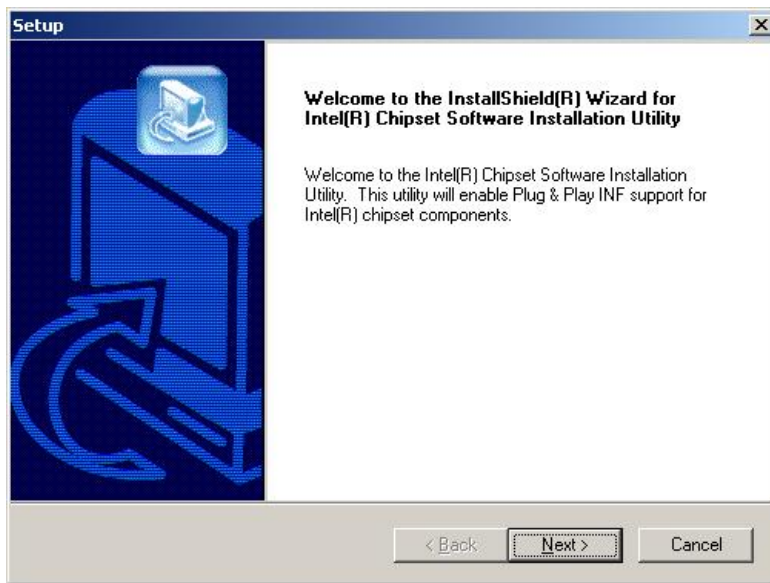

Figure 6-2: Welcome Screen

Step 4: Click “NEXT” and the license agreement shown in Figure 6-3 appears.

WSB-9454 PCIMG 1.0 CPU Card

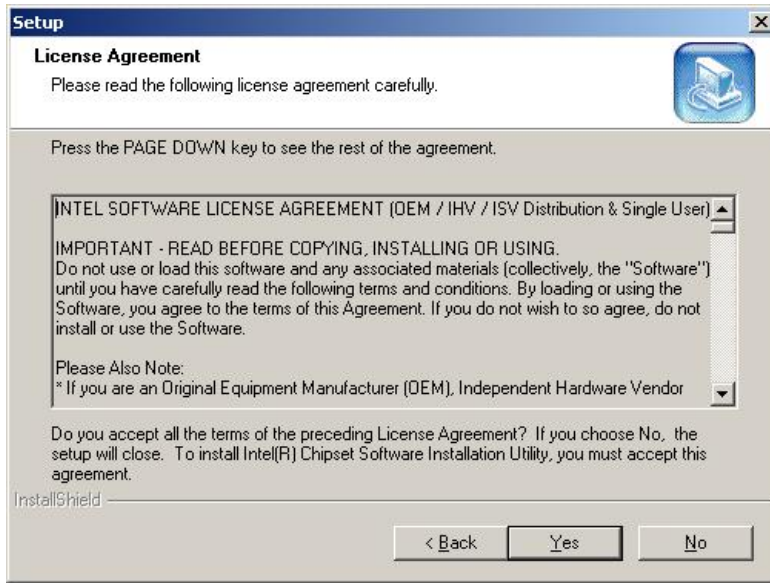

Figure 6-3: License Agreement

Step 5: Agree to the license terms by clicking “YES”. The “Readme” in Figure 6-4 appears.

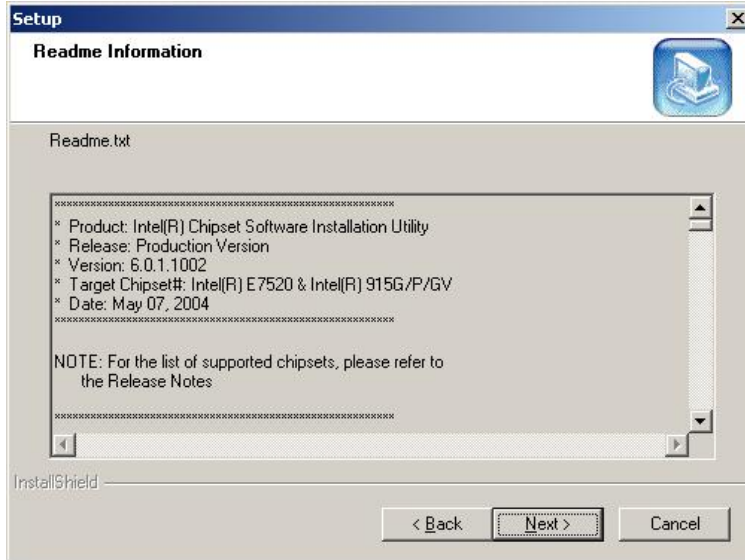

Figure 6-4: Readme Information

Step 6: Click “YES”. The driver is installed on the computer. After the installation is complete, the installation complete screen shown in Figure 6-5 appears. Select

the preferred option and click **“FINISH”** to complete the installation process.



Figure 6-5: Restart the Computer

6.3 VGA Driver

To install the VGA driver, please follow the steps below:

- Step 1:** Insert the Utility CD that came with the motherboard into the system CD drive.
- Step 2:** Open the **X:\2-VGAWIN2K_XP** directory (where **X:** is the system CD drive) and double-click the **win2k_xp1420.exe** installation file.
- Step 3:** The Starting Install Shield Wizard appears (Figure 6-6).

WSB-9454 PCIMG 1.0 CPU Card

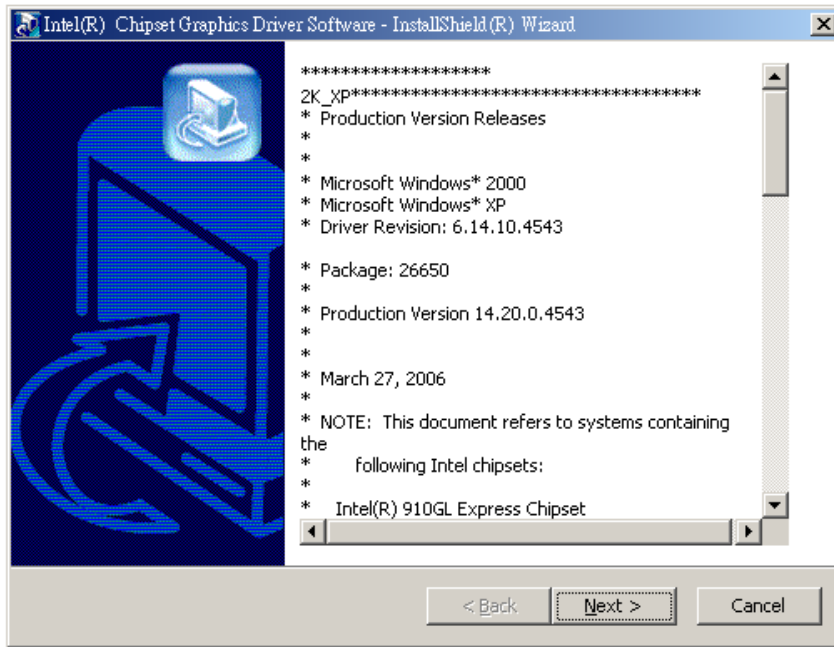

Figure 6-6: Starting Install Shield Wizard Screen

Step 4: The Preparing Setup window appears next (Figure 6-7).

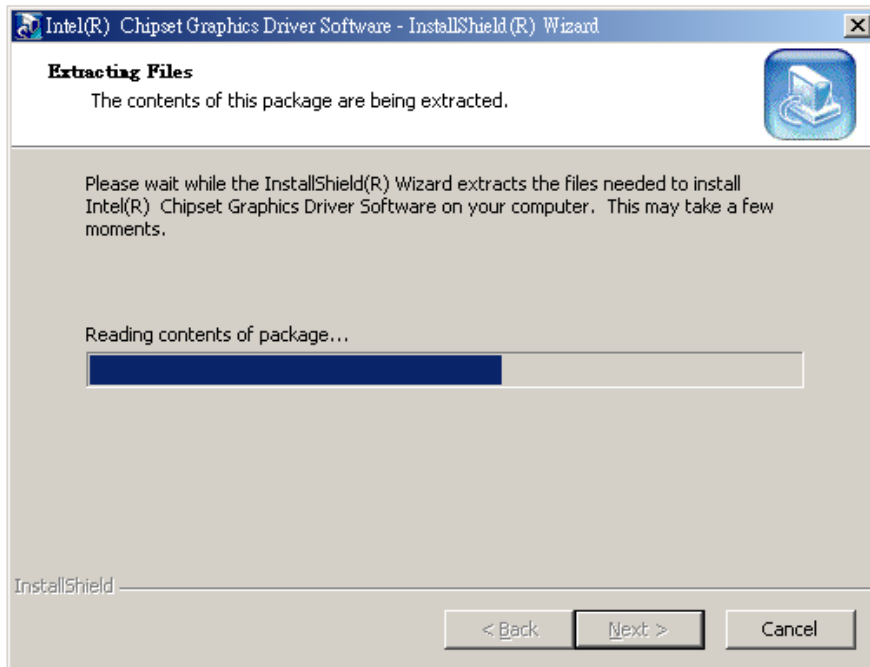

Figure 6-7: Preparing Setup Screen

Step 5: A Welcome screen shown in Figure 6-8 appears. Click **NEXT** to continue the installation.

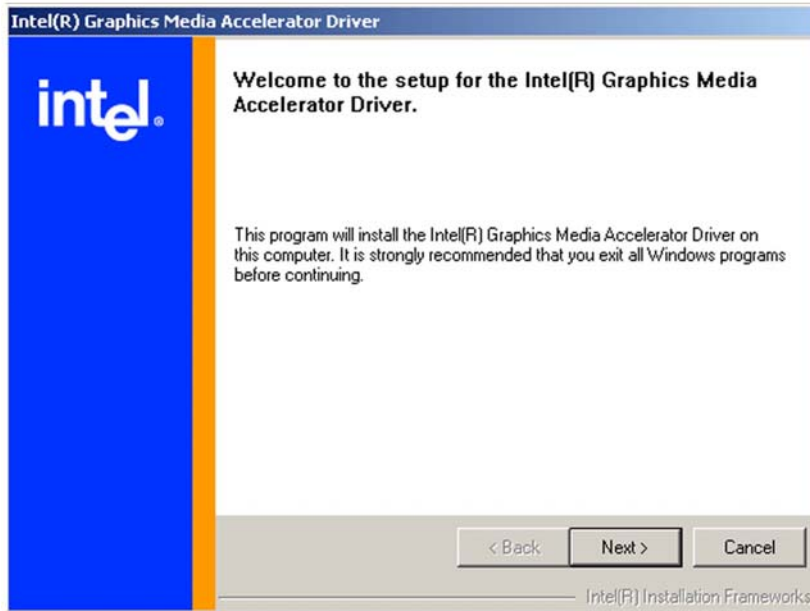

Figure 6-8: VGA Driver Installation Welcome Screen

Step 6: A license agreement shown in Figure 6-9 appears. Read through the license agreement.

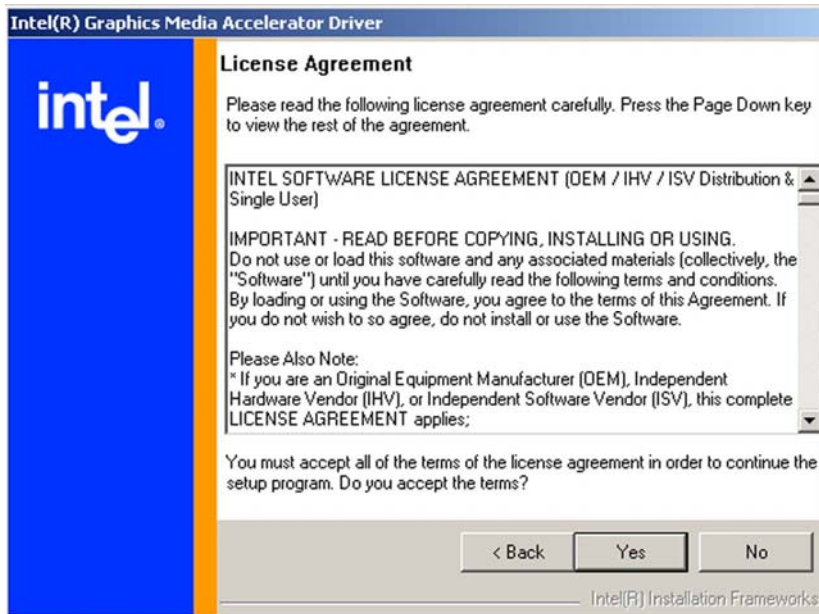

Figure 6-9: VGA Driver License Agreement

WSB-9454 PCIMG 1.0 CPU Card

Step 7: Accept the terms and conditions stipulated in the license agreement by clicking the “YES” button (Figure 6-9). The installation notice shown in Figure 6-10 appears.



Figure 6-10: VGA Driver Installing Notice

Step 8: After the driver installation process is complete, a confirmation screen shown in Figure 6-11 appears.

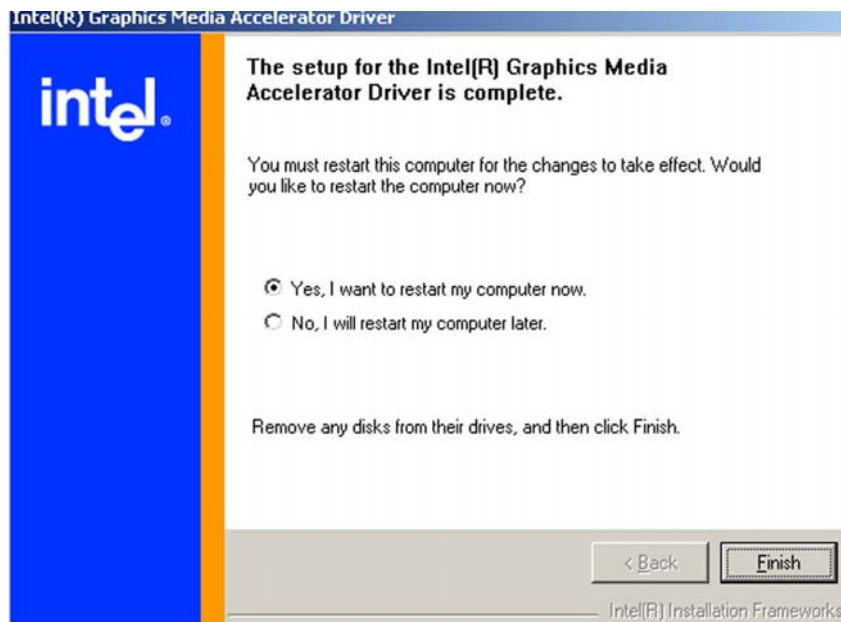

Figure 6-11: VGA Driver Installation Complete

Step 9: The confirmation screen shown in Figure 6-11 allows user to restart the computer immediately after the installation is complete or to restart the computer later. For the settings to take effect the computer must be restarted. Once decided when to restart the computer, click the “FINISH” button.

6.4 Realtek LAN Driver (for GbE LAN) Installation

To install the Realtek LAN driver, please follow the steps below.

Step 1: Open **Windows Control Panel** (Figure 6-12).

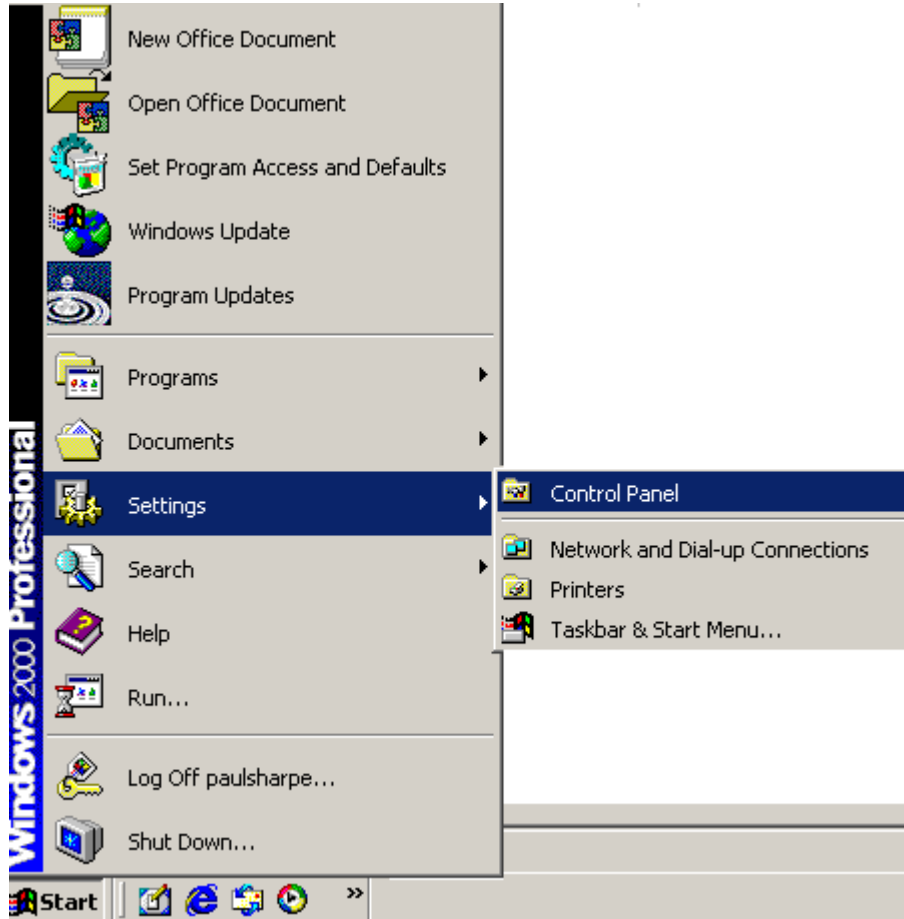

Figure 6-12: Access Windows Control Panel

Step 2: Double click the **System** icon (Figure 6-13).

WSB-9454 PCIMG 1.0 CPU Card

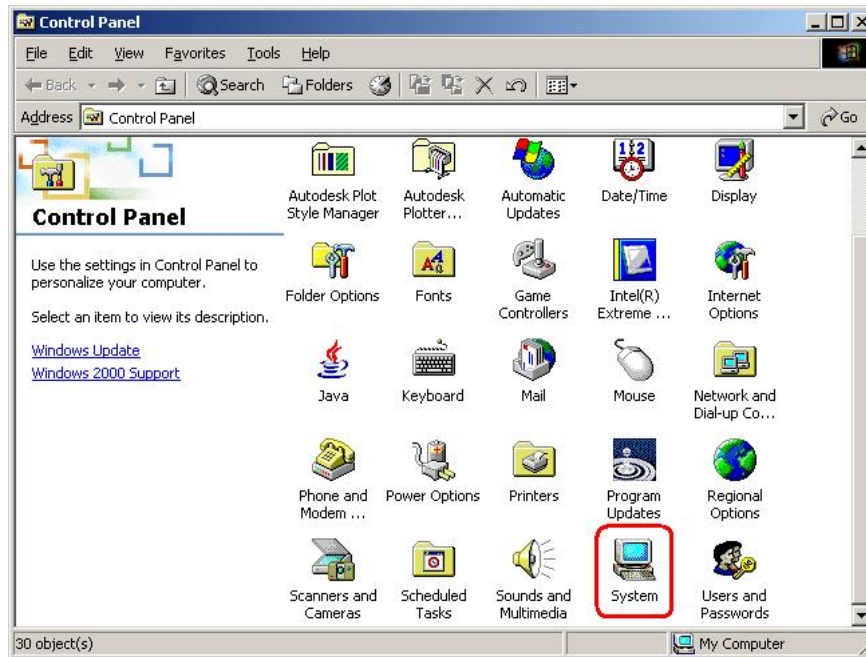

Figure 6-13: Double Click the System Icon

Step 3: Click the **Hardware Tab**, then double click **Device Manager** (Figure 6-14).

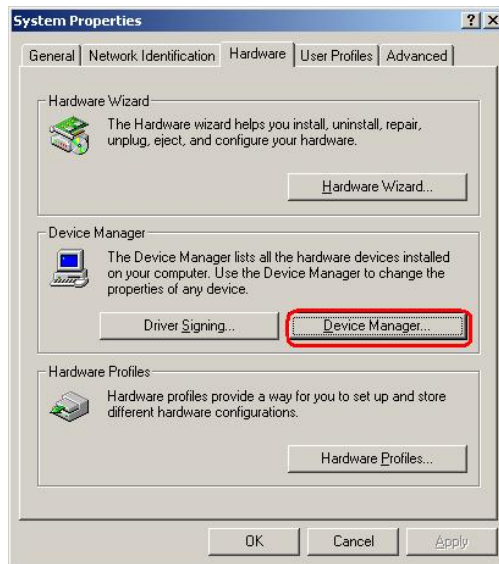

Figure 6-14: Double Click the Device Manager Tab

Step 4: A list of system hardware devices appears (Figure 6-15).

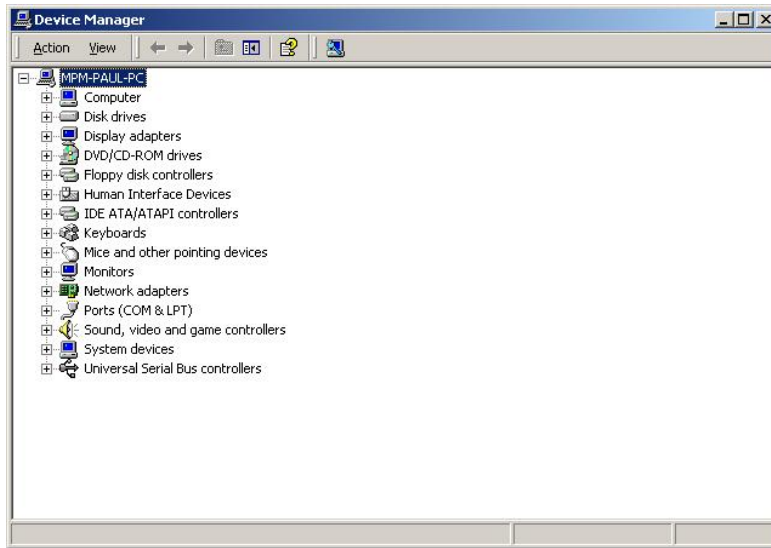

Figure 6-15: Device Manager List

Step 5: Double click the listed device that has question marks next to it. (This means Windows does not recognize the device).

Step 6: The **Device Driver Wizard** appears (Figure 6-16). Click **NEXT** to continue.



Figure 6-16: Search for Suitable Driver

WSB-9454 PCIMG 1.0 CPU Card

Step 7: Select “Specify a Location” in the **Locate Driver Files** window (Figure 6-17).

Click **NEXT** to continue.

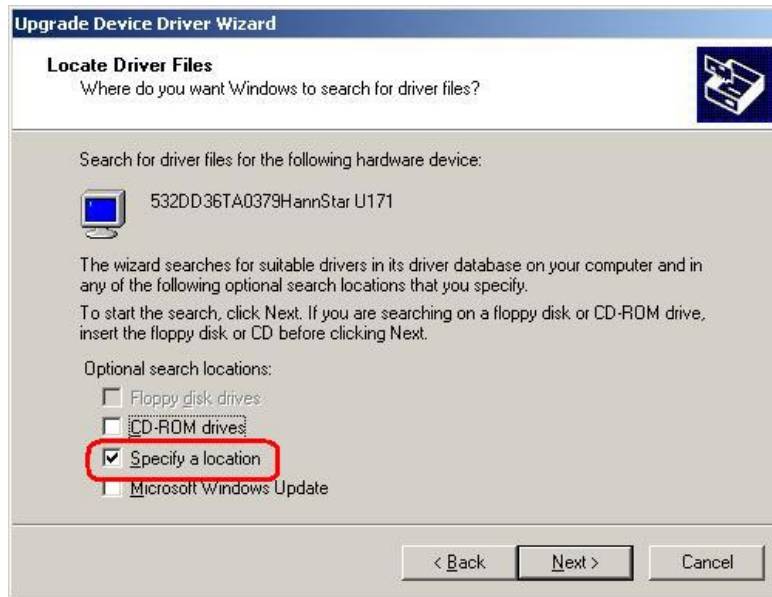

Figure 6-17: Locate Driver Files

Step 8: Select the proper OS folder under the “X:\XX” directory (Figure 6-18) in the location browsing window, where “X:\” is the system CD drive and “XX” is the folder name.

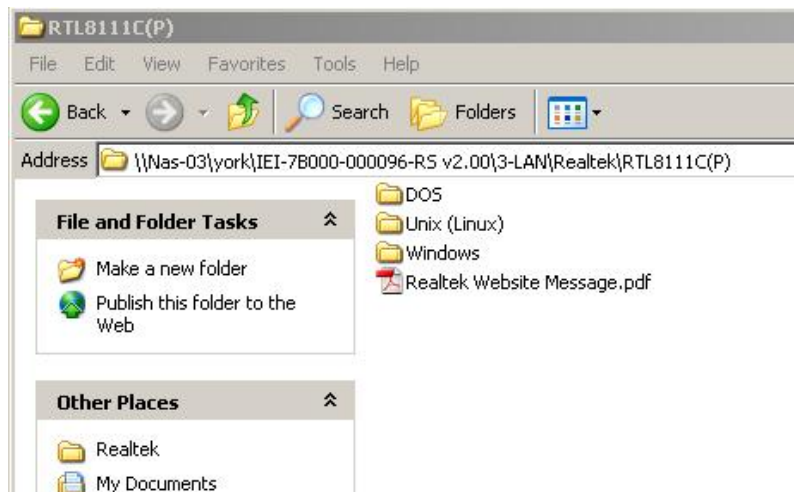

Figure 6-18: Location Browsing Window

Step 9: Click **OK** to continue. A driver files location menu window appears. Click **NEXT** to continue. The driver is installed.

6.5 Realtek AC'97 (ALC655) Audio Driver Installation

To install the Realtek AC `97 audio driver, please follow the steps below.

6.5.1 BIOS Setup

Step 1: Enter the BIOS setup. To do this, reboot the system and press **DEL** during POST.

Step 2: Go to the Southbridge Configuration menu

Step 3: Press **F10** to save the changes and exit the BIOS setup. The system reboots.

6.5.2 Driver Installation

Step 1: Insert the SIS Solution CD that came with the package.

Step 2: From the main driver menu, navigate to **X:\4-AUDIO\AC-KIT08R\Windows** (or other appropriate OS). **X:** represents the system CD drive. A new window appears showing the folder contents (Figure 6-19).

WSB-9454 PCIMG 1.0 CPU Card

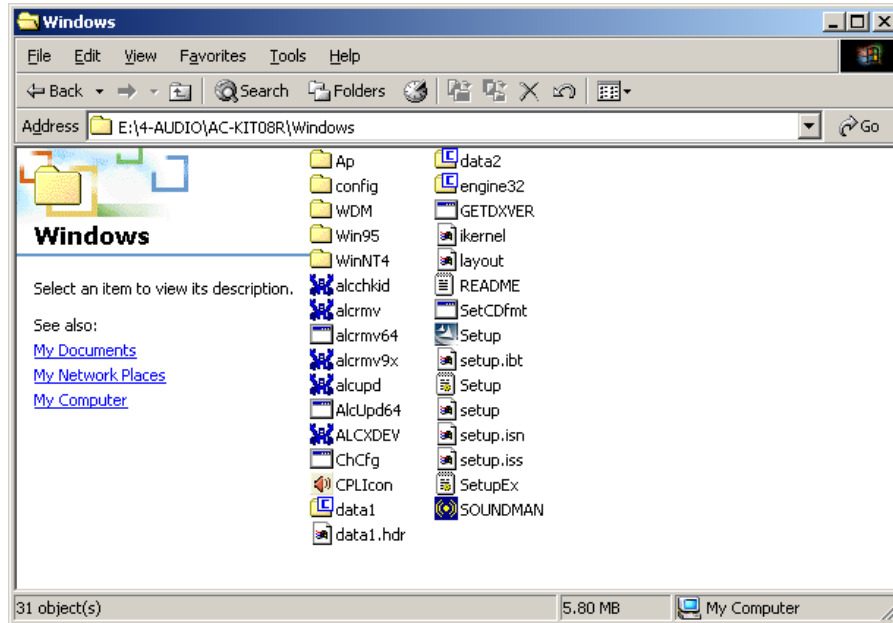

Figure 6-19: CD 4-AUDIO\AC-KIT08R\Windows Folder

Step 3: Double-click the **Setup.exe** file to begin the driver installation process.

Step 4: Once you double click the **Setup** icon, the install shield wizard for the audio driver starts. See Figure 6-20.

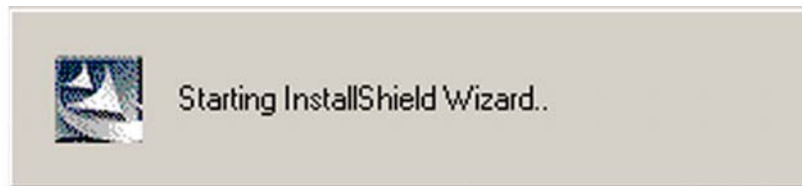

Figure 6-20: AC`97 Audio Driver Install Shield Wizard Starting

Step 5: The Realtek Audio Setup prepares the install shield to guide you through the rest of the setup process. See Figure 6-21.

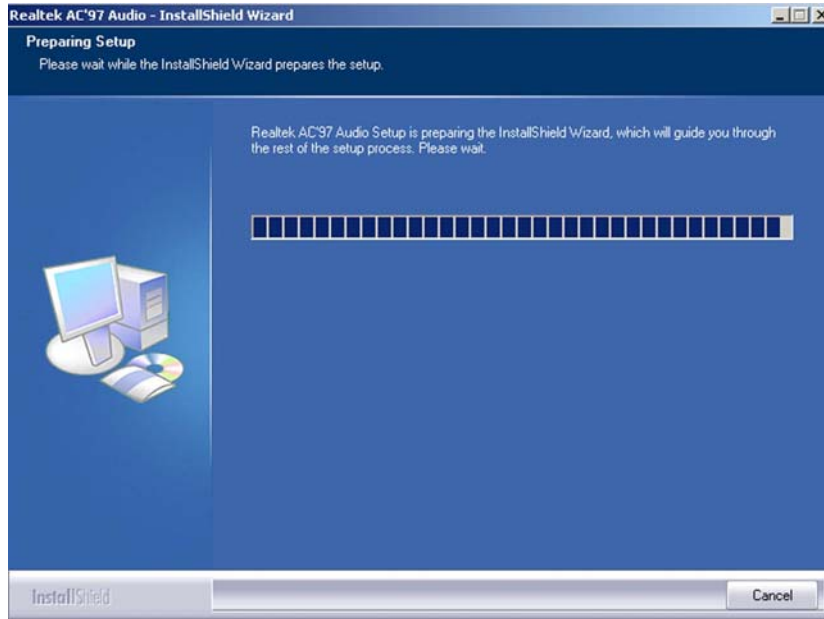

Figure 6-21: AC`97 Audio Driver Setup Preparation

Step 6: After the install shield is prepared, the welcome screen shown in Figure 6-22 appears. To continue the installation process, click the **“NEXT”** button. The install shield starts to configure the new software as shown in Figure 6-23.

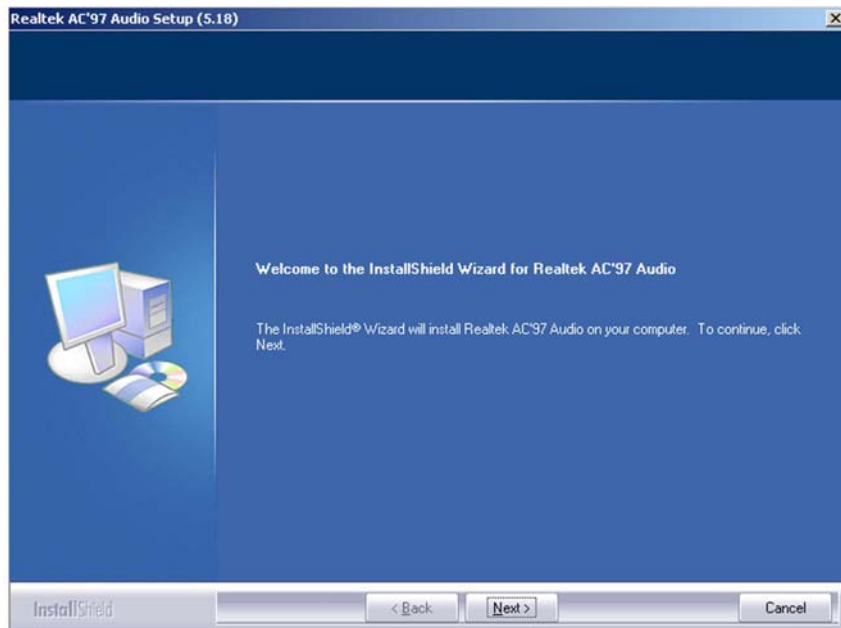

Figure 6-22: AC`97 Audio Driver Welcome Screen

WSB-9454 PCIMG 1.0 CPU Card

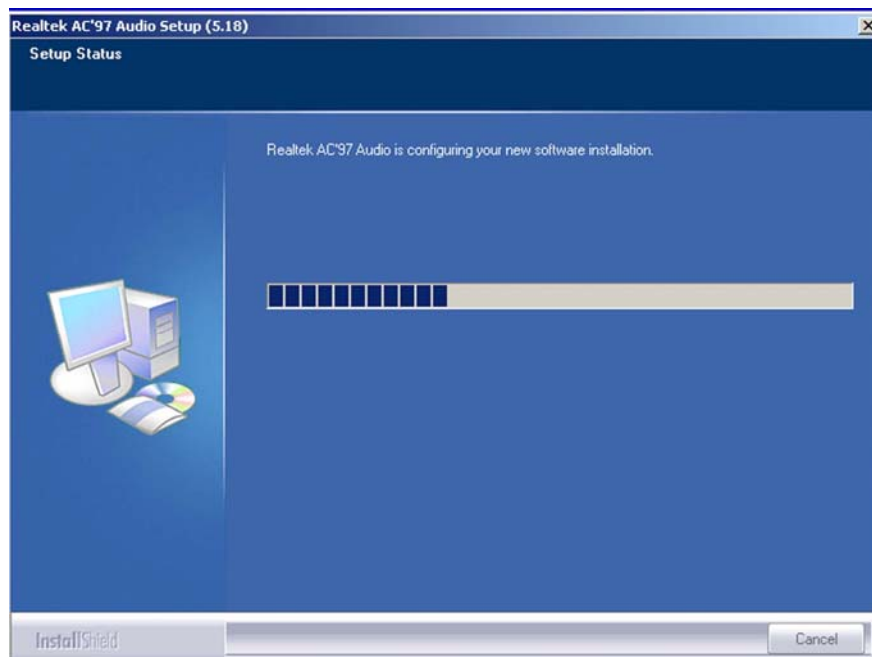

Figure 6-23: AC'97 Audio Driver Software Configuration

Step 7: At this stage the “Digital Signal Not Found” screen appears (Figure 6-24). To continue the installation process, click the “YES” button.

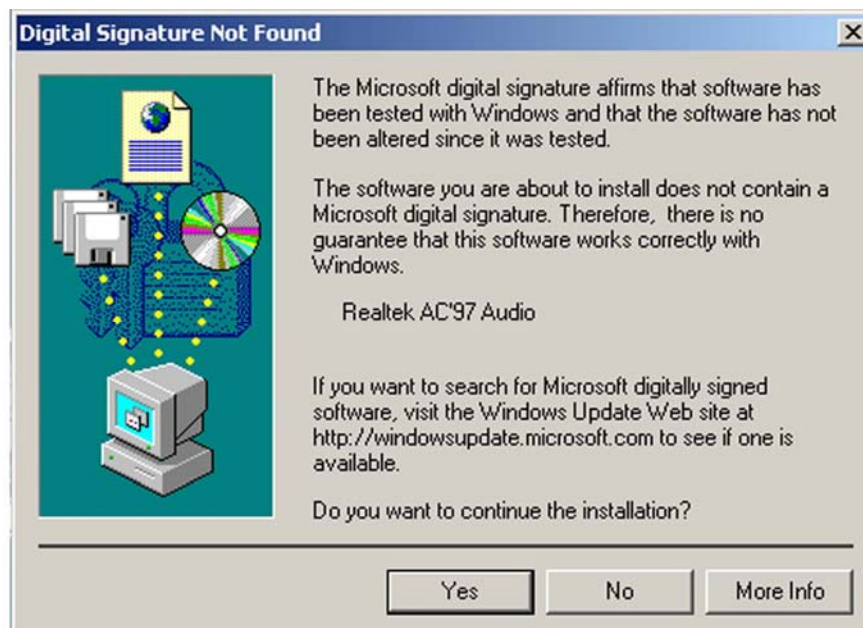

Figure 6-24: AC'97 Audio Driver Digital Signal

Step 8: After clicking the “YES” button in Figure 6-24, the installation of the driver begins (Figure 6-25).

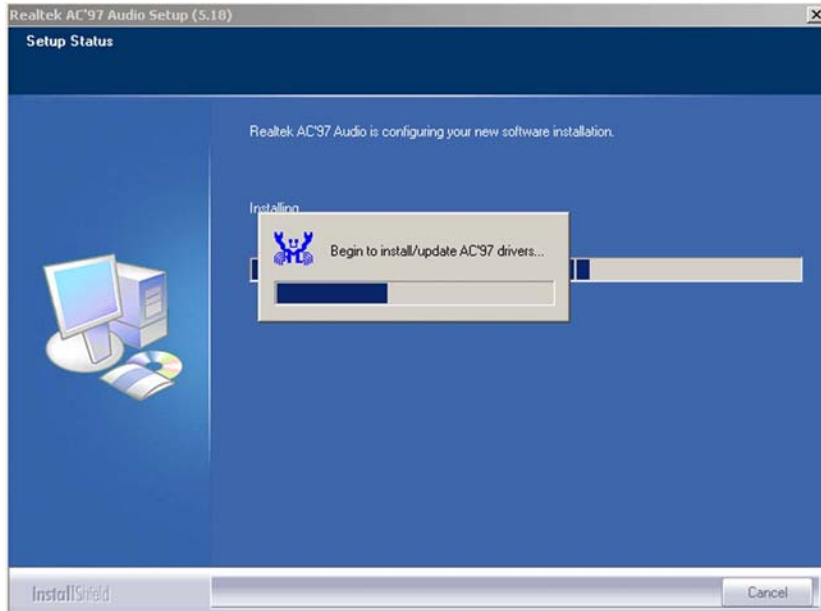

Figure 6-25: AC`97 Audio Driver Installation Begins

Step 9: After the driver installation process is complete, a confirmation screen shown in Figure 6-26 appears.

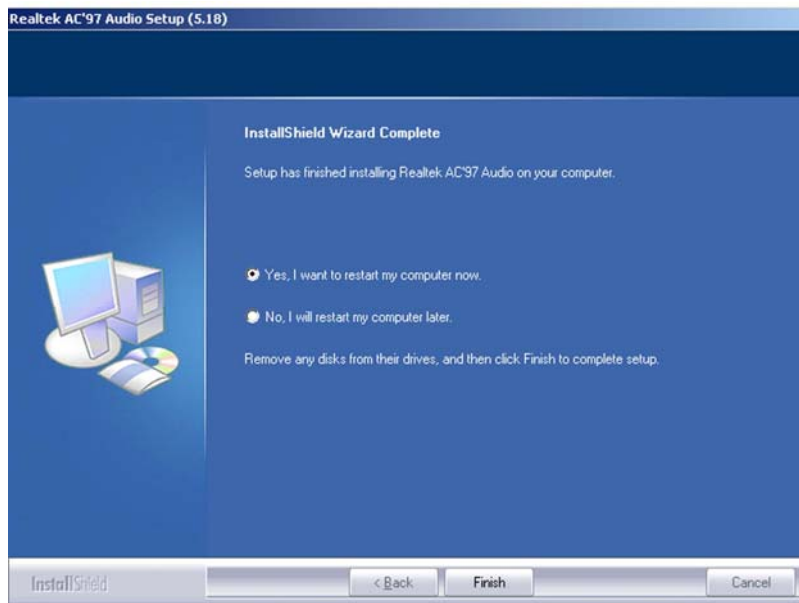

Figure 6-26: AC`97 Audio Driver Installation Complete

WSB-9454 PCIMG 1.0 CPU Card

Step 10: The confirmation screen shown in Figure 6-26 allows you to restart the computer immediately after the installation is complete or to restart the computer later. For the settings to take effect the computer must be restarted. Once you have decided when to restart the computer, click the “FINISH” button.

Appendix

A

BIOS Options

WSB-9454 PCIMG 1.0 CPU Card

Below is a list of BIOS configuration options in the BIOS chapter.

System Overview	56
System Time [xx:xx:xx]	57
System Date [xx/xx/xx]	57
ATA/IDE Configurations [Compatible]	59
Configure SATA as [IDE]	60
Configure SATA Channels [Behind PATA]	60
Legacy IDE Channels [PATA Pri, SATA Sec]	60
OnBoard PCI IDE Controller [Both]	60
Onboard PCI IDE Mode [Legacy Mode]	61
Onboard PCI S-ATA Controller	61
IDE Master and IDE Slave	62
Hard Disk Write Protect [Disabled]	62
IDE Detect Time Out (Sec) [35]	62
ATA (PI) 80Pin Cable Detection [Host & Device]	63
Auto-Detected Drive Parameters	64
Type [Auto]	65
LBA/Large Mode [Auto]	65
Block (Multi Sector Transfer) [Auto]	65
PIO Mode [Auto]	66
DMA Mode [Auto]	66
S.M.A.R.T [Auto]	67
32Bit Data Transfer [Enabled]	68
Floppy A/B	68
Serial Port1 Address [3F8/IRQ4]	69
Serial Port2 Address [2F8/IRQ3]	70
Serial Port2 Mode [Normal]	70
Parallel Port Address [378]	70
Parallel Port Mode [Normal]	70
Parallel Port IRQ [IRQ7]	71
Mode Setting [Full On Mode]	72
CPUFAN PWM Control [100]	72
Power Supply Mode [ATX]	73
Suspend Mode [S1(POS)]	74

Restore on AC Power Loss [Last State]	74
Power Button Mode [On/Off].....	75
Resume on Keyboard/Mouse [Disabled]	75
Resume on Ring [Disabled]	75
Resume on LAN [Disabled].....	75
Resume On RTC Alarm [Disabled].....	76
Keyboard WakeUp [Disabled].....	76
Mouse WakeUp [Disabled]	76
Remote Access [Disabled].....	77
Serial Port Number [COM1].....	77
Base Address, IRQ [2F8h,3].....	78
Serial Port Mode [115200 8,n,1].....	78
Flow Control [None].....	78
Redirection After BIOS POST [Always]	79
Terminal Type [ANSI].....	79
VT-UTF8 Combo Key Support [Disabled].....	79
Sredir Memory Display Delay [Disabled].....	80
USB Function [Enabled].....	80
USB 2.0 Controller [Enabled].....	81
Legacy USB Support [Enabled].....	81
USB2.0 Controller Mode [HiSpeed].....	81
USB Mass Storage Reset Delay [20 Sec]	82
Device ##.....	82
Emulation Type [Auto].....	82
IRQ# [Available]	84
DMA Channel# [Available]	85
Quick Boot [Enabled]	87
Quiet Boot [Disabled]	87
AddOn ROM Display Mode [Force BIOS]	87
Bootup Num-Lock [On]	87
Onboard Lan Rom [Disabled]	87
Change Supervisor Password	91
Change User Password.....	91
Clear User Password	91
Boot Sector Virus Protection [Disabled]	92

WSB-9454 PCIMG 1.0 CPU Card

Memory Hole [Disabled]	93
Initiate Graphic Adapter	93
Internal Graphics Mode Select [Enable, 8 MB]	94
Boot Display Device	94
Audio Controller [All Disabled].....	95
Spread Spectrum [Disabled].....	95
Save Changes and Exit	96
Discard Changes and Exit.....	96
Discard Changes.....	96
Load Optimal Defaults.....	96
Load Failsafe Defaults.....	97

Appendix

B

Terminology

WSB-9454 PCIMG 1.0 CPU Card

AC '97	Audio Codec 97 (AC'97) refers to a codec standard developed by Intel® in 1997.
ACPI	Advanced Configuration and Power Interface (ACPI) is an OS-directed configuration, power management, and thermal management interface.
AHCI	Advanced Host Controller Interface (AHCI) is a SATA Host controller register-level interface.
ATA	The Advanced Technology Attachment (ATA) interface connects storage devices including hard disks and CD-ROM drives to a computer.
ARMD	An ATAPI Removable Media Device (ARMD) is any ATAPI device that supports removable media, besides CD and DVD drives.
ASKIR	Amplitude Shift Keyed Infrared (ASKIR) is a form of modulation that represents a digital signal by varying the amplitude (“volume”) of the signal. A low amplitude signal represents a binary 0, while a high amplitude signal represents a binary 1.
BIOS	The Basic Input/Output System (BIOS) is firmware that is first run when the computer is turned on and can be configured by the end user
CODEC	The Compressor-Decompressor (CODEC) encodes and decodes digital audio data on the system.
CompactFlash®	CompactFlash® is a solid-state storage device. CompactFlash® devices use flash memory in a standard size enclosure. Type II is thicker than Type I, but a Type II slot can support both types.
CMOS	Complimentary metal-oxide-conductor is an integrated circuit used in chips like static RAM and microprocessors.
COM	COM refers to serial ports. Serial ports offer serial communication to expansion devices. The serial port on a personal computer is usually a male DB-9 connector.
DAC	The Digital-to-Analog Converter (DAC) converts digital signals to analog signals.
DDR	Double Data Rate refers to a data bus transferring data on both the rising and falling edges of the clock signal.

DMA	Direct Memory Access (DMA) enables some peripheral devices to bypass the system processor and communicate directly with the system memory.
DIMM	Dual Inline Memory Modules are a type of RAM that offer a 64-bit data bus and have separate electrical contacts on each side of the module.
DIO	The digital inputs and digital outputs are general control signals that control the on/off circuit of external devices or TTL devices. Data can be read or written to the selected address to enable the DIO functions.
EHCI	The Enhanced Host Controller Interface (EHCI) specification is a register-level interface description for USB 2.0 Host Controllers.
EIDE	Enhanced IDE (EIDE) is a newer IDE interface standard that has data transfer rates between 4.0 MBps and 16.6 MBps.
EIST	Enhanced Intel® SpeedStep Technology (EIST) allows users to modify the power consumption levels and processor performance through application software. The application software changes the bus-to-core frequency ratio and the processor core voltage.
FSB	The Front Side Bus (FSB) is the bi-directional communication channel between the processor and the Northbridge chipset.
GbE	Gigabit Ethernet (GbE) is an Ethernet version that transfers data at 1.0 Gbps and complies with the IEEE 802.3-2005 standard.
GPIO	General purpose input
HDD	Hard disk drive (HDD) is a type of magnetic, non-volatile computer storage device that stores digitally encoded data.
ICH	The Input/Output Control Hub (ICH) is an Intel® Southbridge chipset.
IrDA	Infrared Data Association (IrDA) specifies infrared data transmission protocols used to enable electronic devices to wirelessly communicate with each other.
L1 Cache	The Level 1 Cache (L1 Cache) is a small memory cache built into the system processor.
L2 Cache	The Level 2 Cache (L2 Cache) is an external processor memory cache.

WSB-9454 PCIMG 1.0 CPU Card

LCD	Liquid crystal display (LCD) is a flat, low-power display device that consists of two polarizing plates with a liquid crystal panel in between.
LVDS	Low-voltage differential signaling (LVDS) is a dual-wire, high-speed differential electrical signaling system commonly used to connect LCD displays to a computer.
POST	The Power-on Self Test (POST) is the pre-boot actions the system performs when the system is turned-on.
RAM	Random Access Memory (RAM) is volatile memory that loses data when power is lost. RAM has very fast data transfer rates compared to other storage like hard drives.
SATA	Serial ATA (SATA) is a serial communications bus designed for data transfers between storage devices and the computer chipsets. The SATA bus has transfer speeds up to 1.5 Gbps and the SATA II bus has data transfer speeds of up to 3.0 Gbps.
S.M.A.R.T	Self Monitoring Analysis and Reporting Technology (S.M.A.R.T) refers to automatic status checking technology implemented on hard disk drives.
UART	Universal Asynchronous Receiver-transmitter (UART) is responsible for asynchronous communications on the system and manages the system's serial communication (COM) ports.
UHCI	The Universal Host Controller Interface (UHCI) specification is a register-level interface description for USB 1.1 Host Controllers.
USB	The Universal Serial Bus (USB) is an external bus standard for interfacing devices. USB 1.1 supports 12Mbps data transfer rates and USB 2.0 supports 480Mbps data transfer rates.
VGA	The Video Graphics Array (VGA) is a graphics display system developed by IBM.

Appendix

C

Digital I/O Interface

WSB-9454 PCIMG 1.0 CPU Card

C.1 Introduction

The DIO connector on the WSB-9454 is interfaced to GPIO ports on the Super I/O chipset. The DIO has both 4-bit digital inputs and 4-bit digital outputs. The digital inputs and digital outputs are generally control signals that control the on/off circuit of external devices or TTL devices. Data can be read or written to the selected address to enable the DIO functions.



NOTE:

For further information, please refer to the datasheet for the Super I/O chipset.

The BIOS interrupt call **INT 15H** controls the digital I/O.

INT 15H:

AH – 6FH	
<u>Sub-function:</u>	
AL – 8	: Set the digital port as INPUT
AL	: Digital I/O input value

C.2 Assembly Language Sample 1

```
MOV     AX, 6F08H      ;setting the digital port as input
INT     15H           ;
```

AL low byte = value

AH – 6FH
<u>Sub-function:</u>
AL – 9 : Set the digital port as OUTPUT
BL : Digital I/O input value

C.3 Assembly Language Sample 2

```
MOV     AX, 6F09H      ;setting the digital port as output
MOV     BL, 09H        ;digital value is 09H
INT     15H           ;
```

Digital Output is 1001b

Appendix

D

Watchdog Timer



NOTE:

The following discussion applies to DOS environment. IEI support is contacted or the IEI website visited for specific drivers for more sophisticated operating systems, e.g., Windows and Linux.

The Watchdog Timer is provided to ensure that standalone systems can always recover from catastrophic conditions that cause the CPU to crash. This condition may have occurred by external EMIs or a software bug. When the CPU stops working correctly, Watchdog Timer either performs a hardware reset (cold boot) or a Non-Maskable Interrupt (NMI) to bring the system back to a known state.

A BIOS function call (INT 15H) is used to control the Watchdog Timer.

INT 15H:

AH – 6FH Sub-function:	
AL – 2:	Sets the Watchdog Timer's period.
BL:	Time-out value (Its unit-second is dependent on the item "Watchdog Timer unit select" in CMOS setup).

Table D-1: AH-6FH Sub-function

Call sub-function 2 to set the time-out period of Watchdog Timer first. If the time-out value is not zero, the Watchdog Timer starts counting down. When the timer value reaches zero, the system resets. To ensure that this reset condition does not occur, calling sub-function 2 must periodically refresh the Watchdog Timer. However, the watchdog timer is disabled if the time-out value is set to zero.

A tolerance of at least 10% must be maintained to avoid unknown routines within the operating system (DOS), such as disk I/O that can be very time-consuming.

WSB-9454 PCIMG 1.0 CPU Card

**NOTE:**

When exiting a program it is necessary to disable the Watchdog Timer, otherwise the system resets.

EXAMPLE PROGRAM:

; INITIAL TIMER PERIOD COUNTER

;

W_LOOP:

;

```

MOV      AX, 6F02H      ;setting the time-out value
MOV      BL, 30         ;time-out value is 48 seconds
INT      15H

```

;

; ADD THE APPLICATION PROGRAM HERE

;

```

CMP      EXIT_AP, 1     ;is the application over?
JNE      W_LOOP        ;No, restart the application

MOV      AX, 6F02H     ;disable Watchdog Timer
MOV      BL, 0         ;
INT      15H

```

;

; EXIT ;

Appendix

E

Hazardous Materials Disclosure

E.1 Hazardous Materials Disclosure Table for IPB Products Certified as RoHS Compliant Under 2002/95/EC Without Mercury

The details provided in this appendix are to ensure that the product is compliant with the Peoples Republic of China (China) RoHS standards. The table below acknowledges the presences of small quantities of certain materials in the product, and is applicable to China RoHS only.

A label will be placed on each product to indicate the estimated “Environmentally Friendly Use Period” (EFUP). This is an estimate of the number of years that these substances would “not leak out or undergo abrupt change.” This product may contain replaceable sub-assemblies/components which have a shorter EFUP such as batteries and lamps. These components will be separately marked.

Please refer to the table on the next page.

Part Name	Toxic or Hazardous Substances and Elements					
	Lead (Pb)	Mercury (Hg)	Cadmium (Cd)	Hexavalent Chromium (CR(VI))	Polybrominated Biphenyls (PBB)	Polybrominated Diphenyl Ethers (PBDE)
Housing	<input type="radio"/>	<input type="radio"/>	<input type="radio"/>	<input type="radio"/>	<input type="radio"/>	<input type="radio"/>
Display	<input type="radio"/>	<input type="radio"/>	<input type="radio"/>	<input type="radio"/>	<input type="radio"/>	<input type="radio"/>
Printed Circuit Board	<input type="radio"/>	<input type="radio"/>	<input type="radio"/>	<input type="radio"/>	<input type="radio"/>	<input type="radio"/>
Metal Fasteners	<input type="radio"/>	<input type="radio"/>	<input type="radio"/>	<input type="radio"/>	<input type="radio"/>	<input type="radio"/>
Cable Assembly	<input type="radio"/>	<input type="radio"/>	<input type="radio"/>	<input type="radio"/>	<input type="radio"/>	<input type="radio"/>
Fan Assembly	<input type="radio"/>	<input type="radio"/>	<input type="radio"/>	<input type="radio"/>	<input type="radio"/>	<input type="radio"/>
Power Supply Assemblies	<input type="radio"/>	<input type="radio"/>	<input type="radio"/>	<input type="radio"/>	<input type="radio"/>	<input type="radio"/>
Battery	<input type="radio"/>	<input type="radio"/>	<input type="radio"/>	<input type="radio"/>	<input type="radio"/>	<input type="radio"/>

O: This toxic or hazardous substance is contained in all of the homogeneous materials for the part is below the limit requirement in SJ/T11363-2006

X: This toxic or hazardous substance is contained in at least one of the homogeneous materials for this part is above the limit requirement in SJ/T11363-2006

WSB-9454 PCIMG 1.0 CPU Card

此附件旨在确保本产品符合中国 RoHS 标准。以下表格标示此产品中某有毒物质的含量符合中国 RoHS 标准规定的限量要求。

本产品上会附有“环境友好使用期限”的标签，此期限是估算这些物质“不会有泄漏或突变”的年限。本产品可能包含有较短的环境友好使用期限的可替换元件，像是电池或灯管，这些元件将会单独标示出来。

部件名称	有毒有害物质或元素					
	铅 (Pb)	汞 (Hg)	镉 (Cd)	六价铬 (CR(VI))	多溴联苯 (PBB)	多溴二苯 醚 (PBDE)
壳体	○	○	○	○	○	○
显示	○	○	○	○	○	○
印刷电路板	○	○	○	○	○	○
金属螺帽	○	○	○	○	○	○
电缆组装	○	○	○	○	○	○
风扇组装	○	○	○	○	○	○
电力供应组装	○	○	○	○	○	○
电池	○	○	○	○	○	○

○: 表示该有毒有害物质在该部件所有物质材料中的含量均在 SJ/T11363-2006 标准规定的限量要求以下。
 X: 表示该有毒有害物质至少在该部件的某一均质材料中的含量超出 SJ/T11363-2006 标准规定的限量要求。