



NEXCOM International Co., Ltd.

Industrial Computing Solutions

Applied Panel Display

APPD 1200T/1205T/1500T/1700T/1900T

User Manual

Contents

Preface

Copyright	iv
Disclaimer	iv
Acknowledgements	iv
Regulatory Compliance Statements	iv
Declaration of Conformity	iv
RoHS Compliance	v
Warranty and RMA	vi
Safety Information	viii
Installation Recommendations	viii
Safety Precautions	ix
Technical Support and Assistance	x
Conventions Used in this Manual	x
Global Service Contact Information	xi
Package Contents	xiii
Ordering Information	xv

Chapter 1: Product Introduction

Overview - APPD 1200T/1205T	1
Key Features	1
Overview - APPD 1500T	2
Key Features	2
Overview - APPD 1700T	3
Key Features	3
Overview - APPD 1900T	4
Key Features	4

Specifications	5
APPD 1200T	5
Specifications	6
APPD 1205T	6
Specifications	7
APPD 1500T	7
Specifications	8
APPD 1700T	8
Specifications	9
APPD 1900T	9
Knowing Your APPD Series	10
Front Top View of APPD 1200T/1205T	10
Front Top View of APPD 1500T	10
Front Top View of APPD 1700T	10
Front Top View of APPD 1900T	10
Front Top View in Detail	11
Rear Bottom View of APPD 1200T/1205T	12
Rear Bottom View of APPD 1500T	12
Rear Bottom View of APPD 1700T	12
Rear Bottom View of APPD 1900T	12
Rear Bottom View in Detail	13
Rear View of APPD 1200T/1205T	14
Rear View of APPD 1500T	15
Rear View of APPD 1700T	16
Rear View of APPD 1900T	17
Mechanical Dimensions	18
APPD 1200T/1205T	18

APPD 1500T	19
APPD 1700T	20
APPD 1900T	21
Chapter 2: Connector Pin Definitions	
External I/O Interfaces	22
USB Port.....	22
COM Port.....	22
DVI Port (DVI-D).....	23
VGA Port.....	23
12 – 24V DC Input	24
Chapter 3: System Setup	
Panel Mounting	25
Installing the Power Adapter Bracket.....	28
Chapter 4: Adjusting the Display	
OSD Menu Functions	33
Chapter 5: Touch Driver Settings.....49	
Appendix A: Power Consumption.....50	
Appendix B: Extended Display Identification Data Timing Support.....51	

Preface

Copyright

This publication, including all photographs, illustrations and software, is protected under international copyright laws, with all rights reserved. No part of this manual may be reproduced, copied, translated or transmitted in any form or by any means without the prior written consent from NEXCOM International Co., Ltd.

Disclaimer

The information in this document is subject to change without prior notice and does not represent commitment from NEXCOM International Co., Ltd. However, users may update their knowledge of any product in use by constantly checking its manual posted on our website: <http://www.nexcom.com>. NEXCOM shall not be liable for direct, indirect, special, incidental, or consequential damages arising out of the use of any product, nor for any infringements upon the rights of third parties, which may result from such use. Any implied warranties of merchantability or fitness for any particular purpose is also disclaimed.

Acknowledgements

APPD 1200T/1205T/1500T/1700T/1900T is a trademark of NEXCOM International Co., Ltd. All other product names mentioned herein are registered trademarks of their respective owners.

Regulatory Compliance Statements

This section provides the FCC compliance statement for Class B devices and describes how to keep the system CE compliant.

Declaration of Conformity

FCC

This equipment has been tested and verified to comply with the limits for a Class B digital device, pursuant to Part 15 of FCC Rules. These limits are designed to provide reasonable protection against harmful interference when the equipment is operated in a commercial environment. This equipment generates, uses, and can radiate radio frequency energy and, if not installed and used in accordance with the instructions, may cause harmful interference to radio communications. Operation of this equipment in a residential area (domestic environment) is likely to cause harmful interference, in which case the user will be required to correct the interference (take adequate measures) at their own expense.

CE

The product(s) described in this manual complies with all applicable European Union (CE) directives if it has a CE marking. For computer systems to remain CE compliant, only CE-compliant parts may be used. Maintaining CE compliance also requires proper cable and cabling techniques.

RoHS Compliance



NEXCOM RoHS Environmental Policy and Status Update

This publication, including all photographs, illustrations and software, is protected under international copyright laws, with all rights reserved. No part of this manual may be reproduced, copied, translated or transmitted in any form or by any means without the prior written consent from NEXCOM International Co., Ltd.

RoHS restricts the use of Lead (Pb) < 0.1% or 1,000ppm, Mercury (Hg) < 0.1% or 1,000ppm, Cadmium (Cd) < 0.01% or 100ppm, Hexavalent Chromium (Cr6+) < 0.1% or 1,000ppm, Polybrominated biphenyls (PBB) < 0.1% or 1,000ppm, and Polybrominated diphenyl Ethers (PBDE) < 0.1% or 1,000ppm.

In order to meet the RoHS compliant directives, NEXCOM has established an engineering and manufacturing task force to implement the introduction of green products. The task force will ensure that we follow the standard NEXCOM development procedure and that all the new RoHS components and new manufacturing processes maintain the highest industry quality levels for which NEXCOM are renowned.

The model selection criteria will be based on market demand. Vendors and suppliers will ensure that all designed components will be RoHS compliant.

How to recognize NEXCOM RoHS Products?

For existing products where there are non-RoHS and RoHS versions, the suffix "(LF)" will be added to the compliant product name.

All new product models launched after January 2006 will be RoHS compliant. They will use the usual NEXCOM naming convention.

Warranty and RMA

NEXCOM Warranty Period

NEXCOM manufactures products that are new or equivalent to new in accordance with industry standard. NEXCOM warrants that products will be free from defect in material and workmanship for 2 years, beginning on the date of invoice by NEXCOM. HCP series products (Blade Server) which are manufactured by NEXCOM are covered by a three year warranty period.

NEXCOM Return Merchandise Authorization (RMA)

- Customers shall enclose the “NEXCOM RMA Service Form” with the returned packages.
- Customers must collect all the information about the problems encountered and note anything abnormal or, print out any on-screen messages, and describe the problems on the “NEXCOM RMA Service Form” for the RMA number apply process.
- Customers can send back the faulty products with or without accessories (manuals, cable, etc.) and any components from the card, such as CPU and RAM. If the components were suspected as part of the problems, please note clearly which components are included. Otherwise, NEXCOM is not responsible for the devices/parts.
- Customers are responsible for the safe packaging of defective products, making sure it is durable enough to be resistant against further damage and deterioration during transportation. In case of damages occurred during transportation, the repair is treated as “Out of Warranty.”
- Any products returned by NEXCOM to other locations besides the customers’ site will bear an extra charge and will be billed to the customer.

Repair Service Charges for Out-of-Warranty Products

NEXCOM will charge for out-of-warranty products in two categories, one is basic diagnostic fee and another is component (product) fee.

Repair Service Charges for Out-of-Warranty Products

NEXCOM will charge for out-of-warranty products in two categories, one is basic diagnostic fee and another is component (product) fee.

System Level

- Component fee: NEXCOM will only charge for main components such as SMD chip, BGA chip, etc. Passive components will be repaired for free, ex: resistor, capacitor.
- Items will be replaced with NEXCOM products if the original one cannot be repaired. Ex: motherboard, power supply, etc.
- Replace with 3rd party products if needed.
- If RMA goods can not be repaired, NEXCOM will return it to the customer without any charge.

Board Level

- Component fee: NEXCOM will only charge for main components, such as SMD chip, BGA chip, etc. Passive components will be repaired for free, ex: resistors, capacitors.
- If RMA goods can not be repaired, NEXCOM will return it to the customer without any charge.

Warnings

Read and adhere to all warnings, cautions, and notices in this guide and the documentation supplied with the chassis, power supply, and accessory modules. If the instructions for the chassis and power supply are inconsistent with these instructions or the instructions for accessory modules, contact the supplier to find out how you can ensure that your computer meets safety and regulatory requirements.

Cautions

Electrostatic discharge (ESD) can damage system components. Do the described procedures only at an ESD workstation. If no such station is available, you can provide some ESD protection by wearing an antistatic wrist strap and attaching it to a metal part of the computer chassis.

Safety Information

Before installing and using the device, note the following precautions:

- Read all instructions carefully.
- Do not place the unit on an unstable surface, cart, or stand.
- Follow all warnings and cautions in this manual.
- When replacing parts, ensure that your service technician uses parts specified by the manufacturer.
- Avoid using the system near water, in direct sunlight, or near a heating device.
- The load of the system unit does not solely rely for support from the rackmounts located on the sides. Firm support from the bottom is highly necessary in order to provide balance stability.

Installation Recommendations

Ensure you have a stable, clean working environment. Dust and dirt can get into components and cause a malfunction. Use containers to keep small components separated.

Adequate lighting and proper tools can prevent you from accidentally damaging the internal components. Most of the procedures that follow require only a few simple tools, including the following:

- A Philips screwdriver
- A flat-tipped screwdriver
- A grounding strap
- An anti-static pad

Using your fingers can disconnect most of the connections. It is recommended that you do not use needle-nose pliers to disconnect connections as these can damage the soft metal or plastic parts of the connectors.

Safety Precautions

1. Read these safety instructions carefully.
2. Keep this User Manual for later reference.
3. Disconnect this equipment from any AC outlet before cleaning. Use a damp cloth. Do not use liquid or spray detergents for cleaning.
4. For plug-in equipment, the power outlet socket must be located near the equipment and must be easily accessible.
5. Keep this equipment away from humidity.
6. Put this equipment on a stable surface during installation. Dropping it or letting it fall may cause damage.
7. The openings on the enclosure are for air convection to protect the equipment from overheating. **DO NOT COVER THE OPENINGS.**
8. Make sure the voltage of the power source is correct before connecting the equipment to the power outlet.
9. Place the power cord in a way so that people will not step on it. Do not place anything on top of the power cord. Use a power cord that has been approved for use with the product and that it matches the voltage and current marked on the product's electrical range label. The voltage and current rating of the cord must be greater than the voltage and current rating marked on the product.
10. All cautions and warnings on the equipment should be noted.
11. If the equipment is not used for a long time, disconnect it from the power source to avoid damage by transient overvoltage.
12. Never pour any liquid into an opening. This may cause fire or electrical shock.
13. Never open the equipment. For safety reasons, the equipment should be opened only by qualified service personnel.
14. If one of the following situations arises, get the equipment checked by service personnel:
 - a. The power cord or plug is damaged.
 - b. Liquid has penetrated into the equipment.
 - c. The equipment has been exposed to moisture.
 - d. The equipment does not work well, or you cannot get it to work according to the user's manual.
 - e. The equipment has been dropped and damaged.
 - f. The equipment has obvious signs of breakage.
15. Do not place heavy objects on the equipment.
16. The unit uses a three-wire ground cable which is equipped with a third pin to ground the unit and prevent electric shock. Do not defeat the purpose of this pin. If your outlet does not support this kind of plug, contact your electrician to replace your obsolete outlet.
17. **CAUTION: DANGER OF EXPLOSION IF BATTERY IS INCORRECTLY REPLACED. REPLACE ONLY WITH THE SAME OR EQUIVALENT TYPE RECOMMENDED BY THE MANUFACTURER. DISCARD USED BATTERIES ACCORDING TO THE MANUFACTURER'S INSTRUCTIONS.**

Technical Support and Assistance

1. For the most updated information of NEXCOM products, visit NEXCOM's website at www.nexcom.com.
2. For technical issues that require contacting our technical support team or sales representative, please have the following information ready before calling:
 - Product name and serial number
 - Detailed information of the peripheral devices
 - Detailed information of the installed software (operating system, version, application software, etc.)
 - A complete description of the problem
 - The exact wordings of the error messages

Warning!

1. Handling the unit: carry the unit with both hands and handle it with care.
2. Maintenance: to keep the unit clean, use only approved cleaning products or clean with a dry cloth.
3. CompactFlash: Turn off the unit's power before inserting or removing a CompactFlash storage card.

Conventions Used in this Manual



Warning:

Information about certain situations, which if not observed, can cause personal injury. This will prevent injury to yourself when performing a task.



Caution:

Information to avoid damaging components or losing data.



Note:

Provides additional information to complete a task easily.

Global Service Contact Information

Headquarters

NEXCOM International Co., Ltd.

15F, No. 920, Chung-Cheng Rd.,
ZhongHe District, New Taipei City, 23586,
Taiwan, R.O.C.

Tel: +886-2-8226-7786

Fax: +886-2-8226-7782

www.nexcom.com

America

USA

NEXCOM USA

2883 Bayview Drive,
Fremont CA 94538, USA

Tel: +1-510-656-2248

Fax: +1-510-656-2158

Email: sales@nexcom.com

www.nexcom.com

Asia

Taiwan

Central Taiwan Office

16F, No.250, Sec. 2, Chongde Rd.,
Beitun Dist., Taichung City 406, R.O.C.

Tel: +886-4-2249-1179

Fax: +886-4-2249-1172

Email: sales@nexcom.com.tw

www.nexcom.com.tw

Japan

NEXCOM Japan

9F, Tamachi Hara Bldg., 4-11-5, Shiba Minato-ku,
Tokyo, 108-0014, Japan

Tel: +81-3-5419-7830

Fax: +81-3-5419-7832

Email: sales@nexcom-jp.com

www.nexcom-jp.com

China

NEXCOM China

1F & 2F, Block A, No. 16 Yonyou Software Park,
No. 68 Beiqing Road, Haidian District,

Beijing, 100094, China

Tel: +86-010-5704-2680

Fax: +86-010-5704-2681

Email: sales@nexcom.cn

www.nexcom.cn

Shanghai Office

Room 603/604, Huiyinmingzun Plaza Bldg., 1,
No.609, Yunlin East Rd.,

Shanghai, 200062, China

Tel: +86-21-5278-5868

Fax: +86-21-3251-6358

Email: sales@nexcom.cn

www.nexcom.cn

Shenzhen Office

Room1707, North Block, Pines Bldg.,
No.7 Tairan Rd., Futian Area,
Shenzhen, 518040, China
Tel: +86-755-8332-7203
Fax: +86-755-8332-7213
Email: sales@nexcom.cn
www.nexcom.cn

Wuhan Office

1-C1804/ 1805, Mingze Liwan,
No. 519 South Luoshi Rd.,
Hongshan District,
Wuhan, 430070, China
Tel: +86-27-8722-7400
Fax: +86-27-8722-7400
Email: sales@nexcom.cn
www.nexcom.cn

Chengdu Office

9F, Shuxiangxie, Xuefu Garden,
No.12 Section 1, South Yihuan Rd.,
Chengdu, 610061, China
Tel: +86-28-8523-0186
Fax: +86-28-8523-0186
Email: sales@nexcom.cn
www.nexcom.cn

Europe

Italy

NEXCOM ITALIA S.r.l

Via Gaudenzio Ferrari 29,
21047 Saronno (VA), Italia
Tel: +39 02 9628 0333
Fax: +39 02 9286 9215
Email: nexcomitalia@nexcom.eu
www.nexcomitalia.it

United Kingdom

NEXCOM EUROPE

10 Vincent Avenue,
Crownhill Business Centre,
Milton Keynes, Buckinghamshire MK8 0AB,
United Kingdom
Tel: +44-1908-267121
Fax: +44-1908-262042
Email: sales.uk@nexcom.eu
www.nexcom.eu

Package Contents

Before continuing, verify that the package you received is complete. The APPD series package, APPD 1200T/1205T/1500T/1700T/1900T, should have all the items listed in the table.

APPD 1200T/1205T/1500T/1700T

Item	Description	Qty
1	Panel Mount Kit	12
2	Driver CD	1
3	Touch Pen	1
4	VGA Cable (1.8m)	1
5	USB Cable (1.8m)	1
6	Serial Cable (1.8m)	1
7	Terminal blocks 3-pin Phoenix Contact Plug	1
8	Panel Mount Hole Block	12



Terminal blocks
3-pin Phoenix
Contact Plug



VGA Cable



USB Cable



Panel Mount Kit

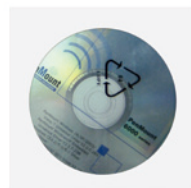

Driver CD



Touch Pen



Serial Cable



Panel Mount Hole Block



Note: Package contents may vary depending on your country region, some items may be optional. Please contact your local distributor for more information.

APPD 1900T

Item	Description	Qty
1	Panel Mount Kit	14
2	Driver CD	1
3	Touch Pen	1
4	VGA Cable (1.8m)	1
5	USB Cable (1.8m)	1
6	Serial Cable (1.8m)	1
7	Terminal blocks 3-pin Phoenix Contact Plug	1
8	Panel Mount Hole Block	14



Terminal blocks
3-pin Phoenix
Contact Plug



VGA Cable



USB Cable



Panel Mount Kit

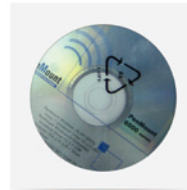

Driver CD



Touch Pen



Serial Cable



Panel Mount Hole Block



Note: Package contents may vary depending on your country region, some items may be optional. Please contact your local distributor for more information.

Ordering Information

The following provides ordering information for the Applied Panel Display series.

- **Barebone**

APPD 1200T (P/N: 10IAD120000X0)

12.1" SVGA industrial 4:3 LED Backlight flush touch monitor with VGA, and DVI-D input, 12~24VDC input, RS-232 and USB touch screen interfaces

APPD 1205T (P/N: 10IAD120500X0)

12.1" XGA industrial 4:3 LED Backlight flush touch monitor with VGA, and DVI-D input, 12~24VDC input, RS-232 and USB touch screen interfaces

APPD 1500T (P/N: 10IAD150000X0)

15" XGA industrial 4:3 LED Backlight flush touch monitor with VGA, and DVI-D input, 12~24VDC input, RS-232 and USB touch screen interfaces

APPD 1700T (P/N: 10IAD170000X0)

17" SXGA industrial 4:3 LCD flush touch monitor with VGA and DVI-D input, 12~24VDC input, RS-232 and USB touch screen interfaces

APPD 1900T (P/N: 10IAD190000X0)

19" SXGA industrial 4:3 LED Backlight flush touch monitor with VGA, and DVI-D input, 12~24V DC input, RS-232 and USB touch screen interfaces

- **Optional**

12V, 60W AC/DC power adapter w/o power cord (P/N: 7400060011X00)

US Power Cord (P/N: 60233POW17X00)



UK Power Cord (P/N: 60233POW19X00)



EU Power Cord (P/N: 60233POW18X00)



1.8m DVI-D Cable (P/N: 60233DVI28X00)



Chapter 1: Product Introduction

Overview - APPD 1200T/1205T



Key Features

- IP65 compliant plastic front bezel with flush panel by 5-wire touch screen
- Dual display input interface: analog VGA and DVI-D
- Shares identical appearance with APPC series
- Dual touch screen interface: RS232 and USB
- Ultra slim in depth
- OSD Multilanguage function

Overview - APPD 1500T



Key Features

- IP65 compliant plastic front bezel with flush panel by 5-wire touch screen
- Dual display input interface: analog VGA and DVI-D
- Shares identical appearance with APPC series
- Dual touch screen interface: RS232 and USB
- Ultra slim in depth
- OSD Multilanguage function

Overview - APPD 1700T



Key Features

- IP65 compliant plastic front bezel with flush panel by 5-wire touch screen
- Dual display input interface: analog VGA and DVI-D
- Shares identical appearance with APPC series
- Dual touch screen interface: RS232 and USB
- Ultra slim in depth
- OSD Multilanguage function

Overview - APPD 1900T



Key Features

- IP65 compliant plastic front bezel with flush panel by 5-wire touch screen
- Dual display input interface: analog VGA and DVI-D
- Shares identical appearance with APPC series
- Dual touch screen interface: RS232 and USB
- Ultra slim in depth
- OSD Multilanguage function

Specifications

APPD 1200T

Panel

- LED Size: 12.1", 4:3
- Resolution: SVGA 800x600
- Luminance: 450cd/m²
- Contrast ratio: 700
- LCD color: 16.2M
- Viewing Angle: 65(U), 75(D), 80(L), 80(R)
- Backlight: LED

Touch Screen

- 5-wire resistive (flush panel type)
- Light transmission: 80%
- Interface: USB and RS232

Rear I/O

- Touch screen interface port: RS-232 (1x DB9) / USB Type A
- Video port: VGA (1x DB15) / DVI-D (1x DVI-I connector)
- DC power input connector: 3-Pin Phoenix terminal Blocks

OSD Function

- OSD keypad
- Multilanguage OSD

Mechanical & Environment

- Color: pantone black
- IP protection: IP65 front
- Mounting: panel/ wall/ stand/ VESA 100mm x 100mm

- Power input: 12V~24VDC
- Power adapter: optional AC to DC power adapter (+12V, 60W)
- Vibration:
 - IEC 68 2-64
 - 2Grms @ sine, 5~500Hz, 1hr/axis (Operating)
 - 2.2Grms @ random condition, 5~500Hz, 0.5hr/axis (Non-operating)
- Shock:
 - IEC 68 2-27
 - 20G@wall mount, half sine, 11ms
 - Operating temperature: -5°C to 60°C
 - Storage temperature: -20°C to 75°C
- Operating humidity: 10%~90% relative humidity, non-condensing
- Dimension: 317 x 243 x 53.5mm
- Weight: 2.9Kg

Certifications

- CE approval
- FCC Class B

Specifications

APPD 1205T

Panel

- LED Size: 12.1", 4:3
- Resolution: XGA 1024x768
- Luminance: 500cd/m²
- Contrast ratio: 700
- LCD color: 16.2M
- Viewing Angle: 80(U), 80(D), 80(L), 80(R)
- Backlight: LED

Touch Screen

- 5-wire resistive (flush panel type)
- Light transmission: 80%
- Interface: USB and RS232

Rear I/O

- Touch screen interface port: RS-232 (1x DB9) / USB Type A
- Video port: VGA (1x DB15) / DVI-D (1x DVI-I connector)
- DC power input connector: 3-Pin Phoenix terminal Blocks

OSD Function

- OSD keypad
- Multilanguage OSD

Mechanical & Environment

- Color: pantone black
- IP protection: IP65 front
- Mounting: panel/ wall/ stand/ VESA 100mm x 100mm

- Power input: 12V~24VDC
- Power adapter: optional AC to DC power adapter (+12V, 60W)
- Vibration:
 - IEC 68 2-64
 - 2Grms @ sine, 5~500Hz, 1hr/axis (Operating)
 - 2.2Grms @ random condition, 5~500Hz, 0.5hr/axis (Non-operating)
- Shock:
 - IEC 68 2-27
 - 20G@wall mount, half sine, 11ms
 - Operating temperature: -5°C to 60°C
 - Storage temperature: -20°C to 75°C
- Operating humidity: 10%~90% relative humidity, non-condensing
- Dimension: 317 x 243 x 53.5mm
- Weight: 2.9Kg

Certifications

- CE approval
- FCC Class B

Specifications

APPD 1500T

Panel

- LED Size: 15", 4:3
- Resolution: XGA 1024x768
- Luminance: 400cd/m²
- Contrast ratio: 700
- LCD color: 16.2M
- Viewing Angle: 60(U), 80(D), 80(L), 80(R)
- Backlight: LED

Touch Screen

- 5-wire resistive (flush panel type)
- Light transmission: 80%
- Interface: USB and RS232

Rear I/O

- Touch screen interface port: RS-232 (1x DB9) / USB Type A
- Video port: VGA (1x DB15) / DVI-D (1x DVI-I connector)
- DC power input connector: 3-Pin Phoenix terminal Blocks

OSD Function

- OSD keypad
- Multilanguage OSD

Mechanical & Environment

- Color: pantone black
- IP protection: IP65 front
- Mounting: panel/ wall/ stand/ VESA 100mm x 100mm

- Power input: 12V~24VDC
- Power adapter: optional AC to DC power adapter (+12V, 60W)
- Vibration:
 - IEC 68 2-64
 - 2Grms @ sine, 5~500Hz, 1hr/axis (Operating)
 - 2.2Grms @ random condition, 5~500Hz, 0.5hr/axis (Non-operating)
- Shock:
 - IEC 68 2-27
 - 20G@wall mount, half sine, 11ms
 - Operating temperature: -5°C to 60°C
 - Storage temperature: -20°C to 75°C
- Operating humidity: 10%~90% relative humidity, non-condensing
- Dimension: 384.37 x 310 x 51.2 mm
- Weight: 3.98Kg

Certifications

- CE approval
- FCC Class B

Specifications

APPD 1700T

Panel

- LED Size: 17", 4:3
- Resolution: SXGA 1280x1024
- Luminance: 380cd/m²
- Contrast ratio: 1000
- LCD color: 16.7M
- Viewing Angle: 80(U), 80(D), 85(L), 85(R)
- Backlight: CCFL

Touch Screen

- 5-wire resistive (flush panel type)
- Light transmission: 81%
- Interface: USB

Rear I/O

- Touch screen interface port: RS-232 (1x DB9) / USB Type A
- Video port: VGA (1x DB15) / DVI-D (1x DVI-I connector)
- DC power input connector: 3-Pin Phoenix terminal Blocks

OSD Function

- OSD keypad
- Multilanguage OSD

Mechanical & Environment

- Color: pantone black
- IP protection: IP65 front
- Mounting: panel/ wall/ stand/ VESA 100mm x 100mm

- Power input: 12V~24VDC
- Power adapter: optional AC to DC power adapter (+12V, 60W)
- Vibration:
 - IEC 68 2-64
 - 2Grms @ sine, 5~500Hz, 1hr/axis (Operating)
 - 2.2Grms @ random condition, 5~500Hz, 0.5hr/axis (Non-operating)
- Shock:
 - IEC 68 2-27
 - 20G@wall mount, half sine, 11ms
 - Operating temperature: -5°C to 50°C
 - Storage temperature: -20°C to 75°C
- Operating humidity: 10%~90% relative humidity, non-condensing
- Dimension: 410.4 x 340.4 x 43.7 mm
- Weight: 5.3 Kg

Certifications

- CE approval
- FCC Class B

Specifications

APPD 1900T

Panel

- LED Size: 19", 4:3
- Resolution: SXGA 1280x1024
- Luminance: 350cd/m²
- Contrast ratio: 1000
- LCD color: 16.7M
- Viewing Angle: 80(U), 80(D), 85(L), 85(R)
- Backlight: LED

Touch Screen

- 5-wire resistive (flush panel type)
- Light transmission: 81%
- Interface: USB

Rear I/O

- Touch screen interface port: RS-232 (1x DB9) / USB Type A
- Video port: VGA (1x DB15) / DVI-D (1x DVI-I connector)
- DC power input connector: 3-Pin Phoenix terminal Blocks

OSD Function

- OSD keypad
- Multilanguage OSD

Mechanical & Environment

- Color: pantone black
- IP protection: IP65 front
- Mounting: panel/ wall/ stand/ VESA 100mm x 100mm

- Power input: 12V~24VDC
- Power adapter: optional AC to DC power adapter (+12V, 60W)
- Vibration:
 - IEC 68 2-64
 - 2Grms @ sine, 5~500Hz, 1hr/axis (Operating)
 - 2.2Grms @ random condition, 5~500Hz, 0.5hr/axis (Non-operating)
- Shock:
 - IEC 68 2-27
 - 20G@wall mount, half sine, 11ms
 - Operating temperature: -5°C to 50°C
 - Storage temperature: -20°C to 75°C
- Operating humidity: 10%~90% relative humidity, non-condensing
- Dimension: 457.64 x 379.24 x 49.25 mm
- Weight: 5.4 Kg

Certifications

- CE approval
- FCC Class B

Knowing Your APPD Series

Front Top View of APPD 1200T/1205T



Power & OSD
Menu Buttons

Front Top View of APPD 1700T



Power & OSD
Menu Buttons

Front Top View of APPD 1500T



Power & OSD
Menu Buttons

Front Top View of APPD 1900T



Power & OSD
Menu Buttons

Front Top View in Detail

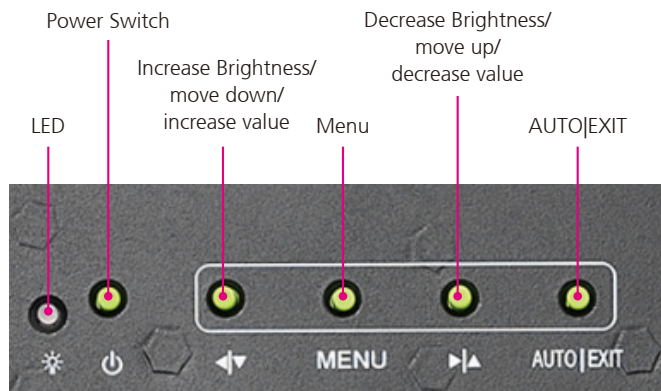

LED

Displays the power status of the display. Green LED indicates the display is switched on, if the display is not connected to a computer, the LED will flash red.

Power Switch

Press to power-on or power-off the display.



No OSD menu: Press to increase the brightness of the screen.
 Inside OSD menu: Press to move the selection down in OSD menu.
 Configuring options: Press to increase the value.



No OSD menu: Press to decrease the brightness of the screen.
 Inside OSD menu: Press to move the selection up in OSD menu.
 Configuring options: Press to decrease the value

OSD Menu

No OSD Menu: Press to load the OSD menu.
 Inside OSD Menu: Press to select the highlighted option in OSD menu.

AUTO|EXIT

Press to exit the OSD menu, or return to main menu.



The OSD will exit automatically if there is no activity in 5 seconds. This timer can be adjusted in OSD menu (Default: On, 5 seconds).

Rear Bottom View of APPD 1200T/1205T



Rear Bottom View of APPD 1700T



Rear Bottom View of APPD 1500T



Rear Bottom View of APPD 1900T



Rear Bottom View in Detail

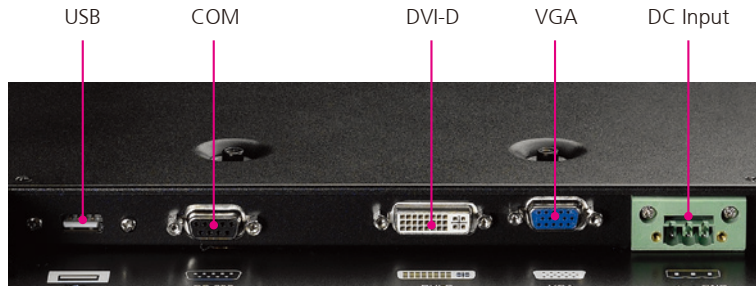

Touchscreen Connector (USB) (Optional)

This USB connector must be attached to the USB port of the PC. The touchscreen cable is included in accessory box.

Touchscreen Connector (DB-9) (Optional)

This RS-232 connector must be connected to the RS-232 port of the PC.



RS-232 & USB touchscreen interface does not allow connection into the system at the same time.

DVI Port (DVI-D)

Connected with a standard DVI connector through I/O port of this unit. Only supports digital signals.

VGA Port (DB-15)

This DB-15 connector can be connected to the system.

12 – 24V DC Input

Terminal block socket used to plug a DC power cord.

Rear View of APPD 1200T/1205T



VESA Mounting Holes

These are mounting holes for VESA mount (100x100mm)

Rear View of APPD 1500T



VESA Mounting Holes

These are mounting holes for VESA mount (100x100mm)

Rear View of APPD 1700T



VESA Mounting Holes

These are mounting holes for VESA mount (100x100mm)

Rear View of APPD 1900T



VESA Mounting Holes

These are mounting holes for VESA mount (100x100mm)

Mechanical Dimensions

APPD 1200T/1205T

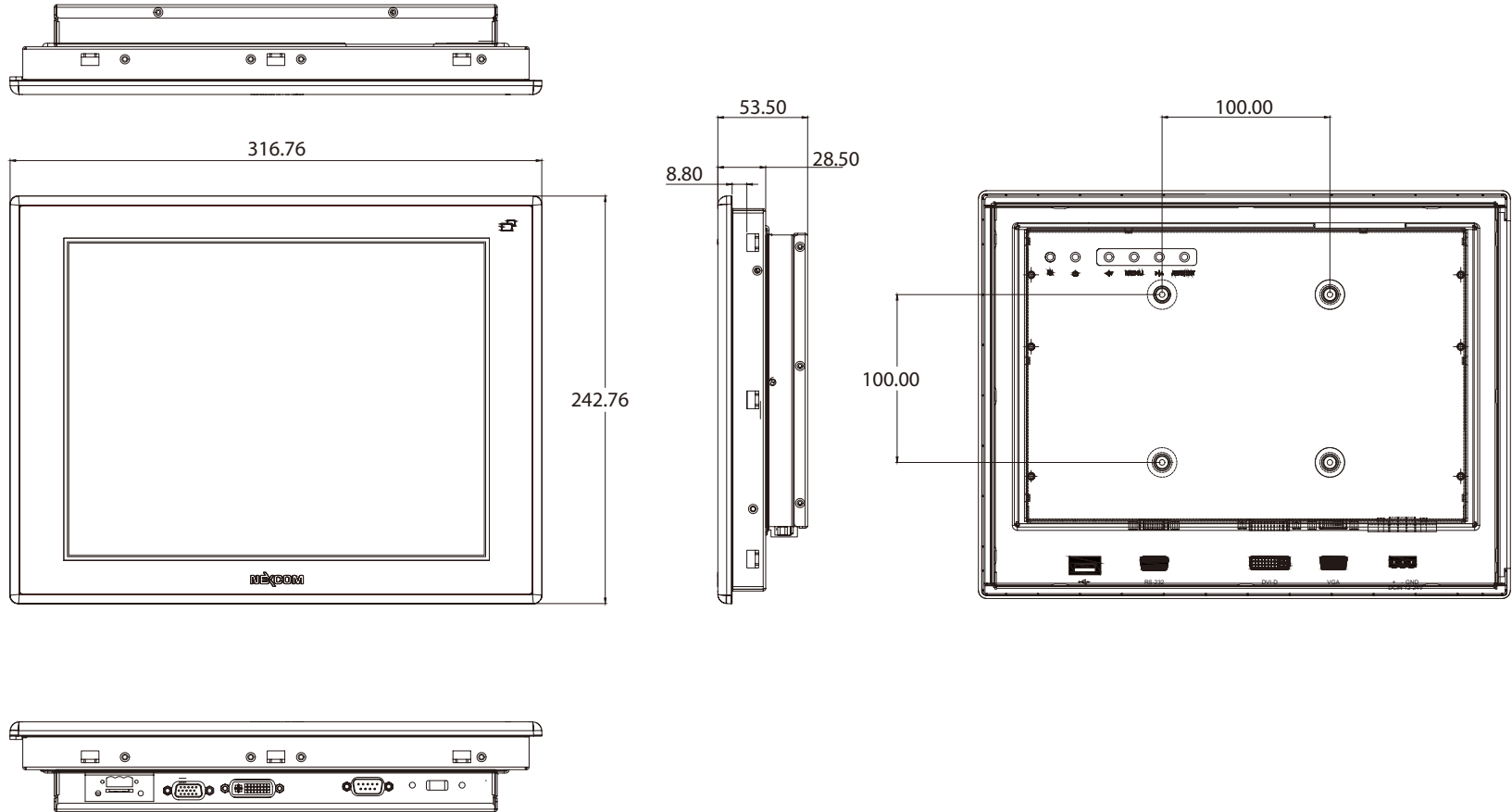

APPD 1500T

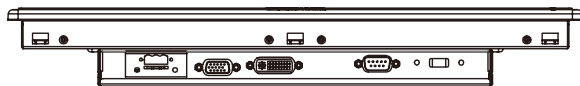
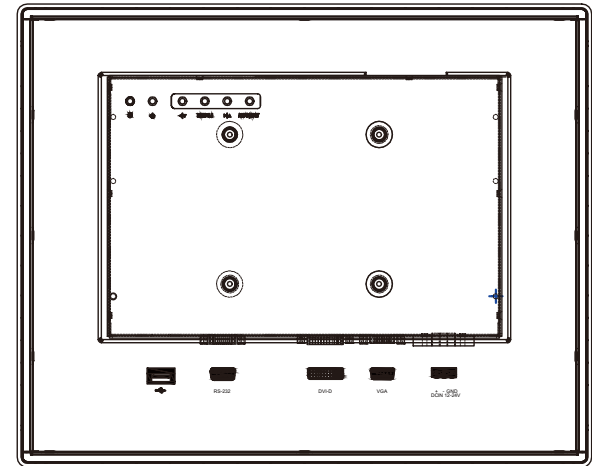
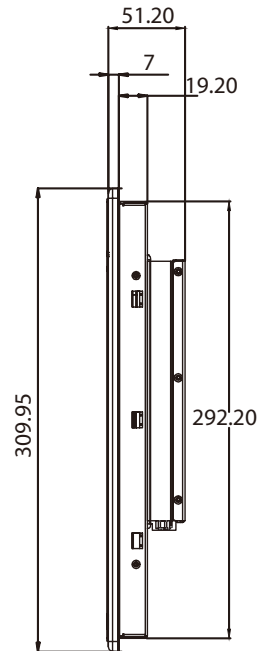
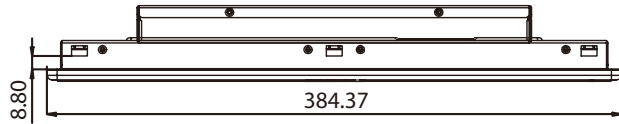

APPD 1700T

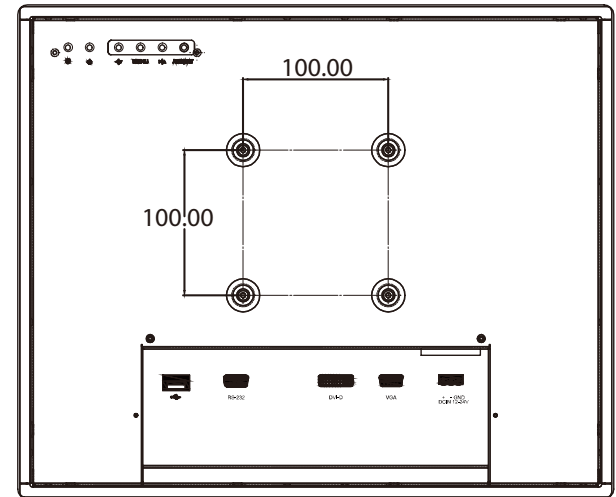
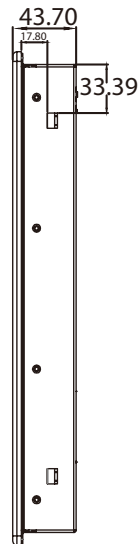
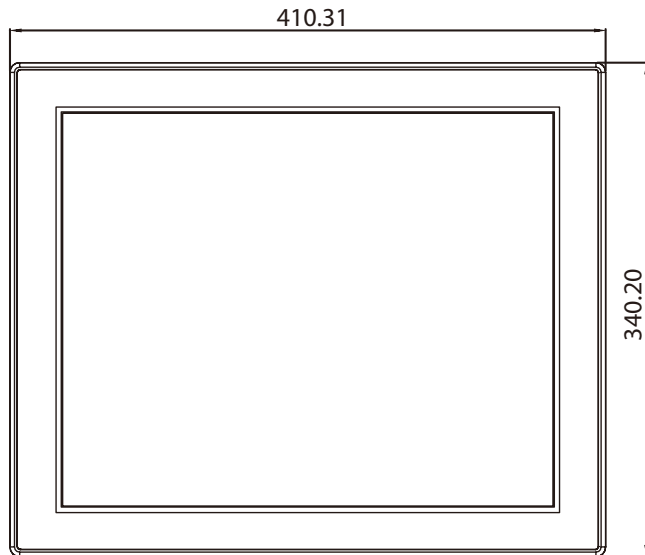
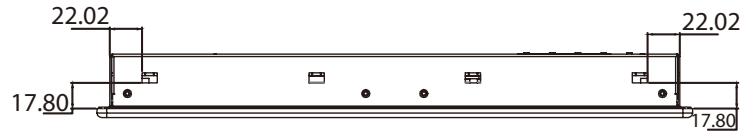

APPD 1900T

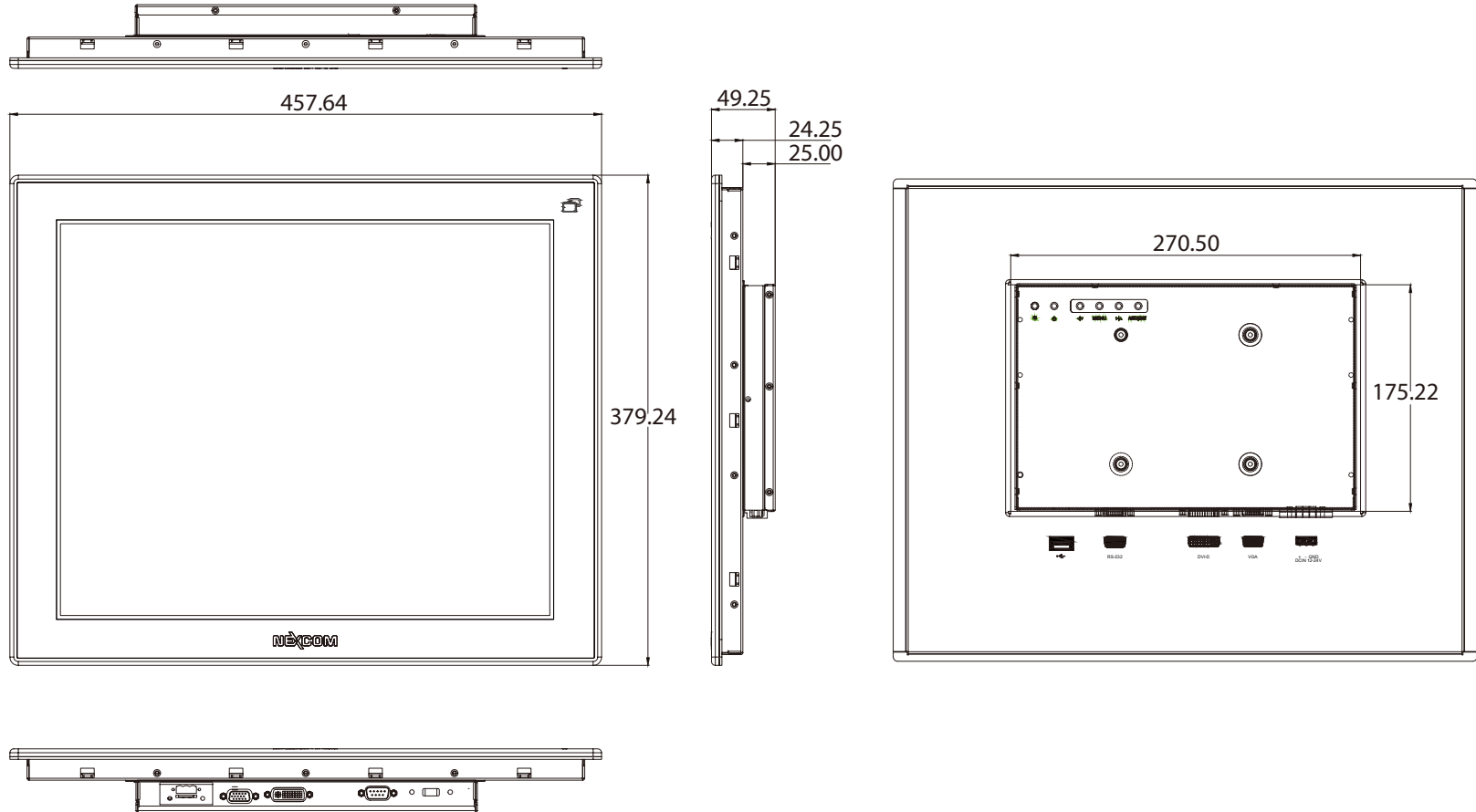

Chapter 2: Connector Pin Definitions

External I/O Interfaces

USB Port

Connector type: USB port



Pin	Definition
1	VCC5
2	DATA_N
3	DATA_P
4	GND

COM Port

Connector type: DB-9 port

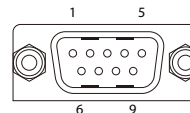

Pin	Definition	Pin	Definition
1	NC	2	RXD#: Receive Data
3	TXD: Transmit Data	4	NC
5	GND	6	NC
7	NC	8	NC
9	NC		

DVI Port (DVI-D)

Connector type: 24-pin D-Sub, 2.0mm-M-180 (DVI)



Pin	Definition	Pin	Definition
1	TMDS Data 2-	2	TMDS Data 2+
3	Shield	4	NC
5	NC	6	DDC clock
7	DDC data	8	Reserved
9	TMDS Data 1-	10	TMDS Data 1+
11	Shield	12	NC
13	NC	14	+5V
15	GND	16	Hot plug detect
17	TMDS data 0-	18	TMDS data 0+
19	Shield	20	NC
21	NC	22	Shield
23	TMDS clock+	24	TMDS clock-
C1	NC	C2	NC
C3	NC	C4	NC
C5	NC		

VGA Port

Connector type: DB-9 port, 9-pin D-Sub (COM1)

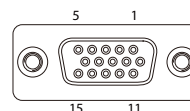

Pin	Definition	Pin	Definition
1	RED	2	GREEN
3	BLUE	4	ID2
5	GND	6	RGND
7	GGND	8	BGND
9	KEY	10	SGND
11	ID0	12	SDA
13	HSYNC or CSYNC	14	VSYNC
15	SCL		

12 – 24V DC Input

Connector type: 3-pin Terminal Block



Pin	Definition
1	+
2	-
3	GND

Chapter 3: System Setup

Panel Mounting

1. Select a place on the panel where you will mount the Industrial Touch Monitor.
2. Cut out a shape on the panel that corresponds to the Industrial Touch Monitor's rear dimensions.

The thickness of the panel (e.g. steel board, plank, acrylic board, wall, etc.) where you will mount the Industrial Touch Monitor must not exceed 3mm for APPD 1500T/1900T and 4mm for APPD 1200T/1205T/1700T. If the distance between the front bezel and panel mount hole is too wide, it will not fit the panel mount kit.

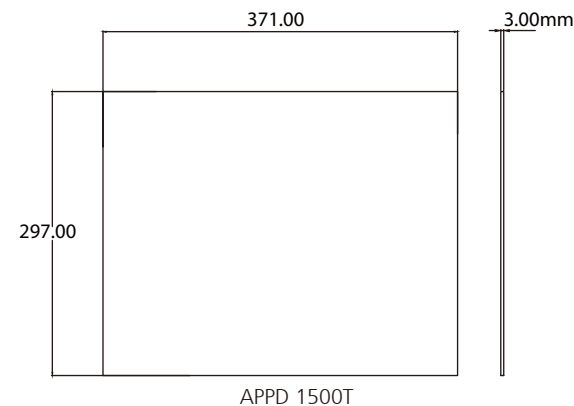
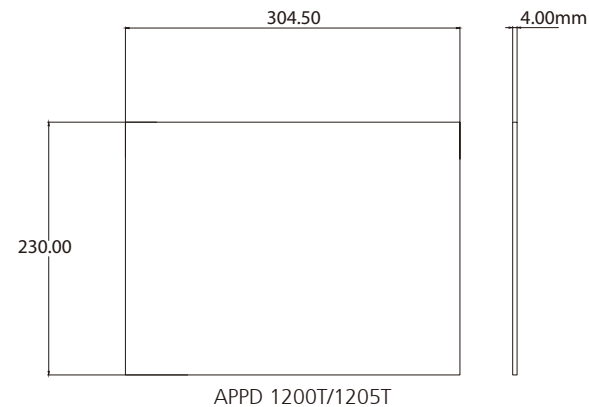

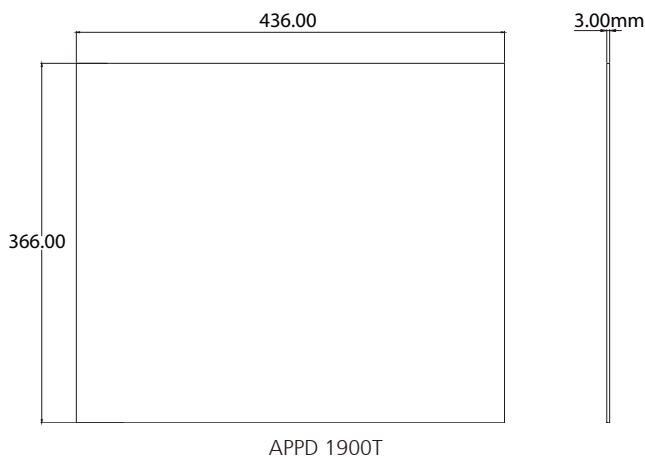
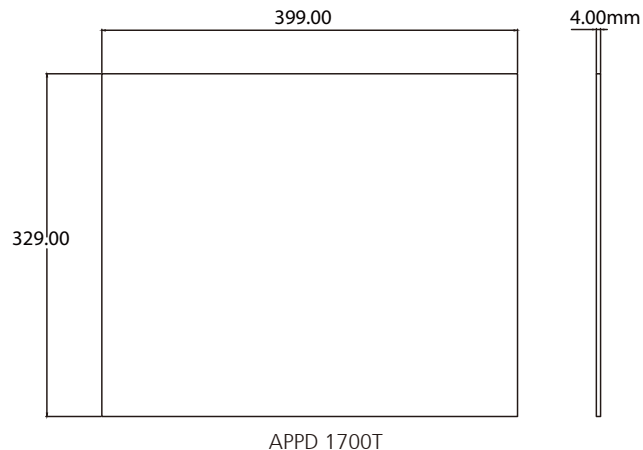

- Slide the Industrial Touch Monitor through the hole until it is properly fitted against the panel.
- Position the mounting clamps along the rear edges of the Industrial Touch Monitor. The first and second clamps must be positioned and secured diagonally prior to mounting the rest of the clamps. Tighten the clamp's screw until it touches the panel.



Do not overtighten the screws to prevent damaging the Panel PC.

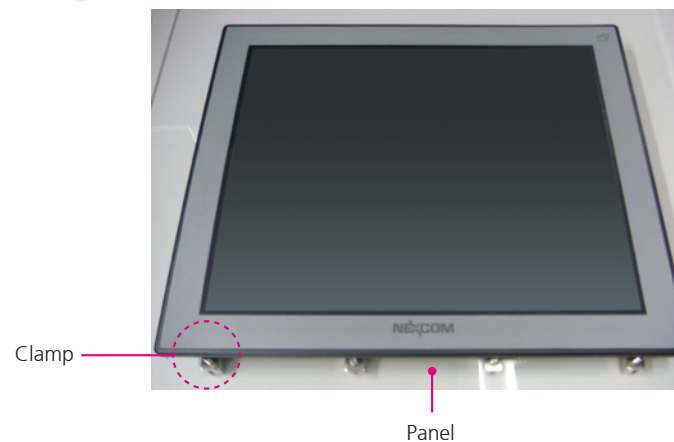

5. The illustration below shows all clamps properly mounted.



Installing the Power Adapter Bracket

(Optional accessory for APPD 1900T only)

1. Locate the mounting screws for the bracket on the back side of the chassis.



2. Remove the mounting screws and store them in a safe place for later use.



3. Wire the power adapter cabling into the cable opening on the bracket, then place the adapter inside the bracket.

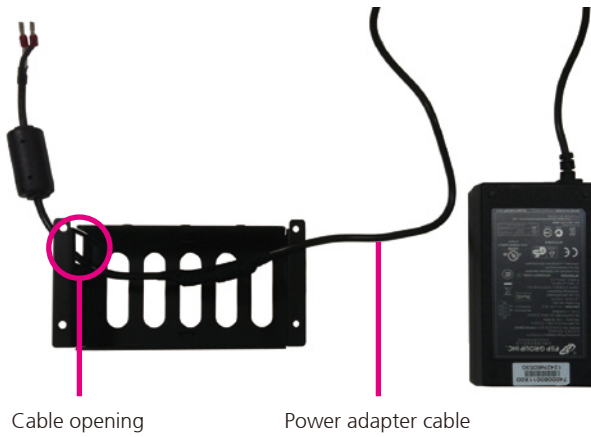

4. Turn the bracket over to the back side, and place the cable tie into the two tie mounts.

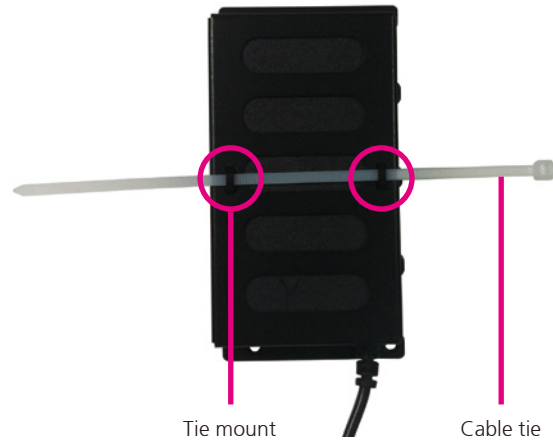

5. Wrap the power adapter cable, then secure the cable firmly by tying the cable tie.



6. With the bracket still facing backwards, align the mounting holes on the bracket to the mounting holes on the back of the chassis, then tighten screws to secure it.

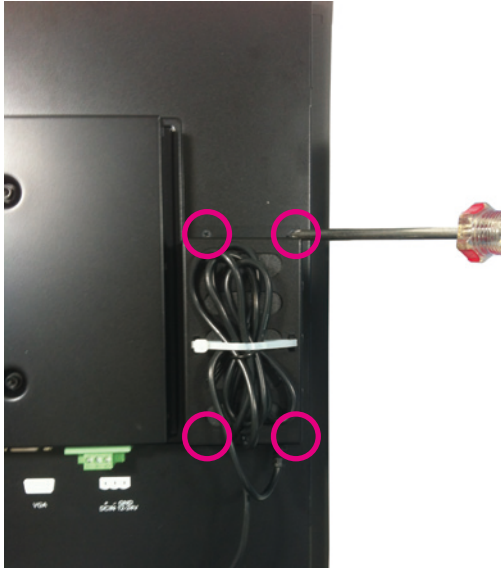

7. Plug the 3-pin terminal block connector into the DC input.



8. Plug the positive, negative and GND wires of the DC power cable into the corresponding pins on the DC input, then tighten the screws on the terminal blocks to secure the wires.



9. Plug the AC power cord into the power adapter.

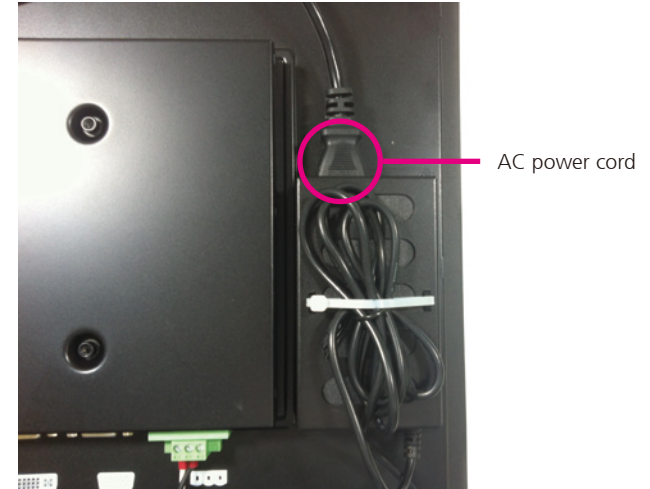

Before plugging the DC power cable wires into the DC input, use a multimeter or voltmeter to measure which wire is positive "+", negative "-", and GND, and ensure that they are connected to the correct pins.

Chapter 4: Adjusting the Display

OSD Menu Functions

The On Screen Display (OSD) menu provides options to adjust the display. Press the MENU button on the back of the display panel to open the OSD menu. Refer to the images below for each OSD menu options.

1. Colour

Contrast

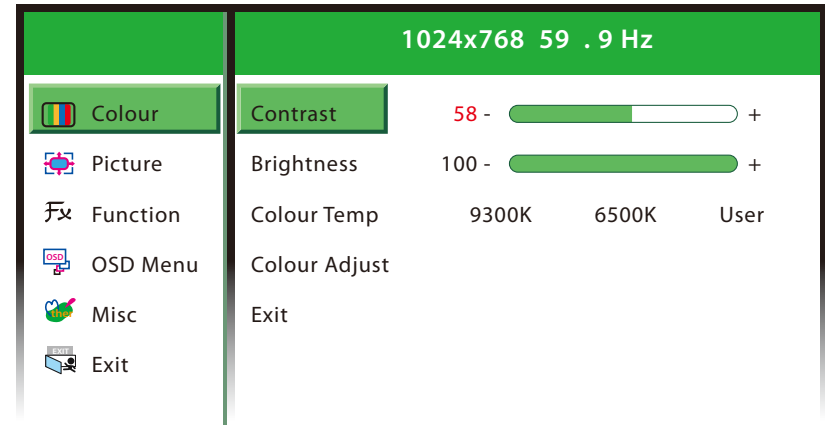
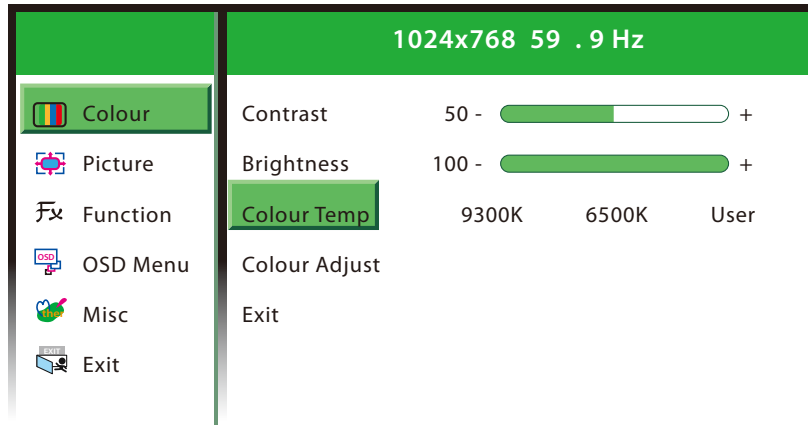

Brightness

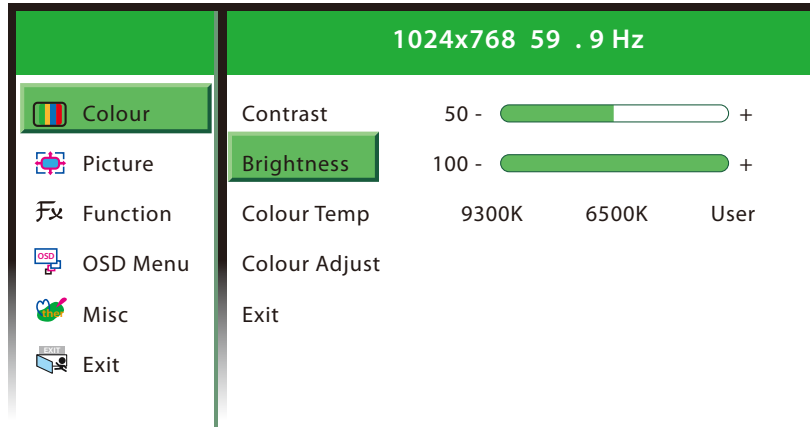

Colour Temp

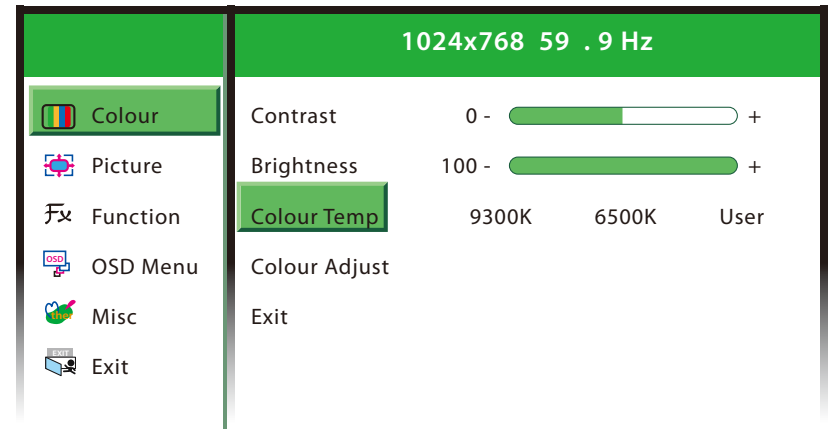

Colour Adjust



Exit

Exits the Colour Adjust sub-menu or press the button to exit.

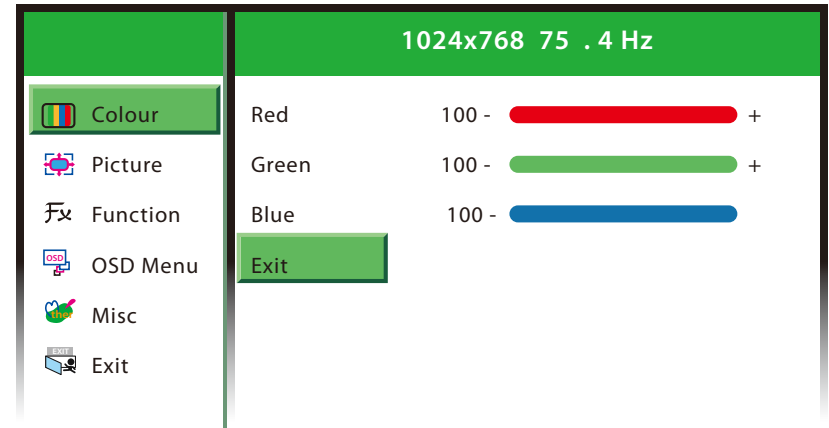
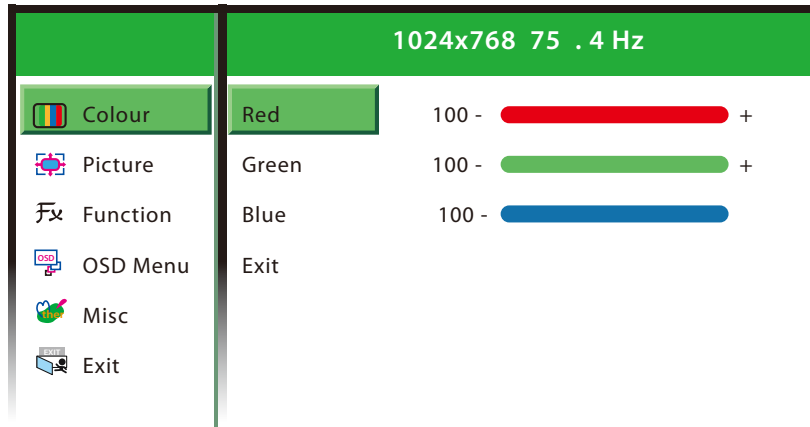

Exit

Exits the Colour sub-menu and return to main menu, or press the  button continuously till exit.

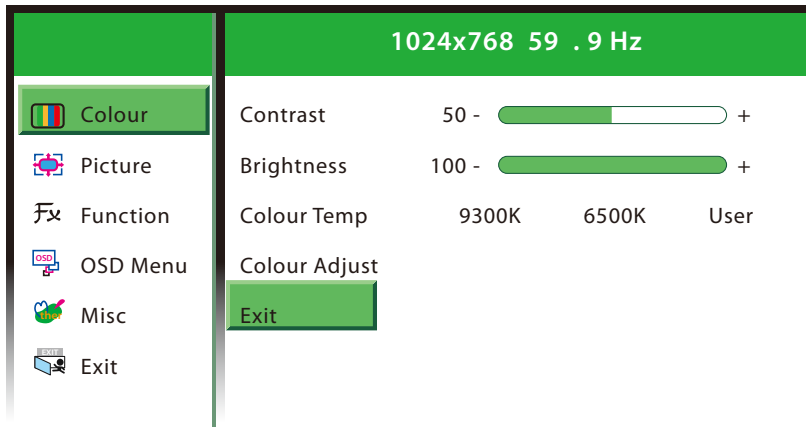

2. Picture

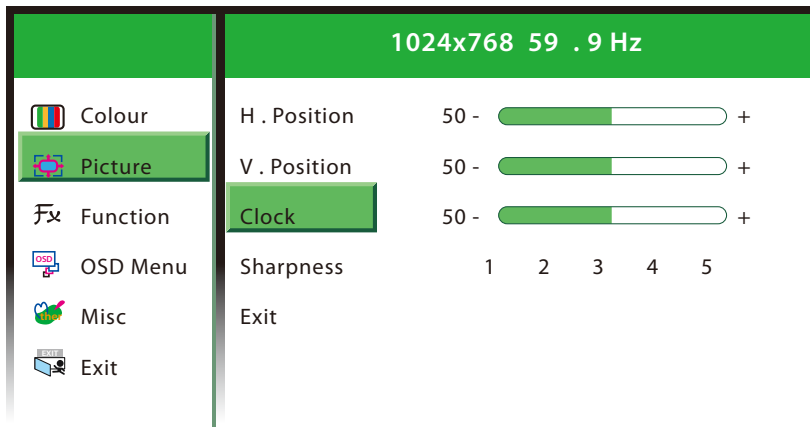

H. Position

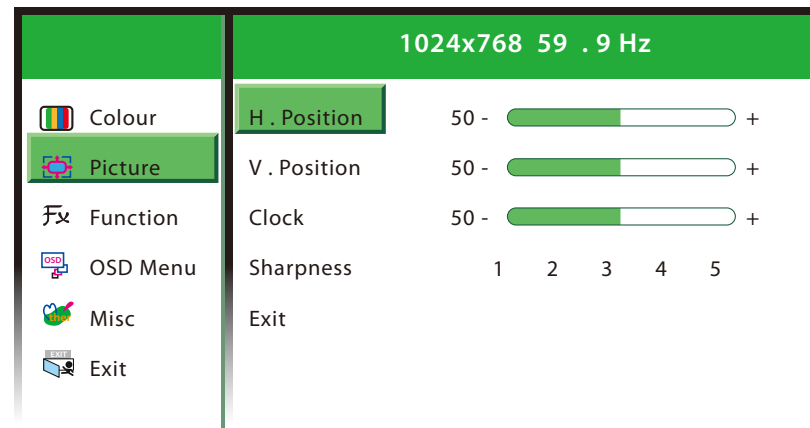
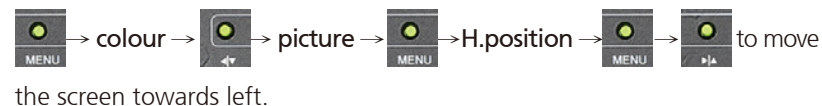
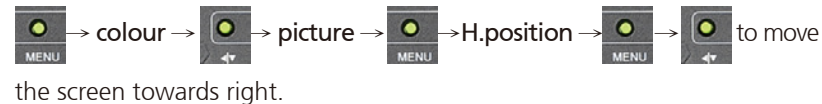

V. Position

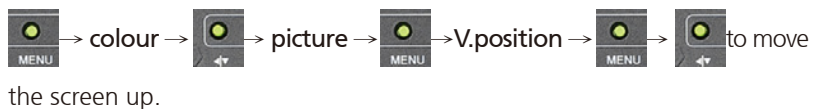
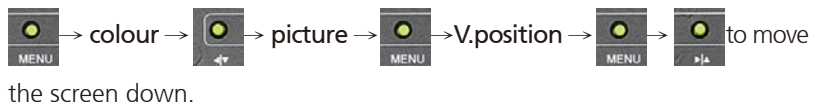

Clock

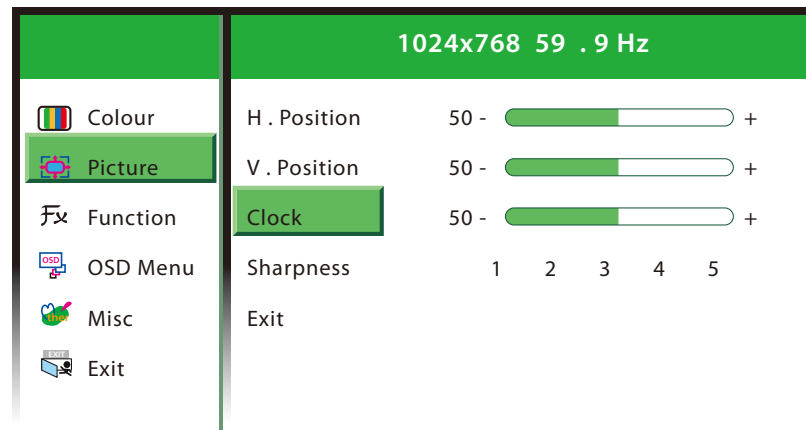
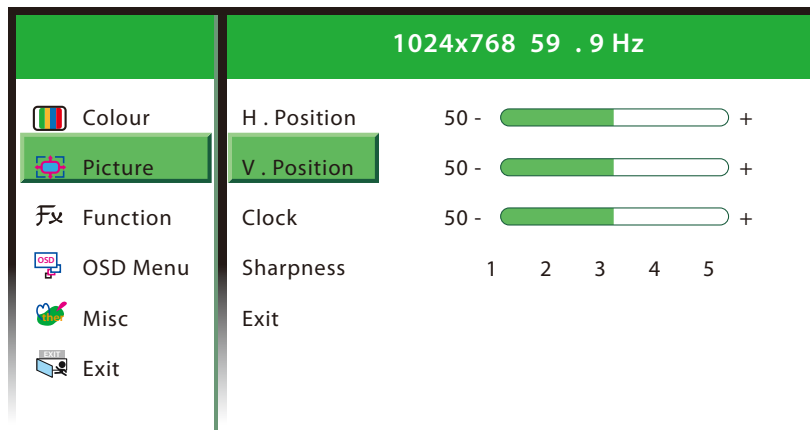

Sharpness



to decrease it.

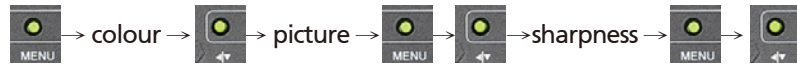

to decrease it.

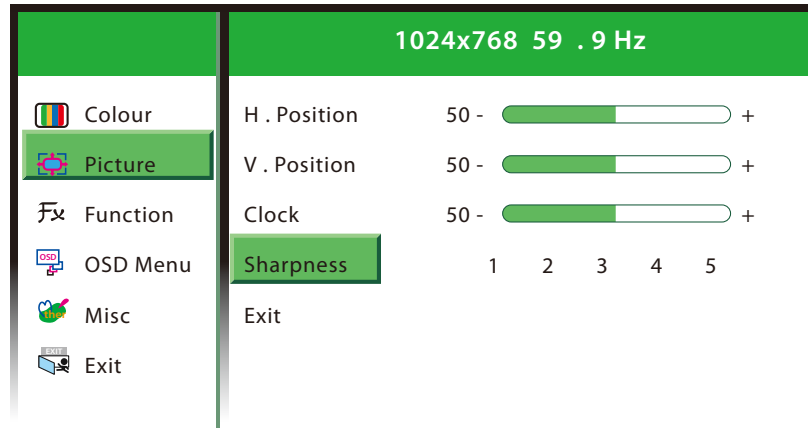

3. Function

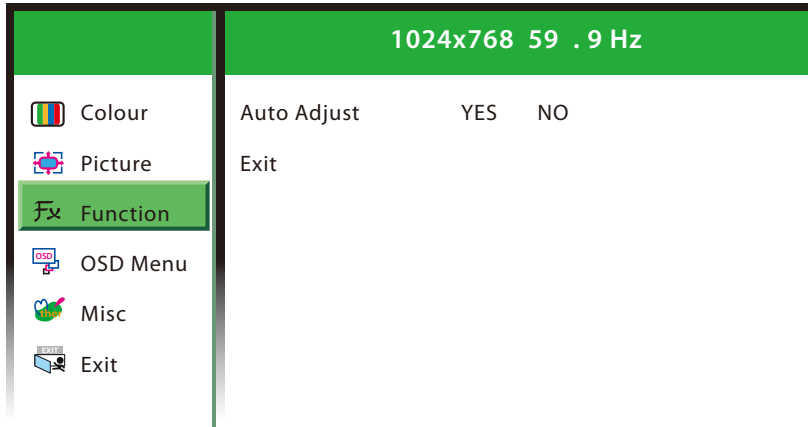

Auto Adjust

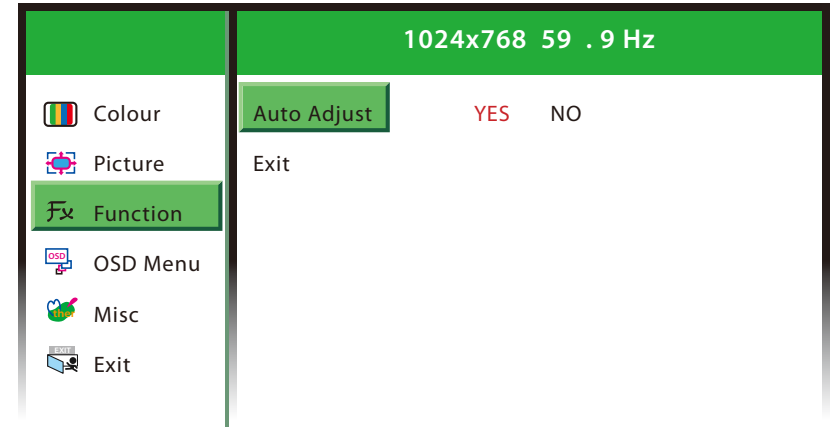
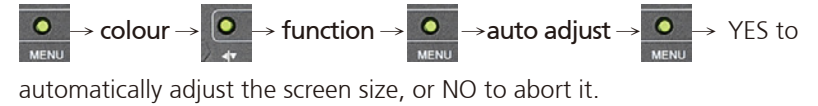

Exit

Exits the Function Adjust sub-menu or press the  button to exit.

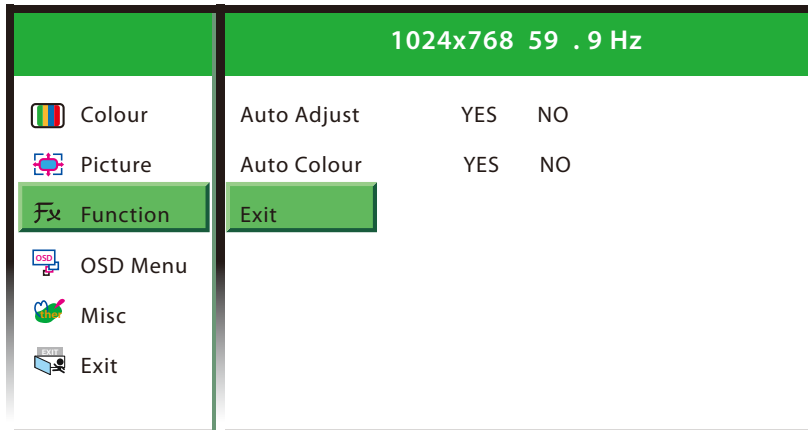
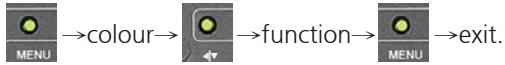

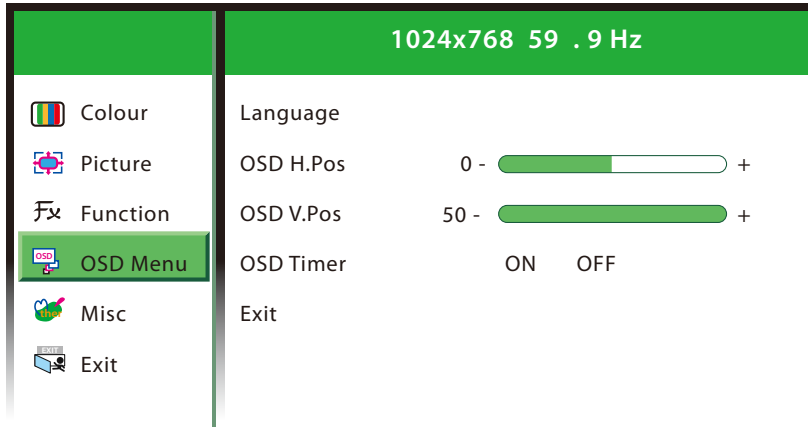

4. OSD Menu

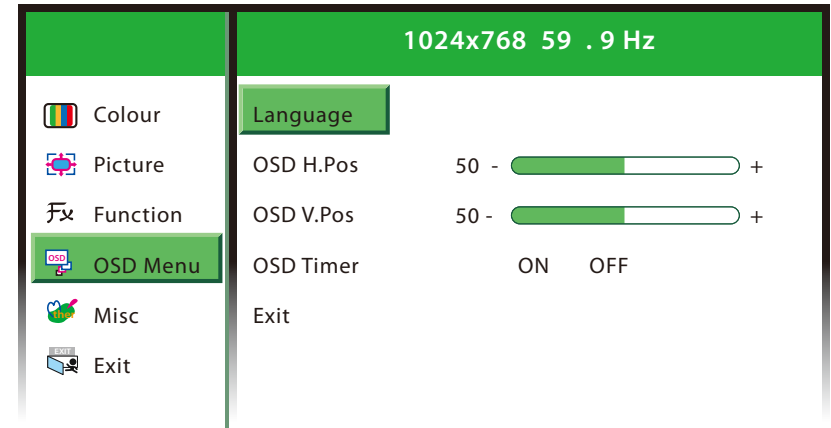

Language

Press the  button to enter the Language sub-menu.



Select the desired language for the OSD menu and press the  button to apply the language.

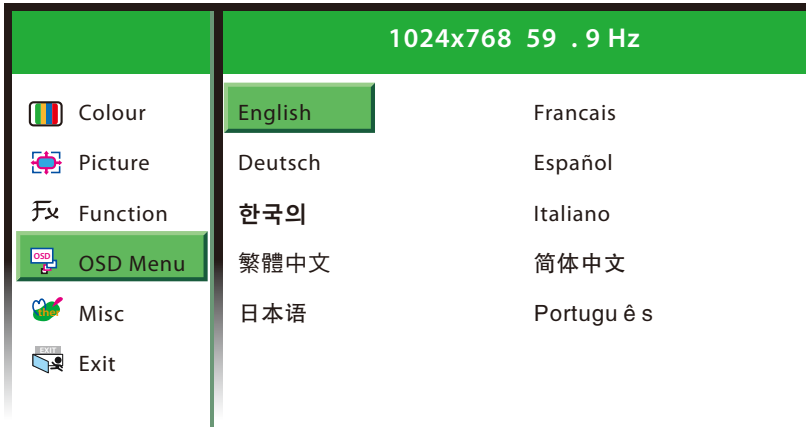

OSD H. Pos

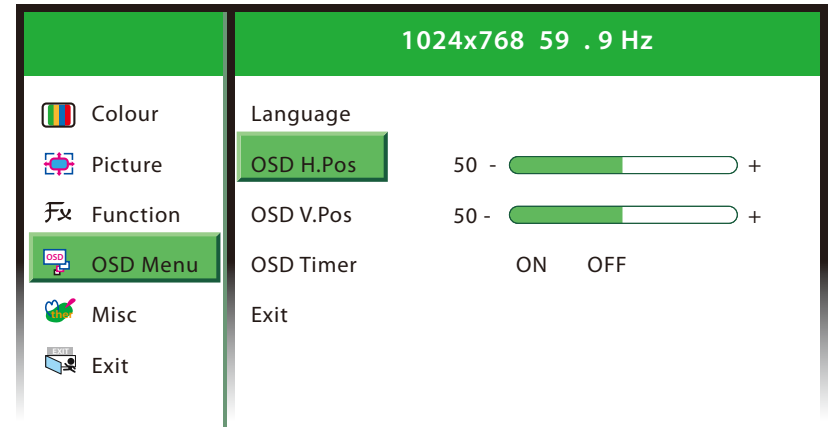
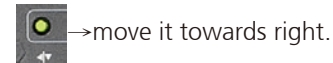
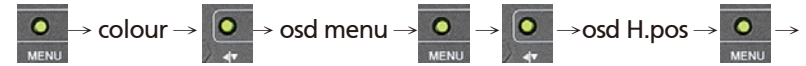
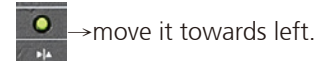
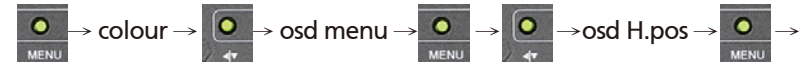

OSD V. Pos

Press ◀|▼ on the back of the display panel to move the OSD menu up, or ▶|▲ to move it down.

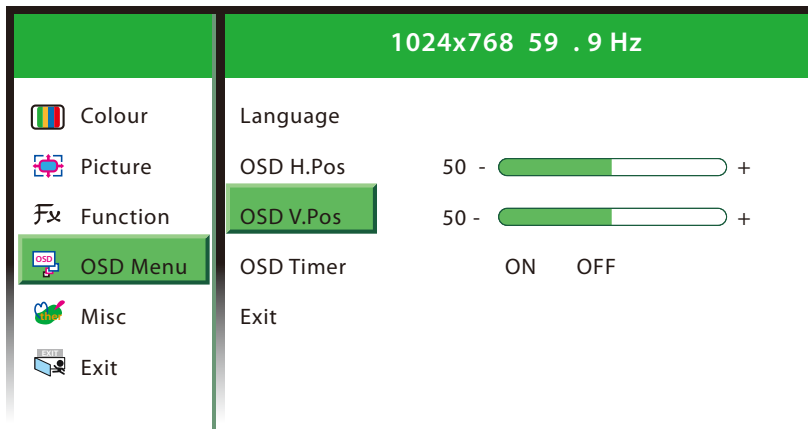
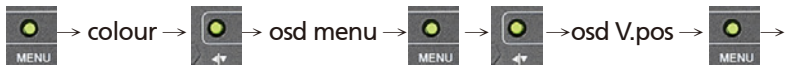
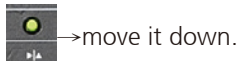

OSD Timer

Select ON to specify the timeout period of the OSD menu, or OFF to disable it. Press ◀|▼ on the back of the display panel to increment the timer by 1 second, or ▶|▲ to decrement the timer by 1 second.

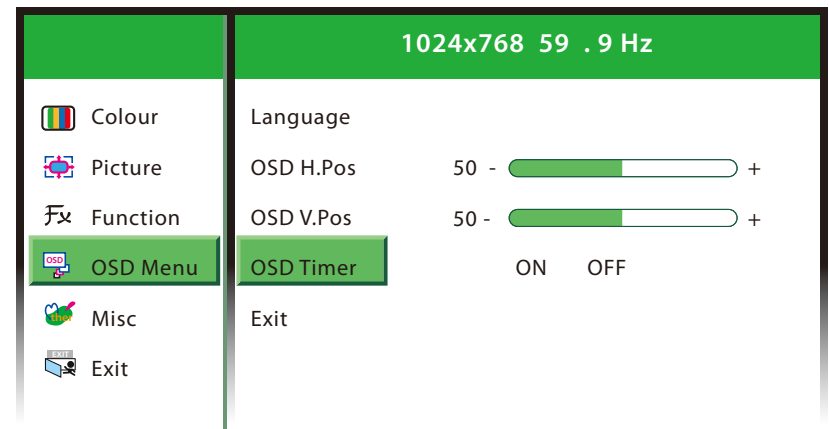

Exit

Exits the OSD Menu sub-menu or press the  button to exit.

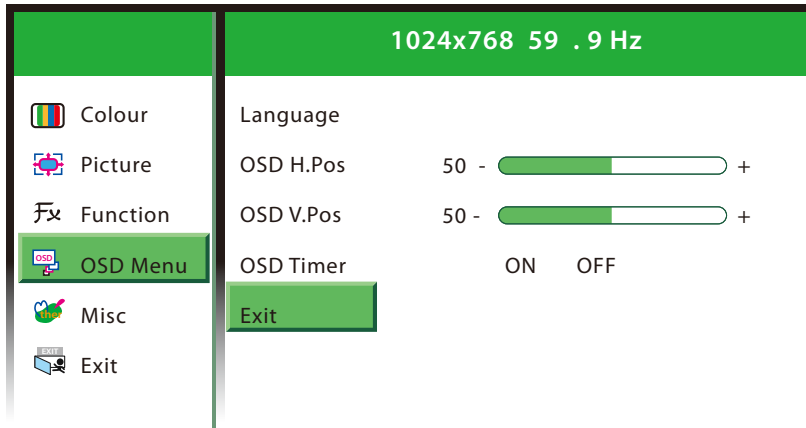

5. Misc

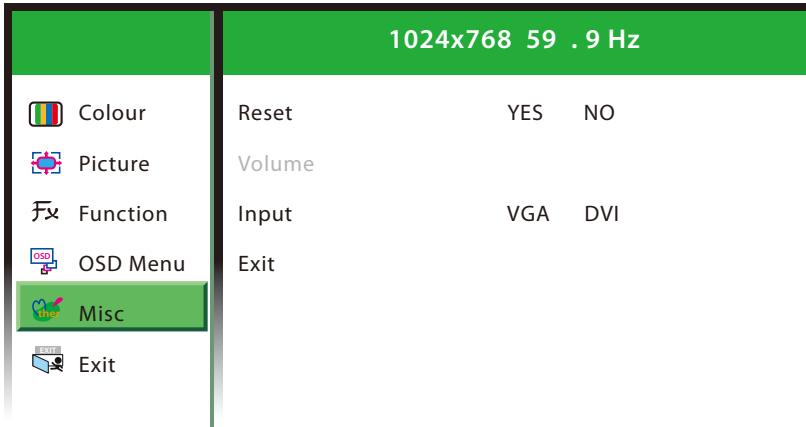

Reset

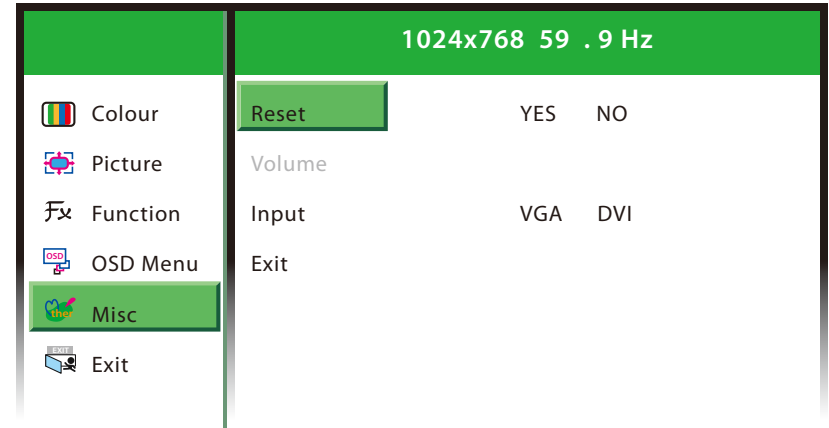
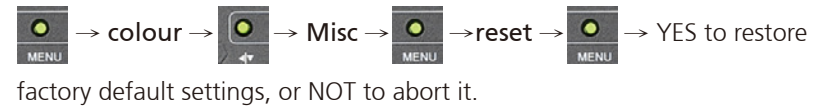

Input



VGA or DVI as the video input.

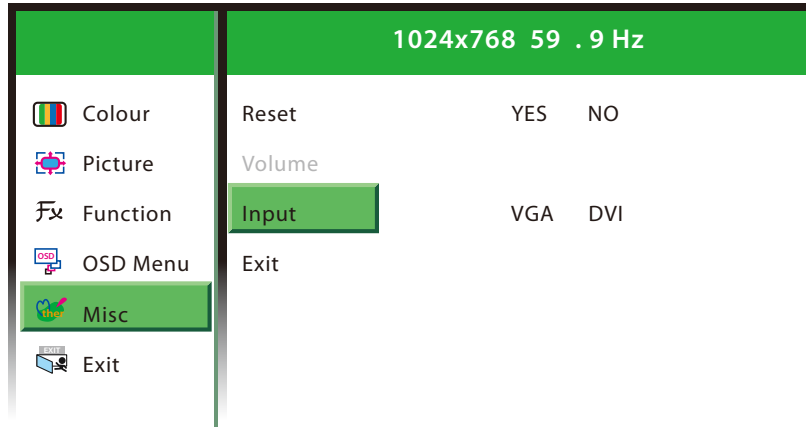

Exit

Exits the Misc sub-menu or press the button to exit.

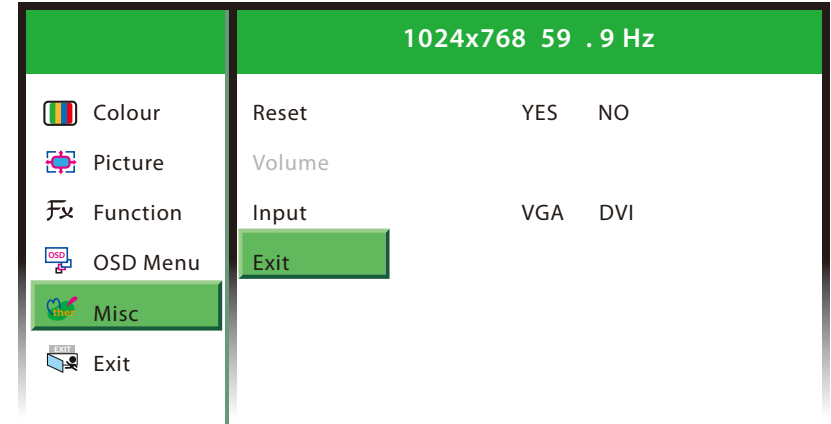

6. Exit

Exits the OSD main menu or press the  button to exit.

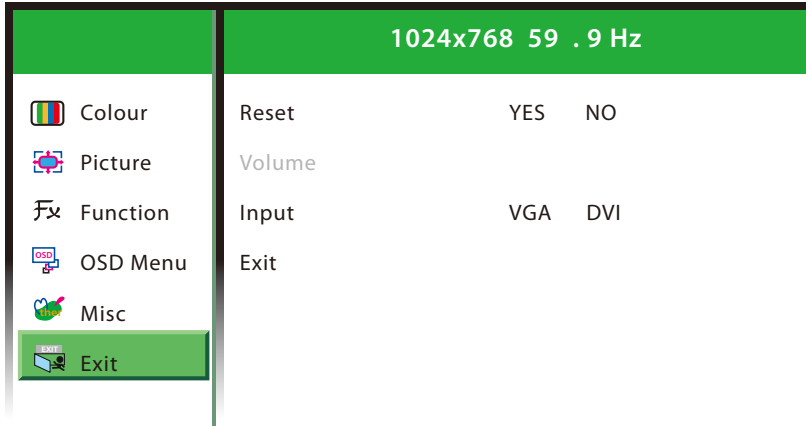

Chapter 5: Touch Driver Settings

Before installing the touch drivers, please adjust the Install.ini file. The Install.ini file is located under the following folder:

\\PenMount Windows Universal Driver V2.2.0.283(Win7_32_64bit_WHQL)\Driver

1. Open the Install.ini file.
2. Confirm if the Install.ini file has the following settings, if not, please change it.

```
[Install]
USB = 1           Must set this to "1"
COM = 1          Must set this to "1"
MMonitor = 1
ENUM = 1
```

```
[Option]
TouchReport = 2   USB/COM
EdgeOffset = 5
Smoothing = 1
```

```
[ENUM]
Total = 4
COM1 = 1         Set "1" to the COM port you intend to use
COM2 = 0
```

```
COM3 = 0
COM4 = 0
```

```
[COM1]
AlwaysExist
```

3. Install the touch drivers.

Appendix A: Power Consumption

Purpose

The purpose of the power consumption test is verified the power dissipation of the system and the load of the power supply.

Test Equipment

PROVA CM-07 AC/DC CLAMP METER
Desktop PC

Device Under Test

DUT: Sys #1

Test Procedure

1. Power up the DUT and then switch on the desktop PC connecting to it.
2. Measure the power consumption and record it.
3. Enter the standby mode (Turn off display).
4. Measure the power consumption and record it.

APPD 1200T

	+12V	+24V
Full-Loading Mode	0.73A	0.39A
Total	8.76W	9.36W
Standby Mode	0.05A	0.06A
Total	0.6W	1.44W

APPD 1205T

	+12V	+24V
Full-Loading Mode	0.75A	0.39A
Total	9W	9.36W
Standby Mode	0.05A	0.05A
Total	0.6W	1.2W

APPD 1500T

	+12V	+24V
Full-Loading Mode	0.97A	0.5A
Total	11.64W	12W
Standby Mode	0.04A	0.05A
Total	0.48W	1.2W

APPD 1700T

	+12V	+24V
Full-Loading Mode	2.6A	1.21A
Total	31.2W	29.04W
Standby Mode	0.05A	0.05A
Total	0.6W	1.2W

APPD 1900T

	+12V	+24V
Full-Loading Mode	1.54A	0.77A
Total	18.48W	18.48W
Standby Mode	0.05A	0.05A
Total	0.6W	1.2W

Appendix B: Extended Display Identification Data Timing Support

APPD 1200T

Resolution	Vertical Frequencies			
	60Hz	70Hz	72Hz	75Hz
640x480	✓		✓	✓
720x400		✓		
800x600	✓		✓	✓

APPD 1205T

Resolution	Vertical Frequencies			
	60Hz	70Hz	72Hz	75Hz
640x480	✓		✓	✓
720x400		✓		
800x600	✓		✓	✓
1024x768	✓	✓		✓

APPD 1500T

Resolution	Vertical Frequencies			
	60Hz	70Hz	72Hz	75Hz
640x480	✓		✓	✓
720x400		✓		
800x600	✓		✓	✓
1024x768	✓	✓		✓

APPD 1700T

Resolution	Vertical Frequencies			
	60Hz	70Hz	72Hz	75Hz
640x480	✓		✓	✓
720x400		✓		
800x600	✓		✓	✓
1024x768	✓	✓		✓
1280x1024	✓			✓

APPD 1900T

Resolution	Vertical Frequencies			
	60Hz	70Hz	72Hz	75Hz
640x480	✓		✓	✓
720x400		✓		
800x600	✓		✓	✓
1024x768	✓	✓		✓
1280x1024	✓			✓