



Rack Mount Display 15~20.1”



User Manual

V1.0

For more information on this
and other Winmate products,
please visit our website at:
www.winmate.com

Document Part Number: 91521110101Y

Please read this instructions before operating the device and retain them for future reference.

CONTENTS

PREFACE	- 3 -
ABOUT THIS USER MANUAL	- 8 -
CHAPTER 1: INTRODUCTION	- 10 -
1.1 Product Features	- 10 -
1.2 Package Contents.....	- 11 -
1.3 Product Overview.....	- 12 -
1.4 OSD Control Panel	- 14 -
1.4.1 Control Buttons	- 14 -
1.4.2 LED Indicators.....	- 14 -
CHAPTER 2: INSTALLATION	- 16 -
2.1 Wiring Requirements	- 16 -
2.2 Mounting Guide.....	- 17 -
2.2.1 Rack Mounting	- 17 -
2.2.2 VESA Mounting.....	- 18 -
2.2 Cable Mounting Considerations	- 19 -
2.3 Connecting Power.....	- 19 -
2.4 Connecting Peripherals.....	- 20 -
2.4.1 VGA Connector	- 20 -
2.4.2 HDMI Connector	- 21 -
2.4.3 DVI Connector.....	- 21 -
2.4.4 S-Video	- 22 -
2.4.5 Composite Video.....	- 22 -
CHAPTER 3: OPERATING THE DEVICE	- 24 -
3.1 Turning on the System.....	- 24 -
3.2 OSD Menu Navigation	- 25 -
CHAPTER 4: TROUBLESHOOTING	- 29 -
4.1 Troubleshooting Guide.....	- 29 -
APPENDIX A: FREQUENCY TABLE	- 31 -

PREFACE

Copyright Notice

No part of this document may be reproduced, copied, translated, or transmitted in any form or by any means, electronic or mechanical, for any purpose, without the prior written permission of the original manufacturer.

Trademark Acknowledgement

Brand and product names are trademarks or registered trademarks of their respective owners.

Disclaimer

We reserve the right to make changes, without notice, to any product, including circuits and/or software described or contained in this manual in order to improve design and/or performance. We assume no responsibility or liability for the use of the described product(s) conveys no license or title under any patent, copyright, or masks work rights to these products, and make no representations or warranties that these products are free from patent, copyright, or mask work right infringement, unless otherwise specified. Applications that are described in this manual are for illustration purposes only. We make no representation or guarantee that such application will be suitable for the specified use without further testing or modification.

Warranty

Our warranty guarantees that each of its products will be free from material and workmanship defects for a period of one year from the invoice date. If the customer discovers a defect, we will, at his/her option, repair or replace the defective product at no charge to the customer, provide it is returned during the warranty period of one year, with transportation charges prepaid. The returned product must be properly packaged in its original packaging to obtain warranty service. If the serial number and the product shipping data differ by over 30 days, the in-warranty service will be made according to the shipping date. In the serial numbers the third and fourth two digits give the year of manufacture, and the fifth digit means the month (e. g., with A for October, B for November and C for December).

For example, the serial number 1W16Axxxxxxx means October of year 2016.

Customer Service

We provide a service guide for any problem by the following steps: First, visit the website of our distributor to find the update information about the product. Second, contact with your distributor, sales representative, or our customer service center for technical support if you need additional assistance.

You may need the following information ready before you call:

- Product serial number
- Software (OS, version, application software, etc.)
- Description of complete problem
- The exact wording of any error messages

In addition, free technical support is available from our engineers every business day. We are always ready to give advice on application requirements or specific information on the installation and operation of any of our products.

Naming Rule

R19LXXX-RMXX

Item	Description
R	Panel Type
19	Panel Size
LXXX	Product Size
RM	Mechanical Type(Rack Mount)
XX	Panel Model

Advisory Conventions

Four types of advisories are used throughout the user manual to provide helpful information or to alert you to the potential for hardware damage or personal injury. These are Notes, Important, Cautions, and Warnings. The following is an example of each type of advisory.

**NOTE:**

A note is used to emphasize helpful information

**IMPORTANT:**

An important note indicates information that is important for you to know.

**CAUTION/ ATTENTION**

A Caution alert indicates potential damage to hardware and explains how to avoid the potential problem.

Un avertissement d'attention indique un dommage possible à l'équipement et explique comment éviter le problème potentiel.

**WARNING!/AVERTISSEMENT!**

An Electrical Shock Warning indicates the potential harm from electrical hazards and how to avoid the potential problem.

Un avertissement de choc électrique indique le potentiel de choc sur des emplacements électriques et comment éviter ces problèmes.

**ALTERNATING CURRENT / MISE À LE TERRE!**

The Protective Conductor Terminal (Earth Ground) symbol indicates the potential risk of serious electrical shock due to improper grounding.

Le symbole de Mise à Terre indique le risque potentiel de choc électrique grave à la terre incorrecte.

Safety Information

WARNING! / AVERTISSEMENT!



Always completely disconnect the power cord from your chassis whenever you work with the hardware. Do not make connections while the power is on. Sensitive electronic components can be damaged by sudden power surges. Only experienced electronics personnel should open the PC chassis.

Toujours débrancher le cordon d'alimentation du chassis lorsque vous travaillez sur celui-ci. Ne pas brancher de connexions lorsque l'alimentation est présente. Des composants électroniques sensibles peuvent être endommagés par des sauts d'alimentation. Seulement du personnel expérimenté devrait ouvrir ces chassis.

CAUTION/ATTENTION



Always ground yourself to remove any static charge before touching the CPU card. Modern electronic devices are very sensitive to static electric charges. As a safety precaution, use a grounding wrist strap at all times. Place all electronic components in a static-dissipative surface or static-shielded bag when they are not in the chassis.

Toujours vérifier votre mise à la terre afin d'éliminer toute charge statique avant de toucher la carte CPU. Les équipements électroniques modernes sont très sensibles aux décharges d'électricité statique. Toujours utiliser un bracelet de mise à la terre comme précaution. Placer toutes les composantes électroniques sur une surface conçue pour dissiper les charge, ou dans un sac anti-statique lorsqu'elles ne sont pas dans le chassis.

Safety Precautions

For your safety carefully read all the safety instructions before using the device. Keep this user manual for future reference.

- Always disconnect this equipment from any AC outlet before cleaning. Do not use liquid or spray detergents for cleaning. Use a damp cloth.
- For pluggable equipment, the power outlet must be installed near the equipment and must be easily accessible.
- Keep this equipment away from humidity.
- Put this equipment on a reliable surface during installation. Dropping it or letting it fall could cause damage.
- The openings on the enclosure are for air convection and to protect the equipment from overheating.



CAUTION/ATTENTION

Do not cover the openings!

- Before connecting the equipment to the power outlet make sure the voltage of the power source is correct.
- Position the power cord so that people cannot step on it. Do not place anything over the power cord.
- If the equipment is not used for a long time, disconnect it from the power source to avoid damage by transient over-voltage.
- Never pour any liquid into an opening. This could cause fire or electrical shock.
- Never open the equipment. For safety reasons, only qualified service personnel should open the equipment.
- All cautions and warnings on the equipment should be noted.



CAUTION

Always ground yourself to remove any static charge before touching the board. Modern electronic devices are very sensitive to static electric charges. As a safety precaution, use a grounding wrist strap at all times. Place all electronic components in a static-dissipative surface or static-shielded bag when they are not in the chassis.

ABOUT THIS USER MANUAL

This User Manual provides information about using the Winmate® Rack Mount Display. The documentation set provides information for specific user needs, and includes:

- **Rack Mount Display User Manual** – contains detailed description on how to use the display, its components and features.



NOTE:

Some pictures in this guide are samples and can differ from actual product.

Document Revision History

Version	Date	Note
1.0	22-Nov-2017	New document release

INTRODUCTION

This chapter gives you product overview, describes features and hardware specification. You will find all accessories that come with the display device in the packing list. Mechanical dimensions and drawings included in this chapter.



CHAPTER 1: INTRODUCTION

Congratulations on purchasing Winmate® Rack Mount Display. Versatile display in an open-frame housing designed for rear and VESA mounting with integrated bracket design for KIOSK applications.

The Winmate Rack Mount Display is a microprocessor-controlled to work with 15~20.1" TFT LCD panel. It is designed to meet the demanding performance requirements of today's business and industrial applications.

1.1 Product Features



Winmate® Rack Mount Display features:

- 15~20.1" TFT LCD
- 1x HDMI, 1x VGA (Standard)
- 1 x DVI, 1 x S-Video, 1 x Composite (Optional)
- Rack Mount design
- Sleek and flush mounts
- Suitable for industrial applications

1.2 Package Contents

Carefully remove the box and unpack your display. Please check if all the items listed below are inside your package. If any of these items are missing or damaged contact us immediately.

Standard factory shipment list:

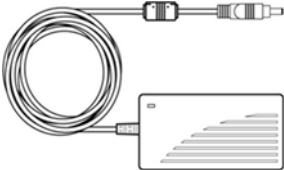
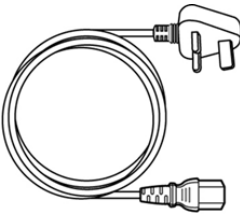
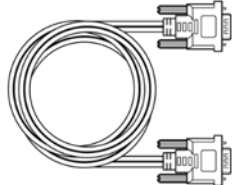
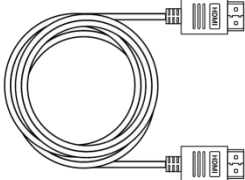
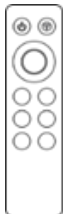
		
Display	User Manual (Hardcopy)	Black screw bolts**
Varies by product	91521110101Y	Varies by product
		
110~240V AC Power Adapter	Power Cord	VGA Cable (D-SUB 15pin Male to 15pin Male)
Varies by product	Varies by country	9441151150P4
		
HDMI Cable (HDMI 19pin Male to 19pin Male)	Remote Control (Optional)	
94E0190190P3	9B0000000418	

****Notice:** Screw bolts provided by Winmate only to be used to screw the display onto a console from the rear side. If you prefer your own bolts, please make sure to use M4 and 30mm in length.

1.3 Product Overview

This section describes physical appearance of the Rack Mount Display.



NOTE:

Notice that standard input terminals include VGA and HDMI. Your device may be equipped with DVI, S-Video or Composite input terminals based on your order.

Notice that input and output connectors vary by product size and specifications. The picture above shows only a prototype model for information purposes only.

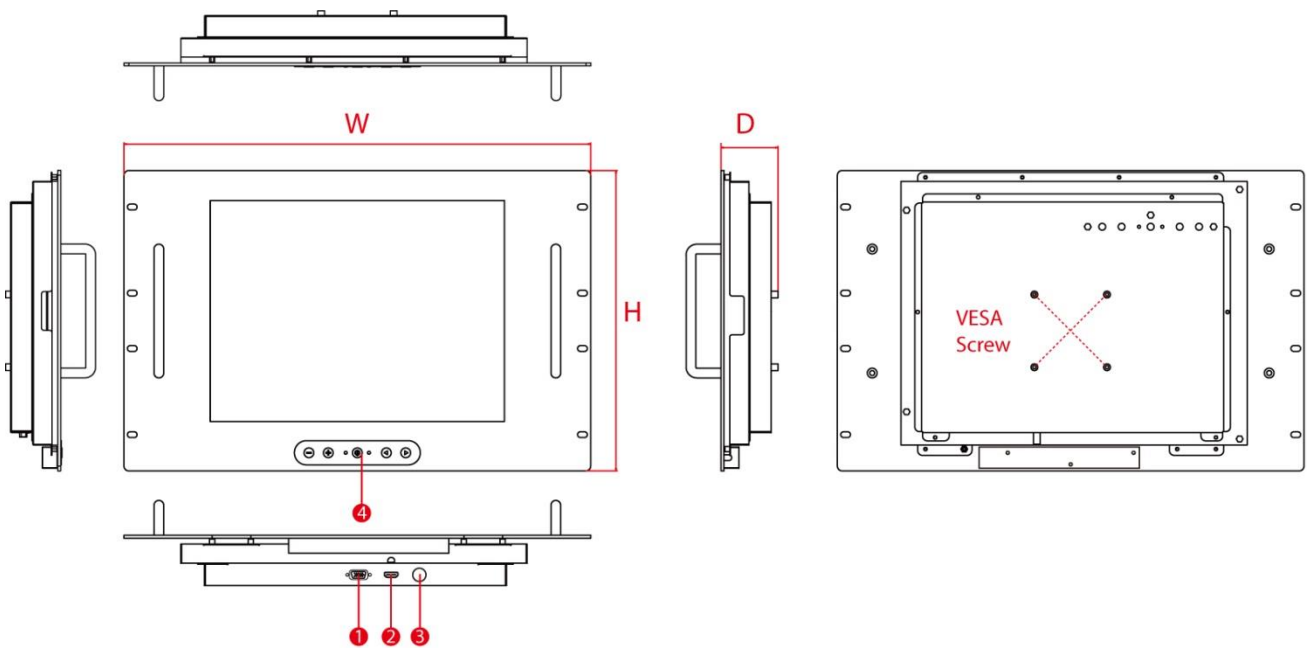

No	Description	No	Description
①	VGA	③	DC-in
②	HDMI	④	OSD Control Panel*

* The location of OSD Panel may vary by model.

**The location and mechanical drawing varies by model.

Refer to the table below for a unit dimensions.

Model Name	Dimensions (W x H x D, mm)	VESA (W x H, mm)
R15L100-RKA1	482x310x58.8	75 x 75
R15L600-RMC3	482x310x56.8	75 x 75
R17L500-RKM1	482x399x64	100 x 100, 75 x75
R19L300-RKM1	482x399x70	100 x 100, 75 x 75
R19L300-RKM2	482x399x64	100 x 100, 75 x 75
R20L100-RKA2	482x399x69	100 x 100, 75 x 75

1.4 OSD Control Panel

1.4.1 Control Buttons

OSD control panel varies by product specifications.

Type A

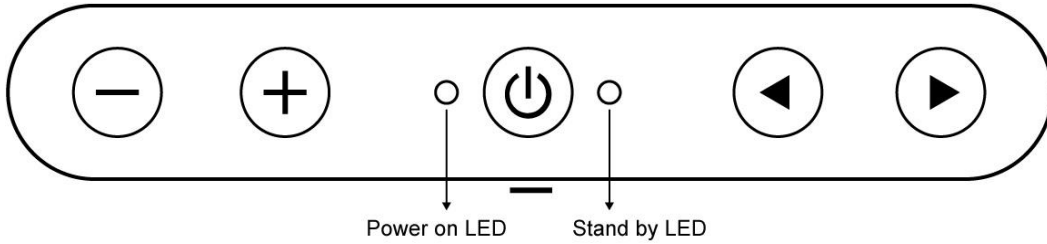

Icon	Function
	Decrease the value / Select up
	Increase the value / Select down
	Power switch
	Select left
	Select right / Call main OSD menu

1.4.2 LED Indicators

LED indicators are located on the OSD control panel the rear side of the display.

Icon	Description	Function
	Power Indicator	Lights up in "Green" when the monitor turn on
	Stand by Indicator	Lights up in "Orange" when the device cannot detect any input source

INSTALLATION

This chapter provides hardware installation instructions and mounting guide for all available mounting options. Pay attention to cautions and warning to avoid any damages.



CHAPTER 2: INSTALLATION

This chapter provides hardware installation instructions and mounting guide for all available mounting options. Pay attention to cautions and warning to avoid any damages

2.1 Wiring Requirements

The following common safety precautions should be observed before installing any electronic device:

- Strive to use separate, non-intersecting paths to route power and networking wires. If power wiring and device wiring paths must cross make sure the wires are perpendicular at the intersection point.
- Keep the wires separated according to interface. The rule of thumb is that wiring that shares similar electrical characteristics may be bundled together.
- Do not bundle input wiring with output wiring. Keep them separate.
- When necessary, it is strongly advised that you label wiring to all devices in the system.



CAUTION

- Do not run signal or communication wiring and power wiring in the same conduit. To avoid interference, wires with different signal characteristics (i.e., different interfaces) should be routed separately.
- Be sure to disconnect the power cord before installing and/or wiring your device.
- Verify the maximum possible current for each wire gauge, especially for the power cords. Observe all electrical codes dictating the maximum current allowable for each wire gauge.
- If the current goes above the maximum ratings, the wiring could overheat, causing serious damage to your equipment.

Be careful when handling the unit. When the unit is plugged in, the internal components generate a lot of heat which may leave the outer casing too hot to touch.

2.2 Mounting Guide

The Rack Mount Display can be applied for several different installation methods, including panel mounting, bracket mounting, VESA mounting. Refer to sub-sections below for more details.



CAUTION/ ATTENTION

Follow mounting instructions and use recommended mounting hardware to avoid the risk of injury.

Suivez les instructions de montage et d'utilisation recommandé le matériel de montage pour éviter le risque de blessure.

2.2.1 Rack Mounting

The Rack Mount Display comes with clamp mounts that enable you to install the unit onto a wall (where space has been cut out to accommodate the rest of the hardware). Winmate provides VESA and Wall Mount Kits by request.

Installation Instruction

1. Make a cutout on the fixture (ex. wall) according to the cutout dimensions of the display.
2. Based on the drawing, mark screw holes on a front side of the fixture. Place display on the fixture from the rear side. Use electric screwdriver to fasten M3 screws from the front side.
3. You complete the installation. Please connect all the peripherals if needed.

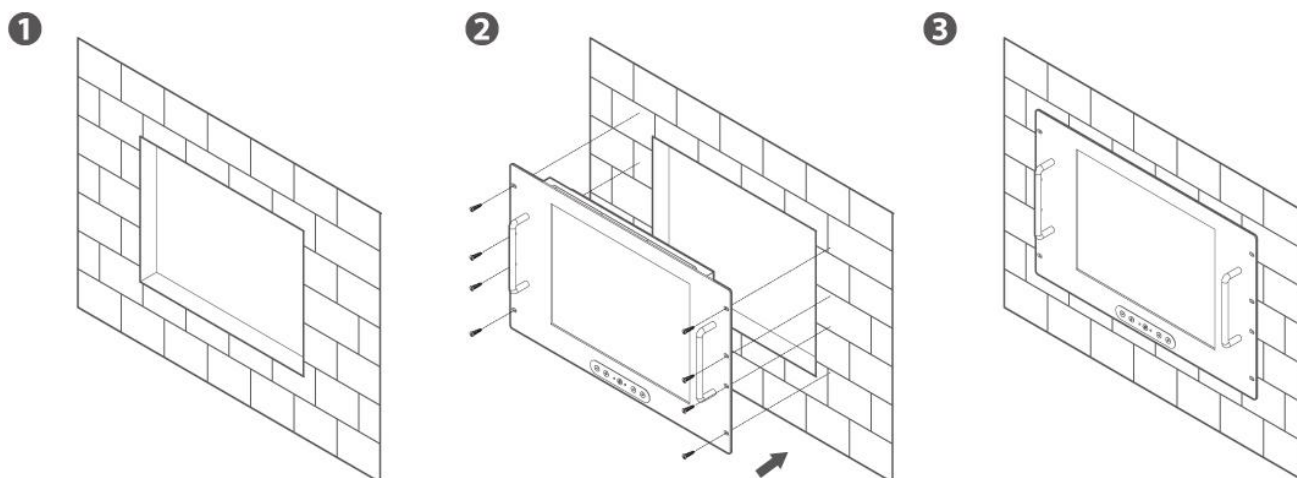

2.2.2 VESA Mounting

Rack Mount Display comes with VESA Mount holes for mounting.

Installation Instruction:

1. Screw VESA bracket to the fixture (ex. swing arm) with four VESA screws.
2. Place the device on VESA bracket.

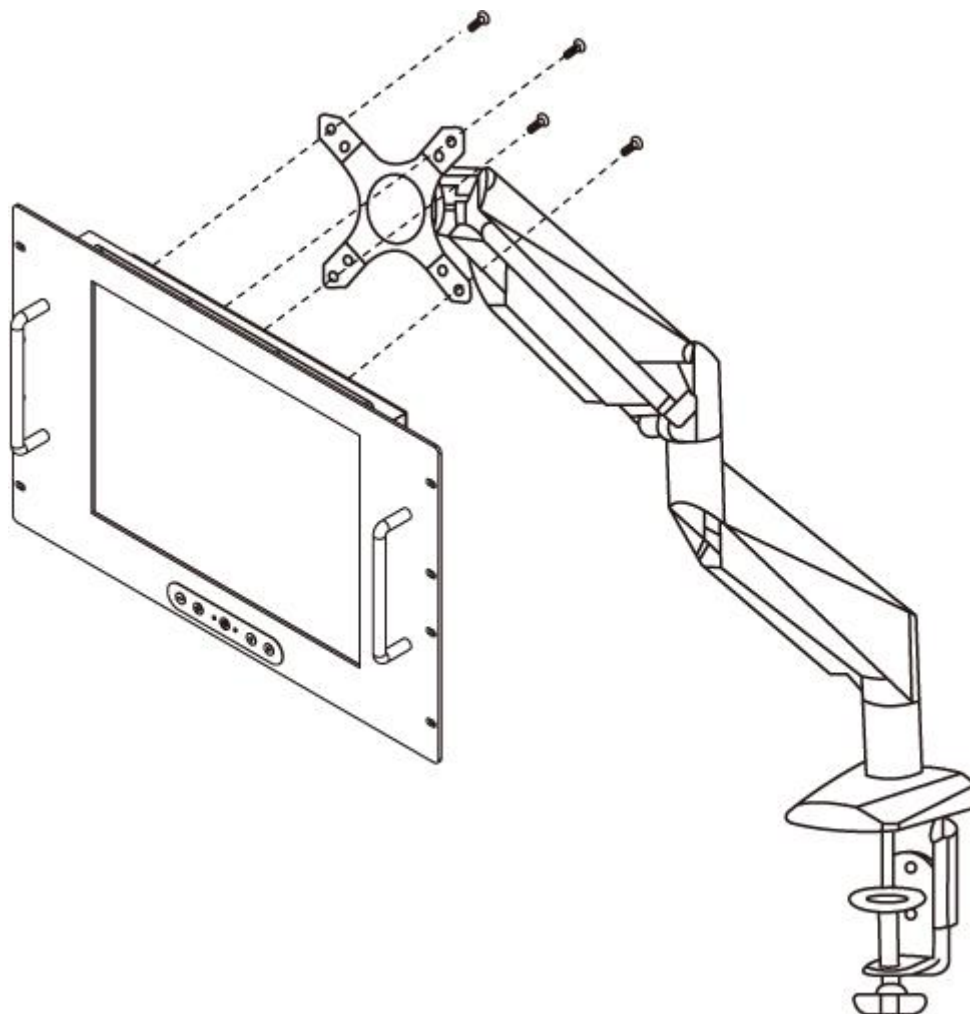

Notice that VESA stand and mounting kit are not provided by Winmate.

2.2 Cable Mounting Considerations

For a nice look and safe installation, make sure cables are neatly hidden behind the device.



CAUTION/ ATTENTION

Observe all local installation requirements for connection cable type and protection level.

Suivre tous les règlements locaux d'installations, de câblage et niveaux de protection.



CAUTION/ ATTENTION

Turn off the device and disconnect other peripherals before installation.

Éteindre l'appareil et débrancher tous les périphériques avant l'installation.

2.3 Connecting Power

This section provides information on how to use connectors on the Rack Mount Display. Be cautious while working with these modules. Please carefully read the content of this chapter in order to avoid any damages.

Installation instruction:

1. Connect the AC cord to the AC IN terminal on the AC adaptor.
2. Connect the DC OUT terminal of the AC adaptor to the DC IN terminal on the monitor.
3. Align the notch on the cord connector with the guiding groove and plug it in.
4. Connect the AC cord plug to the power outlet.

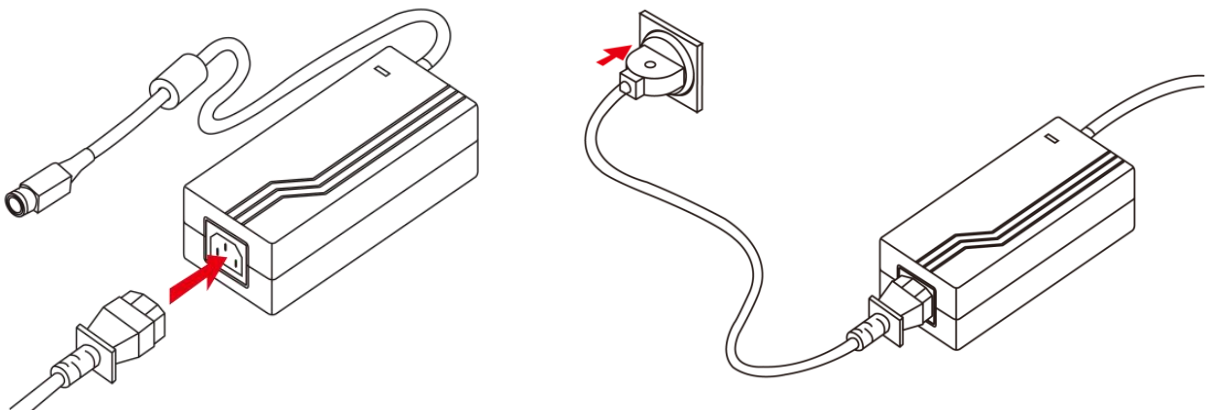

2.4 Connecting Peripherals

The panel control port is designed for monitors that work with a variety of compatible video sources. Due to the possible deviations between these signal sources, you may have to make adjustments to the monitor settings from the OSD menu when switching between these sources.



NOTE:

Notice that standard input terminals include VGA and HDMI. Your device may be equipped with DVI-D, S-Video or Composite input terminals based on your order.

2.4.1 VGA Connector

Rack Mount Display uses standard 15pin D-sub connector. Plug 15-pin VGA signal cable to the VGA connector in the rear of motherboard, and plug the other end to the monitor. Secure cable connectors with hexagonal copper pillars M3x4mm.

Pin Assignment and signal names for VGA connector

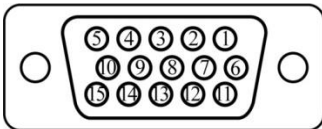

Pin №	Signal Name	Pin №	Signal Name
1	RED	2	GREEN
3	BLUE	4	NC
5	GND	6	AGND
7	AGND	8	AGND
9	VGA_5V	10	GND
11	NC	12	DDCSDA
13	H Sync	14	V Sync
15	DDCSCL		

2.4.2 HDMI Connector

Plug HDMI signal cable to the HDMI connector on the rear side of PC system, and plug the other end to the monitor.

Pin Assignment and signal names for HDMI connector



Pin №	Signal Name	Pin №	Signal Name
1	HDMI_RX2+	2	GND
3	HDMI_RX2-	4	HDMI_RX1+
5	GND	6	HDMI_RX1-
7	HDMI_RX0+	8	GND
9	HDMI_RX0-	10	HDMI_RXC+
11	GND	12	HDMI_RXC-
13	HDMI_CON_CEC	14	NC
15	HDMI_CON_SCL	16	HDMI_CON_SDA
17	GND	18	+5V_HDMI
19	HDMI_CON_HP		

2.4.3 DVI Connector

Notice that DVI is an optional connector and may not be present in your device.

Use DVI to connector in the rear of PC system, and plug the other end to the TFT LCD display. Fasten cable connectors with screws.

Pin Assignment and signal names for DVI connector



Pin №	Signal Name	Pin №	Signal Name
1	DVI_RX2-	2	DVI_RX2+
3	GND	4	4-
5	4+	6	DVI_SCL
7	DVI_SDA	8	NC
9	DVI_RX1-	10	DVI_RX1+
11	GND	12	3-
13	3+	14	+5V
15	DVI_CON_CABLE	16	DVI_CON_HP
17	DVI_RX0-	18	DVI_RX0+
19	GND	20	5-
21	5+	22	GND
23	DVI_CLKP	24	DVI_CLKN
C1	NC	C2	NC
C3	NC	C4	NC
C5	NC		

2.4.4 S-Video

Notice that S-Video is an optional connector and may not be present in your device.

Use Mini-DIN connector to connect S-Video to the display.

Pin Assignment and signal names for S-Video connector

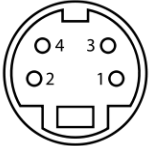

Pin №	Signal Name	Pin №	Signal Name
1	GND	2	GND
3	Y	4	C

2.4.5 Composite Video

Notice that Composite video is an optional connector and may not be present in your device.

Use composite video cable to connect composite video input.

Pin Assignment and signal names for Composite Video connector

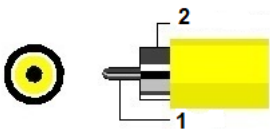

Pin №	Signal Name	Pin №	Signal Name
1	Composite Video Signal	2	GND

OPERATING THE DEVICE

This chapter provides detailed information on how to operate the display.



CHAPTER 3: OPERATING THE DEVICE

In this chapter you will find instructions on how to operate the display.





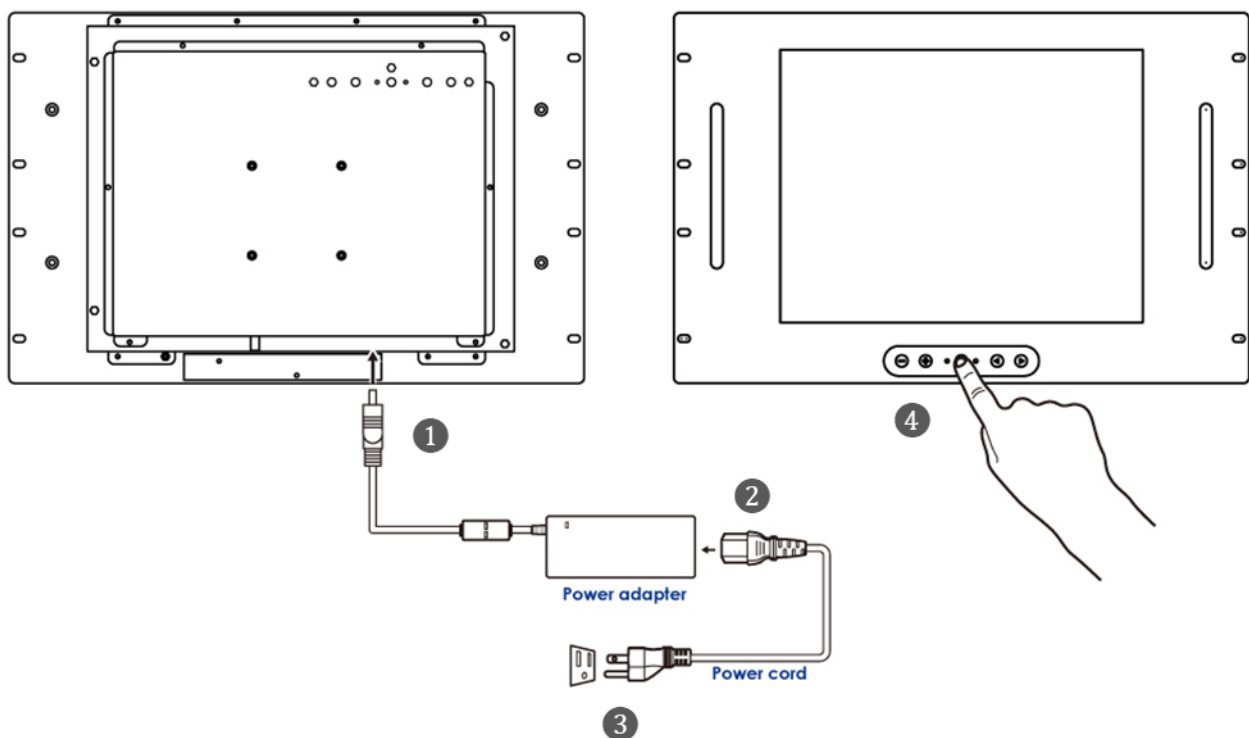

3.1 Turning on the System

To turn on the system:

1. Connect the power adapter cable to the DC IN of the display.
2. Connect the power cord to the power adapter.
3. Connect the power cord to a power outlet.
4. Press the power button located on the OSD control panel on the rear to turn on the system.



3.2 OSD Menu Navigation

	BRICONTRAST	BRIGHTNESS CONTRAST
	POSITION	Only support VGA mode H position V position
	IMAGE	Only support VGA mode Auto Adjustment Clock Phase White Balance
	COLOR	USER 9300K 6500K ADC RIGHTNESS
OP	OPTION	VR Brightness Volume Speaker
XII	GAMMA	GAMMA0 GAMMA1 GAMMA2
	CHANNEL	AUTO Scan ANALOG HDMI
	RECALL	YES NO
	OSD EXIT	YES NO

BRICONTRAST

OSD Icon	Sub-menu	Settings	Note
 BRICONTRAST	BRIGHTNESS	slider bar	Default 50
	Use to adjust the screen's brightness. Range 0 to 100		
	CONTRAST	slider bar	Default 50
	Use to adjust the screen's contrast. Range 0 to 100		

POSITION (VGA mode only)



OSD Icon	Sub-menu	Settings	Note
 POSITION	H POSITION	slider bar	Default 50
	Use to adjust the image to the left or right on the screen. Range 0 to 100		
	V POSITION	slider bar	Default 50
	Use to adjust the image up or down on the screen. Range 0 to 100		

IMAGE (VGA mode only)

OSD Icon	Sub-menu	Settings	Note
 IMAGE	AUTO	Select and execute	
	Use to choose the best settings for the current input signal		
	CLOCK	slider bar	Default 50
	Use to adjust the value of horizontal image. Range 0 to 100		
	PAHSE	slider bar	Default 50
	Use to adjust the phase control (Phase adjustment may be required to optimize the display quality)		
	WHITE BALANCE	Select and execute	
Use to set RGB signal voltage level			

COLOR

OSD Icon	Sub-menu	Settings	Note
 COLOR	USER	R.G.B slider bar	
	Choose RED/GREEN/BLUE to set value of color temperature brightness to suit your own preference		
	9300K	Select and execute	
	Use to set value of monitor for the CIE coordinate 9300 color temperature		
	6500K	Select and execute	
	Use to set value of monitor for the CIE coordinate 6500 color temperature		
	ADC RIGHTNESS	slider bar	Default 50
Set value of monitor for ADC Brightness. Range 0 to 100			

GAMMA

OSD Icon	Sub-menu	Settings	Note
	GAMMA 0	Select and execute	Default GAMMA0
	Choose the parameter of GAMMA 0 as default setting.		
	GAMMA 1	Select and execute	
	Choose the parameter of GAMMA 1 as default setting.		
	GAMMA 2	Select and execute	
Choose the parameter of GAMMA 2 as default setting.			

OPTION

OSD Icon	Sub-menu	Settings	Note
	VR Brightness	ON/OFF	Default OFF
	Choose the brightness control mode by VR control		
	Volume	slider bar	Default 10
	Use to set value of Volume		
	Speaker	ON/OFF	Default OFF
Use to set value of Volume Speaker			

CHANNEL

OSD Icon	Sub-menu	Settings	Note
	AUTO SCAN	Select and execute	Default mode
	Auto detect the input source		
	ANALOG	Select and execute	
	Switch the setting of signal input to Analog mode		
	HDMI	Select and execute	
Switch the setting of signal input to HDMI mode			

RECALL

OSD Icon	Sub-menu	Settings	Note
	YES	Select and execute	
	Recall the factory default setting		
	NO	Select and execute	
	Return to main menu		

EXIT

OSD Icon	Sub-menu	Settings	Note
	YES	Select and execute	
	Exit the OSD menu		
	NO	Select and execute	
	Return to main menu		

TROUBLESHOOTING

This chapter contains troubleshooting information. Check this guide before calling for repairs.



CHAPTER 4: TROUBLESHOOTING

This chapter contains troubleshooting information. Check this guide before calling for repairs.

4.1 Troubleshooting Guide

If your monitor fails to operate correctly, check the following chart for possible solution before calling for repairs:

Condition	Check Point
The picture does not appear	<ul style="list-style-type: none"> • Check if the signal cable is firmly seated in the socket. • Check if the Power is ON at the computer • Check if the brightness control is at the appropriate position, not at the minimum.
The screen is not synchronized	<ul style="list-style-type: none"> • Check if the signal cable is firmly seated in the socket. • Check if the output level matches the input level of your computer. • Make sure the signal timings of the computer system are within the specification of the monitor. • If your computer was working with a CRT monitor, you should check the current signal timing and turn off your computer before you connect the VGA Cable to this monitor.
The position of the screen is not in the center	<ul style="list-style-type: none"> • Adjust the H-position, and V-position, or Perform the Auto adjustment.
The screen is too bright (too dark)	<ul style="list-style-type: none"> • Check if the brightness or contrast control is at the appropriate position, not at the Maximum (Minimum).
The screen is shaking or waving	<ul style="list-style-type: none"> • Perform the Auto adjustment. • Moving all objects which emit a magnetic field such as motor or transformer, away from the monitor. • Check if the specific voltage is applied. • Check if the signal timing of the computer system is within the specification of monitor.

**If you are unable to correct the fault by using this chart, stop using your monitor and contact your distributor or dealer for further assistance.*

FREQUENCY TABLE

This section includes supported frequency range of available video inputs.



APPENDIX A: FREQUENCY TABLE

The choice of supported modes depends on the monitor native resolution. Refer to the table below for more information about available input signals.

Signal name	Vertical Frequency (Hz)	DVI	VGA	HDMI 1.4
640 x 480	60	✓	✓	✓
	72	✓	✓	✓
	75	✓	✓	✓
480P	60	✓	✓	✓
800 x 600	60	✓	✓	✓
	72	✓	✓	✓
	75	✓	✓	✓
1024 x 768	60	✓	✓	✓
	72	✓	✓	✓
	75	✓	✓	✓
720P	60	✓	✓	✓
1280 x 1024	60	✓	✓	✓
	72	✓	✓	✓
	75	✓	✓	✓
1600 x 1200	60	✓	✓	✓
1920 x 1080	60	✓	✓	✓
1920 x 1200	60	✓	✓	✓



Winmate Inc.

9F, No.111-6, Shing-De Rd., San-Chung District,
New Taipei City 24158, Taiwan, R.O.C

Tel: 886-2-8511-0288

Fax: 886-2-8511-0211

Email: sales@winmate.com.tw

Official website: www.winmate.com
