

Full IP65 Chassis Display

8.4~42”



User Manual

Contents

Preface	3
About This User Manual	7
Chapter 1: Introduction	8
1.1 Overview	9
1.2 Product Features.....	9
1.3 Package Contents.....	9
1.4 Product Overview	10
1.5 Physical Buttons and LED Indicators	12
1.6 Connectors.....	13
Chapter 2: Installation	14
2.1 Wiring Requirements.....	15
2.2 Mounting Guide	15
2.2.2 VESA Mount.....	16
2.2.3 Yoke Mount	17
2.3 Cable Mounting Considerations	17
2.4 Connecting Power	18
2.5 Connecting Peripherals	19
2.5.1 Power Cable.....	19
2.5.2 USB Cable for Touch.....	20
2.5.3 RS-232 Cable for Touch	20
2.5.4 VGA Cable.....	21
2.5.5 DVI Cable	21
Chapter 3: Operating the Device	22
3.1 Turning On and Off the Device.....	23
3.2 OSD Menu Navigation.....	24
3.3 Troubleshooting Guide.....	25
Appendix	26
Appendix A: Frequency Table	27
Appendix B: Cleaning the Monitor	27

Preface

Copyright Notice

No part of this document may be reproduced, copied, translated, or transmitted in any form or by any means, electronic or mechanical, for any purpose, without the prior written permission of the original manufacturer.

Trademark Acknowledgement

Brand and product names are trademarks or registered trademarks of their respective owners.

Disclaimer

We reserve the right to make changes, without notice, to any product, including circuits and/or software described or contained in this manual in order to improve design and/or performance. We assume no responsibility or liability for the use of the described product(s) conveys no license or title under any patent, copyright, or masks work rights to these products, and make no representations or warranties that these products are free from patent, copyright, or mask work right infringement, unless otherwise specified. Applications that are described in this manual are for illustration purposes only. We make no representation or guarantee that such application will be suitable for the specified use without further testing or modification.

Warranty

Our warranty guarantees that each of its products will be free from material and workmanship defects for a period of one year from the invoice date. If the customer discovers a defect, we will, at his/her option, repair or replace the defective product at no charge to the customer, provide it is returned during the warranty period of one year, with transportation charges prepaid. The returned product must be properly packaged in its original packaging to obtain warranty service. If the serial number and the product shipping data differ by over 30 days, the in-warranty service will be made according to the shipping date. In the serial numbers the third and fourth two digits give the year of manufacture, and the fifth digit means the month (e. g., with A for October, B for November and C for December).

For example, the serial number 1W16Axxxxxxx means October of year 2016.

Customer Service

We provide a service guide for any problem by the following steps: First, visit the website of our distributor to find the update information about the product. Second, contact with your distributor, sales representative, or our customer service center for technical support if you need additional assistance.

You may need the following information ready before you call:

- Product serial number
- Software (OS, version, application software, etc.)
- Description of complete problem
- The exact wording of any error messages

In addition, free technical support is available from our engineers every business day. We are always ready to give advice on application requirements or specific information on the installation and operation of any of our products.

Naming Rule

R08TXXX-65XX

Item	Description
R	Panel Type
08	Panel Size
TXXX	Panel Specifications
65	Mechanical Type (Full IP65)
XX	Panel Model

Advisory Conventions

Four types of advisories are used throughout the user manual to provide helpful information or to alert you to the potential for hardware damage or personal injury. These are Notes, Important, Cautions, and Warnings. The following is an example of each type of advisory.



Note:

A note is used to emphasize helpful information



Important:

An important note indicates information that is important for you to know.



Caution/ Attention

A Caution alert indicates potential damage to hardware and explains how to avoid the potential problem.

Unéalerted' attention indique un dommage possible à l'équipement et explique comment éviter le problem potentiel.



Warning!/ Avertissement!

An Electrical Shock Warning indicates the potential harm from electrical hazards and how to avoid the potential problem.

Un Avertissement de Choc Électrique indique le potentiel de choc sur des emplacements électriques et comment éviter ces problèmes.



Alternating Current / Mise à la Terre The Protective Conductor Terminal (Earth Ground) symbol indicates the potential risk of serious electrical shock due to improper grounding.

Le symbole de Mise à Terre indique le risqué potentiel de choc électrique grave à la terre incorrecte.

Safety Information

Warning!/ Avertissement!



Always completely disconnect the power cord from your chassis whenever you work with the hardware. Do not make connections while the power is on. Sensitive electronic components can be damaged by sudden power surges. Only experienced electronics personnel should open the PC chassis.

Toujours débrancher le cordon d'alimentation du chassis lorsque vous travaillez sur celui-ci. Ne pas brancher de connexions lorsque l'alimentation est présente. Des composants électroniques sensibles peuvent être endommagés par des sauts d'alimentation. Seulement du personnel expérimenté devrait ouvrir ces chassis.

Caution/ Attention



Always ground yourself to remove any static charge before touching the CPU card. Modern electronic devices are very sensitive to static electric charges. As a safety precaution, use a grounding wrist strap at all times. Place all electronic components in a static-dissipative surface or static-shielded bag when they are not in the chassis.

Toujours vérifier votre mise à la terre afin d'éliminer toute charge statique avant de toucher la carte CPU. Les équipements électroniques modernes sont très sensibles aux décharges d'électricité statique. Toujours utiliser un bracelet de mise à la terre comme précaution. Placer toutes les composants électroniques sur une surface conçue pour dissiper les charge, ou dans un sac anti-statique lorsqu'elles ne sont pas dans le chassis.

Safety Precautions

For your safety carefully read all the safety instructions before using the device. Keep this user manual for future reference.

- Always disconnect this equipment from any AC outlet before cleaning. Do not use liquid or spray detergents for cleaning. Use a damp cloth.
- For pluggable equipment, the power outlet must be installed near the equipment and must be easily accessible.
- Keep this equipment away from humidity.
- Put this equipment on a reliable surface during installation. Dropping it or letting it fall could cause damage.
- The openings on the enclosure are for air convection and to protect the equipment from overheating.



Caution/ Attention

Do not cover the openings!

- Before connecting the equipment to the power outlet make sure the voltage of the power source is correct.
- Position the power cord so that people cannot step on it. Do not place anything over the power cord.
- If the equipment is not used for a long time, disconnect it from the power source to avoid damage by transient over-voltage.
- Never pour any liquid into an opening. This could cause fire or electrical shock.
- Never open the equipment. For safety reasons, only qualified service personnel should open the equipment.
- All cautions and warnings on the equipment should be noted.



Caution/ Attention

Always ground yourself to remove any static charge before touching the board. Modern electronic devices are very sensitive to static electric charges. As a safety precaution, use a grounding wrist strap at all times. Place all electronic components in a static-dissipative surface or static-shielded bag when they are not in the chassis.

About This User Manual

This User Manual provides information about using the Winmate® Full IP65 Chassis Display. The documentation set provides information for specific user needs, and includes:

- **Full IP65 Chassis Display User Manual** – contains detailed description on how to use the display, its components and features.



Note:

Some pictures in this guide are samples and can differ from actual product.

Models

Screen Size	Model Name
8.4"	R08T200-65T1
15"	R15L600-65C3
17"	R17L500-65M1
17"	R17L500-65A1
19"	R19L300-65M1
21.5"	W22L100-65A3
32"	W32L300-65A3
42"	W42L100-65A3
42"	W42L300-65A3

Document Revision History

Version	Date	Note
1.0	15-Dec-2018	New document release.

Chapter 1: Introduction

This chapter gives you product overview, describes features and hardware specification. You will find all accessories that come with the display device in the packing list. Mechanical dimensions and drawings included in this chapter.

1.1 Overview

Congratulations on purchasing Winmate® Full IP65 Chassis Display. Winmate multipurpose and waterproof fully sealed IP65 display is protected against outer dust and water splash, and ideal for use in harsh environments such as food processing and packaging automation. food processing and packaging automation.

1.2 Product Features

Full IP65 Chassis Display features:

- 8.4-42" TFT LCD
- VGA video input
- RS-232 or USB for touch
- Full IP65 water and dust proof
- SUS 304 stainless steel enclosure
- Supports VESA mount
- Suitable for food and pharmaceutical industry

1.3 Package Contents

Carefully remove the box and unpack your display. Please check if all the items listed below are inside your package. If any of these items are missing or damaged contact us immediately.

Standard factory shipment list:

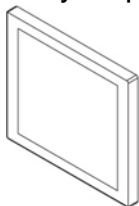

- **Display**

Varies by product



- **User Manual (Hardcopy)**

P/N: 91521110103R

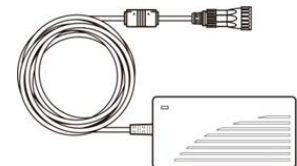

- **AC Adapter**

50W 90PO12050002
80W 90PO12080003

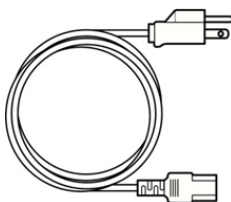

- **Power Cord**

Varies by country

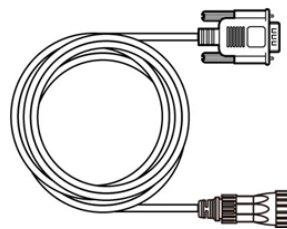

- **VGA Cable**

P/N: 944115010000

1.4 Product Overview

This section describes physical appearance of the Full IP65 Chassis Display.

Notice that input and output connectors vary by product size and specifications. The picture above shows only a prototype model for information purposes only.

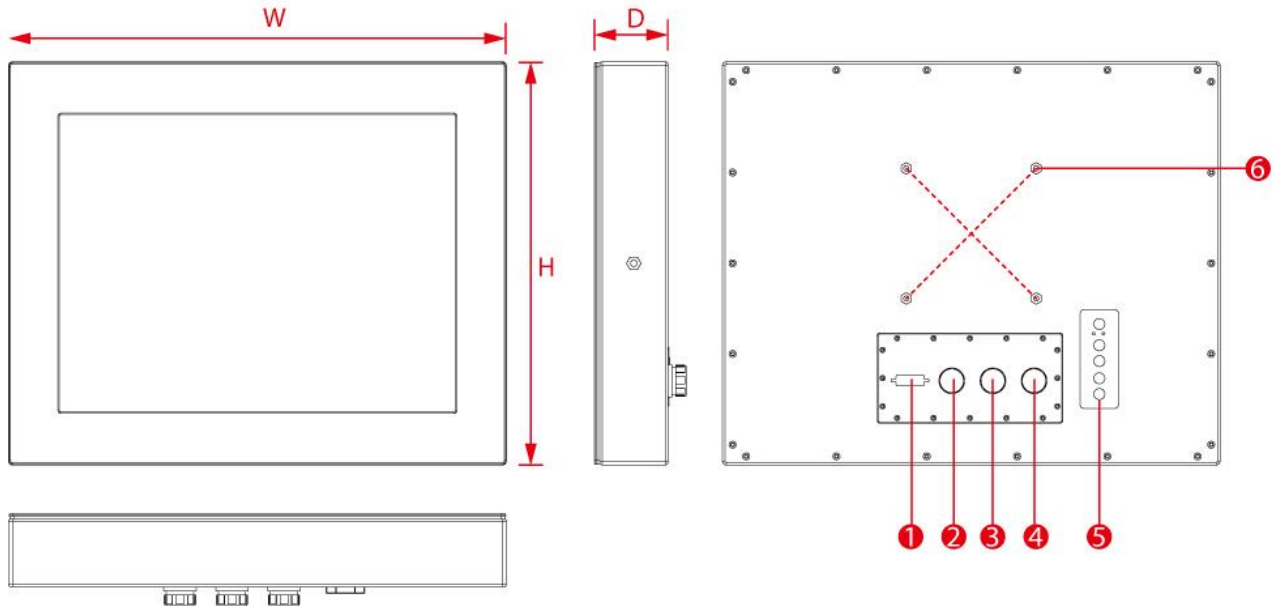

No	Description	No	Description
①	DVI (Optional)*	④	DC input
②	RS-232 or USB for touch (Optional)	⑤	OSD Control Panel*
③	VGA	⑥	VESA mount

* The location of OSD Panel may vary by model.

**The location and mechanical drawing varies by model.

Refer to the table below for a unit dimensions.

Model Name	Dimensions (W x H x D, mm)	VESA (W x H, mm)	VESA Screw Thread
R08T200-65T1	250 x 200 x 50	75 x 75	M4, L=5
R15L600-65C3	383 x 310 x 56.4	100 x 100	M4, L=5
R17L500-65M1	416 x 350 x 61.3	100 x 100	M4, L=5
R17L500-65A1	416 x 350 x 61.3	100 x 100	M4, L=5
R19L300-65M1	460 x 385 x 63	100 x 100	M4, L=5
W22L100-65A3	550 x 340 x 58.6	100 x 200	M4, L=5
W32L300-65A3	785 x 475 x 77.4	100 x 100, 100 x 200, 100 x 400	M6, L=6
W42L100-65A3	1046 x 633 x 64.6	200 x 200, 200 x 600	M8, L=6
W42L300-65A3	1046 x 633 x 64.6	200 x 200, 200 x 600	M8, L=6

1.5 Physical Buttons and LED Indicators

Physical buttons and LED indicators located on the rear side of the Display.

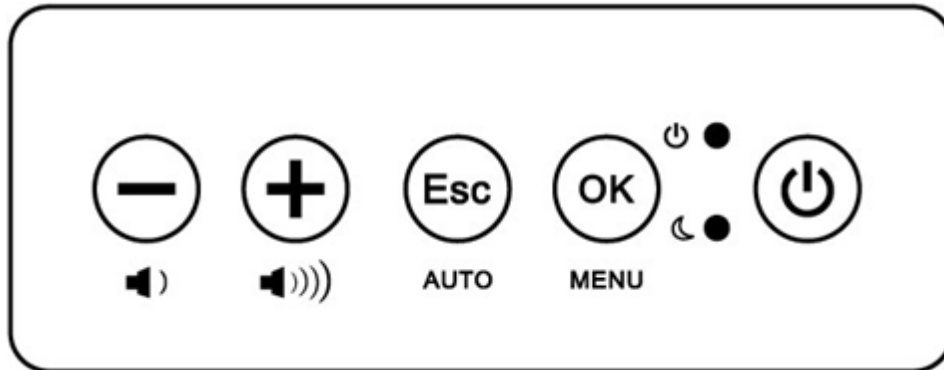

Physical Buttons

Icon	Button	Description
	DOWN/ VOLUME DOWN	Press to decrease the volume or volume down when without OSD menu.
	UP/ VOLUME UP	Press to increase the value or volume up when without OSD menu.
	ESC/ AUTO	Press to exit the menu or auto adjustment when without OSD menu.
	OK/ MENU	Press to confirm the action or to call main OSD menu.
	Power On/ Off	Press to power on or power off the device.

LED Indicators

LED Type	Status	Description
	On	Power is on
	Off	Power is off
	On	System is in standby mode
	Off	System is idle

1.6 Connectors

Full IP65 Chassis Display has M25 type connectors with protection caps.



Caution/ Attention

To maintain device's IP65 rating close the I/O and tighten protection caps when I/O is not used.

Pour maintenir la norme IP65 de l'appareil près d'E / S et serrer capuchons de protection lorsque E / S est pas utilisé.

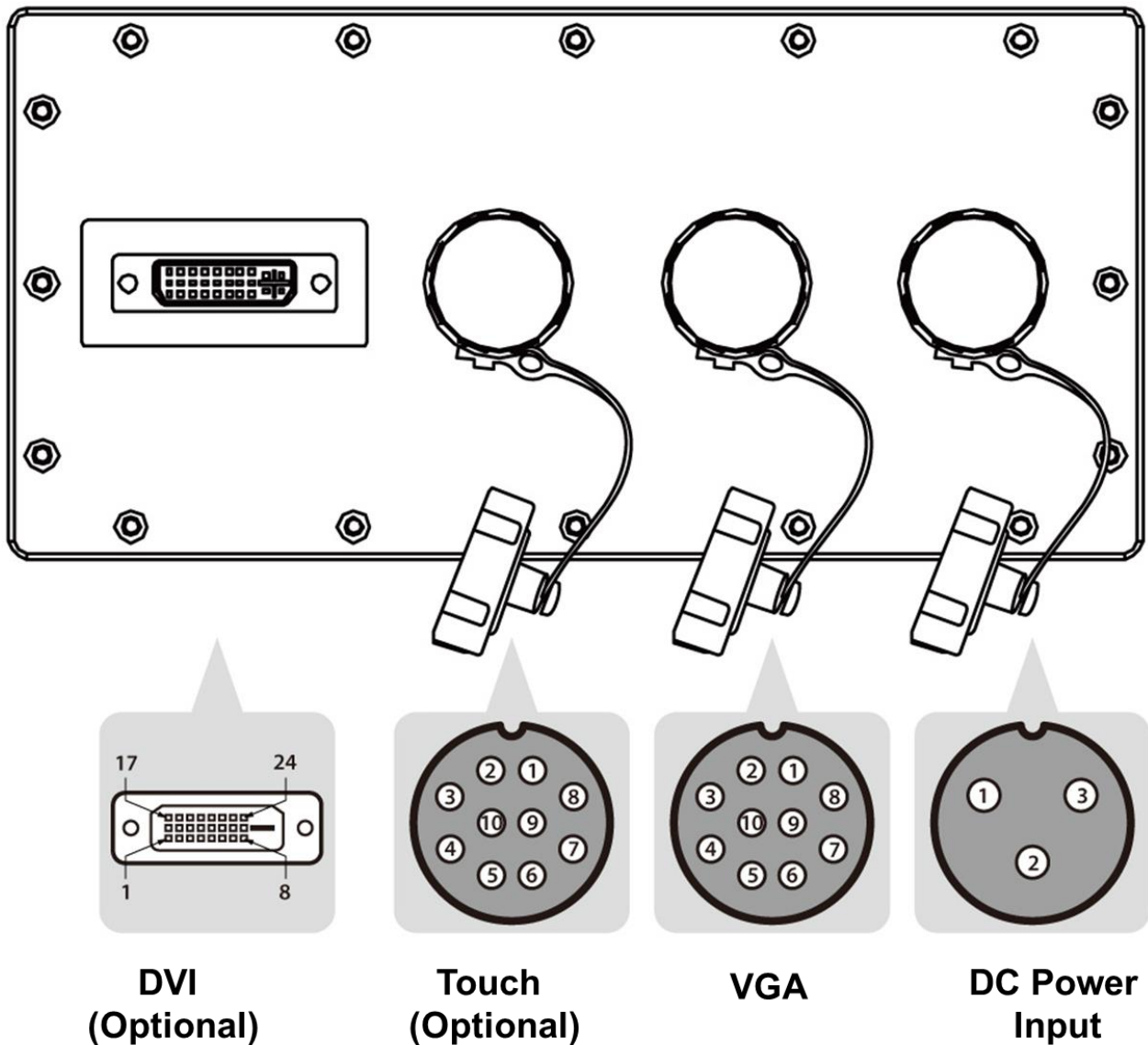

Chapter 2: Installation

This chapter provides hardware installation instructions and mounting guide for all available mounting options. Pay attention to cautions and warning to avoid any damages

2.1 Wiring Requirements

The following common safety precautions should be observed before installing any electronic device:

- Strive to use separate, non-intersecting paths to route power and networking wires. If power wiring and device wiring paths must cross make sure the wires are perpendicular at the intersection point.
- Keep the wires separated according to interface. The rule of thumb is that wiring that shares similar electrical characteristics may be bundled together.
- Do not bundle input wiring with output wiring. Keep them separate.
- When necessary, it is strongly advised that you label wiring to all devices in the system.
- Do not run signal or communication wiring and power wiring in the same conduit. To avoid interference, wires with different signal characteristics (i.e., different interfaces) should be routed separately.
- Be sure to disconnect the power cord before installing and/or wiring your device.
- Verify the maximum possible current for each wire gauge, especially for the power cords. Observe all electrical codes dictating the maximum current allowable for each wire gauge.
- If the current goes above the maximum ratings, the wiring could overheat, causing serious damage to your equipment.

Be careful when handling the unit. When the unit is plugged in, the internal components generate a lot of heat which may leave the outer casing too hot to touch.

2.2 Mounting Guide

The Full IP65 Chassis supports VESA mount for wall and desk installation. Refer to sub-sections below for more details.



Caution/ Attention

Follow mounting instructions and use recommended mounting hardware to avoid the risk of injury.

Suivez les instructions de montage et d'utilisation recommandé le matériel de montage pour éviter le risque de blessure.

2.2.2 VESA Mount

The Display has VESA mount holes on the rear side. Follow instructions below to mount the unit with VESA mount bracket .

Size	VESA Dimensions	Screw Hole Diameter
8.4"	75 x 75 mm	VESA M4, D=5 mm
15",17", 19"	100 x 100 mm	VESA M4, D=5 mm
21.5"	100 x 200 mm	VESA M4, D=5 mm
32"	100 x 200 mm, 100 x 400	VESA M6, D=6 mm
42"	200 x 200, 200 x 600	VESA M6, D=6 mm

Installation Instruction:

1. Screw VESA bracket to the fixture (ex. swing arm) with four VESA screws.
2. Place the device on VESA bracket.

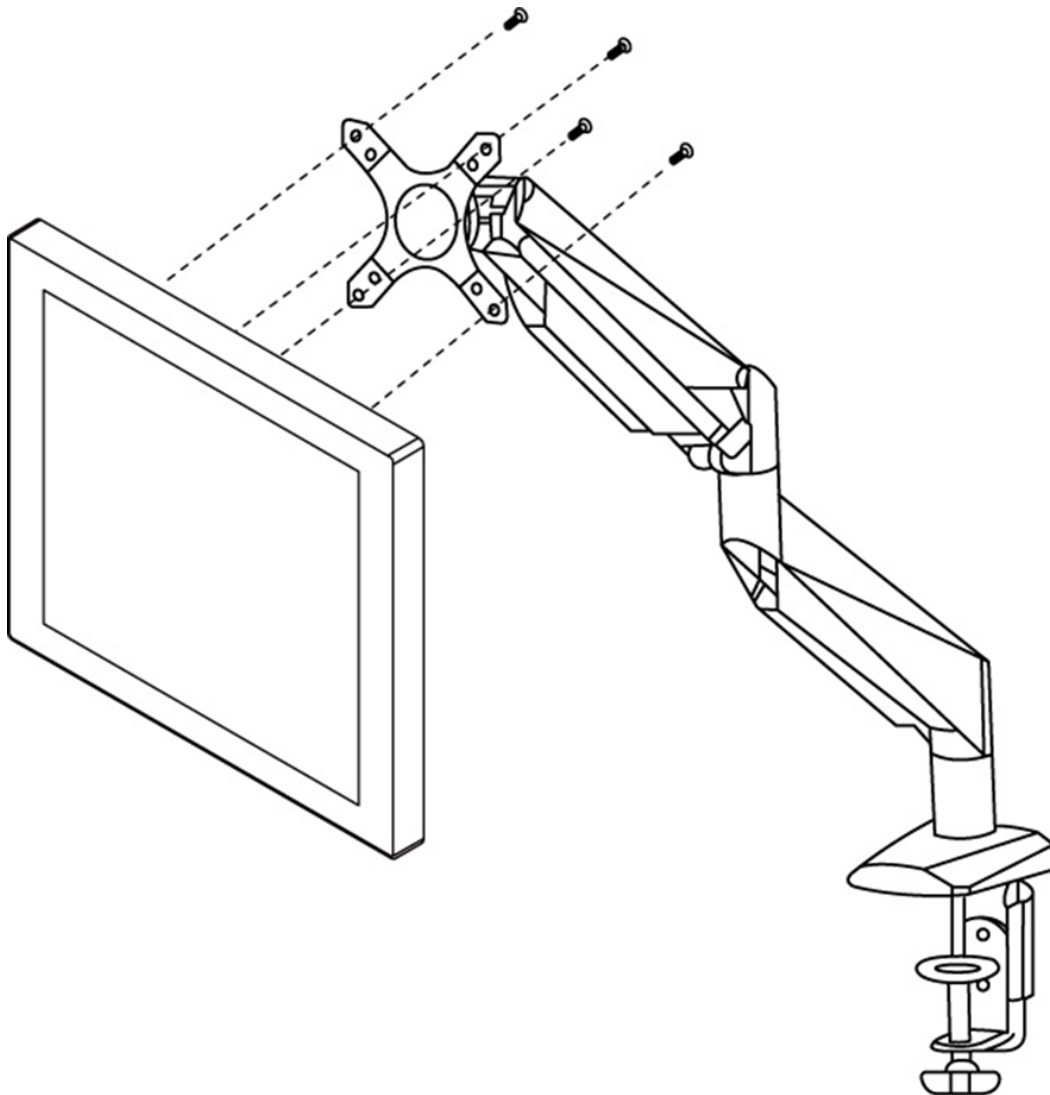

Notice that VESA stand and mounting kit are not provided by Winmate.

2.2.3 Yoke Mount

Yoke Mount solution allows installing the display with the bracket.

Mounting instruction:

1. Place the Display on the bracket stand, aiming screw holes for each other.
2. Secure screws to fix the device upon the bracket stand.
3. Firmly secure the locking handle to the Display.

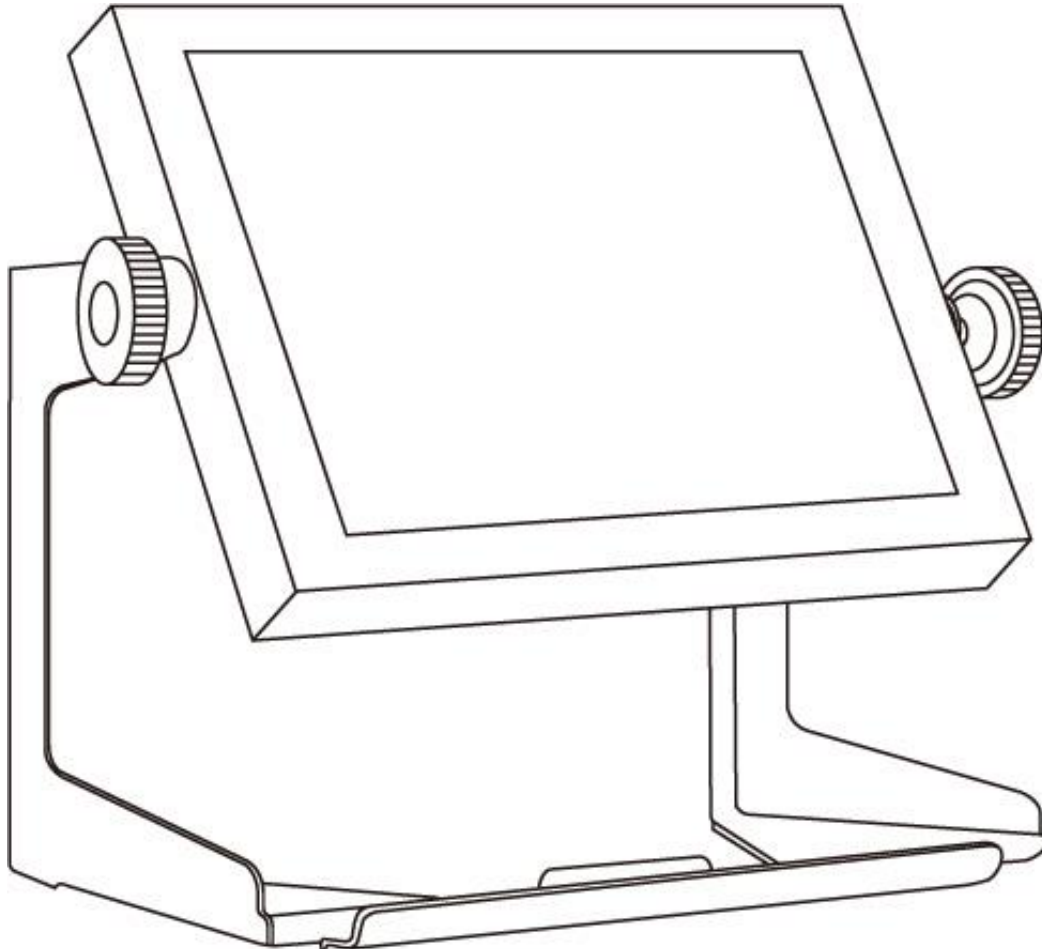

Notice that bracket stand is not provided by Winmate.

2.3 Cable Mounting Considerations

For a nice look and safe installation, make sure cables are neatly hidden behind the device.



Caution/ Attention

Observe all local installation requirements for connection cable type and protection level.

Suivre tous les règlements locaux d'installations, de câblage et niveaux de protection.



Caution/ Attention

Turn off the device and disconnect other peripherals before installation.

Éteindre l'appareil et débrancher tous les périphériques avant l'installation.

2.4 Connecting Power

This section provides information on how to use connectors on the Display. Be cautious while working with these modules. Please carefully read the content of this chapter in order to avoid any damages.

Installation instruction:

1. Connect the AC cord to the AC IN terminal on the AC adapter.
2. Connect the DC OUT terminal of the AC adaptor to the DC IN terminal on the monitor.
3. Align the notch on the cord connector with the guiding groove and plug it in.
4. Connect the AC cord plug to the power outlet.

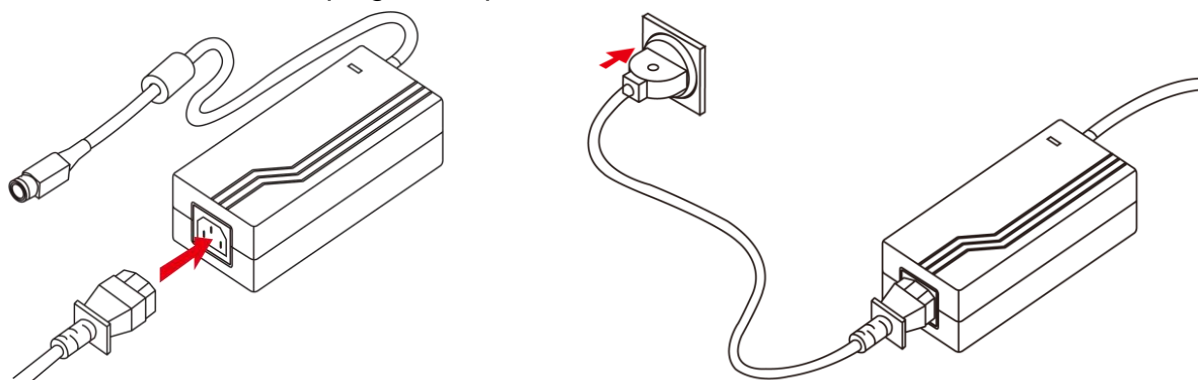

2.5 Connecting Peripherals

The panel control port is designed for monitors that work with a variety of compatible video sources. Due to the possible deviations between these signal sources, you may have to make adjustments to the monitor settings from the OSD menu when switching between these sources.



Note:

Notice that standard input terminals include VGA. Your device may be equipped with USB for touch, DVI input terminals based on your order.

2.5.1 Power Cable

The Full IP65 Chassis Display has M25 type connectors. Use power cable to connect display to the source of power.

The display support 12V DC power input.

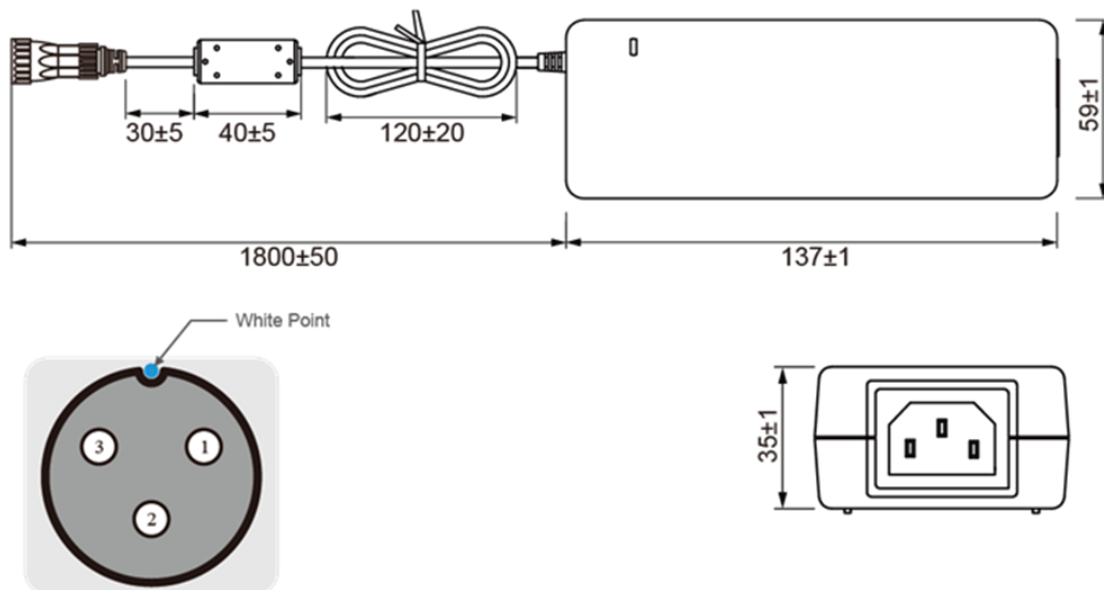

Pin No.	Symbols	Color
CN1-3	GND	Black
CN1-2	shield	
CN1-1	VCC	White

2.5.2 USB Cable for Touch

The display may have optional M25 type USB connector for touch based on your order. Use USB cable to connect touch.

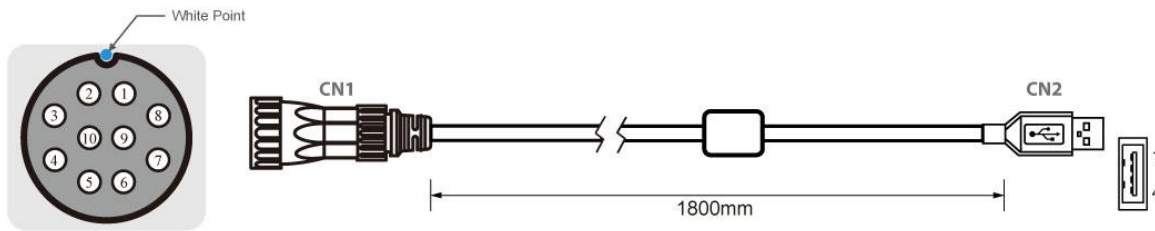

Pin No.	Symbols	Color	Pin No.	Symbols	Color
CN1-1	VCC	RED	CN2-1	VCC	RED
CN1-2	D-	WHITE	CN2-2	D-	WHITE
CN1-3	D+	GREEN	CN2-3	D+	GREEN
CN1-4	GND	BLACK	CN2-4	GND	BLACK
CN1-5	Shield		CN2	Shield	

} Twist

2.5.3 RS-232 Cable for Touch

The display may have optional M25 type serial port connector based on your order. Use serial cable to connect touch.

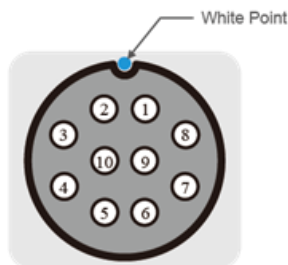
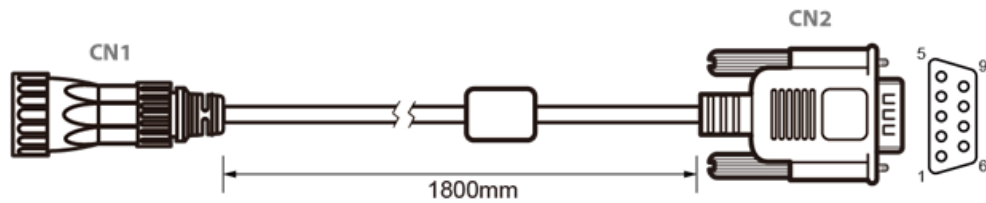

Pin No.	Symbols	Color		Pin No.	Symbols	Color
CN1-1	DCD-CON2	Green	↔	CN2-1	DCD-CON2	Green
CN1-2	DSR-CON2	Brown	↔	CN2-6	DSR-CON2	Brown
CN1-3	RXD-CON2	Red	↔	CN2-2	RXD-CON2	Red
CN1-4	RTS-CON2	Orange	↔	CN2-7	RTS-CON2	Orange
CN1-5	TXD-CON2	Blue	↔	CN2-3	TXD-CON2	Blue
CN1-6	CTS-CON2	White	↔	CN2-8	CTS-CON2	White
CN1-7	DTR-CON2	Purple	↔	CN2-4	DTR-CON2	Purple
CN1-8	RI-CON2	Yellow	↔	CN2-9	RI-CON2	Yellow
CN1-9	GND-CON2	Black	↔	CN2-5	GND-CON2	Black
CN1-10	NC		↔	CN2-10	NC	

2.5.4 VGA Cable

The display has M25 type VGA connector. Use VGA cable to connect the display to other external devices.

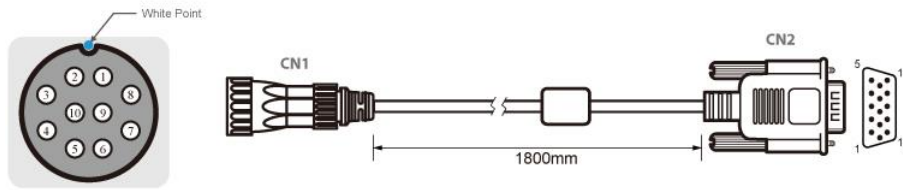

CN1			CN2		
Pin No.	Symbols	Color	Pin No.	Symbols	Color
1	R	Red	1	R	Red
2	R-GND	Black	6	R-GIND	Black
3	G	Green	2	G	Green
4	G-GND	Black	7	G-GND	Black
5	B	Blue	3	B	Blue
6	B-GND	Black	8	B-GND	Black
7	SDA	Yellow	12	SDA	Yellow
8	HS	Orange	13	HS	Orange
9	VS	White	14	VS	White
10	SCL	Brown	15	SCL	Brown
			4	HS-GDN	
			5	NC	
			9	NC	
			10	NC	
			11	VS-GDN	

2.5.5 DVI Cable

The display may have optional DVI connector based on your order. Use DVI cable to connect the display to other external device.

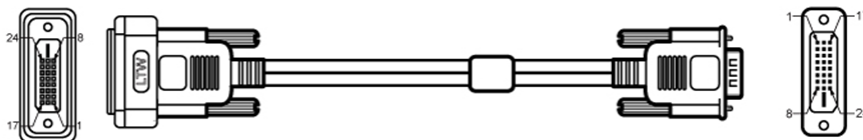

CN1		CN2	
Pin No.	Symbol	Pin No.	Symbol
CN1-1	TMDS Data2-	CN2-1	TMDS Data2-
CN1-2	TMDS Data2+	CN2-2	TMDS Data2+
CN1-3	TMDS Data2 Shield	CN2-3	TMDS Data2 Shield
CN1-4	NC	CN2-4	NC
CN1-5	NC	CN2-5	NC
CN1-6	DDC Clock	CN2-6	DDC Clock
CN1-7	DDC Data	CN2-7	DDC Data
CN1-8	NC	CN2-8	NC
CN1-9	TMDS Data 1-	CN2-9	TMDS Data 1-
CN1-10	TMDS Data 1+	CN2-10	TMDS Data 1+
CN1-11	TMDS Data 1 Shield	CN2-11	TMDS Data 1 Shield
CN1-12	NC	CN2-12	NC
CN1-13	NC	CN2-13	NC
CN1-14	+5V Power	CN2-14	+5V Power
CN1-15	Ground	CN2-15	Ground
CN1-16	Hot Plug Detect	CN2-16	Hot Plug Detect
CN1-17	TMDS Data 0-	CN2-17	TMDS Data 0-
CN1-18	TMDS Data 0+	CN2-18	TMDS Data 0+
CN1-19	TMDS Data 0 Shield	CN2-19	TMDS Data 0 Shield
CN1-20	NC	CN2-20	NC
CN1-21	NC	CN2-21	NC
CN1-22	TMDS Data Clock Shield	CN2-22	TMDS Data Clock Shield
CN1-23	TMDS Clock+	CN2-23	TMDS Clock+
CN1-24	TMDS Clock-	CN2-24	TMDS Clock-

Chapter 3: Operating the Device

In this chapter you will find instructions on how to operate the display.



3.1 Turning On and Off the Device





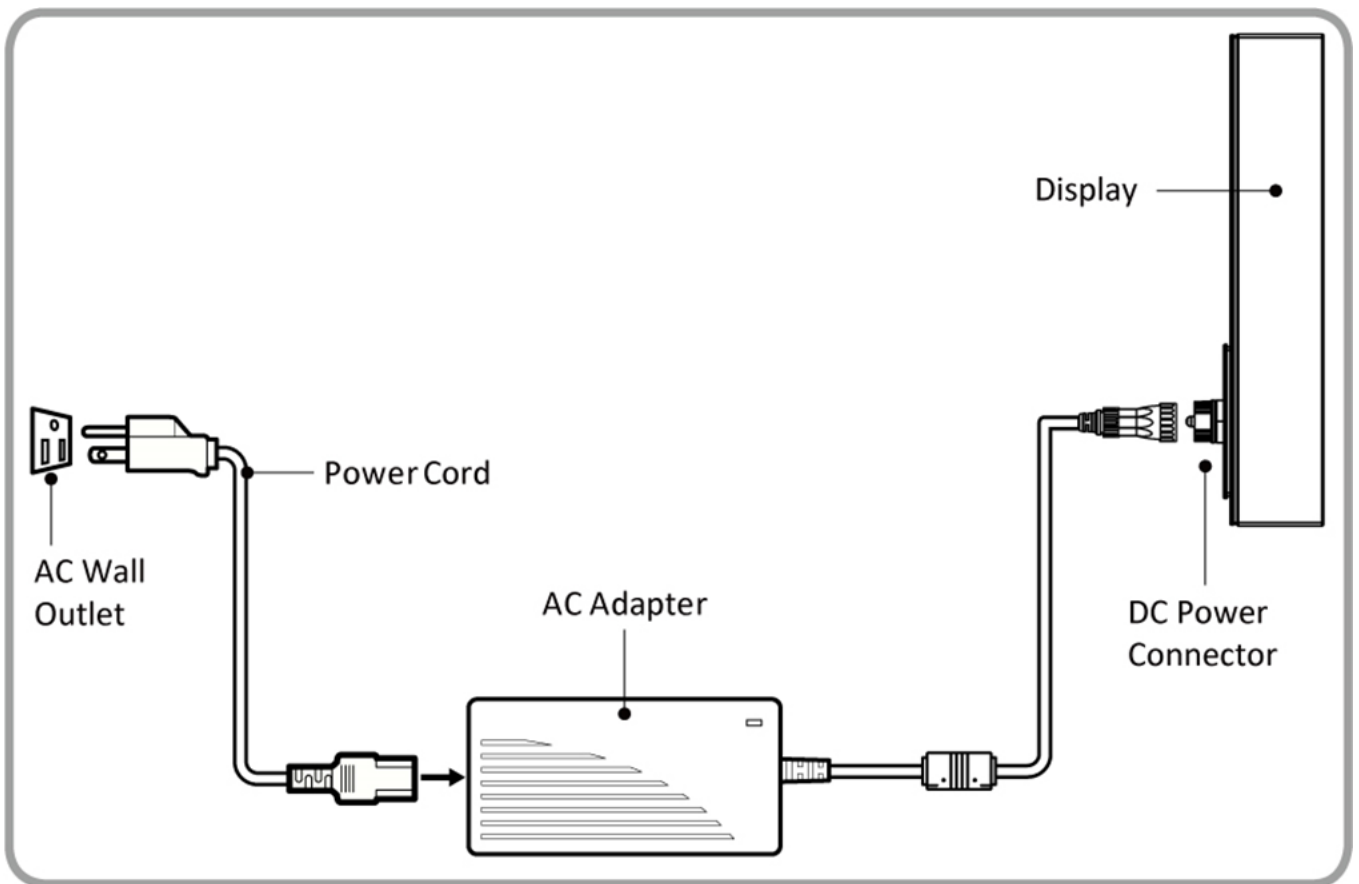

To turn on the system:

1. Connect the power adapter cable to the DC input of the display.
2. Connect the power cord to the power adapter.
3. Connect the power cord to a power outlet.
4. Press the power button located on the OSD control panel on the rear to turn on the system.

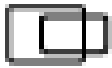

To shut down your device, do the following disconnect the power cord and the device will automatically turn off.

3.2 OSD Menu Navigation

OSD Icon	Sub-menu	Settings	Note
 BRICONTRAST	BRIGHTNESS	slider bar	Default 50
	Use to adjust the screen's brightness. Range 0 to 100		
	CONTRAST	slider bar	Default 50
	Use to adjust the screen's contrast. Range 0 to 100		
 POSITION	H POSITION	slider bar	Default 50
	Use to adjust the image to the left or right on the screen. Range 0 to 100		
	V POSITION	slider bar	Default 50
Use to adjust the image up or down on the screen. Range 0 to 100			
 IMAGE	AUTO	Select and execute	
	Use to choose the best settings for the current input signal		
	CLOCK	slider bar	
	Use to adjust the value of horizontal image.		
	PAHSE	slider bar	
	Use to adjust the phase control (May be required to optimize the display quality)		
	WHITE BALANCE	Select and execute	
Use to set RGB signal voltage level			
 COLOR	USER	R.G.B slider bar	
	Choose RED/GREEN/BLUE to set value of color temperature brightness.		
	9300K	Select and execute	
	Use to set value of monitor for the CIE coordinate 9300 color temperature		
	6500K	Select and execute	
	Use to set value of monitor for the CIE coordinate 6500 color temperature		
	ADC RIGHTNESS	slider bar	Default 50
Set value of monitor for ADC Brightness. Range 0 to 100			
 XII GAMMA	GAMMA 0	Select and execute	Default GAMMA0
	Choose the parameter of GAMMA 0 as default setting.		
	GAMMA 1	Select and execute	
	Choose the parameter of GAMMA 1 as default setting.		
	GAMMA 2	Select and execute	
Choose the parameter of GAMMA 2 as default setting.			
 CHANNEL	AUTO SCAN	Select and execute	Default mode
	Auto detect the input source		
	ANALOG	Select and execute	
	Switch the setting of signal input to Analog mode		
	DVI	Select and execute	
Switch the setting of signal input to DVI mode			
 RECALL	YES	Select and execute	
	Recall the factory default setting		
	NO	Select and execute	
Return to main menu			
 EXIT	YES	Select and execute	

3.3 Troubleshooting Guide

If your monitor fails to operate correctly, check the following chart for possible solution before calling for repairs:

Condition	Check Point
The picture does not appear	<ul style="list-style-type: none"> • Check if the signal cable is firmly seated in the socket. • Check if the Power is ON at the computer • Check if the brightness control is at the appropriate position, not at the minimum.
The screen is not synchronized	<ul style="list-style-type: none"> • Check if the signal cable is firmly seated in the socket. • Check if the output level matches the input level of your computer. • Make sure the signal timings of the computer system are within the specification of the monitor. • If your computer was working with a CRT monitor, you should check the current signal timing and turn off your computer before you connect the VGA Cable to this monitor.
The position of the screen is not in the center	<ul style="list-style-type: none"> • Adjust the H-position, and V-position, or Perform the Auto adjustment.
The screen is too bright (too dark)	<ul style="list-style-type: none"> • Check if the brightness or contrast control is at the appropriate position, not at the Maximum (Minimum).
The screen is shaking or waving	<ul style="list-style-type: none"> • Perform the Auto adjustment. • Moving all objects which emit a magnetic field such as motor or transformer, away from the monitor. • Check if the specific voltage is applied. • Check if the signal timing of the computer system is within the specification of monitor.

**If you are unable to correct the fault by using this chart, stop using your monitor and contact your distributor or dealer for further assistance.*

Appendix

This chapter contains additional product information, including troubleshooting guide and frequency table



Appendix A: Frequency Table

The choice of supported modes depends on the monitor native resolution. Refer to the table below for more information about available input signals.

Signal name	Vertical Frequency (Hz)	DVI	VGA
640 x 480	60	✓	✓
	72	✓	✓
	75	✓	✓
480P	60	✓	✓
800 x 600	60	✓	✓
	72	✓	✓
	75	✓	✓
1024 x 768	60	✓	✓
	72	✓	✓
	75	✓	✓
720P	60	✓	✓
1280 x 1024	60	✓	✓
	72	✓	✓
	75	✓	✓
1600 x 1200	60	✓	✓
1920 x 1080	60	✓	✓
1920 x 1200	60	✓	✓

Appendix B: Cleaning the Monitor

Before cleaning:

- Make sure the device is turned off.
- Disconnect the power cable from any AC outlet.

When cleaning:

- Use water up to 80°C to clean the housing.
- Wipe the screen with a clean, soft, lint-free cloth. This removes dust and other particles.
- The display area is highly prone to scratching. Does not use ketene type material (for example Acetone), Ethyl alcohol, toluene, ethyl acid or Methyl chloride to clear the panel. It may permanently damage the panel and void the warranty.
- If it is still not clean enough, apply a small amount of non-ammonia, non-alcohol based glass cleaner onto a clean, soft, lint-free cloth, and wipe the screen.
- Don not use oil directly on the display screen. If droplets are allowed to drop on the screen, permanent staining or discoloration may occur.

Winmate Inc.
9F, No.111-6, Shing-De Rd., San-Chung District,
New Taipei City 24158, Taiwan, R.O.C
www.winmate.com