

17~32" Rack Mount Military Display



Model No. **R17L100-RKA1ML**
R19L100-RKA3ML
R20L100-RKA2ML
W24L100-RKS1ML
W32L100-RKA3ML

User Manual

For more information on this and other Winmate products, please visit our website at:
www.winmate.com

Document Version V1.2

Document Part No. 9152111101D

Please read this instructions before operating the device and retain them for future reference.

CONTENTS

PREFACE	3
ABOUT THIS USER MANUAL	7
CHAPTER 1: INTRODUCTION	8
1.1 INTRODUCTION	8
1.2 PRODUCT FEATURES	8
1.3 PACKAGE CONTENTS	9
1.4 PHYSICAL BUTTONS AND LED INDICATORS	15
CHAPTER 2: GETTING STARTED	16
2.1 POWERING ON	16
2.1.1 <i>Power Considerations</i>	16
2.1.2 <i>Connecting the Power</i>	17
2.2 CONNECTING OTHER DEVICES.....	19
2.2.1 <i>VGA Connector</i>	19
2.2.2 <i>VGA to 5 BNCs Signal Shielding Cable</i>	19
2.2.3 <i>DVI-I Connector</i>	20
2.2.4 <i>HDMI Connector</i>	20
CHAPTER 3: MOUNTING	21
3.1 CABLE MOUNTING CONSIDERATIONS	21
3.2 MOUNTING GUIDE	22
3.2.1 <i>Console / Rack Mount</i>	22
3.2.2 <i>VESA Mount</i>	23
CHAPTER 4: ON-SCREEN DISPLAY CONTROL	24
4.1 NAVIGATING THE OSD MENU	24
4.2 OSD MENU IN VGA MODE	25
4.3 OSD MENU IN DVI MODE	27
CHAPTER 5: MAINTENANCE	30
5.1 CLEANING THE DISPLAY SCREEN	30
5.2 CLEANING THE CASING	30
CHAPTER 6: TECHNICAL SUPPORT	31
6.1 TROUBLESHOOTING	31
6.2 PROBLEM REPORT FORM	32
APPENDIX	33
APPENDIX A: PRODUCT SPECIFICATIONS	33
APPENDIX B: ORDER INFORMATION.....	34
APPENDIX C: MIL-STD-810F/G COMPLIANCE	34
APPENDIX D: MIL-STD-461E/F COMPLIANCE	35

Preface

Copyright Notice

No part of this document may be reproduced, copied, translated, or transmitted in any form or by any means, electronic or mechanical, for any purpose, without the prior written permission of the original manufacturer.

Trademark Acknowledgement

Brand and product names are trademarks or registered trademarks of their respective owners.

Disclaimer

We reserve the right to make changes, without notice, to any product, including circuits and/or software described or contained in this manual in order to improve design and/or performance. We assume no responsibility or liability for the use of the described product(s) conveys no license or title under any patent, copyright, or masks work rights to these products, and make no representations or warranties that these products are free from patent, copyright, or mask work right infringement, unless otherwise specified. Applications that are described in this manual are for illustration purposes only. We make no representation or guarantee that such application will be suitable for the specified use without further testing or modification.

Warranty

Our warranty guarantees that each of its products will be free from material and workmanship defects for a period of one year from the invoice date. If the customer discovers a defect, we will, at his/her option, repair or replace the defective product at no charge to the customer, provide it is returned during the warranty period of one year, with transportation charges prepaid. The returned product must be properly packaged in its original packaging to obtain warranty service. If the serial number and the product shipping data differ by over 30 days, the in-warranty service will be made according to the shipping date. In the serial numbers the third and fourth two digits give the year of manufacture, and the fifth digit means the month (e. g., with A for October, B for November and C for December).

For example, the serial number 1W16Axxxxxxx means October of year 2016.

Customer Service

We provide a service guide for any problem by the following steps: First, visit the website of our distributor to find the update information about the product. Second, contact with your distributor, sales representative, or our customer service center for technical support if you need additional assistance.

You may need the following information ready before you call:

- Product serial number.
- Detailed description of the problem.
- The exact wording of error messages.

In addition, free technical support is available from our engineers every business day. We are always ready to give advice on application requirements or specific information on the installation and operation of any of our products.

Advisory Conventions

Four types of advisories are used throughout the user manual to provide helpful information or to alert you to the potential for hardware damage or personal injury. These are Notes, Important, Cautions, and Warnings. The following is an example of each type of advisory.



Note:

A note is used to emphasize helpful information



Important:

An important note indicates information that is important for you to know.



Caution/ Attention

A Caution alert indicates potential damage to hardware and explains how to avoid the potential problem.

Une alerte d'attention indique un dommage possible à l'équipement et explique comment éviter le problème potentiel.



Warning!/ Avertissement!

An Electrical Shock Warning indicates the potential harm from electrical hazards and how to avoid the potential problem.

Un Avertissement de Choc Électrique indique le potentiel de chocs sur des emplacements électriques et comment éviter ces problèmes.





Alternating Current/ Mise à le terre !

The Protective Conductor Terminal (Earth Ground) symbol indicates the potential risk of serious electrical shock due to improper grounding.

Le symbole de Mise à Terre indique le risqué potentiel de choc électrique grave à la terre incorrecte.

Safety Information

CAUTION!	POSSIBLE PROBLEM	PREVENTION
 <p>Do not expose the display to direct sunlight.</p>	<p>Sunlight shines directly will cause the panel damage.</p>	<p>You should avoid placing the product under direct sunlight.</p>
 <p>Do not place the display in wet environment.</p>	<p>If the product is close to the wet ground such as grassplot, the moisture between panel and glass will make the product malfunction.</p>	<p>You should avoid placing the product in wet environment.</p>

Safety Precautions

For your safety carefully read all the safety instructions before using the device. All cautions and warnings on the equipment should be noted. Keep this user manual for future reference.



Caution/ Attention

Do not cover the openings!
Ne pas couvrir les ouvertures!

*Let service personnel to check the equipment in case any of the following problems appear:

- The power cord or plug is damaged.
- Liquid has penetrated into the equipment.
- The equipment has been exposed to moisture.
- The equipment does not work well or you cannot get it to work according to the user manual.
- The equipment has been dropped and damaged.
- The equipment has obvious signs of breakage.
- Do not leave this equipment in an uncontrolled environment where the storage temperature is below -20°C (-4°F) or above 60°C (140°F). It may damage the equipment.



Caution/ Attention

Use the recommended mounting apparatus to avoid risk of injury.
Utiliser l'appareil de fixation recommandé pour éliminer le risque de blessure.



Warning!/ Avertissement!

Only use the connection cords that come with the product. When in doubt, please contact the manufacturer.
Utiliser seulement les cordons d'alimentation fournis avec le produit. Si vous doutez de leur provenance, contactez le manufacturier.



Warning!/ Avertissement!

Always ground yourself against electrostatic damage to the device.
Toujours vérifier votre mise à la terre afin que l'équipement ne se décharge pas sur vous.

Important Safety Information

Federal Communications Commission Radio Frequency Interface Statement



This device complies with part 15 FCC rules.

Operation is subject to the following two conditions:

- This device may not cause harmful interference.
- This device must accept any interference received including interference that may cause undesired operation.

This equipment has been tested and found to comply with the limits for a class "A" digital device, pursuant to part 15 of the FCC rules. These limits are designed to provide reasonable protection against harmful interference when the equipment is operated in a commercial environment. This equipment generates, uses, and can radiate radio frequency energy and, if not installed and used in accordance with the instruction manual, may cause harmful interference to radio communications. Operation of this equipment in a residential area is likely to cause harmful interference in which case the user will be required to correct the interference at his own expense.

European Union



Thus equipment is in conformity with the requirement of the following EU legislations and harmonized standards. Product also complies with the Council directions.

Electromagnetic Compatibility Directive (2014/30/EU)

- EN55024: 2010 EN 55022: 2010 Class B
 - IEC61000-4-2: 2009
 - IEC61000-4-3: 2006+A1: 2007+A2: 2010
 - IEC61000-4-4: 2012
 - IEC61000-4-5: 2014
 - IEC61000-4-6: 2013
 - IEC61000-4-8: 2010
 - IEC61000-4-11: 2004
- EN55022: 2010/AC:2011
- EN61000-3-2:2014
- EN61000-3-3:2013

Low Voltage Directive (2014/35/EU)

- EN 60950-1:2006/A11:2009/A1:2010/A12:2011/ A2:2013

About This User Manual

This User Manual provides information about using the Winmate® Military Grade Rack Mount Display.

The documentation set for the Military Grade Rack Mount Display provides information for specific user needs, and includes:

- **Military Grade Rack Mount Display User Manual** – contains detailed description on how to use the device, its components and features.



Note:

Some pictures in this guide are samples and can differ from actual product.

Document Revision History

Version	Date	Note
1.0	8-Mar-2016	Initial release
1.1	9-Sep-2016	Revise format, add mounting instruction
1.2	9-Mar-2017	Add W32L100-RKA3ML

Chapter 1: Introduction

This chapter gives you product overview, describes features and hardware specification. You will find all accessories that come in the package.

1.1 Introduction

Thank you for choosing the Winmate® Military Grade Rack Mount Display. Winmate® Military Grade Displays feature anti-corrosive coating with aluminum alloy housing withstands the harshest military environments. Armored power connector MIL-DTL-38999 Type I initially developed for aerospace industry perfectly fit in our Military grade product line.

Withstanding rigors of harsh environments and tough weather conditions these Displays meet the most demanding requirements. Suitable for Army Headquarters and being connected to mobile devices on the field Display can provide up-to-date information for immediate commands.

1.2 Product Features

Winmate® Military Grade Rack Mount Display offers the following features:

- 17~32" LCD
- Aluminum housing with anti-corrosive coating.
- Compliance with military standard MIL-STD-810G/F.
- Flush Rack / Rack Mount Mechanical Design
- AC 110~240V Power input (default) or isolation DC IN 9~36V (Optional)
- Convenient On-Screen Display Controls
- Built-in Light Sensor for auto brightness control
- Military Grade Power Connector (MIL-DTL-38999/1)
- Standard AR Glass
- EMI ITO Glass (Optional)
- 5-wire Resistive Touch (Optional)
- 5-wire Resistive Touch with EMI Mesh Coating (Optional)

1.3 Package Contents

Carefully remove the box and unpack your device. Please check if all the items listed below are inside your package. If any of these items are missing or damaged contact us immediately.

Standard factory shipment list:

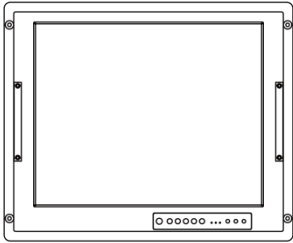

- Display



- User Manual (Hardcopy)

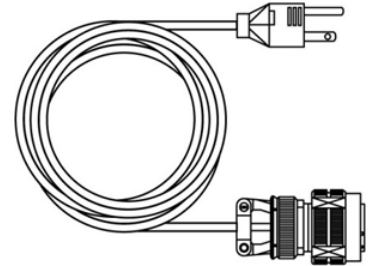

- Power Cord
MIL-DTL-38999/1, 2m

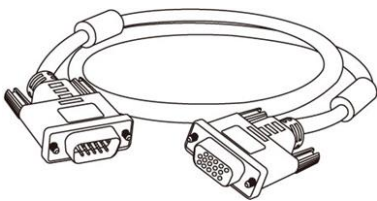

VGA Cable, 2m

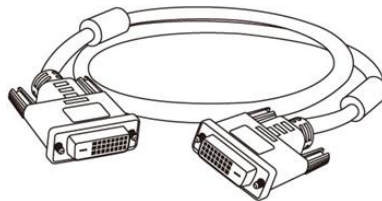

DVI Cable, 2m

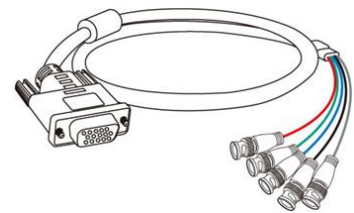

VGA to 5 BNC Shielding
Cable, 2m

The package may include the following items based on your order:

- 1 x Touch Driver CD (Optional)
- 1 x Touch RS-232 Shielding Cable, 2 meter (Optional)
- 1 x RS-232 Remote Control Shielding Cable, 2 meter (optional)
- 1 x HDMI Cable

Dimension 17"

Unit: mm

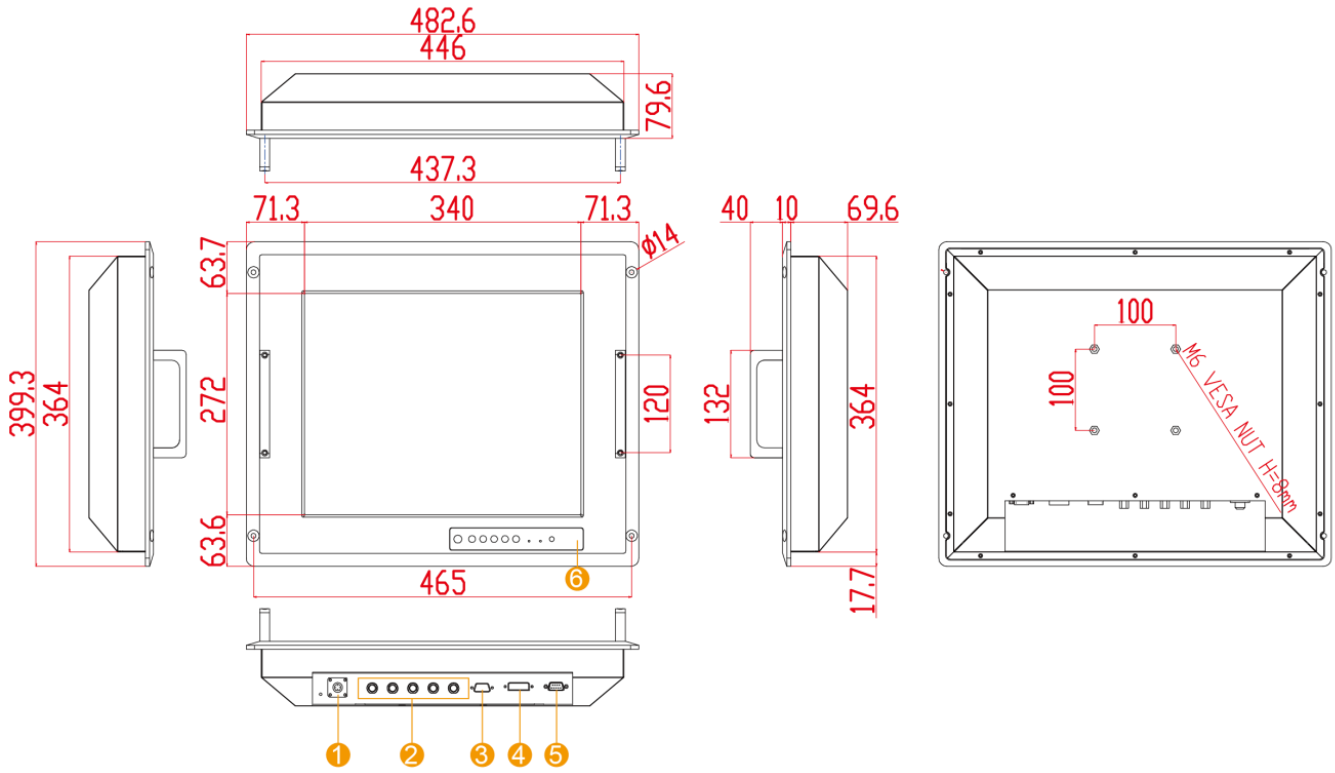

CUT OUT 450x368 mm

No	Description	No	Description
①	AC in 220V ±10%, 50 ± 3% Hz	④	DVI-D
②	5 x BNCs	⑤	RS232
③	15 pin D-Sub (VGA)		

Dimensions 19"

Unit : mm

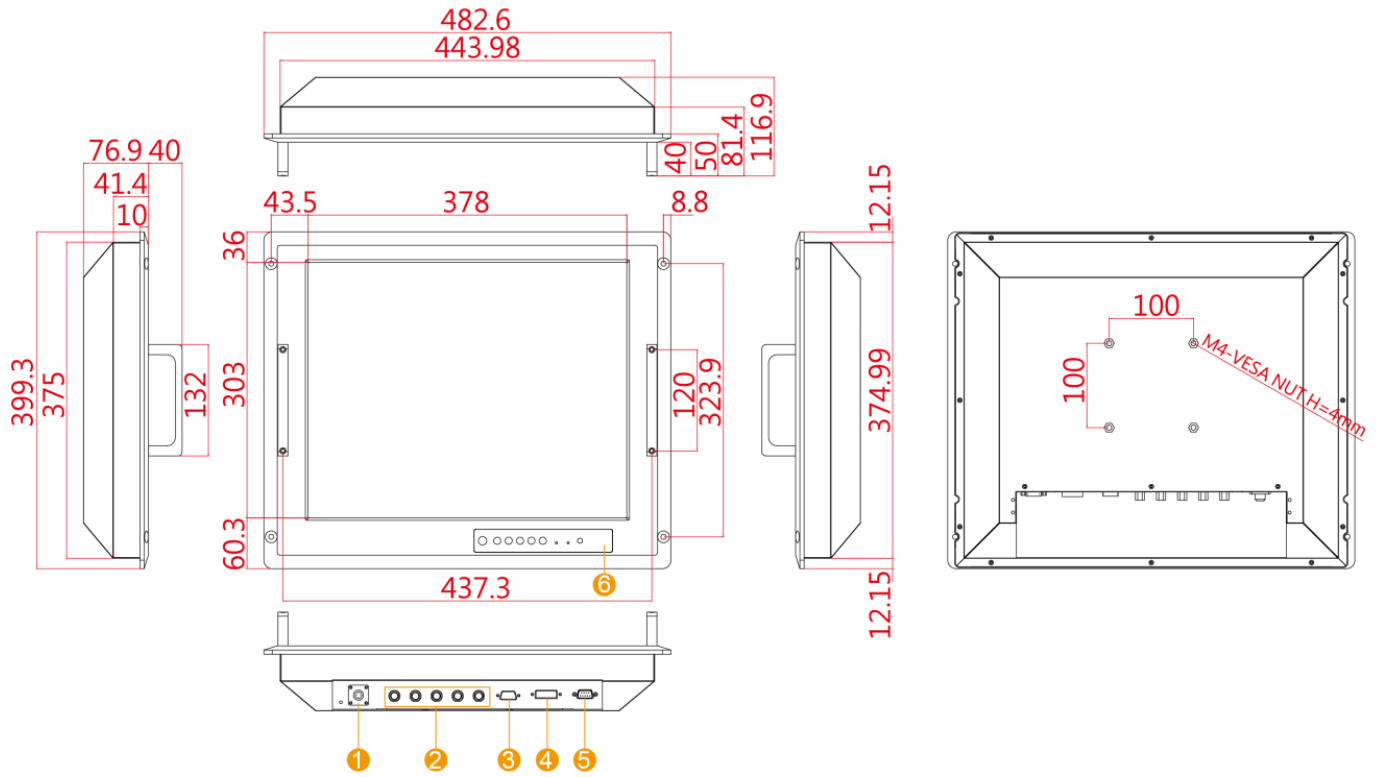

CUT OUT 448 x 379 mm

No	Description	No	Description
①	AC in 220V ±10%, 50 ± 3% Hz	④	DVI-D
②	5 x BNCs	⑤	RS232
③	15 pin D-Sub (VGA)		

Dimensions 20.1"

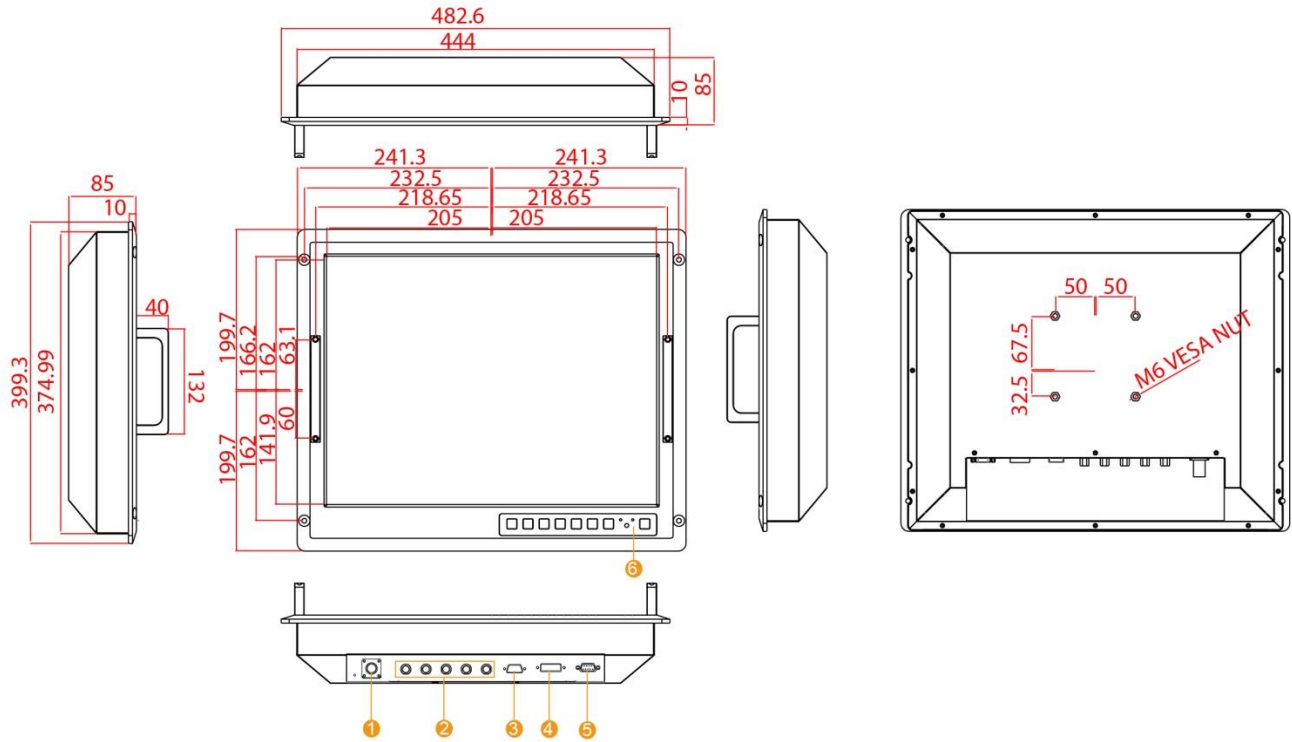

CUT OUT 446 x 377 mm

No	Description	No	Description
①	AC in 220V \pm 10%, 50 \pm 3% Hz	④	DVI-D
②	5 x BNCs	⑤	RS-232
③	15 pin D-Sub (VGA)		

Dimensions 24"

Unit : mm

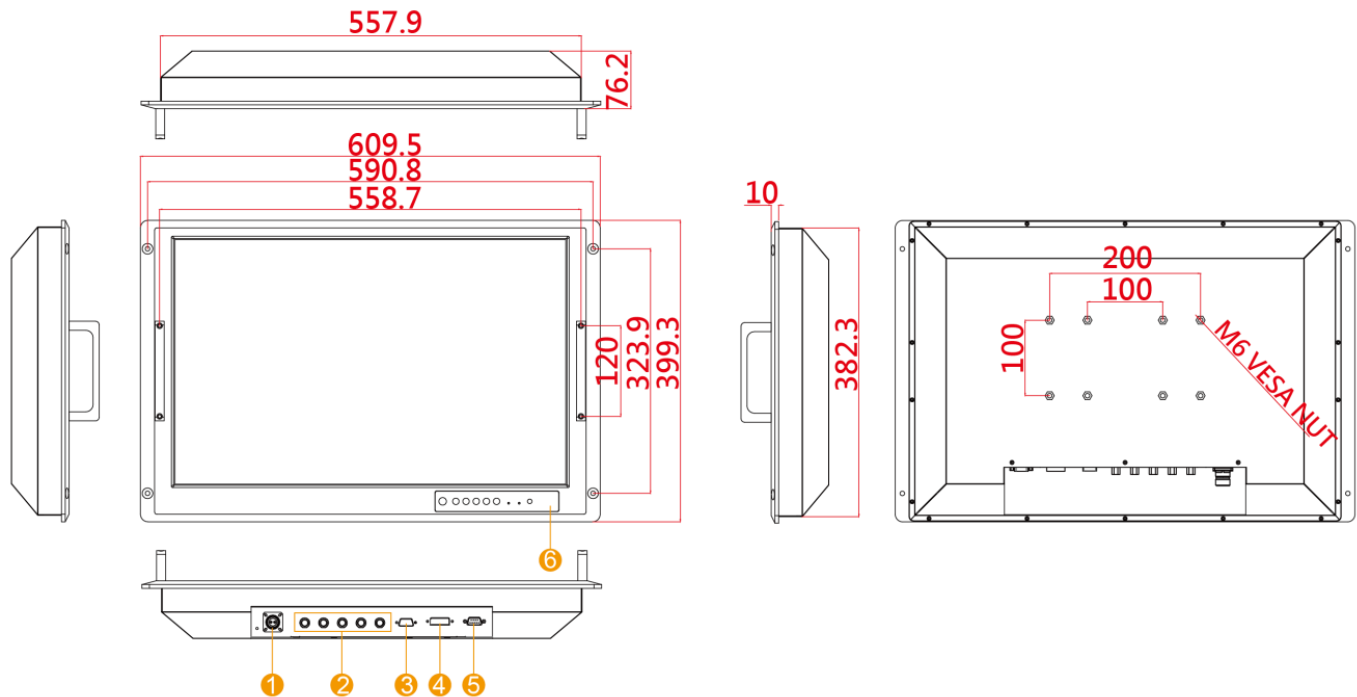

CUT OUT 562*387 mm

No	Description	No	Description
①	AC in 220V $\pm 10\%$, 50 $\pm 3\%$ Hz	④	DVI-D
②	5 x BNCs	⑤	RS232
③	15 pin D-Sub (VGA)		

Dimensions 32"

Unit : mm

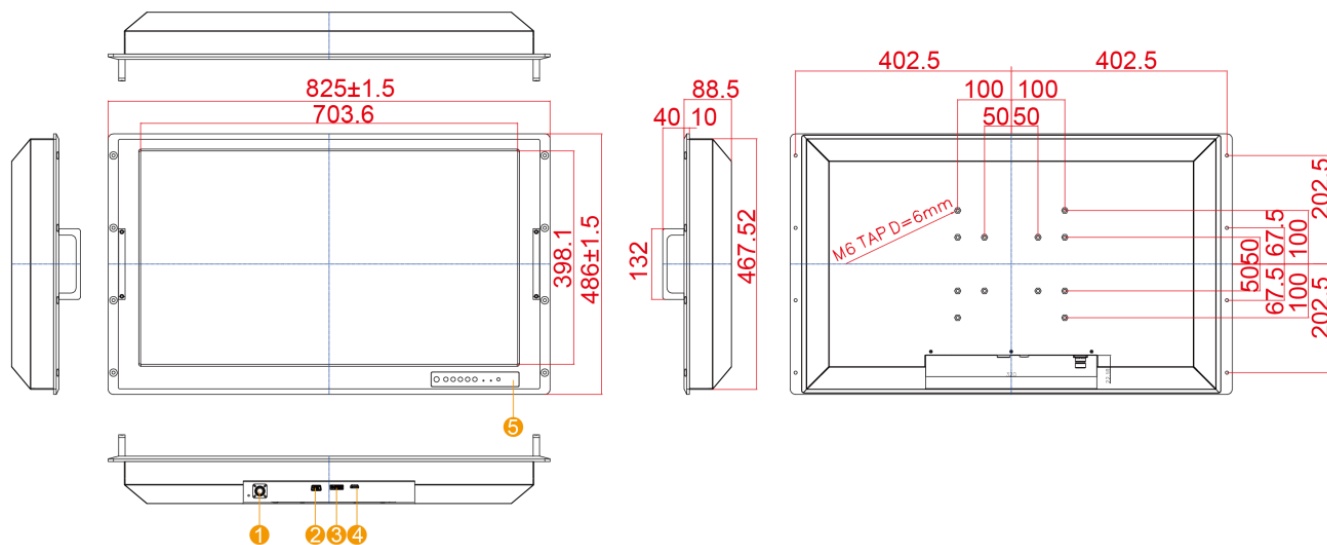

CUT OUT mm

No	Description	No	Description
①	AC in 220V ±10%, 50 ± 3% Hz	④	HDMI in
②	15 pin D-Sub (VGA)	⑤	OSD Control
③	DVI-D		

1.4 Physical Buttons and LED Indicators

On-Screen Display (OSD) is a user-friendly interface to remote the display function and to adjust the display's image properties. It also supports special Hot Keys for easy control, such as auto-adjustment and brightness control for backlight.

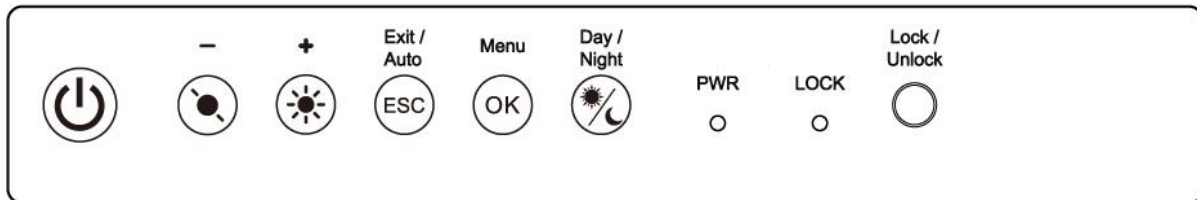

Physical Buttons

Icon	Button	Function
	Power	Turn ON or turn OFF the Display.
	Brightness DOWN	Decrease the brightness of the display screen, or allows user to navigate items of a single OSD menu.
	Brightness UP	Increase the brightness of the display screen, or allows user to navigate items of a single OSD menu.
	Exit/ Auto	Automatically adjusts brightness of the display screen, or allows user to exit the OSD menu.
	Menu	Allows user to enter the main menu.
	Day/ Night	Tap this button to enter DAY MODE. Tap this button to enter NIGHT MODE to increase visibility in low-light conditions.
	LOCK/ UNLOCK	Tap this button to lock/ unlock the function of OSD panel.

LED Indicators

Indicator	Color	Definition
PWR	Green	Power is ON and the device functions normally
	Orange	Display is suspended
LOCK	Red	The function of OSD buttons is locked
	OFF	Lock function disabled

Chapter 2: Getting Started

This chapter provides information on how to connect the device to the source of power, connector pinouts and the guideline to turn on/off the Display.

2.1 Powering On

2.1.1 Power Considerations

Follow the recommendations below when powering on the equipment.

- Plug-in the power cord to easy accessible AC outlet.
- Plug-in the AC adapter to a grounded outlet.



Alternating Current Mise à la terre !

This product must be grounded. Use only a grounded AC outlet. Install the additional PE ground wire if the local installation regulations require it.

**If you do not use a grounded outlet while using the device, you may notice an electrical tingling sensation when the palms of your hands touch the device.*

Ce produit doit être mis à la terre. Utiliser seulement un cordon d'alimentation avec mise à la terre. Si les règlements locaux le requiert, installer des câbles de mise à la terre supplémentaires.

**Si vous n'utilisez pas une prise d'alimentation avec mise à la terre, vous pourriez remarquer une sensation de picotement électrique quand la paume de vos mains touche à l'appareil.*

2.1.2 Connecting the Power

2.1.2.1 Connecting to AC Input Power Source (Default)

AC Power Input Requirements: AC 100~240V, Universal, $\pm 10\%$

Connect one end of the Military Grade power connector MIL-DTL-38999/1 to the Display (CN2), and plug the other end of the power connector (CN1) in to a working AC outlet.

Note: Power cords vary in appearance by region and country.

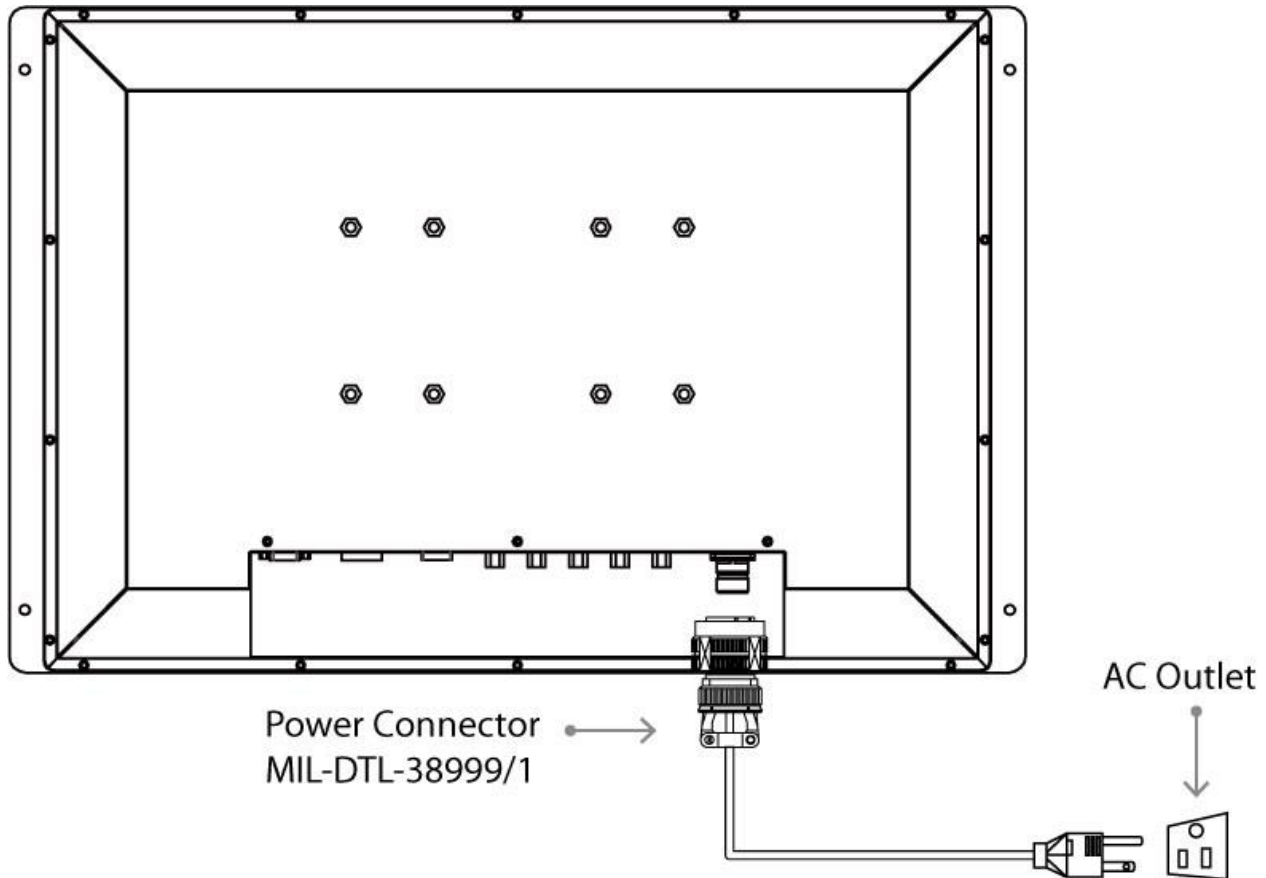

Connector Pinouts:

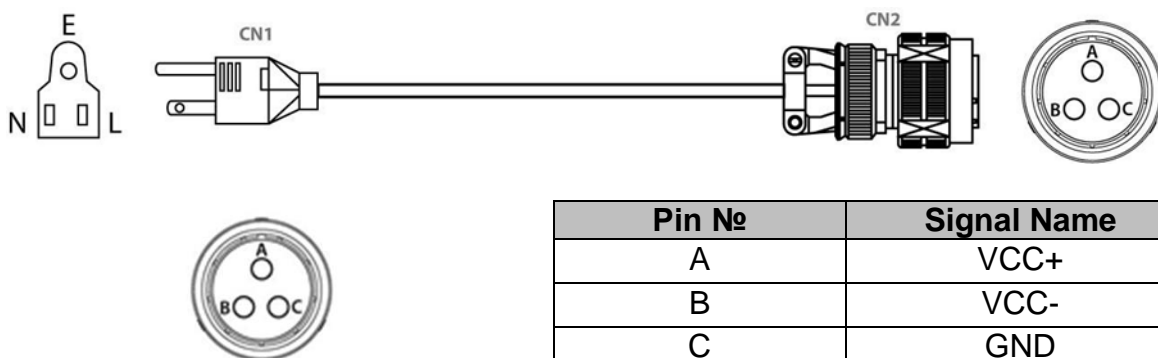

Warning! / Avertissement!

Serious injury due to shock is possible if unit is wired incorrectly or connected to voltage exceeding the input voltage range.

Des blessures graves en raison du choc est possible si l'unité est mal câblé ou connecté à la tension maximale de la plage de tension d'entrée.

2.1.2.1 Connecting to DC Input Power Source (Optional)

DC Power Input Requirements: 9~36V DC IN

1. Insert the exposed wires of the DC Power Cable to the appropriate connectors on the terminal block plug.
2. Plug the terminal block plug firmly to the DC IN Jack.
3. Connect the other end of the DC power cable (wires with lug terminals that are labeled + and - to the terminals of the 9-36V DC Power Source). Ensure that the power connections maintain the proper polarity.

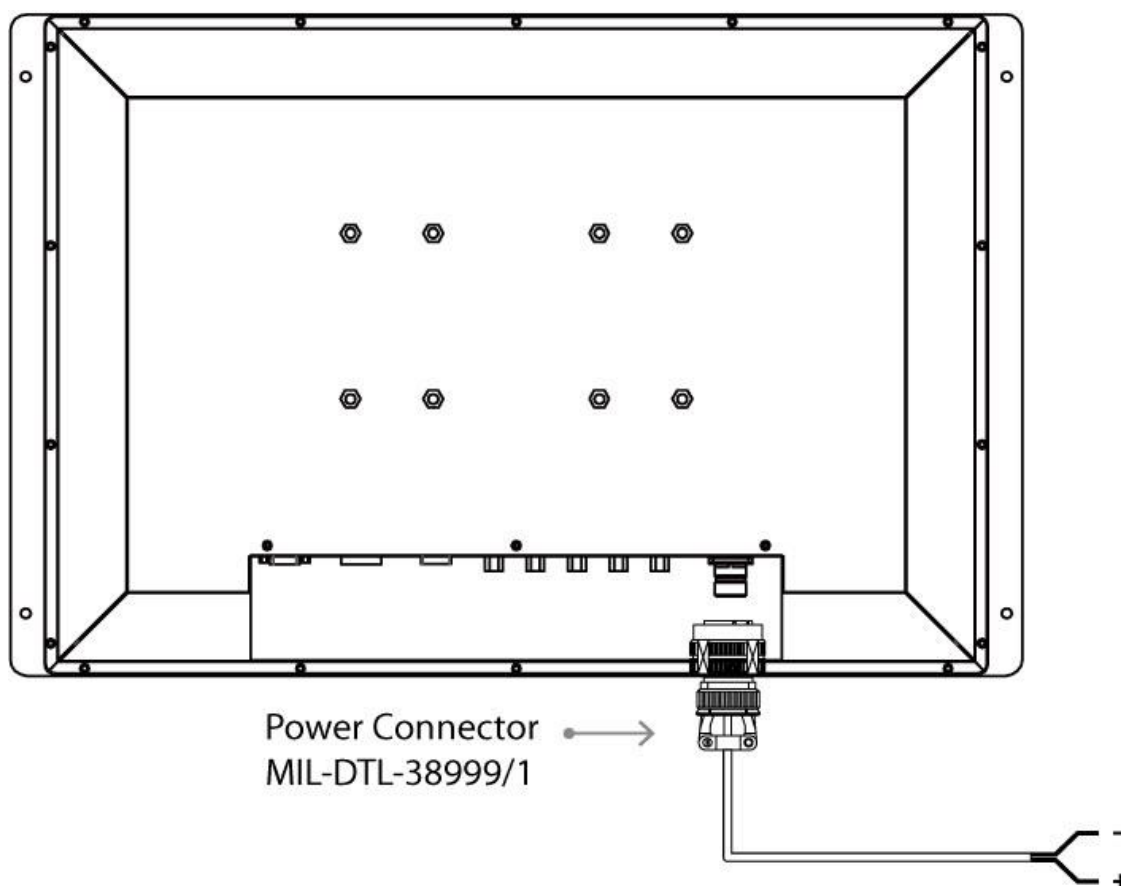

Warning!/ Avertissement!

Make sure that the polarization of the power lines is correct and complete including earth ground.

Assurez-vous que la polarisation des lignes électriques est correcte et complète, y compris la terre.

2.2 Connecting Other Devices



Warning!/ Avertissement!

Make sure the power is off when connecting and disconnecting the connectors.
Assurez-vous que l'alimentation est coupée lors de la connexion et la déconnexion des connecteurs.

2.2.1 VGA Connector

Plug one end of the 15-pin signal cable to the video signal connector at the rear of the PC system and the other end to the Display. Secure the connectors with the screws on the cable connector at both ends.

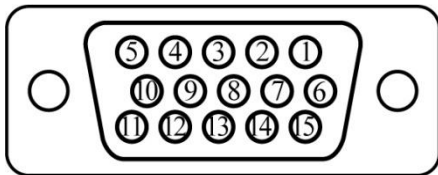
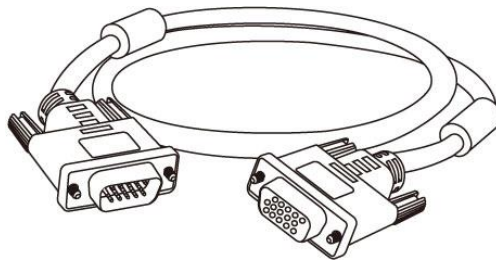

Pin №	Signal Name	Pin №	Signal Name
1	RED	2	GREEN
3	BLUE	4	ID2/RES
5	GND	6	RED_RTN
7	GREEN_RTN	8	BLUE_RTN
9	KEY/PWR	10	GND
11	ID0/RES	12	ID1/SDA
13	HSync	14	VSynC
15	ID3/SCL		

2.2.2 VGA to 5 BNCs Signal Shielding Cable

Plug one end of VGA signal cable to the rear side of the PC system and the other end of 5BNCs (R, G, B, H, V) signal connector to the Display.

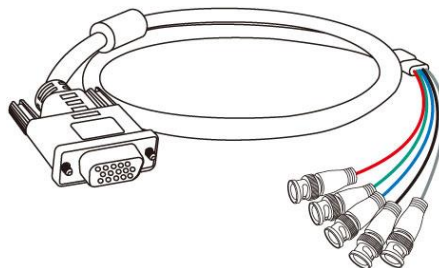

2.2.3 DVI-I Connector

Plug one end of the DVI signal cable to the video signal connector (DVI-I Dual Link) at the rear of the PC system and the other end to the Display.

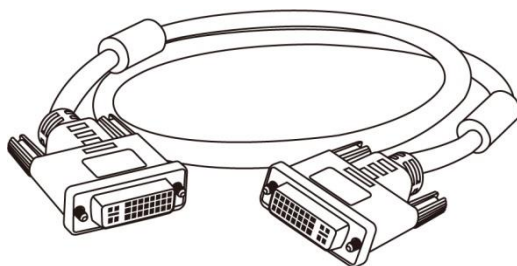

Pin №	Signal Name	Pin №	Signal Name
1	DVI_RX2-	2	DVI_RX2+
3	GND	4	NC
5	NC	6	DVI_SCL
7	DVI_SDA	8	NC
9	DVI_RX1-	10	DVI_RX1+
11	GND	12	NC
13	NC	14	+5V
15	DVI_CON_CABLE	16	DVI_CON_HP
17	DVI_RX0-	18	DVI_RX0+
19	GND	20	NC
21	NC	22	GND
23	DVI_CLKP	24	DVI_CLKN
C1	NC	C2	NC
C3	NC	C4	NC
C5	NC		

2.2.4 HDMI Connector

Notice that only 32" Display has HDMI connector.

Use HDMI A Type19-pin female output connector to connect the HMI device to an external display.

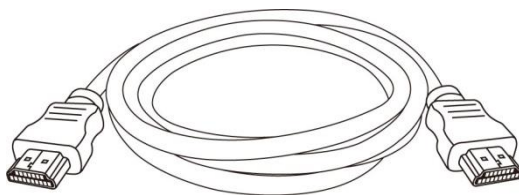

Pin №	Signal Name	Pin №	Signal Name
1	TMDS_DATA2+	2	GND
3	TMDS_DATA2-	4	TMDS_DATA1+
5	GND	6	TMDS_DATA1-
7	TMDS_DATA0+	8	GND
9	TMDS_DATA0-	10	TMDS_CLOCK+
11	GND	12	TMDS_CLOCK-
13	CEC	14	NC
15	DDC_CLOCK	16	DDC_DATA
17	GND	18	5V
19	Hot Plug Detect		

Chapter 3: Mounting

This chapter provides mounting guide for all available mounting options. Pay attention to cautions and warning to avoid any damages.



Caution/ Attention

Follow mounting instructions and use recommended mounting hardware to avoid the risk of injury.

Suivez les instructions de montage et d'utilisation recommandé le matériel de montage pour éviter le risque de blessure.

Safety Precautions

Observe the following common safety precautions before installing any electronic device:

- Use separate, non-intersecting paths to route power and networking wires. If power wiring and device wiring paths must be crossed make sure the wires are perpendicular at the intersection point.
- Keep the wires separated according to the interface. Wires that share similar electrical characteristics must be bundled together.
- Do not bundle input wiring with output wiring. Keep them separate.
- When necessary, it is strongly advised that you label wiring to all devices in the system.

3.1 Cable Mounting Considerations

For a nice look and safe installation, make sure cables are neatly hidden behind the device.



Caution/ Attention

Observe all local installation requirements for connection cable type and protection level.

Suivre tous les règlements locaux d'installations, de câblage et niveaux de protection.



Caution/ Attention

Turn off the device and disconnect other peripherals before installation.

Éteindre l'appareil et débrancher tous les périphériques avant l'installation.



Alternating Current Mise à le terre !

To prevent electrical shock, the Safety Ground location on the rear must be bonded to the local earth ground through a minimum 12 AWG wire as short as possible.

Pour éviter les chocs électriques, l'emplacement de la prise terre à l'arrière doit être lié à terre locale, à travers un 12 AWG minimum et aussi court que possible.

3.2 Mounting Guide

Military Grade Display comes with different mounting options suitable for most of the industrial and commercial applications. Refer to sub-sections below for more details.

3.2.1 Console / Rack Mount

The main mounting approach is rack mount - very user-friendly in terms of installation.

Cutout dimensions (W x D in mm)			
17"	19"	24"	32"
450 x 368 mm	448 x 379 mm	562 x 387 mm	771 x 470 mm
Screws			
M4 truss head (4 pcs)	M4 truss head (4 pcs)	M6 truss head (4 pcs)	M6 truss head (4 pcs)

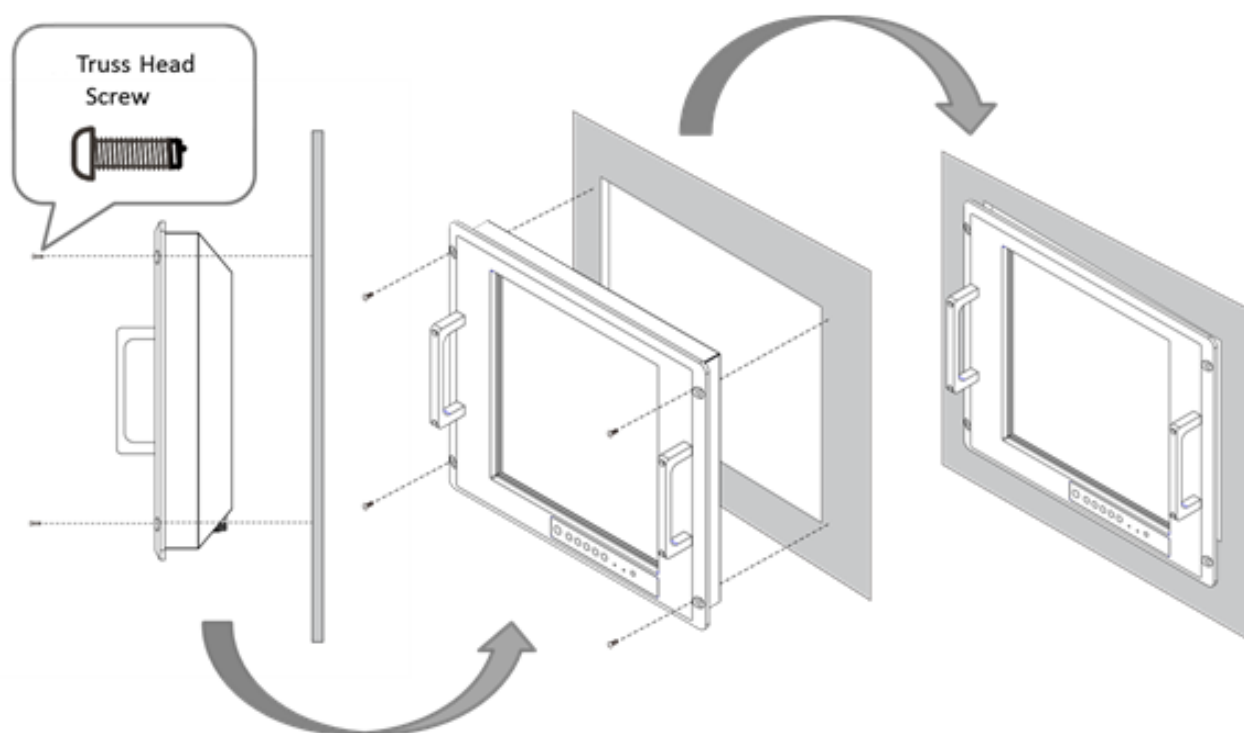

Installation Instruction:

1. Prepare a fixture for the specific dimensions of the device.
2. Cut a hole on a sub frame or panel according to the cutout dimensions.
3. Install the device properly onto the cutout area of the sub frame or panel with the sides of the front bezel.
4. Fix the device from the outside to the fixture with four M6 truss head screws.

3.2.2 VESA Mount

Military Rack Mount Display support VESA Mount installation. Notice that VESA Plate is not included in Winmate's standard accessories package.

VESA Plate			
17"	19"	24"	32"
100 x 100 mm	100 x 100 mm	100 x 100 mm 100 x 200 mm	100 x 100 mm 100 x 200 mm

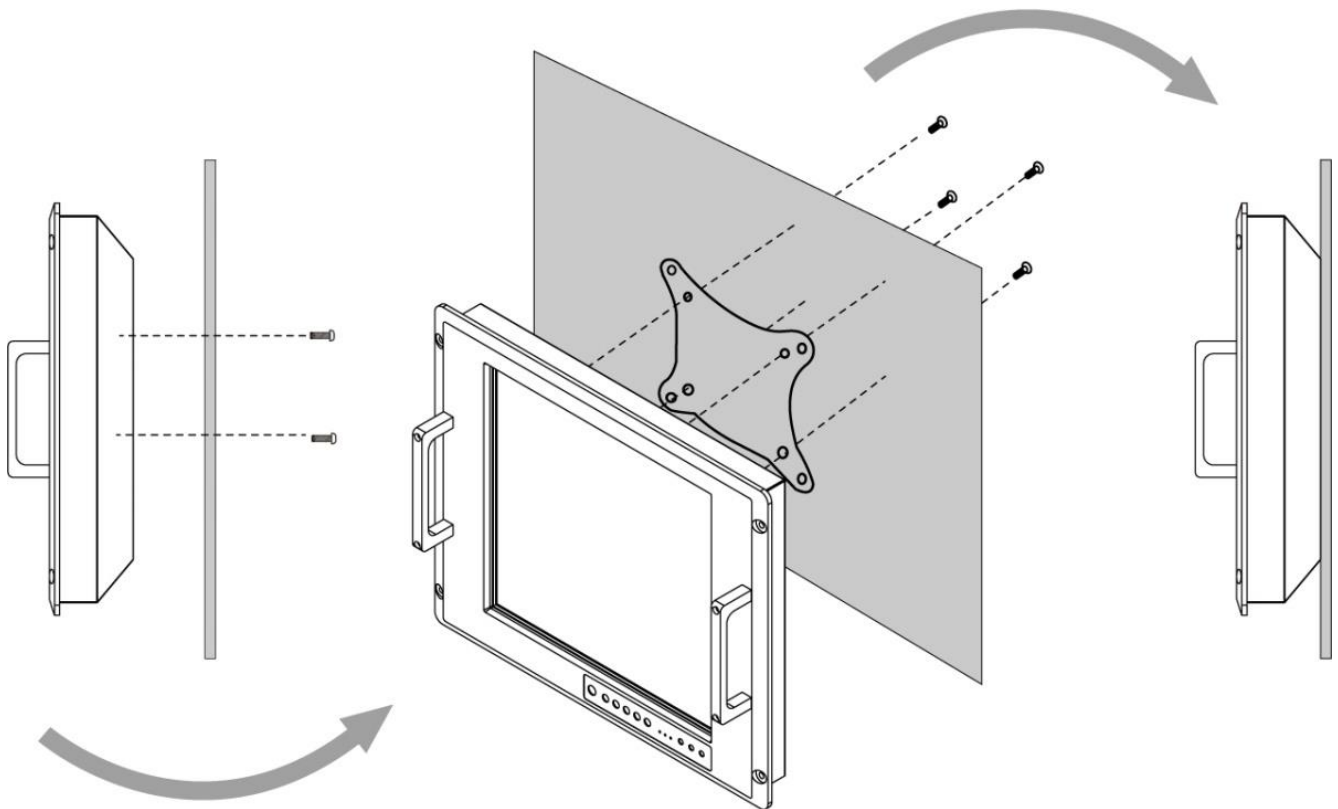

**with customer's bracket*

Installation Instruction:

1. Screw VESA Bracket to the fixture (ex. wall).
2. Place the device on VESA bracket.
3. Continue with the instructions provided with your VESA-compatible wall bracket (not supplied by Winmate).

Chapter 4: On-Screen Display Control

This chapter provides information about On-Screen Display (OSD) Control interfaces.

4.1 Navigating the OSD Menu









This section describes how to navigate the OSD Menu.

OPTION	ACTION	EFFECT
Enter the main menu	Press the MENU button	Display the main menu on the screen.
Select the menu you want to adjust	Press +/- the button	Shift the item selections up or down until it is desired, and then press the button again to enter the menu item.
Adjust item settings	Press +/- the button	Adjust the value of setting. Once you adjust the value of setting, the value will be stored automatically.
Exit the OSD menu	Select the "EXIT OSD" item or press the Exit Key directly	Return the regular screen viewing. If there is no command respond for 30 seconds, OSD menu will be closed automatically.

4.2 OSD Menu in VGA Mode

This section describes how to navigate the OSD Menu in VGA Mode.

Navigation buttons in VGA Mode

	BRICONTRAST	BRIGHTNESS CONTRAST AUTO BRIGHTNESS LED LIGHT MIN BRIGHTNESS		AUDIO	VOLUME ADJUST SPEAK ON/OFF
	POSITION	H-POSITION V-POSITION		CHANNEL	ANALOG 1 ANALOG 2 DVI
	IMAGE	AUTO CLOCK PHASE WHITE BALANCE		RECALL	YES NO
	COLOR	USER (RED/GREEN/BLUE) 9300K 6500K ADC BRIGHTNESS		OSD EXIT	YES NO
	GAMMA	GAMMA 0 GAMMA 1 GAMMA 2 GAMMA 3			

Description of items in the navigation menu:

BRICONTRAST

Press "+" to increase or "-" to decrease the brightness or contrast.

- **BRIGHTNESS:** Use to adjust the screen's brightness
- **CONTRAST:** Use to adjust the screen's contrast

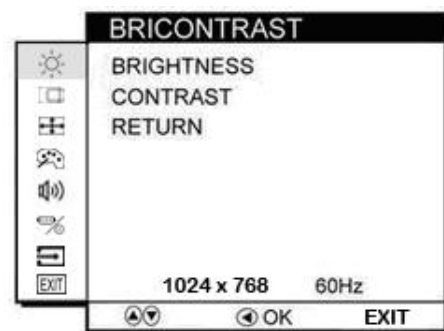

POSITION

You can adjust the screen's position by horizontal and vertical manually.

- **H-POSITION:** Use to adjust the image to the left or right on the screen
- **V-POSITION:** Use to adjust the image up or down on the screen

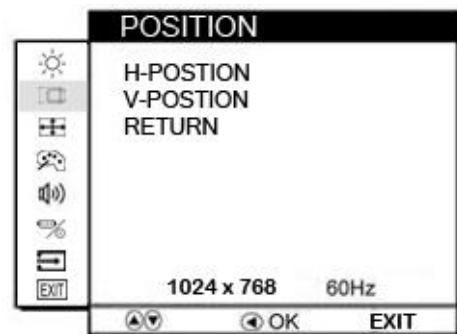

IMAGE

You can adjust the value of screen quality automatically.

- **AUTO:** Use to choose the best settings for the current input signal
- **CLOCK:** Use to adjust the value of horizontal image
- **PHASE:** Use to adjust the phase control (Phase adjustment may be required to optimize the display quality)
- **WHITE BALANCE:** Use to set RGB signal voltage level

COLOR

You can select the screen's color level of the white color field from the default color temperature settings. Also, you can fine tune the color temperature by USER option if necessary.

- **USER:** Choose RED/GREEN/BLUE to set value of color temperature brightness to suit your own preference
- **9300K:** Use to set value of monitor for the CIE coordinate 9300 color temperature
- **6500K:** Use to set value of monitor for the CIE coordinate 6500 color temperature
- **ADC Brightness:** Set value of monitor for ADC Brightness

AUDIO (Optional)

You can adjust the setting of speaker, including volume and mute.

- **VOLUME ADJUST:** Use to adjust the volume of speaker
- **SPEAK ON/OFF:** Use to make the speaker work or mute



RECALL

You can recall the factory default setting by selecting "YES". Select "NO" to return the main menu.

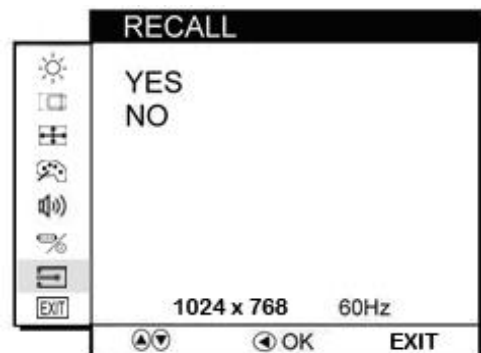
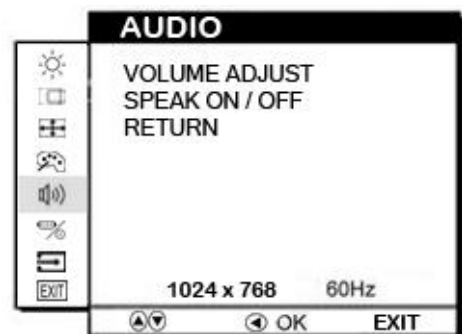
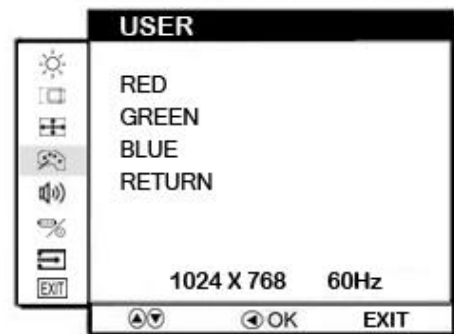
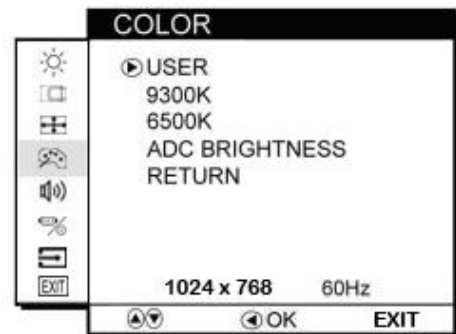
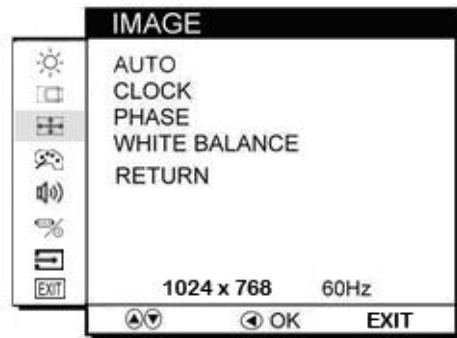

EXIT OSD EXIT

You can exit the OSD menu by selecting "YES". Select "NO" to return the main menu.

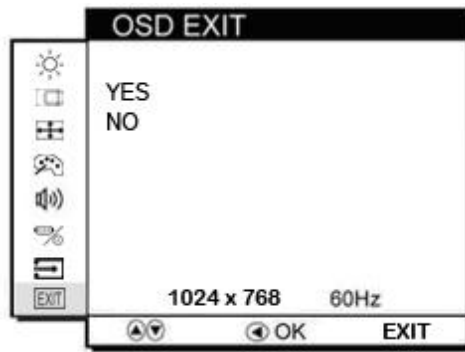
**4.3 OSD Menu in DVI Mode**

This section describes how to navigate the OSD Menu in DVI Mode.

Navigation buttons in DVI Mode

	BRICONTRAST	BRIGHTNESS CONTRAST		AUDIO	VOLUME ADJUST SPEAK ON/OFF
	POSITION	Not available under DVI mode		CHANNEL	VGA DVI
	IMAGE	Not available under DVI mode		RECALL	YES NO
	COLOR	USER └ (RED/GREEN/BLUE)		OSD EXIT	YES NO

Description of items at the navigation menu:

***BRICONTRAST**

Press "+" to increase or "-" to decrease the brightness or contrast.

- **BRIGHTNESS:** Use to adjust the screen's brightness
- **CONTRAST:** Use to adjust the screen's contrast

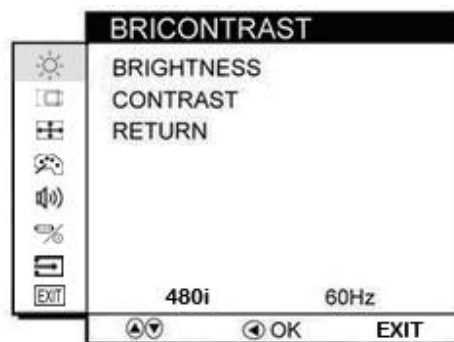

POSITION

These functions are not available under DVI mode.

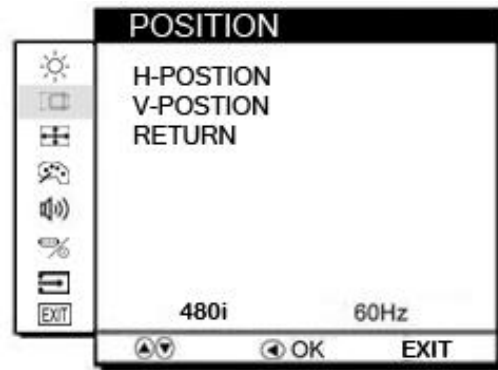

IMAGE

These functions are not available under DVI mode.

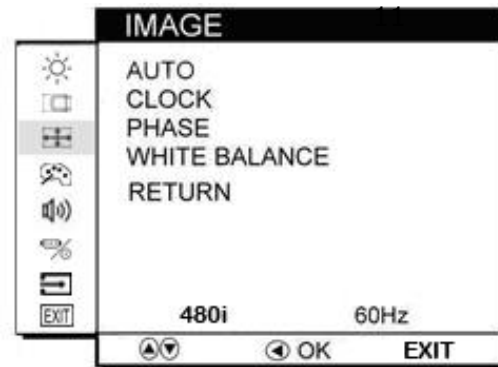

COLOR

You can fine tune the color temperature by USER option if necessary.

- USER: Choose RED/GREEN/BLUE to set value of color temperature brightness to suit you own preference
- For 9300K, 6500K, and ADC BRIGHTNESS, these functions are not available under DVI mode.

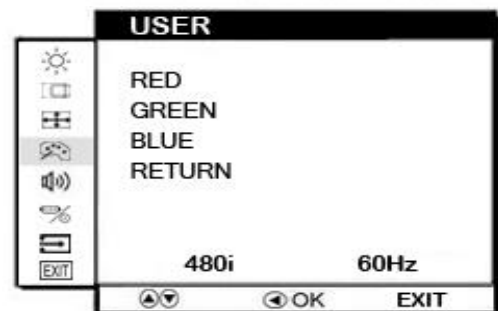
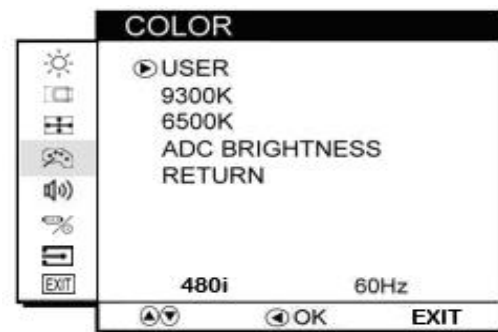

AUDIO (optional)

You can adjust the setting of speaker, including volume and mute.

- VOLUME ADJUST: Use to adjust the volume of speaker
- SPEAK ON/OFF: Use to make the speaker work or mute

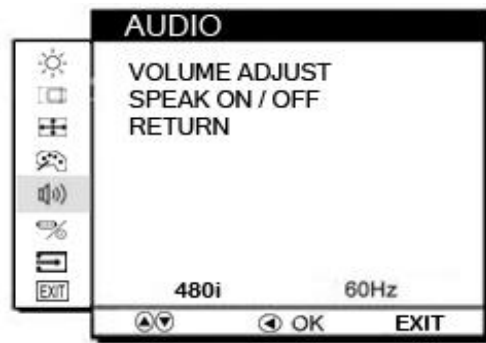

RECALL

You can recall the factory default setting by selecting "YES". Select "NO" to return the main menu.

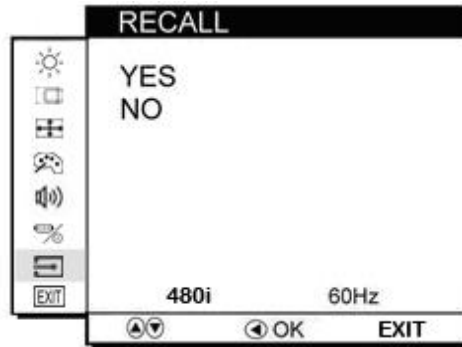

OSD EXIT

You can exit the OSD menu by selecting "YES". Select "NO" to return the main menu.

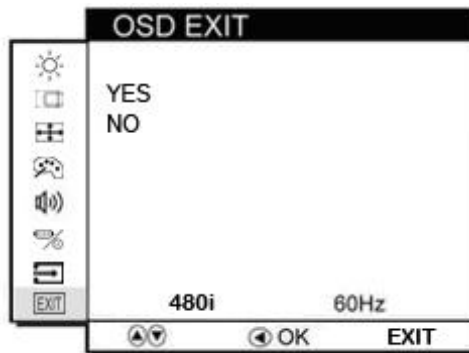

Chapter 5: Maintenance

This chapter includes regular cleaning and maintenance procedures. Follow all the recommendations in this chapter in order to ensure long product lifecycle.

This equipment is extremely rugged and does not require a lot of maintenance. Remember that electrical equipment should be handled with care and used accordingly to its specifications.

5.1 Cleaning the Display Screen

- Wipe the screen with a clean, soft, lint-free cloth. This removes dust and other particles. Do not use acetone, ethyl alcohol, toluene, ethyl acid or methyl chloride to clear the panel. It may permanently damage the display screen.
- You can apply a small amount of non-ammonia; non-alcohol based glass cleaner onto a clean, soft, lint-free cloth and wipe the screen.
- Never spray or pour any liquid directly on the screen or case.
- **Do Not** use water or oil directly on the display screen. If droplets are allowed to drop on the screen, permanent staining or discoloration may occur.

5.2 Cleaning the Casing

Use the following procedure to clean the equipment.



Caution/ Attention

Always turn off the device and disconnect other peripherals before cleaning and maintenance procedures.

Toujours éteindre l'appareil et débrancher tous les périphériques avant que les procédures de nettoyage et d'entretien.

Before Cleaning:

- Make sure the device is turned off.
- Disconnect the power cable from any AC outlet.

When Cleaning:

- Wipe dust off the outside casing with a cloth slightly moistened with water or mild ammonia-based cleaning solution. Do not use this cloth on a display screen!
- Do not use an abrasive cleaner or high pressure washer on the screen.
- Do not rub the unit with a dry cloth. This action can result in a static charge being built up and cause a spark. Always use damp cloth while cleaning the unit.



Warning!/ Avertissement!

POTENTIAL ELECTROSTATIC CHARGE HAZARD – SEE INSTRUCTIONS
 POTENTIEL ÉLECTROSTATIQUE CHARGE DANGER - VOIR
 INSTRUCTIONS

Chapter 6: Technical Support

This chapter includes troubleshooting guide and problem report form. Free technical support is available from our engineers every business day. We are always ready to give advice on application requirements or specific information on the installation and operation of any of our products. If any problem occurs fill in [problem report form](#) enclosed and immediately contact us.

6.1 Troubleshooting

If your monitor fails to operate correctly, consult the following chart for possible solution before calling for repairs:

Condition	Check Point
The picture does not appear	<ul style="list-style-type: none"> • Check if the signal cable is firmly seated in the socket. • Check if the Power is ON at the computer • Check if the brightness control is at the appropriate position, not at the minimum.
The screen is not synchronized	<ul style="list-style-type: none"> • Check if the signal cable is firmly seated in the socket. • Check if the output level matches the input level of your computer. • Make sure the signal timings of the computer system are within the specification of the monitor. • If your computer was working with a CRT monitor, you should check the current signal timing and turn off your computer before you connect the VGA Cable to this monitor.
The position of the screen is not in the center	<ul style="list-style-type: none"> • Adjust the H-position, and V-position, or Perform the Auto adjustment.
The screen is too bright (too dark).	<ul style="list-style-type: none"> • Check if the brightness or contrast control is at the appropriate position, not at the Maximum (Minimum).
The screen is shaking or waving	<ul style="list-style-type: none"> • Press  (the Auto - adjustment control) to adjust. • Moving all objects which emit a magnetic field such as motor or transformer, away from the monitor. Check if the specific voltage is applied. • Check if the signal timing of the computer system is within the specification of monitor.

Note: if you are unable to correct the fault by using this chart, stop using your monitor and contact your distributor or dealer for further assistance.

Appendix

Appendix A: Product Specifications

Model Name	R17L100- RKA1ML	R19L100- RKA3ML	R20L100- RKA2ML	W24L100- RKS1ML	W32L100- RKA3ML
Display					
Viewable Size Image	17"	19"	20.1"	24" (Widescreen)	32" (Widescreen)
Active Display Area,	337.92 (H) x 270.34 (V) mm	376.32(H) x 301.06 (V) mm	408.0(H) x 306.0(V) mm	518.4 (H)x 324(V) mm	698.4(H)x 392.85 (V) mm
Pixel Pitch	0.264 (H)x 0.264 (V) mm	0.294 (H) x 0.294 (V) mm	0.255(H) x0.255 (V) mm	0.270 (H) x 0.270 (V) mm	0.3637(H) x 0.3637(V) mm
Resolution	1280 x 1024	1280 x 1024	1600 x 1200	1920 x 1200	1920 x 1080
Contrast Ratio	1000:1 (typ.)	1000:1 (typ.)	800:1 (typ.)	1000: 1(typ.)	3000:1(typ.)
Display Color	16.7M (8 bits/colors)	16.7M (8 bits/colors)	16.7 Million (8 bits/colors)	16.7M (8 bits/ colors)	1.07 Billion (colors)
Brightness	350(typ.)	350(typ.)	300 (typ.)	300 (typ.)	350 (typ.)
Viewing Angle	-85~85(H);- 80~80(V)	-85~85(H);- 80~80(V)	-89~89 (H); - 89~89 (V)	-89~89(H);- 89~89(V)	-89~89(H);- 89~89(V)
Synch. Range	31.5~80.0KHz/ 60~75Hz	31.5~80.0KHz/ 60~75Hz	31.5~80.0KHz / 60~75Hz	31.5~80.0KHz/ 60~75Hz	31.5~80.0KHz/ 60~75Hz
Input/ Output					
Connectors	1 x D-Sub 15 pin, 5 x BNCs, 1 x DVI-D, 1 x RS232				1 x D-Sub15 (VGA), 1 x DVI-D, 1 x HDMI
Environmental Considerations					
Operating Temp.	-20~60°C	-20~60°C	0~60°C, wide temp. by request	0~50°C, wide temp. by request	0~50°C, wide temp. by request
Storage Temp.	-30~70°C	-30~70°C	-10~70°C	-10~60°C	-10~60°C
MIL-STD 810F/G Compliance	Vibration: MIL-STD-810F Method 514.5				
	Humidity: MIL-STD-810F Method 507.4				
	Transit Drop: MIL-STD-810F Method 516.5				
MIL-461E Compliance	RE: RE101 / RE102				
	CE: CE 101 / CE 102				
	Optional with EMI Glass / Touch				
	RS: RS101 / RS103				
CS: CS 101 / CS 106 / CS 109 / CS 114					
Power Specifications					
Power Source	Default: AC 100~240V, Universal,±10% , Optional: DC 9~36V, ±10%				
Power Consumption	32 W typ.	41 W typ.	90 W typ.	26 W typ.	53 W typ.
Power Management	VESA DPMS Compliant				
Play & Play	VESA DDC 1/2B				
Power Source	Optional: DC 24V, ±10%				

*To comply with the MIL-STD-461E, the display unit must have EMI-ITO Glass or Touch with EMI Mesh Filter.

Appendix B: Order Information

Rack Mount Military Display is available for order in the following configurations:

Order Information	
Item	Description
Touch	5-wire Resistive Touch 5-wire Resistive Touch with EMI Mesh Coating EMI ITO Glass
Power Source	Optional: DC 24V, $\pm 10\%$

Appendix C: MIL-STD-810F/G Compliance

This section includes information on testing methods and procedures in compliance with military standard MIL-STD-810 F/G.

MIL-STD-810F/G Compliance

MIL-STD-810F/G Compliance		
Test	Reference	Condition
* Humidity	Method 507.5	20 to 60°C $\pm 2^\circ\text{C}$, 95%RH $\pm 3\%$
* Vibration	Method 514.6, Procedure I	5 ~ 500 Hz, 1.48/1.90/2.24 Grms, 3-Axis (MIL-STD-810G)
* Transit Drop	Method 516.6, Procedure IV	4ft, 8 Corner, 12 edges, 6 faces
Low Pressure (Altitude)	Storage	Method 500.5, Procedure I
	Operation	Method 500.5, Procedure II
Thermal Shock	Method 503, Procedure II	-33 to 63°C $\pm 2^\circ\text{C}$
Salt Fog	Method 509.5	Salt Spray test, exposing for 24 Hrs Drying condition for 24 Hrs 24 Hrs Salt Spray exposure + 24 Hrs Drying condition
Shock	Method 516.6, Procedure I	Impact acceleration 40 G, 6 faces

**Default Test*

Appendix D: MIL-STD-461E/F Compliance

This section includes information on testing methods and procedures in compliance with military standard MIL-STD-461 E/F. **To comply with MIL-STD-461E Standard, the Display must have Built-in EMI -ITO Glass or Touch with EMI Mesh Film.**

MIL-STD-461E/F Compliance

MIL-STD-461E/F Compliance			
Test	Description	Type	Frequency Range
CE101	Power Leads	Conducted Emission	30 Hz ~ 10 kHz
*CE102	Power Leads	Conducted Emission	10 kHz ~ 10 MHz
CS101	Power Leads	Conducted Susceptibility	30 Hz ~ 150 kHz
CS109	Structure Current	Conducted Susceptibility	60 Hz ~ 100 kHz
CS114	Bulk Cable Injection	Conducted Susceptibility	10 kHz ~ 200 MHz
CS116	Damped Sinusoidal Transients, Cables and Power Leads	Conducted Susceptibility	10 kHz ~ 100 MHz
RE101	Magnetic Field	Radiated Emission	30 Hz ~ 100 kHz
*RE102	Electric Field	Radiated Emission	10 kHz ~ 18 GHz
RS101	Magnetic Field	Radiated Susceptibility	30 Hz ~ 100 kHz
RS103	Electric Field	Radiated Susceptibility	2 MHz ~ 18 GHz

**Default Test*



Winmate Inc.

9F, No.111-6, Shing-De Rd., San-Chung District,
New Taipei City 24158, Taiwan, R.O.C

Tel: 886-2-8511-0288

Fax: 886-2-8511-0211

Email: sales@winmate.com.tw

www.winmate.com